

# Helmet-Mounted Display Symbology for Ground Collision Avoidance in Fighter Aircraft

by

1Lt Jonathan B. Taylor, USAF

B.S. Aeronautical Engineering, Engineering Sciences  
United States Air Force Academy, 1996

SUBMITTED TO THE DEPARTMENT OF AERONAUTICS AND ASTRONAUTICS IN  
PARTIAL FULFILLMENT OF THE REQUIREMENTS FOR THE DEGREE OF

MASTER OF SCIENCE IN AERONAUTICS AND ASTRONAUTICS  
AT THE  
MASSACHUSETTS INSTITUTE OF TECHNOLOGY

SEPTEMBER 1998

© 1998 Jonathan B. Taylor

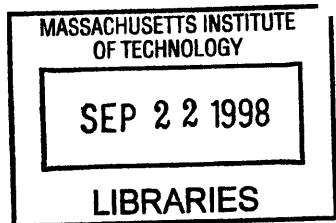
The author hereby grants to MIT  
permission to reproduce and to  
distribute publicly paper and  
microfilm copies of this thesis  
document in whole or in part.

Signature of Author: \_\_\_\_\_  
Department of Aeronautics and Astronautics  
June 17, 1998

Approved by: \_\_\_\_\_  
Thomas McNamara  
Program Manager, Draper Laboratory

Certified by: \_\_\_\_\_  
James Kuchar  
Assistant Professor of Aeronautics and Astronautics  
Thesis Supervisor

Accepted by: \_\_\_\_\_  
Jaime Peraire  
Associate Professor  
Chairman, Department Graduate Committee



Aero

# **Helmet-Mounted Display Symbology for Ground Collision Avoidance in Fighter Aircraft**

by

**1Lt Jonathan B. Taylor, USAF**

Submitted to the Department of Aeronautics and Astronautics  
on June 17, 1998 in Partial Fulfillment of the  
Requirements for the Degree of Master of Science in  
Aeronautics and Astronautics

## **ABSTRACT**

A two-part experimental simulation study was performed to examine ways of improving Ground Collision Avoidance Systems (GCAS) for fighter aircraft through the use of Helmet-Mounted Display (HMD) symbology. Modality and information presentation issues were addressed through the design and testing of five display formats.

An audio alert with no visual symbology was used as a baseline. The addition of visual alert symbology was tested using a head-fixed iconic alerting cue. Formats for additional recovery information were tested using an aircraft-fixed guidance cue, a head-fixed guidance cue, and a head-fixed guidance cue with a pitch ladder. Subjects were given audio and visual side tasks and then responded to GCAS alerts. Recovery performance and subjective ratings of the displays were recorded.

Lower reaction times were observed when a head-fixed visual alert was given in addition to the standard audio alert. No significant differences were seen in subject recovery performance, measured by altitude loss and response times. However, subject head motion varied significantly with display type. Subjects tended to fixate on guidance and state symbology when it was provided. This led to cases where pilots performed entire recoveries with their heads off-boresight when using head-fixed guidance symbology. Subjects varied in their preference of symbology, but head-fixed guidance and state information was preferred over the other display categories using the Analytical Hierarchy Process.

Thesis Supervisor: James Kuchar

Title: Assistant Professor of Aeronautics and Astronautics

## Acknowledgments

This thesis was prepared at The Charles Start Draper Laboratory, Inc., under Contract 27900. The author would like to acknowledge Tom McNamara for his unwavering support of this project and Tina Saunders for her administrative expertise.

For the simulation experiment, the author would like to thank John Danis for his great help in all aspects of the experimental setup. His aid was invaluable. The author also thanks Ed Bachelder for his help with the Helmet-Mounted Display and simulation scene and Dave Hauger for his help with the audio setup. Wade Hampton provided hardware support and Linda Leonard and Mario Santarelli provided administrative support from the Draper sim lab. Special appreciation goes to the volunteer subject pilots who took several hours out of their busy schedule to help with this experiment.

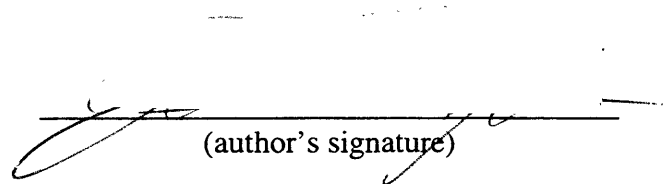
The author thanks Capt Steve Jacobson, USAF for his input during the design of the experiment from a pilot's perspective. Also, Professor Larry Young deserves credit for his expertise on the human vestibular system and its application to this experiments.

The author would also like to recognize Dr. Mike Borowski of the Naval Safety Center and DJ Atkins of the Air Force Safety Center for their help in acquiring statistical safety data for this thesis.

Finally, the author would like to extend a very special thank you to Professor Jim Kuchar and Ed Bergmann for their guidance, advise, hard work, and expertise. Their labors and ideas were instrumental in the completion of this thesis.

Publication of this thesis does not constitute approval by Draper or the sponsoring agency of the findings or conclusions contained herein. It is published for the exchange and stimulation of ideas.

Permission is hereby granted by the author to the Massachusetts Institute of Technology to reproduce any or all of this thesis.

  
(author's signature)

## Table of Contents

Abstract .....	2
Acknowledgments .....	3
Table of Figures .....	6
1. Introduction .....	7
2. Background.....	9
2.1. CFIT.....	9
2.1.1. Problem Magnitude .....	9
2.1.2. CFIT Causes .....	10
2.2. GCAS.....	12
2.2.1. GCAS Description.....	13
2.2.2. GCAS Information .....	14
2.2.3. Impact of GCAS on CFIT Accidents .....	15
2.2.4. GCAS Shortfalls.....	17
2.3. Proposed Approach to Information and Attention Shortfalls.....	19
3. Experimental Facilities.....	23
3.1. Simulation Hardware and Software .....	24
3.1.1. T-38 Vehicle Dynamics .....	25
3.1.2. Visual Scene.....	25
3.1.3. T-38 Cockpit.....	26
3.1.4. Head-Mounted Display and Head Tracker .....	26
3.1.5. Sound.....	28
3.2. Experiment Configuration .....	29
3.2.1. Environment, Scene, and Symbology .....	29
3.2.2. Pilot Tasking .....	32
3.2.2.1. Visual Task Description .....	32
3.2.2.2. Audio Task Description .....	35
3.2.3. Flight Profiling .....	36
3.2.4. GCAS .....	40
3.2.4.1. Simulated Functionality.....	40
3.2.4.2. Alert Format .....	41
3.2.5. Data Recording .....	42
4. Evaluation of Alert Mode Issues and Information Presentation Issues.....	43
4.1. Objectives .....	43
4.2. Experimental Design.....	44
4.2.1. Subject Acquisition.....	44
4.2.2. Experimental Protocol.....	44
4.2.3. Display Configurations .....	52
4.3. Experimental Results .....	58
4.3.1. Reaction Times.....	59
4.3.2. Recovery Performance .....	61
4.3.3. Pilot Head Motion.....	64
4.3.4. Subject Ratings .....	68
4.3.5. Subject Comments.....	73

4.4. Discussion .....	75
5. Conclusions.....	79
References .....	81
Appendix A - Flight Profiles .....	83
Appendix B - Informed Consent Statement.....	91
Appendix C - Experiment Part 1 Questionnaire.....	93
Appendix D - Experiment Part 2 Questionnaire .....	94
Appendix E - Experiment Part 1 Interview Questions .....	96
Appendix F - Experiment Part 2 Interview Questions .....	97
Appendix G - Overall Questionnaire .....	98
Appendix H - Final Interview Questions .....	100
Appendix I - Experimental Results Figures .....	101

## Table of Figures

Figure 2.1.	GCAS Alert Method .....	13
Figure 2.2.	F-16 GCAS HUD Symbology .....	15
Figure 2.3.	CFIT Accidents Per Year (Large Turbo-Jet and Prop-Transports).....	16
Figure 2.4.	Navy/Marine Corps Class A CFIT Mishaps Per Year (All Aircraft Types) .....	17
Figure 2.5.	Air Force Class A CFIT Mishaps Per Year (All Aircraft Types).....	17
Figure 3.1.	Simulation Hardware Block Diagram .....	25
Figure 3.2.	Profile End Attitude and Altitude Conditions.....	29
Figure 3.3.	Flight Path Vector.....	31
Figure 3.4.	Targeting Circle .....	31
Figure 3.5.	“RESUME” Message.....	32
Figure 3.6.	Target Boundaries.....	34
Figure 3.7.	Altitude History - Profile 1 .....	38
Figure 3.8.	Pitch History - Profile 1.....	38
Figure 3.9.	Roll History - Profile 1 .....	39
Figure 3.10.	Experiment GCAS Specifications .....	41
Figure 4.1.	Profile End Attitude Conditions.....	45
Figure 4.2.	Test Matrices .....	46
Figure 4.3.	Example Test Matrix.....	47
Figure 4.4.	Break-X.....	52
Figure 4.5.	Alert Guidance Symbology.....	53
Figure 4.6.	Head-Fixed Alert Guidance Symbology With Pitch Ladder.....	56
Figure 4.7.	Average Stick Reaction Times.....	59
Figure 4.8.	Average Head Reaction Times .....	60
Figure 4.9.	Average Pitch History Comparison (10-30).....	61
Figure 4.10.	Average Roll History Comparison (10-30) .....	62
Figure 4.11.	Average Altitude Loss (10-30) .....	62
Figure 4.12.	Average Roll Response Time (10-30).....	63
Figure 4.13.	Head Yaw Histories (A - 10-30).....	65
Figure 4.14.	Head Yaw Histories (X - 10-30) .....	65
Figure 4.15.	Head Yaw Histories (AF - 10-30) .....	65
Figure 4.16.	Head Yaw Histories (HF - 10-30) .....	65
Figure 4.17.	Head Yaw Histories (HFP - 10-30) .....	65
Figure 4.18.	Aircraft Pitch vs. Head Yaw (A - 10-30) .....	67
Figure 4.19.	Aircraft Pitch vs. Head Yaw (X - 10-30) .....	67
Figure 4.20.	Aircraft Pitch vs. Head Yaw (AF - 10-30) .....	67
Figure 4.21.	Aircraft Pitch vs. Head Yaw (HF - 10-30).....	67
Figure 4.22.	Aircraft Pitch vs. Head Yaw (HFP - 10-30).....	67
Figure 4.23.	Average Ratings of Attention-Getting .....	69
Figure 4.24.	Average Ratings of Urgency.....	70
Figure 4.25.	Average Ratings of Information Understandability.....	70
Figure 4.26.	Average Ratings of Information Usefulness .....	71
Figure 4.27.	Overall Display Preference .....	72
Figure 4.28.	Average Attitude and Altitude Awareness Ratings.....	73

## **1. Introduction**

Controlled Flight Into Terrain (CFIT) is one of the most significant problems facing military aircraft today. CFIT accidents can be caused by a variety of factors including poor visual conditions, channelized attention, pilot fatigue, miscommunication, information misinterpretation, an overload or lack of information, and an overload of tasks inside and outside the cockpit.

Ground Collision Avoidance Systems (GCAS), or Ground Proximity Warning Systems (GPWS), were developed to combat the CFIT problem by providing pilots with a last-minute warning of an impending ground collision. Since their recent implementation in many military aircraft, CFIT accidents have declined.

Despite the success of GCAS, many problems remain which prevent the complete elimination of CFIT accidents. GCAS reliability is being improved by implementing the ability to scan ahead of the aircraft for terrain hazards. The development of accurate Global Positioning System (GPS)/Inertial Navigation System (INS) avionics coupled with Digital Terrain Systems (DTS) is making GCAS more reliable and accurate. However, problems still exist regarding the pilot interface.

The ability to successfully alert the pilot of a terrain hazard and provide the pilot with the information that enables him or her to immediately grasp the situation in order to react quickly and accurately is a difficult challenge in the environment of a modern fighter aircraft. Military missions often involve deliberate low-level flight in an information intensive environment. These factors lead to high pilot workloads, and dangerous situations can arise quickly and unexpectedly. Current GCAS alerts consist of an audio alerting message and limited visual cues. Alerts may go

unnoticed due to an information or work overload, and the pilot may react more slowly to those that are detected.

A proposed method for addressing this problem is through the use of Helmet-Mounted Display (HMD) technology. Unlike other visual display formats, HMDs can display information in the pilot's immediate field of view, regardless of his or her head position. In a fighter aircraft where pilots spend a great deal of time looking off-boresight, such a system could be an effective means of enhancing GCAS. This thesis documents a two-part simulation study performed in parallel of alert mode and information presentation issues for an HMD-enhanced GCAS through prototype alert and guidance displays.

Chapter 2 provides a background of CFIT and GCAS issues. Aspects of the simulator setup and experimental protocol are discussed in Chapter 3. Chapter 4 discusses the two-part experiment on audio and visual alert modes and information presentation issues. A summary of the conclusions of this thesis is presented in Chapter 5.

It should be noted that the acronym HMD is used interchangeably for Helmet-Mounted Display and Head-Mounted Display in this thesis. Helmet-Mounted Display graphics are projected onto the visor of a pilot's helmet, but the pilot can still view the real world through the visor. A Head-Mounted Display is not transparent, but uses screens to display graphics. In this study, a Head-Mounted Display was used to simulate a Helmet-Mounted Display by projecting outside world graphics as well as symbology that would be drawn on a Helmet-Mounted Display. The acronym will be spelled out in this thesis when a change in meaning occurs.

## **2. Background**

### **2.1. CFIT**

Controlled Flight Into Terrain (CFIT) is an accidental collision with terrain by a controllable aircraft manned by a functional crew. CFIT accidents occur in many different weather conditions, terrain types, and phases of flight. Civil, commercial, and military aviation all suffer CFIT losses each year for a variety of aircraft and crew types.

#### **2.1.1. Problem Magnitude**

CFIT is one of the most significant problems facing the aviation world today. Between 1979 and 1989 CFIT was the leading cause of fatal aircraft accidents around the world [1]. Though much public focus falls on CFIT in the air transportation field, the problem is by no means confined to this sector of aviation.

Between 1983 and 1997, CFIT claimed 106 Navy, 62 Marine Corps, and 141 Air Force aircraft [3,4]. Though air transportation CFIT accidents currently occur at the rate of approximately 5 aircraft per year [2], Navy and Marine Corps aircraft have averaged 8 and Air Force aircraft have averaged 8.7 CFIT losses per year over the last decade (1988-1997) [3,4]. In the Air Force, CFIT is the second largest category of tactical aircraft Class A mishaps (those involving loss of life, permanent disability, total aircraft loss, or over \$1 million in damage) [5]. CFIT has cost the Air Force an average of \$180 million per year over the last decade, and has claimed 160 lives [4]. The military is concerned about these accidents and has taken steps towards eliminating them, as is described below.

### **2.1.2. CFIT Causes**

The root cause of most if not all of these accidents is a loss of pilot Situational Awareness (SA) with respect to the terrain. The very definition of CFIT accidents implies that the pilot was unaware of the situation or became aware of the situation too late to avoid impacting the ground. An exception to this rule is an accident where the pilot makes an intentional maneuver towards the terrain, but incorrectly estimates the aircraft's ability to recover from the maneuver. This situation is applicable to military aircraft which routinely perform aggressive maneuvers close to terrain, such as the A-10 and F-111.

The most obvious conditions for a loss of SA are those of low visibility - flying in clouds, haze, thick fog, or at night. In these instances, unfamiliarity with surrounding terrain, misinterpretation of flight information, and pilot disorientation can all lead to hazardous situations. However, CFIT accidents occur in all types of weather, including calm, high-visibility conditions.

The factors that contribute to CFIT accidents in poor visibility conditions also apply to good visibility conditions, but the pilot has the advantage of being able to maintain visual separation from terrain. However, other factors can hinder the pilot in this task. First, some terrain may be visually deceptive. When flying close to the ground, ridgelines may be obscured in the shadows of higher terrain. Terrain such as desert plains can be featureless, making altitude difficult to judge visually. An example of featureless terrain causing an accident was a DC-10 crash in Antarctica in 1979 [6]. Though the aircraft was in clear visibility conditions, a snow covered ridge was unnoticed due to white-out effects. Shallow sloping terrain can be hard to distinguish and can slowly rise to meet an aircraft maintaining a constant altitude above mean sea

level (MSL). Visual references may also be deceptive. Low-flying pilots use the scale of objects they recognize, such as trees, to judge altitude. When flying over bushes that look like trees, matching the scale results in a much lower altitude. Though aircraft instruments provide a clear information source, visual references are very compelling.

Fatigue is a major factor affecting the performance of a pilot. Intense, lengthy, and multiple sorties are inherent in many areas of military aviation, and can lead to high levels of pilot fatigue. This can result in a loss of concentration, a reduced scan, and overall decrease in SA.

Both the lack and overload of information and tasks can affect SA. Long flights with low taskload can cause pilots to become complacent. This is especially dangerous if a terrain threat is not expected and arises suddenly. In fighter aircraft, the information and taskload tends to fall at the high end of the scale. A study of F-16 mishaps from 1980-1989 named task oversaturation as a definite contributor in over 20% of the accidents [7]. Pilots must often balance a variety of information sources such as the radios, threat warning receiver, targeting computer, and radar system in addition to their primary flight instrumentation. The radios alone can be the source of several types of information on targets, threats, vectoring, wingman intentions, etc., as well as information not relevant to the pilot. Meanwhile, the pilot may be simultaneously tasked with such things as maintaining a high energy state, locating a target, navigating, avoiding ground fire, arming weapons, observing a wingman, or sorting radar targets in addition to avoiding the terrain. This task and information loading reduces the pilot's ability to maintain SA with respect to the ground and devote time necessary for the task of avoiding the terrain.

One particular problem related to task loading is channelized attention. There are instances where a pilot may become so focused on a particular task that flying the aircraft

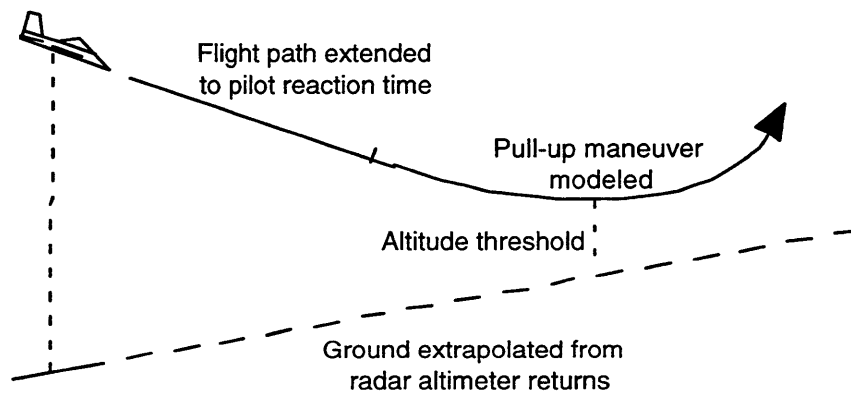
becomes secondary. Channelized attention was deemed a definite contributor in over 60% of the F-16 mishaps from 1980-1989 [7], and often occurs during critical phases of the flight. Ground targets can often be difficult to identify from the air, and pilots can spend tens of seconds, or even several minutes, visually acquiring a target. Tactics often dictate that this acquisition be performed off-axis, where the aircraft flies perpendicular to a line to the target in order to avoid defenses. During weapons release, a pilot can become fixated on the task of lining up a good drop, and this is often done during a dive towards the ground. Pilots can also become fixated on performing a battle damage assessment of their own or their wingman's attack, and this usually necessitates looking to the rear quarter. 44% of F-16 Class A mishaps from 1980-1989 occurred during combat maneuvering [8]. Channelized attention can not only lead to a loss of SA, but may also delay a pilot's awareness of and response to a terrain alert.

## **2.2. GCAS**

The Ground Collision Avoidance System (GCAS) is one of several technological developments designed to prevent CFIT. Two other major systems are Terrain Following Radar (TFR) and the Air Traffic Control (ATC) based Minimum Safe Altitude Warning system (MSAW). TFR is an active and predictive method of ground avoidance, often coupled to the flight control system providing automatic terrain following capability. The associated radar and avionics are bulky and expensive, and the radar emissions can be detected by hostile forces [8]. MSAW is a safeguard for ground controllers used primarily in terminal areas, but limited by ground radar capabilities and Mode-C altitude encoding transponders on aircraft [9]. MSAW does not apply to a large part of the military flight regime.

### 2.2.1. GCAS Description

GCAS (similar in operation to GPWS in commercial aviation) warns the pilot of impending terrain impact via a voice message and warning light. GCAS operates by extrapolating the terrain in front of the aircraft from readings given by the radar altimeter. As the aircraft passes over terrain and the radar altimeter receives returns, the ground slope under the aircraft is calculated from the difference in subsequent measurements and the aircraft rate of descent. The system uses an alerting criteria based on the aircraft altitude above ground level (AGL), its descent rate or vertical closure rate with the terrain (from the vertical speed and calculated terrain slope), and an internal model of the aircraft and pilot performance of a pull-up maneuver [10]. Figure 2.1 shows how the flight path vector is projected forward and then a pull-up maneuver is modeled. If the projected flight path passes through an altitude threshold, an alert is issued.



**Figure 2.1**  
**GCAS Alert Method**

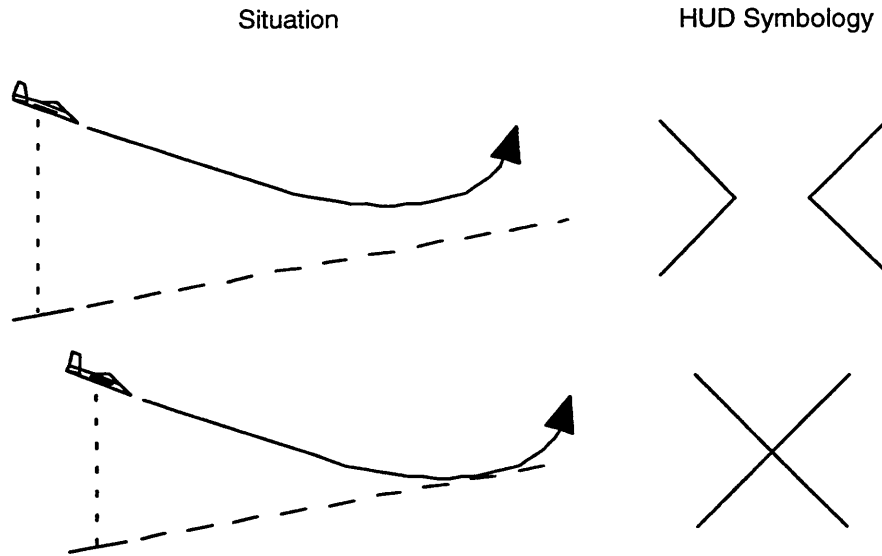
Military aircraft employ a variety of systems functionally equivalent to GCAS. The Low Altitude Warning System (LAWS), Low Altitude Safety and Targeting Enhancements (LASTE), and Ground Clobber (GC) systems all operate in the same manner as traditional GCAS with a

radar altimeter [11]. The major difference between them is the various assumptions and thresholds that go into their algorithms. For example, when modeling the pull-up maneuver of the equipped aircraft, different systems make various assumptions about weight, pilot reaction, and aircraft performance.

### **2.2.2. GCAS Information**

GCAS provides only limited information to the pilot regarding a terrain threat. For most systems currently employed on military aircraft, up to three information sources exist. The first is an audio message transmitted to the pilot through the aircraft's communication system. This usually consists of a voice message, "PULL-UP!" and may include a series of accompanying alert tones. GCAS may provide a warning light in the cockpit as an additional alert. Third, there may be accompanying Heads-Up Display (HUD) symbology, depending on the particular system.

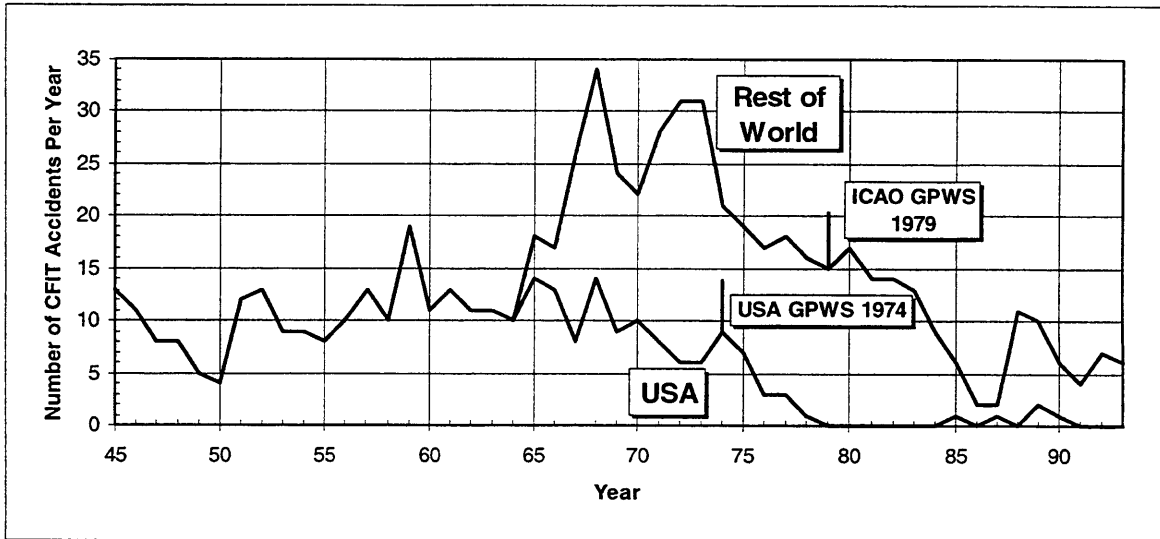
In all cases, the information transmitted is minimal in content and primarily targeted at attention-getting. The audio alert and warning light tell the pilot only that a dangerous situation has been reached and immediate action is required. These alerts do not vary in intensity in any way. Also, the HUD symbology does not often provide additional information. In most cases a "break-X" is drawn in the center of the HUD. In the case of the A-10, the "X" obscures any symbology that would normally appear behind it including weapons, velocity vector, and partial pitch ladder symbology. In some cases, the alert symbology gives information regarding the severity of the situation. An example is the F-16, where two chevrons move together to form a break-X. The distance between chevrons is related to the predicted time to impact as shown in Fig. 2.2.



**Figure 2.2  
F-16 GCAS HUD Symbology**

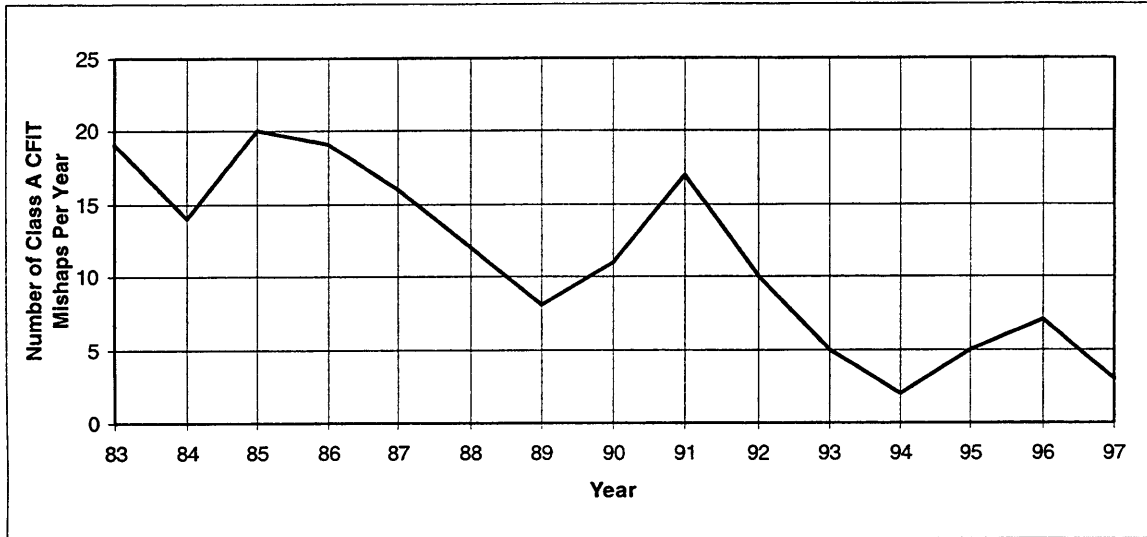
### **2.2.3. Impact of GCAS on CFIT Accidents**

The development of GCAS has helped reduce the number of CFIT accidents in commercial and military aviation in recent years. In commercial aircraft, the effect of GCAS has been dramatic and undisputed. In 1975, the FAA mandated the Ground Proximity Warning System (a simpler form of GCAS) on most air carrier turbine-powered aircraft [12]. In 1992, this requirement was expanded to include all commercial aircraft with 10 or more passenger seats [12]. Figure 2.3 shows a definite decrease in CFIT accidents for transport aircraft in the USA after 1975 and shows a similar decrease for the rest of the world after 1979 when GPWS was adopted as a standard by the International Civil Aviation Organization (ICAO) [13]. This decrease is also due to improvements in CFIT awareness, training, procedures, and ATC radar coverage.

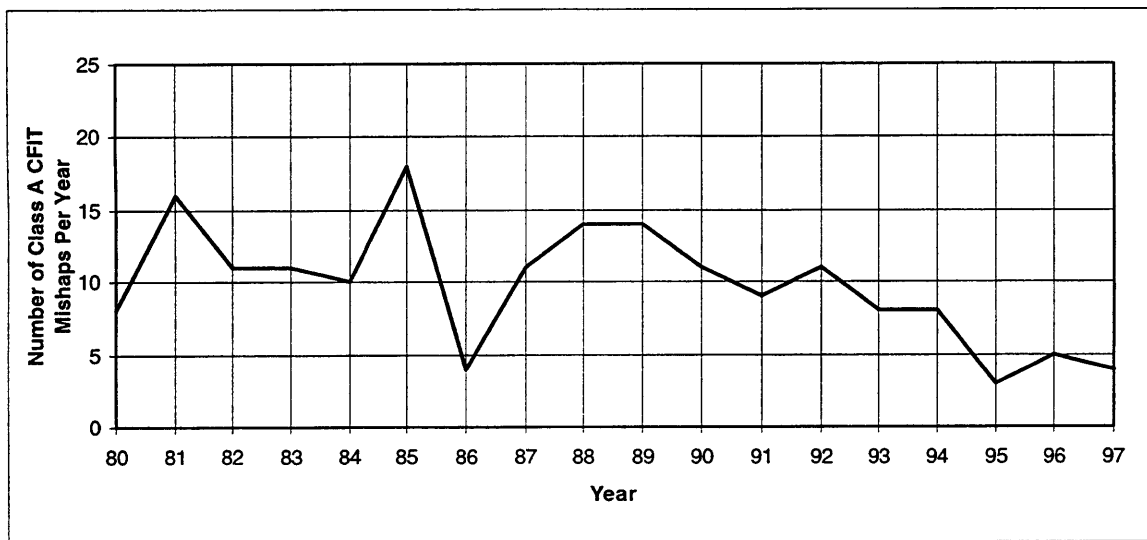


**Figure 2.3**  
**CFIT Accidents Per Year (Large Turbo-Jet and Prop-Transports) [13]**

Similar significance can be inferred for military aviation. However, it is not as statistically apparent because GCAS has been implemented in different forms on different types of aircraft at various times and in various numbers of each type. There has been no definitive military standard for implementing GCAS. Fig. 2.4 shows a decline in CFIT accident rates for the Navy and Marine Corps from 1983-1997. Fig. 2.5 shows a similar decline for the Air Force from 1980-1997. But besides GCAS, this decline may be due to education and training.



**Figure 2.4**  
**Navy/Marine Corps Class A CFIT Mishaps Per Year (All Aircraft Types) [3]**



**Figure 2.5**  
**Air Force Class A CFIT Mishaps Per Year (All Aircraft Types) [4]**

**2.2.4. GCAS Shortfalls**

Despite the apparent success of GCAS, CFIT accidents continue to occur. There are several reasons why CFIT has not been eliminated. Some aircraft still have no GCAS capability. Even on aircraft equipped with GCAS, current systems cannot directly sense terrain in front of the

aircraft. This causes two problems. GCAS can generate false warnings in cases where the terrain slope changes ahead of the aircraft (such as ridgelines) and where the radar altimeter receives a false ground return (such as from clouds or other aircraft). Also, sudden changes in terrain or sudden maneuvers of the aircraft can lead to a late or missed warnings.

High rates of false warnings causes pilots to lose trust in their GCAS. They may react slower (checking to see if an actual terrain hazard exists) or disregard the warnings completely. "Delayed Response Syndrome," due to a pilot checking the validity of a warning, is a well documented problem [12,14]. Finally, the GCAS alerts themselves are limited in the information they provide and the modes they use to provide it. The warning light and HUD symbology may be missed if the pilot's visual attention is someplace other than at these locations. The audio alert can also be missed due to masking effects of other noises in the cockpit such as radio calls and other alerts. When multiple channels (or sources) of information are presented to a pilot, the pilot tends to sample channels where information is presented more frequently [15]. This can lead to missed detections of alerts which occur infrequently. Warnings can be overlooked in situations of high pilot workload and high information load, such as during air combat or weapons delivery. Alerts that are detected may be reacted to more slowly due to the effect of multiple stimuli on reaction time [15].

These flaws are accentuated by the low altitude and high maneuverability flight regimes of some military aircraft, as well as the fact that military pilots are often in high stress and workload situations. In order for GCAS warnings to be effective, "The pilot needs time to recognize, believe, and react" [16], but in a low altitude fighter, events may occur more quickly than the pilot can deal with them.

One way to improve the performance of the system and increase its reliability is to develop a better algorithm. Modeling the predicted aircraft recovery more accurately through better pilot response and aircraft performance models is one method. Another way is to provide GCAS with a better model of the terrain in front of the aircraft. Coupling GPS/INS based navigation data with a digital terrain database provides an accurate method of hazardous terrain detection [17]. Using this data, GCAS can probe terrain ahead of the aircraft and into turns as well. These enhancements can reduce the number of late and false alarms inherent in current GCAS. However, the problem of getting the pilot's immediate attention and having the pilot react in the appropriate way remains.

### **2.3. Proposed Approach to Information and Attention Shortfalls**

This thesis specifically addresses the GCAS problems of information transfer to the pilot and attention-getting during times of high taskload. The primary example situation from which the experiments performed were drawn is of a single seat, low altitude attack aircraft operating in a target rich combat environment (both hostile and friendly targets present), such as an A-10 aircraft on a Close Air Support (CAS) mission. In such a situation, the pilot's attention is focused on sorting targets located around the aircraft, in addition to flying and monitoring the state of the vehicle and possibly avoiding ground fire. The pilot is also sorting information from the radios, correlating this with what he or she sees, and transmitting queries and intentions. Both the audio and visual channels of the pilot are highly saturated. The absence of other crew members means tasks cannot be delegated, placing the need for parallel task processing solely on the pilot.

The presence of an imminent terrain threat must be communicated to the pilot in the most clear, direct, and timely manner. The two main means of information presentation are audio and

visual. Other alert modes have been suggested, such as using the tactile sense by delivering vibrations or mild electric shocks. False tactile alerts, especially shocks, may be more annoying to the pilot than false audio or visual alerts. Also, a pilot in a maneuvering fighter aircraft is subject to large forces, and tactile alerts may be masked by these sensations. The olfactory sense is not dependable as a reliable information source because of human sensitivity issues. Tactile and olfactory displays are limited to transmitting a small number of discrete signals. Though they might be useful for warning purposes, they are not suited for more complex information [15].

Audio alerts have the advantage of being non-dependent on head and eye position. However, they are limited in the amount, type, speed, and bandwidth of information that can be displayed. Audio alerts are primarily suited for attention-getting and the transmission of simple messages. Visual alerts are dependent on where the pilot is looking, though they can display complex and large quantities of information simultaneously. Thus, visual alerts are often used to provide guidance and state information.

In the case of a GCAS system, the information to be transmitted is relatively uncomplicated, but the urgency is great. This would seem to point towards an audio presentation. However, the effectiveness of this audio alert is reduced in situations of high stress, other audio inputs, channelized attention, and high work and task loads. Audio and visual alerts used in conjunction complement each other. A study performed by Boeing, Douglas, and Lockheed aircraft manufacturers showed that a visual and voice alert combination was more effective than a voice-only alert when used with aircraft related tasks [18].

Helmet-Mounted Display technology offers the ability to project visual information to the pilot regardless of head position. Displaying a break-X on an HMD, for example, would ensure

that the visual channel is available for an alert to the pilot at all times. Additionally, this channel could also provide state and guidance information to the pilot.

The current GCAS audio alert provides only attention-getting information. The pilot still needs to process the state of the aircraft relative to the terrain and compute the proper recovery procedure. While in principle this seems simple, e.g. roll upright and pull, pilots may be temporarily disoriented, and need to know how much to pull and when a safe recovery (flight path angle) is attained. Though viewing the horizon to the sides and rear of the aircraft can provide some state information, the HUD, primary flight instrumentation, and oncoming terrain is to the front. This means that if the pilot is looking to the sides or rear of the aircraft, he or she must return their visual attention to the front to gain proper state information. The recovery procedure for a GCAS alert has been standardized to allow the pilot to react as quickly as possible as opposed to formulating a specific recovery for the particular situation. This procedure calls for the pilot to unload the aircraft, roll the wings approximately level, and then pull the nose up to climb away from the terrain. Though the procedure is standardized, the pilot still needs to comprehend the state of the aircraft in order to roll and pull correctly.

This thesis hypothesizes that a visual alert projected directly in the pilot's field of view coupled with a corresponding audio alert will mitigate the effects of high stress, other audio inputs, channelized attention, and high work and task loads. This thesis also hypothesizes that providing the pilot with state and/or guidance information via an HMD will allow the pilot to immediately initiate the recovery regardless of his or her head position. This could result in faster reaction times in situations where the pilot's attention is focused away from the front of the

aircraft. Furthermore, the use of additional state and guidance information could enable the pilot to make a more confident, aggressive, and precise recovery maneuver.

### 3. Experimental Facilities

A two part experiment was performed using a T-38 flight dynamics simulator developed by The C.S. Draper Laboratory, along with a partially functional, fixed-based T-38 cockpit, and a Head-Mounted Display with audio headphones coupled to a head tracker. The experiment tested display configurations for a fighter GCAS system.

The first part of the experiment compared an audio-only alert modality with an audio and visual modality. The second part compared different formats of visual guidance and state information used during a GCAS alert. Specifics of the experiment are discussed in Chapter 4. This chapter describes the facilities used to conduct the experiment and the protocol common to both parts of it.

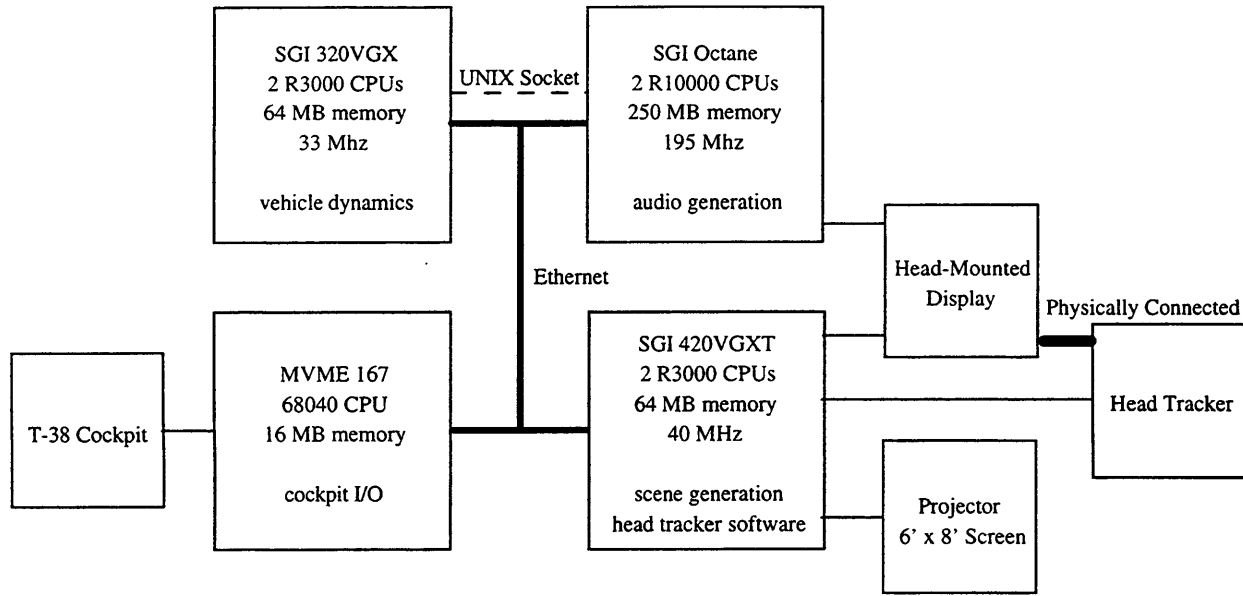
The desired goal of the setup was to create a simulated flying environment similar to the experience of a low-flying fighter in a high task and information load situation. Then, the different display configurations could be tested for their effects on the pilot's response. The difficulty in designing such a setup came from balancing realism with simplicity and repeatability, and ensuring that the pilot responses mirrored those that would occur in an actual fighter aircraft. The strategy was to divert the pilot's visual, audio, and mental attentions away from the task of monitoring terrain by assigning visual and audio side tasks. Then, an alert was given and the pilot's response was observed.

In order to achieve repeatable aircraft attitudes for testing alert responses, an autopilot flew the aircraft through a series of maneuvers close to the ground. Targets appeared to the sides of the aircraft to be designated by the subject with a head-fixed sight as a side task. The subject also listened to a stream of simulated radio callsigns and responded to his or her own callsign.

These tasks were intended to distract the subject from the aircraft's attitude and altitude. At certain predefined conditions during the testing, a simulated GCAS alert was given, consisting of a voice alert and one of several sets of symbologies. When the alert was given, control of the aircraft was transferred to the subject, who then flew a standard recovery maneuver. Several aircraft state variables as well as the pilot's head position were continuously recorded.

### **3.1. Simulation Hardware and Software**

The entire simulation setup resided on four processors - the first hosted the T-38 vehicle dynamics and timing routines, the second hosted the outside scene and head tracker, the third hosted the T-38 cockpit hardware Input/Output, and the fourth hosted the audio generation. Fig. 3.1 shows a block diagram of the integrated simulation setup with specifications for each processor. All processors communicated through a common ethernet connection. The vehicle dynamics, scene generator, cockpit I/O, and head tracker programs broadcasted and gathered information in a standardized format over a Network DataBase (NDB). The simulator and audio generation programs sent and received signals directly through a UNIX socket connection.



**Figure 3.1**  
**Simulation Hardware Block Diagram**

### 3.1.1. T-38 Vehicle Dynamics

The C.S. Draper Laboratory T-38 vehicle dynamics simulator was chosen because it is robust, flexible, and provides a “generic” fighter aircraft simulation (all Air Force fighter pilots have flown the T-38). The simulator closely approximated the flight characteristics of a USAF T-38 aircraft, used for preliminary fighter training. The vehicle dynamics program sent outputs to and received inputs from the scene, cockpit I/O, and head tracker via the NDB. It also sent messages to the audio generator via the UNIX socket connection. This program was considered the core of the integrated flight simulator. In addition to calculating the vehicle dynamics, it managed environmental factors and included data recording capabilities.

### 3.1.2. Visual Scene

The visual scene was functionally one of the most important pieces of the experiment. The scene was generated using the Gemini Visual System (GVS) SIMation Series Software graphics package. The GVS software included functions for building and manipulating scene

objects and creating viewing “cameras” and attaching them to objects, as well as pre-built objects and textures to be used in a scene.

### **3.1.3. T-38 Cockpit**

The T-38 cockpit was used to make the simulated flight experience more realistic. It provided a pilot interface consistent with operating an actual fighter. The T-38 cockpit was already configured for use with the T-38 simulator. It included a number of analogue and discreet channels for controls. The controls utilized for these experiments were the stick, rudder pedals, and two thumb buttons on the stick (one on the top adjacent to the trim coolie switch and one on the left side midway down the stick - both accessed by the right thumb). The two throttles and flap switch provided inputs to the simulation, but remained fixed for these experiments at full military power and zero degrees of flaps.

### **3.1.4. Head-Mounted Display and Head Tracker**

To give the pilot an unlimited field of view and simulate a Helmet-Mounted Display, a Head-Mounted Display with an attached head tracker was used. The Virtual Research Systems, Inc. VR4 HMD used two 1.3 in Liquid Crystal Displays (LCDs) to provide color images to the pilot’s eyes at a 480 x 240 color pixel resolution [19]. The HMD displayed a 50° x 40° field of view, and the periphery was blocked by the front shell of the unit. Though the lack of peripheral images detracted from the creation of a realistic virtual world, this feature was useful for these experiments because it helped to reduce the pilot’s awareness of aircraft attitude and altitude. The video image was not broadcast in stereo for this experiment. The HMD also featured earphones for the transmission of audio signals. A control unit received inputs from the scene

generation video output and audio generation audio output and broadcast the signals to the HMD through a single 22 pin bundle.

In order for the HMD to function properly, a head tracker was needed to provide pilot head angles to the scene. The Logitech Head Tracker used for these experiments operated via ultrasonic signals. A stationary transmitter broadcast these signals from three speakers covering a 100° conical area out to a distance of 5 ft [20]. The ultrasonic signals were received by a receiver mounted on the top of the HMD. The receiver relayed the signals back to the control unit which resolved the head angles. Head position data was also available, but was not used for these experiments. The unit's report rate was 50 Hz [20]. Information was transmitted to the head tracker software through a 19,200 baud serial port.

The head tracker exhibited two major flaws. At very high head angles (approximately 135° yaw or 50° pitch) significant jitter was seen. This was enhanced by a person's tendency to lean back or to the side while looking upwards or backwards. The motion of leaning moved the head tracker receiver to the edge of the sensor field, while the tilting of the head turned the receiver away from the fixed broadcaster. Also, very high head movement rates (on the order of several hundred deg/s) could cause the tracker to lose its lock, resulting in significant display lags. The jitter effect was minimized by raising the fixed broadcaster as high as possible, creating a larger tracking region.

The HMD and head tracker were not existing parts of the simulation, and had to be properly integrated. A mounting plate was added to the T-38 cockpit behind the front seat to hold the display and tracker control units. An adjustable arm was attached to the plate which held the stationary head tracker transmitter over the pilot's head. The transmitter was positioned

approximately 1.5 ft above a typical pilot's head. The arm could be rotated as well as raised and lowered.

The head tracker software continuously broadcasted the head pitch, roll, and yaw angles to the NDB. A routine in the scene software read in the pilot head angles and adjusted the pilot camera rotations to display the appropriate view. The standard computer monitor signal operated at 60 Hz while the HMD required an NTSC standard signal at 30 Hz. A routine in the scene software enabled the video output to be switched between these two formats. Though the computer monitor could not display the NTSC format, the video signal also ran to a projector used to display the scene on a screen in front of the T-38 cockpit which could read both signal formats. The projector and screen were used to monitor the scene during testing and also to demonstrate the HMD without it being worn.

### **3.1.5. Sound**

To test the different alert modalities and realistically simulate a GCAS alert, audio capability was essential. This capability was also used to produce simulated radio calls. An audio generation program was developed which received inputs from the T-38 simulator and generated audio signals using the Iris Audio Processor on the SGI Octane.

Sounds were stored in audio message files read by the audio generation program. The audio generation program received signals from the run-time simulator program directing it to queue up and play the appropriate sound file through the sound card. Sound files could also be queued and played manually through the program. The messages were sent to the head-mounted display control box, which sent a signal to the earphones attached to the display. The audio generation program was limited to serial broadcast of audio messages.

### 3.2. Experiment Configuration

During an experimental run, the autopilot flew the aircraft through prerecorded trajectories while the pilot accomplished audio and visual side tasks. The four flight profiles used each ended in specific pitch, roll, and altitude conditions, shown in Fig. 3.2. At the end of each profile, when the attitude and altitude conditions had been reached, a GCAS alert was given in one of several different formats (discussed in Chapter 4). The pilot then was given control of the aircraft and flew a recovery maneuver. After the recovery, control was returned to the autopilot, and another profile and recovery was flown. The four profiles were each flown once during a run. One run was performed for each display format.

Profile #	Pitch	Bank	Altitude
1	10° Down	30° Left	900 ft
2	10° Down	60° Right	1000 ft
3	20° Down	30° Right	1300 ft
4	20° Down	60° Left	1900 ft

**Figure 3.2**  
**Profile End Attitude and Altitude Conditions**

#### 3.2.1. Environment, Scene, and Symbology

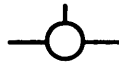
A pre-rendered scene centered at Randolph AFB in San Antonio, TX was chosen as a basis for the experiment because of its flat, featureless terrain. The terrain was textured green, and created the illusion of flat, grass-covered rolling hills. Such terrain was desired to decrease

the pilot's SA with respect to the ground. The terrain elevation was set at zero ft MSL. All buildings, runways, roads, clouds, and other structures were eliminated from the scene. The sky was colored pale blue, similar to a clear midday. A clear, well-defined horizon was used with no haze or fog effects. The scene used an F-5 object (identical to a T-38 except for the addition of AIM-9 Sidewinder missiles on the wingtips) provided by the GVS software to represent the simulated T-38. Due to the pilot camera being positioned inside the aircraft object, much of the cockpit structure was transparent. A black polygon was added to represent the inside of the cockpit. It covered the area between the nose and rear bulkhead, and obscured the pilot's view at angles greater than 45 degrees below the horizontal. No head-down cockpit instrumentation was displayed by the scene.

The symbology was generated in two reference frames: head-fixed and aircraft-fixed. All symbology was chosen to be black to avoid color associations and to contrast with the green terrain and blue sky. All symbols were drawn with a three pixel line-width. The head-fixed symbology was created using an existing HUD creation routine, drawn with a milli-radian coordinate system. The aircraft-fixed symbology was created as objects whose positions and rotations were updated in relation to the aircraft. Therefore the pilot could move his or her head and the symbology would remain fixed with regard to the aircraft. The distance of the symbology from the pilot eye camera was adjusted to match the symbology created in the head-fixed reference frame.

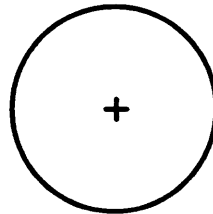
Some symbology was common to both parts of the experiment and will be described here. The symbology specific to each part of the experiment is discussed in Chapter 4. The only flight information symbology the pilot received at all times was a flight path vector. This symbol was

created in the aircraft-fixed reference frame and moved with regard to the aircraft angle of attack. Sideslip motion was not incorporated into the symbology. The flight path vector, shown in Fig. 3.3, was portrayed in the standard format of a miniature aircraft symbol. It consisted of a 10 mrad radius circle with two 20 mrad wings and a 10 mrad vertical tail attached to the outside of the circle.



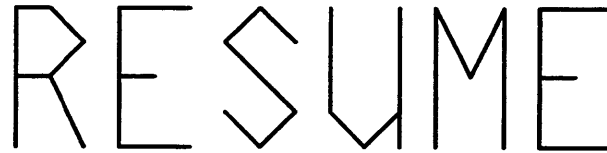
**Figure 3.3**  
**Flight Path Vector**

The second piece of symbology was a targeting circle used in the visual targeting task. The symbol, shown in Fig. 3.4, was generated in the head-fixed reference frame. It consisted of a 50 mrad radius circle with a 10 mrad wide and 10 mrad high crosshair in the center. The circle and crosshair was centered in the field of view.



**Figure 3.4**  
**Targeting Circle**

The last piece of common symbology was a “RESUME” message used at the end of each GCAS recovery to indicate to the pilot that it was safe to level off from the recovery climb attitude. The message, shown in Fig. 3.5, was generated in the head-fixed reference frame. “RESUME” was written in all capital letters. The letters were each 40 mrad x 80 mrad in size separated by 20 mrad spaces. The entire message was of dimensions 340 mrad x 80 mrad and was centered in the field of view.



**Figure 3.5**  
**“RESUME” Message**

The scene code contained most of the logic dictating when specific symbology should be displayed. The switch to alert symbology was cued from a message sent by the flight profile runtime program.

### **3.2.2. Pilot Side Tasks**

Side tasks were used to create the high task and work load situation for which an improved GCAS pilot interface is needed. The tasks were designed to load the pilot’s visual and audio channels. The tasks were also designed to take the pilot’s focus away from the aircraft attitude and altitude, decreasing their SA with regard to the terrain.

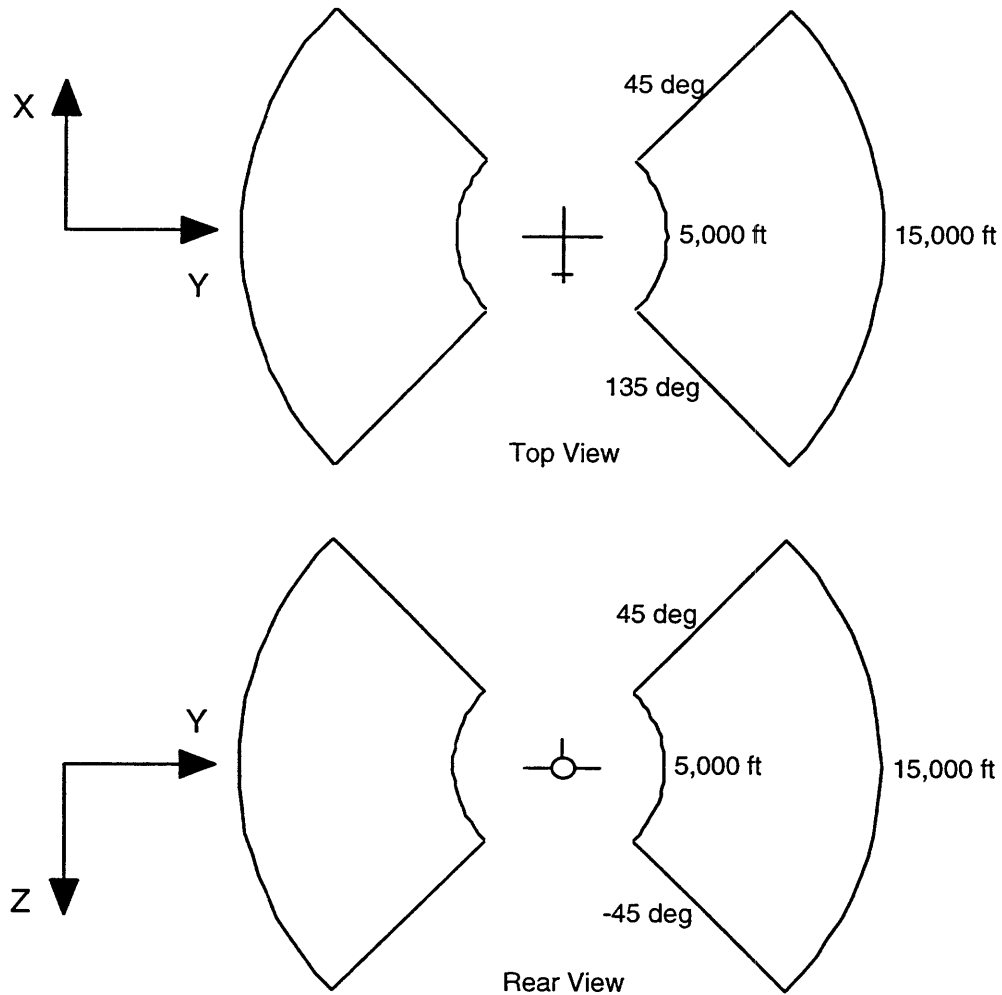
#### **3.2.2.1. Visual Task Description**

The visual task required the pilot to designate targets using a targeting circle affixed the center of the pilot’s field of view. The task was designed to increase the physical and mental workload on the pilot while diverting their visual and mental attentions away from the aircraft attitude.

Twelve targets (six “friendly” red circles and six “enemy” red squares) were constantly displayed around the aircraft. These targets were stationary in inertial space. Each target’s rotation was updated continuously so the target was always facing the aircraft. Though this detracted from the illusion of a 3-dimensional target in inertial space, it ensured that all targets were equally distinguishable with regard to the viewing angle and always directly faced the

aircraft. The squares were of dimensions 200 ft x 200 ft and the circles had radii of 115 ft, giving them approximately the same surface area.

To divert the pilot's attention away from the front of the aircraft, where attitude is apparent, the targets remained in two areas to either side of the aircraft. These areas (shown in Fig. 3.6) were bounded by relative azimuth lines of  $45^\circ$  and  $135^\circ$  to the right and left of the aircraft X-axis (out the nose) and elevation lines of  $-45^\circ$  and  $45^\circ$  above and below the aircraft Y-axis (out the right wing). However, the relative azimuth and elevation of each target was measured from the pilot's head position and not the aircraft center of gravity. Targets were initialized randomly inside these boundaries between 5,000 and 15,000 ft from the pilot's head. At 5,000 ft, the target dimensions were 40 mrad x 40 mrad for the squares and 23 mrad radii for the circles. At 15,000 ft, the target dimensions were 13 mrad x 13 mrad for the squares and 8 mrad radii for the circles. The position of each target relative to the aircraft was constantly checked. Targets that strayed outside the relative azimuth and elevation boundaries due to the motion of the aircraft were repositioned randomly inside the boundary at the same elevation and distance ranges, but between  $45^\circ$  and  $90^\circ$  azimuth. This was done to ensure the targets would be in sight for a significant amount of time before the aircraft flew by them.



**Figure 3.6**  
**Target Boundaries**

Pilots designated targets by positioning their head so the center of the targets fell within a targeting circle and depressing the top thumb button on the stick in the T-38 cockpit. The 100 mrad diameter targeting circle (Fig. 3.4) was affixed to the pilot's head in the center of his or her immediate field of view. All targets whose centers were contained in the targeting circle were designated and "disappeared." Targets that were successfully designated by the pilot were repositioned in the same manner as targets that moved outside the boundary conditions, creating the illusion that the old target had been killed and a new one had appeared.

To determine the success or failure of a targeting attempt, when an upper thumb button depression was detected, the scene software compared the yaw and pitch rotation angles of each target to the yaw and pitch rotation angles of the pilot's head with respect to the earth. Because the targets' rotation angles were constantly updated to face towards the pilot's head, if the two sets of angles matched, the pilot would be looking at the target. If the angular difference determined by  $\sqrt{(\Delta\text{yaw})^2 + (\Delta\text{pitch})^2}$  for any target was found to be less than or equal to 50 mrad (the radius of the target circle), the target was randomly repositioned in the regeneration limits with respect to the aircraft and a hit was recorded in the appropriate category (friendly or enemy). If no hits were found, a miss was recorded. Therefore in practice, to hit a target, the center of the target had to be inside the targeting circle when the attempt was made. Note that since all targets were checked for a targeting success or failure, if multiple targets fell inside the targeting circle when the upper thumb button was depressed, they would all be designated. Hits, frags (hitting a friendly), and misses were recorded any time the designation button was pressed.

During alerts where visual symbology was activated, the targeting circle disappeared. Pilot performance on the visual task was only measured during the profile before each alert.

### **3.2.2.2. Audio Task Description**

The audio task required the pilot to listen to a series of callsigns and respond when the pilot heard his or her own callsign. The task was designed to increase the physical and mental workload on the pilot while diverting their audio attention away from listening for GCAS alerts and their mental attention away from the aircraft attitude.

The pilot received a constant stream of callsigns through the headphones on the HMD. The callsigns were recorded at 16 KHz using a microphone and recording program. They were

recorded at an even rate in a male voice without inflection. Each lasted approximately 0.5 s. The pilot was instructed to respond to their own callsign, "Falcon 3," by pressing the side thumb stick button within one second of hearing it. Six other incorrect callsigns were used to increase the difficulty of the task: "Falcon 1," "Falcon 4," "Eagle 1," "Eagle 3," "Farmer 2," and "Farmer 3."

The run-time program under the vehicle dynamics simulation controlled the audio task. It sent signals to the audio generation program to trigger the playing of callsigns to the pilot. The callsigns were generated in pseudo-random order at pseudo-random intervals between 1.5 and 3 s.

When the side thumb button on the stick was depressed, a check was made to determine the score. If the correct callsign had finished playing less than a second before, a correct response was scored, otherwise an incorrect response was scored. If the correct callsign had been played and one second had elapsed without a response, a miss was scored.

The audio task remained functional during a GCAS alert and pilot recovery with the exception of during the GCAS audio alert. To ensure proper timing of the audio portion of the GCAS alert, the transmission of callsigns was halted until the alert message had been completed. Callsigns continued throughout the remainder of the recovery, but pilot performance on the audio task was only measured during the profile before each alert.

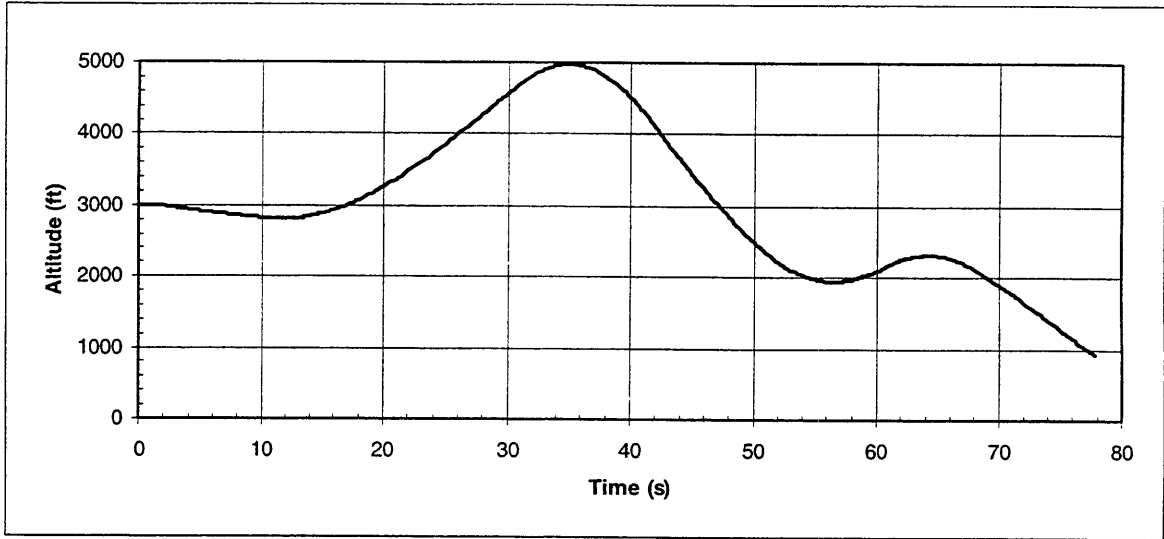
### **3.2.3. Flight Profiling**

Automatic flight profiles were chosen over manual flight control for times when the pilot was not performing a GCAS recovery. The question of whether to allow the pilot to control the aircraft through the entire experiment was heavily debated. Using an autopilot in any sort of simulated "combat" situation does not coincide with fighter tactics doctrine and is unrealistic. However, it was felt that allowing pilot control of the aircraft would imply an assumption of

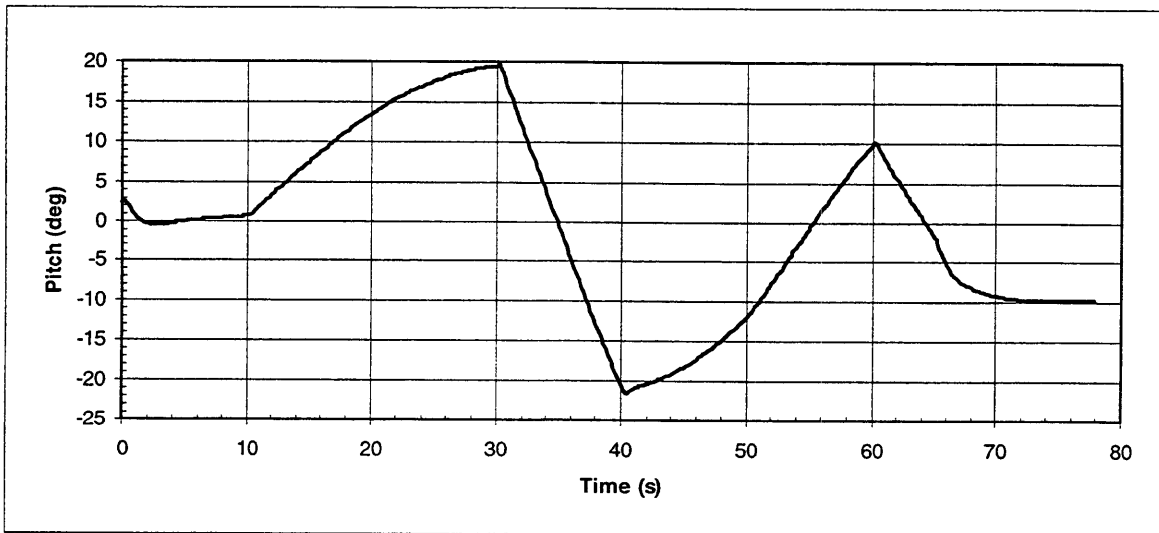
responsibility for ground avoidance and increase the pilot's attention on attitude and altitude. It would also impose a significant learning curve on pilots not current in the T-38. Conversely, commanding unexpected maneuvers while the pilot's attention was focused away from the front quarter would decrease the pilot's SA. Furthermore, though a flight director could be used to guide the pilot to a final specified state before a GCAS alert, the use of a flight director requires attention to aircraft attitude. Also, the use of a pilot-followed flight director is less precise than an autopilot for achieving specific attitude and altitude parameters.

Flight profiling was necessary to set up specific repeatable conditions for the testing of GCAS recoveries using different symbology. No autopilot existed for the T-38 simulator, so a simple run-time autopilot was created. Four distinct flight profiles were created, each ending in specific attitude and altitude conditions. This provided four distinct test cases to be used with each set of symbology. The profiles took the aircraft through a series of maneuvers designed to decrease the pilot's SA while he or she was performing the audio and visual side tasks. Because the majority of each profile was flown using predefined stick inputs and because the starting conditions could vary, the actual aircraft trajectories differed slightly among experimental runs. This led to slight time variations of each profile due to the varied time in achieving the specific end conditions.

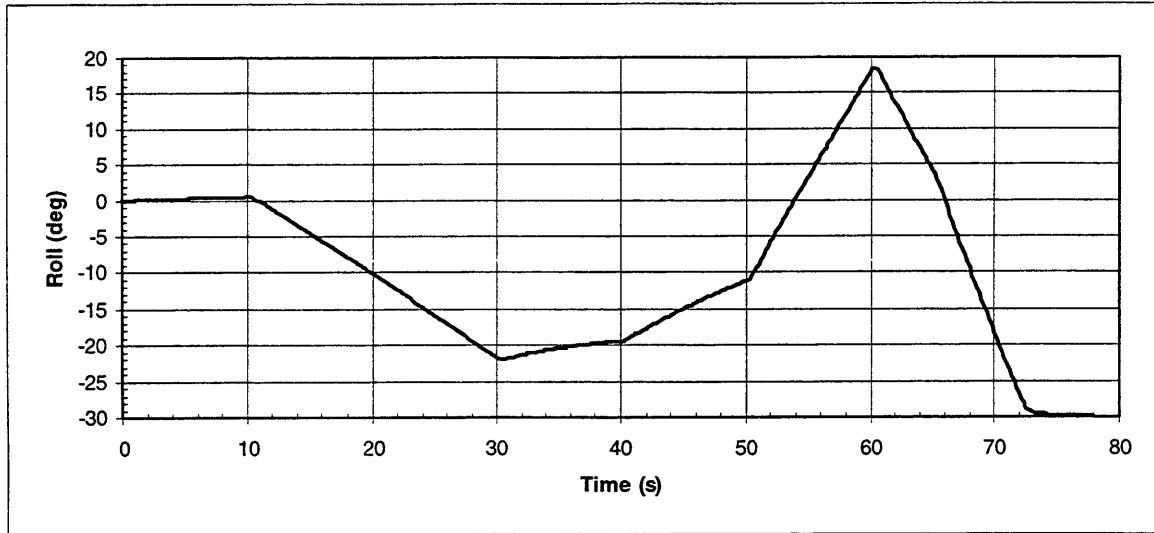
Approximate profile times were: Profile 1 - 80s; Profile 2 - 115s; Profile 3 - 125s; Profile 4 - 155s. Profiles were limited to approximately  $\pm 60^\circ$  bank and  $\pm 20^\circ$  pitch. The end conditions for the profiles are shown in Figure 3.2. Figs. 3.7 - 3.9 show altitude, bank, and pitch histories for a typical case of Profile 1. Typical histories and ground tracks for each profile are listed in Appendix A.



**Figure 3.7**  
**Altitude History - Profile 1**



**Figure 3.8**  
**Pitch History - Profile 1**



**Figure 3.9**  
**Roll History - Profile 1**

When a profile was called, the program disabled stick inputs to the simulator from the cockpit I/O. Then, a series of maneuvers were commanded by providing predefined stick inputs to the simulator based on the time into the profile. For example, in Profile #1, between 10 and 30 seconds, the stick was set at approximately 20% forward stick and 1% left stick.

At the end of the profile, a two-stage feedback-loop autopilot was enabled to bring the aircraft to its final target parameters. The prior maneuvers were designed to end with the aircraft at a point above the final desired altitude, facilitating a final diving maneuver towards the ground to trigger the GCAS alert. Once the desired final altitude had been reached, the profile sent a message to the audio generator and outside scene to display the GCAS alert, and control was returned to the pilot.

Because the subjects were out of the control loop during the flight profiles, the cockpit stick inputs did not match the profiled stick inputs at the end of the profile. To avoid a sudden stick transient, the profiled stick inputs were phased out in the following manner. When the

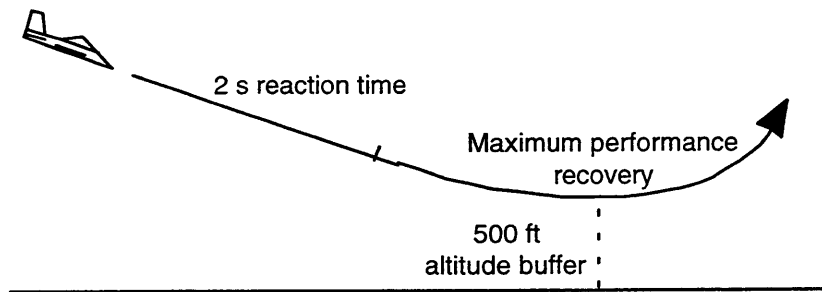
profile ended and control was returned to the pilot, the stick inputs were transferred to trim settings. Therefore, if the cockpit stick was centered, the trimmed stick input would exactly match the ending profiled input and no transient would result. Over the next 2.5 seconds, the stick trim was proportionally reduced to a setting resulting in neutral aircraft trim in straight and level flight at full military power. Though the trim was adjusted while the pilot was in control of the aircraft, the trim phase out was small in comparison to the stick motions during a recovery, so the change in aircraft handling characteristics was unnoticeable to the pilot. This trim phase-out was only used for the longitudinal stick input because at each ending condition, lateral stick inputs from the autopilot were close to zero.

### **3.2.4. GCAS**

#### **3.2.4.1. Simulated Functionality**

A complete GCAS algorithm was not necessary for the experiments because of the pre-specified final profile conditions. Also, the purpose of these experiments was not to evaluate the GCAS algorithms themselves. However, the proper functioning of a GCAS system had to be simulated.

The altitudes at which the flight profiles would end (and the simulated GCAS would activate) were derived experimentally from the final attitude conditions. The simulated GCAS algorithm was chosen with the following specifications: a 500 ft altitude buffer, maximum performance recovery, and 2 s pilot response time were assumed. These specifications are shown in Fig. 3.10.



**Figure 3.10**  
**Experiment GCAS Specifications**

A preliminary experiment was conducted in which the aircraft was flown at full military power to the specified attitude conditions for each profile at a low altitude and held at those conditions for at least 2 s. Then, a recovery was performed in the standard manner of rolling the wings approximately level and pulling out of the dive at maximum G's. Flight data was recorded and the altitude loss from 2 s before the recovery to the minimum altitude reached was extracted. Four runs for each condition were averaged and a 500 ft buffer was added to these altitude losses. These values were rounded to the nearest 100 ft. The final altitudes were used to end the flight profiles and activate the GCAS alerts.

The structure of the profiles made it possible to lead the aircraft into a situation which obviously warranted a GCAS alert. Therefore, the flight profiles were checked during their creation to ensure that a situation requiring a GCAS alert was not encountered until the end of the profile.

#### **3.2.4.2. Alert Format**

The alert format consisted of audio and visual modes (except in one test condition where only the audio alert was tested). The audio alert consisted of a voice message, "Pull up! Pull up!," spoken urgently in a woman's voice and repeated once after a 1.75 s delay. The message

was recorded at 16 KHz using a microphone and recording program, and lasted approximately 0.75 s. The different visual alerts are explained in detail in Chapter 4. The visual and audio alerts were activated simultaneously as soon as the target altitude was reached. The run-time program that controlled the flight profiles sent the message to the audio generation program to play the GCAS alert at the appropriate time. Though the audio alert was only played twice, the visual alert persisted until the aircraft passed through a “safe” altitude limit of 2500 ft AGL.

### **3.2.5. Data Recording**

The run-time input file used for the flight profiles and audio task also provided initial conditions for the simulator. An additional input file for the simulator was used to initialize the data recording function, setting the variables and data recording rate. The data recording function recorded all variables at a constant simulator time rate of 5 Hz (simulator time very closely approximated real time) to their maximum precision to a single file for each simulator initialization and run sequence. These files were catalogued and backed up after each simulator run. The files were in a format that could only be read by the simulator, so the data was converted to text format using a decryption program.

The following variables were recorded: simulator time (s), aircraft yaw (deg), aircraft pitch (deg), aircraft roll (deg), altitude (ft), true airspeed (ft/s), G’s, latitude (deg), longitude (deg), pilot head yaw (deg), pilot head pitch (deg), pilot head roll (deg), longitudinal stick input (in), and lateral stick input (in).

## **4. Evaluation of Alert Mode Issues and Information Presentation Issues**

HMD-based GCAS alert information offers two advantages. First, it provides an additional visual alert modality to compliment the audio modality regardless of the pilot's head position. Second, it offers the capability to display state and guidance information apart from the alert information, also regardless of the pilot's head position. Part 1 of the experiment addressed the alert modality issue, while Part 2 addressed the issues associated with providing state and guidance information to the pilot to aid in resolving a GCAS alert.

Though the two parts of the experiment evaluated different issues, the goal of increasing pilot recovery performance was shared. Therefore, the experiment parts were performed in parallel, and results were compared between parts.

### **4.1. Objectives**

Part 1 of the experiment was designed to evaluate the differences in alert modes for an HMD-based GCAS. Part 2 was designed to evaluate the effectiveness of three prototypical symbology sets for use with an HMD-based GCAS alert. The symbology in Part 2 differed in the amount and format of information provided. The following objectives were addressed:

1. Obtain baseline data on GCAS recovery performance with an audio-only alert in a high taskload situation. This baseline is necessary for the evaluation of the effectiveness of advanced HMD-based GCAS displays.
2. Evaluate differences in GCAS recovery performance between an audio-only alert modality and an audio-plus-visual alert modality.
3. Obtain pilot subjective ratings on the effectiveness of an additional visual alert in the immediate field of view.

4. Evaluate differences in GCAS recovery performance among three sets of visual symbology: an aircraft-fixed guidance cue, a head-fixed guidance cue, and a head-fixed guidance cue with additional state information (a pitch ladder). A common audio alert was present in all three alert formats.

5. Evaluate the effectiveness of the three sets of visual guidance symbology with respect to the baseline audio-only alert and the audio-plus-visual alert.

6. Obtain pilot subjective ratings on the effectiveness of different formats of state and guidance information in a GCAS alert.

## **4.2. Experimental Design**

### **4.2.1. Subject Acquisition**

Though this experiment was focused specifically on military fighter aircraft, it was felt that the primary effects would be observed with any pilot with a basic level of flight proficiency. Furthermore, limiting the subject selection to military fighter pilots would severely restrict the availability of subjects. For these reasons, the minimum requirements for a subject were that he or she hold a Private Pilot's license.

Subjects were recruited by two methods: poster advertisements and word of mouth. Data from thirteen subjects was collected for the experiment.

### **4.2.2. Experimental Protocol**

Both parts of the experiment were conducted during the same session for each experimental subject, using the T-38 simulation facility described in Chapter 3. Total session time varied between 2 h 15 min and 3 h. Five separate experimental runs were conducted during the session, each lasting approximately 10 min. The four flight profiles were flown in each run,

resulting in 20 terrain escape scenarios for each subject. Each profile ended in a different attitude condition when the GCAS alert was triggered, as given in Fig. 4.1 (these conditions will be referred to by the convention shown in parentheses). The profile order was counterbalanced to minimize anticipation by the pilot.

Profile #	Pitch	Bank
1 (10-30)	10° Down	30° Left
2 (10-60)	10° Down	60° Right
3 (20-30)	20° Down	30° Right
4 (20-60)	20° Down	60° Left

**Figure 4.1**  
**Profile End Attitude Conditions**

Two GCAS display configurations were tested for Part 1: an audio-only alert (A) and an audio and break-X (visual) alert (X). Three configurations were tested for Part 2: an audio alert with an aircraft-fixed guidance cue (AF), an audio alert with a head-fixed guidance cue (HF), and an audio alert with a head-fixed guidance cue and pitch ladder for state information (HFP). Fig. 4.2 shows the two test matrices (modality comparison and information format comparison). The order in which Parts 1 and 2 of the experiment were performed and the order of displays in each experiment part were counterbalanced to minimize learning trends in the data.

	Profile			
Modality	10-30	10-60	20-30	20-60
A				
X				

	Profile			
Information Format	10-30	10-60	20-30	20-60
AF				
HF				
HFP				

**Figure 4.2**  
**Test Matrices**

An example of a typical subject test matrix is shown in Fig. 4.3.

Part 2 - Information Format				
Display Order	Profile Order			
HF	10-30	20-60	10-60	20-30
AF	10-60	20-60	20-30	10-30
HFP	20-60	10-30	10-60	20-30

Part 1 - Modality				
Display Order	Profile Order			
X	10-30	10-60	20-60	20-30
A	10-60	20-30	10-60	20-60

**Figure 4.3**  
**Example Test Matrix**

In this example, the subject started with the information format part of the experiment. The first experimental run was conducted with the HF display. During the first run, the four profiles were flown in the following order: 10-30, 20-60, 10-60, and 20-30. The subject then performed an experimental run with the AF display and then one with the HFP display. After the

information format part was complete, the subject flew two experimental runs for the modality part (one with the X display and one with the A display).

When subjects arrived for testing, they were shown to the simulator lab and given a brief introduction. They were told that they would be flying a T-38 simulator in a T-38 cockpit with an HMD, they would be performing some tasks during the experiment, and they would be asked some questions during the session. Then, they were given a consent form to read and sign. This form, shown in Appendix B, informed the subjects of risks associated with the experiment and their rights as volunteers. It was approved by the Committee on The Use of Humans as Experimental Subjects.

Subjects were then introduced to the T-38 cockpit and the HMD. They were shown the stick, rudder pedals, and stick buttons. They were told that the throttle, flap lever, and trim stick button were functional but would not be used for this experiment and should not be moved. The operation of the HMD was shown on the projector screen in front of the T-38 cockpit, and the standard symbology of the flight path vector and targeting circle was explained. The subjects were warned about HMD jitter at extreme head angles, that lag that could occur with very rapid head movements, and about the physical constraints of the balancing arm and wire bundle. They were told to immediately report any unanticipated or hindering problems associated with the HMD.

The subjects were told that the autopilot would be flying the aircraft for most of the experiment and that their job was to accomplish an audio and visual task. Each task was explained and an example of how to designate targets was shown on the projector screen by moving the HMD by hand and pressing the targeting button on the stick. Subjects were told that

they would be scored on these tasks and that their score would be maximized by being fast as well as accurate. For the visual task they would receive points for each enemy they correctly targeted. They would be slightly penalized for pressing the button but not hitting any targets and heavily penalized for hitting a friendly target. They were told about the ability to hit multiple targets by placing the targeting circle around several targets. For the audio task they would receive points each time they correctly responded to their callsign, "Falcon 3," within one second. They would be penalized for missing their callsign and for responding to a different callsign. The subjects were instructed to keep the stick in its neutral position while the autopilot had control of the aircraft.

The subjects were told that occasionally the autopilot would bring them on a collision course with the ground, but that a GCAS was installed to warn them of such a situation. The GCAS warning would consist of an audio voice alert, "Pull up! Pull up! . . . Pull up! Pull up!," and in some cases a visual cue that would be explained later. They were told that the GCAS would automatically transfer control of the aircraft back to the pilot when an alert occurred and that their immediate concern was to recover the aircraft from whatever situation it was in. The standard recovery maneuver of rolling the wings approximately level and pulling the nose above the horizon at maximum G's was explained to them. They were told that performing the audio and visual tasks was secondary to recovering from a dangerous situation, as they would lose all their points if they hit the ground. The subjects were instructed to pull the nose up to approximately a 20° climb (flight path vector 20° above the horizon). They were told that they could estimate this by placing the horizon just below the bottom of their field of view when looking directly at the flight path vector. They were instructed to maintain this climb until the

word “RESUME” appeared in their immediate field of view. At this point they should push the nose forwards and establish straight and level flight. They were told that the “RESUME” message would disappear and the targeting circle would reappear when they had leveled the nose. The subjects were instructed to maintain this straight and level attitude until the aircraft felt like it had trimmed out, then they could say out loud, “OK to resume,” or, “ready to resume,” in order to reengage the autopilot. They were told that the experimenter would respond with, “OK resume,” indicating that the autopilot had been activated and that it was safe to return to the scored tasks.

Immediate questions were answered and then the subjects were placed in the cockpit and fitted with the HMD. The subjects were allowed as much time as they felt was necessary to become familiar with the aircraft and use of the HMD. While the aircraft was paused in the air, they were shown the audio “Pull up!” message and allowed to practice the visual targeting task. Then, the aircraft was put in motion and trimmed for straight and level flight at full military power at 3000 ft. Callsign generation, controlled by the simulator, automatically began when the aircraft was unpaused. The subjects were told to become familiar with the aircraft behavior, practice the audio task, and practice recovering from a nose down situation.

When the subjects indicated they were comfortable with the operation of the aircraft and the tasks, they were shown each of the visual GCAS symbologies that would be used for the first part of the experiment. The use of the symbology was explained and the subjects were allowed to practice flying the aircraft with the symbology. The “RESUME” message was also shown and the pilots were reminded of its use.

Finally, before the first experimental run began, the entire experiment was summarized for the subjects and any final questions were answered. Then the subjects were told which GCAS symbology to expect for their first experimental run.

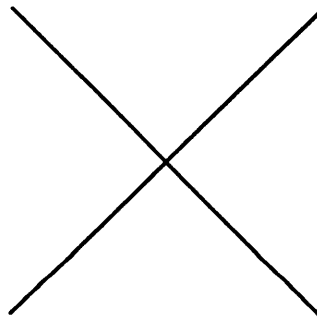
The subjects flew the experimental runs, consisting of the four flight profiles and four manual recoveries. After each run the subjects were asked if there were any problems with the conduct of the run. Any concerns were immediately addressed. Each run was followed by a five minute break where the subjects were allowed to remove the HMD and data from the run was catalogued. After the completion of the first part of the experiment, the subjects were removed from the cockpit and given the corresponding questionnaire. Appendix C shows the questionnaire for Experiment Part 1, and Appendix D shows the questionnaire for Experiment Part 2. After completing the questionnaire, the subjects were asked questions in an interview format, and their responses were recorded by hand. The interview questions for Experiment Part 1 are shown in Appendix E, and the interview questions for Experiment Part 2 are shown in Appendix F.

The second part of the experiment proceeded in the same manner as the first after all interview questions had been answered. At the completion of the second part, the subjects were given the corresponding questionnaire and asked the corresponding interview questions. The subjects were then asked to fill out a final questionnaire concerning overall issues with the experiment and a background information sheet. These are shown in Appendix G. Finally, the subjects were asked interview questions about close ground encounters in their real world flying experiences. These questions are shown in Appendix H.

### 4.2.3. Display Configurations

The first alert format included the audio “Pull up!” warning described in Chapter 3, but no visual indication. The targeting circle for the visual task remained visible during the alert and recovery, unlike when visual symbology was used. The audio-only alert case is referred to as “A” in all results and figures.

The second alert format included the audio “Pull up!” warning and a break-X displayed in the center of the pilot’s field of view. The break-X, shown in Fig. 4.4, consisted of two intersecting lines, each 283 mrad long. The entire X occupied an area 200 mrad x 200 mrad. The break-X remained visible until it was replaced by the “RESUME” message when the safe altitude had been reached. The audio plus break-X alert case is referred to as “X” in all results and figures.

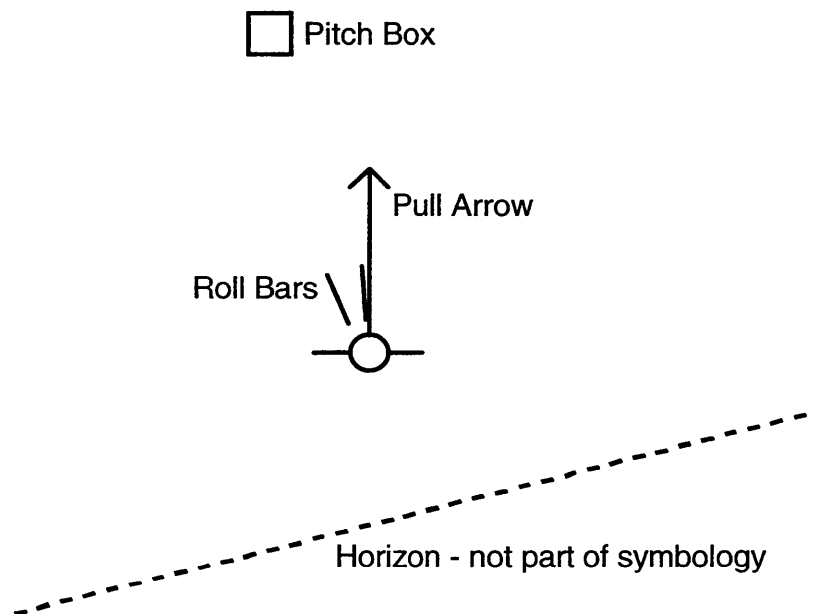


**Figure 4.4**  
**Break-X**

In both test cases, the only information given to the pilot was that a dangerous situation had been reached. The difference between the cases was the method used to transmit this information to the pilot.

For Part 2 of the experiment, three GCAS alert formats were tested. The symbologies shown below only appeared when an alert was given, as in the break-X case.

The first alert format included the audio “Pull up!” warning described in Chapter 3, as well as an aircraft-fixed set of guidance symbology, designed by the author. The symbology, shown in Fig. 4.5, was integrated with the aircraft-fixed flight path vector described in Chapter 3. It consisted of three parts. First, an arrow, referred to as the “pull arrow,” extended from the vertical tail of the flight path vector. The arrow was 80 mrad in length (tip positioned 100 mrad above the center of the flight path vector circle), and had two 14 mrad lines at 45° angles from the tip (forming the pointer). Because the pull arrow was affixed to the flight path vector, it would always indicate the direction of nose travel when the stick was pulled back.



**Figure 4.5**  
**Alert Guidance Symbology (aircraft shown pitched up and rolled right)**

The second part of the symbology were the “roll bars.” Two 30 mrad long bars extended from the center of the flight path vector circle at a distance of 20 mrad (each bar was drawn from 20-50 mrad from the center of the circle). The bars remained fixed with respect to the horizon at angles of  $\pm 10^\circ$  from vertical. As the aircraft rolled, the bars would remain fixed relative to the

horizon, but would move with the flight path vector and pull arrow when the aircraft was pitched or yawed. These bars functioned as a roll guidance command. If the aircraft was rolled until the pull arrow was positioned inside the two roll bars, the aircraft would be within 10° of wings level.

The third part of the symbology was the “pitch box.” A 22 x 22 mrad hollow box was positioned 20° above the horizon. The box would remain fixed relative to the horizon as the aircraft rolled or pitched, but would move with the other symbology as the aircraft yawed. The box functioned as a pitch guidance command. If the aircraft was pitched until the flight path vector fell inside the pitch box, the aircraft would be climbing at a 20° flight path.

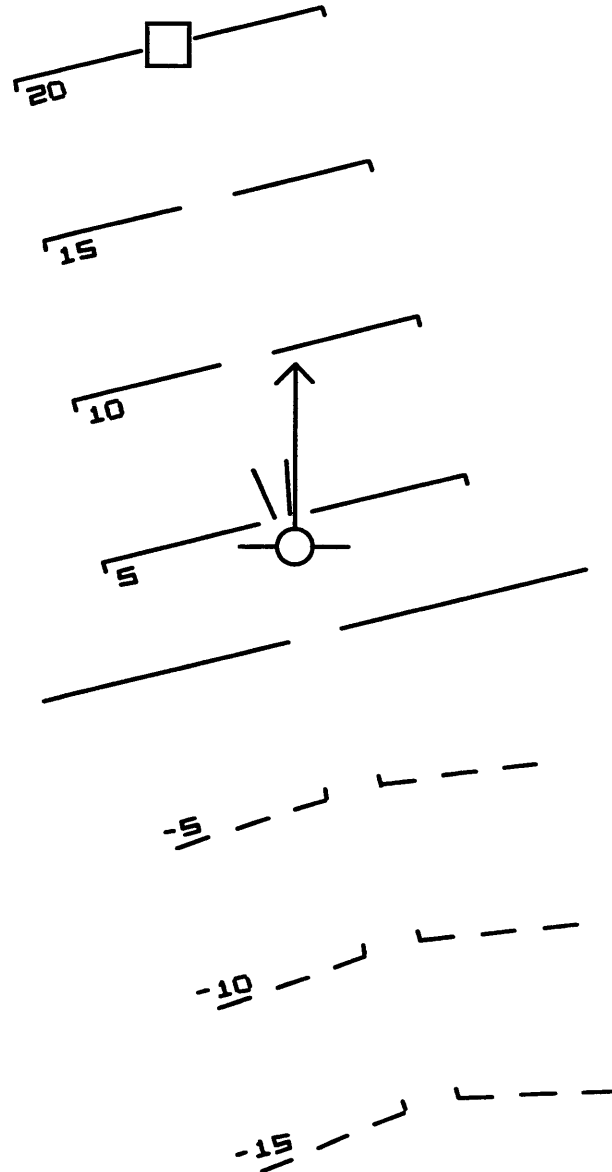
This set of symbology was drawn in the aircraft-fixed reference frame, and could only be seen if the pilot were looking towards the nose of the aircraft. However, when an alert occurred, the targeting circle used for the visual task was removed, providing an immediate implicit visual cue. The aircraft-fixed guidance cue remained visible until it was replaced by the “RESUME” message when the safe altitude had been reached. The audio plus aircraft-fixed guidance alert case is referred to as “AF” in all results and figures.

The second alert format included the audio “Pull up!” warning and a head-fixed set of guidance symbology. The symbology was identical to the aircraft-fixed symbology set (shown in Fig. 4.5) except for its placement. The flight path vector, pull arrow, roll bars, and pitch box were all drawn in the head-fixed reference frame and remained centered in the pilot’s field of view. However, the guidance symbology operated with respect to the aircraft body, regardless of the pilot’s head position. Therefore, a mismatch between the symbology and the outside view would occur unless the pilot’s head was centered. For example, if the pilot was looking directly out the right side of the aircraft and commanded a roll to the right, the symbology would show the

roll marks and pitch box (if visible) rotating to the left, but the horizon the pilot sees would be rising. Also, the aircraft-fixed flight path vector was not removed when this symbology was present. So, if a pilot was looking towards the nose of the aircraft, two flight path vectors were visible: one which moved with the aircraft and one with attached symbology which moved with the pilot's head.

The head-fixed symbology was designed to allow the pilot to perform a recovery maneuver regardless of the pilot's head position by providing guidance with respect to the aircraft's nose. The targeting circle for the visual task was removed when this symbology was shown. The head-fixed guidance cue remained visible until it was replaced by the "RESUME" message when the safe altitude had been reached. The audio plus head-fixed guidance alert case is referred to as "HF" in all results and figures.

The third alert format included the audio "Pull up!" warning, a head-fixed set of guidance symbology, and a head-fixed set of state symbology. The symbology, shown in Fig. 4.6, was identical to the head-fixed guidance cue except for the addition of a pitch ladder. The pitch ladder, like the flight path vector, pull arrow, roll marks, and pitch box, was drawn in the head-fixed reference frame, but operated with respect to the aircraft body. The pitch ladder behaved in the same manner as the pitch box. As in the head-fixed guidance cue, the aircraft-fixed flight path vector remained visible while the head-fixed guidance cue and pitch ladder were displayed.



**Figure 4.6**  
**Head-Fixed Alert Guidance Symbology With Pitch Ladder**

The pitch ladder consisted of a horizon line, positive and negative pitch bars, and numbers indicating the degrees of pitch. Each pitch bar consisted of two lines drawn to the right and left of center. The horizon bar's lines were each 135 mrad long, each starting 15 mrad from centerline. The positive pitch bars were drawn every 5° until 30° of pitch where they were drawn every 10°. The bars varied in length, becoming shorter at higher pitch angles. The two lines for

each positive pitch bar varied from 85 mrad to 35 mrad in length (decreasing linearly by 5 mrad), each starting 15 mrad from centerline. At the outside of either line, a 5 mrad vertical line was drawn extending towards the horizon. Pitch numbers were drawn at the left side of each bar, below the line. The negative pitch bars were drawn every 5° until -30° of pitch where they were drawn every 10°. The bars each consisted of two dashed lines, 85 mrad in length starting 15 mrad from centerline. Each line had three segments 17 mrad in length separated by 17 mrad spaces. The negative pitch bars were angled down away from the centerline (angles increasing with negative pitch) as shown in Fig. 4.6. The chevrons formed by the bars pointed towards the horizon, becoming more exaggerated at steeper pitch angles. At the inside edge of each line, a 5 mrad vertical line was drawn extending towards the horizon. Pitch numbers were drawn at the left side of the bar, above the line.

This symbology was designed to allow the pilot to perform a recovery maneuver regardless of the pilot's head position by providing guidance information through a "view" of the aircraft's nose. The addition of state information was designed to give the pilot an immediate and compelling view of the aircraft attitude not available through the guidance cue, to emphasize the severity of the situation and the appropriate recovery indicated by the guidance cue. The state information was also designed to aid the pilot in overcoming the mismatch between head-fixed guidance symbology and the outside world view. The head-fixed guidance cue and pitch ladder remained visible until it was replaced by the "RESUME" message when the safe altitude had been reached. The audio plus head-fixed guidance and pitch ladder alert case is referred to as "HFP" in all results and figures.

### 4.3. Experimental Results

Data were collected from thirteen subjects in this experiment. Subjects ranged in age from 20 to 63, averaging 39. Subjects ranged in powered flight experience from 77 to 3000 hrs, averaging 675 hrs. Subjects also varied in pilot ratings. Each possessed the minimum Private Pilot License requirement. Four subjects had civilian instrument ratings. Six subjects had military flying experience, three of which had jet experience.

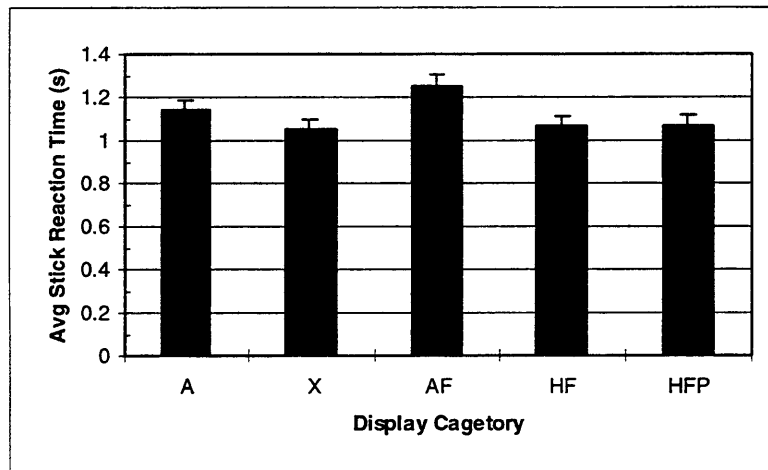
Data were lost from one profile in one experimental run of one subject due to an experimenter error during testing. Variations in profile initial conditions caused profile end conditions to differ slightly from the desired end conditions. Data were eliminated from four profiles due to this difference exceeding 10%. One assumption of the experiment was that subjects would be visually distracted from observing the aircraft attitude and altitude when an alert was given. It was felt that if the nose of the aircraft was in the subject's field of view, the subject would have better access to aircraft state information. Therefore, the data were screened for instances of low head yaw and pitch angles at the time of an alert. Cases where the subject's head yaw angle was within  $30^\circ$  of center and head pitch angle was within  $25^\circ$  of center (the aircraft nose was in view) were not used. In all, data from 26 of 260 profiles (10%) were not used.

Full sets of experimental results from all profiles and displays are given in Appendix I. Though flight profile end conditions included positive and negative bank angles, these have been normalized to positive angles for the purpose of comparison. Time = 0 on all history plots is the time the alert was given.

### 4.3.1. Reaction Times

Two reaction times were measured: stick reaction time and head reaction time. Stick reaction time was defined as the time from the alert until the pilot moved the stick away from the neutral position. Head reaction time was defined as the time from the alert until the pilot moved his or her head to be within the head yaw and pitch limits necessary to view the nose of the aircraft ( $\pm 30^\circ$  yaw,  $\pm 25^\circ$  pitch). Stick and head reaction times were not affected by profile end conditions.

Average stick reaction time for each display configuration is shown in Fig. 4.7.

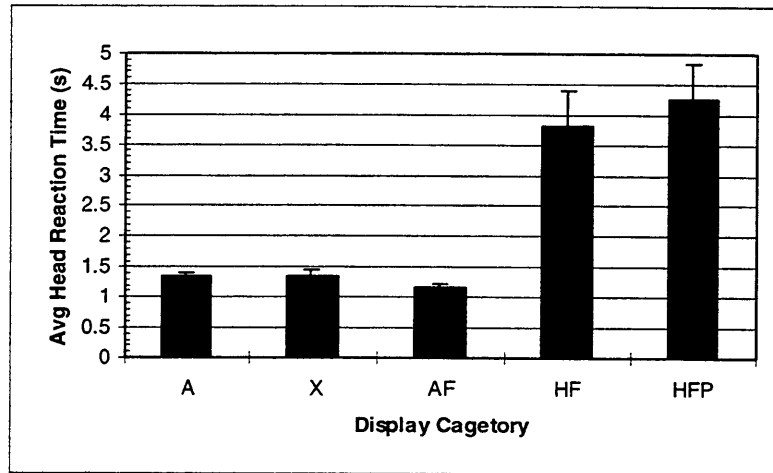


**Figure 4.7**  
**Average Stick Reaction Time (Error bars: 1  $\sigma$  of estimate of mean)**

Average stick reaction time was slightly faster (approximately 0.08 s faster) for the HF and HFP displays than the baseline A display case. A slightly slower average stick reaction time (approximately 0.1 s slower) was seen for the AF display. No significant statistical differences ( $p < 0.05$  using paired t-test for means) in stick reaction time were observed between the A display case and the other display configurations. However, significant differences were observed

between the AF and X displays ( $p < 0.01$ ), the AF and HF displays ( $p < 0.01$ ), and the AF and HFP displays ( $p < 0.01$ ).

Average head reaction time for each display configuration is shown in Fig. 4.8.



**Figure 4.8**  
**Average Head Reaction Time (Error bars:  $1 \sigma$  of estimate of mean)**

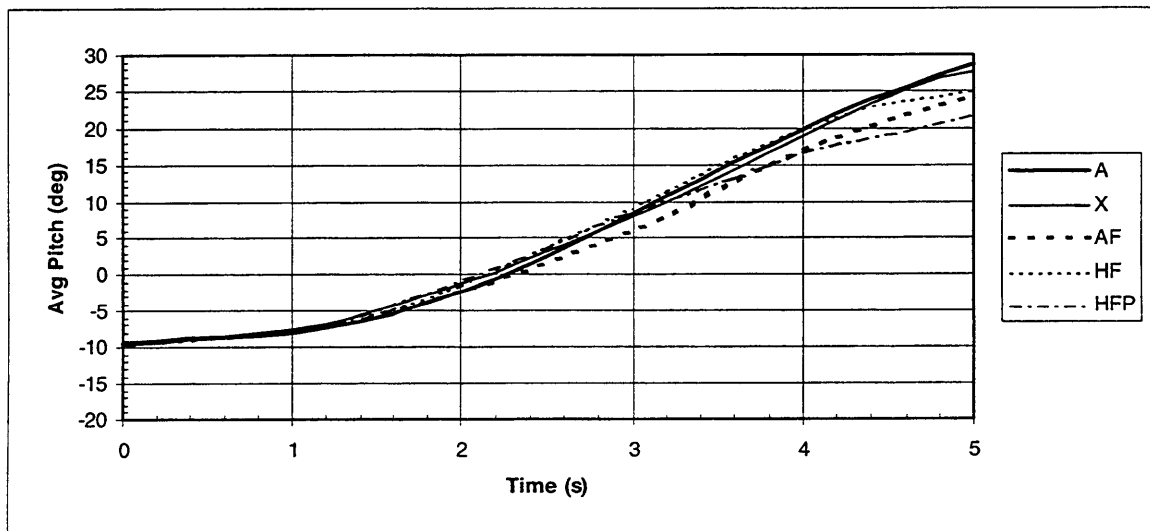
Average head reaction times for the A and X display cases were approximately equal. The AF display showed a slightly faster average head reaction time (approximately 0.2 s faster) than the A display. Average head reaction times for both the HF and HFP displays were much larger than the A display case (on the order of several seconds slower). In other words, pilots tended to move their heads to the front more quickly with the AF display and keep their heads off-axis significantly longer with the HF and HFP displays. Statistically comparing the A display case with the other display configurations, significant differences in head reaction time were observed between the A and AF displays ( $p < 0.01$ ), the A and HF displays ( $p < 0.01$ ), and the A and HFP displays ( $p < 0.01$ ). No significant difference was observed between the A and X display cases. Also, no significant difference was observed between the HF and HFP display cases.

### 4.3.2. Recovery Performance

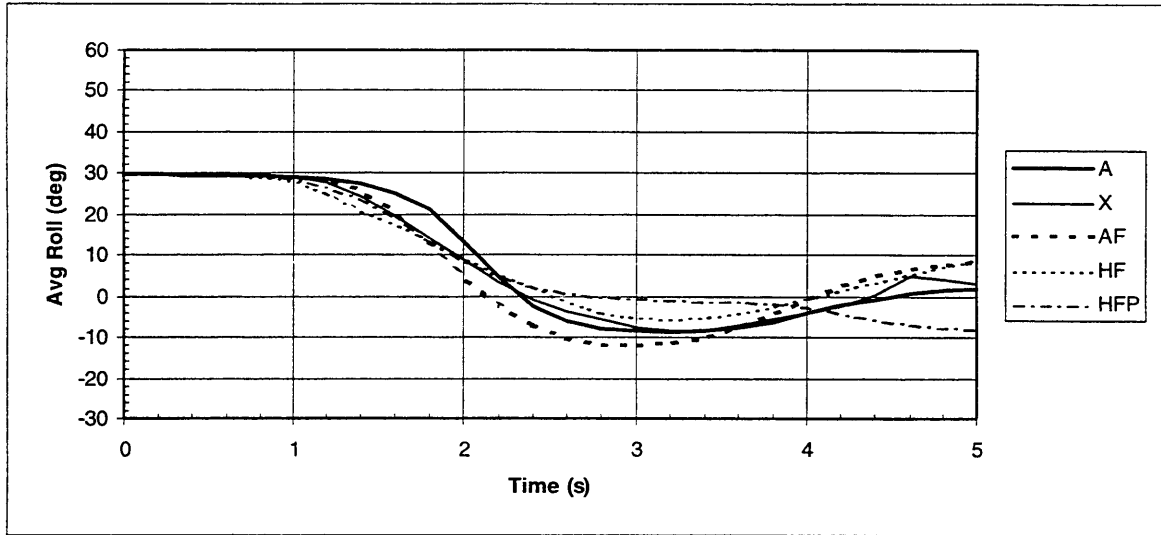
Several metrics were used to compare the characteristics and performance of pilot recoveries: altitude loss, pitch response time, roll response time, total response time, and roll overshoot. Altitude loss was defined as the difference between the altitude at the time the alert was given and the minimum altitude reached during the recovery. Pitch and roll response times were defined as the time from the alert until the aircraft passed through a pitch attitude of  $0^\circ$ , or until the aircraft was rolled within  $15^\circ$  of level attitude, respectively. The total response time was the time from the alert until a pitch attitude  $> 10^\circ$  and a roll attitude between  $\pm 15^\circ$  was reached. This was deemed a safe recovery attitude (level climbing). Finally, roll overshoot was defined as the magnitude of the peak of the initial roll overshoot from  $0^\circ$ .

Average pitch and roll response history comparisons for the 10-30 case are shown in Figs.

4.9 - 4.10.



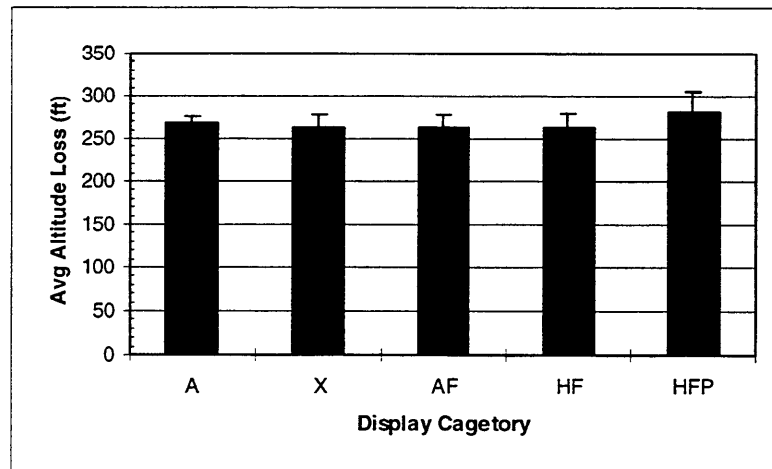
**Figure 4.9**  
**Average Pitch History Comparison (10-30)**



**Figure 4.10**  
**Average Roll History Comparison (10-30)**

These graphs and the graphs for the other conditions (shown in Appendix I) indicate similar responses for each display category. They show no apparent trends among displays in the slight variations of response seen.

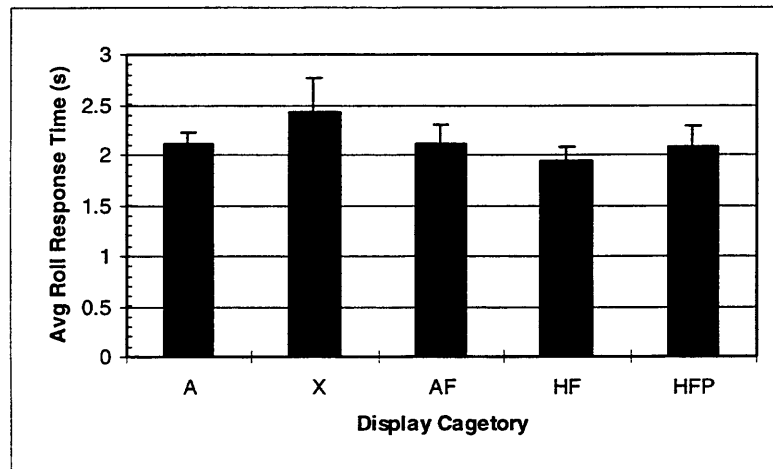
Figure 4.11 shows the average altitude loss for each display configuration at the 10-30 condition.



**Figure 4.11**  
**Average Altitude Loss (10-30) (Error bars: 1  $\sigma$  of estimate of mean)**

This graph and the graphs for the other conditions (shown in Appendix I) show similar altitude losses for all displays at each condition. Comparing altitude loss between the A display and all other display configurations, significant differences were found only in two cases: A > X at 20-60 ( $p < 0.05$ ), and A > HFP at 10-60 ( $p < 0.05$ ). No trends in differences between displays were observed across the four conditions.

Figure 4.12 shows the average roll response time for each display configuration at the 10-30 condition.



**Figure 4.12**  
**Average Roll Response Time (10-30) (Error bars: 1  $\sigma$  of estimate of mean)**

This graph and the graphs for the other conditions (shown in Appendix I) show similar average roll response times for all displays at each condition. Comparing roll response times between the A display and all other display configurations, significant differences were found only in two cases: A > HF at 20-30 ( $p < 0.01$ ), and A > HFP at 10-60 ( $p < 0.05$ ). No trends in differences between displays were observed across the four conditions.

Like the average roll response time results, the graphs of average pitch response times (shown in Appendix I) show similar values for all displays at each condition. Comparing pitch

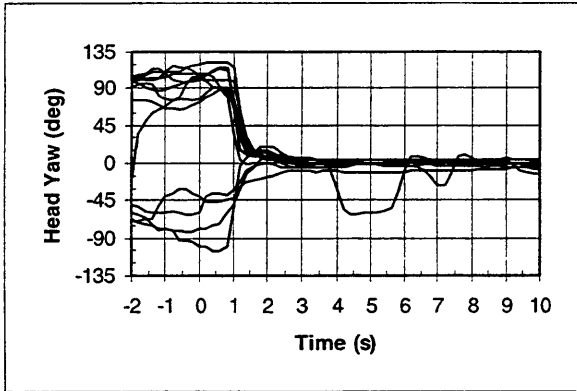
response times between the A display and all other display configurations, significant differences were found only in three cases:  $A > X$  at 20-60 ( $p < 0.05$ ),  $A > AF$  at 10-60 ( $p < 0.01$ ), and  $A > HFP$  at 10-60 ( $p < 0.01$ ). No trends in differences between displays were observed across the four conditions.

Similarly, the graphs of average total response times (shown in Appendix I) show similar values for all displays at each condition. Comparing total response times between the A display and all other display configurations, a significant difference was found in only one case:  $A < AF$  at 20-30 ( $p < 0.05$ ). No trends in differences between displays were observed across the four conditions.

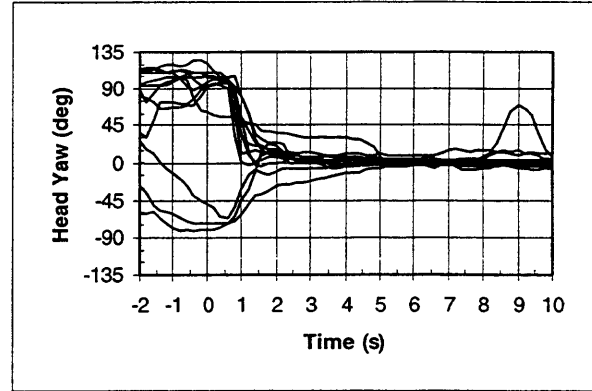
The graphs of average roll overshoots (shown in Appendix I) show large variations among display categories and among conditions. However, high standard deviation values can also be seen. Comparing roll overshoots between the A display and all other display configurations, no significant differences were found. No trends in differences between displays were observed across the four conditions.

### **4.3.3. Pilot Head Motion**

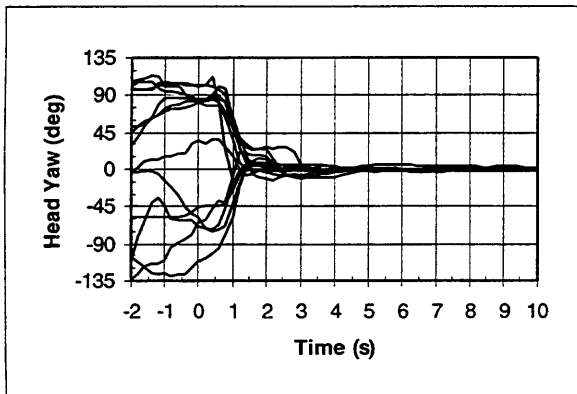
Figs. 4.13 - 4.17 show head yaw histories for each case at the 10-30 condition.



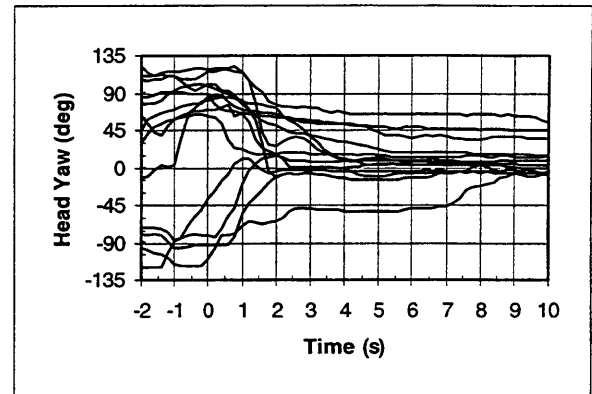
**Figure 4.13**  
**Head Yaw Histories (A - 10-30)**



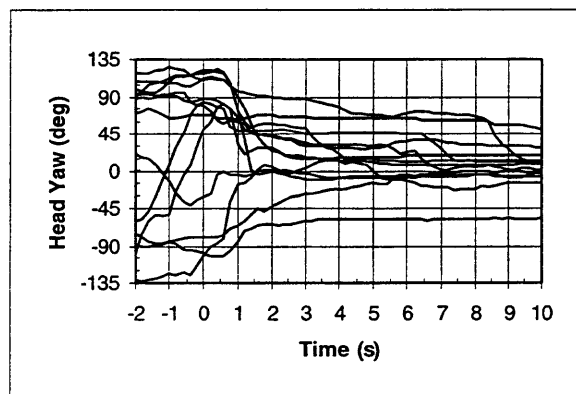
**Figure 4.14**  
**Head Yaw Histories (X - 10-30)**



**Figure 4.15**  
**Head Yaw Histories (AF - 10-30)**



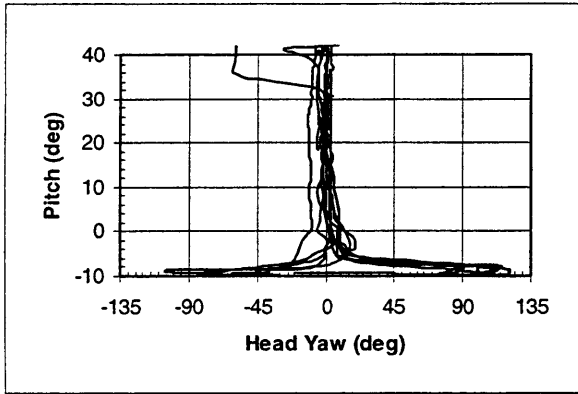
**Figure 4.16**  
**Head Yaw Histories (HF - 10-30)**



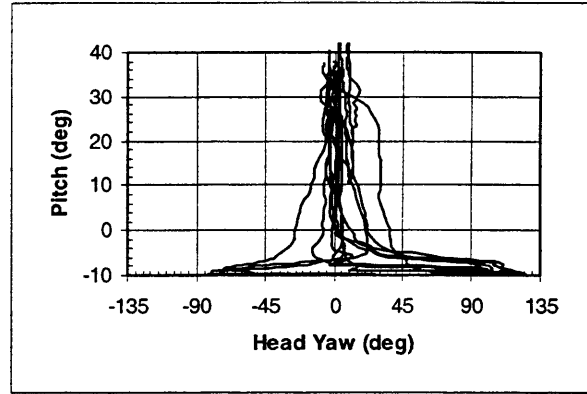
**Figure 4.17**  
**Head Yaw Histories (HFP - 10-30)**

These graphs and the graphs for the other conditions (shown in Appendix I) show significant differences in pilot head behavior among display configurations. In the A, X, and AF display cases, pilots centered their heads within the first couple seconds following the alert. The AF display graph shows a tighter grouping of head yaw angles after the initial centering than the A and X display graphs. In the HF and HFP display cases, head behavior is much more varied. Some pilots centered their heads within the first couple seconds. Others' heads remained fixed in the position seen before the alert. Most showed a trend towards the center, but significantly more slowly than the first three display categories.

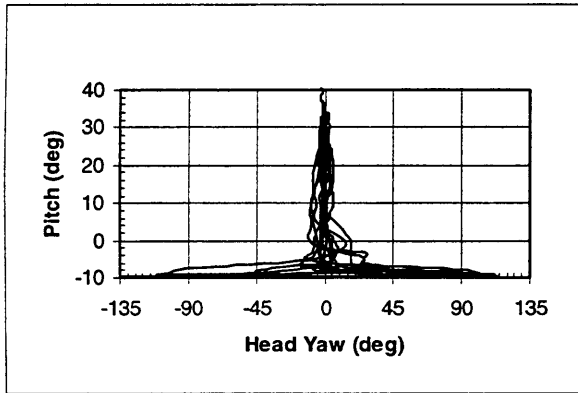
Plots of pilot head motion relative to aircraft head motion are useful in characterizing the effect of display symbology on pilot head behavior. Also, the relationship between aircraft motion and pilot head motion has important consequences for the pilot's vestibular system. Figs. 4.18 - 4.22 show head yaw vs. aircraft pitch for each case at the 10-30 condition.



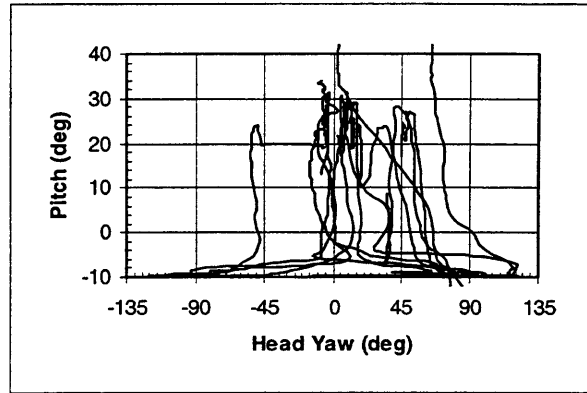
**Figure 4.18**  
**Aircraft Pitch vs. Head Yaw (A - 10-30)**



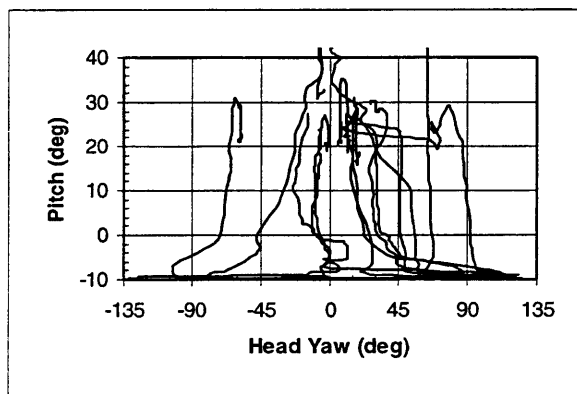
**Figure 4.19**  
**Aircraft Pitch vs. Head Yaw (X - 10-30)**



**Figure 4.20**  
**Aircraft Pitch vs. Head Yaw (AF - 10-30)**



**Figure 4.21**  
**Aircraft Pitch vs. Head Yaw (HF - 10-30)**



**Figure 4.22**  
**Aircraft Pitch vs. Head Yaw (HFP - 10-30)**

These graphs and the graphs for the other conditions (shown in Appendix I) also show significant differences in pilot head behavior among display configurations. In the A, X, and AF display cases, pilots centered their heads before or at the beginning of the pitch recovery. The AF display graph shows a tighter grouping of head yaw angles after the initial centering than the A and X display graphs. In the HF and HFP display cases, some pilots centered their heads at the beginning of the pitch recovery. Others' heads remained fixed in the position seen before the alert as the aircraft made significant pitch changes. Most showed a trend towards the center, but significantly more slowly than the first three display categories.

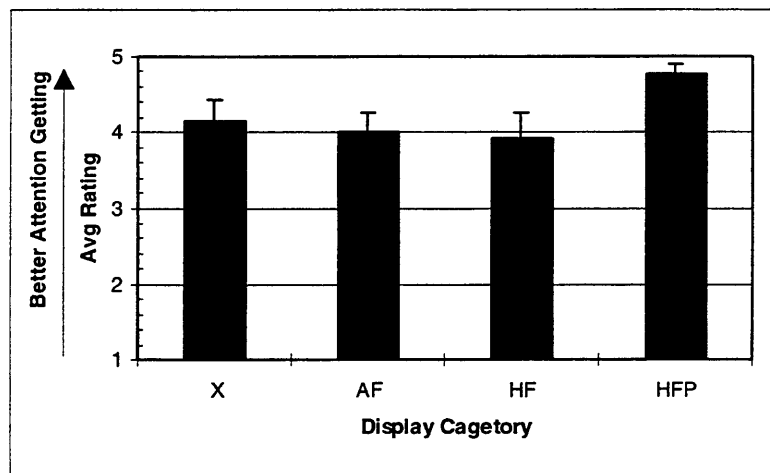
Graphs of aircraft roll vs. head yaw are shown in Appendix I. These graphs demonstrate the same trends in head motion with respect to the recovery as seen above. In the A, X, and AF display cases, pilots centered their head before significant aircraft roll changes were made. In the HF and HFP display cases, pilots' heads were often off-axis as the aircraft made significant roll changes.

#### **4.3.2. Subjective Ratings**

Subjects were asked to rate the effectiveness of each alert in getting their attention, and the effectiveness of each alert in conveying a sense of urgency on a scale of 1-5 (5 being best attention-getting or most urgent). For the three symbology cases where additional information was presented, the subjects were asked to rate the understandability and usefulness of the information given on a scale from 1-5 (5 being easiest to understand or most useful). Finally, subjects were asked to compare the dominance of one alert over another for each possible pair of alert types. Nine responses were possible for each comparison (weak, strong, very strong, and

absolute dominance choices for each symbology, and an equal dominance choice). The questionnaires are listed in Appendix B and Appendix C.

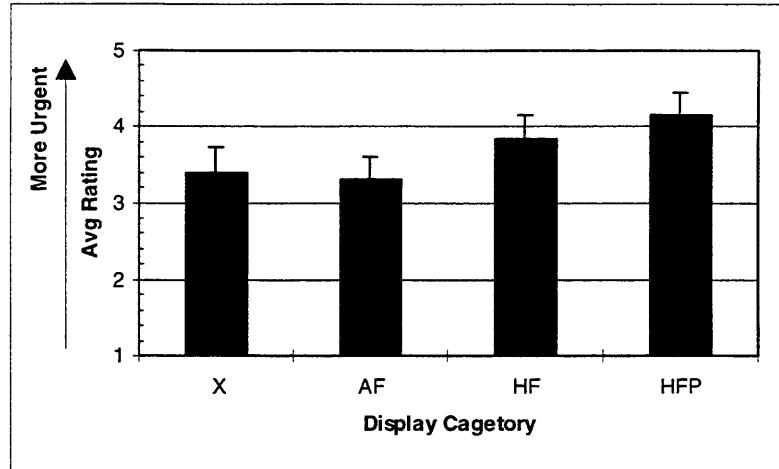
Figure 4.23 shows the average attention-getting rating for each display configuration. Possible confusion by subjects in the rating of the A display due to audio and visual differentiation decreased the experimenter's confidence in the results for the A case. Therefore, the A display category is not shown in Figures 4.23 or 4.24.



**Figure 4.23**  
**Average Ratings of Attention-Getting (Error bars: 1  $\sigma$  of estimate of mean)**

The HFP display was rated the highest. HFP was rated significantly higher than the X display ( $p < 0.05$ ), the AF display ( $p < 0.01$ ), and the HF display ( $p < 0.01$ ). Though not shown, A was rated slightly lower than the HFP display.

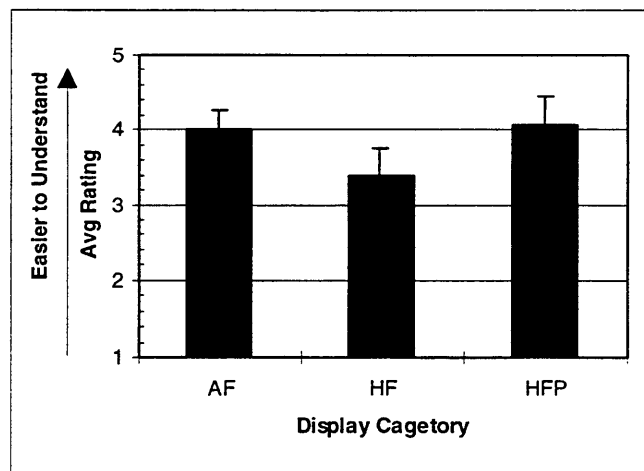
Figure 4.24 shows the average urgency rating for each display configuration.



**Figure 4.24**  
**Average Ratings of Urgency (Error bars: 1  $\sigma$  of estimate of mean)**

The HFP display was rated the highest of all the visual display categories. HFP was rated significantly higher than the X display ( $p < 0.05$ ) and the AF display ( $p < 0.01$ ). The HF display, third highest, was rated significantly higher than the AF display ( $p < 0.01$ ). Though not shown, the A display was rated slightly higher than the HFP display

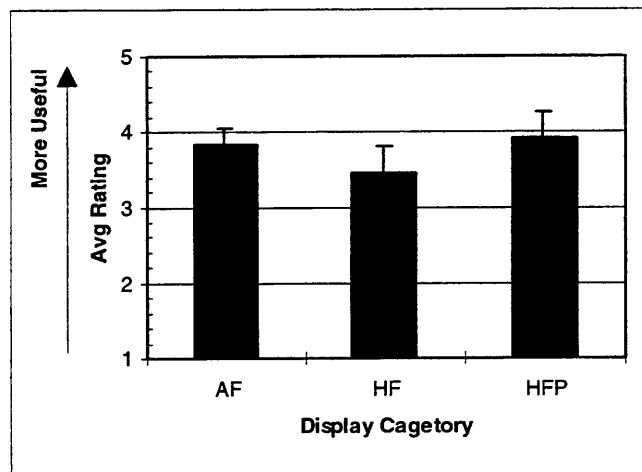
Figure 4.25 shows the average information understandability rating for the AF, HF, and HFP display configurations (the A and X displays were not rated).



**Figure 4.25**  
**Average Ratings of Information Understandability (Error bars: 1  $\sigma$  of estimate of mean)**

The HFP display was rated the highest. However, no significant differences were found between the HFP display rating and the other two display ratings. The HF display was rated slightly lower than the HFP display. HF was rated significantly higher than the AF display ( $p < 0.05$ ).

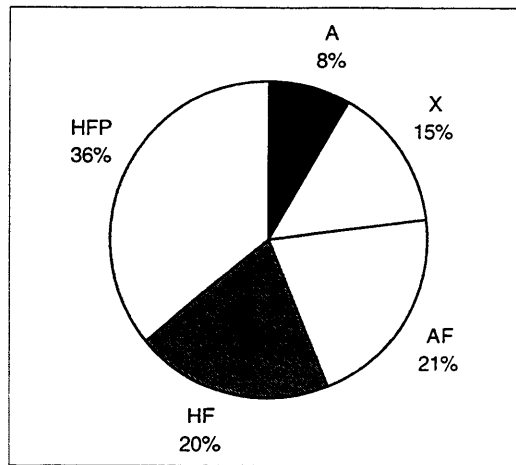
Figure 4.26 shows the average information usefulness rating for the AF, HF, and HFP display configurations (the A and X displays were not rated).



**Figure 4.26**  
**Average Ratings of Information Usefulness (Error bars: 1  $\sigma$  of estimate of mean)**

The HFP display was rated the highest. However, no significant differences were found among display configurations.

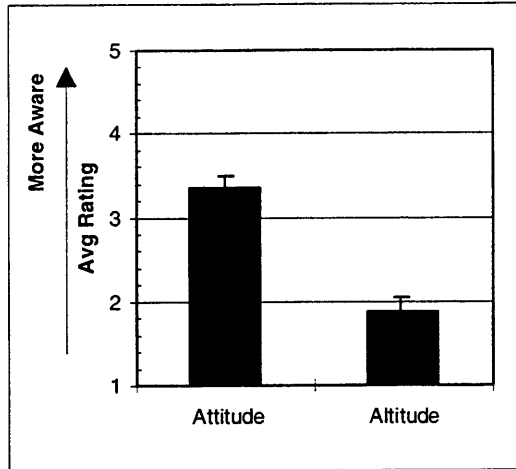
The subjective dominance comparison ratings were used with the Analytical Hierarchy Process method to obtain overall display preferences for each subject in terms of percentages [21]. Fig. 4.27 shows the resultant display preference for the group of subjects.



**Figure 4.27**  
**Overall Display Preference**

The HFP display was preferred the most overall, followed by the AF and HF displays at nearly equal preferences, and then the X display and the A display. However, subjects largely differed in their individual preferences. Some subjects favored a particular display much more than the other displays. Other subjects tended to prefer particular categories of displays, such as head-fixed information (X, HF, and HFP), or guidance information (AF, HF, and HFP).

Subjects were also asked to rate their overall attitude and altitude awareness through the testing (before the alerts) at the end of each experiment part on a scale from 1-5 (5 being most aware). Fig. 4.28 shows the total average ratings of attitude and altitude. Though each category was rated twice by each subject, no major variations were found between ratings.



**Figure 4.28**

**Average Attitude and Altitude Awareness Ratings (Error bars:  $1 \sigma$  of estimate of mean)**

This graph shows a moderate average rating of attitude awareness and a very low average rating of altitude awareness.

#### **4.3.3. Subject Comments**

Subject comments were consistent with the variability in display preferences. Regarding the modality issue, those that favored the audio plus break-X (X) case said that the additional cue was useful in reinforcing the audio alert. One subject said that the break-X was easier to discern from the visual background than the audio alert was from the audio background. Many commented that the X did not add any information, but was good to have as an additional reference. One subject who liked the break-X commented that it would have been better if it had not been persistent. Also, two subjects indicated that they would definitely not like to have the break-X without the audio cue. Those that favored the audio-only alert thought the break-X was distracting or cluttered the display, and that it added no information. One said that the audio alert was much more urgent than the break-X.

Subject comments varied regarding the information presentation issue. Those subjects that preferred the aircraft-fixed symbology said that it was less confusing than the head-fixed symbology. One subject found the presence of two flight path vectors when looking forward with the head-fixed symbology disturbing. The subject had an impulse to line them up, but did not know how. Another subject did not know where the pilot's head should go when using the head-fixed symbology.

Those that preferred the head-fixed symbology liked its immediate information presentation. Many that found it initially confusing commented that they were able to adapt to the head-fixed presentation mode over time, and were able to block out the disparities between the symbology and the outside world. One subject said there was still an impulse to move the head forward. Others indicated that they became fixated on the symbology and flew recoveries with their heads away from the front of the aircraft. A few subjects indicated that they did not prefer the addition of the pitch ladder. They commented that it did not add any useful information, but did clutter the display. Many responded positively to the pitch ladder, saying it added an immediate and compelling sense of the aircraft's attitude. One subject said it aided in minimizing the tendency to overshoot the aircraft's roll. Others commented favorably on the clear pitch information provided by the ladder. One subject with HUD experience liked the pitch ladder because of familiarity with using it in a HUD.

Two subjects indicated that they did not prefer the addition of guidance and state information. One subject said it seemed to increase the pilot's gain and workload during the recovery because of a panic effect; the subject wanted to turn the symbology off. Another commented that the information was used only for fine tuning the end of the recovery, but the

outside horizon was used during the majority of the recovery. Other subjects responded favorably to the additional information. One indicated that additional information was always useful. Another felt that the guidance and state information added confidence to the recovery.

#### **4.4. Discussion**

The three display categories with head-fixed visual symbology (X, HF, and HFP) showed lower stick reaction times than the audio-only and the audio and aircraft-fixed guidance displays. However, the differences seen in reaction times between the X, HF, and HFP displays and the A display were not significant. Stick reaction time differences were of a small order of magnitude (approximately 0.1 s). Most subjects preferred the addition of the visual alert cue; however, some found the break-X distracting and felt it added no information to the audio alert.

There appears to be no significant differences in GCAS recovery performance among the various display configurations tested. The pitch and roll histories are nearly identical for each display configuration at each profile condition. Furthermore, only a few differences were seen in the recovery performance and characteristic metrics used. Those few significant differences found did not span the range of conditions. Differences were of a small order of magnitude (response time differences generally less than 0.5 s).

The major differences found in this experiment involve the pilot's head behavior with respect to the different display categories. Subjects' head behavior seems to indicate a tendency to fixate on guidance and state symbology. The slightly faster head reaction time of the AF display case indicates that pilots look immediately at the symbology during an alert, and keep looking at the symbology during the recovery. Graphs of the head yaw show the most centered and stable behavior for the AF display. The large and highly variable head reaction times seen in

the HF and HFP display cases indicate that pilots were able to perform the GCAS recovery without having to look forwards. The head yaw graphs of these cases show many instances where the pilot's head remains off-center during a large part of the recovery. Pilot comments also support this conclusion. The break-X visual symbology does not seem to affect pilot head movement during the recovery.

Subjects seemed to prefer the head-fixed guidance symbology and pitch ladder overall. Aside from the A ratings, the HFP case was rated highest in attention-getting, urgency, information understandability, and information usefulness. Furthermore, the HFP case received the highest dominance rating. Subjects commented that the combination of guidance and state information was desirable, and that this combination helped overcome the confusing nature of the head-fixed symbology.

The results of the experiment brought up many issues about the design of the experiment and the possible implications of the data. The lack of significant recovery variation among display configurations may be due to experimental inadequacies. Though side tasks were used to distract the subjects, the horizon was never hidden from sight. The nose of the aircraft often passed through subjects' fields of view when switching from side to side on the visual targeting task. Subjects also rated their attitude awareness high compared to altitude awareness. Average stick reaction time was slightly faster than average head reaction time in all cases except for the AF display case. This seems to indicate that pilots can begin their recovery maneuver with attitude information seen from the side or from a mental estimate of the aircraft attitude based on prior observations.

One way to address the problem of subject attitude awareness is to take away all attitude and altitude information by putting the aircraft in the clouds. This was debated for this experiment, but rejected for several reasons. One of the experimental objectives was to examine the difference between the audio-only and audio-plus-visual alert modalities. Restoring attitude and altitude information to the pilot at the time of an alert implies a visual alert reference, so it would be impossible to test an audio-only alert. Furthermore, such a situation is unrealistic. Pilots always receive attitude and altitude information, from the instruments if the outside world is not visible. Also, flying with zero visibility does not correspond the low-level, high task and work load situation studied by this experiment.

Another way to decrease subject attitude awareness is to modify the side tasks. Targets could be placed only on one side of the aircraft, so the pilot does not move his or her head from one side to the other (resulting in a view of the nose). The audio task could require more complex mental processing. For example, the subject could be asked to respond to mental arithmetic problems given over the radio.

The data regarding recovery performance and pilot head-motion seem to suggest that pilots are able to perform the same recovery maneuver with head-fixed guidance and state information despite the fact that the head-fixed symbology violates the principle of compatible motion (the display should conform to the motion of the aircraft as seen by the pilot). Many subjects indicated that they found this disparity confusing, but that they were able to quickly adapt to the display method. Though the pilots did not perform the targeting task while flying the aircraft recovery, this finding suggests that it may be possible for a pilot to perform an off-axis visual task while precisely guiding the aircraft. However, the potential for confusion persists and

more research must be performed into various methods for displaying head-fixed guidance and state information.

Another important issue involving pilot head motion is the effect on the pilot's vestibular system. This experiment did not reproduce any vestibular cues that would be felt by a pilot flying an actual aircraft. A GCAS alert and recovery can involve high head and aircraft angular rates. In this experiment, high degrees of head motion were seen due to the pilot's response to the alert. High aircraft roll and pitch rates were seen during the recovery maneuver. Differences in head motion relative to aircraft motion due to the different display configurations can lead to differences in pilot vestibular cues. Of particular importance is the Coriolis or cross-coupling effect. Pilots can feel a disturbing false vestibular cue when a sudden head motion is made orthogonal to a high angular body (or aircraft) rate [22]. For example, the pilot yaws his or her head while the aircraft is rolling. These vestibular effects must be studied in more detail.

Overall, pilots rated the audio-only display highest in urgency and second highest in attention-getting. This seems confusing considering the fact that all other display formats included the audio alert. Some pilots indicated that the visual alerts were distracting. This may have detracted from the overall sensation of alert and resulted in higher audio-only display ratings in attention-getting and urgency. Another possible explanation is that subjects were confused about answering the questionnaire. Some subjects may have assumed that the rating only applied to the visual portion of the display for the other configurations. This question was asked by and clarified to several subjects, indicating that the questionnaire may have been flawed in this respect.

## 6. Conclusions

In summary, the major conclusions of this thesis are the following:

1. Pilots given GCAS head-fixed visual alert symbology in addition to a GCAS audio alert exhibited a lower stick reaction time than those given aircraft-fixed alert symbology or only an audio alert. However, the reaction time difference was not statistically significant in comparison to the audio-only alert case.
2. Pilots are able to perform GCAS recoveries at the same level of proficiency (measured by altitude loss and response times) using the five alert formats tested in this experiment: audio-only, audio and head-fixed visual alert symbology, audio and aircraft-fixed guidance symbology, audio and head-fixed guidance symbology, and audio and head-fixed guidance symbology with a pitch ladder.
3. Pilots tended to fixate on guidance and state information symbology when it was given. When given aircraft-fixed symbology at the time of an alert, pilots' heads turned immediately towards the symbology and stayed focused on it throughout the recovery. When given head-fixed symbology at the time of an alert, pilots' heads tended to remain off-axis. When given no state or guidance symbology at the time of an alert, pilots' heads turned towards the front of the aircraft, but were not as tightly focused as in the aircraft-fixed symbology case.
4. Pilots given head-fixed guidance symbology exhibited a wide range of head motions during a GCAS alert and recovery. Overall, pilots' heads remained off-axis while performing the recovery maneuver. This implies that the use of head-fixed guidance symbology may allow pilots to perform tasks requiring off-axis head positioning while precisely guiding

the aircraft. This may also have possible implications for the pilot's vestibular sense during maneuvers, and more research should be done in this area.

5. Though individual pilot preference for specific symbology differed, pilots preferred the head-fixed guidance symbology with a pitch ladder for a GCAS alerting display over all other displays tested using the Analytical Hierarchy Process.

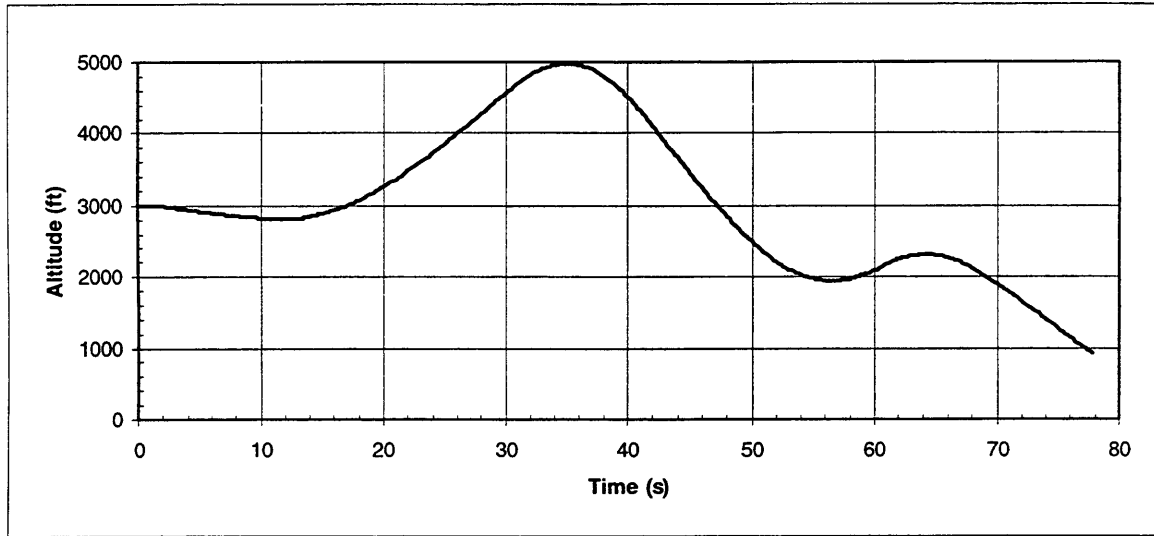
## References

1. Kuchar, James K. and R. John Hansman. Advanced Terrain Displays for Transport Category Aircraft. Dept. of Aeronautics and Astronautics, MIT, Cambridge, MA. Aug. 23, 1991.
2. O'Brien, John E. and William W. Edmunds Jr. New Aircraft Technology and Associated Flight Crew Training. FSF 45th IASS & IFA 22nd International Conference. Long Beach, CA. 1992.
3. Statistical data received from Dr. Mike Borowsky of the Naval Safety Center, Norfolk, VA.
4. Statistical data received from DJ Atkins of the Air Force Safety Center, Kirtland AFB, NM.
5. Shah, Diane S. Ground Collision Warning System Performance Criteria for High Maneuverability Aircraft. Wright-Patterson AFB, OH. Dec., 1988.
6. Bateman, Don. Flight Into Terrain and The Ground Proximity Warning System. Sundstrand Data Control, Inc. Jan. 16, 1990.
7. Holland, Dwight A., and James E. Freeman. A Ten-Year Overview of USAF F-16 Mishap Attributes from 1980-89. Proceedings of the Human Factors and Ergonomics Society 39th Annual Meeting. San Diego, CA. 1995. 30-34.
8. Hewitt, C., A.J. Henley, and J.D. Boyes. A Ground and Obstacle Collision Avoidance Technique (GOCAT). Proceedings of the IEEE 1991 National Aerospace and Electronics Conference.
9. Hughes, David. "CFIT Task Force to Develop Simulator Training Aid." Aviation Week and Space Technology. Jul. 10, 1995. 34-38.
10. Kuchar, James K. and R. John Hansman. A Unified Methodology for the Evaluation of Hazard Alerting Systems. Dept. of Aeronautics and Astronautics, MIT, Cambridge, MA. Jan., 1995
11. DiPadua, Capt M.A., R. Geiselhart, and J. Gavern. Comparison of the General Dynamics Ground Clobber Algorithm with the GCAS and LAWS Algorithms. Wright-Patterson AFB, OH. Apr., 1988.
12. Haase, Capt David. ALPA Ground-proximity Warning System Survey. FSF 45th IASS & IFA 22nd International Conference. Long Beach, CA. 1992.
13. Bateman, Don. Ground Proximity Warning Systems (GPWS): Success & Further Progress. The International Civil and Military Avionics Conference, Cafe Royal, London, U.K. Apr. 7, 1994.

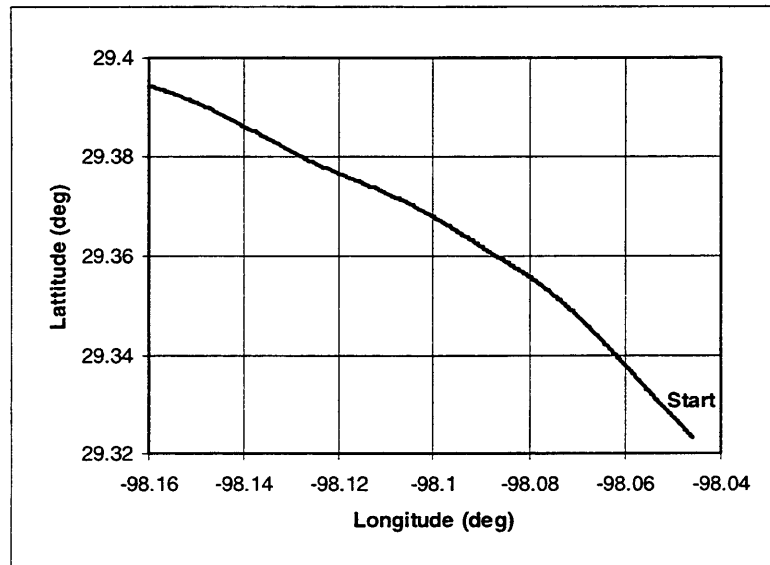
14. DeCelles, J.L. The Delayed GPWS Response Syndrome. Aviation Research & Education Foundation. Herndon, VA. Jul., 1991.
15. Sanders, Mark S. and Ernest J. McCormick. Human Factors in Engineering and Design. 7th ed. New York: McGraw-Hill, Inc., 1993. 169-89.
16. Lagarhus, Capt Otto. Ground-proximity Warnings -- Why Do We Get Them?, How Can We Avoid Them?, How Do We Train to Survive The Real Ones? FSF 45th IASS & IFA 22nd International Conference. Long Beach, CA. 1992.
17. Proctor, Paul. "Major Airlines Embrace Enhanced GPWS." Aviation Week and Space Technology. Apr. 21, 1997. 46-48.
18. Boucek, Jr., G.P., B.L. Berson, D.A. Po-Chedley, and J.F. Hendrickson. Aircraft Alerting Systems Standardization Study. 4th AIAA/IEEE Digital Avionics Systems Conference. St. Louis, MO. Nov. 17-19, 1981.
19. VR4 User's Guide. Virtual Research Systems, Inc. Santa Clara, CA. 1994.
20. 3D Mouse & Head Tracker Technical Reference Manual. Logitech, Inc. Fremont, CA. Nov., 1992.
21. Yang, L. and R. J. Hansman. Application of the Analytic Hierarchy Process for Making Subjective Comparisons Between Multiple Automation/Display Options. 6th IFAC/IFIP/IFORS/IEA Symposium. Cambridge, MA. June 27-29, 1995.
22. Boff, K.R., and J.E. Lincoln. Engineering Data Compendium: Human Perception and Performance. AAMRL. Wright-Patterson AFB, OH. 1988.

# Appendix A

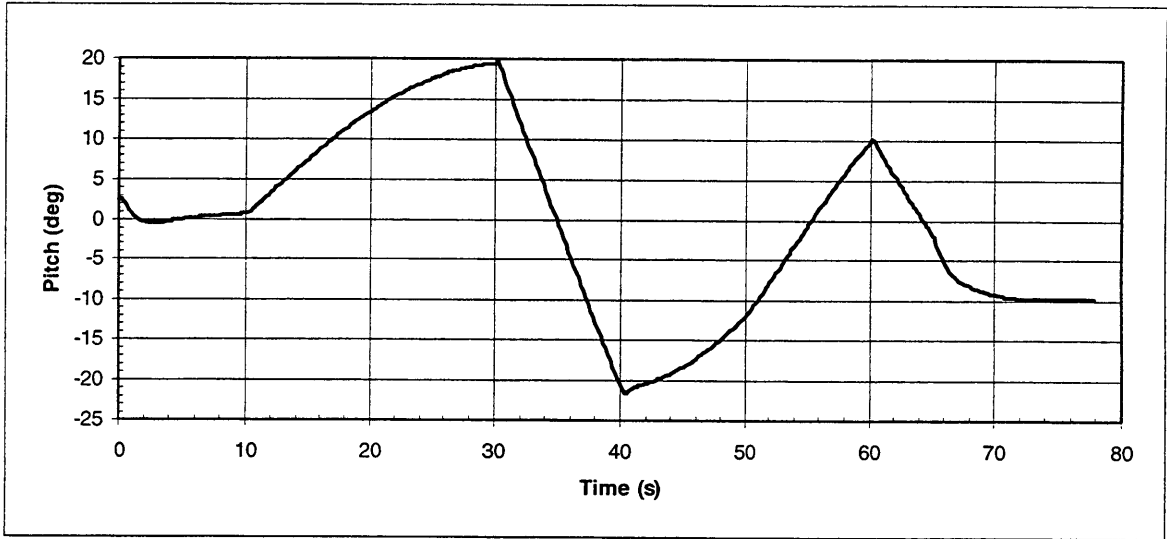
## Flight Profiles



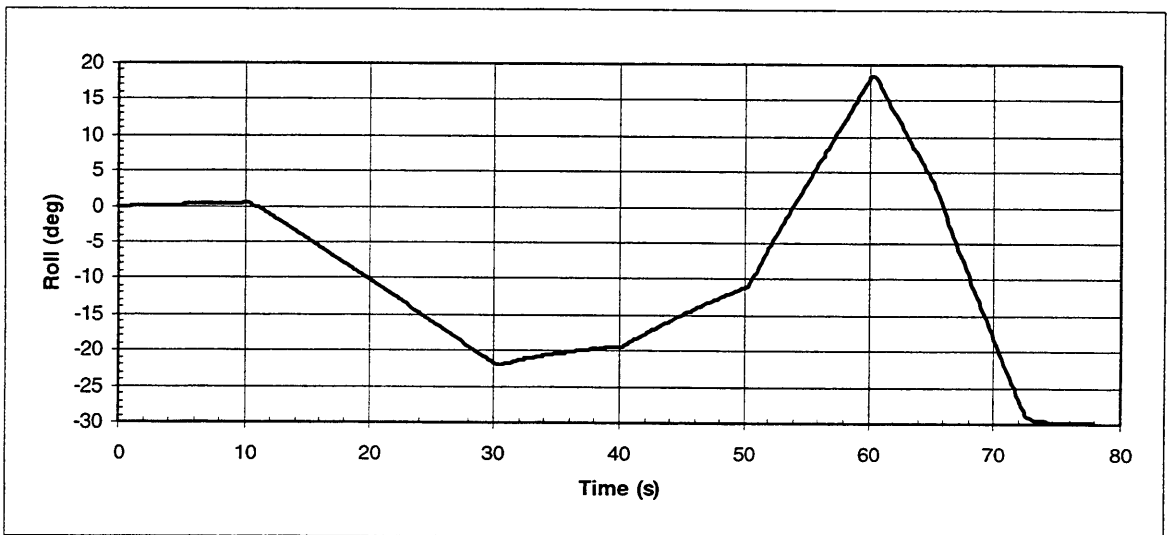
Altitude History - Profile 1



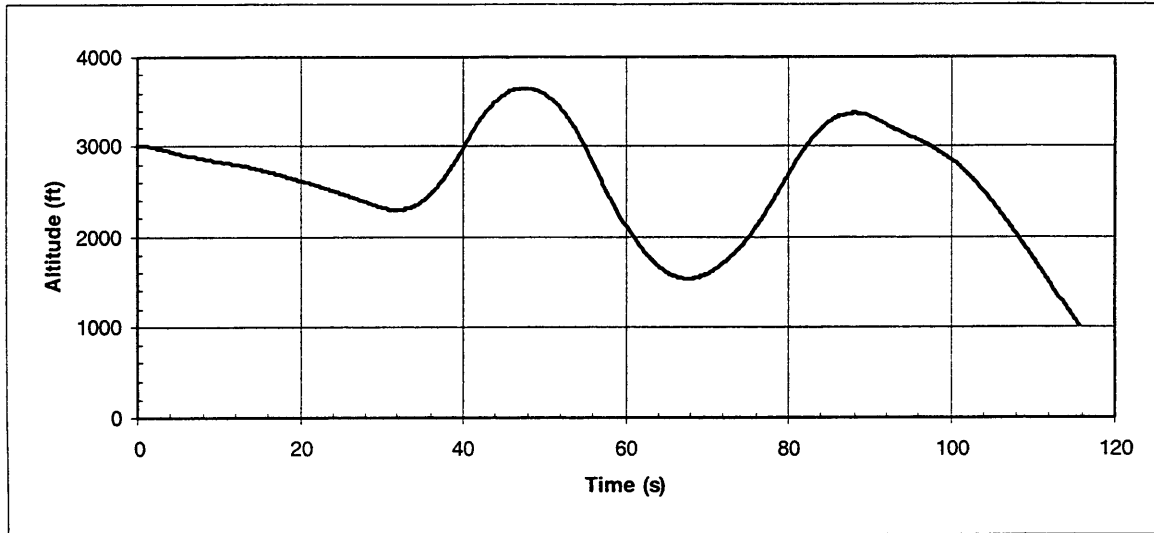
Ground Track - Profile 1



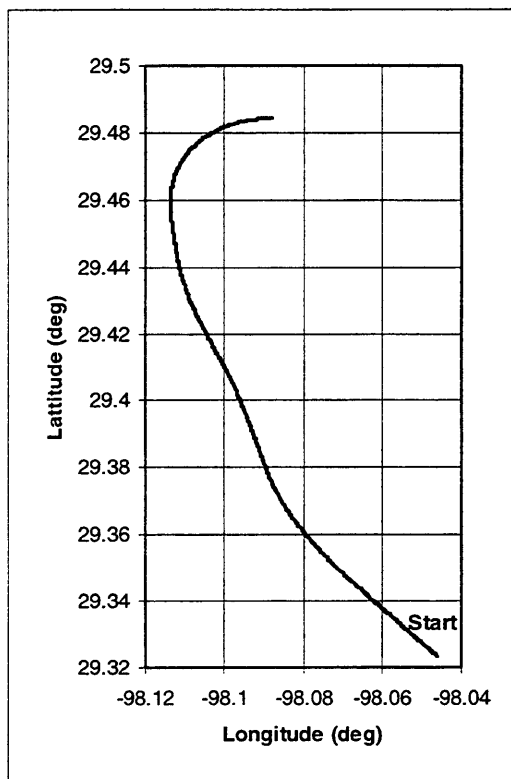
**Pitch History - Profile 1**



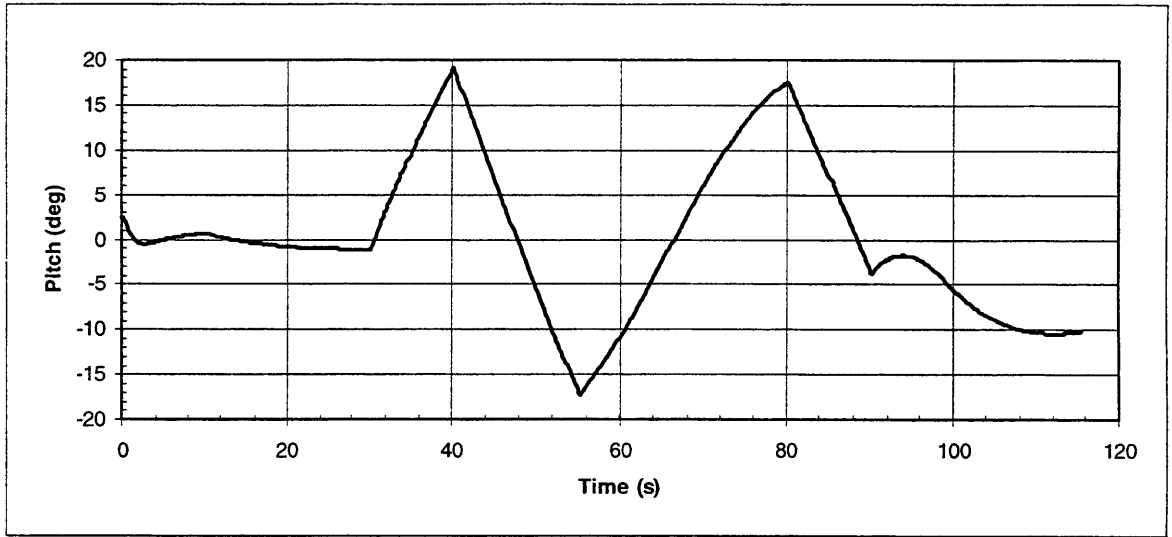
**Roll History - Profile 1**



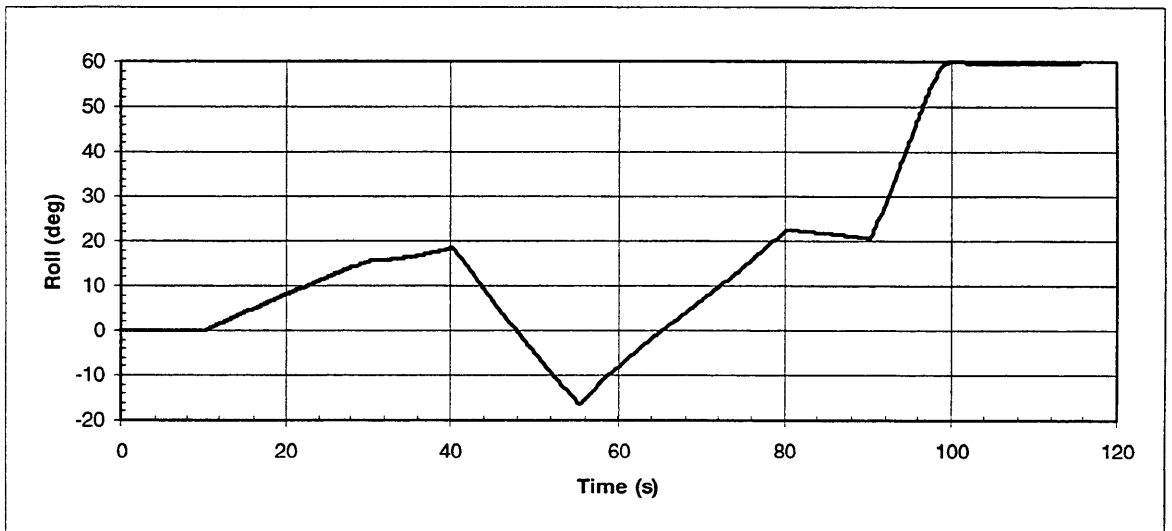
**Altitude History - Profile 2**



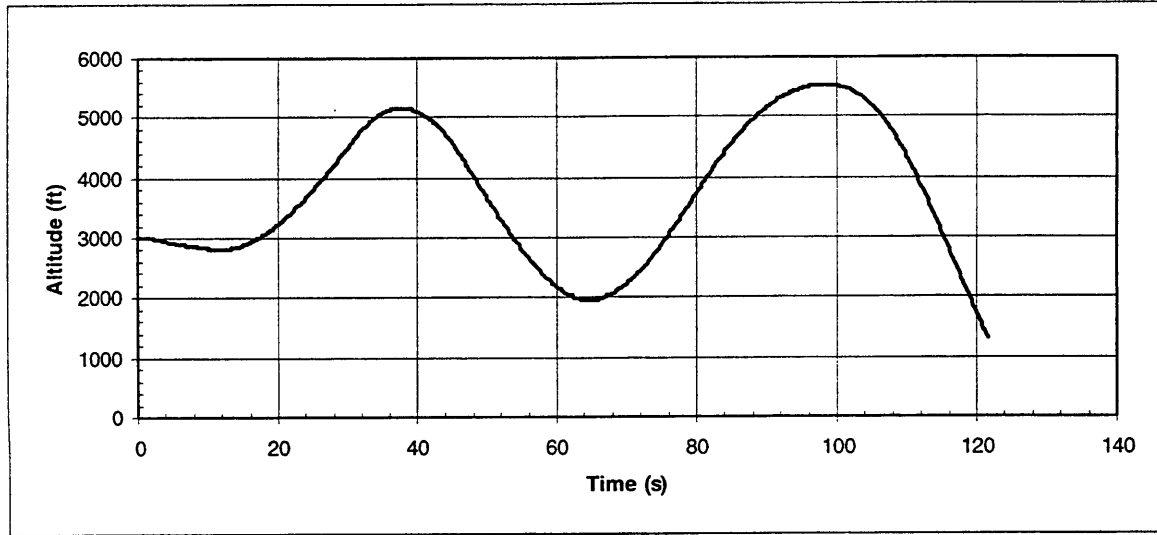
**Ground Track - Profile 2**



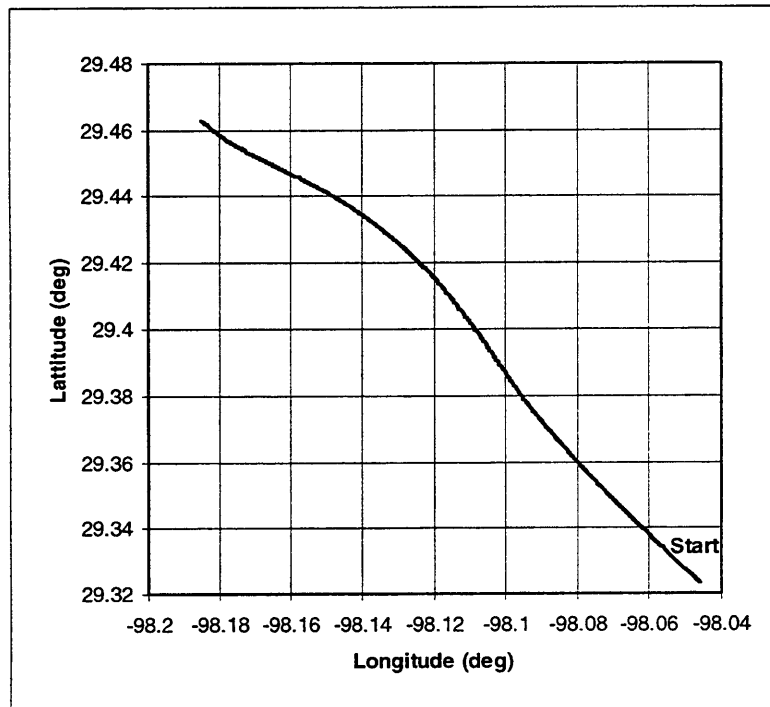
**Pitch History - Profile 2**



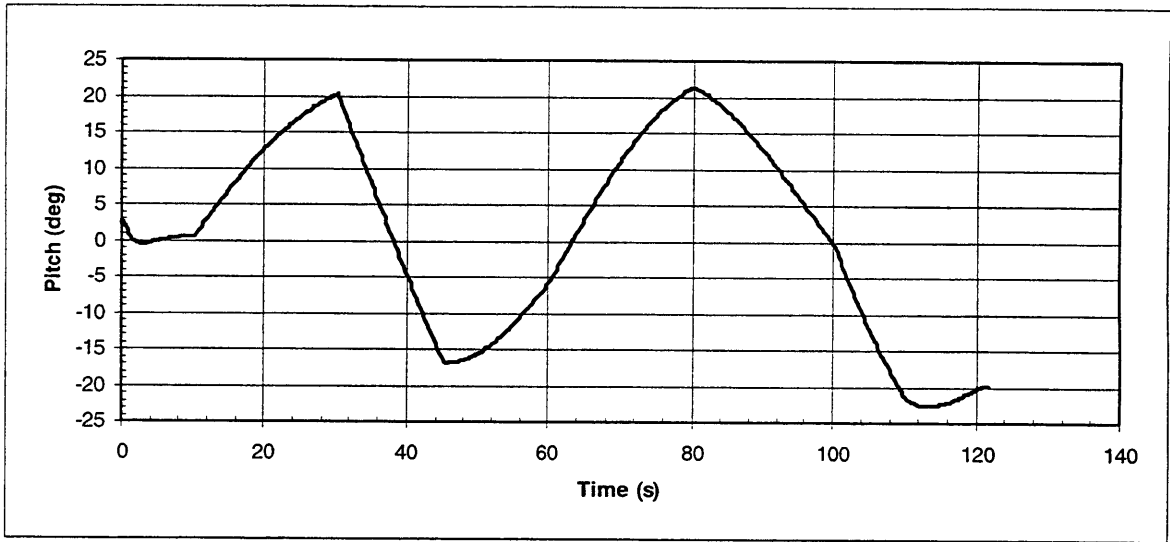
**Roll History - Profile 2**



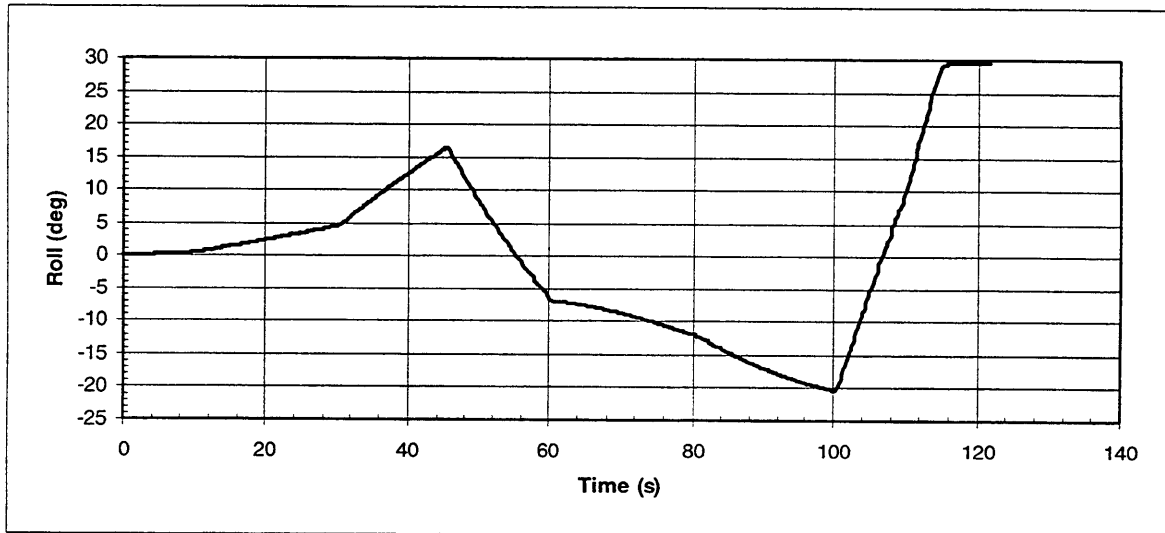
**Altitude History - Profile 3**



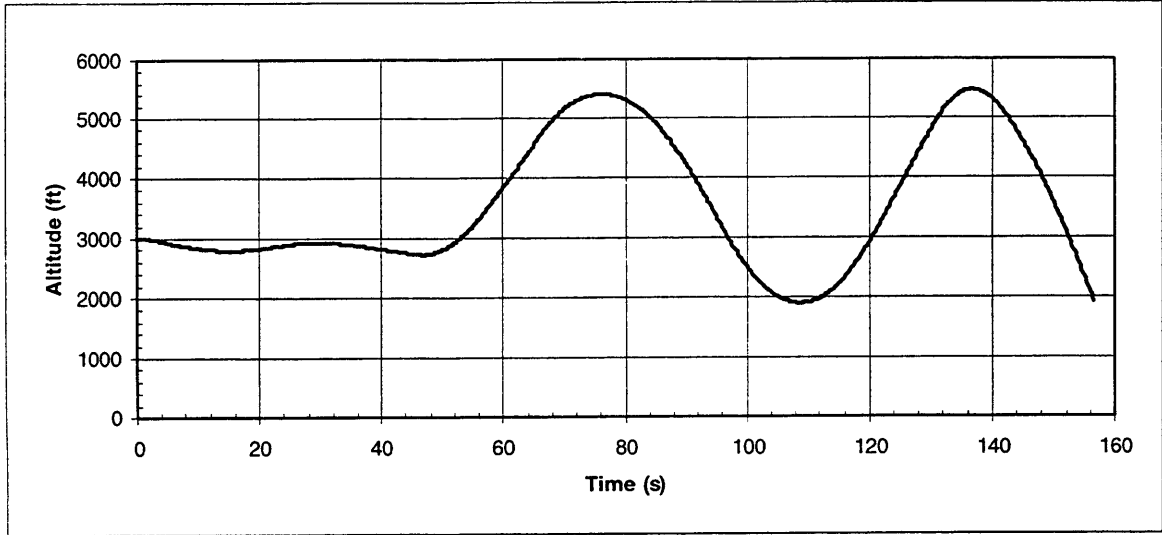
**Ground Track - Profile 3**



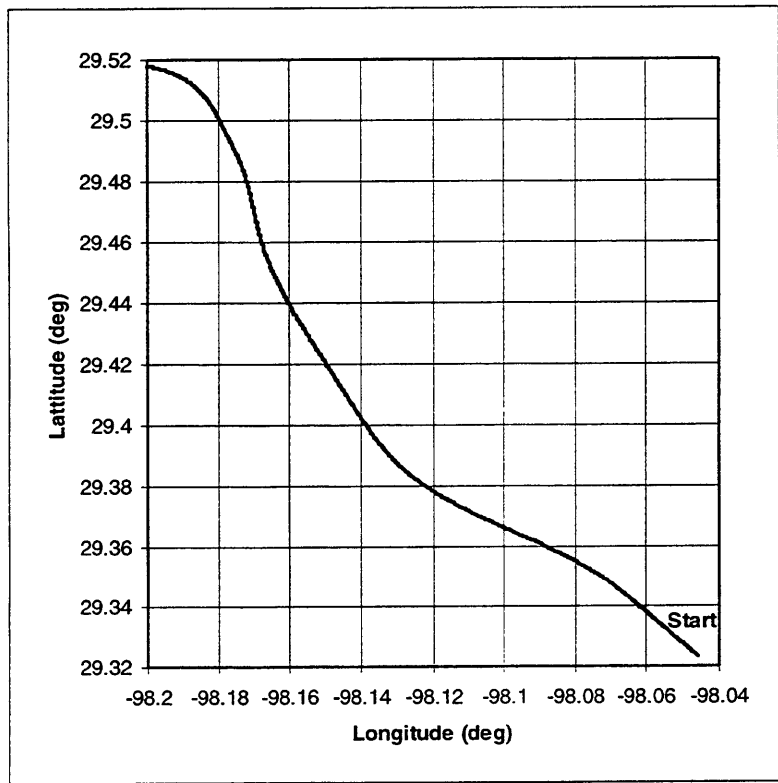
**Pitch History - Profile 3**



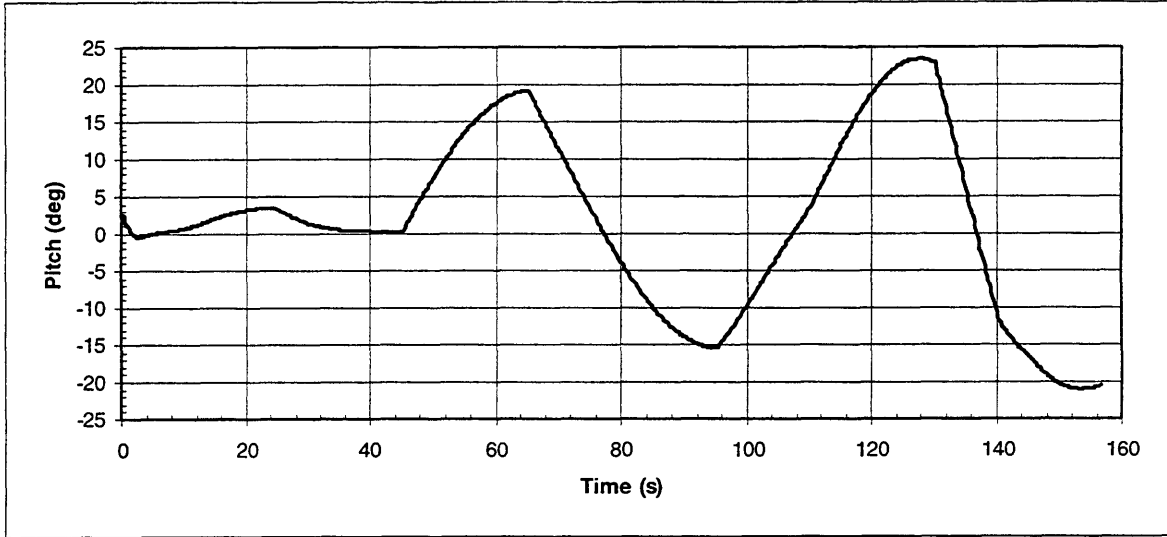
**Roll History - Profile 3**



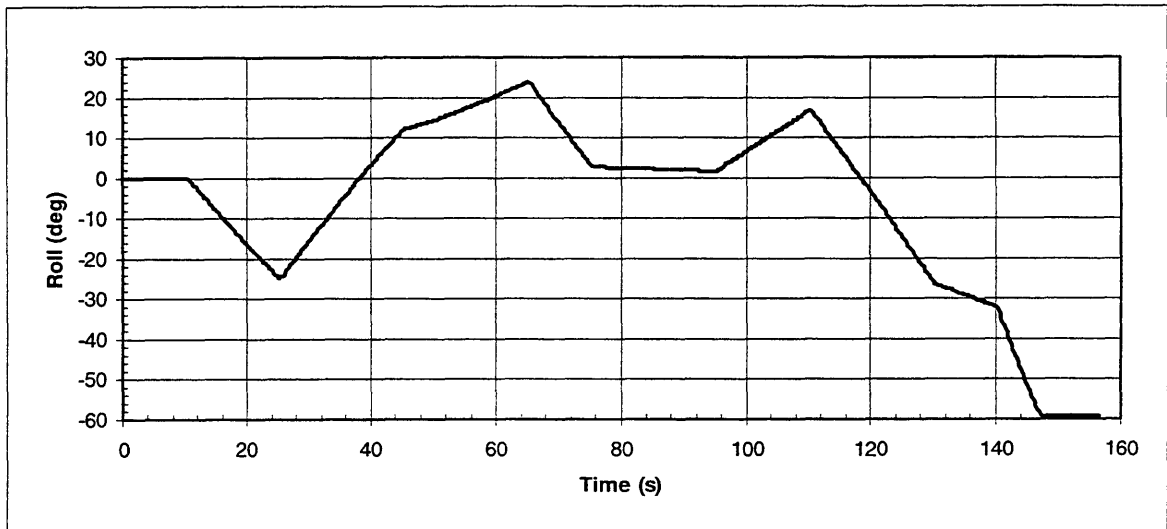
**Altitude History - Profile 4**



**Ground Track - Profile 4**



**Pitch History - Profile 4**



**Roll History - Profile 4**

## Appendix B

### Informed Consent Statement

#### Experimental Study of Visual Alert Cues for Terrain Avoidance During Low-Level Maneuvering Flight

Research Assistant:

J. Brett Taylor  
Room 3451B  
C. S. Draper Laboratory  
Cambridge, MA 02139

Principal Investigator:

Prof. James Kuchar  
MIT Rm. 33-117  
77 Massachusetts Ave.  
Cambridge, MA 02139

Participation in this study is voluntary and you may halt the experiment at any time and withdraw from the study for any reason, without prejudice.

This study is designed to evaluate several candidate alerting displays for terrain avoidance during low-level maneuvering. You will be flying a T-38 flight simulator and will be wearing a head-mounted display that shows the view out the cockpit. During these flights, your task is to identify targets visually, respond to radio calls, and to respond to any terrain alerts. As you fly, you will be scored on your ability to perform these tasks correctly and rapidly. This study will consist of two phases. There will be a brief interview after each phase and at the end of the testing. The study is expected to take a total of 3 hours to complete.

As with any flight simulation, you may or may not experience “simulator sickness”, including disorientation, vertigo, dizziness, headache, eye strain, fatigue, nausea, and in extreme cases, vomiting. Additionally, the head-mounted display may produce skin irritation and neck strain. As a result, you will continually be in voice contact with the experimenter, who will be stationed next to the simulator cockpit, and frequent rest periods will be provided. Please inform the experimenter at the first sign of any uncomfortable symptoms, and the experiment will be interrupted and an attempt made to alleviate the cause of the symptoms. Should you wish to stop or delay the experiment, you are free to do so at any time.

All data will be collected in a confidential manner and will not be linked in any way to your identity. You will remain anonymous in any report which describes this work.

If you have any questions concerning the purpose, procedures, or risks associated with this experiment, please ask them.

CONSENT

In the unlikely event of physical injury resulting from participation in this research, I understand that medical treatment will be available from the M.I.T. Medical Department, including first aid, emergency treatment and follow-up care as needed, and that my insurance carrier may be billed for the cost of such treatment. However, no compensation can be provided for medical care apart from the foregoing. I further understand that making such medical treatment available, or providing it, does not imply that such injury is the Investigator's fault. I also understand that by my participation in this study I am not waiving any of my legal rights.\*

I understand that I may also contact the Chairman of the Committee on the Use of Humans as Experimental Subjects, M.I.T. 253-6787, if I feel I have been treated unfairly as a subject.

I volunteer to participate in this experiment which is to involve flight simulation using a head-mounted display. I understand that I may discontinue my participation at any time. I have been informed as to the nature of this experiment and the risks involved, and agree to participate in the experiment.

---

Date

---

Signature

---

\* Further information may be obtained by calling the Institute's Insurance and Legal Affairs Office at 253-2822.

## Appendix C

### Experiment Part 1 Questionnaire

#### Audio Only vs. Break X

1. How aware were you of the aircraft's **altitude** while performing the tasks (before each terrain alert activated) (1-5)?

Completely Unaware					Knew Attitude at All Times
1	2	3	4	5	

2. How aware were you of the aircraft's **altitude** while performing the tasks (before each terrain alert activated) (1-5)?

Completely Unaware					Knew Altitude at All Times
1	2	3	4	5	

3. How effective was each alert in getting your attention (1-5)?

Audio alert only:

Very Bad					Very Good
1	2	3	4	5	

Break X alert:

Very Bad					Very Good
1	2	3	4	5	

4. How effectively did each alert convey the sense of urgency (1-5)?

Audio alert only:

Very Bad					Very Good
1	2	3	4	5	

Break X alert:

Very Bad					Very Good
1	2	3	4	5	

5. Compare the dominance of the alert types you received (how much you preferred one over the other) (1-9):

absolute	very strong	strong	weak	equal	weak	strong	very strong	absolute
1	2	3	4	5	6	7	8	9

Audio Only

Break X

## Appendix D

### Experiment Part 2 Questionnaire

#### A/C-Fixed vs. Head-Fixed vs. Head-Fixed + Ladder

1. How aware were you of the aircraft's **altitude** while performing the tasks (before each terrain alert activated) (1-5)?

Completely Unaware					Knew Attitude at All Times
1	2	3	4	5	

2. How aware were you of the aircraft's **altitude** while performing the tasks (before each terrain alert activated) (1-5)?

Completely Unaware					Knew Altitude at All Times
1	2	3	4	5	

3. How effective was each alert in getting your attention (1-5)?

Aircraft-fixed guidance info:

Very Bad					Very Good
1	2	3	4	5	

Head-fixed guidance info:

Very Bad					Very Good
1	2	3	4	5	

Head-fixed guidance info + pitch ladder:

Very Bad					Very Good
1	2	3	4	5	

4. How effectively did each alert convey the sense of urgency (1-5)?

Aircraft-fixed guidance info:

Very Bad					Very Good
1	2	3	4	5	

Head-fixed guidance info:

Very Bad					Very Good
1	2	3	4	5	

Head-fixed guidance info + pitch ladder:

Very Bad					Very Good
1	2	3	4	5	

5. How easy was it to understand the information presented in each alert (1-5)?

Aircraft-fixed guidance info:

Very Hard 1 2 3 4 5 Very Easy

Head-fixed guidance info:

Very Hard 1 2 3 4 5 Very Easy

Head-fixed guidance info + pitch ladder:

Very Hard 1 2 3 4 5 Very Easy

6. How useful was the information presented in each alert (1-5)?

Aircraft-fixed guidance info:

Very Useless 1 2 3 4 5 Very Useful

Head-fixed guidance info:

Very Useless 1 2 3 4 5 Very Useful

Head-fixed guidance info + pitch ladder:

Very Useless 1 2 3 4 5 Very Useful

7. Compare the dominance of the alert types you received (how much you preferred one over the other) (1-9):

	absolute	very strong	strong	weak	equal	weak	strong	very strong	absolute
	1	2	3	4	5	6	7	8	9
A/C-Fixed									Head-Fixed

	absolute	very strong	strong	weak	equal	weak	strong	very strong	absolute
	1	2	3	4	5	6	7	8	9
A/C-Fixed									Head-Fixed + Ladder

	absolute	very strong	strong	weak	equal	weak	strong	very strong	absolute
	1	2	3	4	5	6	7	8	9
Head-Fixed									Head-Fixed + Ladder

## **Appendix E**

### **Experiment Part 1 Interview Questions**

Do you have any comments on the tasks you performed?

Do you have any comments on the alerts you received?

Which alert did you prefer and why?

Did your task management change over the course of the experiment?

If so, how?

Did your awareness of the aircraft attitude change over the course of the experiment?

If so, how?

## **Appendix F**

### **Experiment Part 2 Interview Questions**

Do you have any comments on the tasks you performed?

Do you have any comments on the alerts you received?

Which alert did you prefer and why?

Did you have any trouble correlating the head-fixed guidance info and/or pitch ladder with the real world?

If so, explain:

Did your task management change over the course of the experiment?

If so, how?

Did your awareness of the aircraft attitude change over the course of the experiment?

If so, how?

## Appendix G

### Overall Questionnaire

#### Overall

1. Compare the dominance of the alert types you received throughout the experiment (how much you preferred one over the other) (1-9):

	absolute 1	very strong 2	strong 3	weak 4	equal 5	weak 6	strong 7	very strong 8	absolute 9
Audio Only									A/C-Fixed

	absolute 1	very strong 2	strong 3	weak 4	equal 5	weak 6	strong 7	very strong 8	absolute 9
Audio Only									Head-Fixed

	absolute 1	very strong 2	strong 3	weak 4	equal 5	weak 6	strong 7	very strong 8	absolute 9
Audio Only									Head-Fixed + Ladder

	absolute 1	very strong 2	strong 3	weak 4	equal 5	weak 6	strong 7	very strong 8	absolute 9
Break X									A/C-Fixed

	absolute 1	very strong 2	strong 3	weak 4	equal 5	weak 6	strong 7	very strong 8	absolute 9
Break X									Head-Fixed

	absolute 1	very strong 2	strong 3	weak 4	equal 5	weak 6	strong 7	very strong 8	absolute 9
Break X									Head-Fixed + Ladder

2. How were the tasks balanced in terms of time (how much time did you spend on each) (1-5)?

Visual Dominated	Balanced	Audio Dominated
1	2	3
4	5	

3. How were the tasks balanced in terms of physical challenge (how much physical energy did you spend on each) (1-5)?

Visual Dominated	Balanced	Audio Dominated
1	2	3
4	5	

4. How were the tasks balanced in terms of mental challenge (how much mental energy did you spend on each) (1-5)?

Visual Dominated		Balanced		Audio Dominated
1	2	3	4	5

Age:

Gender: M / F

Please list your pilot experience:

Total Hours:

Ratings:

Primary A/C:

Jet Experience:

Military Experience:

HUD Experience:

GCAS Experience:

HMD Experience:

## **Appendix H**

### **Final Interview Questions**

Have you ever had a close ground encounter (where sudden action was required to avoid the ground) or GCAS call before?

If so, could you please describe what happened?

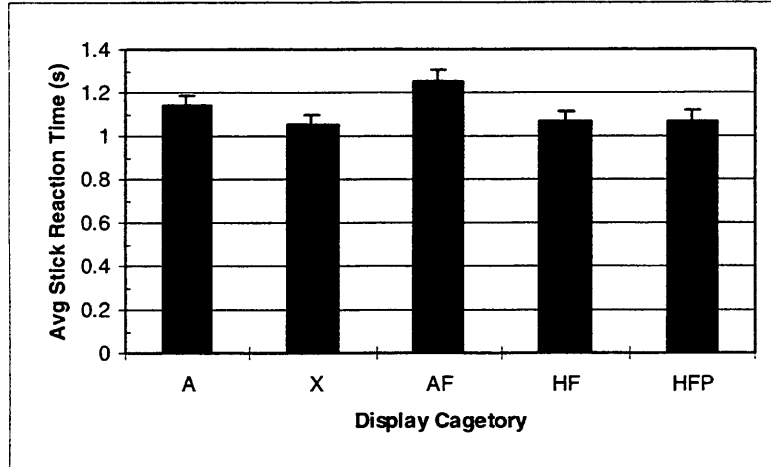
Was a GCAS warning issued?

If so, how did it contribute to your avoidance of the ground?

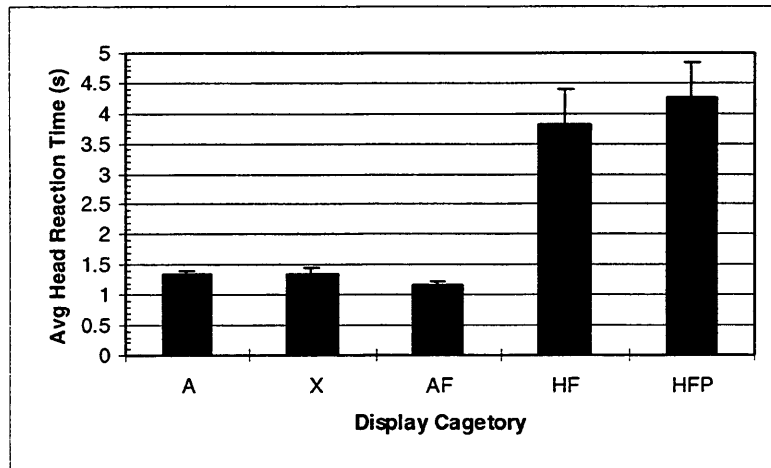
Was the GCAS warning timely? urgent? noticeable? relied on?

## Appendix I

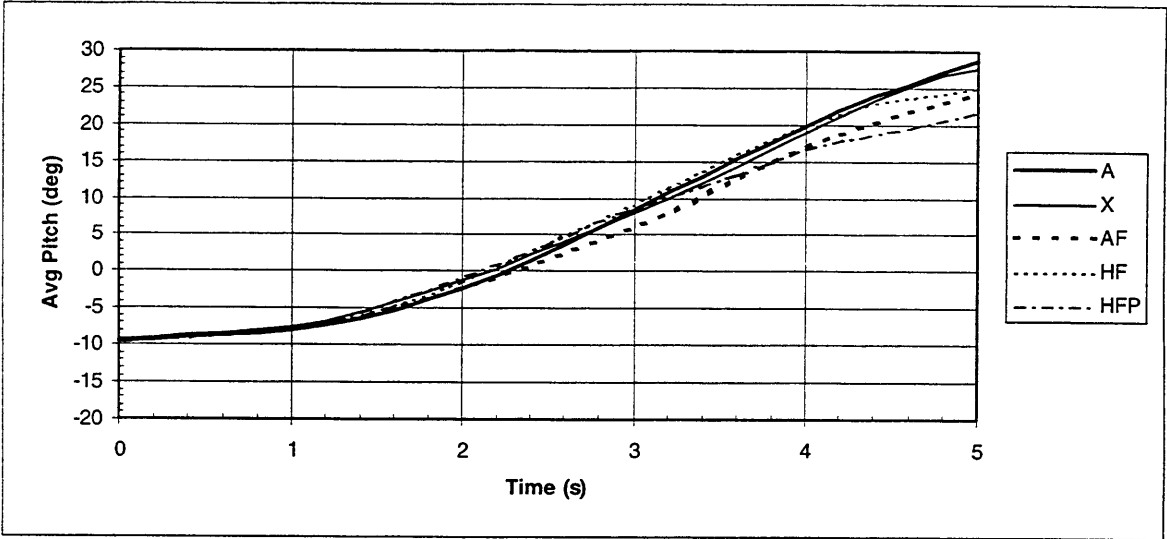
### Experimental Results Figures



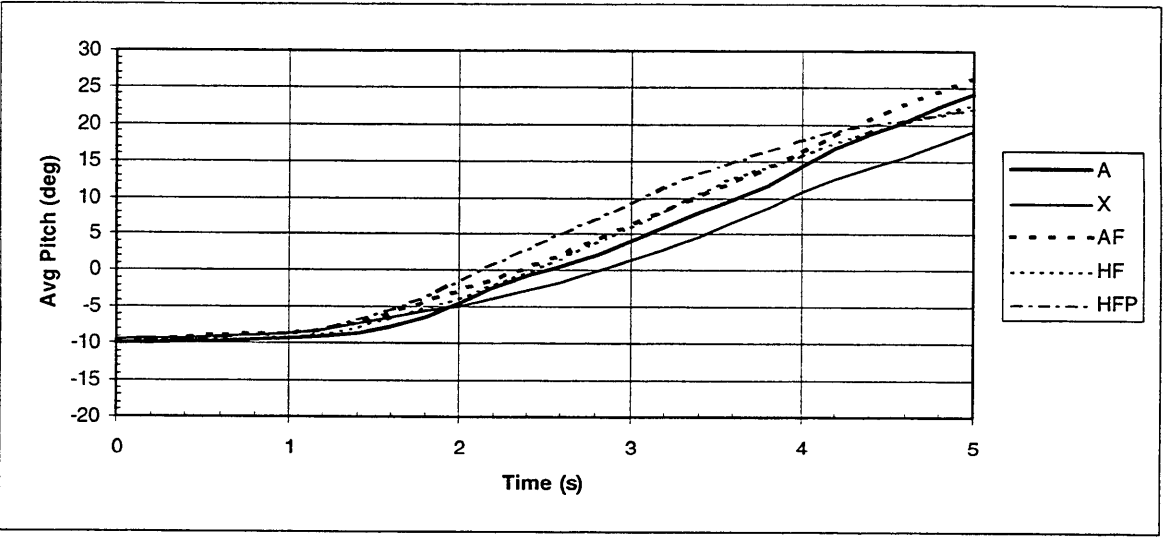
Average Stick Reaction Times (Error bars: 1  $\sigma$  of estimate of mean)



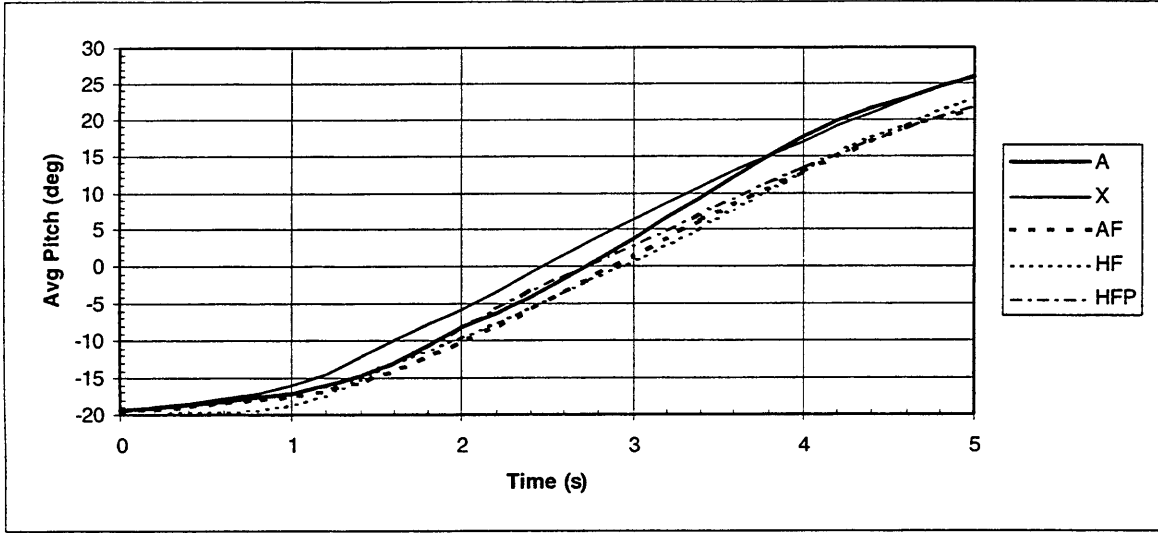
Average Head Reaction Times (Error bars: 1  $\sigma$  of estimate of mean)



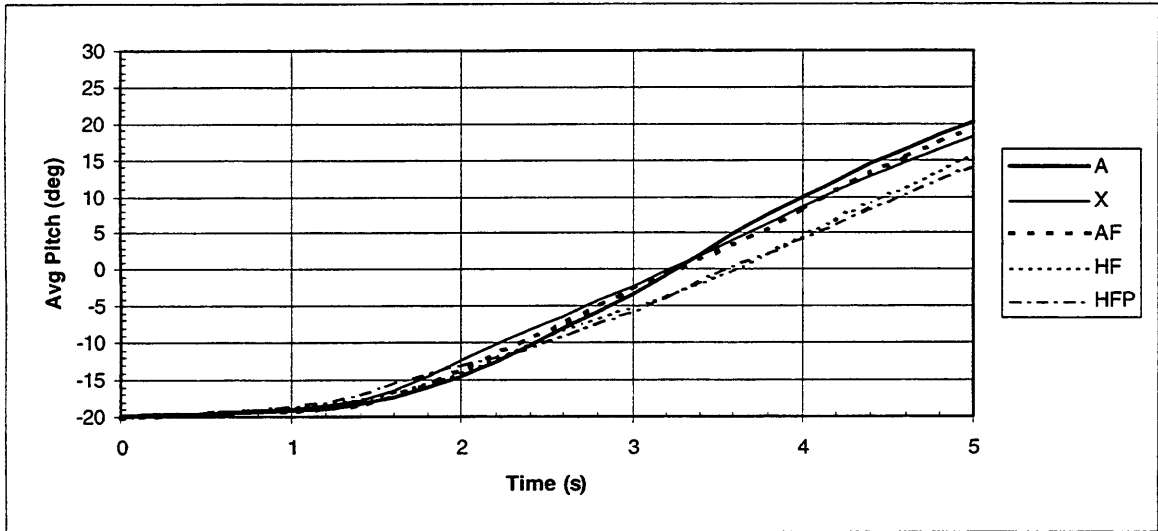
**Average Pitch History Comparison (10-30)**



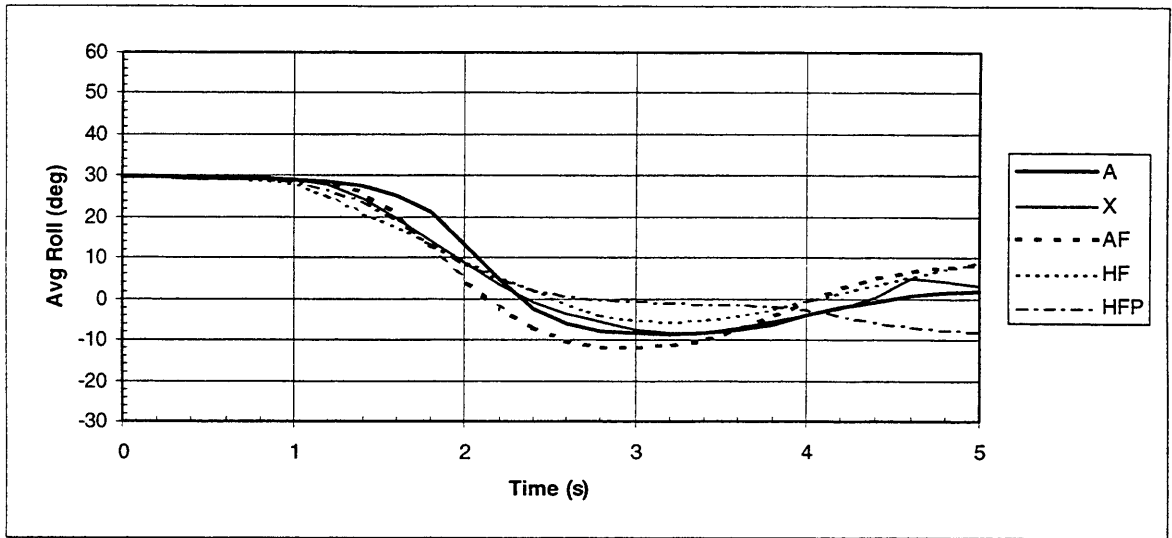
**Average Pitch History Comparison (10-60)**



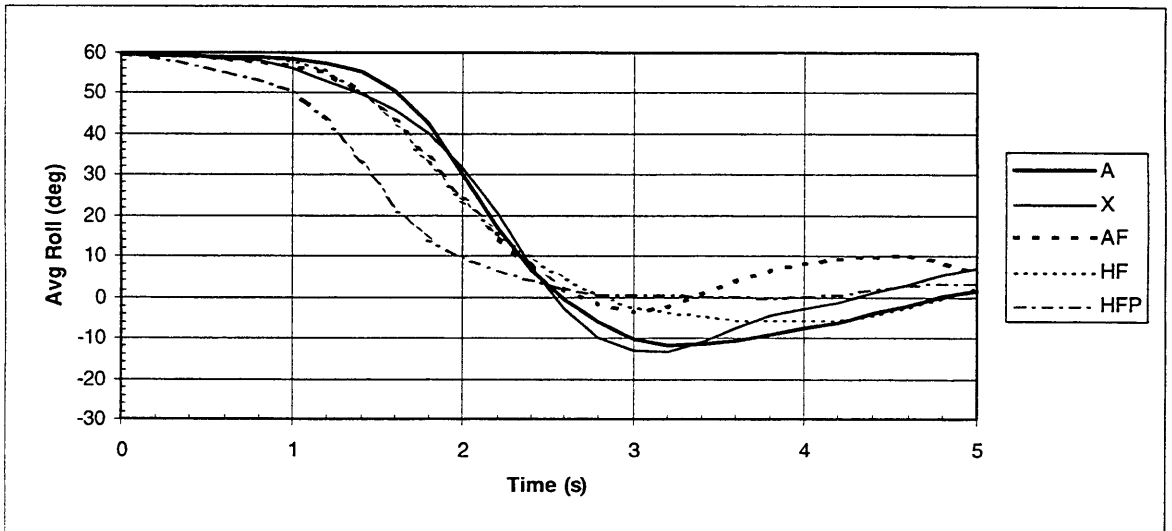
**Average Pitch History Comparison (20-30)**



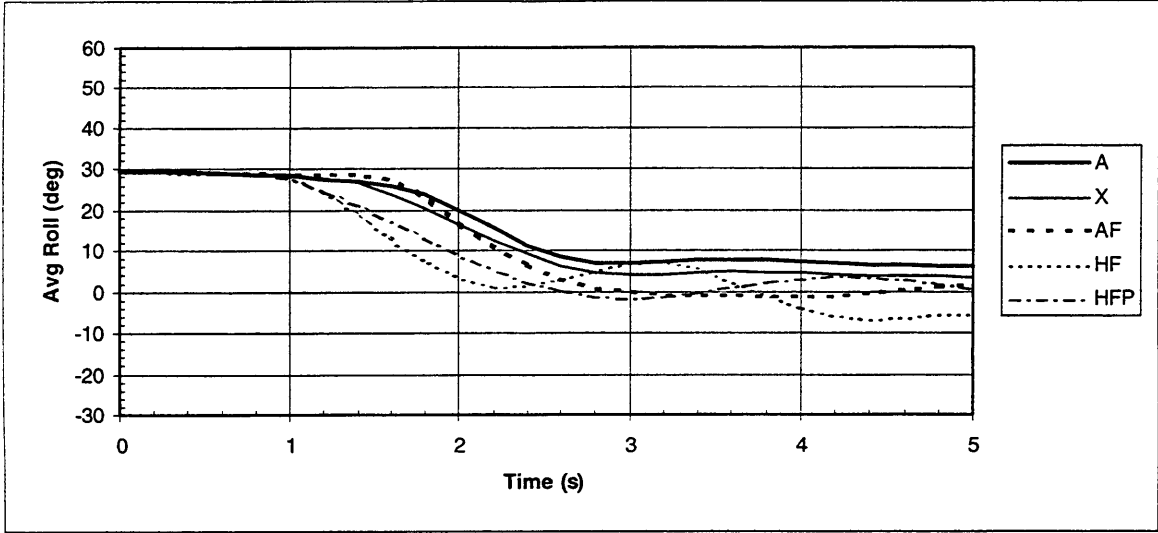
**Average Pitch History Comparison (20-60)**



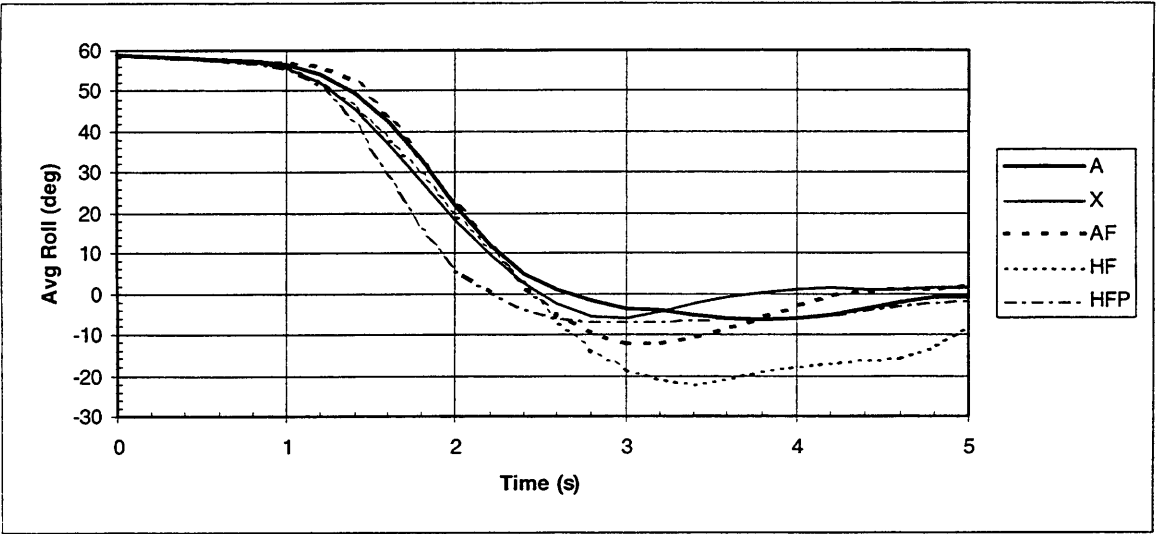
**Average Roll History Comparison (10-30)**



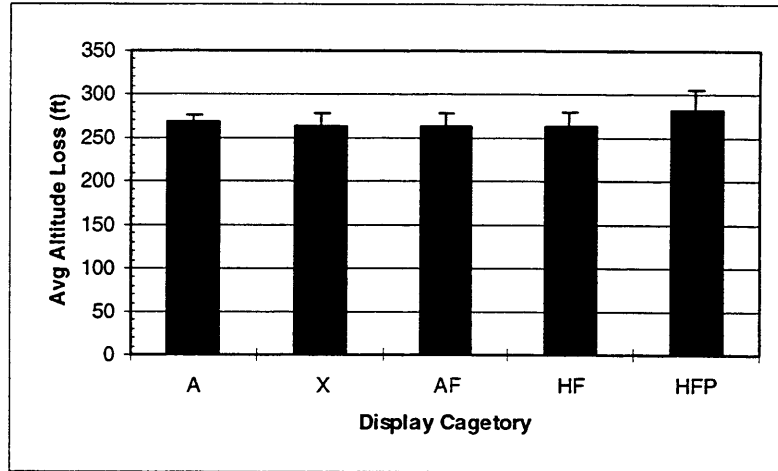
**Average Roll History Comparison (10-60)**



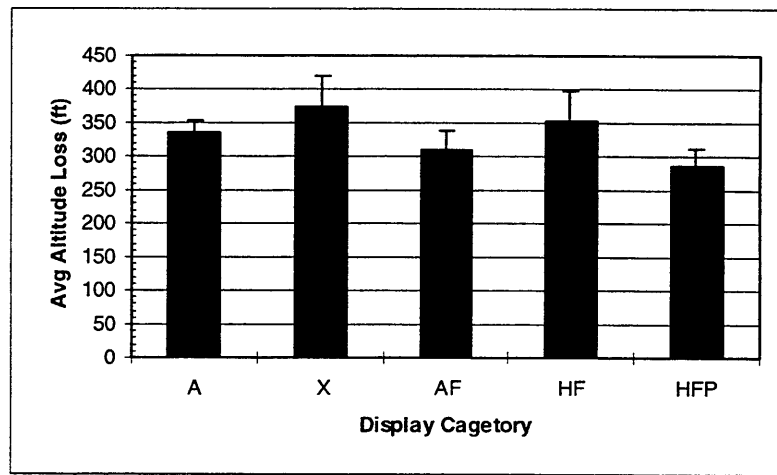
**Average Roll History Comparison (20-30)**



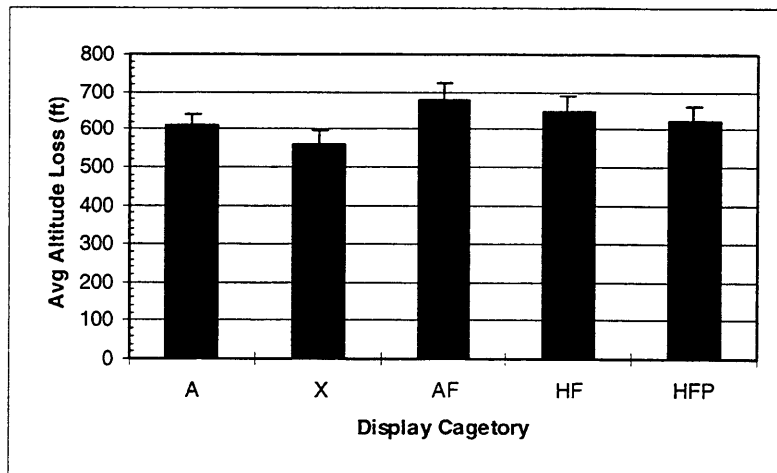
**Average Roll History Comparison (20-60)**



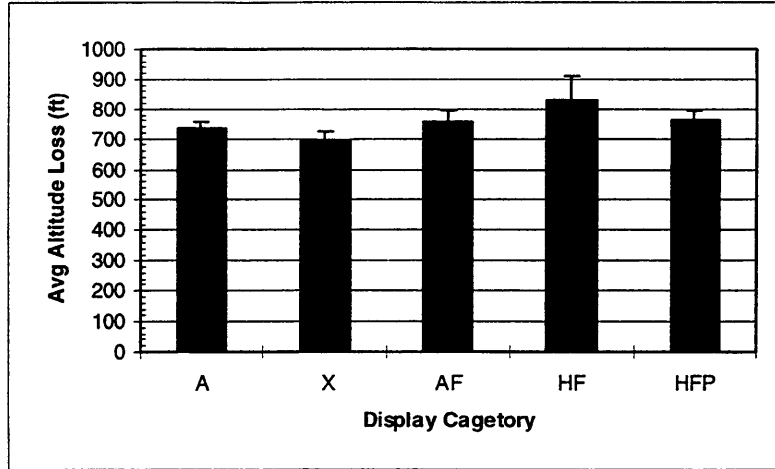
**Average Altitude Loss (10-30) (Error bars: 1  $\sigma$  of estimate of mean)**



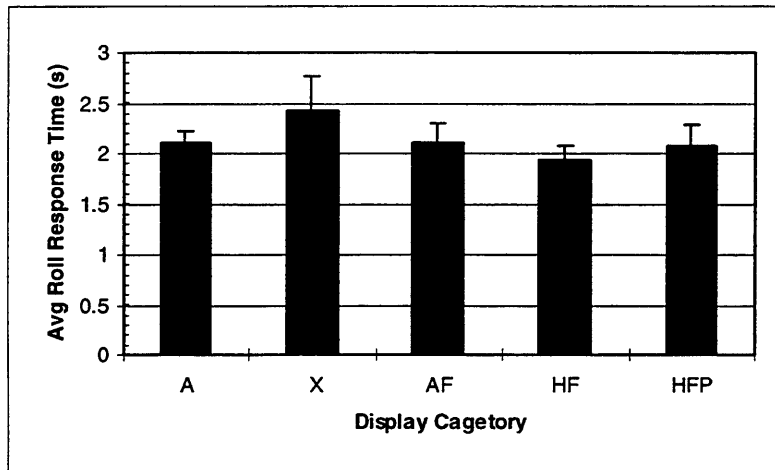
**Average Altitude Loss (10-60) (Error bars: 1  $\sigma$  of estimate of mean)**



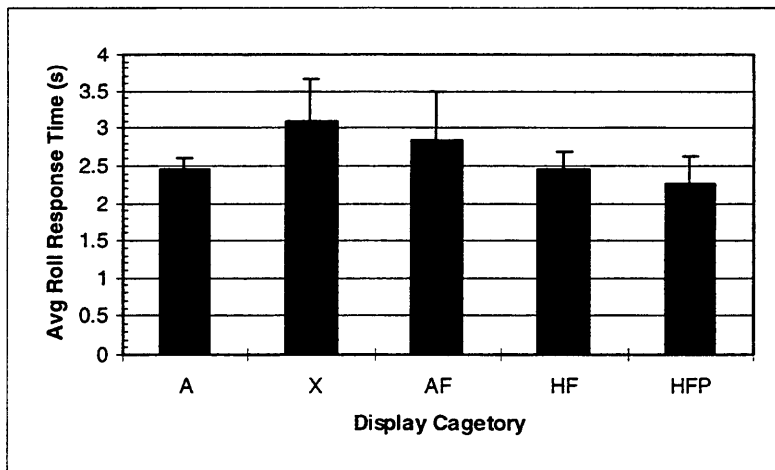
**Average Altitude Loss (20-30) (Error bars: 1  $\sigma$  of estimate of mean)**



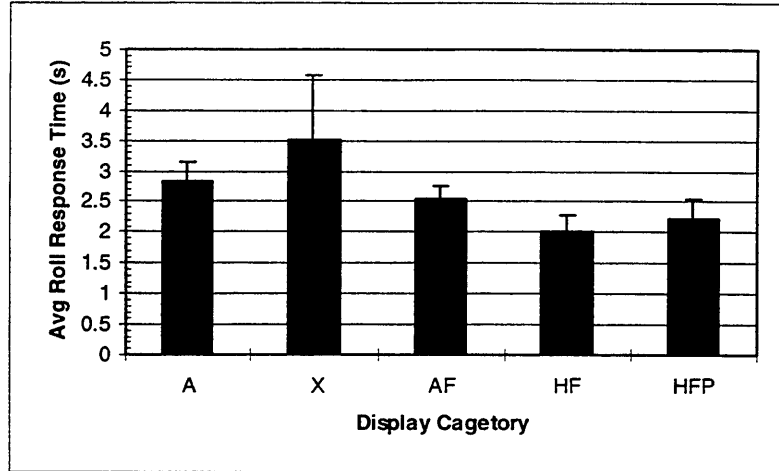
**Average Altitude Loss (20-60) (Error bars: 1  $\sigma$  of estimate of mean)**



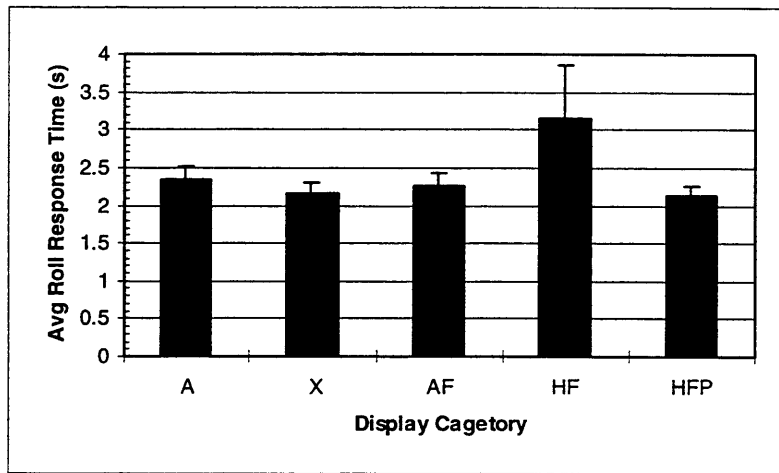
**Average Roll Response Time (10-30) (Error bars: 1  $\sigma$  of estimate of mean)**



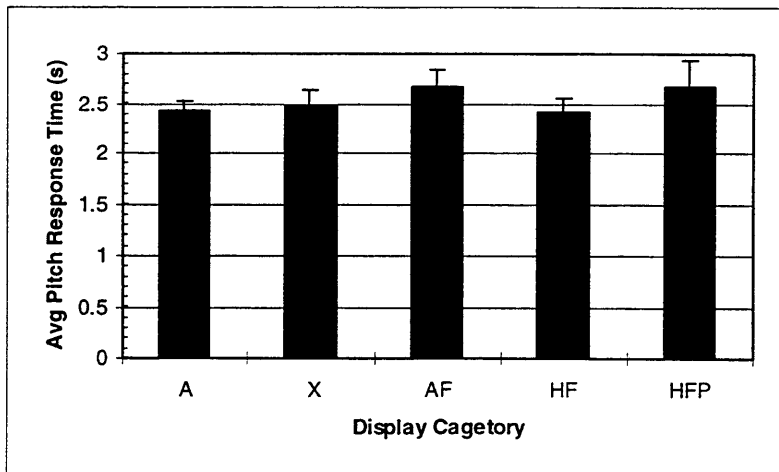
**Average Roll Response Time (10-60) (Error bars: 1  $\sigma$  of estimate of mean)**



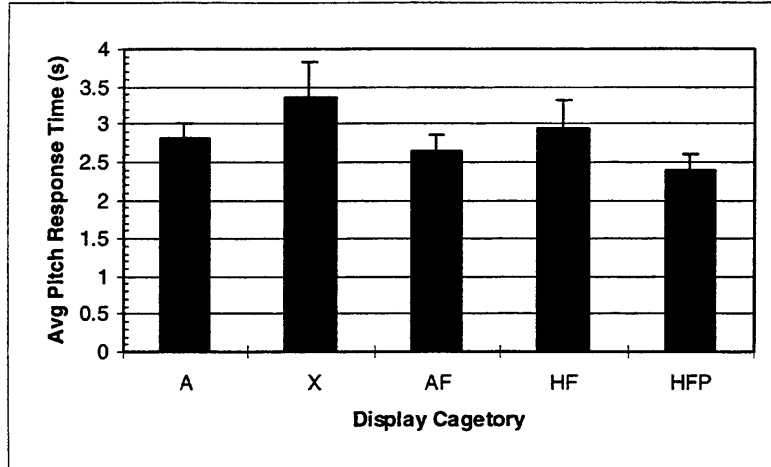
**Average Roll Response Time (20-30) (Error bars: 1  $\sigma$  of estimate of mean)**



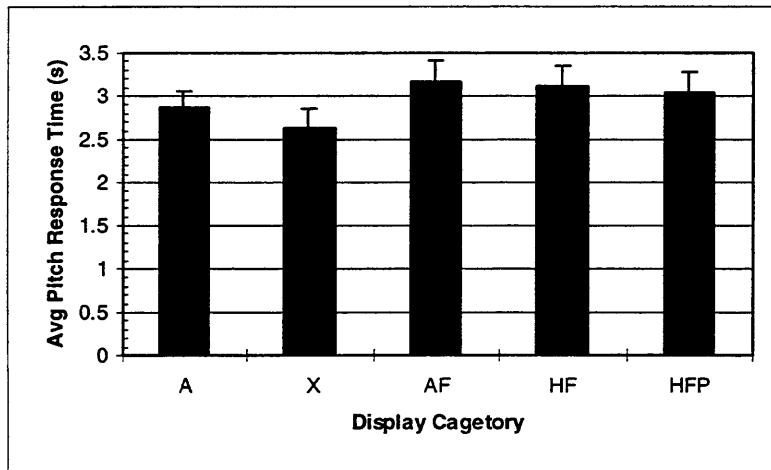
**Average Roll Response Time (20-60) (Error bars: 1  $\sigma$  of estimate of mean)**



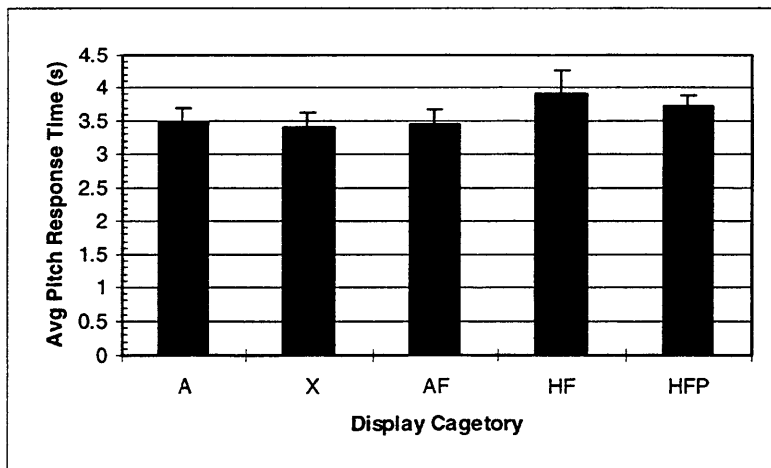
**Average Pitch Response Time (10-30) (Error bars: 1  $\sigma$  of estimate of mean)**



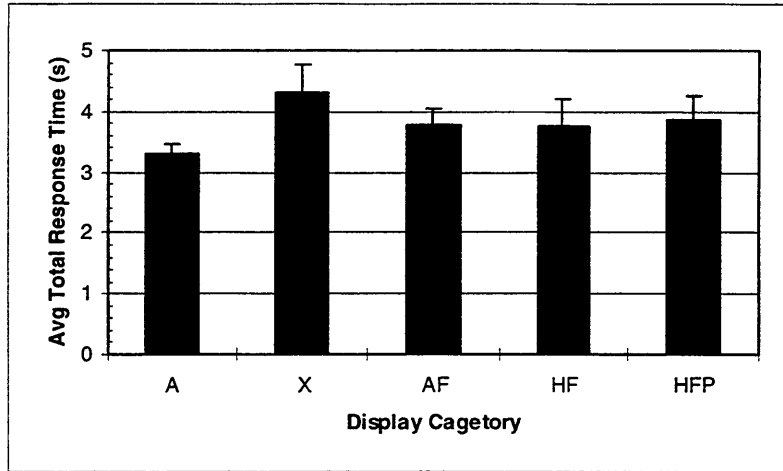
**Average Pitch Response Time (10-60) (Error bars: 1  $\sigma$  of estimate of mean)**



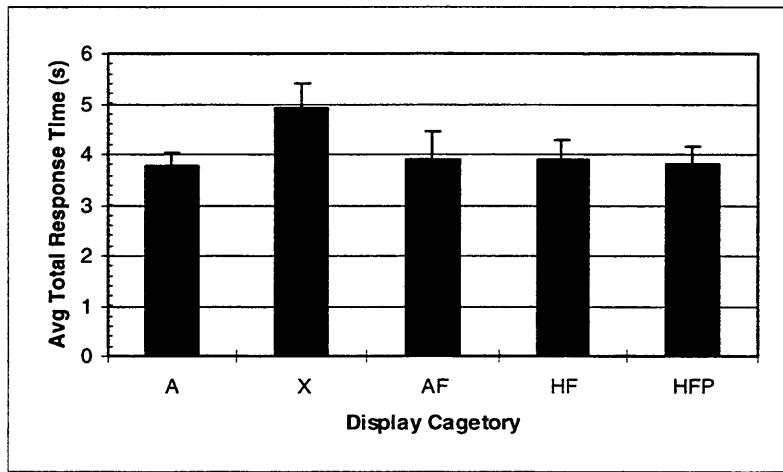
**Average Pitch Response Time (20-30) (Error bars: 1  $\sigma$  of estimate of mean)**



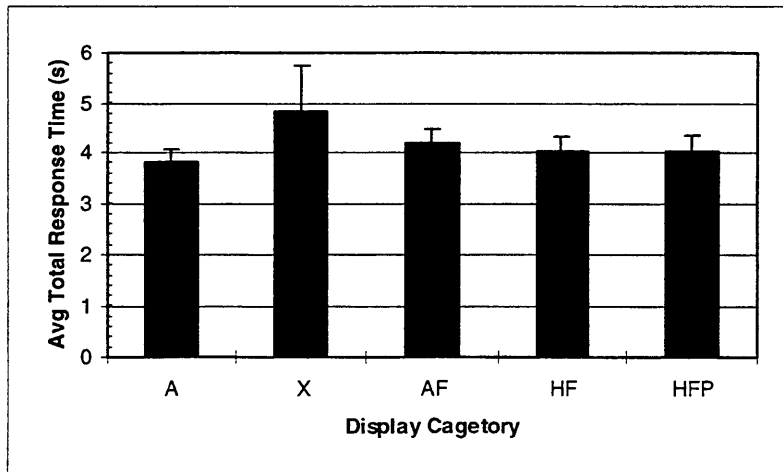
**Average Pitch Response Time (20-60) (Error bars: 1  $\sigma$  of estimate of mean)**



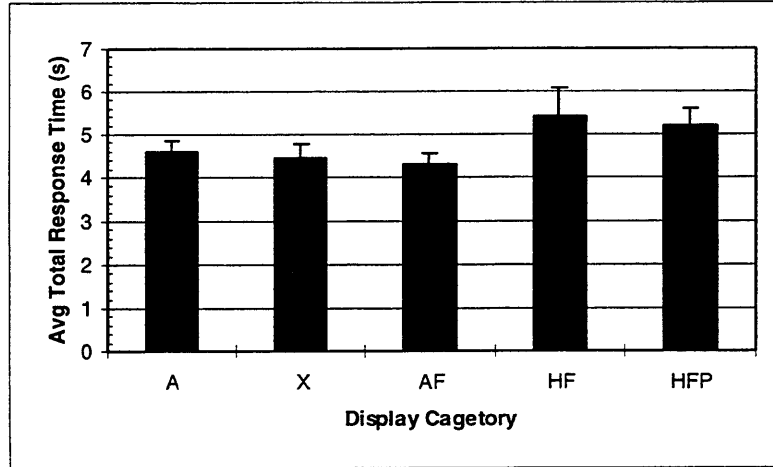
**Average Total Response Time (10-30) (Error bars: 1  $\sigma$  of estimate of mean)**



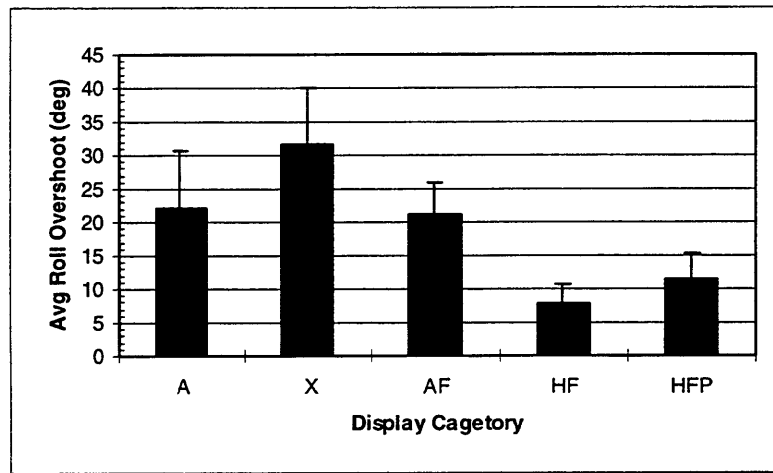
**Average Total Response Time (10-60) (Error bars: 1  $\sigma$  of estimate of mean)**



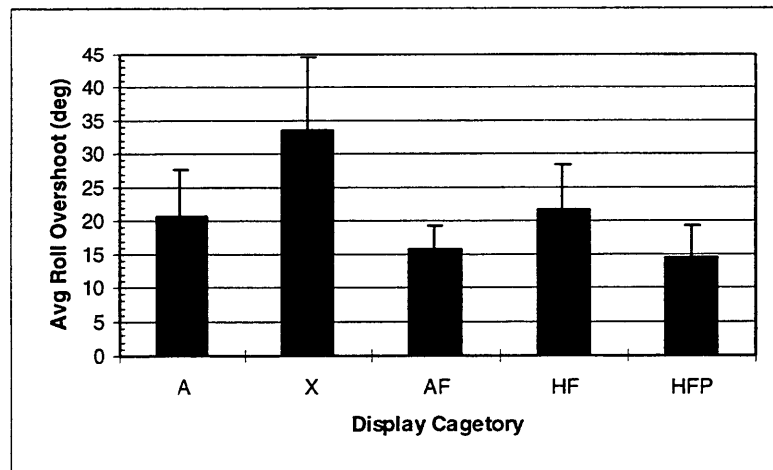
**Average Total Response Time (20-30) (Error bars: 1  $\sigma$  of estimate of mean)**



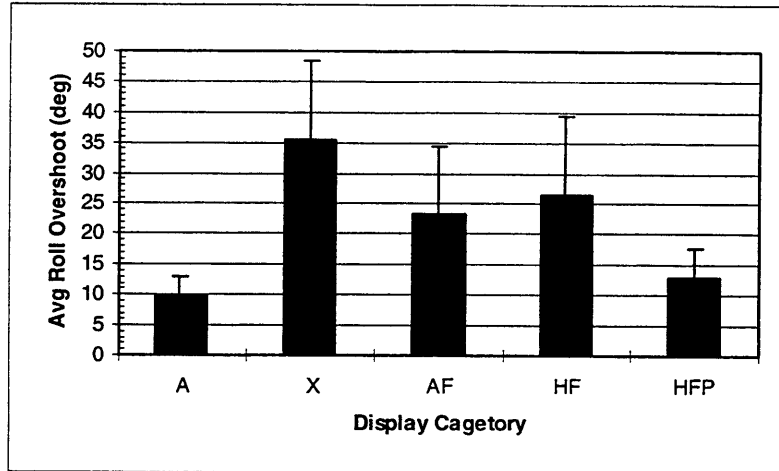
**Average Total Response Time (20-60) (Error bars: 1  $\sigma$  of estimate of mean)**



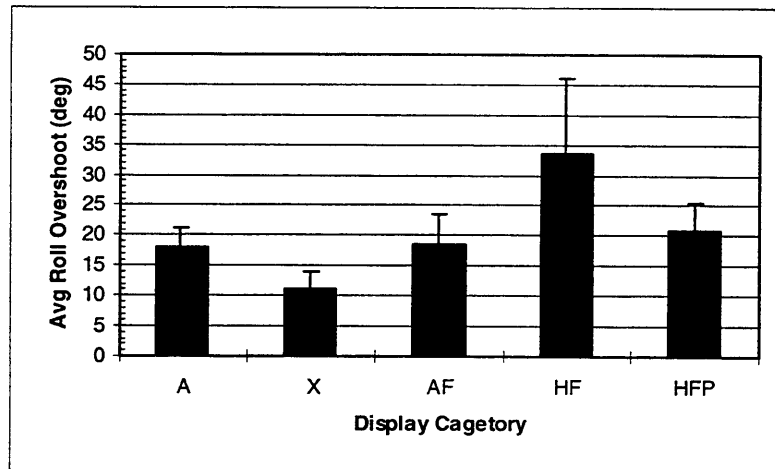
**Average Roll Overshoot (10-30) (Error bars: 1  $\sigma$  of estimate of mean)**



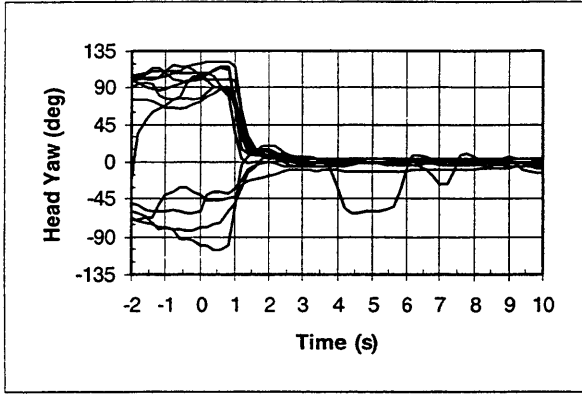
**Average Roll Overshoot (10-60) (Error bars: 1  $\sigma$  of estimate of mean)**



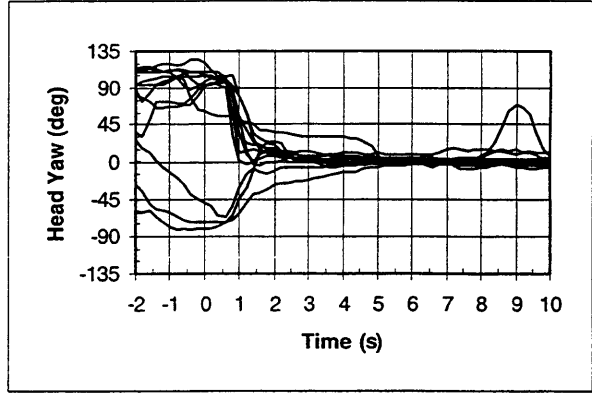
**Average Roll Overshoot (20-30) (Error bars: 1  $\sigma$  of estimate of mean)**



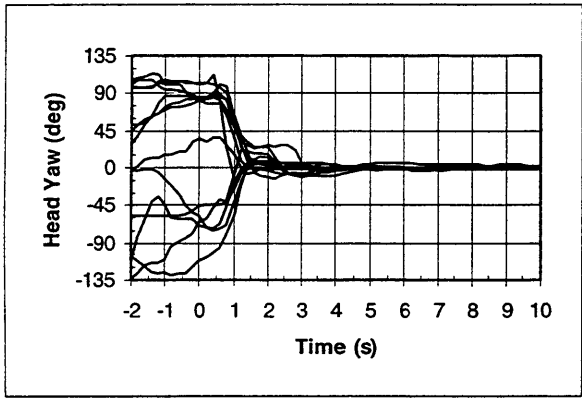
**Average Roll Overshoot (20-60) (Error bars: 1  $\sigma$  of estimate of mean)**



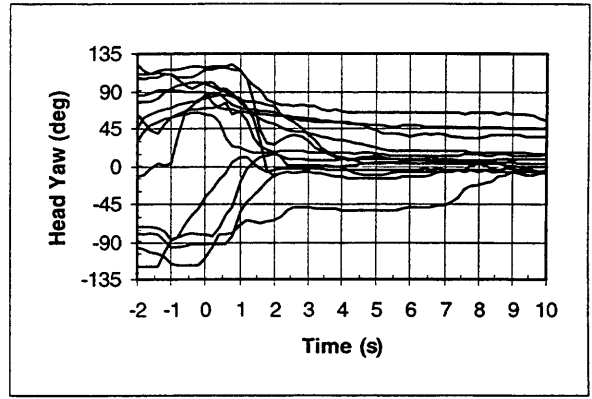
**Head Yaw Histories (A - 10-30)**



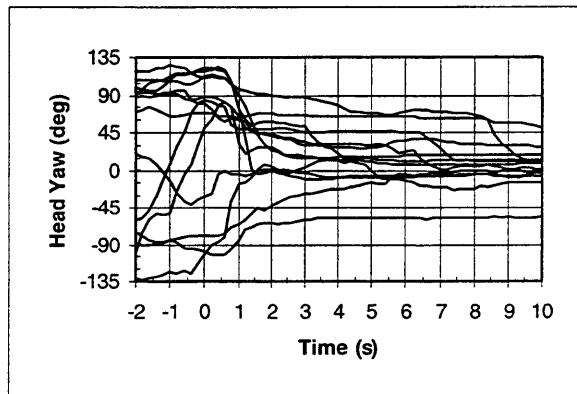
**Head Yaw Histories (X - 10-30)**



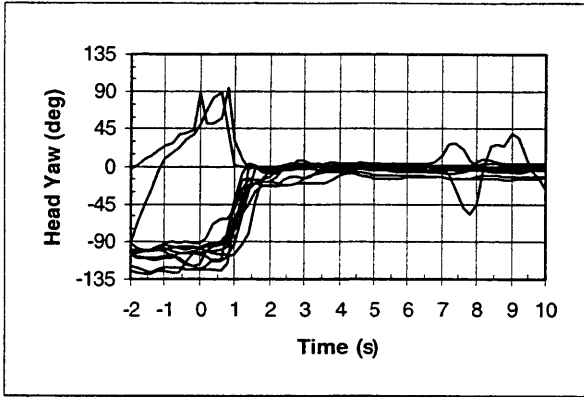
**Head Yaw Histories (AF - 10-30)**



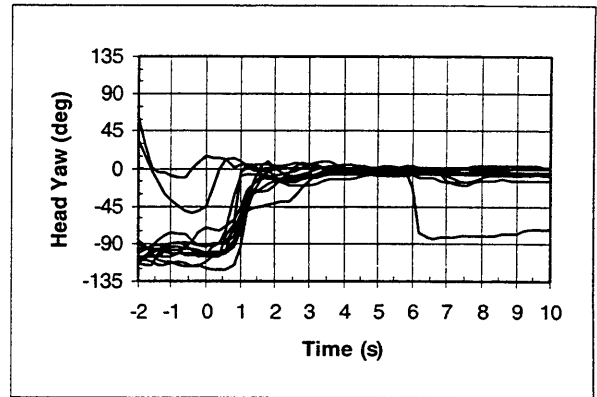
**Head Yaw Histories (HF - 10-30)**



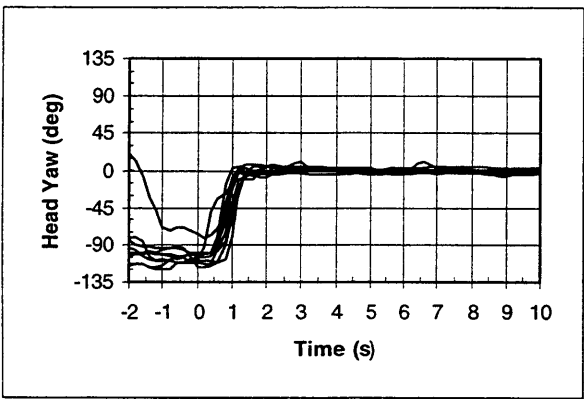
**Head Yaw Histories (HFP - 10-30)**



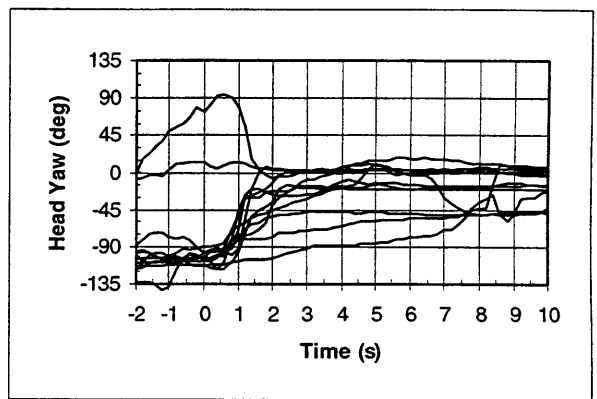
**Head Yaw Histories (A - 10-60)**



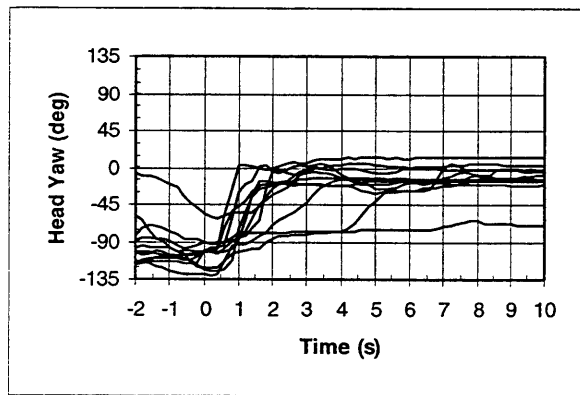
**Head Yaw Histories (X - 10-60)**



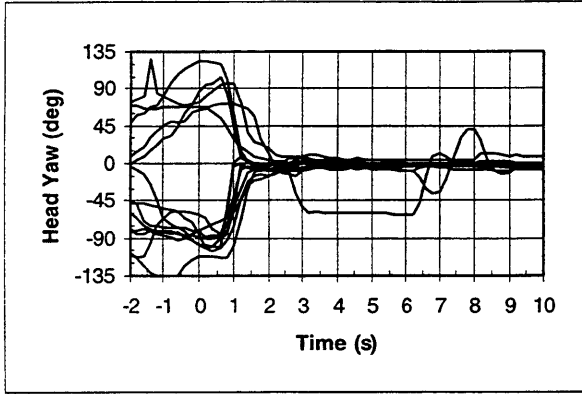
**Head Yaw Histories (AF - 10-60)**



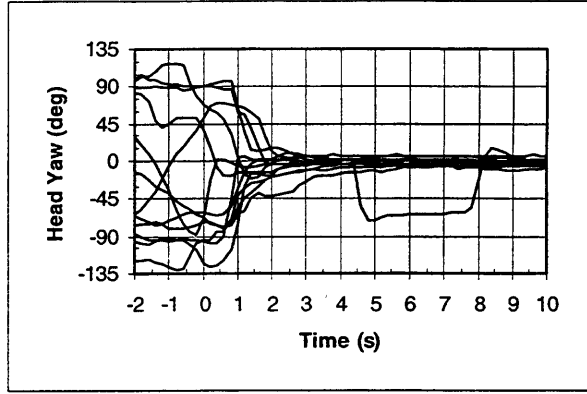
**Head Yaw Histories (HF - 10-60)**



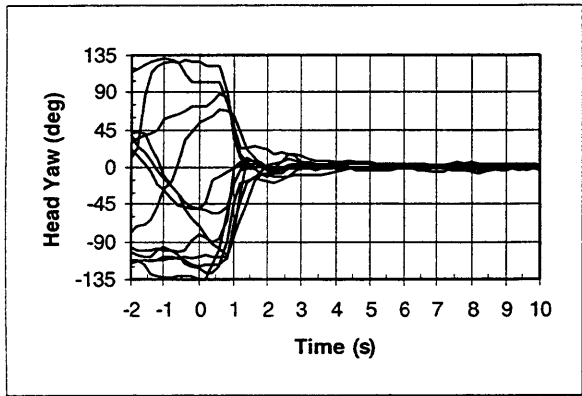
**Head Yaw Histories (HFP - 10-60)**



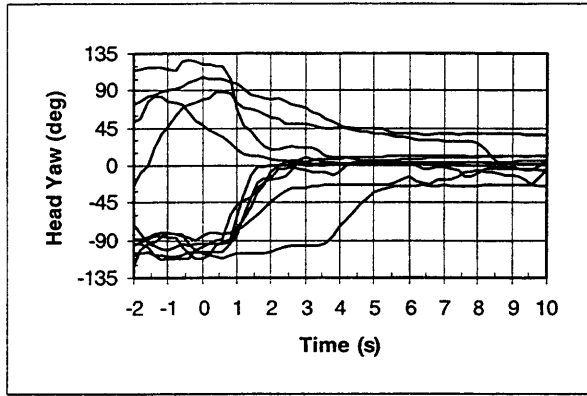
**Head Yaw Histories (A - 20-30)**



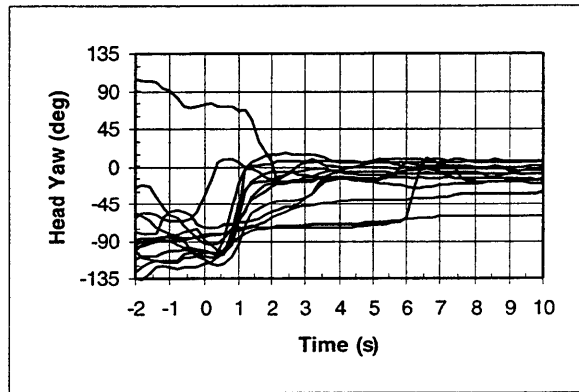
**Head Yaw Histories (X - 20-30)**



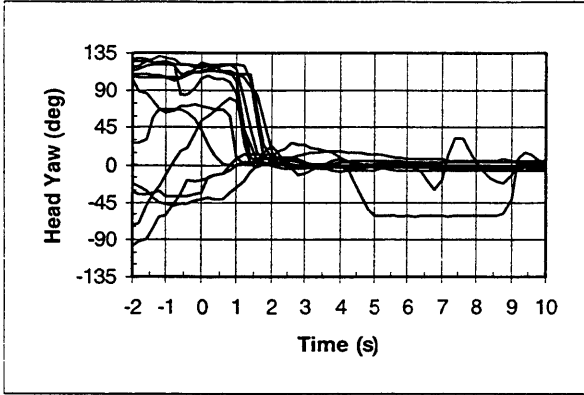
**Head Yaw Histories (AF - 20-30)**



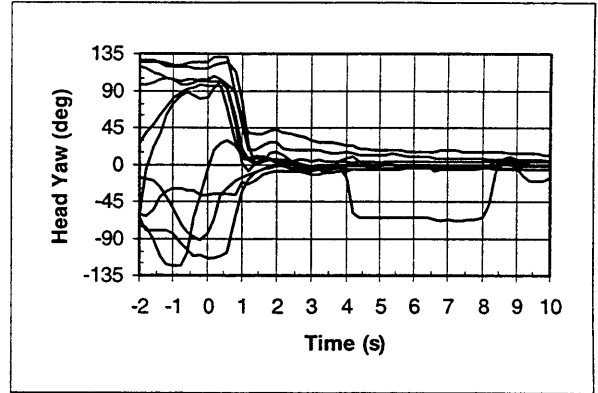
**Head Yaw Histories (HF - 20-30)**



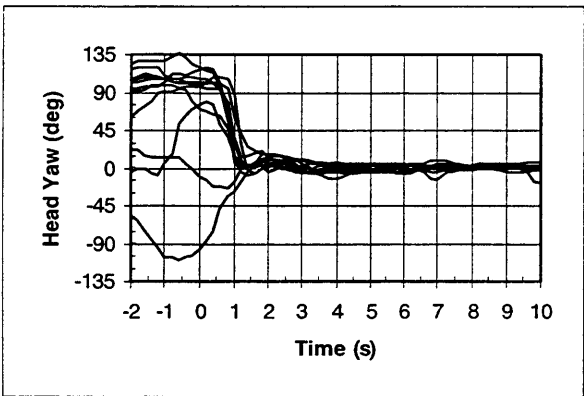
**Head Yaw Histories (HFP - 20-30)**



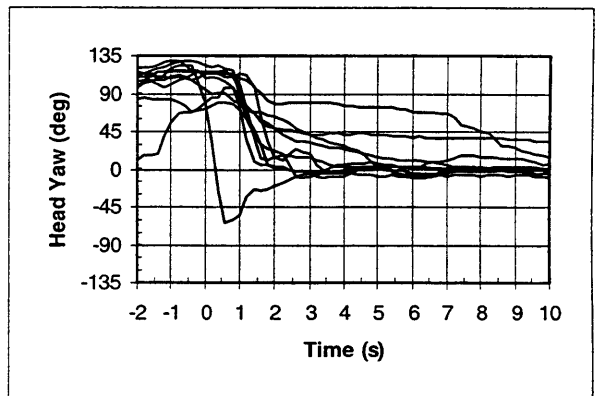
**Head Yaw Histories (A - 20-60)**



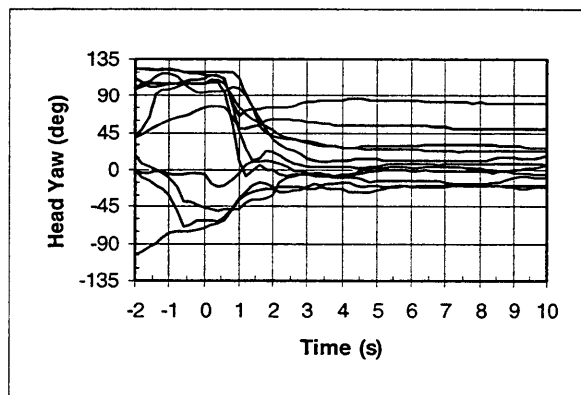
**Head Yaw Histories (X - 20-60)**



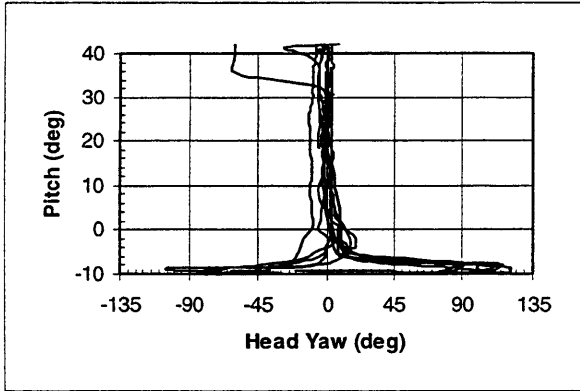
**Head Yaw Histories (AF - 20-60)**



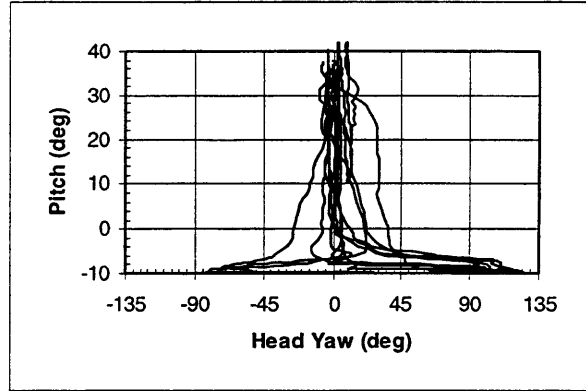
**Head Yaw Histories (HF - 20-60)**



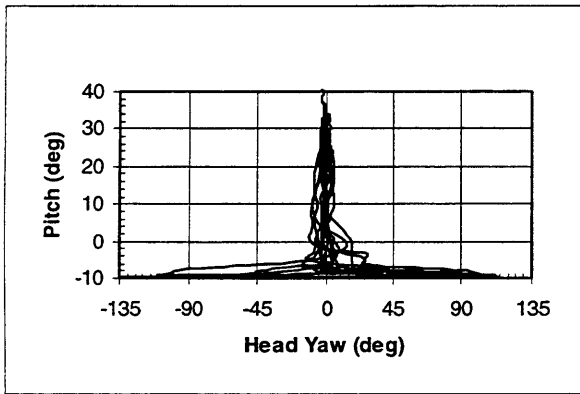
**Head Yaw Histories (HFP - 20-60)**



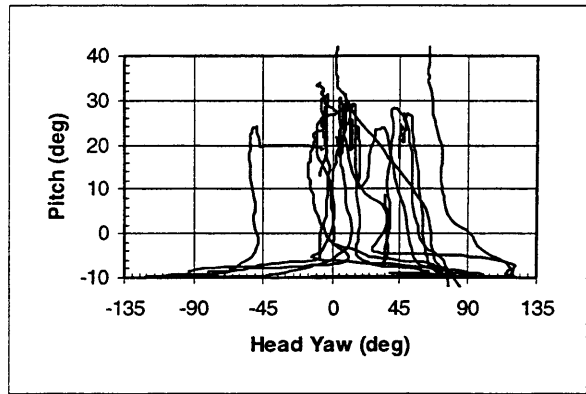
**Aircraft Pitch vs. Head Yaw (A - 10-30)**



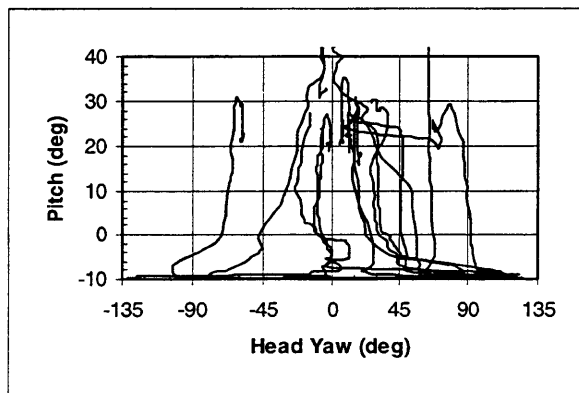
**Aircraft Pitch vs. Head Yaw (X - 10-30)**



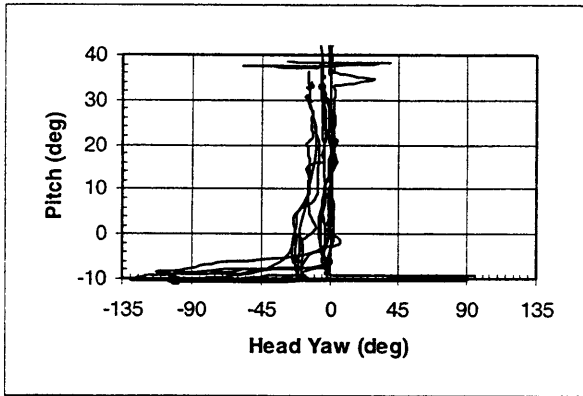
**Aircraft Pitch vs. Head Yaw (AF - 10-30)**



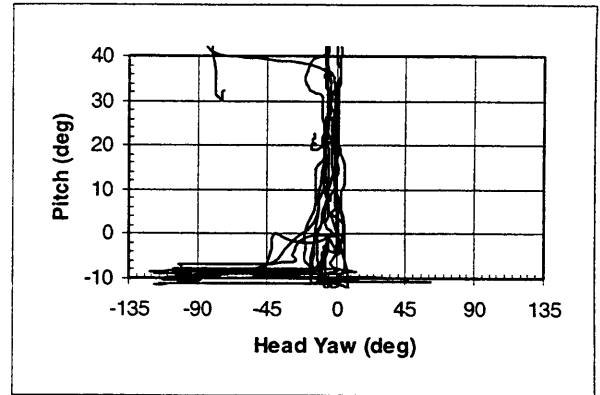
**Aircraft Pitch vs. Head Yaw (HF - 10-30)**



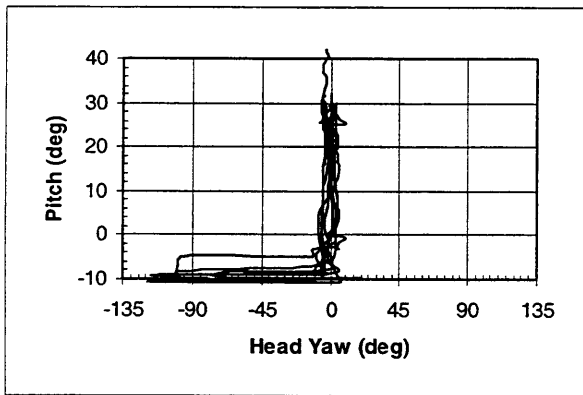
**Aircraft Pitch vs. Head Yaw (HFP - 10-30)**



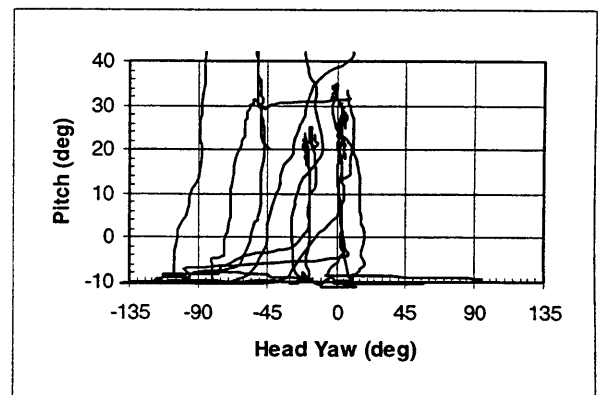
**Aircraft Pitch vs. Head Yaw (A - 10-60)**



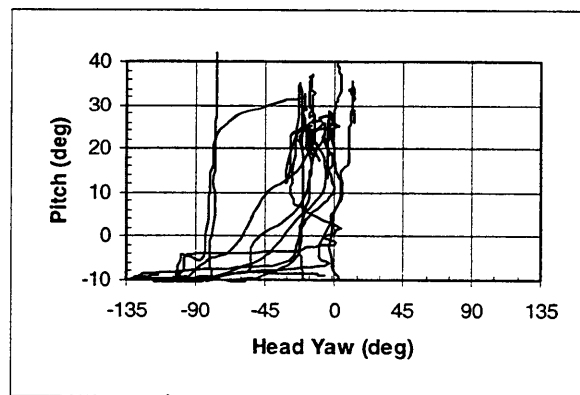
**Aircraft Pitch vs. Head Yaw (X - 10-60)**



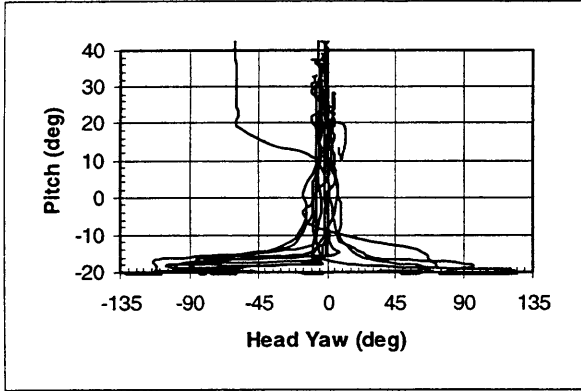
**Aircraft Pitch vs. Head Yaw (AF - 10-60)**



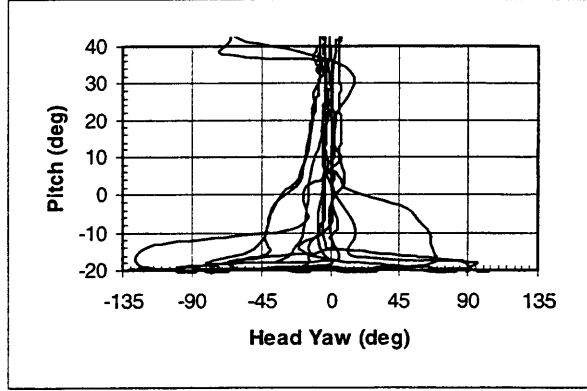
**Aircraft Pitch vs. Head Yaw (HF - 10-60)**



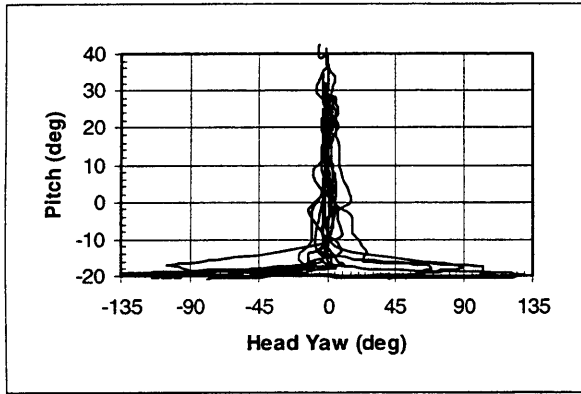
**Aircraft Pitch vs. Head Yaw (HFP - 10-60)**



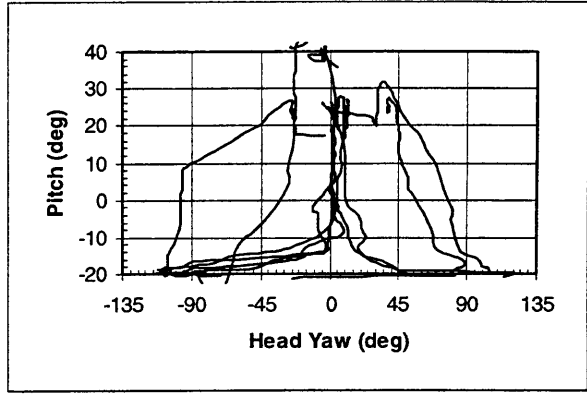
**Aircraft Pitch vs. Head Yaw (A - 20-30)**



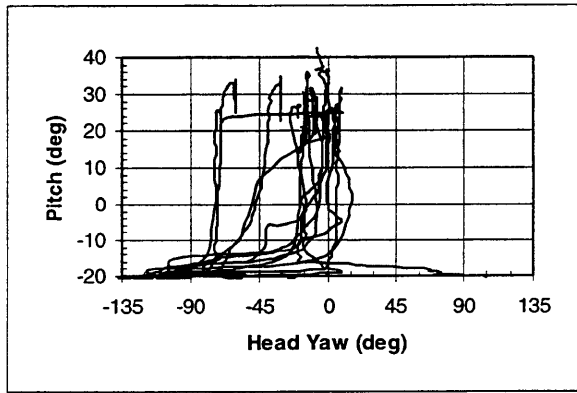
**Aircraft Pitch vs. Head Yaw (X - 20-30)**



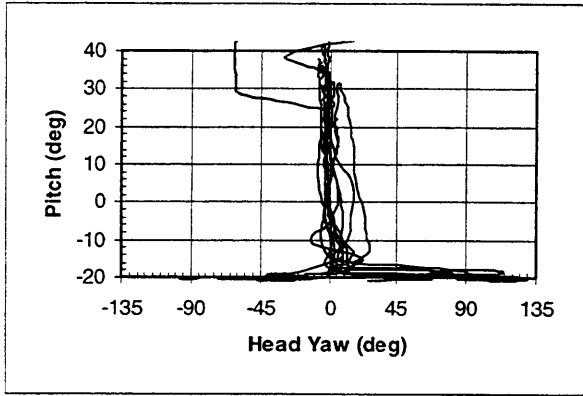
**Aircraft Pitch vs. Head Yaw (AF - 20-30)**



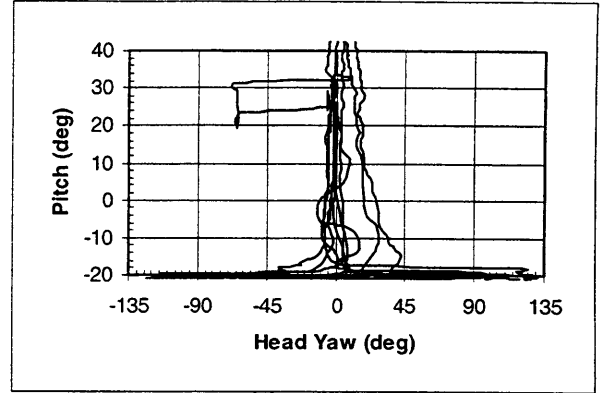
**Aircraft Pitch vs. Head Yaw (HF - 20-30)**



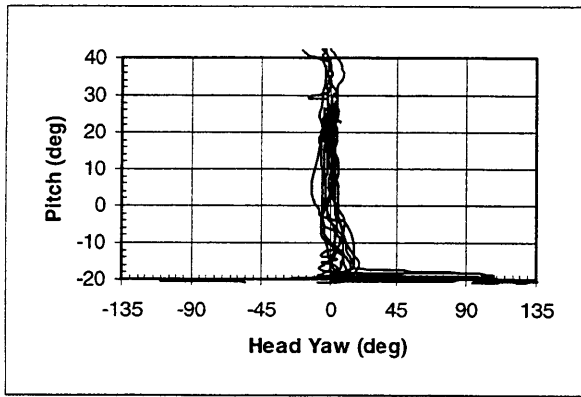
**Aircraft Pitch vs. Head Yaw (HFP - 20-30)**



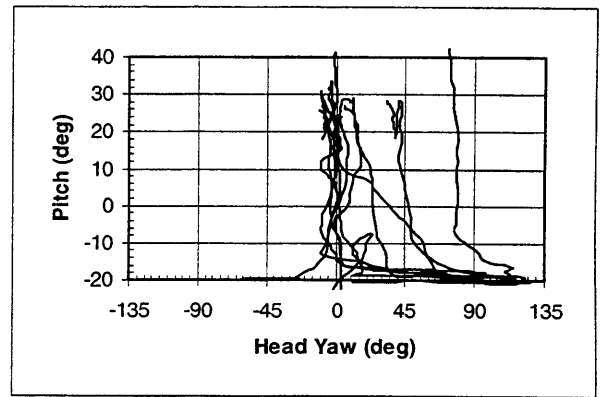
**Aircraft Pitch vs. Head Yaw (A - 20-60)**



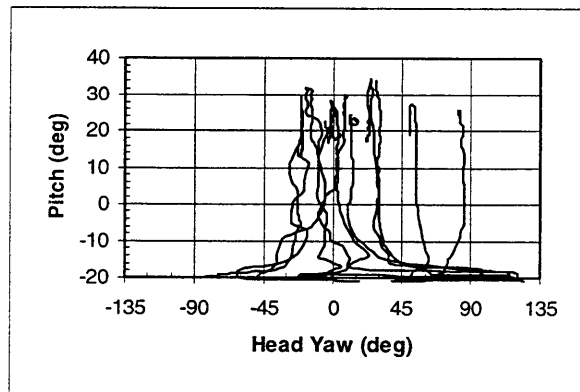
**Aircraft Pitch vs. Head Yaw (X - 20-60)**



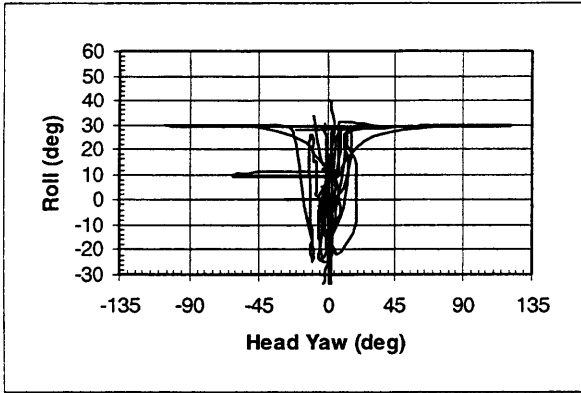
**Aircraft Pitch vs. Head Yaw (AF - 20-60)**



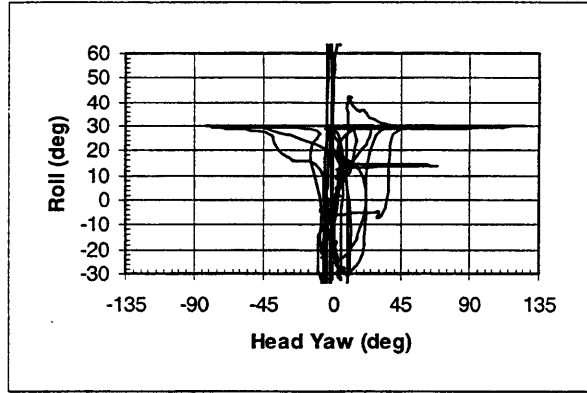
**Aircraft Pitch vs. Head Yaw (HF - 20-60)**



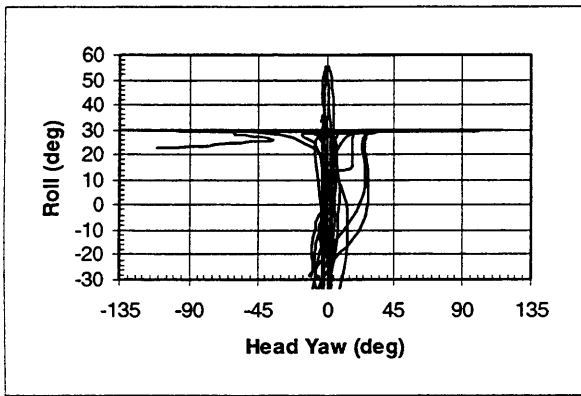
**Aircraft Pitch vs. Head Yaw (HFP - 20-60)**



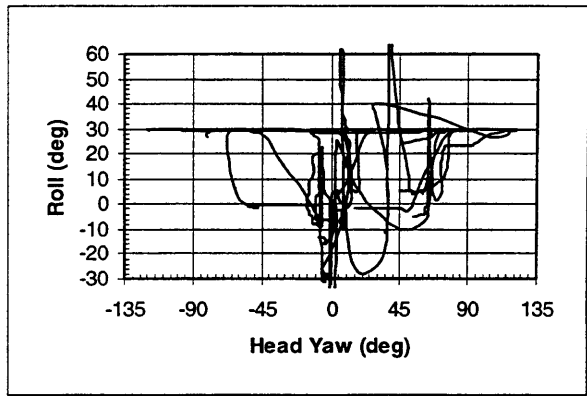
**Aircraft Roll vs. Head Yaw (A - 10-30)**



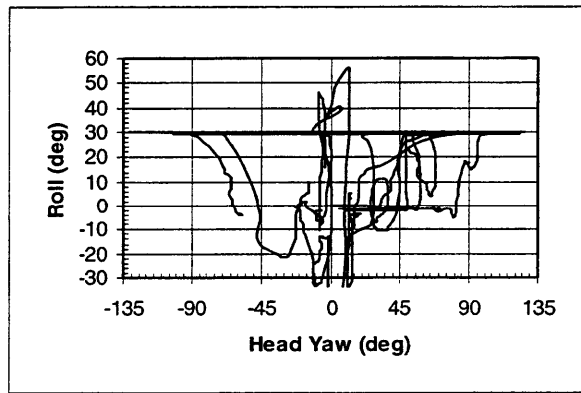
**Aircraft Roll vs. Head Yaw (X - 10-30)**



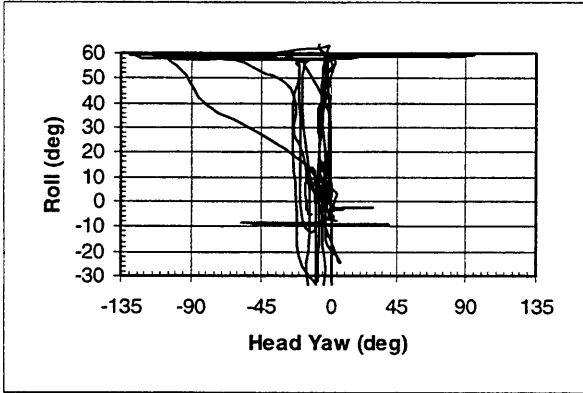
**Aircraft Roll vs. Head Yaw (AF - 10-30)**



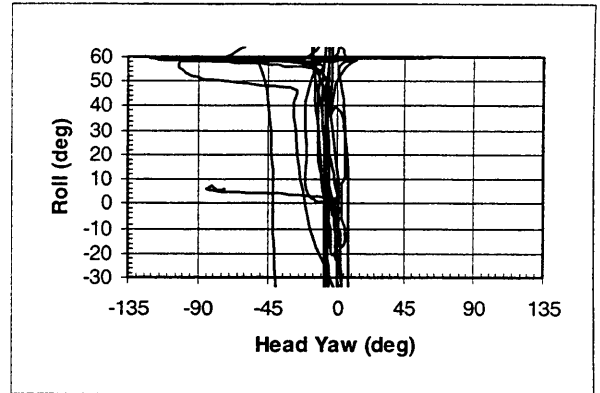
**Aircraft Roll vs. Head Yaw (HF - 10-30)**



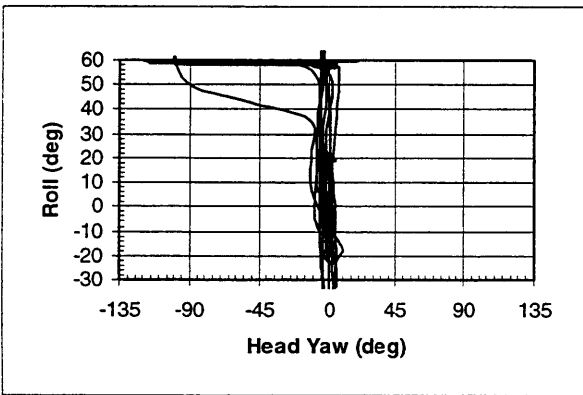
**Aircraft Roll vs. Head Yaw (HFP - 10-30)**



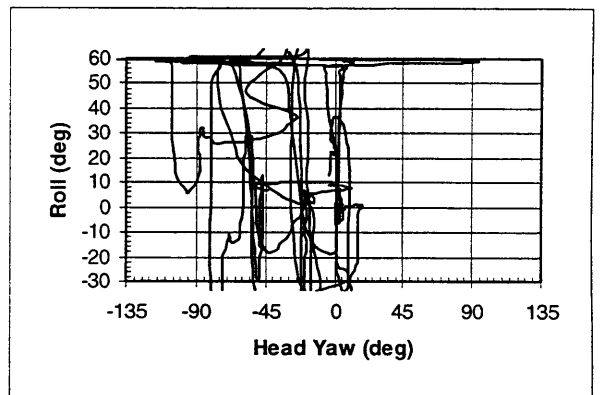
**Aircraft Roll vs. Head Yaw (A - 10-60)**



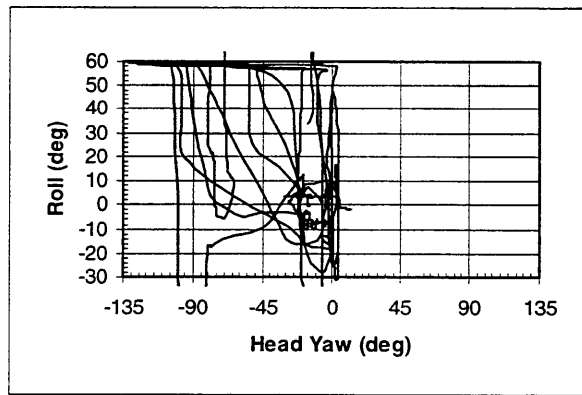
**Aircraft Roll vs. Head Yaw (X - 10-60)**



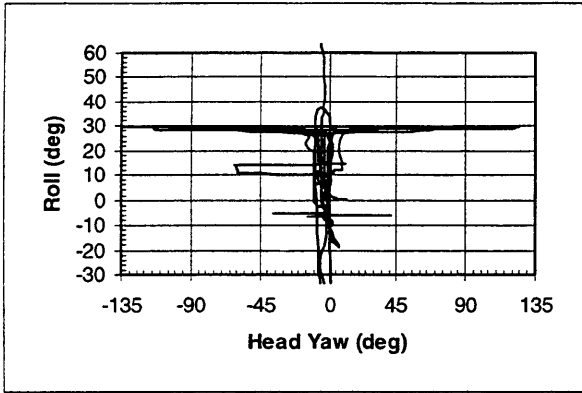
**Aircraft Roll vs. Head Yaw (AF - 10-60)**



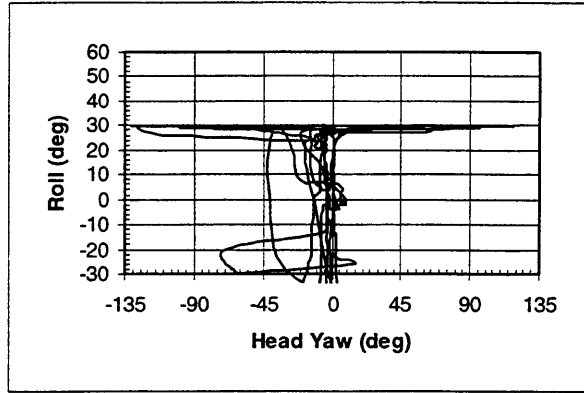
**Aircraft Roll vs. Head Yaw (HF - 10-60)**



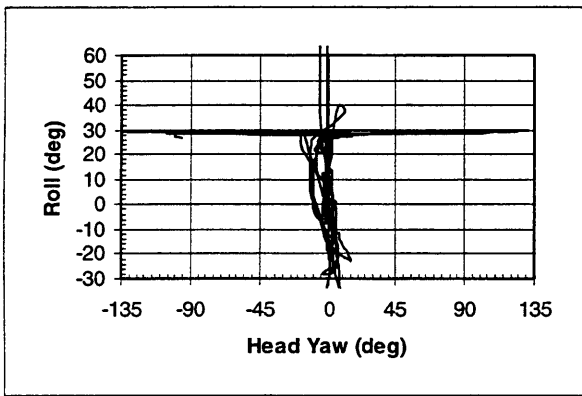
**Aircraft Roll vs. Head Yaw (HFP - 10-60)**



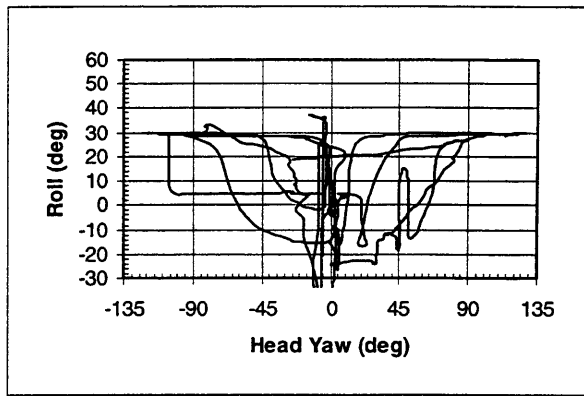
**Aircraft Roll vs. Head Yaw (A - 20-30)**



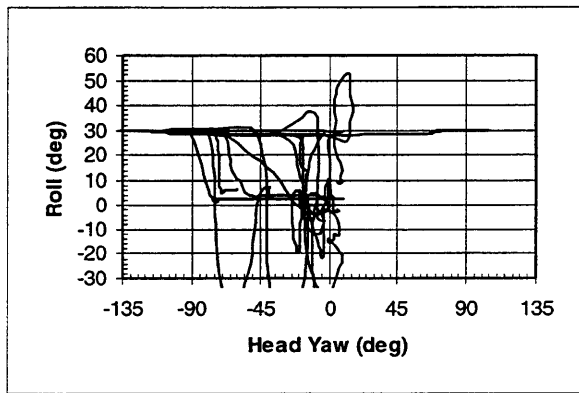
**Aircraft Roll vs. Head Yaw (X - 20-30)**



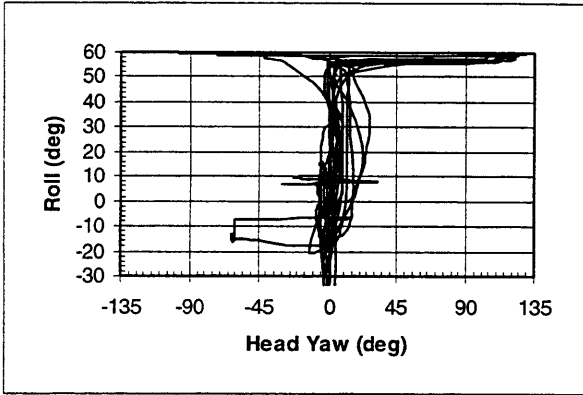
**Aircraft Roll vs. Head Yaw (AF - 20-30)**



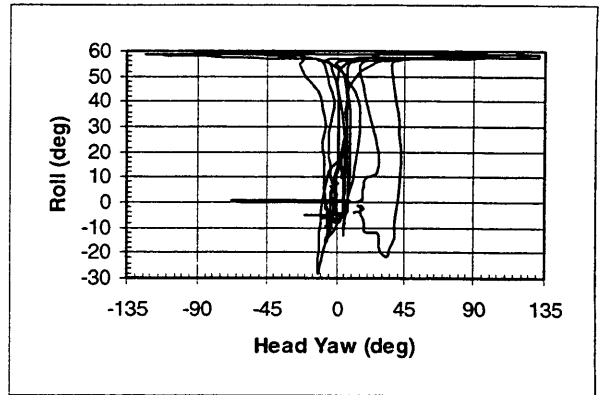
**Aircraft Roll vs. Head Yaw (HF - 20-30)**



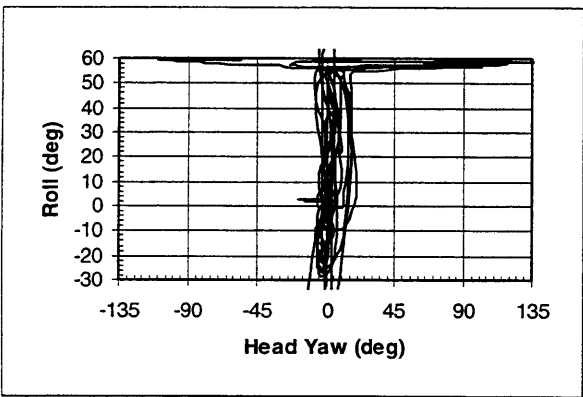
**Aircraft Roll vs. Head Yaw (HFP - 20-30)**



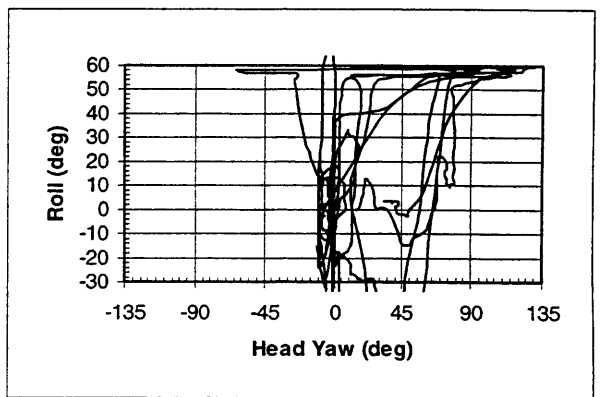
**Aircraft Roll vs. Head Yaw (A - 20-60)**



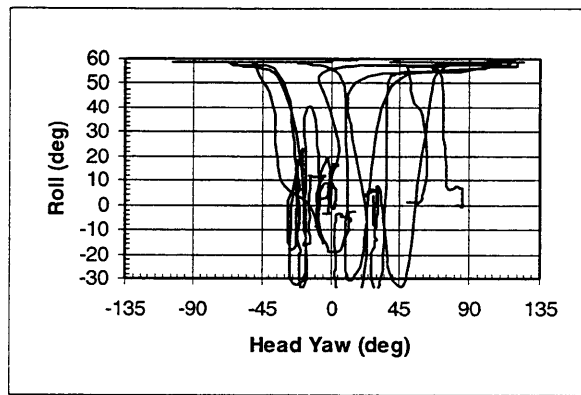
**Aircraft Roll vs. Head Yaw (X - 20-60)**



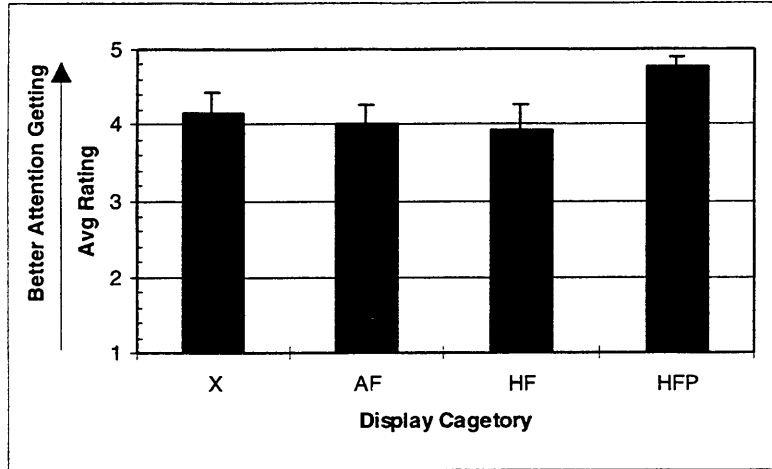
**Aircraft Roll vs. Head Yaw (AF - 20-60)**



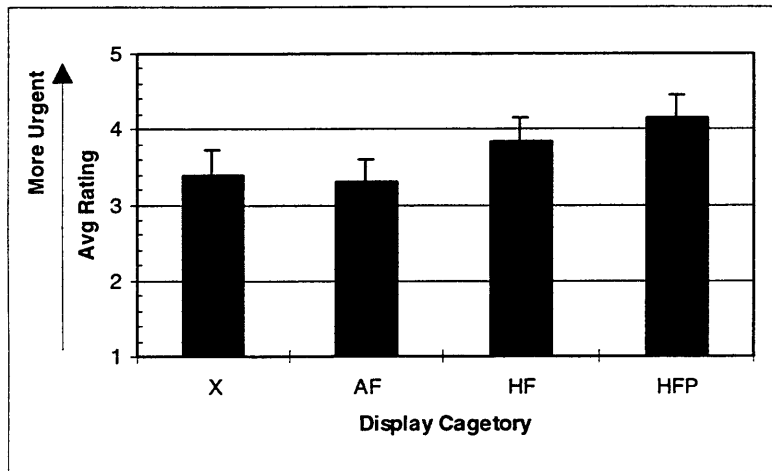
**Aircraft Roll vs. Head Yaw (HF - 20-60)**



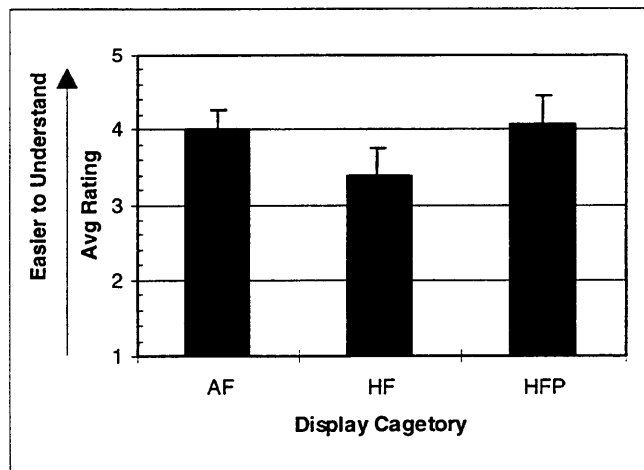
**Aircraft Roll vs. Head Yaw (HFP - 20-60)**



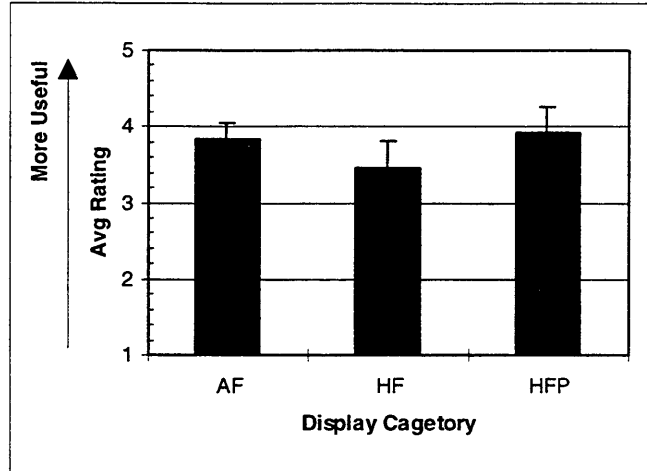
**Average Ratings of Attention-Getting (Error bars: 1  $\sigma$  of estimate of mean)**



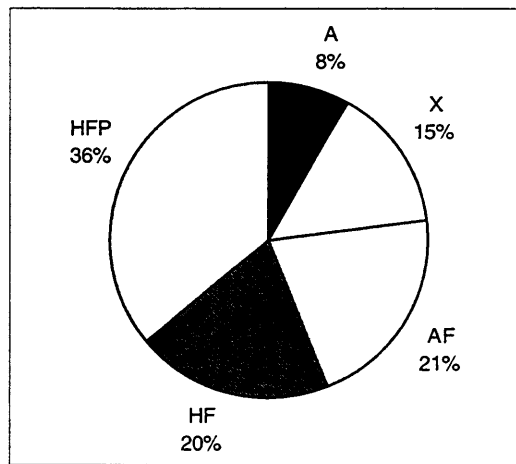
**Average Ratings of Urgency (Error bars: 1  $\sigma$  of estimate of mean)**



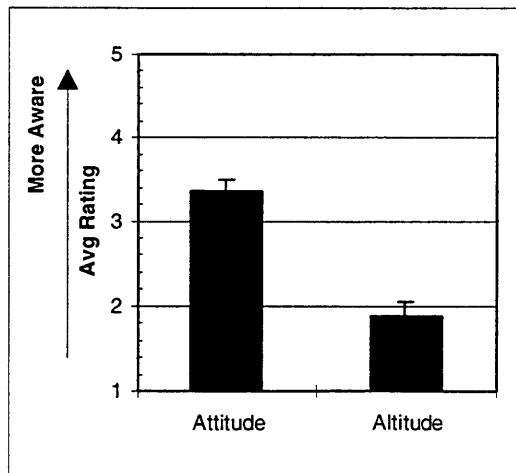
**Average Ratings of Information Understandability (Error bars: 1  $\sigma$  of estimate of mean)**



Average Ratings of Information Usefulness (Error bars: 1  $\sigma$  of estimate of mean)



Overall Display Preference



Average Attitude and Altitude Awareness Ratings (Error bars: 1  $\sigma$  of estimate of mean)

9 1-1