

# Excavation Materials Handling in the Loetschberg Base Tunnel using Decision Aids for Tunneling (DAT)

by

**Christina Kollarou**

Diploma, Mining and Metallurgical Engineering (2000)  
National Technical University of Athens, Greece

Submitted to the Department of Civil and Environmental Engineering  
in Partial Fulfillment of the Requirements for the degree of  
Master of Science in Civil and Environmental Engineering

at the

Massachusetts Institute of Technology  
June 2002

© 2002 Massachusetts Institute of Technology  
All rights reserved

Signature of Author.....

.....  
Department of Civil and Environmental Engineering  
May 10, 2002

Certified by.....

.....  
Prof. Herbert H. Einstein  
Professor of Civil and Environmental Engineering  
Thesis Supervisor

Accepted by.....

.....  
Prof. Oral Buyukozturk  
Chairman, Departmental Committee on Graduate Studies

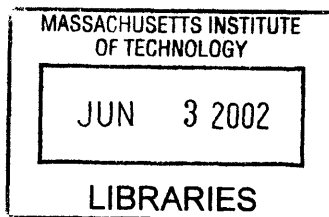

BARKER



# **Excavation Materials Handling in the Loetschberg Base Tunnel using Decision Aids for Tunneling (DAT)**

by

**Christina Kollarou**

Submitted to the Department of Civil and Environmental Engineering  
on May 10, 2002 in Partial Fulfillment of the  
Requirements for the degree of Master of Science in  
Civil and Environmental Engineering

## **Abstract**

A major problem in tunneling is that most decisions must be made under conditions of uncertainty. A significant contribution to help with such decisions was the development of the Decision Aids for Tunneling (DAT). The DAT are based on probabilistic analysis and allow the user to quantify uncertainties by mathematical modeling. Although the DAT have been used for many major tunnel projects they have never been used to simulate the resources management of an actual project.

Therefore the Southern Part of the Loetschberg Base tunnel, which is in fact a complex tunnel network, consisting of seven different tunnels, approximately 40 Km long was selected in order to apply the resources model of the DAT.

Many different simulation scenarios were run which prove that taking into account an additional factor, which in this case is the excavated materials, during planning may lead to quite different decisions. The results of the materials management simulations can contribute to the design of a tunnel project through optimization of the tunnel operations.

Thesis Supervisor: Herbert H. Einstein  
Title: Professor of Civil and Environmental Engineering



στο Μιχάλη μου,

## Acknowledgments

I would like to thank all the people who helped me during this research.

Prof. Herbert H. Einstein: *“It was a pleasure working with you. Thank you for supervising this work and providing me with valuable suggestions”*.

Cedric Marzer: *“I finally made it. Thank you for coding MBK and discussing with me several issues of this research”*.

Claude Indermitte: *“Thank you for helping me run the simulations and for your immediate responses”*.

Petros Boufounos: *“Thank you helping me with all the computer problems”*.

I would also like to thank my friends Georgios Constantinides, Petros Boufounos and Theodoros Konstantakopoulos. *“I am very pleased to meet you all. Thank you for being my friends and sharing with me this unique experience”*.

# Table of Contents

<b>Table of Contents .....</b>	<b>7</b>
<b>List of Figures and Tables .....</b>	<b>11</b>
<b>Chapter 1 Introduction.....</b>	<b>19</b>
Tunneling and Underground Operations.....	19
Problem Definition and Objectives.....	19
Thesis Outline .....	20
<b>Chapter 2 The Loetschberg Project .....</b>	<b>21</b>
Switzerland’s Public Transport Network Solution .....	21
The Loetschberg Tunnel Overview.....	23
The Tunnel Design.....	26
The Tunnel Geology .....	27
Construction Concept.....	29
<i>Excavation Methods.....</i>	<i>31</i>
1.The Tunnel Boring Machine (TBM).....	31
2. Drilling & Blasting.....	32
<i>Support of the Tunnels .....</i>	<i>34</i>
Initial Support.....	34
Final Support.....	35
Support Details in the TBM Excavation .....	36
Support Details in the Drill & Blast Excavation.....	36
<b>Chapter 3 The Loetschberg base Tunnel and DAT .....</b>	<b>37</b>
Geology and SIMSUPER’ s Input .....	37
Loetschberg Base Tunnel Simulation Output .....	40
<b>Chapter 4 Materials Management for the Loetschberg Base Tunnel.....</b>	<b>47</b>
Materials Resources .....	47
Excavation Materials’ Categories .....	50
<i>Main Excavation Materials Categories .....</i>	<i>50</i>
<i>Alkali Reactive materials .....</i>	<i>50</i>
<i>Extended Excavation Materials Categories.....</i>	<i>51</i>

Concrete and Aggregates .....	52
Aggregates and Concrete Production.....	52
<b>Chapter 5 Assumptions Made and Techniques Used .....</b>	<b>55</b>
Excavation Materials Categories Used for the Simulations.....	55
Repositories Used for the Simulations.....	56
Simulations Techniques and Assumptions Made .....	57
<b>Chapter 6 MBK Interface .....</b>	<b>61</b>
Creating a data file with MBK .....	62
<i>Materials in MBK</i> .....	62
<i>Repositories in MBK</i> .....	63
<i>Tunnels in MBK</i> .....	64
<i>Flows in MBK</i> .....	70
<b>Chapter 7 Data Input for the materials management of the Loetschberg BaseTunnel ..</b>	<b>75</b>
Resources Data.....	75
<i>Excavation Resources</i> .....	75
<i>Aggregates Resources</i> .....	75
<i>Support Resources</i> .....	76
<i>Auxiliary Resources</i> .....	76
Resources named “progressX” .....	76
Resources named “ShotcreteXstop” .....	77
Resources named “LiningproX” .....	77
Repositories Data .....	79
<i>Repositories at the Exit of the Tunnels</i> .....	80
<i>Repositories at the Plants</i> .....	80
<i>Final Repository</i> .....	80
Tunnel Data.....	83
<i>10 Raron DB Tunnel</i> .....	84
Calculations and Markov Transition Matrices .....	86
Flows Data .....	91
1) <i>Flows Originate from the Tunnel Repositories and Terminate at the Aggregates</i>	
<i>Plant Repository</i> .....	93

2) <i>Flows within Aggregates Plant Repository</i> .....	94
3) <i>Flows from Aggregates Plant Repository too Concrete Plant Repository</i> .....	96
4) <i>Flows terminate to the Final Repository</i> .....	98
5) <i>Flows of the “LiningProX” and “ShotcreteXstop” types of resources</i> .....	99
6) <i>Flows for shotcrete and concrete transportation</i> .....	99
<b>Chapter 8 The New Simulations of the South Part of the Loetschberg Base Tunnel...</b>	<b>101</b>
Simulations without Reusing the Resources .....	101
Simulations Reusing the Resources .....	113
<i>Simulation A Results</i> .....	114
<i>Simulation B Results</i> .....	129
<i>Simulation C Results</i> .....	135
<i>Simulation A1 Results</i> .....	142
<i>Simulation A2 Results</i> .....	145
<b>Chapter 9 A System Dynamics Approach in Tunneling</b> .....	<b>149</b>
System Dynamics Concept .....	149
<i>Steps of SD modeling</i> .....	150
System Dynamics in Tunneling .....	151
<b>Chapter 10 Conclusions and Perspectives</b> .....	<b>155</b>
Conclusions drawn from the Simulations .....	155
General Conclusions .....	156
Future Research and Development .....	156
<b>Appendix A Initial Support Profiles</b> .....	<b>159</b>
<b>Appendix B Tunnel Input Data</b> .....	<b>169</b>
<i>9 Raron TBM Tunnel</i> .....	170
Calculations and Markov Transition Matrices .....	173
<i>8 Steg Access TBM Tunnel</i> .....	178
Calculations and Markov Transition Matrices .....	181
<i>11 Steg TBM Tunnel</i> .....	185
Calculations and Markov Transition Matrices .....	188
<i>6 Ferden SE and 7 Ferden SW Drill &amp; Blast Tunnels</i> .....	192
Calculations and Markov Transition Matrices .....	194

<i>5 Ferden NW and 4 Ferden NE Drill &amp; Blast Tunnels</i> .....	197
Calculations and Markov Transition Matrices.....	199
<b>Appendix C Cross- Section Markov Transition Matrices</b> .....	<b>203</b>
<b>Bibliography</b> .....	<b>209</b>

## List of Figures and Tables

Figure 1. Switzerland’s future rail network .....	21
Figure 2. The AlpTransit Project .....	23
Figure 3. AlpTransit in the Switzerland’s network <sup>4</sup> .....	24
Figure 4. Loetschberg Base Tunnel <sup>4</sup> .....	25
Figure 5. The Project overview <sup>4</sup> .....	26
Figure 6. Geological cross section of the Loetschberg Base Tunnel <sup>4</sup> .....	28
Figure 7. The Construction Concept <sup>4</sup> .....	30
Figure 8. The Loetschberg’s TBM.....	31
Figure 9. Drilling & Blasting Method.....	33
Figure 10. Excavation in Ferden .....	33
Figure 11 Typical Rock Support Profile (Drilling & Blasting) .....	34
Figure 12. Final Support Profile (Drilling & Blasting).....	35
Figure 13. The Southern Loetschberg Tunnel Network.....	37
Figure 14. Tunnel 10 Raron DB Time/ Position Graph after 100 Simulations .....	41
Figure 15. Tunnel 9 Raron TBM and 6 Ferden DB Time/ Position Graph after 100 Simulations.....	42
Figure 16. Tunnel 8 StegAccess TBM, 11 Steg TBM and 7 Ferden DB Time/ Position Graph after 100 Simulations .....	43
Figure 17. Tunnel 5 Ferden DB Time/ Position Graph after 100 Simulations .....	44
Figure 18. Tunnel 4 Ferden DB Time/ Position Graph after 100 Simulations .....	45
Figure 19. View of the aggregates and concrete plant at Raron .....	47
Figure 20. Materials Management Flow Net .....	48
Figure 21. Repositories Layout.....	49
Figure 22. Cracking patterns resulting from ASR .....	51

Figure 23. K1 Excavation Materials Flow .....	52
Figure 24. Repositories used for the Materials Management Simulations. ....	56
Figure 25. From MBK to SIMSUPER data files .....	61
Figure 26. Units used in every stage of the simulation .....	62
Figure 27. MBK Materials Input Window .....	63
Figure 28. MBK Repositories Input Window .....	63
Figure 29. Geology as introduced .....	64
Figure 30. Result of a geological simulation .....	65
Figure 31. MBK Tunnel Input Windows-Cross Sections-Difficult Cross sections and Difficult Geological Zones .....	68
Figure 32. MBK Tunnel Input Windows- Geological Zones .....	69
Figure 33. Presentation of a Flow .....	70
Figure 34. Flow window in MBK inreface .....	71
Figure 35. Aggregates Production Information Flow Window .....	72
Figure 36. A Flow between two Different Repositories .....	73
Figure 37. Resources Used in the Loetschberg Base Tunnel Simulation .....	78
Figure 38. MBK vs. SIMSUPER Repositories .....	79
Figure 39. Raron DB Repository .....	81
Figure 40. Raron TBM Repository .....	81
Figure 41. Steg DB Repository .....	81
Figure 42. Ferden DB Repository .....	81
Figure 43. Aggregates Plant Repository .....	82
Figure 44. Concrete Plant Repository .....	82
Figure 45. Final Repository.....	82
Figure 46. Tunnels use for the simulation.....	83
Figure 47. 10 Raron DB MBK Tunnel Window.....	85

Figure 48. Geologic Zones 1-7 of the 10 Raron DB Tunnel..... 89

Figure 49. Geologic Zones 7-11 of the 10 Raron DB Tunnel..... 89

Figure 50. Difficult Zones in 10 Raron DB Tunnel ..... 90

Figure 51. Graphical Representation of the flows used for the simulation of the South Part of the Loetschberg Base Tunnel ..... 91

Figure 52. Flows MBK Window for the South Part of the Loetschberg Base Tunnel ..... 92

Figure 53. Raron K1 DB to Aggregates Plant Flow Information Window ..... 94

Figure 54. K1DBtransf Flow Information Window..... 96

Figure 55. K1TBMtransf Flow Information Window..... 96

Figure 56. Aggregates to Shotcrete Flow Information Window..... 98

Figure 57. Aggregates to Concrete Flow Information Window ..... 98

Figure 58. Shotcrete Transportation Flow Information Window..... 100

Figure 59. Concrete Transportation Flow Information Window ..... 100

Figure 60. “New” Tunnel 10 Raron DB Time/ Position Graph after 100 Simulations ..... 104

Figure 61. “New” Tunnels 9 Raron TBM and 6 Ferden DB Time/ Position Graph after 100 Simulations..... 105

Figure 62. “New” Tunnels 8 StegAccess TBM, 11 Steg TBM and 7 Ferden DB Time/ Position Graph after 100 Simulations ..... 106

Figure 63. “New” Tunnel 5 Ferden DB Time/ Position Graph after 100 Simulations ..... 107

Figure 64. “New” Tunnel 4 Ferden DB Time/ Position Graph after 100 Simulations ..... 108

Figure 65. “**Example**” Simulation Results of the Excavation Materials at the Raron DB Repository ..... 109

Figure 66. “**Example**” Simulation Results of the Excavation Materials at the Raron TBM Repository ..... 110

Figure 67. “**Example**” Simulation Results of the Excavation Materials at the Steg TBM Repository ..... 111

Figure 68. “**Example**” Simulation Results of the Excavation Materials at Ferden DB Repository ..... 112

Figure 69. <b>Scenario A</b> “Example” Simulation Results for the Excavation and the Initial Support of the Tunnels.....	115
Figure 70. <b>Scenario A</b> “Example” Simulation Results for the Excavation, the Initial and the Final Support of the Tunnels.....	116
Figure 71. <b>Scenario A</b> “Example” Simulation Results of the Aggregates for Shotcrete at the Aggregates Plant Repository.....	122
Figure 72. <b>Scenario A</b> “Example” Simulation Results of the Aggregates for Concrete at the Aggregates Plant Repository.....	123
Figure 73. <b>Scenario A</b> “Example” Simulation Results of the K2 Stock .....	124
Figure 74. <b>Scenario A</b> “Example” Simulation Results of the K1ar TBM Stock .....	125
Figure 75. <b>Scenario A</b> “Example” Simulation Results of the KuDB, Ku TBM and KuAgg Material Stocks in the Final Repository.....	126
Figure 76. <b>Scenario A</b> “Example” Simulation Results of the Concrete Stock at the Raron DB Repository .....	127
Figure 77. <b>Scenario A</b> “Example” Simulation Results of the Shotcrete Stock at the Raron DB Repository .....	128
Figure 78. <b>Scenario B</b> “Example” Simulation Results of the Excavation and the Initial Support of the Tunnels.....	130
Figure 79. <b>Scenario B</b> “Example” Simulation Results of the Excavation, the Initial and the Final Support of the Tunnels.....	131
Figure 80. <b>Scenario B</b> “Example” Simulation Results of the K1ar DB Stock.....	133
Figure 81. <b>Scenario B</b> “Example” Simulation Results of the Final Repository Stocks.....	134
Figure 82. <b>Scenario C</b> “Example” Simulation Results for Excavation and Initial Support of the Tunnels.....	136
Figure 83. <b>Scenario C</b> “Example” Simulation Results for the Excavation, the Initial and the Final Support of the Tunnels.....	137
Figure 84. <b>Scenario C</b> “Example” Simulation Results for the Aggregates for Concrete Stocks .....	140
Figure 85. <b>Scenario C</b> “Example” Simulation Results of the KuDB, KuTBM and KUAgg in the Final Repository Stock.....	141
Figure 86. <b>Scenario A1</b> “Example” Simulation Results for the Excavation, the Initial and the Final Support of the Tunnels.....	143

Figure 87. <b>Scenario A2</b> “Example” Simulation Results for the Excavation, the Initial and the Final Support of the Tunnels.....	147
Figure A-1. Drill & Blast Profile ESA1 .....	161
Figure A-2. Drill & Blast Profile ESA2.....	162
Figure A-3. Drill & Blast Profile ESA3a .....	163
Figure A-4. Drill & Blast Profile ESA3b.....	164
Figure A-5. Drill & Blast Profile ESA4a .....	165
Figure A-6. Drill & Blast Profile ESA4b.....	166
Figure A-7. Drill & Blast Profile ESA5a .....	167
Figure A-8. Drill & Blast Profile ESA5b.....	168
Figure B-1. Tunnel 9 Raron TBM MBK Window.....	170
Figure B-2. Geologic Zones 12-18 of the 9 Raron TBM Tunnel.....	175
Figure B-3. Geologic Zones 19-23 of the 9 Raron TBM Tunnel.....	175
Figure B-4. Geologic Zones 24-27 of the 9 Raron TBM Tunnel.....	176
Figure B-5. Difficult Zones in 9 Raron TBM Tunnel .....	177
Figure B-6. Tunnel 8 Steg Access TBM MBK Window .....	178
Figure B-7. Geologic Zones 1-7 of the 8 Steg Access TBM Tunnel.....	183
Figure B-8. Geologic Zones 8-13 of the 8 Steg Access TBM Tunnel.....	183
Figure B-9. Difficult Zones in 8 Steg Access TBM Tunnel .....	184
Figure B-10. Tunnel 11 StegNW TBM MBK Window.....	185
Figure B-11. Geologic Zones 1-7 of the 11 Steg NW TBM Tunnel.....	190
Figure B-12. Geologic Zones 8-14 of the 11 Steg NW TBM Tunnel.....	190
Figure B-13. Geologic Zones 15-20 of the 11 Steg NW TBM Tunnel.....	191
Figure B-14. Difficult Zones in 11 Steg NW TBM Tunnel.....	191
Figure B-15. Tunnel 6 Ferden SE Drill & Blast MBK Window .....	192
Figure B-16 Tunnel 7 Ferden SW Drill & Blast MBK Window .....	193

Figure B-17. Geologic Zones of the 6 Ferden SE and 7 Ferden SW Drill & Blast Tunnels .	195
Figure B-18. Difficult Zones in 6 Ferden SE and 7 Ferden SW Drill & Blast Tunnels .....	196
Figure B-19. Tunnel 5 Ferden NW Drill & Blast MBK Window .....	197
Figure B-20. Tunnel 4 Ferden NE Drill & Blast MBK Window.....	198
Figure B-21. Geologic Zones of the 5 Ferden NW and 4 Ferden NE Drill & Blast Tunnels	202
Figure B-22. Difficult Zones of the 5 Ferden NW and 4 Ferden NE Drill & Blast Tunnels.	202
Figure C-1. Cross-Section Markov Matrix for 10 Raron DB Tunnel.....	204
Figure C-2. Cross-Section Markov Matrix for 9 Raron, 8 Steg, and 11 Steg TBM Tunnels.	204
Figure C-3. Cross-Section Markov Matrix for 6 Ferden and 7 Ferden DB Tunnels .....	204
Figure C-4. Cross-Section Markov Matrix for 5 Ferden and 4 Ferden DB Tunnels .....	204
Figure C-5. Markov Mean Lengths for Zone 2 of the 10Raron DB Tunnel.....	205
Figure C-6. Markov Mean Lengths for Zone 3 of the 10Raron DB Tunnel.....	205
Figure C-7. Markov Mean Lengths for Zone 4 & 6 of the 10Raron DB Tunnel.....	205
Figure C-8. Markov Mean Lengths for Zone 5 of the 10Raron DB Tunnel.....	206
Figure C-9. Markov Mean Lengths for Zone 7 of the 10Raron DB Tunnel.....	206
Figure C-10. Markov Mean Lengths for Zone 8 of the 10Raron DB Tunnel.....	206
Figure C-11. Markov Mean Lengths for Zone 9 of the 10Raron DB Tunnel.....	207
Figure C-12. Markov Mean Lengths for Zone 10 of the 10Raron DB Tunnel.....	207
Table 1. Locations of the Tunnels.....	38
Table 2. Cross-Sections of the Loetschberg Tunnels.....	38
Table 3. Summary of the Results .....	40
Table 4 Crusher Production for Drill & Blast Materials.....	53
Table 5. Crusher Production for TBM Materials .....	53
Table 6. 10 Raron DB Information Table .....	84

Table 7. Comparison of the results between the original and the new Data file.....	101
Table 8. Materials Quantities .....	102
Table 9. <b>Simulation A</b> Average Results for Excavation and Lining.....	114
Table 10. Stocks in Repositories for <b>Scenario A</b> “Example” Simulation .....	120
Table 11. <b>Simulation B</b> Average Results for Excavation and Lining.....	129
Table 12. Stocks in Repositories for Scenario B “Example” Simulation .....	132
Table 13. <b>Simulation C</b> Average Results for Excavation and Lining.....	135
Table 14. Stocks in Repositories for Scenario C “Example” Simulation .....	139
Table 15. <b>Simulation A1</b> Duration Results for Excavation and Lining.....	142
Table 16. Stocks in Repositories for Scenario A1 & Scenario A “Example” Simulation.....	144
Table 17. <b>Simulation A2</b> Duration Results for Excavation and Lining.....	146
Table 18. Stocks in Repositories for Scenario A2 & A “Example” Simulation.....	148
Table A-1. Initial Support for Different Profiles .....	160
Table B-1. 9 Raron TBM Information Table.....	171
Table B-2. 8 Steg TBM Information Table.....	179
Table B-3. 11 StegNW TBM Information Table.....	186
Table B-4. 6 Ferden SE and 7 Ferden SW Drill & Blast Tunnels Information Table.....	193
Table B-5. 5 Ferden NW and 4 Ferden NE Drill & Blast Tunnels Information Table.....	198



# Chapter 1 Introduction

## Tunneling and Underground Operations

Tunneling and underground construction in general is becoming more and more important these days. Limited space is one major factor that forces people to develop underground structures. This is possible due to the rapid development of more effective and accurate technological tools both for design and for construction.

On the other hand underground operations are subject to a variety of uncertainties. Economic factors as well as limitations in resources force engineers to manage more effectively their projects as well as to consider and investigate many new parameters in their designs.

Reuse of the excavated materials is definitely one possibility that is not usually considered in tunnel design. Taking into account this additional possibility will probably reduce some of the cost involved. Also reusing materials represents an enormous environmental contribution, by minimizing the waste materials.

## Problem Definition and Objectives

The purpose of this research is the application of the resources model of the Decision Analysis for Tunneling (DAT) in a real case study. This is the first time that something like this has been attempted and therefore a number of simplifications had to be made.

For the purposes of this research a real tunnel project, from which we would be able to get real and accurate data, had to be found. The Loetschberg base tunnel was selected as a very suitable example since the DAT had already been used for the design. In addition the project's size and complexity is by itself a challenge and would test the accuracy and the effectiveness of the DAT.

Creating and simulating different scenarios for the use of the excavated materials will result in a variety of solutions from which the best one could be applied by the engineers. In addition with this research we will prove that the DAT can be used to simulate resources management. Future research can make this model work even more effectively such that it

can eventually be used in more and more tunnel projects and also be applied in other civil or mining engineering projects.

## Thesis Outline

The thesis is structured as follows: Chapter 2 gives a description of the project. In that chapter all the necessary information of the project is presented. In Chapter 3 the results of the current simulations using the DAT are presented. Chapter 4 gives an analytical description of the materials management techniques used in the Loetschberg tunnel. In Chapter 5 all the assumptions we made in order to simulate this complex problem will be presented. Chapter 6 is a brief presentation of the MBK interface that was created for this research. In Chapter 7 all the data that were input are presented. Chapter 8 is devoted to describing the different simulations and also to presenting and comparing the results. In Chapter 9 we will try to present a System Dynamics approach for tunneling. Finally the conclusions drawn from this research and the perspective, for future research are developed in Chapter 10.

## Chapter 2 The Loetschberg Project

The following outline follows in parts reports written in Tunneling Switzerland [K. Kovari, F. Dercoeuders, 2001], The Loetschberg Railway Base Tunnel [F. Vuilleumier, P. Teuscher, R. Beer, 1997] and BLS Alptransit website [www.blsalptransit.ch].

### Switzerland's Public Transport Network Solution

Over the past 30 years, Switzerland has built and completed a highway network of 1550 Km, opening up new dimensions to road traffic. This network was built following a wish of the past generation to provide all parts of the country with a high quality road network.

This road network and the economic development of Europe have led to a radical increase in truck traffic, particular the traffic crossing the Alps. The Swiss government decided that switching some of the traffic to rail was necessary and various major projects for rail transport have been under discussion and planning for a number of years.

As a result of this process the Swiss government decided in summer 1996 to re-examine the major rail projects, particularly their financing, and to put them to a vote as a total package. The package that was approved by the electorate on 29 November 1998 consists of the following four projects and will create the network shown in Figure 1:

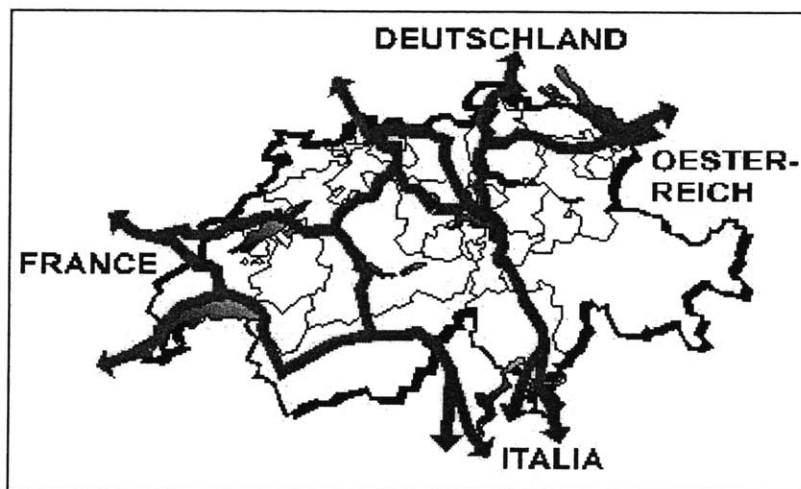

Figure 1. Switzerland's future rail network

## **1. Neat (New Alpine Rail Axes)/ AlpTransit**

NEAT will create new high-performance rail links on the north-south axes through Switzerland. At the core of NEAT are new high-performance links along the Gotthard and Loetschberg axes. NEAT will be used for passenger and goods transportation and offers substantial reductions in travel time for north-south traffic.

## **2. Rail 2000**

The RAIL 2000 project will bring nation-wide improvement in the provision of public passenger transport. The goals of RAIL 2000 will be achieved through a broad range of measures. These include the enhancement of overloaded routes including new rail lines and the use of the very latest rolling stock. Strong coordination will exist between RAIL 2000 and NEAT/AlpTransit since the new and expanded sections of RAIL 2000 will serve as access routes to the new transalpine routes. Conversely, the two AlpTransit axes complement the high-performance RAIL 2000 network and link Ticino and Valais with the north side of the Alps.

## **3. Connection to the European high-performance rail network**

In Europe, a network of high-speed railways is being created for passenger transport. Switzerland has already benefited from the current European high-performance railway links with the ICE<sup>1</sup>, TGV<sup>2</sup> and Cisalpino<sup>3</sup>. With AlpTransit, Switzerland will be fully integrated into the European high-performance rail network and in future will therefore be able to maintain its important position at the heart of Europe, in terms of transport policy.

## **4. Noise reduction on the railways**

Structural measures and improvements will provide better protection from noise.

---

<sup>1</sup> ICE: Inter City Express high-speed Railway in Germany and Switzerland.

<sup>2</sup> TGV: French High Speed Railway Network.

<sup>3</sup> Cisalpino: Railway between Italy and Switzerland.

## The Loetschberg Tunnel Overview

The Loetschberg base tunnel is a component of the AlpTransit concept (Figure 2). It will be 34.6 Km long and together with the 50 Km long line between Olten and Berne (North), the north- south transit route to Milan (South) via Berne-Loetschberg will be equally attractive as the line via Zurich- Gotthard. In the south, it will connect to the existing Simplon base tunnel, whose access lines are currently being extended in Italy. The Loetschberg is located in Central Switzerland (Figure 3) and it leads from Frutigen in the Kander valley to Raron in the Rhone valley, as shown in Figure 4.

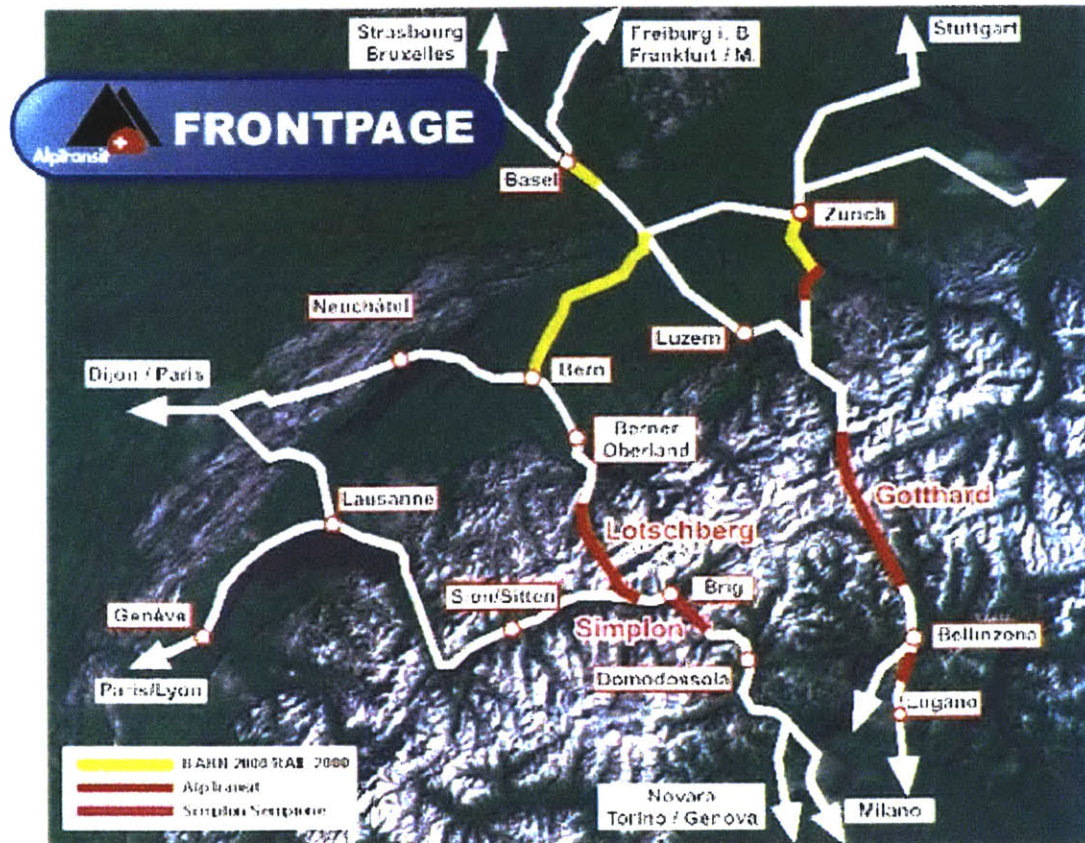

Figure 2. The AlpTransit Project <sup>4</sup>

<sup>4</sup> Resource <http://www.bsalptransit.ch>

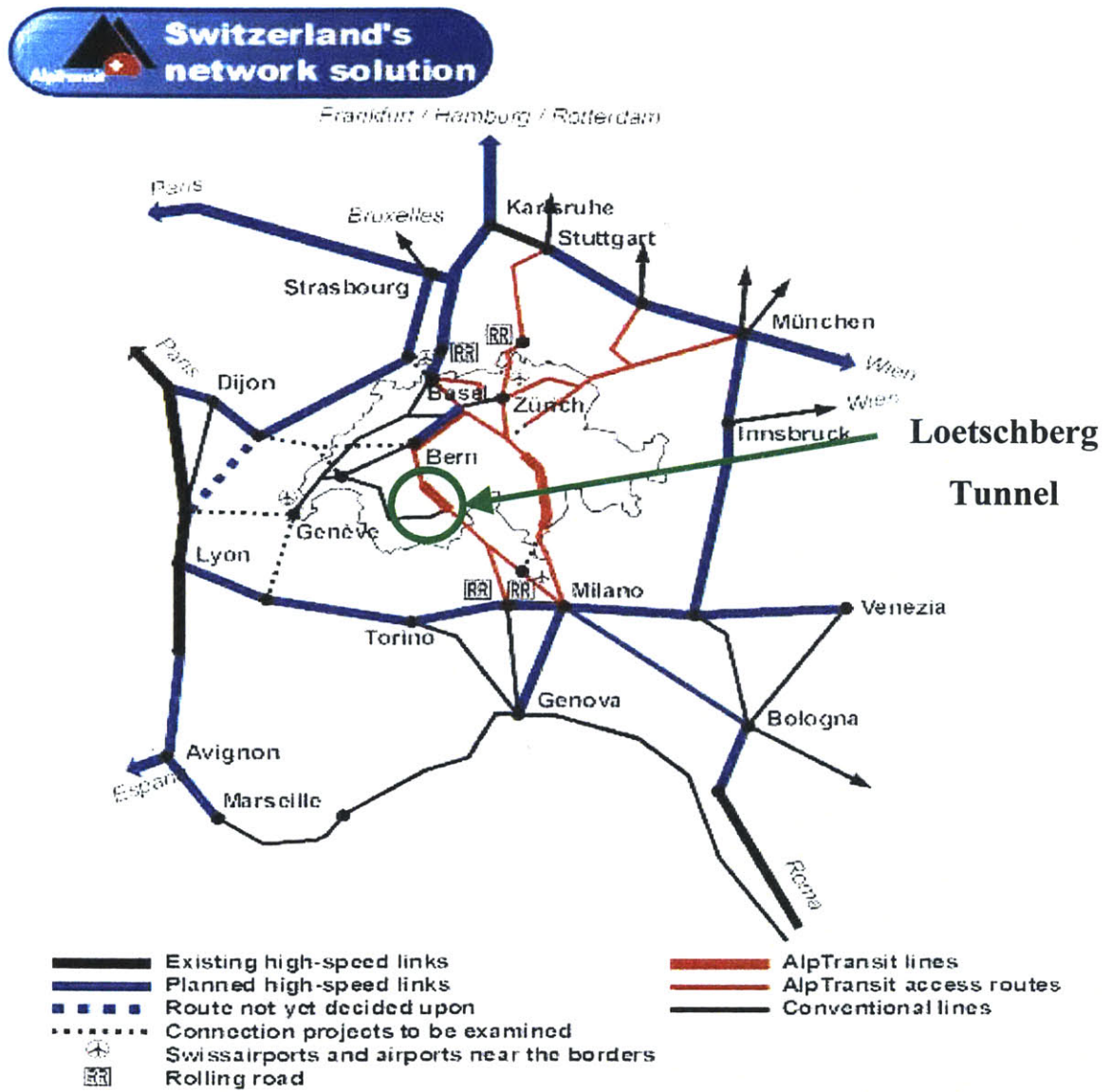

Figure 3. Alptransit in the Switzerland's network<sup>4</sup>

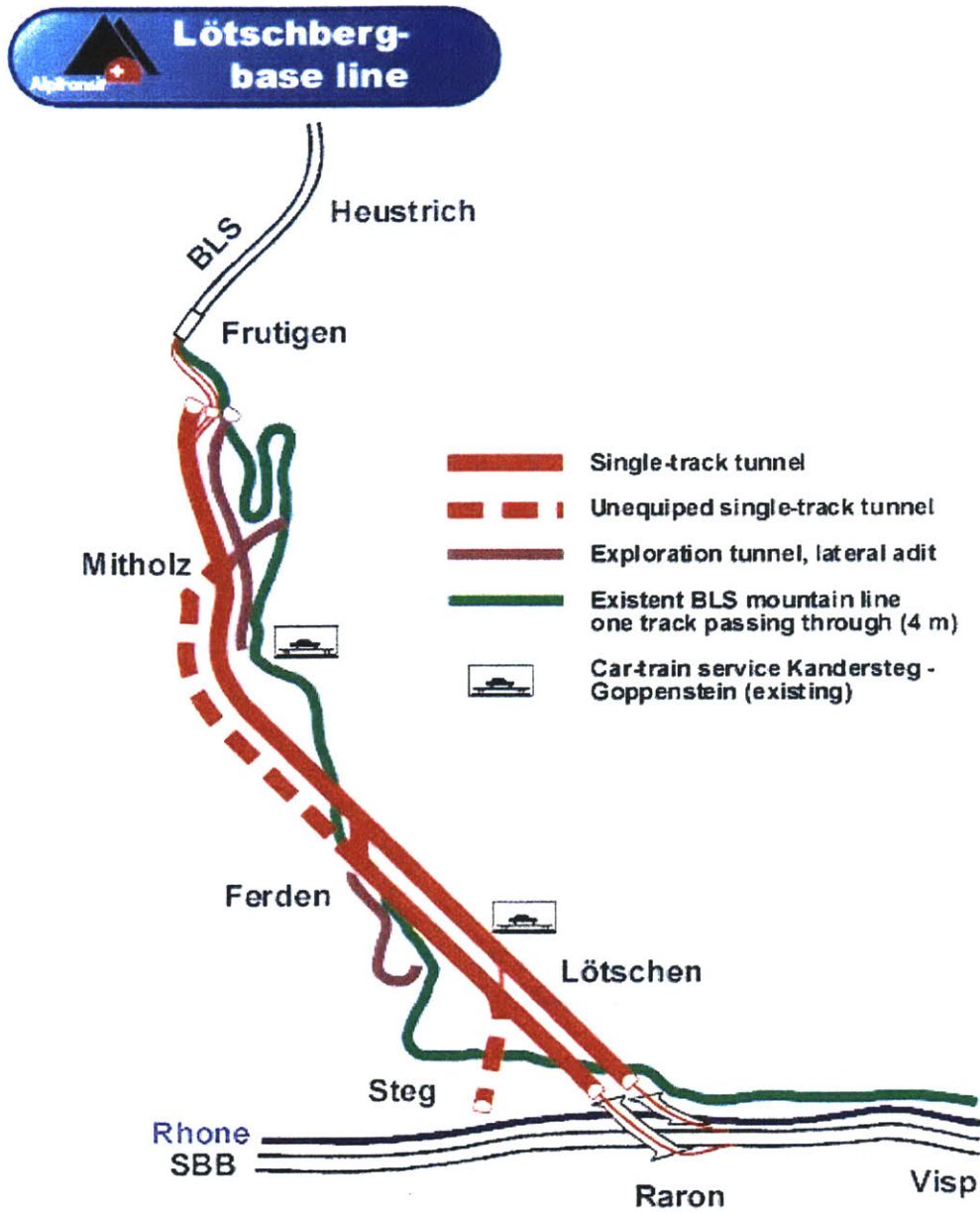

Figure 4. Loetschberg Base Tunnel <sup>4</sup>

## The Tunnel Design

The Loetschberg base tunnel is designed as a tunnel system with two separate single-track tubes, one in each direction (Figure 5). However, in order to reduce the cost only one tunnel tube will be built between the north portal in Frutigen and the service station in Mitholz. This is possible since the Kandertal exploration tunnel, which has already been completed, runs in parallel and will act as a rescue and safety gallery in the operational phase.

South of Mitholz, as far as the south portal in Raron, two tunnel tubes are being built. However in the initial phase the railway infrastructure of the western tube only will be completed between Mitholz and Ferden, while the eastern tube will only be excavated but not equipped with rail infrastructure. In the southern most section between Ferden and Raron both twin tunnels will be built and fully equipped. The total length of the base tunnel is 34.6 km. The distance between the two tubes is generally 40 m. The two tunnel tubes will be linked every 333 m by crossways. A lateral tunnel to Steg is also being built and will have the same profile as the tunnel tubes, so that infrastructure can be installed for rail traffic at a later date, allowing a subsequent direct link to be constructed towards the central Valais.

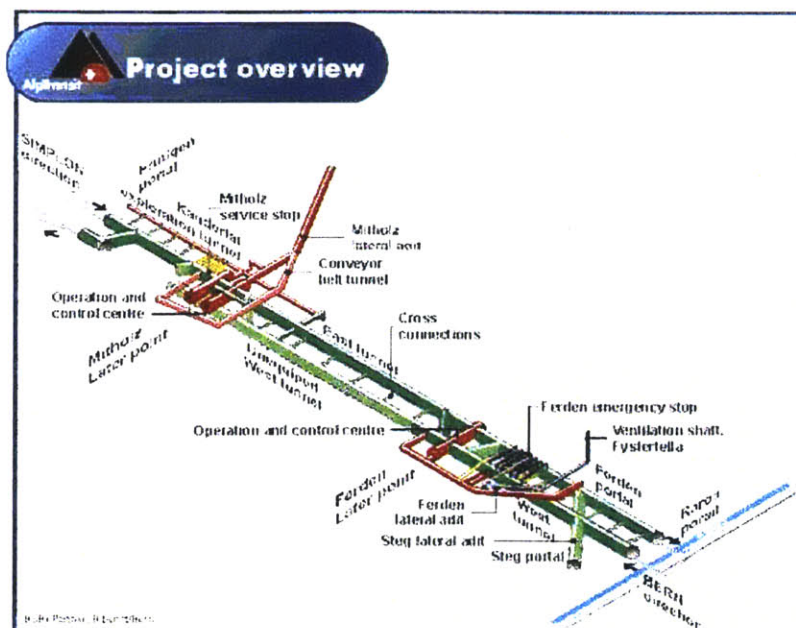

Figure 5. The Project overview<sup>4</sup>

## The Tunnel Geology

The geological conditions at Loetschberg are generally good. All the zones, which could possibly present difficulties, have been investigated using different methods down to the level of the base tunnel. In particular, two dozen boreholes were drilled and 9.5 km of exploration tunnels were driven.

As shown in the geologic profile (Figure 6) in the northern part the Loetschberg base tunnel meets a variety of successive sedimentary rocks (helvetic deposition), some of which are highly eroded. Specifically the tunnel will pass 9.2 Km of flysch, including Taveyannaz sandstones that are followed by 4.5 Km of limestones and marls. After that and for a distance of 0.5 Km there is an autochthonous sedimentary rock cover composed of strongly deformed shales, graywackes (cornieule), anhydrite and dolomites. Going to the south the tunnel traverses the entire Aar massif for a length of 18 Km. This zone is composed of various gneisses, schists, amphibolites, granites and granodiorites. There are possibly two prominent shear zones that are worth to mentioning: the “Faldumbach” and the “Dornbach”, with up to 60 m of thin- bedded schists and phyllites. The Jungfrau keil zone, which is a highly permeable zone, separates the granite from the main body of the Aar massif. The southern end of the tunnel is located in autochthonous sedimentary rocks, composed of limestones, marls, dolomites and argillaceous and calcareous shales.

The flysch and the Taveyananz sandstone are rocks with low permeability and minor to no waterflow. The limestones show some karstification near the surface, which at depth may be filled with mud or loam. High water pressures, up to 140 bar, are found in the above-mentioned Jungfrau keil zone. In the southern autochthonous zone, the main water conducting features are karstified zones.

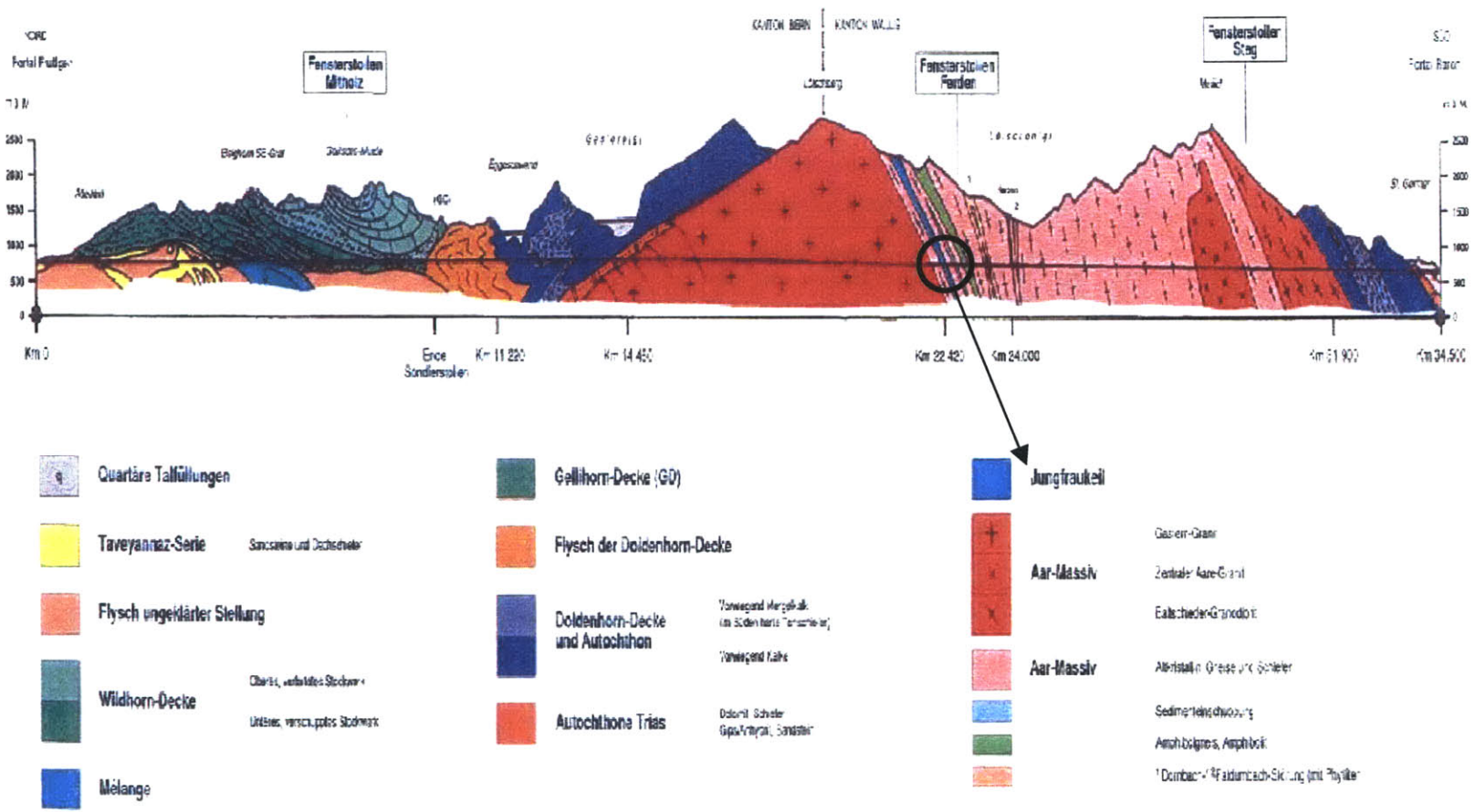

Figure 6. Geological cross section of the Loetschberg Base Tunnel<sup>4</sup>

## Construction Concept

The Channel Tunnel has set new standards in safety. In Switzerland, likewise, it will only be possible to construct future long tunnels as systems of two directionally separated single-track tunnels, joined together at regular intervals by cross passages. The tunnel system on which the new AlpTransit base tunnels are based was already used in the construction of the Simplon base tunnel (South of Loetschberg) almost one hundred years ago. This system has considerable advantages in terms of construction engineering, since two smaller tubes pose far fewer problems with regard to rock mechanics than a double-track tunnel with a larger profile.

Thanks to the Mitholz, Ferden and Steg lateral adits, the Loetschberg Base Tunnel can be subdivided into sections (Figure 7). The lateral adits of Mitholz, Ferden and Steg will serve as intermediate working faces. These, together with the portals at Frutigen and Raron, will provide a total of 10 working faces (at Frutigen there will be no rock tunnel but only the approach in the soil overburden will be built there). Given the subdivision of the tunnel as a whole, all bores will be less than 10 km long. The longest section of the Lötschberg Base Tunnel is between Mitholz and Ferden. It is this section, which will determine the construction time of the base tunnel.

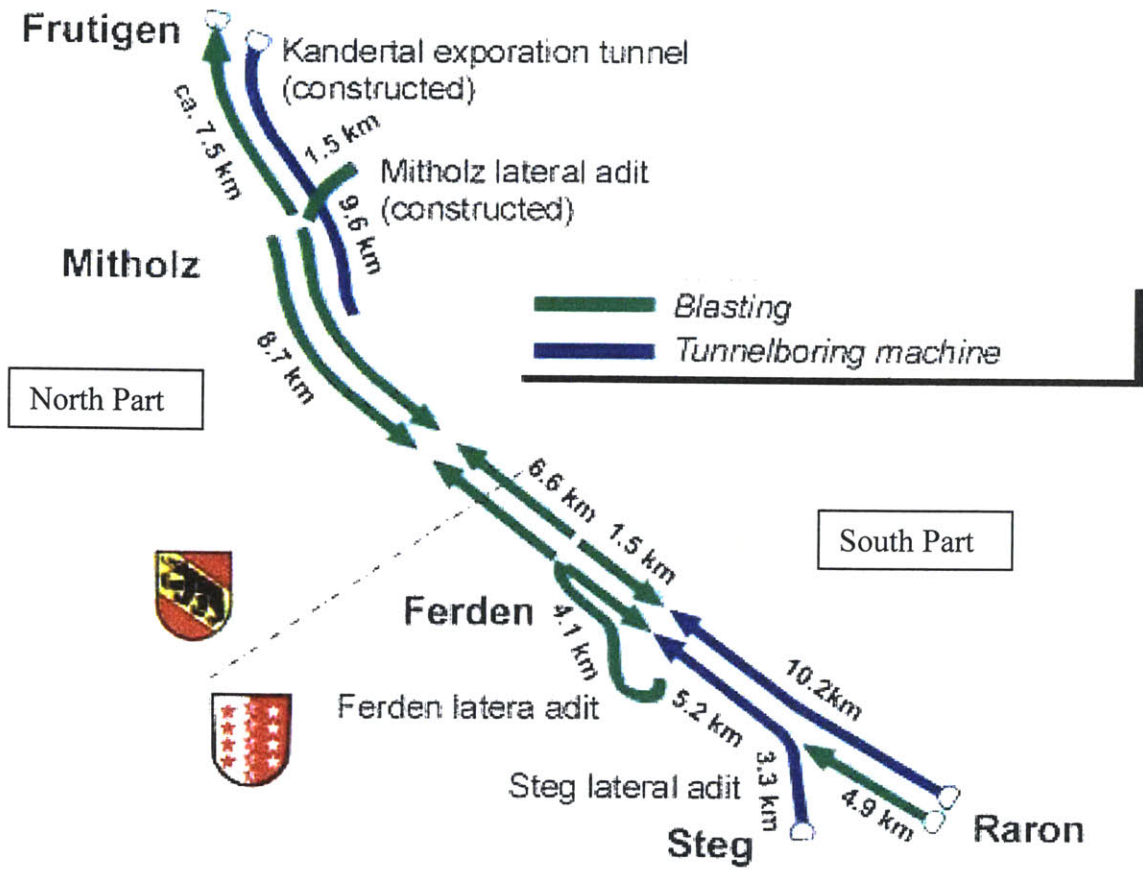

Figure 7. The Construction Concept<sup>4</sup>

## Excavation Methods

The two construction methods that will be described below are being used for the excavation of the tunnel.

### 1. The Tunnel Boring Machine (TBM)

As shown in Figure 7 there are two parts of the tunnel that will be excavated with a Tunnel Boring Machine (TBM). The TBM that is being used is shown in Figure 8.

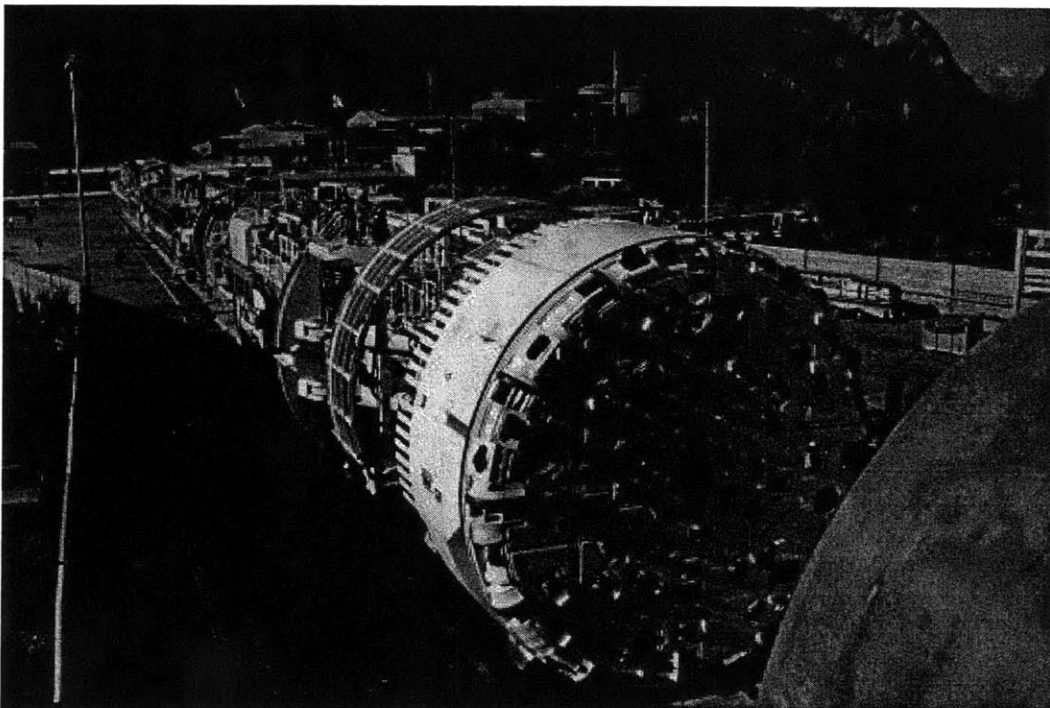

Figure 8. The Loetschberg's TBM<sup>5</sup>

For both tunnels the TBMs are identical, Herrenknecht open hard rock TBMs with the following characteristics:

- 9.43m diameter with 60 cutter discs
- thrust: 16,000 kN
- speed of rotation: 0 to 6 r.p.m.

---

<sup>5</sup> Resource [www.martiag.ch](http://www.martiag.ch)

- power: 10 electric motors, total power 3,500 kW
- total length (including sleds): 142 m

Both TBMs are expected to be excavating at an average rate of 25 m/day.

As can be seen in Figure 8 at the front of the TBM is the drilling head, fitted with the hardened steel cutters discs. The powerful electric motors with a high total output slowly rotate the head. At the rear of the boring head are hydraulic presses, which exert high pressure to push the drilling head against the face of the tunnel. Under the high pressure of the roller bits, the rock splits into small pieces, called chips. The TBM moves forwards in short steps; after each boring stroke the entire machine is pulled forward, braced in position and the process repeated. Directly behind the boring head support as described below is placed. The excavated materials are transported to the rear part of the TBM, by conveyor belts. From there, a tunnel railway takes it to the portal of the tunnel, into a buffer silo and to the loading point.

## **2. Drilling & Blasting**

As one can see in Figure 7 most of the tunnel is being excavated by Drilling & Blasting, since in many parts of the tunnels the use of the TBM was considered risky.

The sequence of the Drilling and Blasting method is the following and is graphically shown in Figure 9:

- a) Drilling and Loading the holes on the face of the tunnel.
- b) Blasting.
- c) Ventilating the tunnel.
- d) Loading the excavated materials on trucks or on the tunnel railway.
- e) Transporting the materials to the portal of the tunnel.
- f) Supporting the excavation if needed.

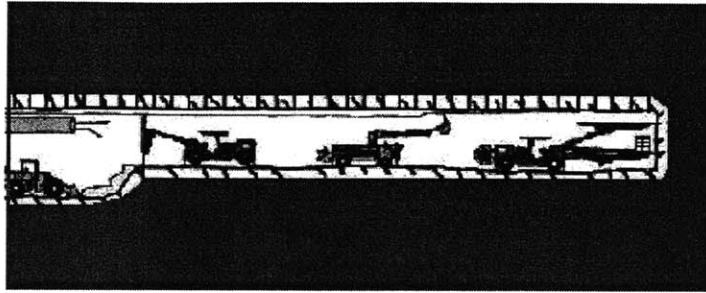

Figure 9. Drilling & Blasting Method

Figure 10 shows part of the excavation work in Ferden.

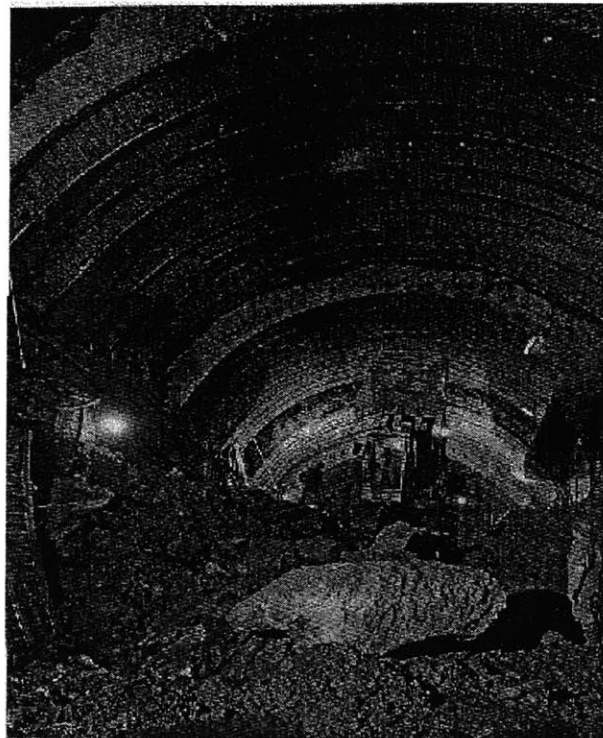

Figure 10. Excavation in Ferden

## Support of the Tunnels

### Initial Support

The owner in consultation with the contractor will select the initial support systems. In order to standardize this a series of rock support profiles have been prepared. Each profile indicates the type of support (rock bolts, shotcrete, and steel ribs) for a given type of excavation (i.e. Drill and Blast or TBM). The selection of the specific support profile to be implemented is decided at the tunnel face as a function of the encountered geologic conditions. A table of the support profiles is shown in Appendix A. Figure 11 illustrates a typical initial support profile.

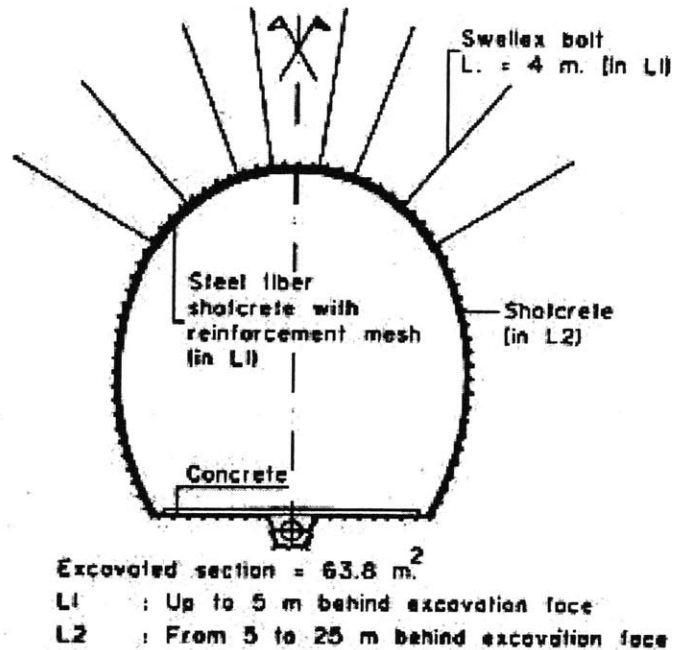

Figure 11 Typical Rock Support Profile (Drilling & Blasting)

Based on the present level of geological knowledge, over 99.5% of the tunnel length will be excavated by “full face”. The sections requiring half face excavation or even more subdivisions represent only 0.2 and 0.3% of the tunnel length respectively. In addition to the above- mentioned rock support profiles, special rock treatment will be required locally. Specifically ground treatment by grouting will probably take place while crossing the “Jungfraukeyl” zone.

## Final Support

In most of the tunnel, the concrete lining is cast in place directly against the rock and against the initial support. The tunnel cross section is shown in Figure 12.

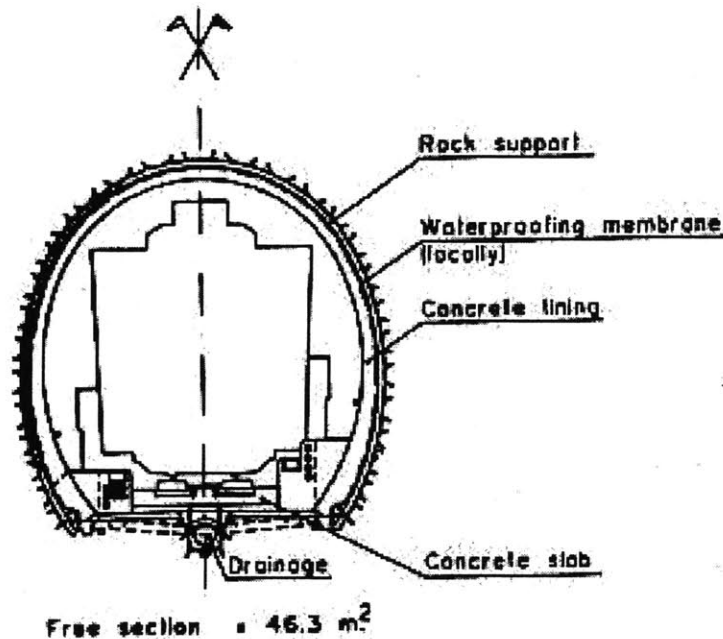

Figure 12. Final Support Profile (Drilling & Blasting)

In areas where water inflows are expected, a waterproofing system is incorporated in between the initial and the final support.

The concrete lining is designed to support the total of the rock pressure arising from long term rock deformation (creep) and failure of the initial support. However it is not designed to support the hydrostatic water pressure, since this may reach very high levels (in the order of 20MPa). The drainage system incorporated in the liner will be designed to reduce these high pressures.

The concrete needed for every meter of final support is:

$$\text{m}^3 \text{ of Concrete per m of final support} = (2\delta R) * t_{\text{lining}} * 1$$

Where,  $\delta$  is 3,14, R is the tunnel radius. We assume that all the tunnels have a radius of 4.5m,  $t_{\text{lining}}$  is the thickness of the concrete. For this project it is 0.4m.

So concrete needed for every meter of support is  $2 * 3.14 * 4.5 * 0.4 = 11.3 \text{ m}^3$ . We round this number to  $11 \text{ m}^3$  for simplicity in the following calculations. The amount of shotcrete for the initial support will be discussed later, since it is related to the geology and the cross-sections.

### **Support Details in the TBM Excavation**

Directly behind the boring head, the rock is secured using rock bolts (in this case swellex) to protect the workforce. Depending on the quality of the rock, additional steel arches or other safety measures are incorporated. Robot arms apply sprayed concrete (shotcrete) in thicknesses of 5- 30 cm. The final support of the tunnel takes place at a distance of a TBM. After some hundred meters from the head final support is placed using the typical tunnel formworks.

### **Support Details in the Drill & Blast Excavation**

Approximately the same techniques are used for the initial and final support of the tunnels being excavated with the traditional drill and blast method. As shown earlier in Figure 11 the initial support will be provided by rock-bolts, mesh, arches and shotcrete, while the final lining will be concrete. In Appendix 1 drawings of some of the typical cross-sections are also presented.

## Chapter 3 The Loetschberg base Tunnel and DAT

The Loetschberg base tunnel was one of the first tunnels in which the Decision Analysis for Tunneling (DAT) was used to estimate the cost and time of the construction. In this chapter all the necessary technical information both for the tunnel and for the SIMSUPER software<sup>6</sup> will be given and the results of the analysis will be presented.

### Geology and SIMSUPER' s Input

The Southern part the Loetschberg tunnel is composed, as mentioned in chapter 2 of seven different tunnels (See Figure 7, Chapter 2). The Network of the tunnels as specified in SIMSUPER is shown in Figure 13.

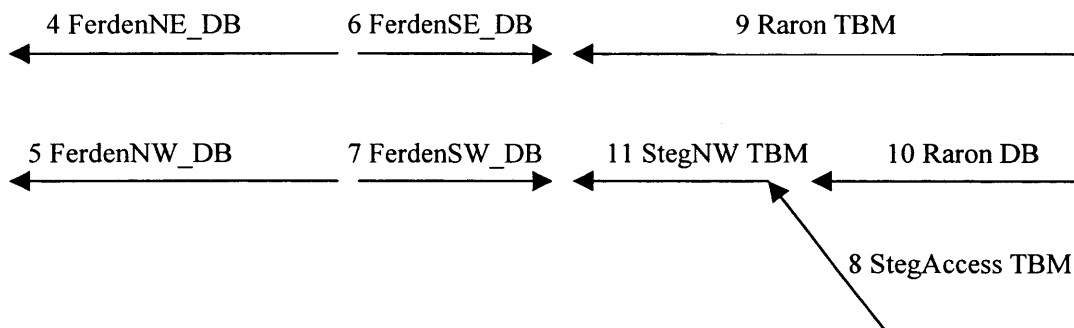

Figure 13. The Southern Loetschberg Tunnel Network

The concept of opposite tunnels<sup>7</sup> (as described in the SIMSUPER user manual) is used. As a result, tunnel 6 FerdenSE\_DB is opposite to 9 Raron TBM, 11 StegNW TBM is opposite to 7 FerdenSW\_DB and tunnels 4 FerdenNE\_DB and 5 FerdenNW\_DB are opposite to the relevant northern parts of the project tunnels. The beginning and end locations of the tunnels as input in SIMSUPER together with the excavation delays<sup>8</sup> are shown in the Table 1.

<sup>6</sup> SIMSUPER software is the code created for the DAT. [C. Indermitte, H. H. Einstein, 2000]

<sup>7</sup> Opposite tunnels are tunnels that both finish as soon as they meet each other.

<sup>8</sup> Delay of a tunnel is the duration (in days) before the simulation of this particular tunnel starts.

Table 1. Locations of the Tunnels

Tunnel	Begin	End	Delay Min	Delay Mode	Delay Max
10 Raron TBM	49,090	44,488	457.00	471.00	485.00
9 Raron DB	49,037	37,521	300.00	300.00	300.00
8 StegAccess	41439	44488	250.00	250.00	250.00
11 StegNW TBM	44,488	37,586	0.00	0.00	0.00
7 FerdenSW DB	37,586	44,488	536.00	540.00	568.00
6 FerdenSE DB	37,521	49,037	540.00	554.00	582.00
5 FerdenNW DB	36,955	22,500	200.00	200.00	200.00
4 FerdenNE DB	36,960	22,623	200.00	200.00	200.00

Each tunnel is divided into different zones and each zone is characterized by a set of geological features. These geological features in correlation with the particular geometry result in all the possible “cross-sections”, as shown in Table 2. A “cross-section” is actually a construction method characterized by the cross-section area, an advance rate and a cost per linear meter. The cost is not shown in this table since it is not relevant for this research on materials handling.

Table 2. Cross-Sections of the Loetschberg Tunnels

	Xsection	Area (m <sup>2</sup> )	Advance Rate (m/day)		
			Min	Mode	Max
<b>10 Raron (Drill &amp; Blast)</b>	ESA 1	64.59	9.0	11.1	11.5
	ESA 2	64.59	8.0	9.9	10.3
	ESA 3a	64.59	5.5	6.8	7.5
	ESA 3b	64.59	5.0	6.4	7.0
	ESA 4a	66.28	2.5	4.0	4.5
	ESA 4b	67.00	3.5	4.7	5.5
	ESA 5ak4	75.21	2.0	2.5	3.0
	ESA 5ak5	75.21	1.5	2.4	2.6
	ESA 5b	79.00	1.0	2.4	2.6
	<b>9 Raron &amp; 8, 11 Steg (TBM)</b>	ET 1a	69.40	13.0	24.5
ET 1b		69.40	12.0	20.2	37.0
ET 2		69.40	12.0	24.0	35.0
ET 3a		69.40	11.0	22.3	32.0
ET 3b		69.40	9.0	18.7	28.0
ET 4a		69.40	4.0	8.5	13.0
ET 4b		69.40	4.0	8.2	13.0
ET 5a		69.40	2.0	3.9	6.0
ET 5b		69.40	2.0	3.7	6.0

7 & 6 Ferden (Drill & Blast)	Xsection	Area (m <sup>2</sup> )	Advance Rate (m/day)		
			Min	Mode	Max
			ES x 1a	64.59	7.5
ES x 2a	64.59	7.0	7.5	9.0	
ES x 2b	64.59	4.0	5.35	6.0	
ES x 3a	64.59	5.5	6.8	7.5	
ES x 3b	66.28	4.0	5.5	6.0	
ES x 4a	67.00	2.0	2.7	4.0	
ES x 5a	75.21	1.2	1.85	2.5	
ES x 6a	75.21	1.0	1.15	2.0	
ES x 6b	79.00	0.8	0.95	1.5	

5 & 4 Ferden (Drill & Blast)	ES 1a	64.59	8.0	8.7	10.3
	ES 2a	64.59	7.0	7.7	9.0
	ES 2b	64.59	4.0	5.5	6.0
	ES 3a	64.59	5.5	7.0	7.5
	ES 3b	66.28	3.5	5.7	6.0
	ES 4a	67.00	2.5	2.8	4.5
	ES 5a	75.21	1.5	1.9	2.6
	ES x 6a	75.21	1.0	1.2	2.0
	ES x 6b	79.00	0.8	1.0	1.5

#### Difficult Zones

All Tunnels	BwSzA	80.00	1.0	3.0	3.5
	BwSzC	80.00	0.5	1.0	1.5
	BwSzE	80.00	4.5	5.7	7.5

At this point it is important to state that the above mentioned procedure is not the typical procedure that one would follow in order to use SIMSUPER (see SIMSUPER users manual). The particular procedure chosen here is the one used during the recent Simulation of the Loetschberg tunnel, which was conducted after the design was complete [Ingenieurgemeinschaft E+B/IUB, BLS Alp Transit AG, 2000].

## Loetschberg Base Tunnel Simulation Output

The average results of the south tunnels of the Loetschberg project that resulted after 100 simulations were run are summarized in Table 3. These average results are calculated from Figure 14- Figure 18. These figures also show the distribution of the length and the duration of each tunnel after the 100 simulations were run.

Table 3. Summary of the Results

<b>Tunnel</b>	<b>Begin Location (m)</b>	<b>End Location (m)</b>	<b>Day Begin</b>	<b>Day Finish</b>	<b>Duration (days)</b>
10 Raron DB	49,090	44,488	470.00	1,240.00	770.00
9 Raron TBM	49,036	39,300	300.00	900.00	600.00
8 StegAccess TBM	41439	44,487	250.00	400.00	150.00
11 StegNW TBM	44,488	38,880	400.00	790.00	390.00
7 FerdenSW DB	37,586	38,881	549.00	788.00	239.00
6 FerdenSE DB	37,521	40,282	560.00	900.00	340.00
5 FerdenNW DB	36,960	27,900	200	1,520.00	1,320.00
4 FerdenNE DB	36,955	27,800	200	1,524.00	1,324.00

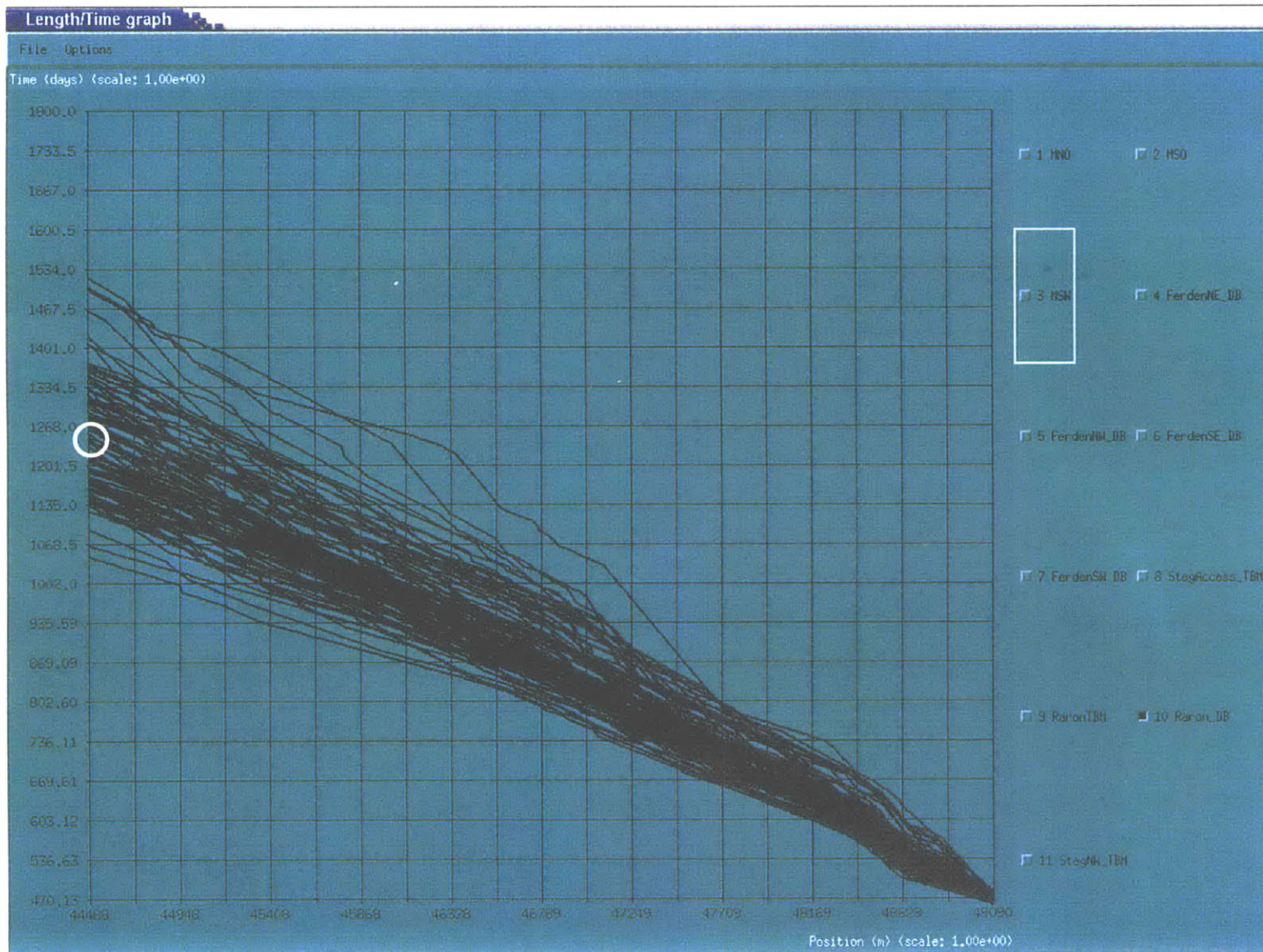

Figure 14. Tunnel 10 Raron DB Time/ Position Graph after 100 Simulations

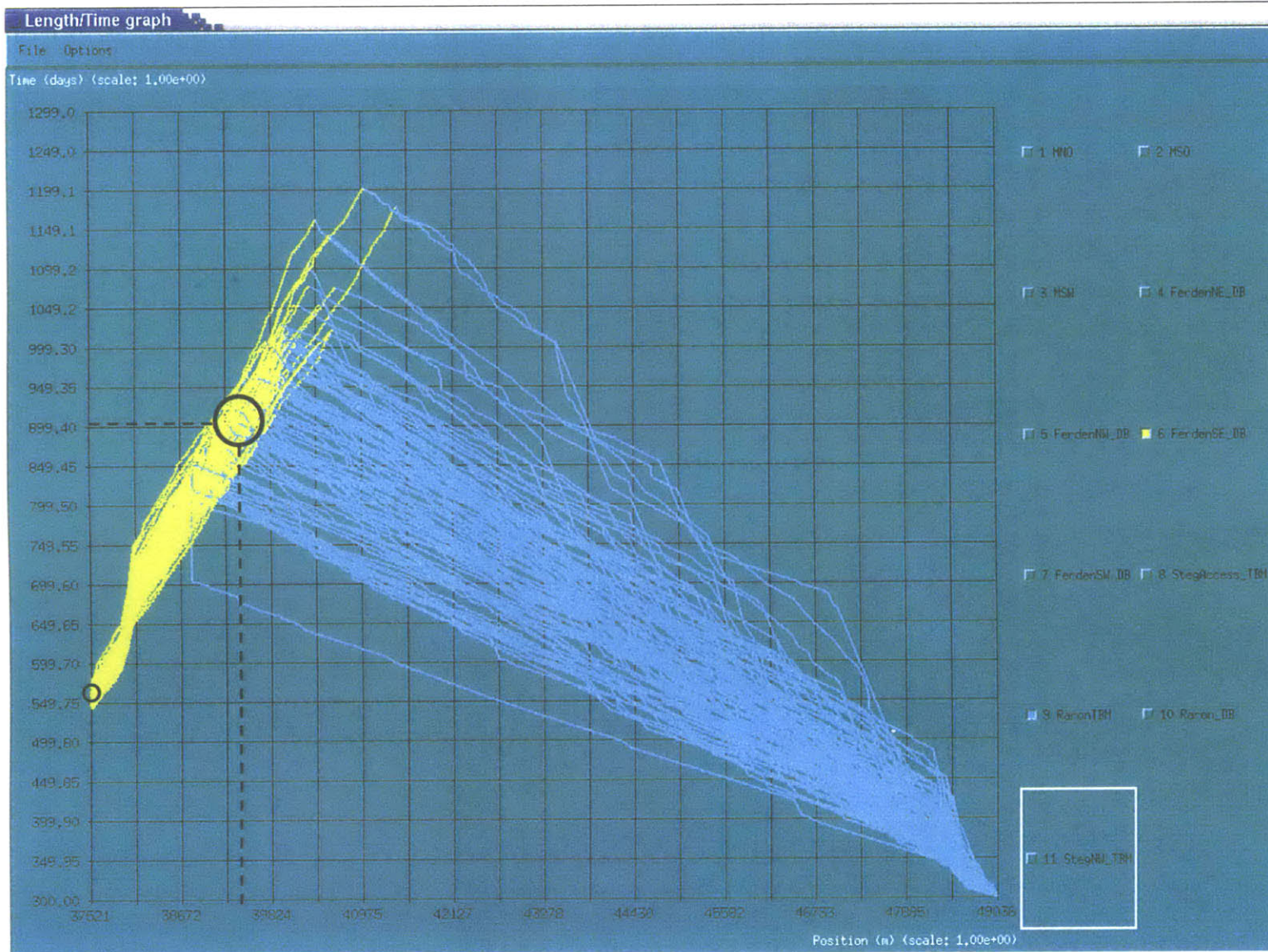

Figure 15. Tunnel 9 Raron TBM and 6 Ferden DB Time/ Position Graph after 100 Simulations

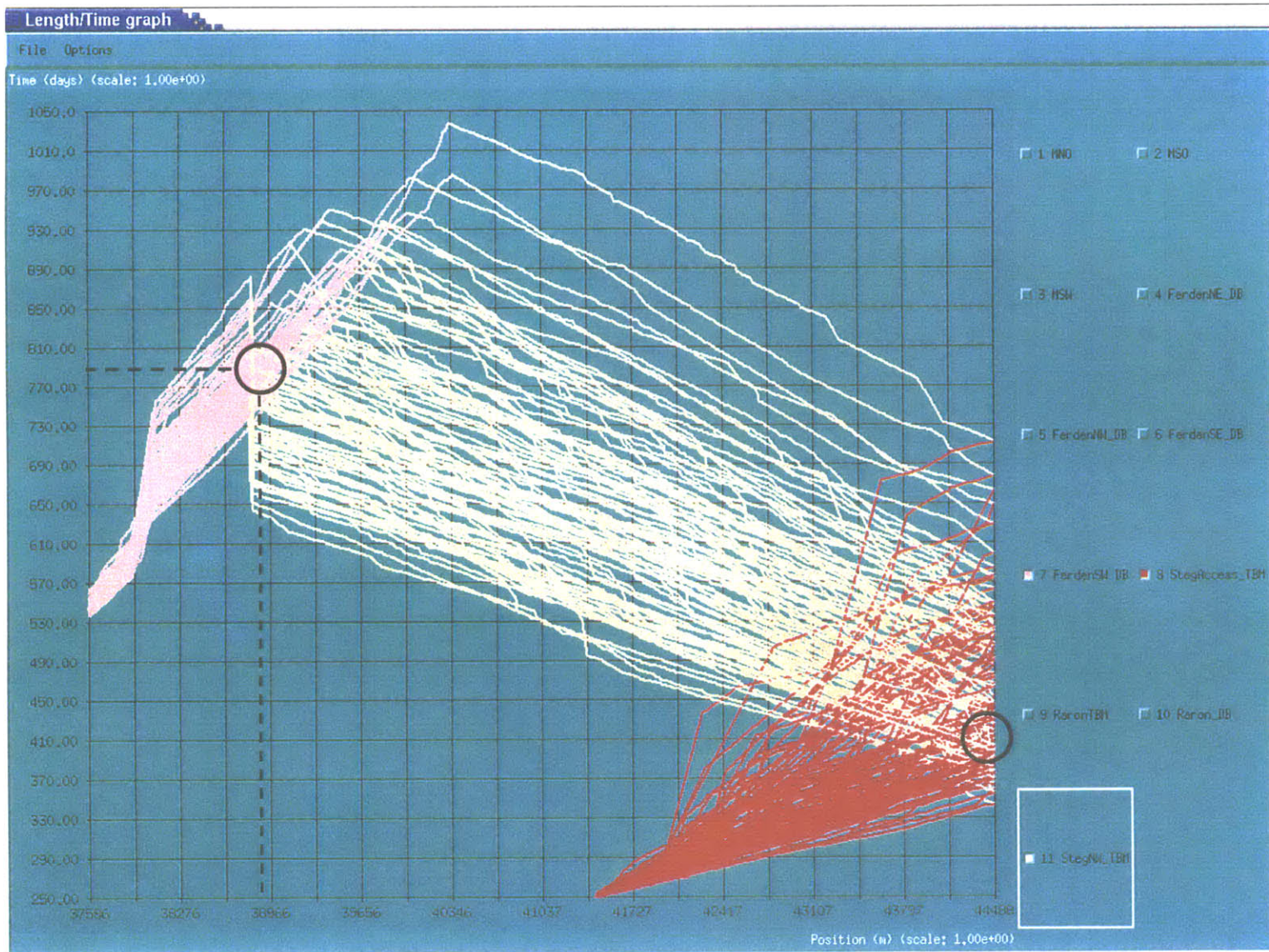

Figure 16. Tunnel 8 StegAccess TBM, 11 Steg TBM and 7 Ferden DB Time/ Position Graph after 100 Simulations

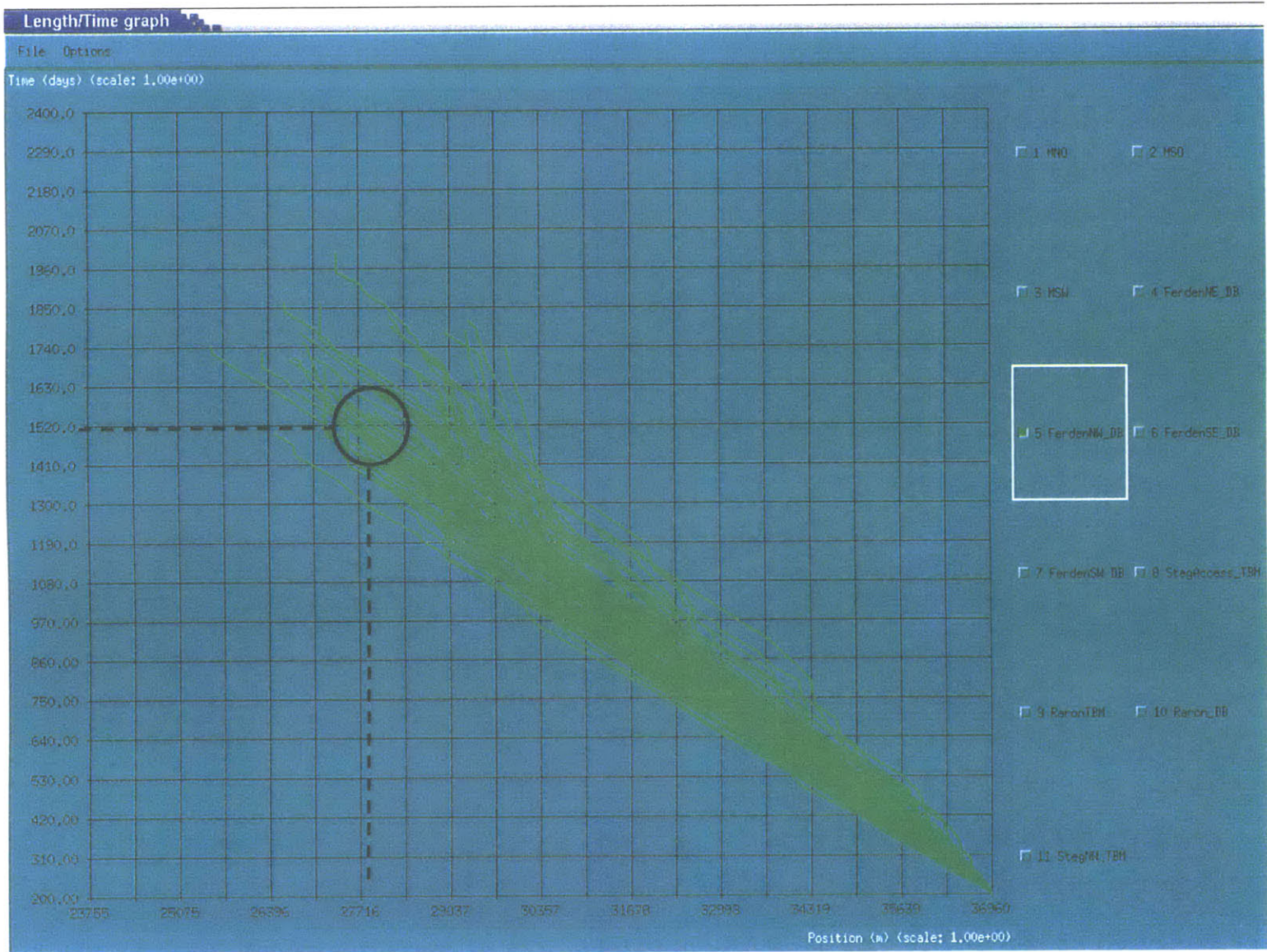

Figure 17. Tunnel 5 Ferden DB Time/ Position Graph after 100 Simulations

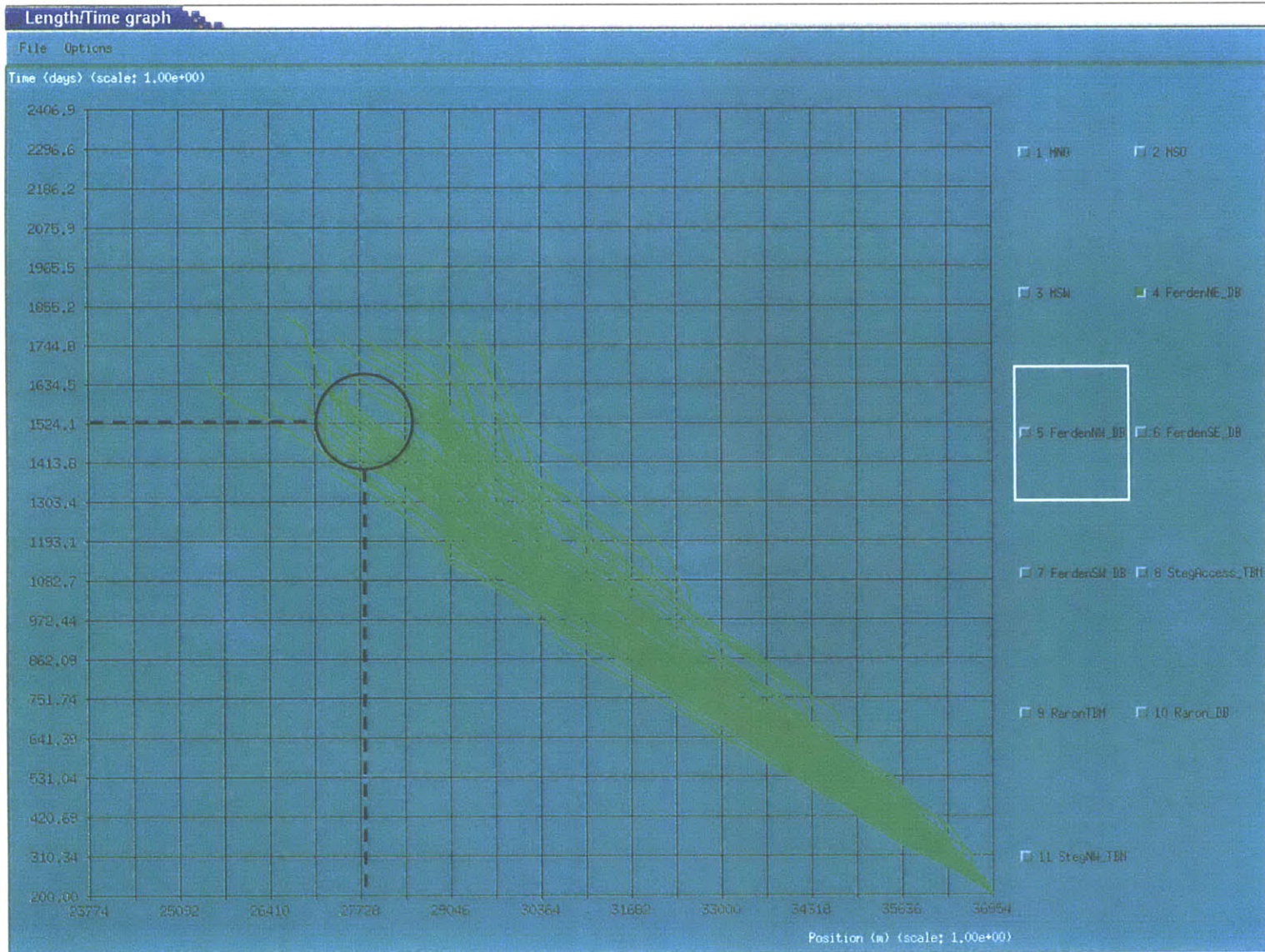

Figure 18. Tunnel 4 Ferden DB Time/ Position Graph after 100 Simulations



# Chapter 4 Materials Management for the Loetschberg Base Tunnel

## Materials Resources

The excavated materials will be used as aggregates for shotcrete and concrete production for both initial and final support. Geologists at the face of the excavation evaluate the quality of the materials. All the materials are stored in intermediate repositories at the exits of the tunnels. From there the materials that qualify for aggregates production are transported by rail to the crushing plant located at Raron. They become aggregates of different sizes and they are transferred to the concrete plant to become shotcrete or concrete, as soon as it is needed in the tunnels. A view of the aggregates and concrete plant at Raron is shown in Figure 19.

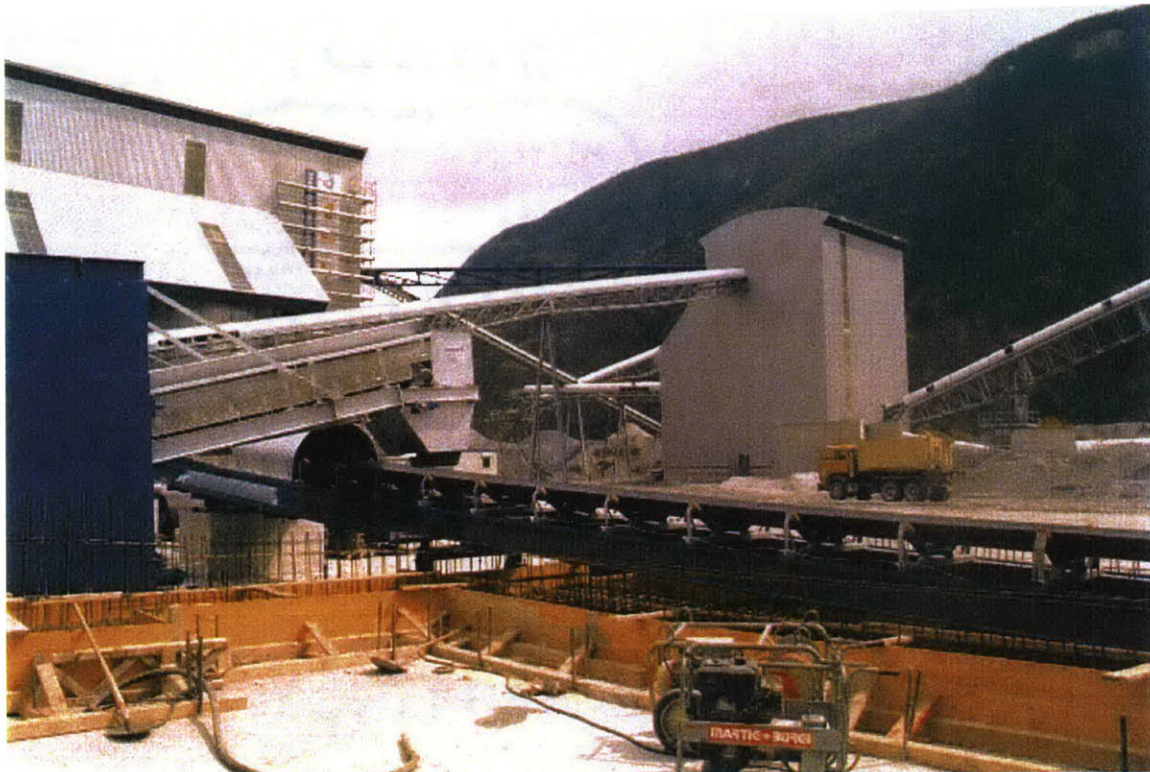

Figure 19. View of the aggregates and concrete plant at Raron

The materials that fail the tests are transported to the final repositories as soon as they exit the tunnels. Such failure can be caused both by the geometry of the excavation materials and the presence of alkali reactive constituents. A flow net of this procedure is shown in Figure 20. A layout of the repositories is shown in Figure 21. As one can see in this figure a repository of flooding material is also indicated. These materials were transported there after a nearby river flood. They are going to be used as aggregates for concrete needs but not for the type of concrete that will be used for the tunnels' support.

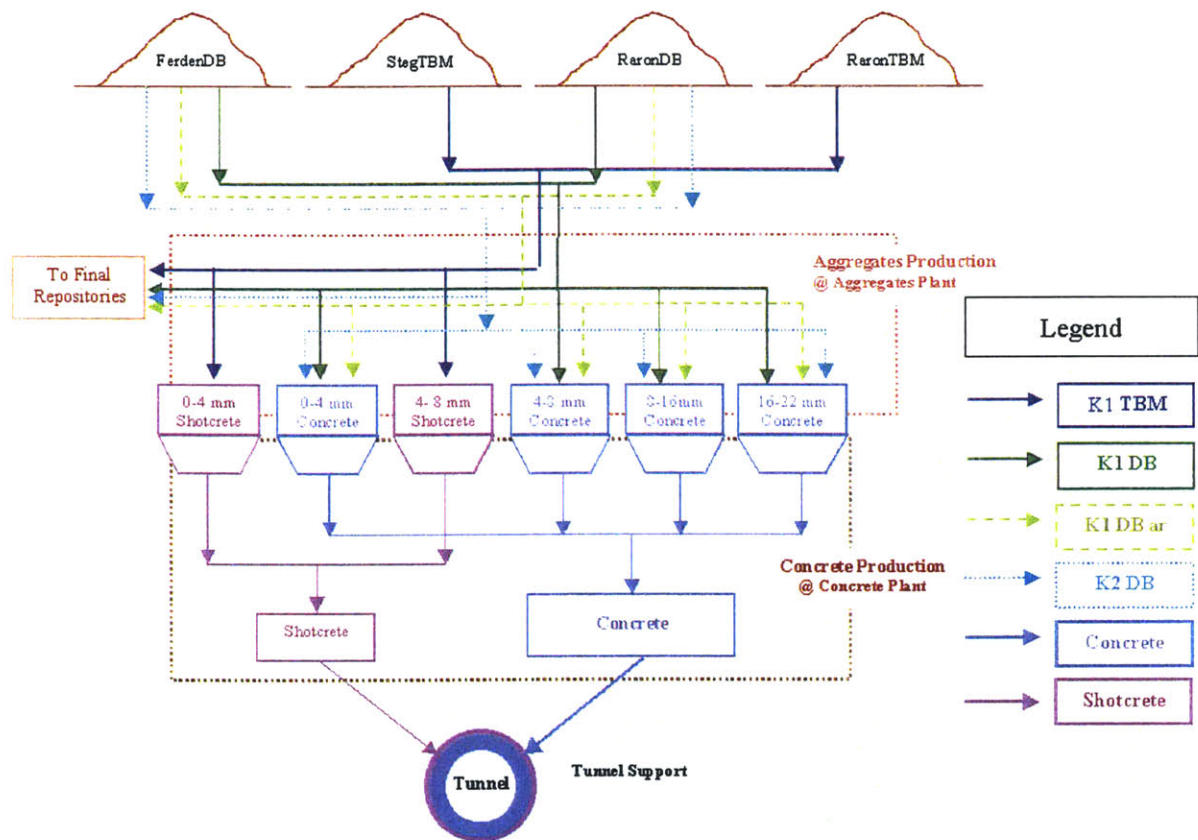

Figure 20. Materials Management Flow Net

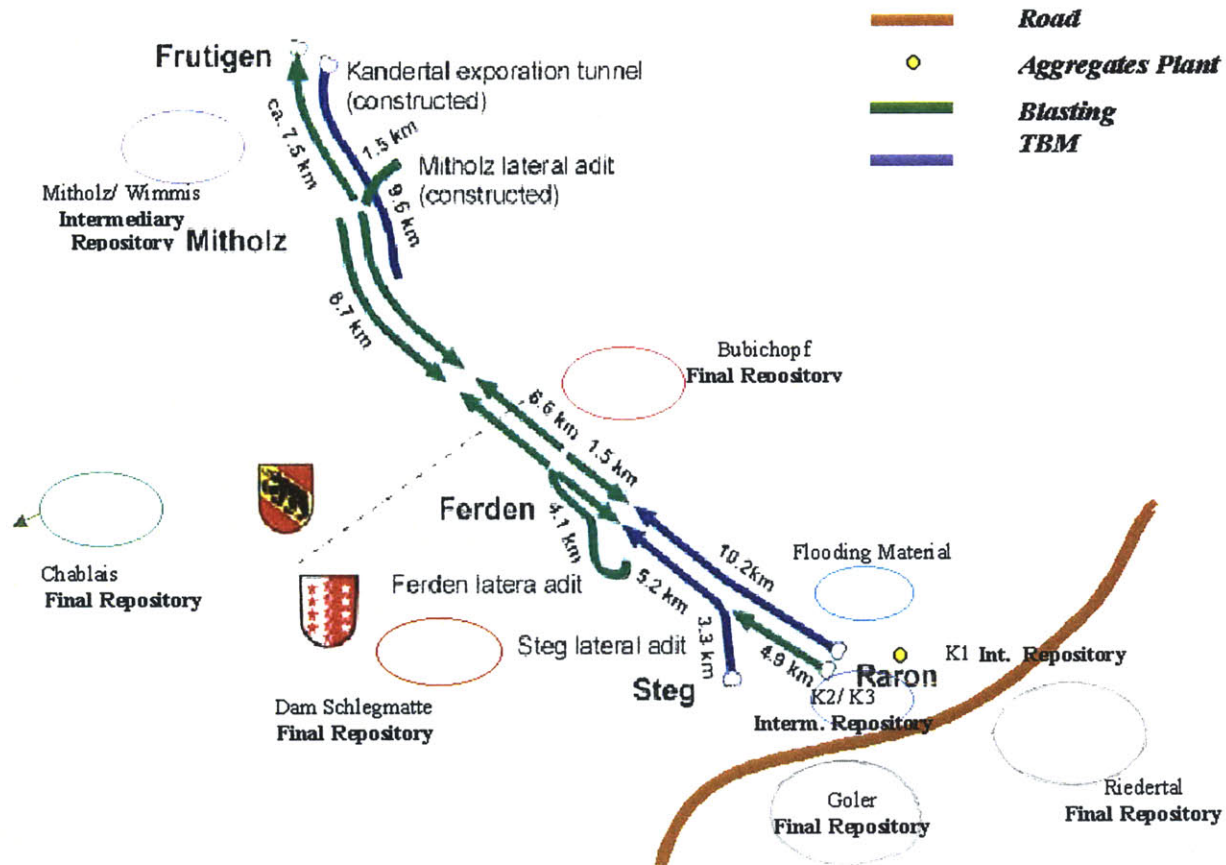

Figure 21. Repositories Layout

# Excavation Materials' Categories

## Main Excavation Materials Categories

The excavation materials of the Loetschberg project are divided into the following main categories as stated in the project documents [Ingenieurgesellschaft E+B/IUB, BLS Alp Transit AG, 2000]:

- **Class 1 materials (K1):** They are good quality rock materials, relatively homogeneous. They are going to be used as aggregates in shotcrete and concrete production.
- **Class 2 materials (K2):** They are moderate to good quality rock materials, relatively heterogeneous. They can be used if necessary as aggregates in shotcrete and concrete production.
- **Class 3 materials (K3):** They are poor quality rock materials, unsuitable for shotcrete and concrete aggregates.

## Alkali Reactive materials

It is well known that aggregates may contain silica ( $\text{SiO}_2$ ), silicates ( $\text{SiO}_x$ ) and carbonates, which in certain mineral forms can react with alkalis (sodium, potassium and calcium hydroxide) in the hydrated cement paste. Of the three known types of deleterious alkali-aggregate reactions in concrete, the alkali-silica reaction is the most common. The other reactions, alkali-silicate and alkali-carbonate, can cause cracking and deterioration of concrete, but have not been as carefully studied and are not fully understood [M. G. Peterson and F. J. Ulm, June 2000].

The product of the alkali-silica reaction (ASR) is a gel that absorbs water and swells to a significant extent and creates localized regions of great pressure that can initiate cracks. Individual cracks tend to interconnect in larger networks in a pattern known as “map cracking”. Typical cracking patterns resulting from ASR is shown in Figure 22.

Determination of which aggregates will be silica-reactive in the field can be very challenging, since there are many factors that come into play in the characterization of the degree of reactivity. Several ASTM standardized tests in conjunction with field experience have made it easier to identify the presence of reactive forms of silica. It has been determined that only certain forms of silica are notably reactive. Known reactive forms of silica include

amorphous silica, quartz if sufficiently strained and microcrystalline, tridymite, cristobalite, opal, chert, cryptocrystalline volcanic rocks (andesites and rhyolites) [H.F.W Taylor, 1997]. These can be found in some limestones and in strained or metamorphic quartz. Felspars, pyroxgneisses, schists, sandstones and basalts are classified as innocuous minerals and rocks.

Since ASR can take ten years or more to develop, it may be many years before macrocracking in a concrete structure is observable. By this time little can be done to inhibit the onward progression of the reaction. Thus, it is better to prevent those deleterious reactions by judicious selection of materials.

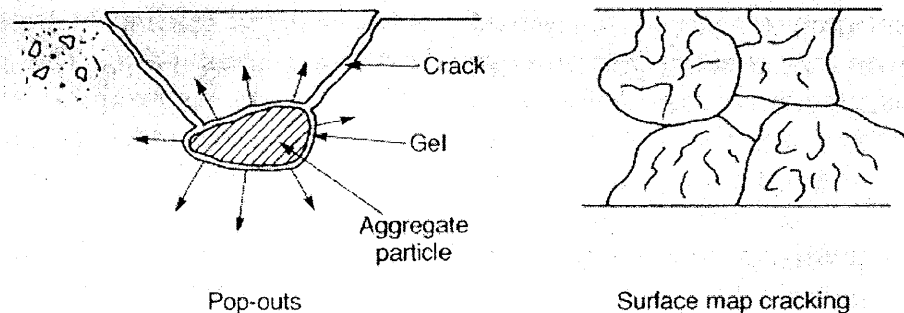

Figure 22. Cracking patterns resulting from ASR

### Extended Excavation Materials Categories

Based on the geologic origin, the excavation method and alkali reactivity the excavation materials are categorized as follows:

- **K1TBM and K1DB:** Class 1 materials excavated by TBM and D&B respectively.
- **K1arTBM and K1arDB:** Alkali reactive class 1 materials excavated by TBM and D&B respectively.
- **K2TBM and K2DB:** Class 2 materials excavated by TBM and D&B respectively.
- **K2arTBM and K2arDB:** Alkali reactive class 2 materials excavated by TBM and D&B respectively.
- **K3TBM and K3DB:** Class 3 materials excavated by TBM and D&B respectively.
- **K3arTBM and K3arDB:** Alkali reactive class 3 materials excavated by TBM and D&B respectively.

## Concrete and Aggregates

Two main types of concrete will be used in the Loetschberg base tunnel construction. These are shotcrete and regular concrete. Shotcrete is part of the initial support of the tunnel and concrete is used as the final support.

Shotcrete will be made using only non-alkali reactive materials, in particular of 60% 0/4 mm and 40% 4/8 mm aggregates. Alkali reactive materials can be used for concrete, although they should be avoided if possible. The aggregates in the concrete production will consist of 45% 0/4 mm, 15% 4/8 mm, 21% 8/16 mm and 19% 16/22 mm.

As stated in the project documents [Ingenieurgesellschaft E+B/IUB, BLS Alp Transit AG, 2000] K1 materials from every tunnel will be used for aggregate production as shown in Figure 23.

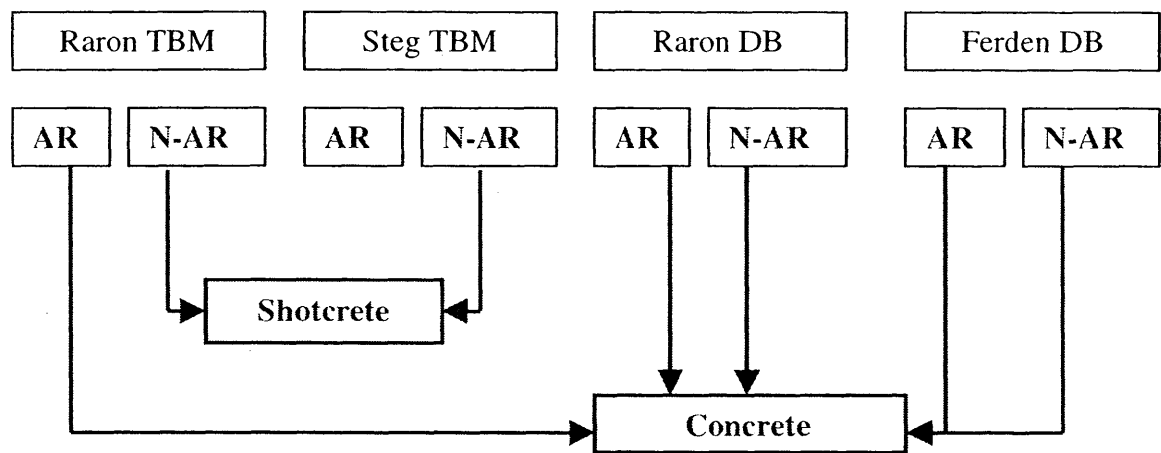

Figure 23. K1 Excavation Materials Flow

## Aggregates and Concrete Production

A crusher with a concrete plant is located at Raron (see Figure 21). All the applicable materials are transported there by rail and stored there until support operations start. Both the crusher's and the concrete plant's capacity, as stated in the project's documents, is approximately 240tn/hour that is 5760 ton/ day.

The size distribution of the crusher's production depending on the excavation method is shown in Table 4 and Table 5.

Table 4 Crusher Production for Drill & Blast Materials

Aggregates Size	Percentage (%)
0/4 mm	36
4/8 mm	12
8/16 mm	17
16/22 mm	15
Useless	20

Table 5. Crusher Production for TBM Materials

Aggregates Size	Percentage (%)
0/4 mm	48
4/8 mm	32
Useless	20

The useless materials do not qualify for concrete production and are basically mud and trash. They are transported by rail and deposited to the final repositories (see Figure 21).



## Chapter 5 Assumptions Made and Techniques Used

In this chapter the techniques that we used and the assumptions that we made in order to simulate the material resources of the Loetschberg base tunnel will be presented.

### Excavation Materials Categories Used for the Simulations

In order to simulate the materials resource process an important step was to identify all the parameters and all the possible options that could appear in the project.

Starting from the excavation materials categories (Chapter 4, Paragraph “Extended Excavation Materials Categories”) it was important to simplify the different options and create a less complex problem. After careful study of the project’s documents and interviewing the project engineers we reached the following conclusions, concerning the excavation materials categories that will be used for the simulation:

- Categories **K1TBM and K1DB**, which remain the same as the category stated in Chapter 4: Class 1 materials excavated by TBM and Drill & Blast.
- Categories **K1arTBM and K1arDB**, which remain the same as the category stated in Chapter 4: Alkali reactive class 1 materials excavated by TBM and Drill & Blast.
- Categories **K2TBM and K2DB**, which remain the same as the category stated in Chapter 4: Class 2 materials excavated by TBM and Drill & Blast.
- Categories **KuTBM and KuDB**, which include the categories K2arTBM and K2arDB, K3DB and K3DB, and K3arTBM and K3arDB stated in Chapter 4 and essentially represent the useless materials excavated by TBM and Drill & Blast.

From these categories K1TBM materials are suitable for shotcrete production, while K1DB and possibly K1arDB or K2DB can be used for concrete production. In simulations that will be presented in the following chapters we will show the results of varying the usage of these materials.

As one can easily see K1arTBM and K2TBM materials will not be used in the simulations as a variable, since those materials will most probably not be used in practice, either.

However they are not considered Ku materials and we might need to investigate their usage. In this case they have to be differentiated from the rest. These materials will stay in the repositories at the exit of the tunnels and form stocks there during the simulations. Their quantity can be measured after the simulations and therefore they can be added to the quantities of the useless materials (Ku), which form stocks in the in the final repositories during the simulations.

## Repositories Used for the Simulations

For the simulations we need repositories at the exit of the tunnels, where the excavated materials can be stored before they are transported to the aggregates plant or to the final repositories (Ferden repository, Steg repository, Raron DB repository and Raron TBM repository shown in Figure 24). We also need repositories at the aggregates plant where both the excavation materials are stored before entering the plant and also the produced aggregates are stored before they are transported to the concrete plant. Similarly a repository is needed at the concrete plant to store the produced shotcrete and concrete before they are transported to the tunnels. In Figure 21 of Chapter 5 we can see that the project uses many different final repositories for storage of the useless materials will. For simplicity, we assume that all the useless materials will be stored in one big final repository. A layout of the repositories as they are used in the simulations can be seen on Figure 24.

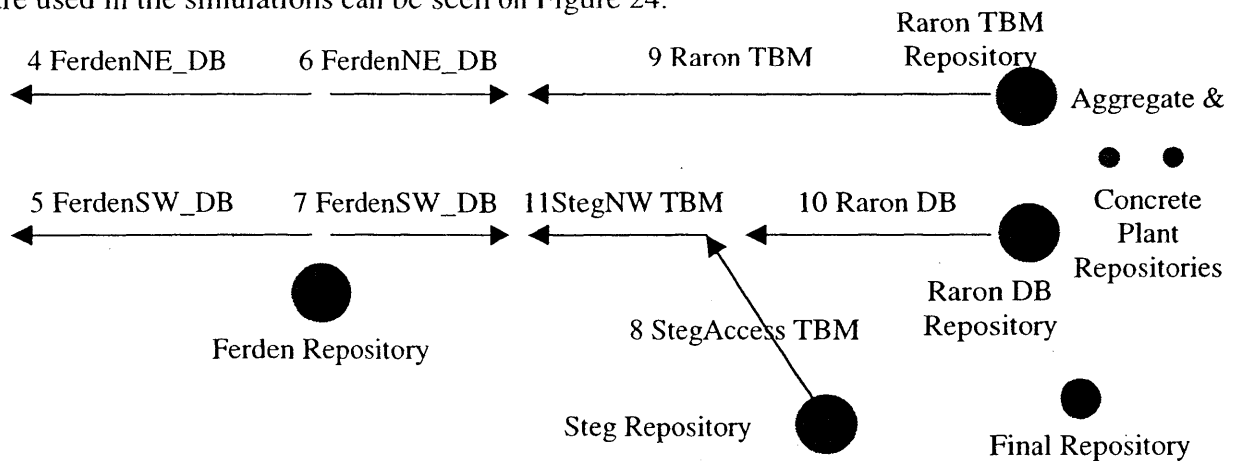

Figure 24. Repositories used for the Materials Management Simulations.

(Note that most of these repositories are “virtual” repositories used in the simulations and may or may not correspond to “real” ones)

## Simulations Techniques and Assumptions Made

As stated before the goal of this research is the simulation of the materials management of the southern part of the Loetschberg base tunnel using the DAT (Figure 7, Chapter 2 and Figure 13, Chapter 3). Simulations with SIMSUPER of the Loetschberg base tunnel were being made independently of this project by the Ecole Polytechnique Federale de Lausanne (EPFL) together with the engineering companies in charge of the project [Ingenieurgesellschaft E+B/IUB, BLS Alp Transit AG, 2000]. These simulations concentrate on the excavation duration and cost and don't include the material production and flows.

The existing data file<sup>9</sup> of the Loetschberg project (both South and North) as received from EPFL had either to be modified in order to use the resources model or a new one had to be created in order to simulate the South tunnels only and their resources. The first option “modification of the existing data file” was considered to be too complicated and too time consuming.

Thus, we decided to create a new data file that would simulate the excavation of the southern part of the project and the resources produced and used from the tunnels. The SIMSUPER software requires a huge amount of data that often need to be entered in many different parts of the software. For the simulation of the resources one had to introduce even more data and SIMSUPER's interface especially for the resources part would have required many non-productive working hours only to input the data in the software. Any additions, changes during the simulations together with the multiple scenarios that are required for a complete research would additionally increase the data input working hours, which of course was not the purpose of this research.

Therefore the creation of a user-friendlier interface for the SIMSUPER software that would limit the amount of input was needed, in order to simulate such a complex project as the resources of the Loetschberg tunnels. Cedric Marzer, who was at the time working in developing the resource model of the DAT, first created by Vijaya Bhayya Halabe an MIT Ph.D. student in 1987, contributed mainly to the development and the coding of this interface.

---

<sup>9</sup> Data file is the set of files that are created by SIMSUPER software, while using it [C. Indermitte, H. H. Einstein, 2000].

Information about this interface, called MBK<sup>10</sup>, can be found in Cedric's Marzer final report submitted in 2001 [C. Marzer, Decision Aids for Tunneling (DAT): Development of the Resource Model, 2001]. Also all the necessary information on this interface will be presented in Chapter 6 of this thesis.

Since we were now building a new interface we decided to make some assumptions to reduce the complexity created both by the project itself and by the endless capabilities of SIMSUPER software.

One of the assumptions was that all the tunnels will be independent of each other and therefore there will be no tunnel network or opposite tunnels as described in SIMSUPER software users manual and used in the simulations created by EPFL. However, by using "virtual resources"<sup>11</sup>, we created the possibility to introduce dependence<sup>12</sup> between tunnels or create opposite tunnels<sup>13</sup> in the MBK

Since opposite tunnels were not considered in this research, the start and end positions of the tunnels were obtained from the results of 100 simulations with the original Loetschberg data file<sup>14</sup> were run (see Table 3 of Chapter 3 for the average results). All the data input in MBK will be shown in the following chapters and any necessary explanations will be given.

---

<sup>10</sup> MBK comes from *Materialsbewirtschaftungskonzept* in German, which means *Materials Management Concept*.

<sup>11</sup> By "virtual resources" we characterize resources that are not really produced from the tunnels but are created by the user for the needs of the simulations.

<sup>12</sup> Dependency can be introduced by using "virtual" resources. One tunnel will produce a resource when it is finished and the following tunnel will only start when the resource is made available.

<sup>13</sup> Opposite tunnels can be created also by using "virtual" resources: the two tunnels use the same resource for each meter excavated. The total amount of this resource is equal to the total length of both tunnels. So the tunnels will run out of resources at the same time and stop when they meet.

<sup>14</sup> The file received from EPFL.

Another MBK assumption is that one geology is defined for every tunnel. This means that in the construction of two parallel tunnels, even if we input the same geological profiles for each tunnel, the result of a single simulation will result in different geological segments for each tunnel. Of course after running many simulations, which is done with the DAT, the results will converge to the same mean values.



## Chapter 6 MBK Interface

As stated before the complexity of the project together with the demands of SIMSUPER interface led to the creation of MBK. The main problem of SIMSUPER is the amount of data that has to be introduced by the user. A way had to be found to limit to the minimum the amount of data to be introduced in order to proceed with this research. This led to the creation of the MBK, which is an interface that generates the data for SIMSUPER.

The MBK interface is programmed in Java. The MBK interface has its own data structure that is not compatible with SIMSUPER. It is possible to open and save MBK files with MBK, but these files cannot be read by SIMSUPER. To run a simulation, it is necessary to export the data, by going to the file menu of MBK and click the “export” option. This exported data file can now be read by SIMSUPER. This is a one way process: files modified by SIMSUPER cannot be reopened by MBK. Figure 25 represents this procedure. More information about the structure of the structure of this software can be found in Cedric’s Marzer final report submitted in 2001.

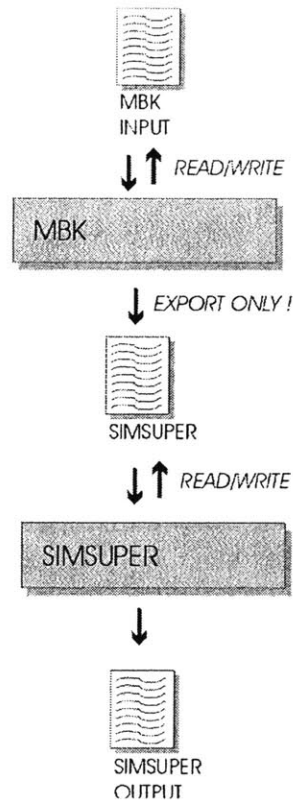

Figure 25. From MBK to SIMSUPER data files

## Creating a data file with MBK

MBK has four main branches: the materials branch, repositories branch, the tunnel branch and the flow branch. In the following an explanation of these branches will be provided.

### Materials in MBK

The materials branch contains the data describing all the different resources used in the simulation, including the excavation materials. Two characteristics are input. One is the resource name and the other is the density ( $\text{tn}/\text{m}^3$ ). The density of the material is used only for the excavation materials in order to convert them from  $\text{m}^3$  to tons. We do this conversion because it is easier to work with tons rather than transform insitu  $\text{m}^3$  of rock to  $\text{m}^3$  of excavated rock.

After the excavation materials are converted into tons for all the transportation and aggregates production processes we use tons. For the shotcrete and concrete production we use tons of aggregate that are needed to produce one  $\text{m}^3$  of shotcrete or concrete and in this way we convert again into  $\text{m}^3$  which is a suitable unit to use for shotcrete and concrete for the tunnel support. The units used for every stage of the simulation are shown in Figure 26.

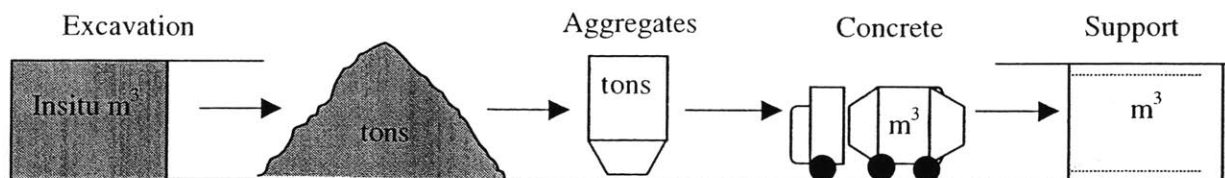

Figure 26. Units used in every stage of the simulation

In Figure 27 a representative window for the materials input of the MBK interface is presented.



## Tunnels in MBK

The tunnels branch contains most of the data used for the simulation. For each tunnel, a list of cross sections is defined. Each cross section contains data describing its rate, its resource needs and its surface area (used to calculate how many cubic meters of rock are excavated). Each tunnel also contains a list of the difficult cross sections used in zones where there is a special geological difficulty also called “geological accident”. The only difference between the normal cross sections and the difficult cross sections is that for the second the excavation material is input semi-deterministically (see below for details). For each tunnel two layers of zones are defined. The top layer describes the general geology and the lower layer describes the geological accidents (see Figure 29).

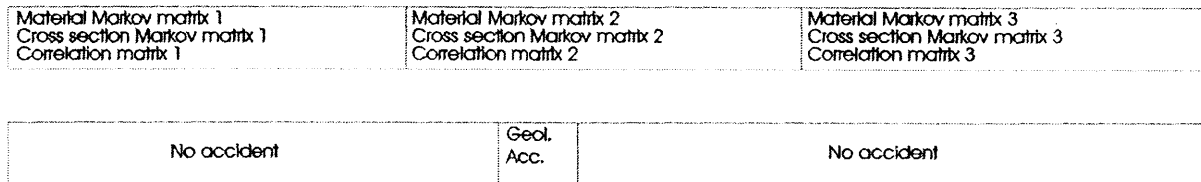

Figure 29. Geology as introduced

The zones of the first layer describe the length and the position of the general geology of the tunnel. The zones of the second layer describe the length and the position of the geological accidents only. The lengths and /or end positions of the zones in the first layer are defined with probabilistic values. Following this, for each zone of the first layer, there are additional probabilistic descriptions regarding the excavation materials and cross-sections:

- one Markov transition matrix and the mean lengths are introduced to generate the sequence of cross-sections.
- one Markov transition matrix and the mean lengths are introduced to generate a sequence of excavation materials
- a correlation matrix, which is used to define the relation between the given geology (cross-sections) and an excavation material. This matrix uses a correlation factor (a number between 0 and 1). When the number 0 is input, this means that the parameters never occur together, whereas when 1 is input it means that they always occur together. A correlation factor of 0.5 is the same as if nothing is input, since it means that the parameters have the same chance of occurring together. The correlation matrix

can be varied in different simulation scenarios. The scenarios along with the results of this research will be presented in Chapter 8. Also additional information for the correlation matrix can be found in the SIMSUPER user's manual.

Only one cross section and only one excavation material characterize each zone of the second layer and therefore we do not use Markov matrices. So both the cross section and the excavation materials type is a deterministic value for these zones. However, the length (or the end positions) of the zones of the second layer are defined probabilistically.

During the simulation, this information is used to generate one sequence of cross sections and one sequence of excavation materials for the whole tunnel (Figure 30). When a geological accident occurs, the normal cross section is replaced by the geological accident cross section. Of course its excavation material is also replaced by the geological accident excavation material.

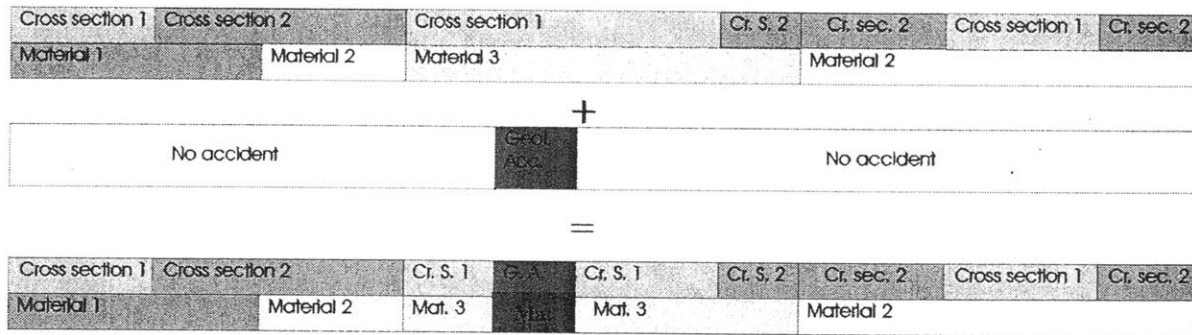

Figure 30. Result of a geological simulation

An MBK tunnel input window is presented in Figure 31A and Figure 32A. This is the most important window in the MBK interface, since it includes 90% of the data. The arrows that appear in the top left corner of the window are used to display the different tunnels. One can add, insert and delete tunnels with the buttons that can be seen on the top of the window at the right of these arrows.

In the left part of the window geometrical information about the tunnels is input. The name of the tunnel, the starting and the ending x, y positions used for its graphical representation, the beginning and the end locations (displayed on the SIMSUPER time-position graph) and the probabilistic values describing the delay before the excavation starts. Finally the name of the repository where tunnel resources (both excavation materials and

support) are stored can be inserted<sup>15</sup>. To find more information about these values, the reader is invited to consult the SIMSUPER user's manual.

The right part of the window consists of five tables. The first table from the top is a list of all the cross sections used in the tunnel. The second table describes the sequence of zones describing the geology. The third table is a list of all the geological accident cross sections. The fourth table is used to describe the probability that and the position where these accidents might occur. Finally, the fifth table is a list of the different excavation materials that the excavation of this tunnel could produce. On the right of each of these tables, there are buttons to add, insert, delete and edit the entries.

When the “edit” button of the first table (cross sections) is clicked in Figure 31B appears. In the first row, the name of the cross section is entered, while in the second the surface area of the cross section is inserted. This value is used to calculate the amount of excavation material that is being produced. The next five rows are used to enter the probabilistic values describing the excavation rate of this particular cross section. The table at the bottom of this dialog box can be used to enter the resources used or produced every meter by this cross section. For instance, it would be possible to specify that 5 rock bolts are used for each meter of this cross section.

When the edit button of the second table is clicked Figure 32F appears. Each line of this table is a geological zone and all the zones together describe the general geology of the tunnel. The limits of each zone are defined the same way as with SIMSUPER. On the right bottom corner of this window tree buttons are located. The “Edit Material Markov” button, the “Edit Cross Section Markov” button and the “Edit Correlation” button.

When the “Edit Material Markov” button in is clicked in Figure 32F, Figure 32G appears. In this figure two tables are displayed. The first represents the Markov transition matrix describing the sequence of the excavation materials and the second represents the Markov mean lengths and the starting probabilities associated with the excavation materials. The excavation materials that appear in the Markov matrix table are those entered in the last table of in the “tunnel” window, shown in Figure 31E.

---

<sup>15</sup> All these values can also be found in the SIMSUPER user's manual, under the tunnel description window.

When the “Edit Cross Section Markov” button is clicked in Figure 32F, Figure 32H appears. In this figure two tables are displayed. The first represents the Markov transition matrix describing the sequence of the cross sections and the second represents the mean Markov lengths and the starting probabilities associated with the cross sections.

And finally when the “Edit Correlation” button is clicked in Figure 32F, Figure 32I appears which is linking the cross sections with the excavation material of each zone.

When the edit button of the third table in Figure 31A (difficult cross-sections) is clicked, Figure 31C appears. This is exactly the same window Figure 31B with the only difference being an extra line that displays the material excavated by this difficult cross section.

Finally when the edit button at the right of the fourth table of the tunnel window is clicked, Figure 31D appears and a geological accident, its position or its length can be introduced<sup>16</sup>.

---

<sup>16</sup> The geological accident can take any value for the length (even zero). Also the words “dummy” or “neutral” have to be entered in the “AccXsection” field to characterize zones in which no accidents occur. By clicking in one of the two options at the bottom left corner in Figure 31D the user can input either positions or lengths for the accident zones. Refer to SIMSUPER user manual for more details

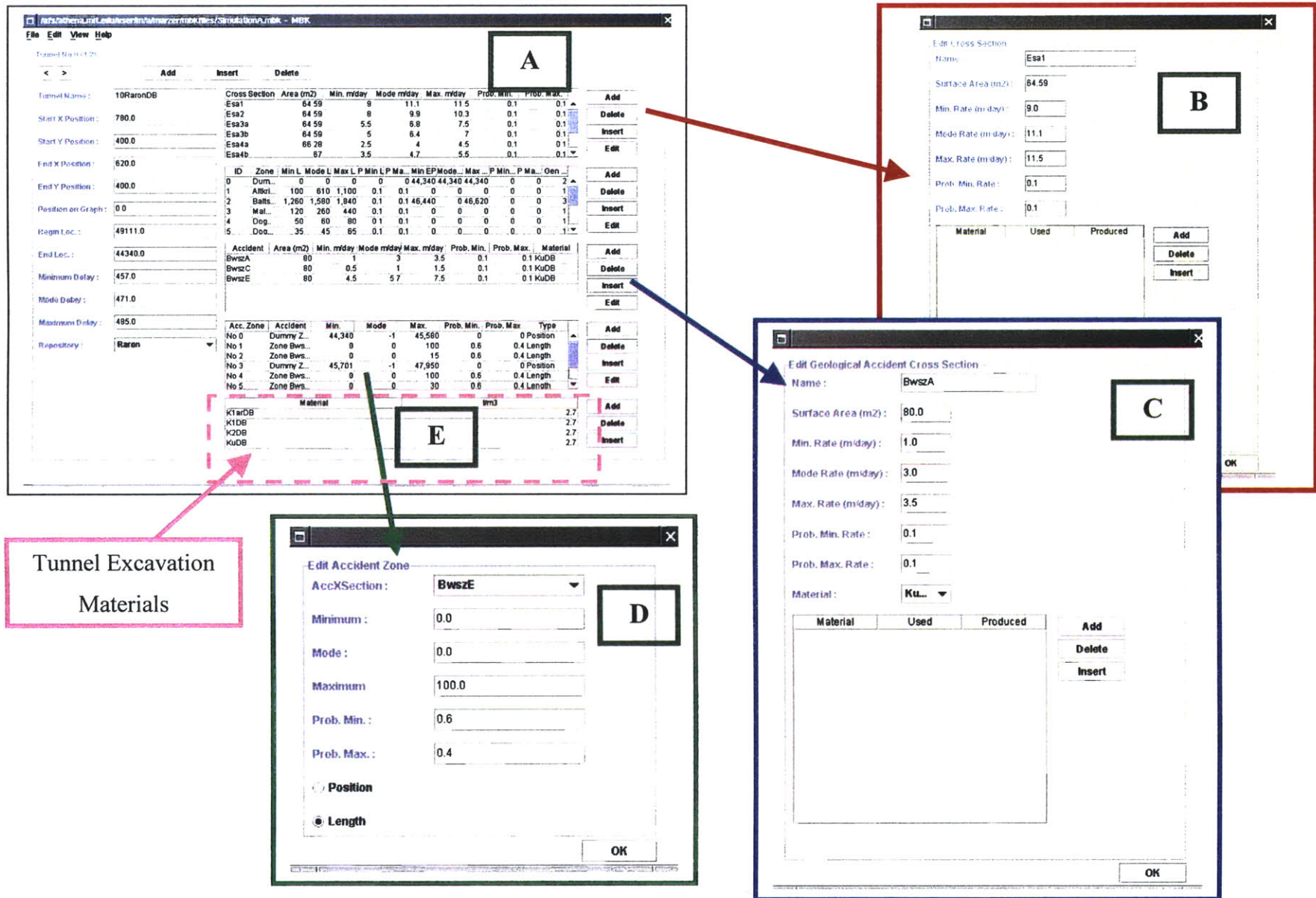

Figure 31. MBK Tunnel Input Windows-Cross Sections-Difficult Cross sections and Difficult Geological Zones

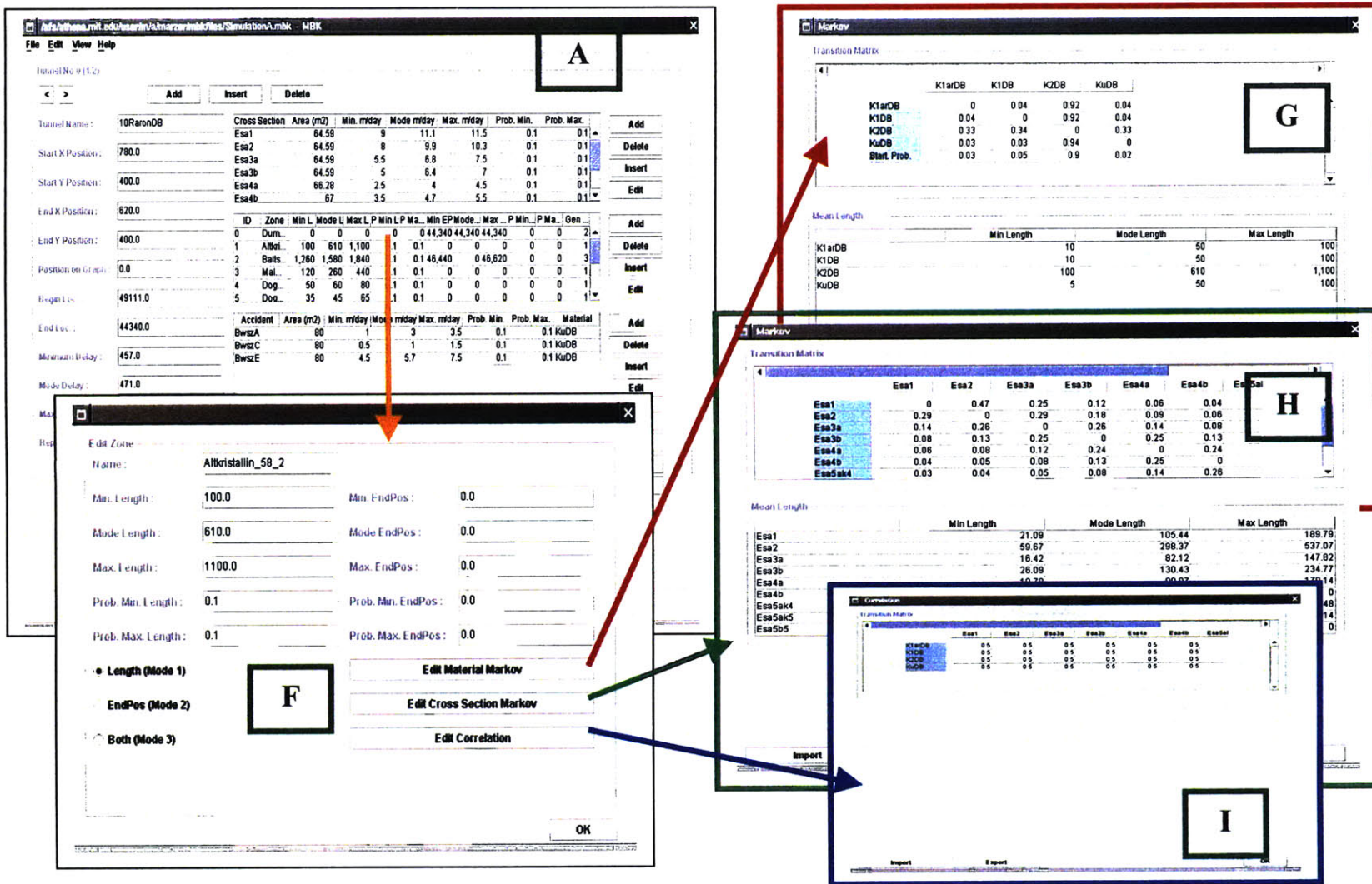

Figure 32. MBK Tunnel Input Windows- Geological Zones

## Flows in MBK

The flow branch contains data describing flows between repositories. The possibility to introduce flows is one of the major differences between the MBK interface and SIMSUPER. These flows can also be used to simulate the transformation of materials. Flows created by the MBK interface are not continuous flows. They are actually activities that take one or more resources from a repository and produce one or more resources in another (or the same) repository after a certain time. In Figure 33 an example is presented.



Figure 33. Presentation of a Flow

In this example tunnel 10RaronDB is being excavated and the materials are stored in a repository outside the tunnel (RaronDB). Then the process of aggregate production takes place and two flows are used to represent it. One flow is used to transport the excavation material from the repository in Raron to the aggregate production plant (MuckFlow) and another one is used to transform the excavation material into aggregates (AggProduction). The last AggProduction flow uses only one repository and therefore no length of the flow is shown in Figure 33. It is only indicated on the end node.

The “Flows” window of MBK is shown in Figure 34. One can see all the flows used by this simulation and some information about them<sup>17</sup>.

The screenshot shows a window titled 'SimulationB.mbk - MBK' with a menu bar (File, Edit, View, Help) and a toolbar with buttons for Edit, Insert, Add, and Delete. Below the toolbar is a table with the following data:

ID	Name	Org. Rep.	Dest. Rep.	Duration	Priority	Max. Nb of Transp.
0	AggProduction	AggregatesPlant	AggregatesPlant	0.042	1	10000000
1	MuckFlow	RaronDB	AggregatesPlant	0.042	1	10000000

Figure 34. Flow window in MBK inreface

When the edit button is clicked Figure 35 appears and a dialog box with the data describing the flow are displayed. In this example in Figure 35 one can see the data used to transform the excavation material (In this case the excavation material is only K1DB) into aggregates.

<sup>17</sup> These values cannot be directly edited from this window. One has to select a flow and press the “Edit” button in order to modify them.

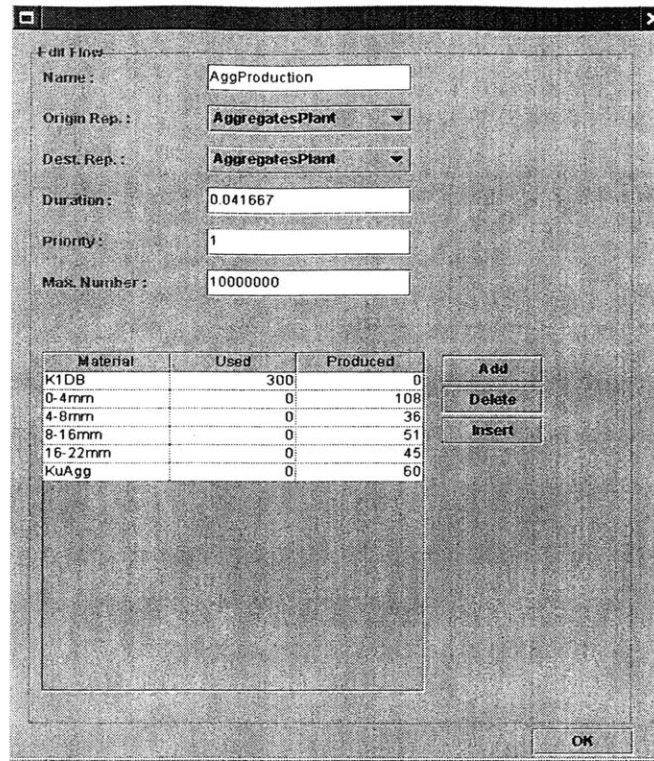

Figure 35. Aggregates Production Information Flow Window

In this flow the origin repository and the destination repository are the same repository, namely the “AggregatesPlant” repository. The resource taken from the origin repository and the resource put into the destination repository are input into the table at shown at the bottom. 300 tons of K1DB are taken from the Aggregate plant and after the duration of 1hour (0.041667 day) they become aggregates. The results of this transformation are that 108 tons of 0-4mm aggregates, 36 tons of 4-8mm aggregates, 51 tons of 8-16mm aggregates, 45 tons of 16-22mm aggregates and 60 tons of waste (KuAgg) are produced at the same repository (AggregatePlant).

The priority text field is used to define which flow has the priority to obtain the resource in the origin repository or the space in the destination repository (for more information about the priorities please refer to the SIMSUPER user manual). The ”Max. Number” represents the possible maximum number of times that a flow/activity will take place<sup>18</sup>. In the example presented in Figure 35 a large number (100'000'000) was chosen to

---

<sup>18</sup> For instance if 1 is entered in this field, resources will be taken only once from the origin repository and will be put once in the destination repository.

make sure the flow will continue, as long as resources exist, until the end of the simulation. Entering 100'000'000 in this field means that no more than 300x100'000'000 tons of K1DB will be transformed.

A similar dialog box describes the second flow (i.e. MuckFlow) used in this simulation. For this flow the origin and the destination repository are different. 500 tons of K1DB material is taken from the “RaronDB” repository, and after 1 hour, 500 tons of K1DB material are put into the “AggregatesPlant” repository. Figure 37 shows this flow.

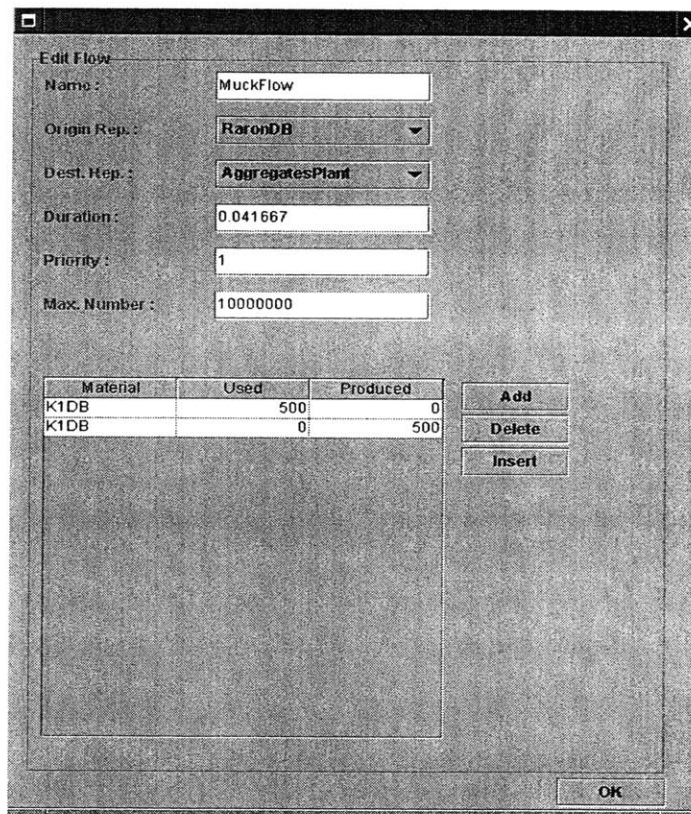

Figure 36. A Flow between two Different Repositories



# **Chapter 7 Data Input for the materials management of the Loetschberg BaseTunnel**

In this Chapter all the data input in the MBK program (mentioned in Chapter 6) will be presented. For the data presentation the same order as the one in Chapter 6 will be followed.

## **Resources Data**

In this paragraph the resources information will be given as it was input in the materials window in the MBK program. Figure 37 is a snapshot from MBK that shows all the resources.

### **Excavation Resources**

During the simulation the following resources were used to characterize the excavation output:

- For the tunnels excavated by Drill and Blast the resources are K1DB, K1arDB, K2DB, KUDB. The  $\text{tn/m}^3$  ratio for those materials is 2.7.
- For the tunnels excavated by TBM the resources are K1TBM, K1arTBM, K2TBM, KUTBM. The  $\text{tn/m}^3$  ratio for those materials is 2.7.

### **Aggregates Resources**

During the simulation the following resources were used to characterize the aggregates production:

- For the aggregates produced from Drill & Blast excavated tunnels the resources are 0-4mmDB, 4-8mmDB, 8-16mmDB, 16-22mmDB, 0-4mmDBar, 4-8mmDBar, 8-16mmDBar and 16-22mmDBar.

- For the aggregates produced from TBM excavated tunnels the resources are 0-4mmTBM, 4-8mmTBM, 0-4mmTBMar and 4-8mmTBMar.

For the waste produced during the aggregate production the resource is KuAgg.

## **Support Resources**

During the simulation we used shotcrete and concrete as the resources that represent the initial and the final support of the tunnels.

## **Auxiliary Resources**

For the needs of the simulation we used some “virtual” resources that help us control the starting and the ending points of some activities. Since in the resources model of the DAT one task does not start until the resources needed are available we can use virtual resources to start or stop one activity. For this simulation we used the “virtual” resources presented below:

### **Resources named “progressX”**

We used this type of resources as products of the excavations. These resources named “progressX” represent the progress of each tunnel “X”, where “X” is the tunnel number as given in the project documents and used in all the parts of the simulation.

In order to explain the meaning of this resource we can take as an example the “progress10” resource. One unit of this resource is produced for every meter of excavation of the tunnel number 10, which in this case is the 10RaronDB tunnel. This means that after the excavation of 10RaronDB tunnel is over, the number of units of the resource “progress10” produced will be equal to the excavation length. Using a number of units of this resource (progress10) as a need for the Lining10DB tunnel<sup>19</sup> we can relate the beginning of the Lining10DB tunnel with the excavation of 10RaronDB tunnel. For example if the length of 10RaronDB tunnel is 1000 m, it will produce 1000 units of “progress10”. A need of 500 units

---

<sup>19</sup> Lining10DB tunnel is the tunnel used to represent the final support of tunnel 10. Please refer to paragraph “Tunnel Data” of this chapter.

of “progress10” for the Lining10DB tunnel means that the tunnel will not start until 500 units are available which is equivalent with 500 m excavation of the 10RaronDB tunnel.

In this simulation we have used, apart from progress10, progress11, progress9, progress8, progress7, progress6, progress5 and progress4 respectively for the rest of the tunnels.

### **Resources named “ShotcreteXstop”**

We also used this type of resources as “virtual” products of the excavations. These resources named “ShotcreteXstop” represent the progress of each tunnel “X”, where “X” is the tunnel number as given in the project documents. Every time a meter is being excavated a unit of the resource “ShotcreteXstop” is being produced. In parallel every time shotcrete is transported to the tunnel a unit of the resource “ShotcreteXstop” is used. This allows one to stop the transportation of a resource; in this simulation it is used to stop the transportation of shotcrete (from the concrete plant to the tunnels) after the excavation of each tunnel finishes and the last meter of the initial support is placed.

### **Resources named “LiningproX”**

The same idea is followed in the lining of tunnels as well. The resources named “LiningproX” represent the progress of each lining tunnel “X”, where “X” again is the lining tunnel number that is the same as that of the actual tunnel. Every time a lining tunnel is advanced by one meter a unit of the resource “LiningproX” is being produced. In parallel every time concrete is transported to the lining tunnel a unit of the resource “LiningproX” is used. This “virtual” resource works the same way as the resource “ShotcreteXstop” discussed above. The only difference is that it is used for the Lining tunnels instead of being used in the actual tunnels.

File Edit View Help

Material

Insert Add Delete

Material	t/m3
K1arTBM	2.7
K1arDB	2.7
K1TBM	2.7
K1DB	2.7
K2TBM	2.7
K2DB	2.7
KuDB	2.7
KuTBM	2.7
0-4mmDB	1
4-8mmDB	1
4-8mmDBar	1
0-4mmDBar	1
8-16mmDB	1
16-22mmDB	1
8-16mmDBar	1
16-22mmDBar	1
0-4mmTBM	1
4-8mmTBM	1
4-8mmTBMar	1
0-4mmTBMar	1
Shotcrete	1
Concrete	1
progress10	1
KuAgg	2.7
Dummy1	2.7
Dummy2	2.7
progress9	1
progress8	1
progress11	1
progress6	1
progress7	1
progress4	1
progress5	1
Linpro4567	1
Linpro9	1
Linpro10	1
Linpro811	1
Shotcrete10stop	1
Shotcrete811stop	1
Shotcrete4567stop	1
Shotcrete9stop	1

Figure 37. Resources Used in the Loetschberg Base Tunnel Simulation

## Repositories Data

In the present version of the SIMSUPER program there is only one actual repository named “Default” in which multiple stocks may exist. However, in such complex projects, it is extremely difficult to handle the different resources with only one repository. The minimum number of repositories we needed was mentioned in chapter 5 and can be seen in Figure 24.

The technique we used to solve this problem was the use of “virtual” repositories. Since only one repository, the “Default”, exists in SIMSUPER we used MBK<sup>20</sup> to represent the number of repositories we needed. With MBK we can have as many repositories as we want and each can store many resources. This combination, of repositories and resources in MBK, is transformed into resources when transferred to SIMSUPER as shown in Figure 38.

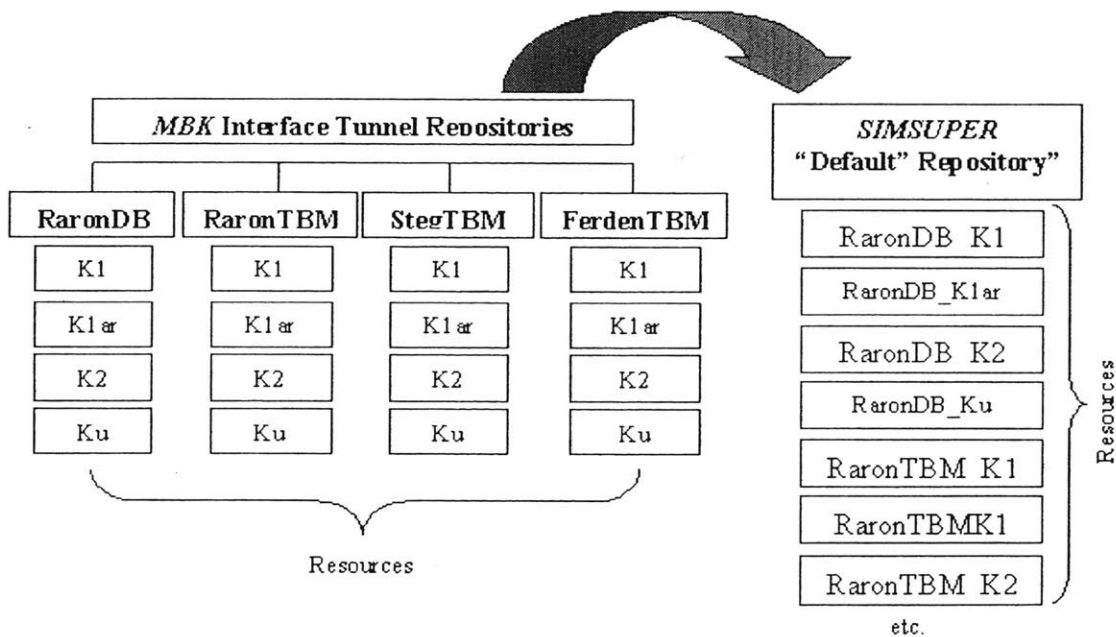

Figure 38. MBK vs. SIMSUPER Repositories

<sup>20</sup> The MBK software generates files that are compatible with the current version of SIMSUPER software, in which multiple repositories as stated above do not exist. During this research a new version of SIMSUPER was created, which includes multiple repositories. MBK was not correspondingly updated and therefore the new option of having multiple repositories with SIMSUPER could not be used.

As stated before and shown in Figure 24 for the purposes of the simulations we used the following “virtual” repositories.

## **Repositories at the Exit of the Tunnels**

- Raron DB Repository (
- Figure 39): All the excavated materials from the Raron DB tunnel are being stored here.
- Raron TBM Repository (**Error! Reference source not found.**): All the excavated materials from the Raron TBM tunnel are being stored here.
- Steg TBM Repository (Figure 41): All the excavated materials from the Steg TBM tunnels are being stored here.
- Ferden DB Repository (Figure 42): All the excavated materials from all the Ferden DB tunnels are being stored here.

## **Repositories at the Plants**

- Aggregates Plant Repository (Figure 43): All the excavated materials that can be used for aggregate production are transported there.
- Concrete Plant Repository (Figure 44): All the different aggregate sizes are transported there for shotcrete and concrete production.

## **Final Repository**

All the useless (Ku, K1arTBM or K2<sup>21</sup>) excavated materials and the muck that is produced at the crusher (KuAgg) are transported and deposited in the final repository (Figure 45).

---

<sup>21</sup> K2 materials are transported to the final repositories only when they are not used for aggregate production.

File Edit View Help

Repository No 0 (1/7)

< > Add Insert Delete

Repository Name: RaronDB

X Position: 780.0

Y Position: 400.0

Material	Initial Level	Maximum Level
K1arDB	0	100,000,000
K1DB	0	100,000,000
K2DB	0	100,000,000
KuDB	0	100,000,000
Shotcrete	45	45
Concrete	11	100,000,000
progress10	0	100,000,000
Linpro10	0	100,000,000
Dummy1	0	100,000,000
Dummy2	0	100,000,000
Shotcrete10stop	0	100,000,000

Insert Add Delete

Figure 39. Raron DB Repository

File Edit View Help

Repository No 4 (5/7)

< > Add Insert Delete

Repository Name: RaronTBM

X Position: 780.0

Y Position: 600.0

Material	Initial Level	Maximum Level
K1arTBM	0	10,000,000
K1TBM	0	10,000,000
K2TBM	0	10,000,000
KuTBM	0	10,000,000
Shotcrete	45	45
progress9	0	10,000,000
Concrete	11	10,000,000
Dummy1	0	10,000,000
Dummy2	0	10,000,000
Linpro9	0	10,000,000
Shotcrete9stop	0	10,000,000

Insert Add Delete

Figure 40. Raron TBM Repository

File Edit View Help

Repository No 5 (7/7)

< > Add Insert Delete

Repository Name: StegTBM

X Position: 700.0

Y Position: 200.0

Material	Initial Level	Maximum Level
K1arTBM	0	10,000,000
K1TBM	0	10,000,000
K2TBM	0	10,000,000
KuTBM	0	10,000,000
Shotcrete	45	45
Concrete	11	10,000,000
Dummy1	0	10,000,000
Dummy2	0	10,000,000
Linpro811	0	10,000,000
progress8	0	10,000,000
progress11	0	10,000,000
Shotcrete811stop	0	10,000,000

Insert Add Delete

Figure 41. Steg DB Repository

File Edit View Help

Repository No 5 (6/7)

< > Add Insert Delete

Repository Name: FerdenDB

X Position: 450.0

Y Position: 350.0

Material	Initial Level	Maximum Level
K1DB	0	10,000,000
K1arDB	0	10,000,000
K2DB	0	10,000,000
KuDB	0	10,000,000
Shotcrete	45	45
Concrete	11	10,000,000
progress4	0	10,000,000
Dummy1	0	10,000,000
Dummy2	0	10,000,000
Linpro4567	0	10,000,000
progress5	0	10,000,000
progress6	0	10,000,000
progress7	0	10,000,000
Shotcrete4567stop	0	10,000,000

Insert Add Delete

Figure 42. Ferden DB Repository

File Edit View Help

Repository No 1 (2/7)

< > Add Insert Delete

Repository Name:

X Position:

Y Position:

Material	Initial Level	Maximum Level
KuAgg	0	10,000,000
0-4mmDB	0	10,000,000
0-4mmDBar	0	10,000,000
4-8mmDB	0	10,000,000
4-8mmDBar	0	10,000,000
8-16mmDB	0	10,000,000
8-16mmDBar	0	10,000,000
16-22mmDB	0	10,000,000
16-22mmDBar	0	10,000,000
0-4mmTBM	0	10,000,000
0-4mmTBMar	0	10,000,000
4-8mmTBM	0	10,000,000
4-8mmTBMar	0	10,000,000
K1arTBM	0	10,000,000
K1DB	0	10,000,000
K1arDB	0	10,000,000
K1TBM	0	10,000,000

Insert Add Delete

Figure 43. Aggregates Plant Repository

File Edit View Help

Repository No 3 (4/7)

< > Add Insert Delete

Repository Name:

X Position:

Y Position:

Material	Initial Level	Maximum Level
Shotcrete	0	10
Concrete	0	20
Linpro4567	0	10,000,000
Linpro9	0	10,000,000
Linpro10	0	10,000,000
Linpro811	0	10,000,000
Shotcrete811 stop	0	10,000,000
Shotcrete9stop	0	10,000,000
Shotcrete4567 stop	0	10,000,000
Shotcrete10stop	0	10,000,000

Insert Add Delete

Figure 44. Concrete Plant Repository

File Edit View Help

Repository No 2 (3/7)

< > Add Insert Delete

Repository Name:

X Position:

Y Position:

Material	Initial Level	Maximum Level
KuDB	0	10,000,000,000
KuTBM	0	10,000,000,000
KuAgg	0	10,000,000,000

Insert Add Delete

Figure 45. Final Repository

## Tunnel Data

Apart from the excavated tunnels that have been mentioned several times, for the purposes of the simulations we also used “tunnels” to represent the lining process. These tunnels called “lining tunnels” are shown in Figure 46.

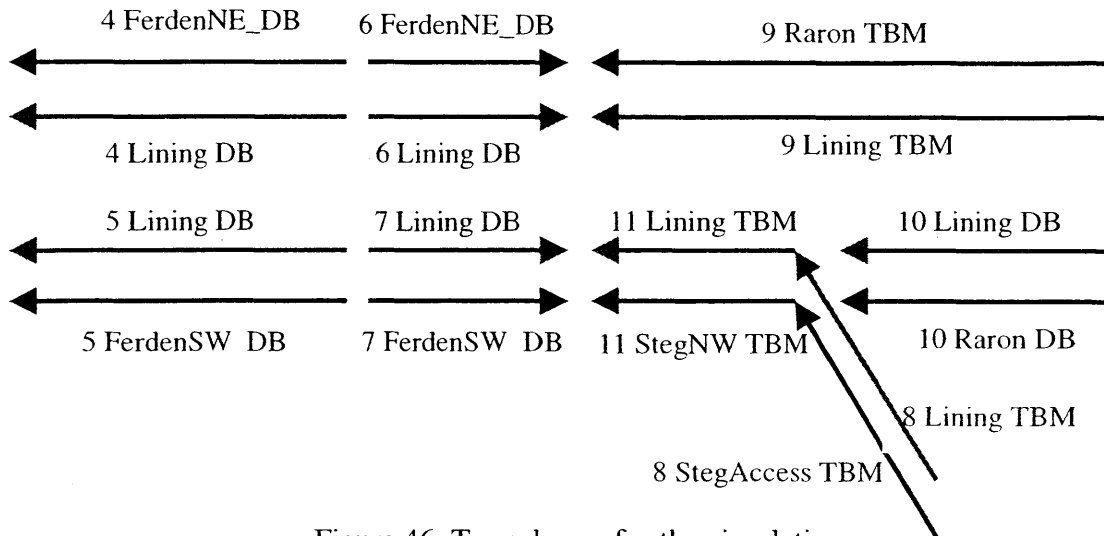

Figure 46. Tunnels use for the simulation

The lining tunnels as one can notice have exactly the same length as the represented excavated tunnel but they do not have any real information about the geology, the construction method and all the input SIMSUPER needs in order to run a simulation. They do not produce any excavation material but they only use an amount of concrete per meter of advance.

Having said all the above we now present all the data that we input into the MBK interface in order to create the new data files. All the data was taken from the original Loetschberg data file. As stated before some of these data (i.e. the repositories, the end and start positions of the tunnels etc.) had to be modified to meet the specifications of this research. Specifically, since we do not use opposite tunnels, we had to input the start and end positions of the tunnels as they resulted after the 100 simulations with the original data file. As one can see in Chapter 3, these simulations resulted in some average meeting points. Some of them happen to be within the predefined length of a geologic zone. In these cases we had to adjust these meeting points and place them at the end or the beginning of the geologic zone.

The new points are very close to the average ones (resulting from the simulation of the original Loetschberg data file).

For simplicity in the next paragraph we will present the data only for 10 Raron DB tunnel. Similar data for the rest of the tunnel network can be found in Appendix B.

## 10 Raron DB Tunnel

Table 6 summarizes all the information discussed above which will be used in the simulations.

Table 6. 10 Raron DB Information Table

Tunnel	Dummy Tunnel	10 Raron Drill and Blast Tunnel										
Zone Nb	1	2	3	4	5	6	7	8	9	10	11	
Zone	Dummy	Altkristallin	Baltsch Granodiorit	Malm	Dogger	Dogger	Dogger Aalenien	Lias	Schuppenzone	Altkristallin	Trias	
END POSITION (m)	44,340	44,960	46,630	46,790	46,860	46,896	47,640	48,370	48,660	49,090	49,111	
Meters		610	1580	260	60	45	745	730	280	440	11	
K1DB (t)				43,798								
K1arDB (t)								111,764				
K2DB (t)			891,546 Parly Ku									
KuDB (t)						244,186					86,119	

Figure 47 shows the MBK “tunnel” window for 10 Raron DB tunnel. The information in this window is briefly discussed below.

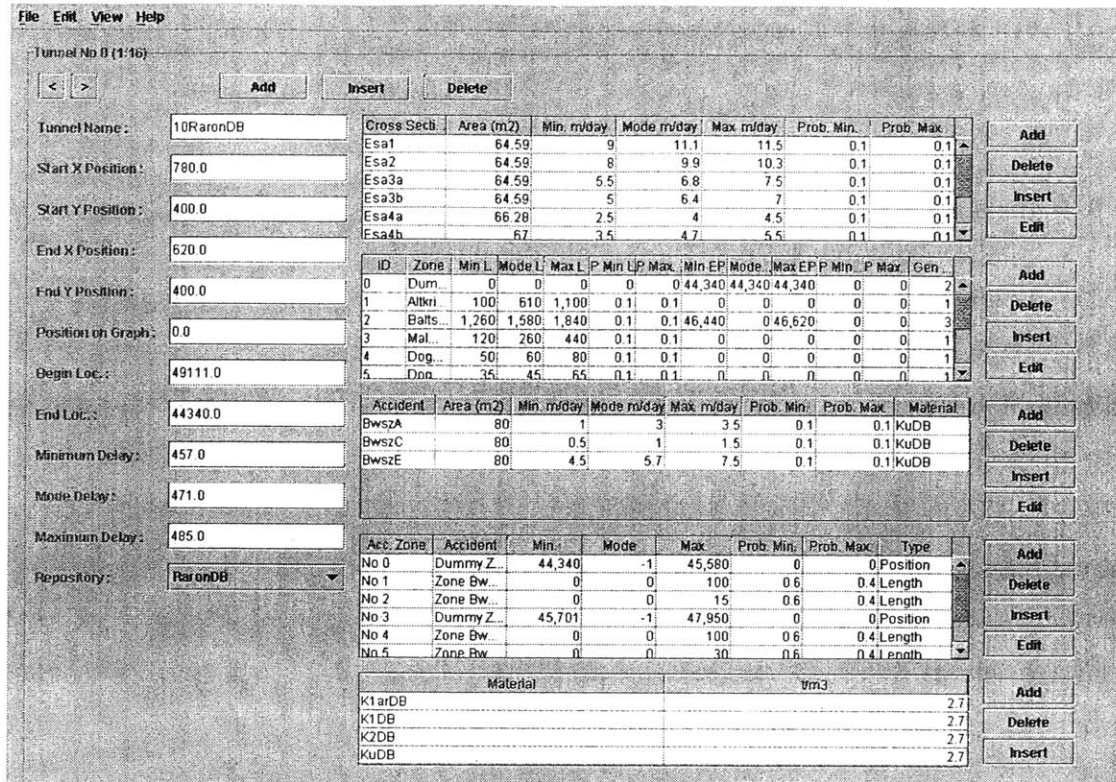

Figure 47. 10 Raron DB MBK Tunnel Window

**Begin Location (m):** 49111, **End Location (m):** 44340.

**Starting Delays (days):** minimum: 457.0, mode: 471, maximum: 485.

**Repository:** Raron DB

**Cross- sections:** ESA1, ESA2, ESA3a, ESA3b, ESA4a, ESA4b, ESA5ak4, ESA5ak5 and ESA5b5.

**Difficult cross- sections:** BwszA, BwszC, BwszE.

The area (m<sup>2</sup>) and the advance rates of all the cross-sections are listed in Table 2 of Chapter 3.

**Geologic Zones:** Information about the geologic zones as shown in SIMSUPER is presented in Figure 48 and Figure 49. As can be seen this tunnel has eleven geologic zones. Two Markov matrices characterize each zone. One is the Markov matrix that characterizes the cross- sections. The cross-section Markov matrices are taken from the original data file of the Loetschberg (It can be seen in Appendix C). The second Markov matrix, which describes the excavation materials, was created based on Table 6. The calculations and the Markov matrices are presented in the next paragraph.

**Difficult Zones:** The data are shown in Figure 50<sup>22</sup>. For these zones the excavation material is a deterministic value and therefore a Markov value is not needed.

### Calculations and Markov Transition Matrices

As stated above there are two Markov Matrices that characterize both the cross-sections and the excavation materials. The matrices of the cross-sections are presented in Appendix C, while the excavation Markov matrices for every zone we be will presented below.

#### *Zone Nb.2 Altkristalin and Nb 3 Baltschieder Granodiorit*

As one can see in Table 6 these two zones will produce mainly K2 non alkali- reactive materials and “partly” Ku materials. We have translated this “partly” as a 20% possibility and so the excavated materials Markov transition Matrix  $P_{zone2} = P_{zone3}$  will be the following:

$$P_{zone2} = \begin{matrix} & \begin{matrix} K1ar & K1 & K2 & Ku \end{matrix} \\ \begin{matrix} K1ar \\ K1 \\ K2 \\ Ku \end{matrix} & \begin{pmatrix} 0 & 0 & 0.8 & 0.2 \\ 0 & 0 & 0.8 & 0.2 \\ 0 & 0 & 0 & 1 \\ 0 & 0 & 1 & 0 \end{pmatrix} \end{matrix}$$

This 20% possibility can be varied in different simulations and the differences in the results can be observed. For this particular zone any variance in this possibility will not effect the simulations significantly since K2 and of course KU materials are will not be used for aggregate production.

---

<sup>22</sup> The two tables presented in this figure should be considered as one, since the bottom table is the right part of the top table. They are displayed here separately due to limitations of the page width.

• **Zone Nb.4 Malm**

From Table 6 one can see that all the excavated materials are K1 non alkali- reactive. In order to represent this in a Markov matrix we have to input the value 1 (100%) in all the transition probabilities of the “K1” column. But, since the diagonal of the matrix has to have zero values and all the rows have to add to probability of 1 (100%), we need to give some probabilities for the rest of the materials in the “K1” row. In this case we assume a 50% probability for both the presence of K1ar or K2 materials after the K1 material has occurred. Thus the resulting excavated materials transition Markov Matrix  $P_{zone4}$  will be the following: (Similar calculations apply in the other excavation material Markov matrices)

$$P_{zone4} = \begin{matrix} & \begin{matrix} K1ar & K1 & K2 & Ku \end{matrix} \\ \begin{matrix} K1ar \\ K1 \\ K2 \\ Ku \end{matrix} & \begin{pmatrix} 0 & 1 & 0 & 0 \\ 0.5 & 0 & 0.5 & 0 \\ 0 & 1 & 0 & 0 \\ 0 & 1 & 0 & 0 \end{pmatrix} \end{matrix}$$

• **Zones Nb. 5, 6 Dogge, 7 Dogger Aalenien, 9 Schuppenzone, 10 Alktristallin and 11 Trias**

From Table 6 we can see that all the excavated materials are Ku. This means that the possibility of excavating a suitable for aggregate production material in this zone is low. In these cases we will not consider any distribution on the other material types and therefore the resulting excavated materials transition Markov Matrix  $P_{zone5} = P_{zone6} = P_{zone7} = P_{zone9} = P_{zone10} = P_{zone11}$  will be the following:

$$P_{zone5} = \begin{matrix} & \begin{matrix} K1ar & K1 & K2 & Ku \end{matrix} \\ \begin{matrix} K1ar \\ K1 \\ K2 \\ Ku \end{matrix} & \begin{pmatrix} 0 & 0 & 0 & 1 \\ 0 & 0 & 0 & 1 \\ 0 & 0 & 0 & 1 \\ 0 & 0 & 1 & 0 \end{pmatrix} \end{matrix}$$

• *Zone Nb.8 Lias*

The information we have on this zone is that both K1ar and Ku materials will be excavated. The zone is 730m and the average cross- section area is 70m<sup>2</sup>, so the total tons excavated will be 730m\*70m<sup>2</sup>\*2.7 t/m<sup>3</sup> = 137,970tons. In table 6 we can see that 111,764tons will be the K1ar materials. This means that the percentage of the Ku materials is:

$$\%Ku = \frac{137,970 - 111,764}{137,970} \approx 0.2 = 20\%$$

So,

$$P_{\text{zone8}} = \begin{matrix} & \begin{matrix} \text{K1ar} & \text{K1} & \text{K2} & \text{Ku} \end{matrix} \\ \begin{matrix} \text{K1ar} \\ \text{K1} \\ \text{K2} \\ \text{Ku} \end{matrix} & \begin{pmatrix} 0 & 0 & 0 & 1 \\ 0.8 & 0 & 0 & 0.2 \\ 0.8 & 0 & 0 & 0.2 \\ 1 & 0 & 0 & 0 \end{pmatrix} \end{matrix}$$

Similar information for the rest of the tunnels will be presented in Appendix B.

Zones							
File Options Table							
	Zone 1	Zone 2	Zone 3	Zone 4	Zone 5	Zone 6	Zone 7
Name	Dunmu_10RaronDB	Altkristallin_58_2	Baltsch_Granodiorit	Malm_60_4	Dogger_61_5	Dogger_62_6	Dogger_Aalenien_63_7
Generation mode	2	1	3	1	1	1	1
Min length	--	100.00	1260.00	120.00	50.00	35.00	600.00
Mode length	--	610.00	1580.00	260.00	60.00	45.00	745.00
Max length	--	1100.00	1840.00	440.00	80.00	65.00	900.00
Prob. Min length	--	0.10	0.10	0.10	0.10	0.10	0.10
Prob. Max length	--	0.10	0.10	0.10	0.10	0.10	0.10
Min end pos	44340.00	--	46440.00	--	--	--	--
Mode end pos	44340.00	--	--	--	--	--	--
Max end pos	44340.00	--	46620.00	--	--	--	--
Prob. Min pos	0.00	--	--	--	--	--	--
Prob. Max pos	0.00	--	--	--	--	--	--
Ground param. set	1	2	3	4	5	6	7

Figure 48. Geologic Zones 1-7 of the 10 Raron DB Tunnel

Zones			
File Options Table			
	Zone 8	Zone 9	Zone 10
Name	Lias_64_8	Schuppenzone_65_9 to	Altkristallin_68_14
Generation mode	1	3	2
Min length	675.00	165.00	--
Mode length	730.00	280.00	--
Max length	785.00	385.00	--
Prob. Min length	0.10	0.10	--
Prob. Max length	0.10	0.10	--
Min end pos	--	48630.00	49090.00
Mode end pos	--	--	49090.00
Max end pos	--	48670.00	49090.00
Prob. Min pos	--	--	1.00
Prob. Max pos	--	--	0.00
Ground param. set	8	9	10

Figure 49. Geologic Zones 7-11 of the 10 Raron DB Tunnel

Semi Deterministic Values, Set: 12 - Parameter: 10RaronDB_Accident (ref. Area)							
File	Option	Table					
	State Name	Generation Mode	Min. Position	Mode Position	Max. Position	Prob Min.	Prob Max.
Row 1	None	Position	44340,00	-1,00	45580,00	0,00	0,00
Row 2	BuszE	Length	---	---	---	---	---
Row 3	BuszC	Length	---	---	---	---	---
Row 4	None	Position	45701,00	-1,00	47950,00	0,00	0,00
Row 5	BuszE	Length	---	---	---	---	---
Row 6	BuszA	Length	---	---	---	---	---
Row 7	BuszC	Length	---	---	---	---	---
Row 8	None	Position	49111,00	49111,00	49111,00	0,00	0,00
Row 9							

Semi Deterministic Values, Set: 12 - Parameter: 10RaronDB_Accident (ref. Area)							
File	Option	Table					
	Mean Position	Min. Length	Mode Length	Max. Length	Prob Min.	Prob Max.	Mean Length
Row 1	44960,00	---	---	---	---	---	---
Row 2	---	0,00	0,00	100,00	0,60	0,40	40,00
Row 3	---	0,00	0,00	15,00	0,60	0,40	6,00
Row 4	46925,50	---	---	---	---	---	---
Row 5	---	0,00	0,00	100,00	0,60	0,40	40,00
Row 6	---	0,00	0,00	30,00	0,60	0,40	12,00
Row 7	---	0,00	0,00	15,00	0,60	0,40	6,00
Row 8	49111,00	---	---	---	---	---	---
Row 9							

Figure 50. Difficult Zones in 10 Raron DB Tunnel

## Flows Data

In Figure 51 is a graphical representation of all the flows used for the simulation of the south part of the Loetschberg Base Tunnel, as shown in the MBK interface. This window appears when the “view” tab is clicked and the “map” option is selected. As one can see all the flows originate and terminate at the repositories that are at the exit of the tunnels. As stated before this is only a graphical representation of the flows, all the data information is inserted in the “Flows”<sup>23</sup> window. Figure 52 is the “Flow” window used for Simulation A<sup>24</sup>.

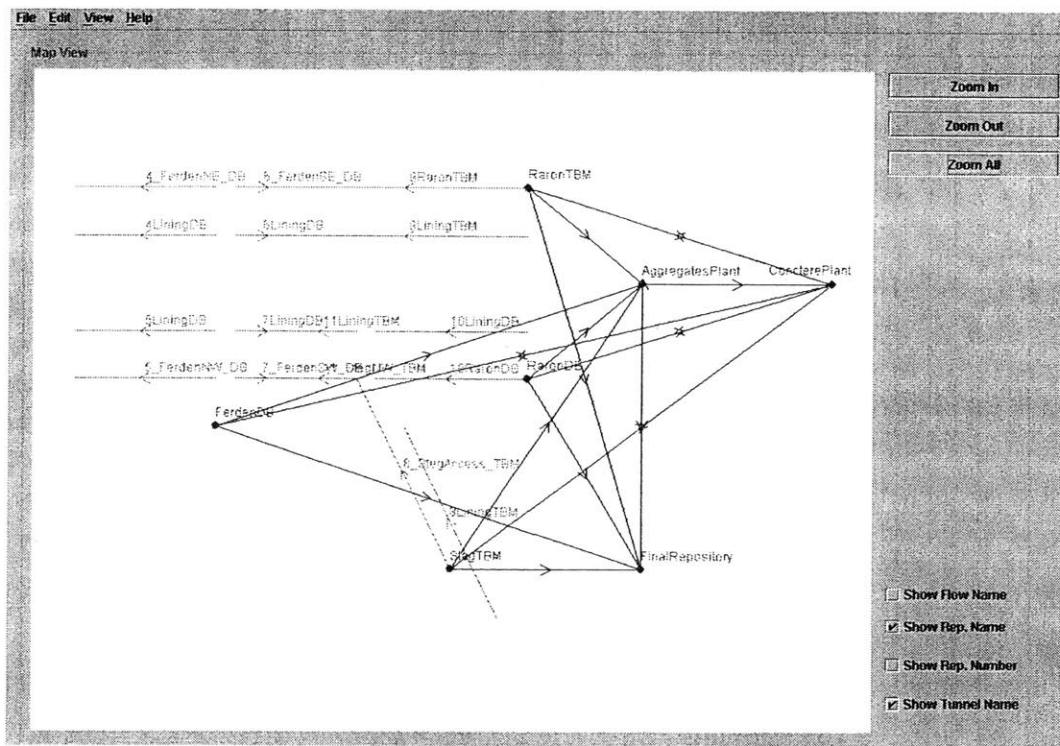

Figure 51. Graphical Representation of the flows used for the simulation of the South Part of the Loetschberg Base Tunnel

<sup>23</sup> Please see “Flows at MBK” paragraph of Chapter 6.

<sup>24</sup> Explanations for Simulation A will be given in Chapter 8. Simulation A was used here since it uses most of the materials and therefore is suitable for the presentation of the data input.

One should notice in Figure 51 that there are direct flows originating in the tunnel repositories and terminating at the concrete plant repository, which appears to contradict the explanation of the process in the paragraph “Repositories Used for Simulations” in Chapter 5, where it was stated that the excavation materials go first to the Aggregates Plant and then to the Concrete Plant. These direct connections are the “virtual” flows that transport the “virtual” resources stated in Chapter 7.

ID	Name	Org. Rep.	Dest. Rep.	Duration	Priority	Max. Nb. of Transp.
0	RaronK1arDB2AggPlant	RaronDB	AggregatesPlant	0.041	1	100000
1	RaronK1arDB2AggP	RaronDB	AggregatesPlant	0.041	1	100000
2	K1DBtransf	AggregatesPlant	AggregatesPlant	0.041	1	100000
3	K1arDBtransf	AggregatesPlant	AggregatesPlant	0.041	1	100000
4	RaronDB2FinalRep	RaronDB	FinalRepository	0.041	1	100000
5	RaronTBM2FinalRep	RaronTBM	FinalRepository	0.041	1	100000
6	RaronK1arTBM2Agg	RaronTBM	AggregatesPlant	0.041	1	100000
7	RaronK1TBM2AggPl	RaronTBM	AggregatesPlant	0.041	1	100000
8	K1TBMtransf	AggregatesPlant	AggregatesPlant	0.041	1	100000
9	Agg2Shotcrete	AggregatesPlant	ConcterePlant	0.002	1	1000000
10	AggDB2Concrete	AggregatesPlant	ConcterePlant	0.002	1	1000000
11	AggarDB2Concrete	AggregatesPlant	ConcterePlant	0.002	1	1000000
12	Shotcrete2RaronDB	ConcterePlant	RaronDB	0	1	100000
13	Concrete210RaronDB	ConcterePlant	RaronDB	0	1	100000
14	AggPlant2FinalRep	AggregatesPlant	FinalRepository	0.041	1	100000
15	Shotcrete2RaronTBM	ConcterePlant	RaronTBM	0	1	100000
16	Concrete2RaronTBM	ConcterePlant	RaronTBM	0	1	100000
17	FerdenK1DB2AggPl	FerdenDB	AggregatesPlant	0.041	1	100000
18	FerdenK1arDB2Agg	FerdenDB	AggregatesPlant	0.041	1	100000
19	Shotcrete2FerdenDB	ConcterePlant	FerdenDB	0	1	100000
20	Concrete2FerdenDB	ConcterePlant	FerdenDB	0	1	100000
21	FerdenDB2FinalRep	FerdenDB	FinalRepository	0.041	1	100000
22	StegK1TBM2AggPlant	StegTBM	AggregatesPlant	0.041	1	100000
23	StegK1arTBM2AggPl	StegTBM	AggregatesPlant	0.041	1	100000
24	Shotcrete2StegTBM	ConcterePlant	StegTBM	0	1	100000
25	Concrete2StegTBM	ConcterePlant	StegTBM	0	1	100000
26	StegTBM2FinalRep	StegTBM	FinalRepository	0.041	1	100000
27	LiningProgress10	RaronDB	ConcterePlant	0	1	100000
28	LiningProgress9	RaronTBM	ConcterePlant	0	1	100000
29	LiningProgress811	StegTBM	ConcterePlant	0	1	100000
30	LiningProgress4567	FerdenDB	ConcterePlant	0	1	100000
31	ShotcreteProgress10	RaronDB	ConcterePlant	0	1	100000
32	ShotcreteProgress9	RaronTBM	ConcterePlant	0	1	100000
33	ShotcreteProgress811	StegTBM	ConcterePlant	0	1	100000
34	ShotcreteProgress4	FerdenDB	ConcterePlant	0	1	100000

Figure 52. Flows MBK Window for the South Part of the Loetschberg Base Tunnel

As one can see there are six different categories of flows shown in Figure 52. In the following paragraphs we will explain each one of them and all the necessary information will be given. For the flows listed below coding “X2Y” is used for labeling. “X” represents the repository they originate from, “2” is an abbreviation for “to” and “Y” represents the repository they terminate to.

## 1) Flows Originate from the Tunnel Repositories and Terminate at the Aggregates Plant Repository

In this category there are the following flows:

- RaronK1DB2AggPlant and RaronK1arDB2AggPlant. These flows originate from the RaronDB repository and terminate at Aggregate Plant repository. The material that is being transported is K1DB for the first flow and K1arDB for the second one respectively.
- RaronK1TBM2AggPlant. This flow originates from the RaronTBM repository and terminates at Aggregate Plant repository. The material that is being transported is K1TBM.
- StegK1TBM2AggPlant. This flow originates from the StegTBM repository and terminates at Aggregate Plant repository. The material that is being transported is K1TBM.
- FerdenK1DB2AggPlant and FerdenK1arDB2AggPlant. These flows originate from the FerdenDB repository and terminate at Aggregate Plant repository. The material that is being transported is K1DB for the first flow and K1arDB for the second one respectively.

As stated above in these flows all the materials that will be used for aggregate production are transported. The transportation for the Loetschberg Base Tunnel is being done by rail. The capacity of each wagon is 100tons and five to ten wagons can be used for each train. We assumed that each train will have 10 wagons, which is equal to 1000tons capacity per train. Also, we assumed that an average round trip will be 1 hour<sup>25</sup>, which is 0,041 days. These parameters can be varied if needed during the simulations.

All the above can be seen in Figure 53, in which 1000tons of K1DB materials are transported from the Raron DB repository to the Aggregates Plant repository in 0.041 days.

---

<sup>25</sup> This duration is probably too short but it was selected, since the data collected showed that transportation time will not be an issue in this project.

The screenshot shows a window titled 'Edit Flow' with the following fields and values:

- Name: RaronK1DB2AggPlant
- Origin Rep.: RaronDB
- Dest. Rep.: AggregatesPlant
- Duration: 0.041
- Priority: 1
- Max. Number: 100000

Below the fields is a table with the following data:

Material	Used	Produced
K1DB	1,000	1,000

Buttons for 'Add', 'Delete', and 'Insert' are located to the right of the table. An 'OK' button is at the bottom right of the window.

Figure 53. Raron K1 DB to Aggregates Plant Flow Information Window

## 2) Flows within Aggregates Plant Repository

In this category the flows are the following:

- K1DBtransf. This flow originates and terminates at the Aggregates Plant. K1DB materials are broken into 0-4mm, 4-8mm, 8-16mm and 16-22mm Drill and Blast aggregates.
- K1arDBtransf. This flow originates and terminates at the Aggregates Plant. K1arDB materials are broken into 0-4mm, 4-8mm, 8-16mm and 16-22mm Drill and Blast alkali-reactive aggregates.
- K1TBMtransf. This flow originates and terminates at the Aggregates Plant. K1TBM materials are broken into 0-4mm and 4-8mm TBM aggregates.

In this type flows all the suitable for aggregates production materials are transformed to aggregates. The crusher capacity is 240tons/hour. Since 1 hour is 0.041 days, the crusher can break 240tons of material every 0.041 days.

Also the crusher's production sizes as stated in the project's documents are:

- For the Drill and Blast materials:

36% 0-4mm

12% 4-8mm

17% 8-16mm

15% 16-22mm

20% Waste

- For the TBM materials:

48% 0-4mm

32% 4-8mm

20% Waste

All the above can be seen in Figure 54 and Figure 55, in which 240tons of K1DB and K1TBM materials are transformed into aggregates in 0.041 days.

Specifically the Figures show that 240 tons of K1DB or K1arDB produce 86.4tons of 0-4mm, 28.8tons of 4-8mm, 40.8tons of 8-16mm, 36tons of 16-22mm and 48tons of waste in 0.041 days. Also, 240 tons of K1TBM produce 115.2tons of 0-4mm, 76.8tons of 4-8mm and 48tons of waste in 0.041 days.

Edit Flow

Name: K1DBtransf

Origin Rep.: AggregatesPlant

Dest. Rep.: AggregatesPlant

Duration: 0.041

Priority: 1

Max. Number: 100000

Material	Used	Produced
K1DB	240	0
0-4mmDB	0	86.4
4-8mmDB	0	28.8
8-16mmDB	0	40.8
16-22mmDB	0	36
KuAgg	0	48

Buttons: Add, Delete, Insert

OK

Figure 54. K1DBtransf Flow

Information Window

Edit Flow

Name: K1TBMtransf

Origin Rep.: AggregatesPlant

Dest. Rep.: AggregatesPlant

Duration: 0.041

Priority: 1

Max. Number: 100000

Material	Used	Produced
K1TBM	240	0
0-4mmTBM	0	115.2
4-8mmTBM	0	76.8
KuAgg	0	48

Buttons: Add, Delete, Insert

OK

Figure 55. K1TBMtransf Flow

Information Window

### 3) Flows from Aggregates Plant Repository too Concrete Plant Repository

In this category there are the following flows:

- Agg2Shotcrete. This flow transforms the aggregate sizes to shotcrete. All the 0-4mm, and 4-8mm TBM sizes are taken form the Aggregates Plant Repository and become shotcrete in the Concrete Plant repository.
- Agg2Concrete. This flow transforms the aggregate sizes to concrete. All the 0-4mm, 4-8mm, 8-16mm and 16-22mm DB sizes are taken form the Aggregates Plant Repository and become concrete in the Concrete Plant repository.

The concrete plant capacity is 240tons/h or 240 tons every 0.041 days. Also concrete production as stated at the project's documents has the following characteristics:

For 1 m<sup>3</sup> of shotcrete production we need:

- 60% 0-4 mm aggregates and
- 40% 4-8 mm aggregates

Since in 1m<sup>3</sup> shotcrete the weight of the aggregates is approximately 1.95 tons, 1.17tons 0-4mm and 0.78tons 4-8mm aggregates will be needed for the production of 1m<sup>3</sup> of shotcrete.

For 1 m<sup>3</sup> of concrete production we need:

- 45% 0-4 mm aggregates
- 15% 4-8 mm aggregates
- 21% 0-4 mm aggregates and
- 19% 4-8 mm aggregates

Since in 1m<sup>3</sup> concrete the weight of the aggregates is approximately 2.00 tons, 0.9tons 0-4mm, 0.3tons 4-8mm, 0.42tons 8-16mm and 0.38tons 16-22mm aggregates will be needed for the production of 1m<sup>3</sup> of concrete.

Since the capacity of the plant is 240 tons/hour, the 1.95 or the 2.00 tons will be processed very quickly (0.00035 days). Such a small number (very close to “0”) may cause computation problems. So, since it will not affect in any way the results of our simulation, we increased it to 0.002days in order to avoid computation problems.

All the above can be seen in Figure 56 and Figure 57, where 1m<sup>3</sup> of shotcrete and 11 m<sup>3</sup> of concrete is produced respectively.

Edit Flow

Name: Agg2Shotcrete

Origin Rep.: AggregatesPlant

Dest. Rep.: ConcterePlant

Duration: 0 0020

Priority: 1

Max. Number: 1000000

Material	Used	Produced
0-4mmTBM	1.17	0
4-8mmTBM	0.78	0
Shotcrete	0	1

Add  
Delete  
Insert

OK

Figure 56. Aggregates to Shotcrete Flow Information Window

Edit Flow

Name: AggDB2Concrete

Origin Rep.: AggregatesPlant

Dest. Rep.: ConcterePlant

Duration: 0 0020

Priority: 1

Max. Number: 100000

Material	Used	Produced
0-4mmDB	9.9	0
4-8mmDB	3.3	0
8-16mmDB	4.62	0
16-22mmDB	4.18	0
Concrete	0	11

Add  
Delete  
Insert

OK

Figure 57. Aggregates to Concrete Flow Information Window

#### 4) Flows terminate to the Final Repository.

As stated before all the useless materials are deposited to the final repositories. As a result the flows of this category are the following:

- RaronDB2Final Rep. This flow represents the transportation of the KuDB materials from the RaronDB repository to the Final Repository.
- RaronTBM2Final Rep. This flow represents the transportation of the KuTBM materials from the RaronTBM repository to the Final Repository.
- StegTBM2Final Rep. This flow represents the transportation of the KuTBM materials from the StegTBM repository to the Final Repository.
- FerdenDB2Final Rep. This flow represents the transportation of the KuDB materials from the FerdenDB repository to the Final Repository.

- AggPlant2FinalRep. This flow represents the transportation of the waste materials KuAgg created during the crushing operation from the Aggregates Plant repository to the Final Repository.

These are all rail transportation. Information on the duration of the rail transportation is given in paragraph “Flows Originate from the Tunnel Repositories and Terminate at the Aggregates Plant Repository”.

## **5) Flows of the “LiningProX” and “ShotcreteXstop” types of resources.**

As stated before these are “virtual” resources that are used for the needs of the simulations. They are transported from the tunnel repositories directly to the concrete plant to control the concrete and the shotcrete transportation. (See description of these resources in the paragraph “Auxiliary Resources” in Chapter 7). The flows that represent this transportation are named “ShotcreteProgressX” and “LiningProgressX” respectively. “X” comes from the number of the tunnel. In these flows one unit of these resources is used and produced at a time. Note that the duration of this flows should be very fast ( $10^{-4}$  days), since we do not want this transportation to be the bottleneck in our process.

## **6) Flows for shotcrete and concrete transportation.**

Taking all the above into account we now need to transport the produced shotcrete and concrete back to the tunnel repositories in order to be used for the support of the tunnels.

The flows that characterize this procedure are the following:

- Shotcrete2RaronDB and Concrete2RaronDB.
- Shotcrete2RaronTBM and Concrete2RaronTBM.
- Shotcrete2StegTBM and Concrete2StegTBM.
- Shotcrete2FerdenDB and Concrete2FerdenDB.

As can be seen in Figure 58 we have chosen to transport  $5 \text{ m}^3$  of shotcrete at a time. Initial support (shotcrete), unlike final support (concrete), depends on the geologic profiles, which vary along the tunnel. As shown in Table A-1 and in Figures A-1- A-8 in Appendix A, each geologic profile uses a different quantity of shotcrete. Since we can not foretell the

quantity of shotcrete that will be needed for every meter of support we used the trial and error technique to find the quantity that will not delay the tunnels. Together with the  $5\text{m}^3$  of shotcrete a unit of the virtual resource “ShotcreteXProgress” is used to control the transportation of shotcrete. (See Figure 58). When “ShotcreteXProgress” finishes the shotcrete flow will stop and no more shotcrete will be transported to the tunnel repository. (See the resources paragraph for more details).

In Figure 59 one can see the concrete transportation. We transport  $11\text{m}^3$  of concrete time, since this is needed for every meter of the support. We also use here the virtual resource LiningXprogress as stated above.

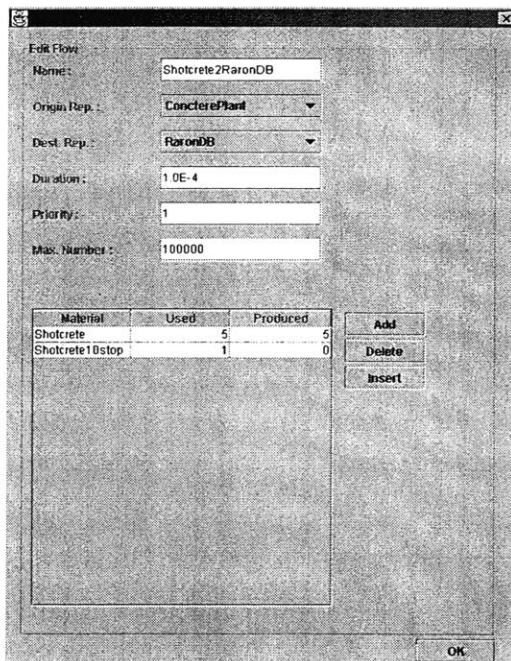

Figure 58. Shotcrete Transportation Flow Information Window

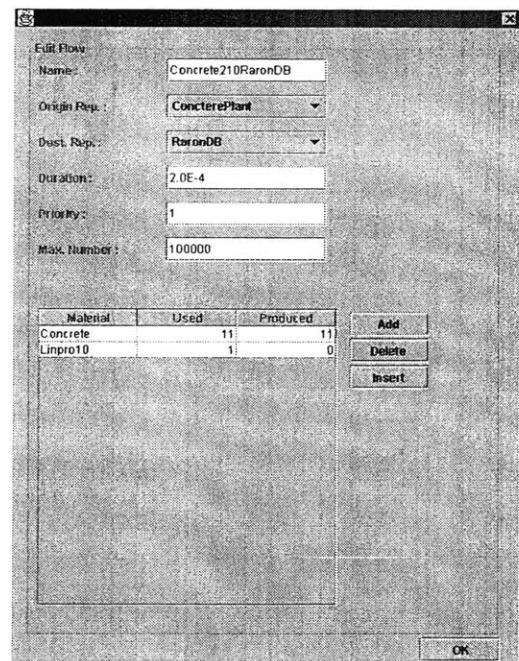

Figure 59. Concrete Transportation Flow Information Window

## Chapter 8 The New Simulations of the South Part of the Loetschberg Base Tunnel.

This Chapter is divided into two parts. In the first part we will present the results of a “new” simulation of the south part of the Loetschberg Base tunnel without the reuse of the resources. The “new” simulation will be compared with the results of the original simulations of the Loetschberg Base tunnel, run by EPFL and presented in this thesis in Chapter 3. Note that in addition to the construction time estimates in the “new” simulation, which can be compared to the EPFL results, there are additional results in forms of produced excavation materials.

In the second part the reuse of the resources will be added and the different scenarios together with their results will be presented.

### Simulations without Reusing the Resources.

In this paragraph the new data file, that we created, will be compared with the original one (received from EPFL) the results of which were presented in Chapter 3. Table 7 summarizes the results for the two data file, after 100 simulations were run. The results are calculated from Figure 14-Figure 18 of Chapter 3 and Figure 60-Figure 64 that follow.

Table 7. Comparison of the results between the original and the new Data file.

Tunnel	Original Data File			New Data File		
	Begin Location (m)	End Location (m)	Duration (days)	Begin Location (m)	End Location (m)	Duration (days)
10 Raron DB	49,090	44,488	770.00	49,111	44,340	800.00
9 Raron TBM	49,036	39,300	600.00	49,108	38,850	870.00
8 StegAccess TBM	41439	44,487	150.00	41,439	44,523	210.00
11 StegNW TBM	44,488	38,880	390.00	44,488	38,850	340.00
7 FerdenSW DB	37,586	38,881	239.00	37,245	38,850	235.00
6 FerdenSE DB	37,521	40,282	340.00	37,245	38,850	270.00
5 FerdenNW DB	36,960	27,900	1,320.00	37,245	27,900	1160.00
4 FerdenNE DB	36,955	27,800	1,324.00	37,245	27,900	1100.00

Figure 60-64 show the distribution of the duration of each tunnel after 100 simulations were run and should be compared with Figure 14-Figure 18 of Chapter 3.

Comparing the figures shown below, with those presented in Chapter 3, one can see that the results are almost identical. Taking into account the distribution of the results after running 100 simulations we can say with confidence that all the assumptions that have been made have not affected the results and thus can be used for the resources management simulations.

Apart from the tunnel lengths and excavation durations interesting results can be seen when looking at the materials produced from these simulations. Table 8 shows the average quantities of the materials as they resulted after 10 simulations.

Table 8. Materials Quantities

<b>Material at Repositories</b>	<b>Average (tons)</b>
Raron K1arDB	54,785.25
Raron K1DB	43,585.62
Raron K2DB	369,566.33
Raron KuDB	356,695.29
Raron K1arTBM	77,032.04
Raron K1TBM	152,920.48
Raron K2TBM	701,341.59
Raron KuTBM	993,522.75
Ferden K1DB	0.00
FerdenK1arDB	1,195,940.95
Ferden K2DB	32,616.65
FerdenKuDB	1,916,000.99
Steg K1arTBM	25,895.92
Steg K1TBM	169,840.69
Steg K2TBM	221,444.05
Steg KuTBM	1,198,511.08
<b>Total</b>	<b>7,509,699.65</b>

The result in terms of tons of excavated materials in Table 8 is reasonable since a quick calculation yields similar results. If  $R=4,5m$ ,  $L_{tunnels}=42,052m$

$$\text{Total } m^3 = \pi * R^2 * L_{tunnels} = 3.14 * 4.5^2 * 42,052 = 2,673,876 m^3, \text{ which is } 7,219,466 \text{ tons.}$$

Figure 65 to Figure 68 are graphical representations of the results of one particular geology simulation, which will be used as an “example” throughout this chapter for presentation and comparison of the different simulation scenarios. This “example” geology simulation results if “Ground Generation Seed” is set to 2500 (see SIMSUPER user manual for more information).

The results of the “example” simulation, shown below, represent the excavation materials before the materials management flows were added. Later in this chapter when the different scenarios will be presented the relevant flows will be added.

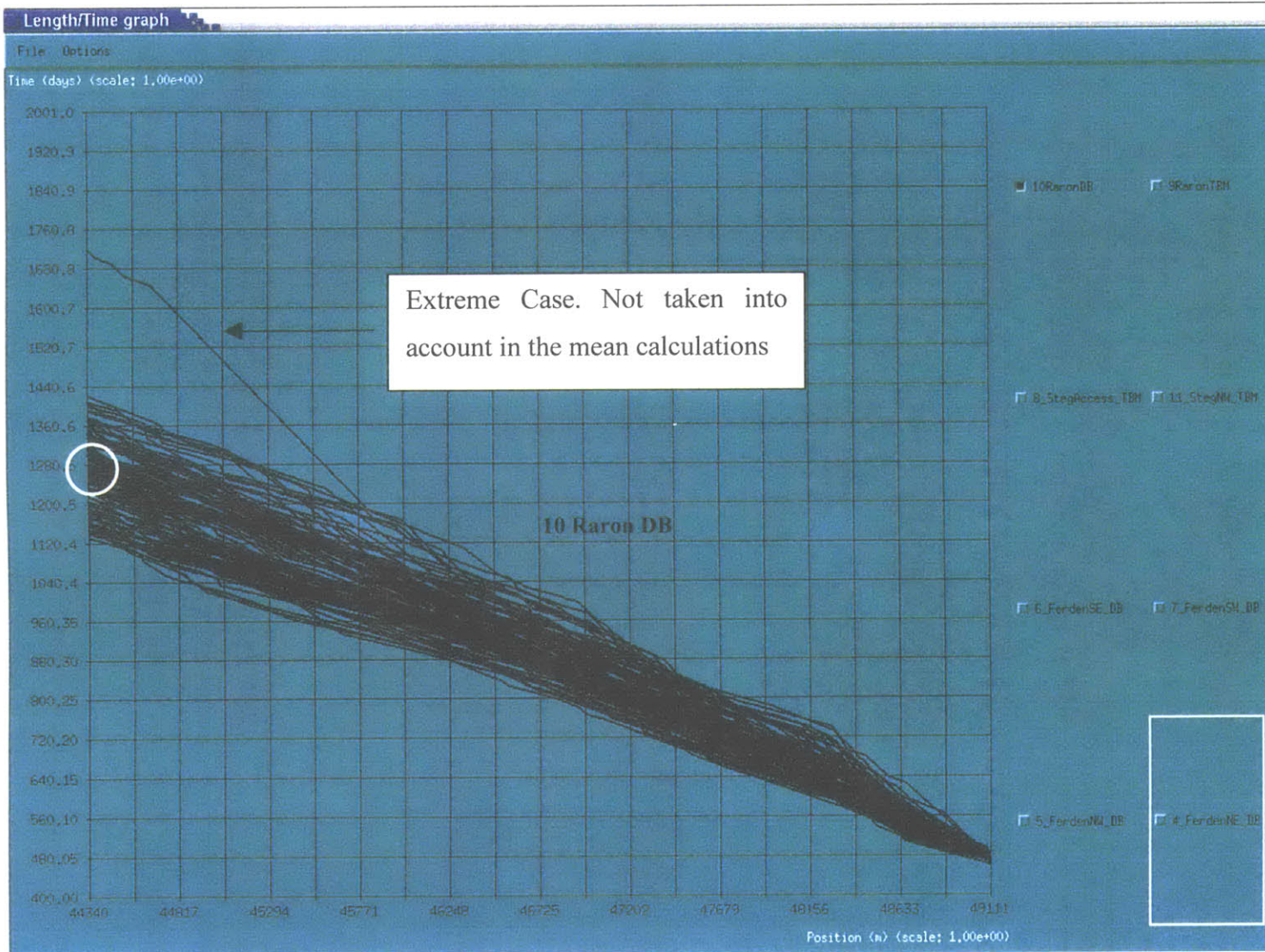

Figure 60. "New" Tunnel 10 Raron DB Time/ Position Graph after 100 Simulations

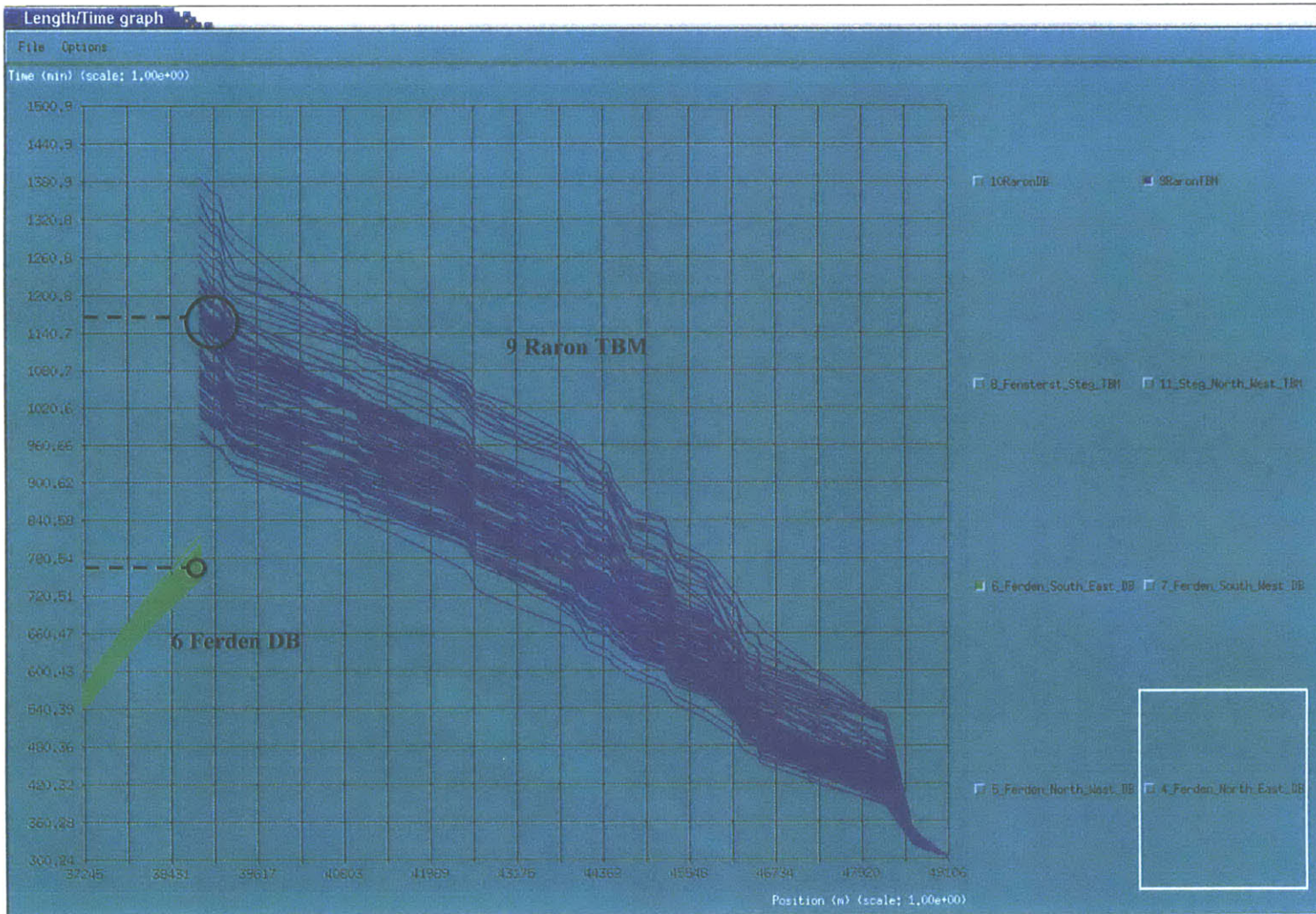

Figure 61. "New" Tunnels 9 Raron TBM and 6 Ferden DB Time/ Position Graph after 100 Simulations

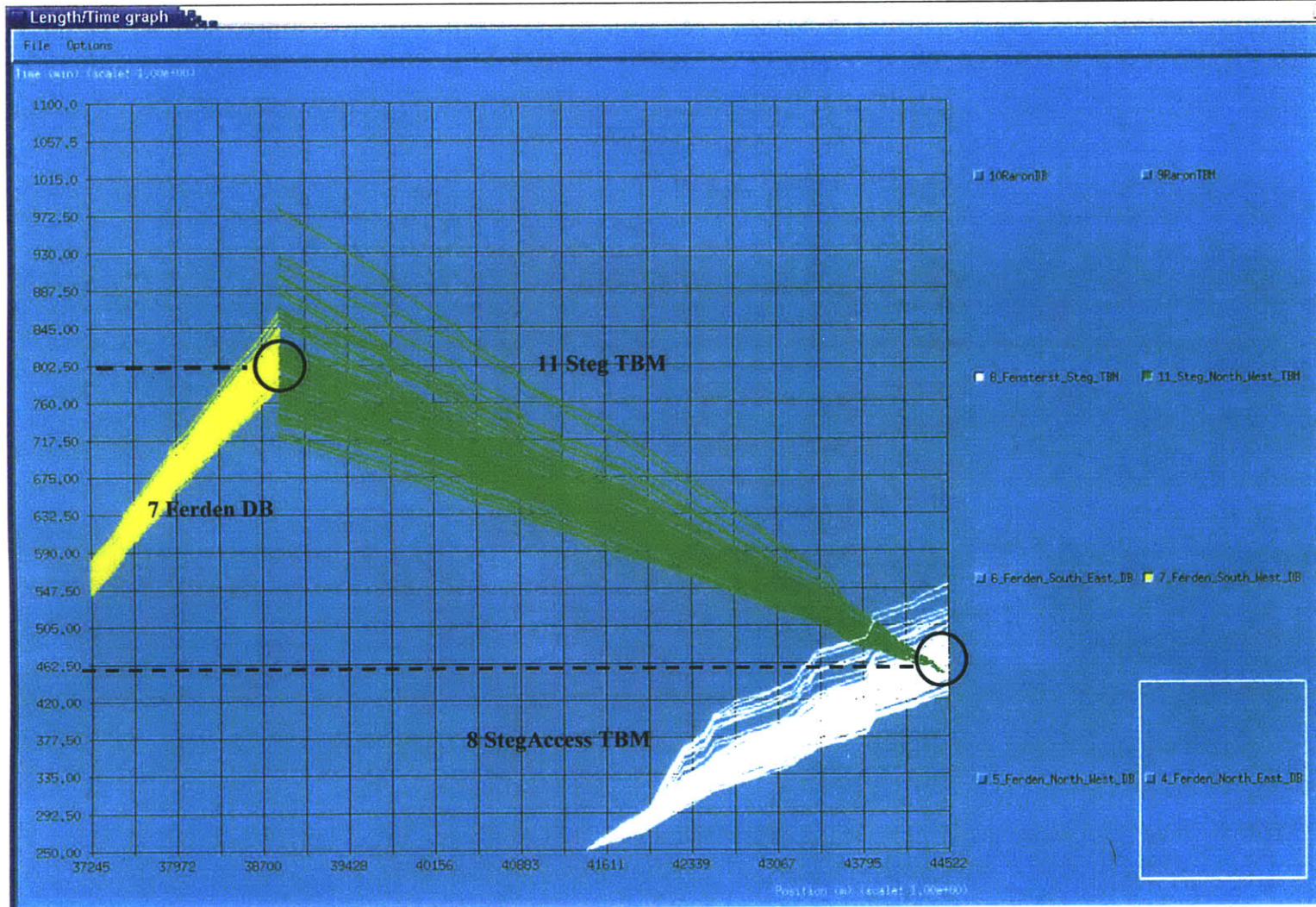

Figure 62. “New” Tunnels 8 StegAccess TBM, 11 Steg TBM and 7 Ferden DB Time/ Position Graph after 100 Simulations

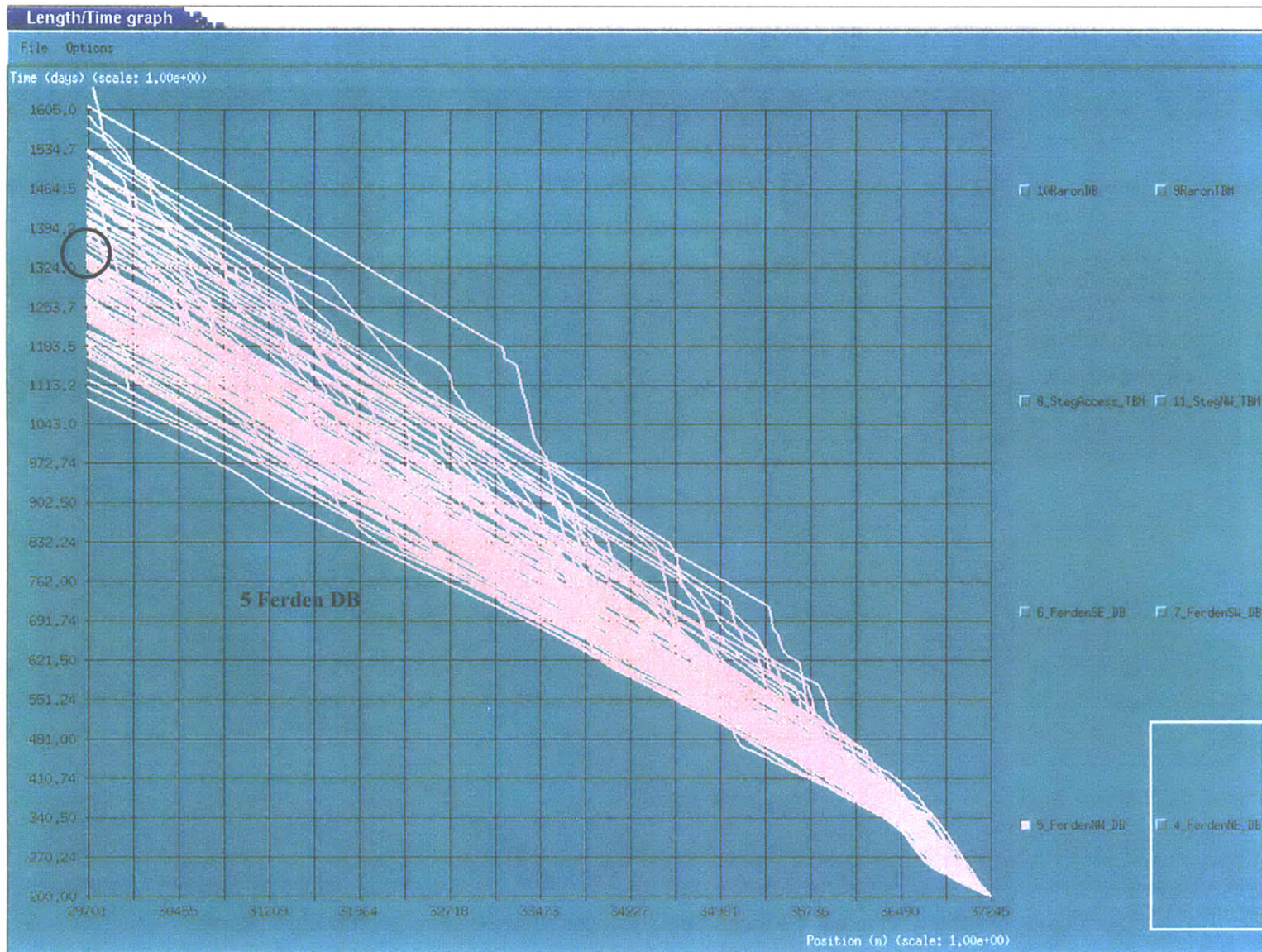

Figure 63. “New” Tunnel 5 Ferden DB Time/ Position Graph after 100 Simulations

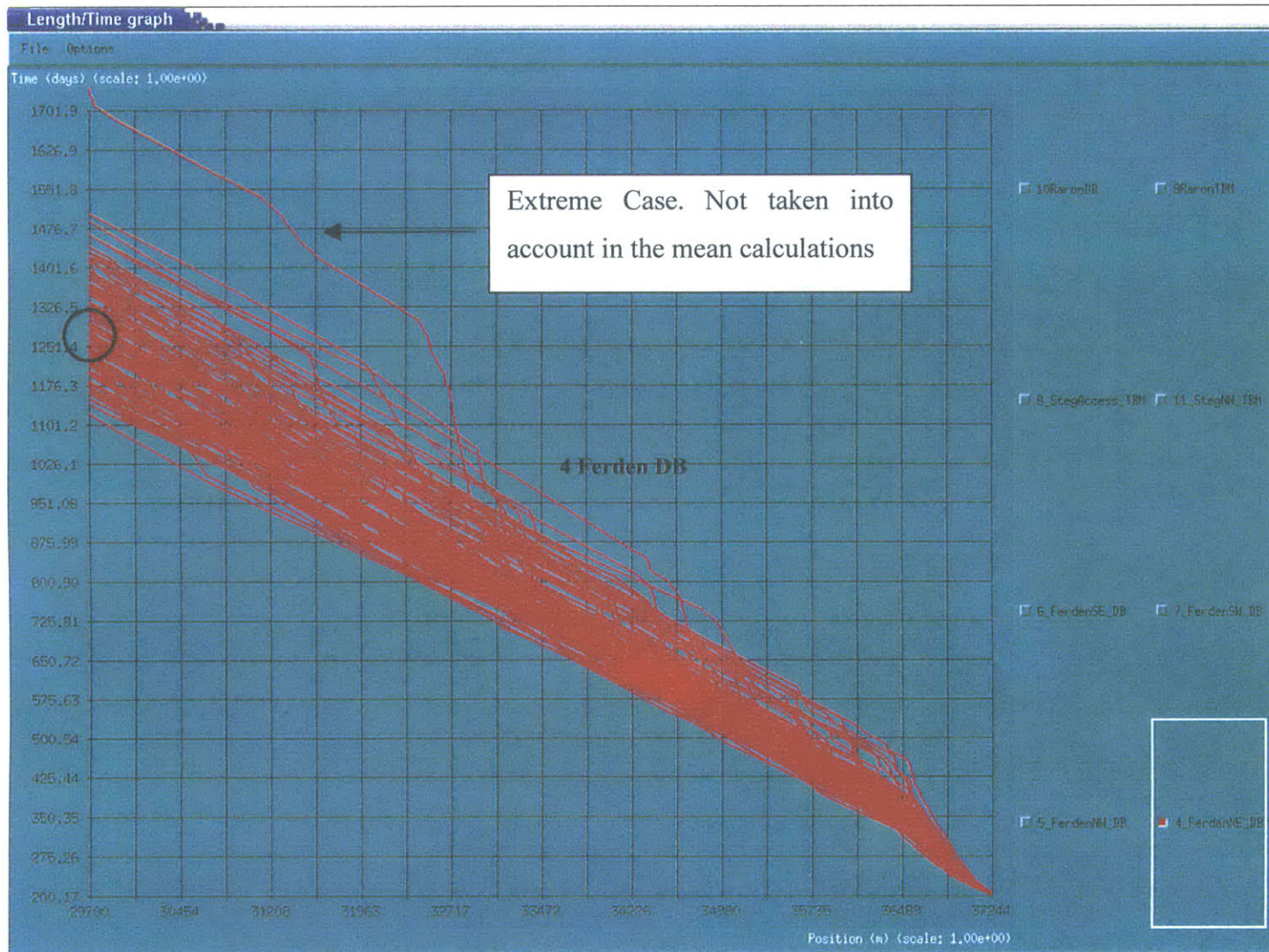

Figure 64. “New” Tunnel 4 Ferden DB Time/ Position Graph after 100 Simulations

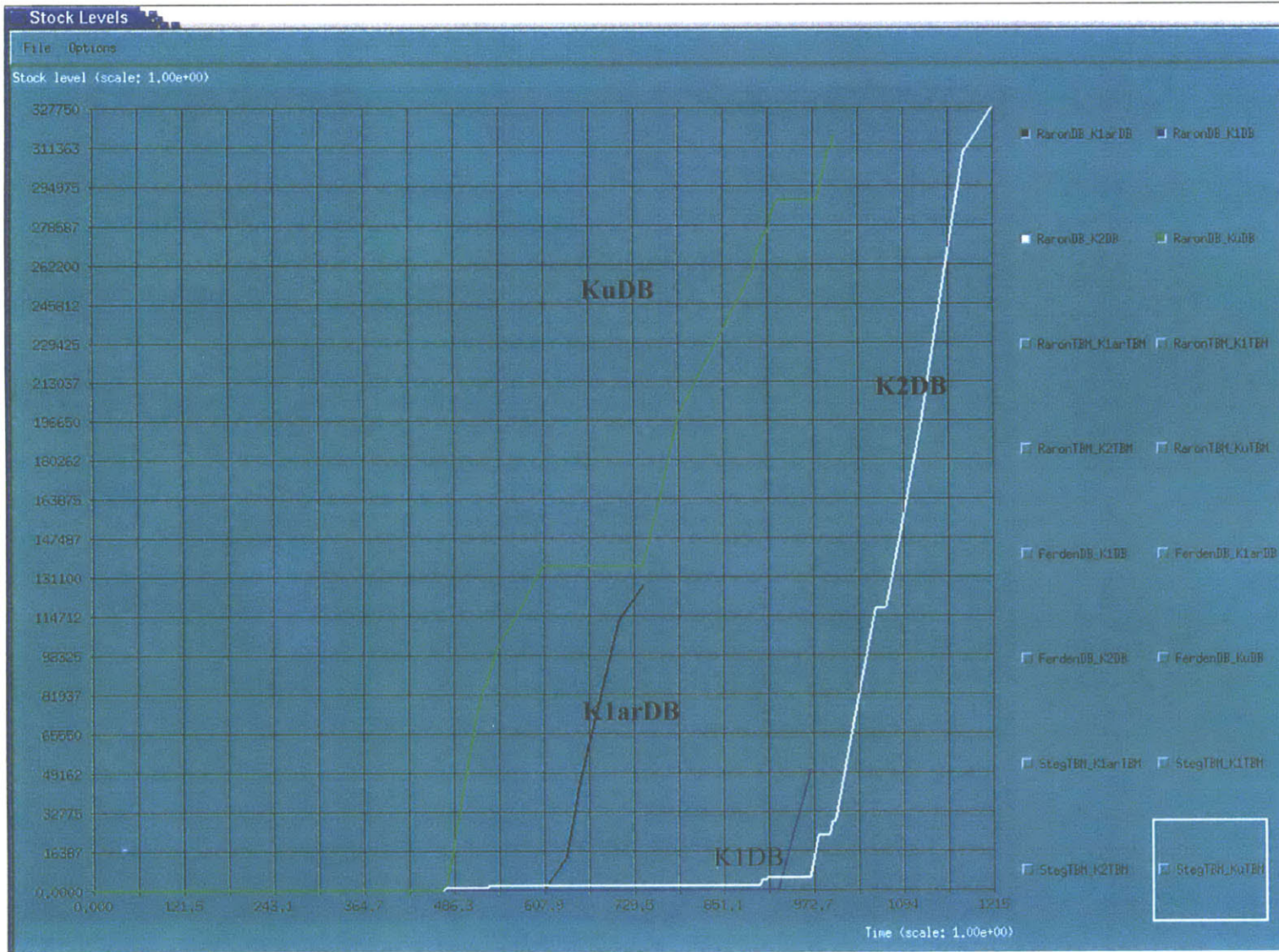

Figure 65. **“Example”** Simulation Results of the Excavation Materials at the Raron DB Repository

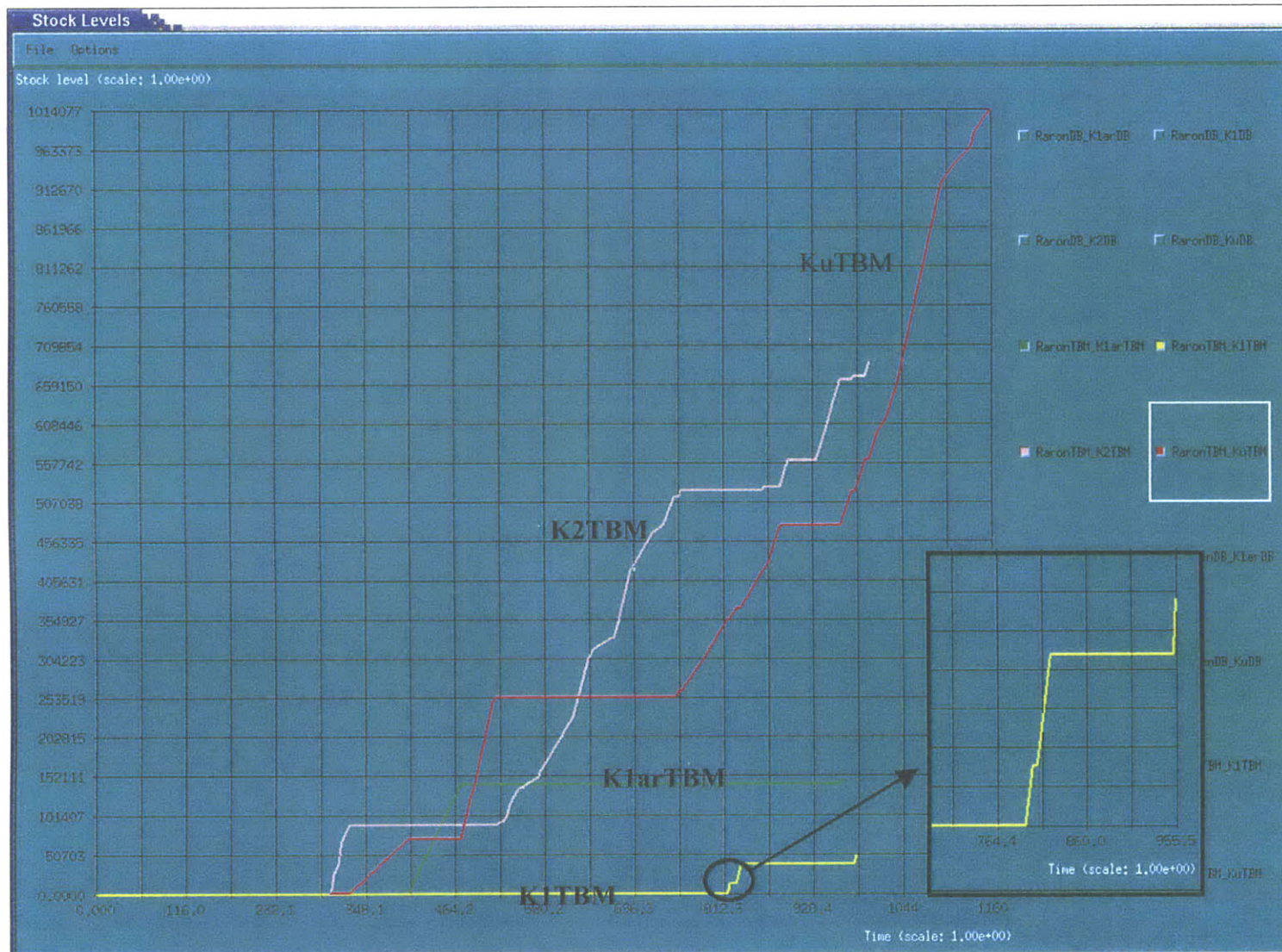

Figure 66. “Example” Simulation Results of the Excavation Materials at the Raron TBM Repository

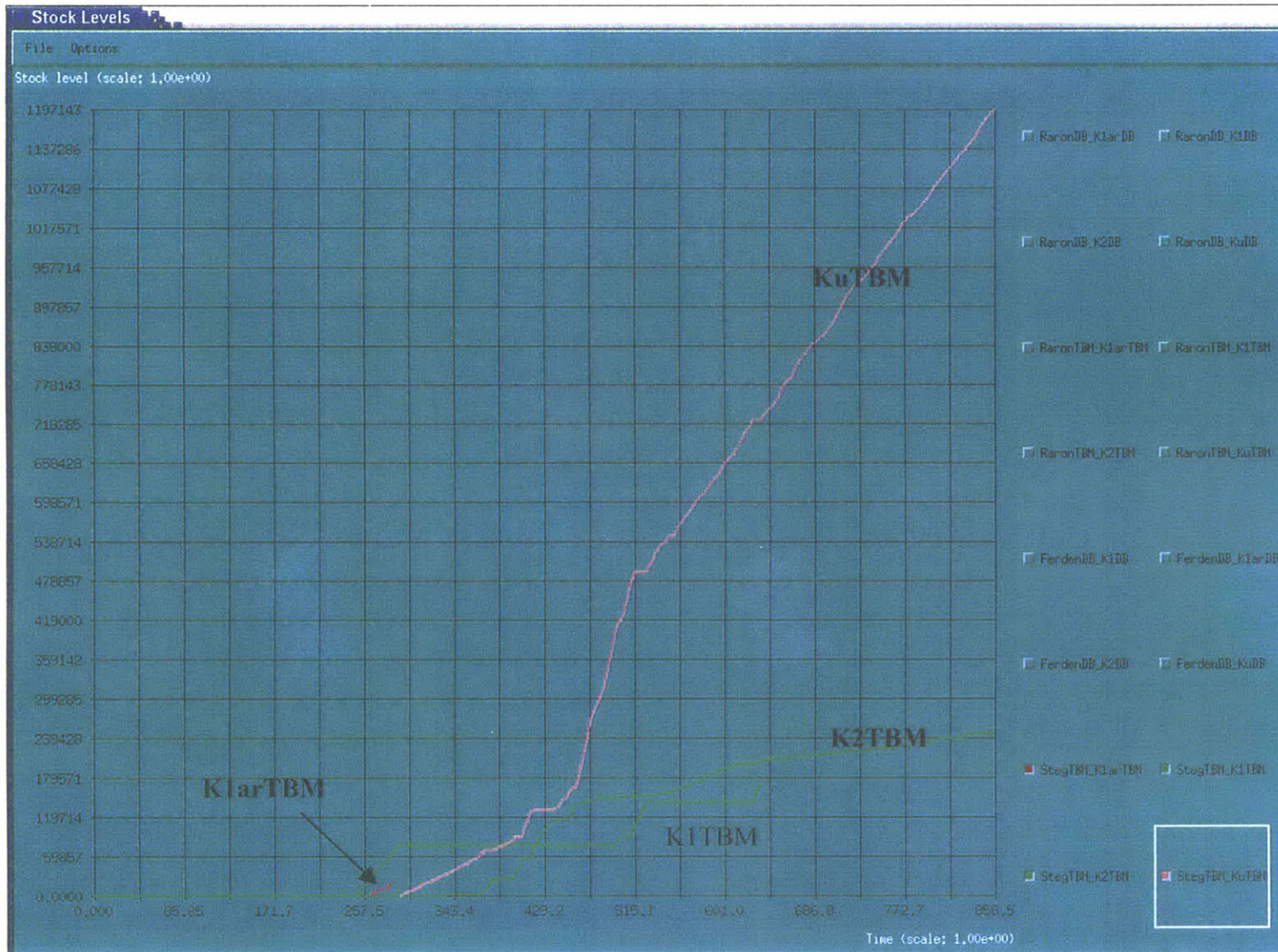

Figure 67. “Example” Simulation Results of the Excavation Materials at the Steg TBM Repository

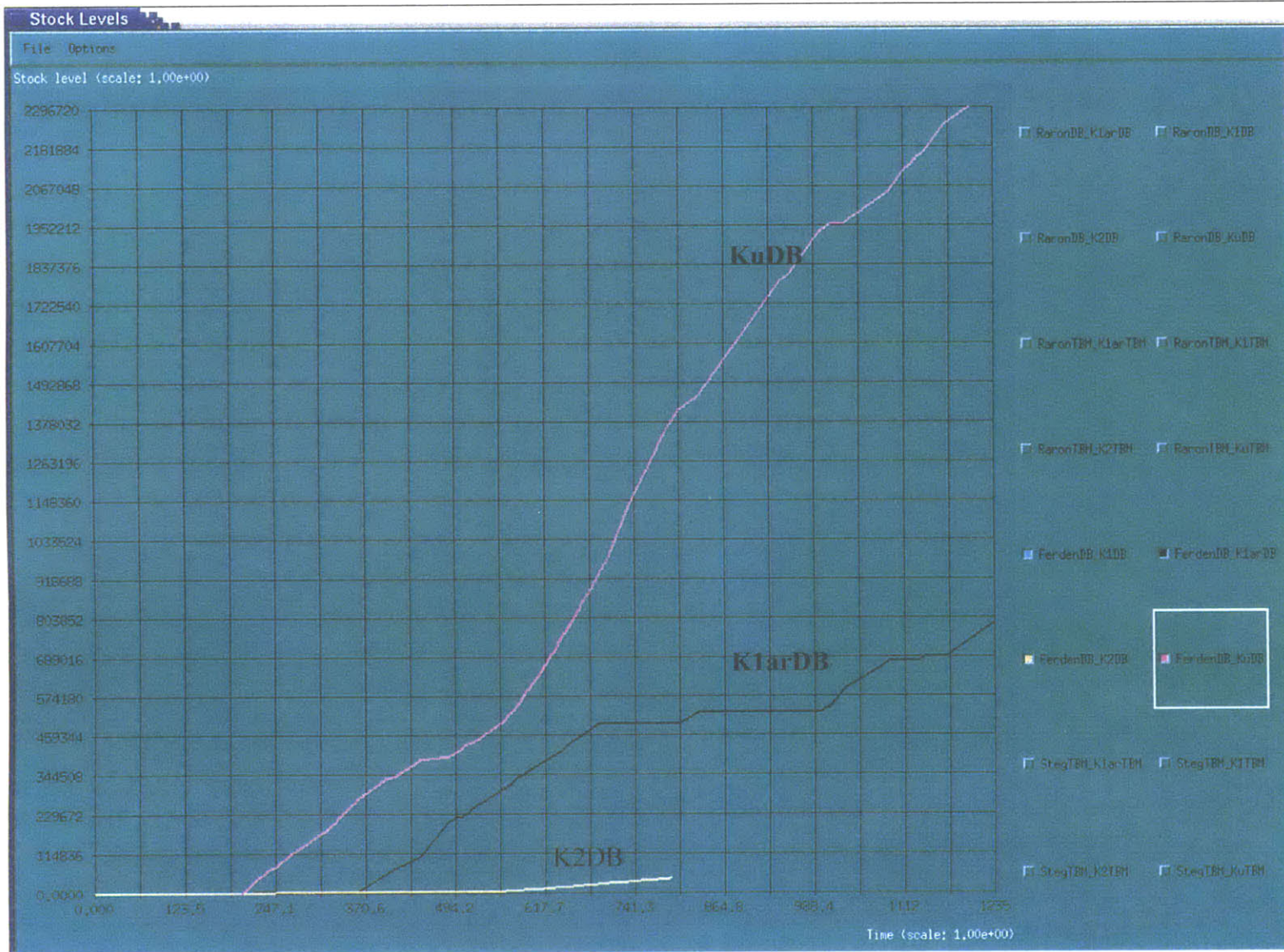

Figure 68. “Example” Simulation Results of the Excavation Materials at Ferden DB Repository

## Simulations Reusing the Resources.

In this section all material management resources which have been simulated and the results will be presented. In all the simulations the materials excavated with a TBM are used only for shotcrete production since their geometry will probably be unfavorable for concrete production.

Three main simulations regarding usage of the excavation materials were run:

- **Simulation A:** Using only K1 type excavation materials. K1DB and K1arDB materials are used for concrete production and K1TBM materials are used for shotcrete production.
- **Simulation B:** Using only non-alkali reactive K1 type of excavation materials. K1DB materials only are used for concrete production and K1TBM materials are used for shotcrete production.
- **Simulation C:** Using non-alkali reactive K1 and K2 types of excavation materials. K1DB and K2DB materials are used for concrete production and K1TBM materials are used for shotcrete production.

Apart from these main simulations a couple of additional simulations were run in which other parameters such as the Markov matrices of the excavation materials and the correlation matrix were varied. Since the Simulation A case scenario is most likely to be applied in reality we varied those parameters only for this scenario which involves the following simulations:

- **Simulation A1:** Using only K1 type of excavation materials. K1DB and K1arDB materials are used for concrete production and K1TBM materials are used for shotcrete production. In this simulation the excavation materials Markov matrices have been modified and a wider distribution of probabilities is given for the excavation materials of each zone. Detailed information will be shown in the relevant paragraph.
- **Simulation A2:** Using only K1 type of excavation materials. K1DB and K1arDB materials are used for concrete production and K1TBM materials are used for shotcrete production. In this simulation the correlation matrix has been changed. In simulations A, B and C all the values in the correlation matrix were equal to 0.5. According to the SIMSUPER user's manual when the value 0.5 is input in the correlation matrix, this means that all the possible

combinations can apply. In simulation A2 we have applied certain restrictions regarding the cross- sections and the excavation materials, which will be presented in the paragraph of the simulation A2 results later in this chapter.

## Simulation A Results

The simulation results for every tunnel, after 30 simulations were run, are summarized in Table 9. Out of the 30 simulations 20 finished completely, while in the remaining 10 the 4 & 5 Ferden, 10 Raron DB and 9 Raron TBM lining tunnels stopped (near the end) due to lack of resources. So for this simulation scenario there is a 33% probability that there will not be enough excavation materials for concrete production and therefore concrete will have to be purchased.

Table 9. **Simulation A** Average Results for Excavation and Lining

<b>Tunnel Name</b>	<b>Av. End Time (days)</b>
10 Raron DB	1,254
10 Raron DB Lining	1,354
9 Raron TBM	1,045
9 Raron TBM Lining	1,204
8 AccesSteg	450
8 Steg Lining	542
11StegTBM	832
11StegTBM Lining	989
6 Ferden DB	787
6 Ferden DB Lining	831
7 Ferden DB	787
7 Ferden DB Lining	837
5 Ferden DB	1,328
5 Ferden DB Lining	1,351
4 Ferden DB	1,374
4 Ferden DB Lining	1,432

In the following the results of the “example” simulation will be presented.

In Figure 69 the results of the excavation and initial support of the “example” simulation are shown, while in Figure 70 the final support results are added.

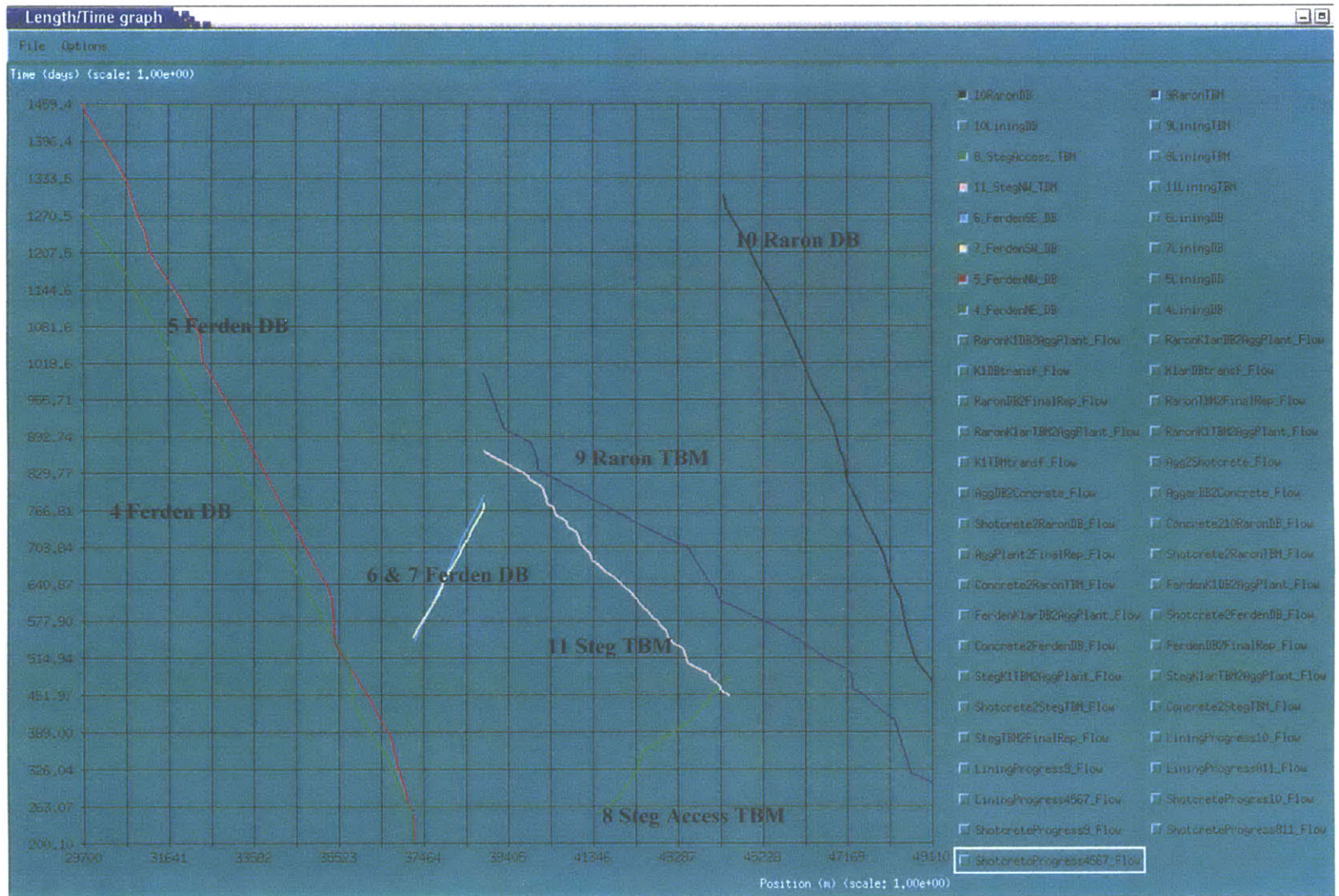

Figure 69. Scenario A “Example” Simulation Results for the Excavation and the Initial Support of the Tunnels

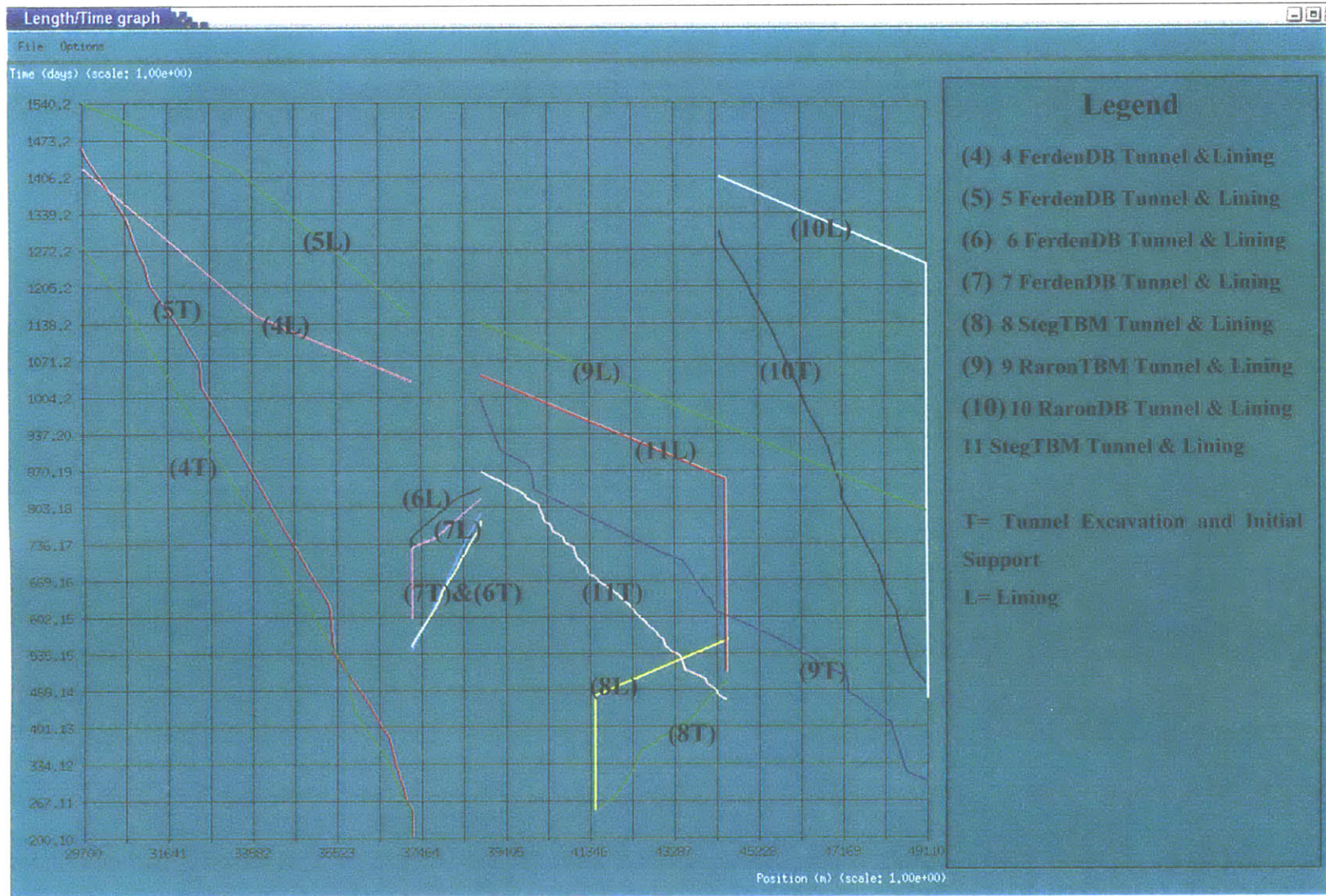

Figure 70. **Scenario A** "Example" Simulation Results for the Excavation, the Initial and the Final Support of the Tunnels

Apart from the tunneling and lining process interesting results can also be seen when looking at the materials.

### **K1TBM Materials**

In this simulation scenario K1TBM materials become aggregates for shotcrete. At the end of the simulations a stock of non-alkali reactive 0/4 mm and 4/8 mm excavated with TBM is formed in the Aggregates Plant repository, shown in Figure 71. In this figure four stages of the materials production can be identified.

- In stage A (day 250 to approx. day 715) we notice an increase of the stocks of 0/4mm and 4/8 mm TBM materials. This means that 0/4mm and 4/8 mm aggregates are produced from K1TBM materials at a faster pace than shotcrete is produced from the aggregates.
- In stage B (approx. day 715 to day 780) we notice a decrease of the stocks of 0/4mm and 4/8 mm TBM materials. Looking in Figure 66 and Figure 67 we see that there is no production of K1TBM materials (and as a consequence no 0/4mm and 4/8mm TBM materials) between these days and therefore the already formed stock decreases.
- In stage C (approx. day 780 to day 800) we notice an increase of the stocks of 0/4mm and 4/8 mm TBM materials. This can be explained (see Figure 66) by the fact that K1TBM materials are produced at Raron TBM repository.
- In stage D (approx. day 800 to day 1,459) we notice that the stocks of 0/4mm and 4/8 mm TBM materials decrease. Looking in Figure 66 we see that there is production of K1TBM materials until day 955. Until day 955 the shotcrete flows are faster than the K1TBM flows and the shotcrete aggregate flows. After day 955 since there is no production of K1TBM materials the stock of 0/4mm and 4/8 mm TBM materials is expected to decrease and eventually stop on the 1,459<sup>th</sup> day together with the last tunnel's (tunnel 5 Ferden DB) initial support.

The comments above apply also to “example” simulation scenarios B and C, since, as in scenario A, only K1TBM materials are used for shotcrete production.

### **K1DB and K1ar DB Materials**

As stated before K1DB and K1arDB materials are used for concrete production, with K1DB materials being given a priority in the process. As soon as they are produced they are transported and transformed to concrete aggregates. So when K1DB materials are not produced K1arDB materials are processed if they are available.

In Figure 65 and Figure 68 one can see the excavated quantities of K1arDB materials at Raron DB and Ferden DB repositories. In Figure 72 the stocks of aggregates produced from K1DB and K1arDB materials are shown. Aggregates produced from K1DB materials (0/4mmDB, 4/8mmDB, 8/16mmDB and 16/22mmDB) are used first and finish first and therefore no stock remains at the Aggregate Plant repository. Regarding the alkali reactive aggregates (0/4mm arDB, 4/8mm arDB, 8/16mm arDB and 16/22mm arDB) one can see the following in Figure 72:

- In stage A (approx. day 250 to day 1100) alkali reactive concrete aggregates stocks (0/4mm arDB, 4/8mm arDB, 8/16mm arDB and 16/22mm arDB) increase. This is due to the fact that concrete production rate is lower than the aggregates production rate during this period.
- In stage B (approx. day 1100 to day 1130) the stocks decrease, because looking at Figure 65 and Figure 68 one sees that there is neither K1arDB nor K1DB material production during this time. On the other hand concrete is being produced and thus the stock of concrete aggregates decreases.
- In stage C (approx. day 1130 to day 1250) the stocks increase, since additional K1arDB materials are produced (see Figure 68).
- In stage D (approx. day 1250 to day 1540) the stocks decrease again, because looking at Figure 68 one sees that K1arDB material production stops on the 1235<sup>th</sup> day. So, since concrete production continues until the lining of the last tunnel (tunnel 5 Ferden DB) terminates on day 1,540, the stocks are reduced.

### **K2 and K1arTBM Materials**

Since K2 (both DB and TBM) and K1ar TBM materials are not used for aggregate production in these simulations their stocks increase during the simulations. This is shown in

Figure 73 and Figure 74, respectively. One can compare these figures with Figure 65- Figure 68, in which the quantities of K2 and K1arTBM materials during the excavation are shown and will realize that they are almost the same.

The engineers can decide whether or not these materials can be used or sold. If they decide they can not use them, they have to be transported to the final repository.

### **Ku Materials**

Figure 75 shows the stocks of all the useless materials at the final repository, namely KuDB, KuTBM and KuAgg.

### **Shotcrete and Concrete**

Finally, Figure 76 and Figure 77 show that the levels of concrete and shotcrete in the Raron DB repository remain low<sup>26</sup>. Shotcrete levels are always below 45 m<sup>3</sup> and concrete levels are either 11m<sup>3</sup> or 0.

11m<sup>3</sup> of concrete are transported to the tunnel repositories and then used to line 1 m of the tunnel. This results in the 0-11m<sup>3</sup> cycles shown in Figure 76. Since the quantity of concrete per meter of final support is constant along the tunnel there is no problem of concrete stock formation at the tunnel repository. We transport exactly the quantity needed and as a result as soon as concrete is available at the tunnel repository it is used for lining.

The concrete transportation- use procedure can not be applied to the shotcrete since as stated in Chapter 2 every cross-section profile has a different need for shotcrete (i.e. ESA1 needs 0.42 m<sup>3</sup>, ESA3b needs 1.79m<sup>3</sup> and ESA4b needs 1.82m<sup>3</sup> etc. per meter of excavation). In the current resource model of the DAT we have to transport a preset amount of material from one repository to the other at a time. In the shotcrete case this might create a stock of shotcrete at the tunnel repository. This is not realistic since shotcrete and concrete can not be stored. In order to avoid the creation of this stock one can input a limit in the quantity of shotcrete in the tunnel repository (i.e. shotcrete at Raron DB repository < 45m<sup>3</sup>). This limit cannot be too low since this causes significant delays in the tunnel construction simulation, which are not realistic since shotcrete can be produced in sufficient quantities. As stated in

---

<sup>26</sup> This happens in every repository at the exit of the tunnels.

paragraph “Flows for shotcrete and concrete transportation” of Chapter 7 we found by trial error that inputting a maximum amount of 45m<sup>3</sup> for shotcrete at the tunnels repository and using 5m<sup>3</sup> of shotcrete per 1m tunnel advance worked well. As shown in Figure 77 this made it possible to both keep the levels of shotcrete in the repositories at a “low” level and also avoid abnormal delays in our system. Having said that one can notice in Figure 77 that shotcrete starts from 45m<sup>3</sup>, which is the initial value we had input and then the stock is reduced by the different quantities used in the tunnel. This performance is related to the cross-section profile, which is different along the tunnel and, of course, varies from one simulation to another. One can also notice in Figure 77 that after one cycle of shotcrete use as discussed above the shotcrete is then increased again by 5m<sup>3</sup> at a time.

Also in this figure one should notice that shotcrete and concrete flows stop at the time when the tunnels are completed. This is achieved with the use of the “virtual” resources (explained in earlier Chapters).

A summary of the all the quantities discussed above as they resulted from the “example” simulation is displayed in Table 10.

Table 10. Stocks in Repositories for **Scenario A** “Example” Simulation

<b>Stock Name</b>	<b>Quantity (t)</b>	<b>Percentage</b>
0/4 mm TBM	110,000	1.47%
4/8 mm TBM	74,000	0.99%
0/4 mm DB	0	0.00%
4/8 mm DB	0	0.00%
8/16 mm DB	0	0.00%
16/22 mm DB	0	0.00%
0/4 mm arDB	83,000	1.11%
4/8 mm arDB	27,000	0.36%
8/16 mm arDB	41,000	0.55%
16/22 mm arDB	33,000	0.44%
K2 Raron DB	345,000	4.60%
K2 Ferden DB	45,000	0.60%
K2 Raron TBM	727,000	9.69%
K2 Steg TBM	215,000	2.87%
K1ar TBM	179,500	2.39%
Ku AggPlant	340,000	4.53%
Ku DB	2,174,000	28.99%
Ku TBM	2,040,000	27.20%
<b>Total</b>	<b>6,433,500</b>	<b>85.78%</b>

In Table 10 the quantities of the materials that remain in the repositories after the simulations are presented. The total quantity of 6,433,500 tons of materials that remain in the repositories after the tunnels have finished is as expected. Since the total quantity of excavated materials are almost 7,500,000 tons (as shown in Table 8), approximately 1,000,000 tons of materials will become aggregates. This is exactly what was expected since for concrete approximately  $11\text{m}^3/\text{m} \cdot 42,052\text{m} = 462,572\text{m}^3$  or 925,144 tons of aggregates are needed and for shotcrete approximately  $1\text{m}^3/\text{m} \cdot 42,052\text{m} = 42,052\text{m}^3$  or 82,000 tons of aggregates are needed, which sums to 1,007,145 tons.

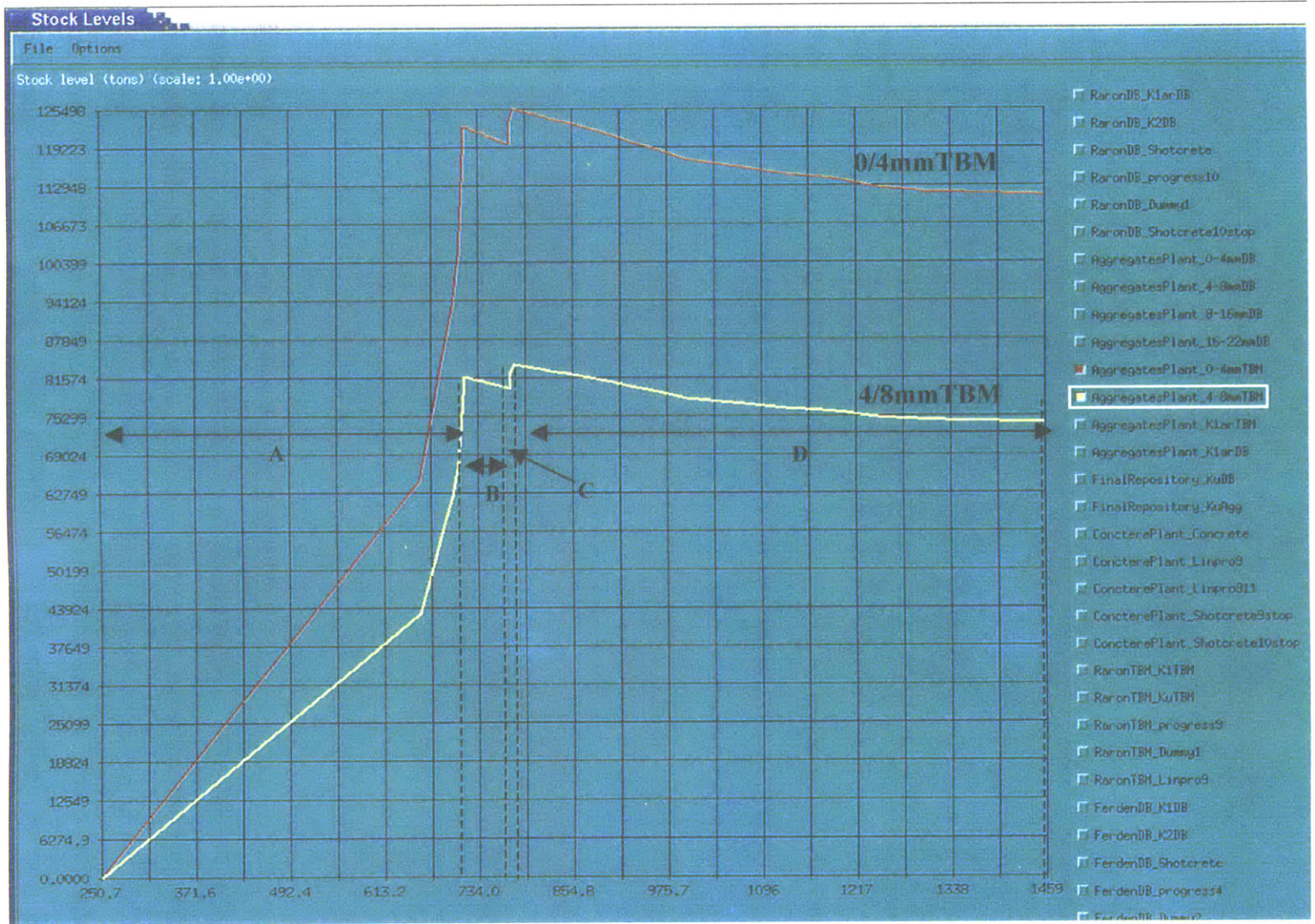

Figure 71. Scenario A “Example” Simulation Results of the Aggregates for Shotcrete at the Aggregates Plant Repository

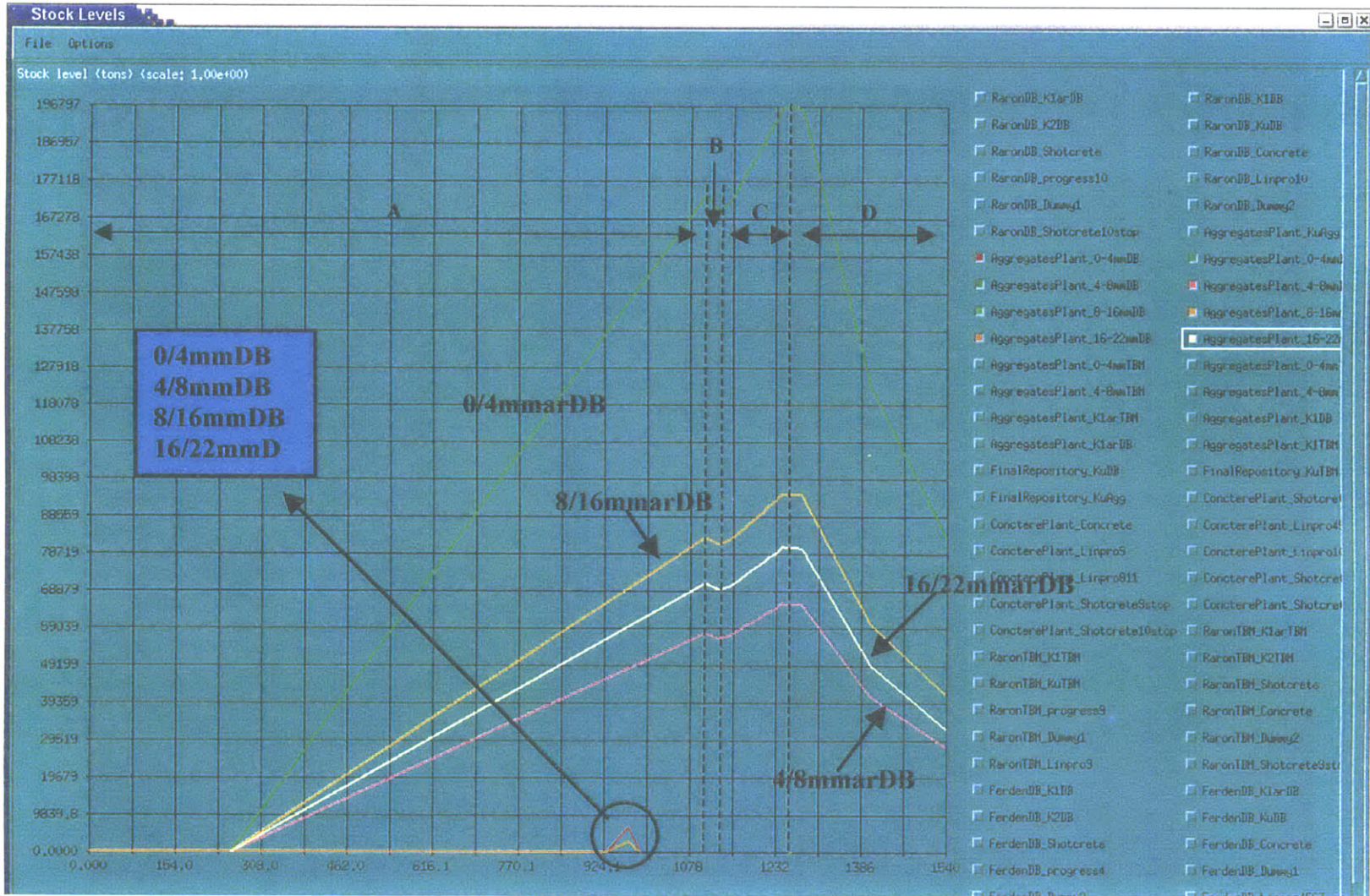

Figure 72. **Scenario A** “Example” Simulation Results of the Aggregates for Concrete at the Aggregates Plant Repository

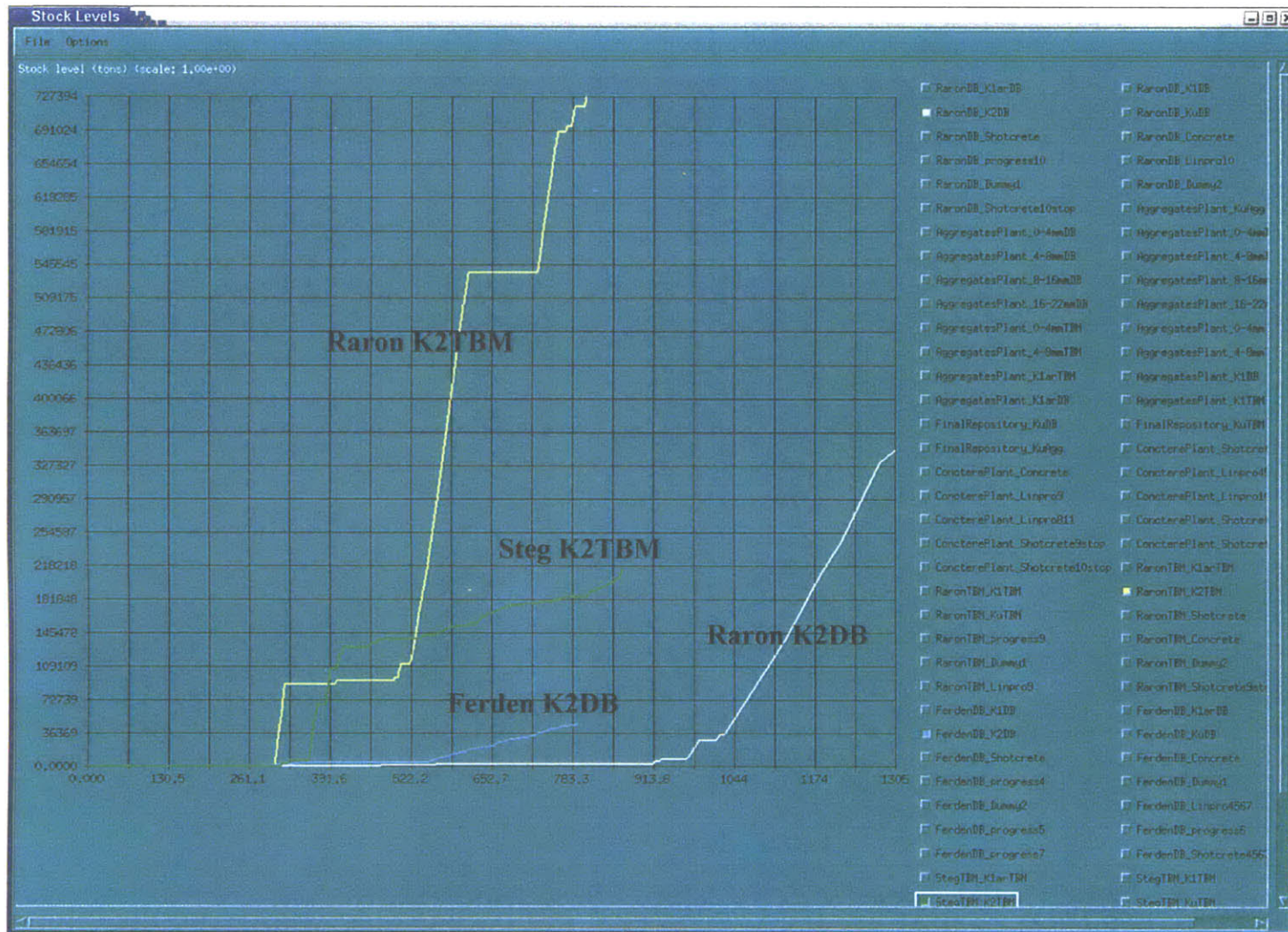

Figure 73. Scenario A “Example” Simulation Results of the K2 Stock

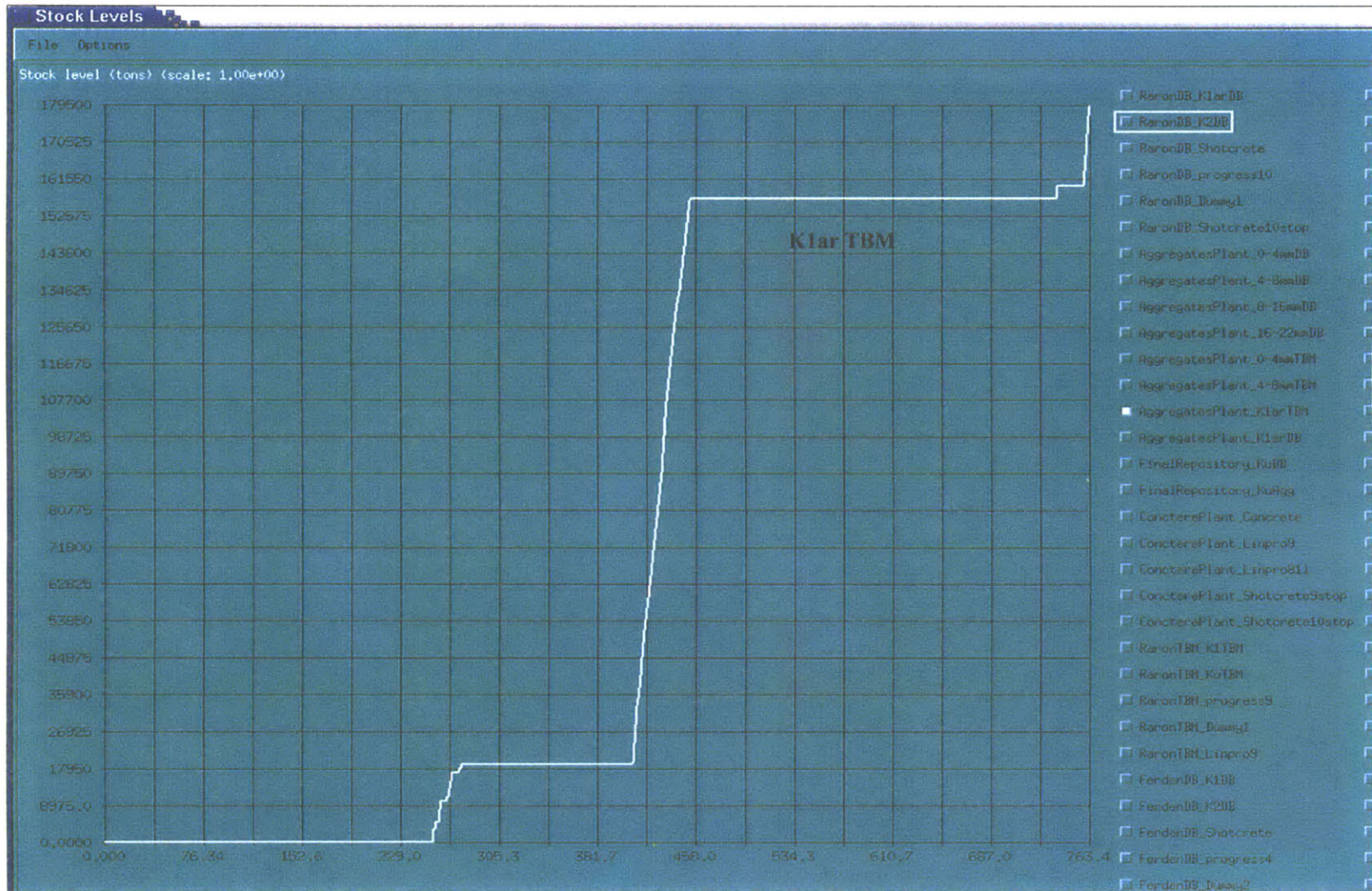

Figure 74. Scenario A “Example” Simulation Results of the Klar TBM Stock

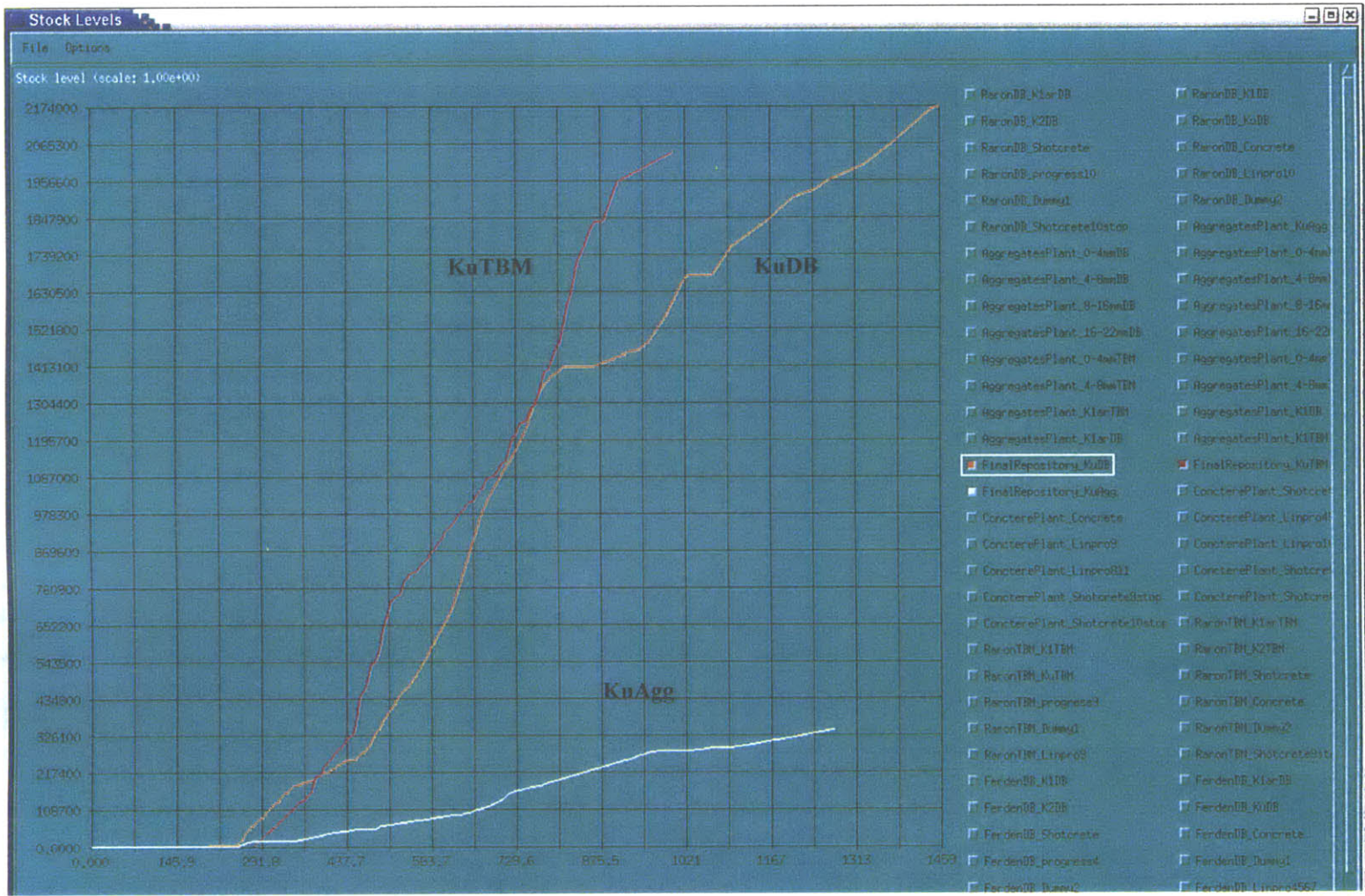

Figure 75. Scenario A “Example” Simulation Results of the KuDB, Ku TBM and KuAgg Material Stocks in the Final Repository

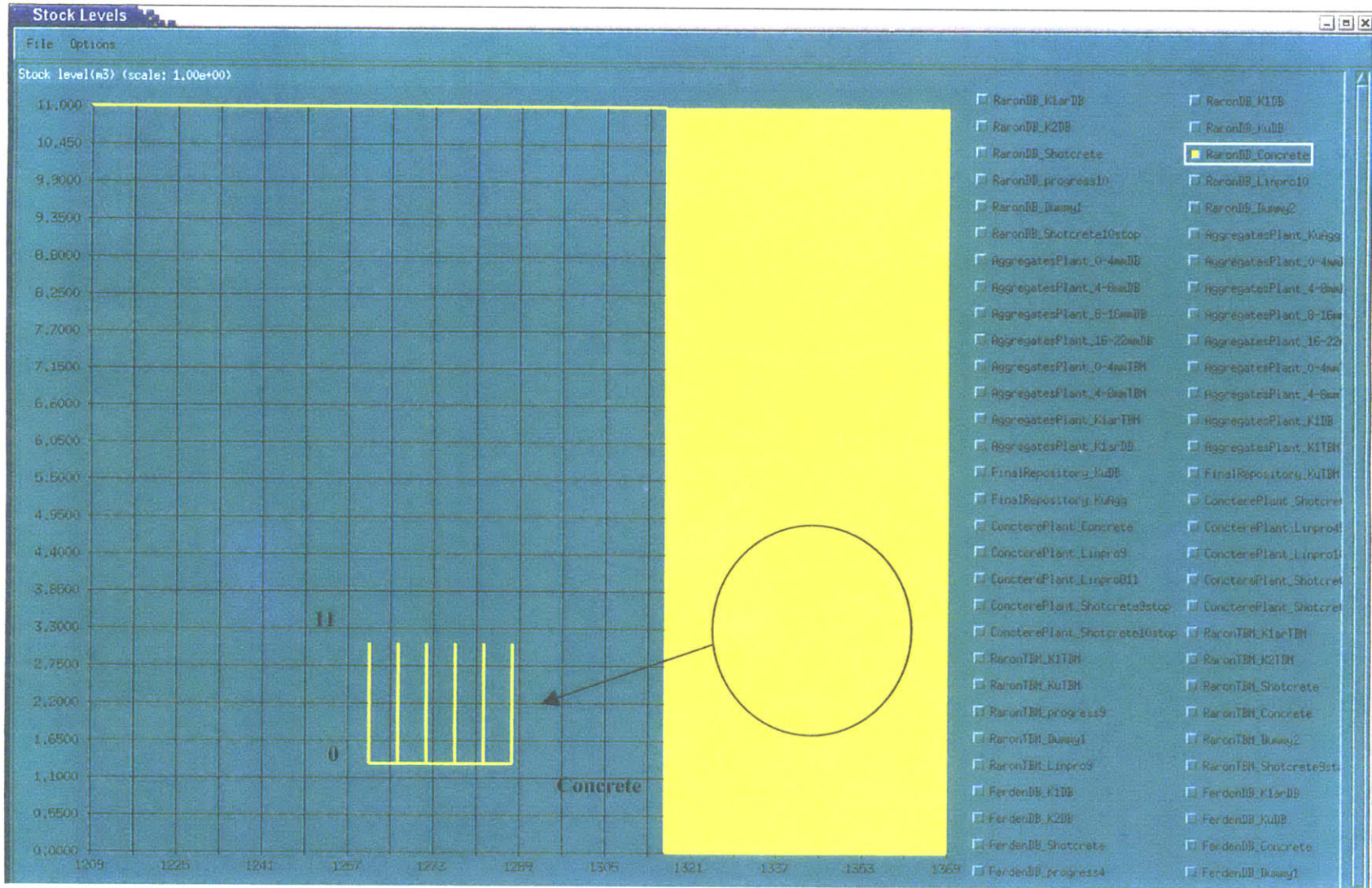

Figure 76. Scenario A “Example” Simulation Results of the Concrete Stock at the Raron DB Repository

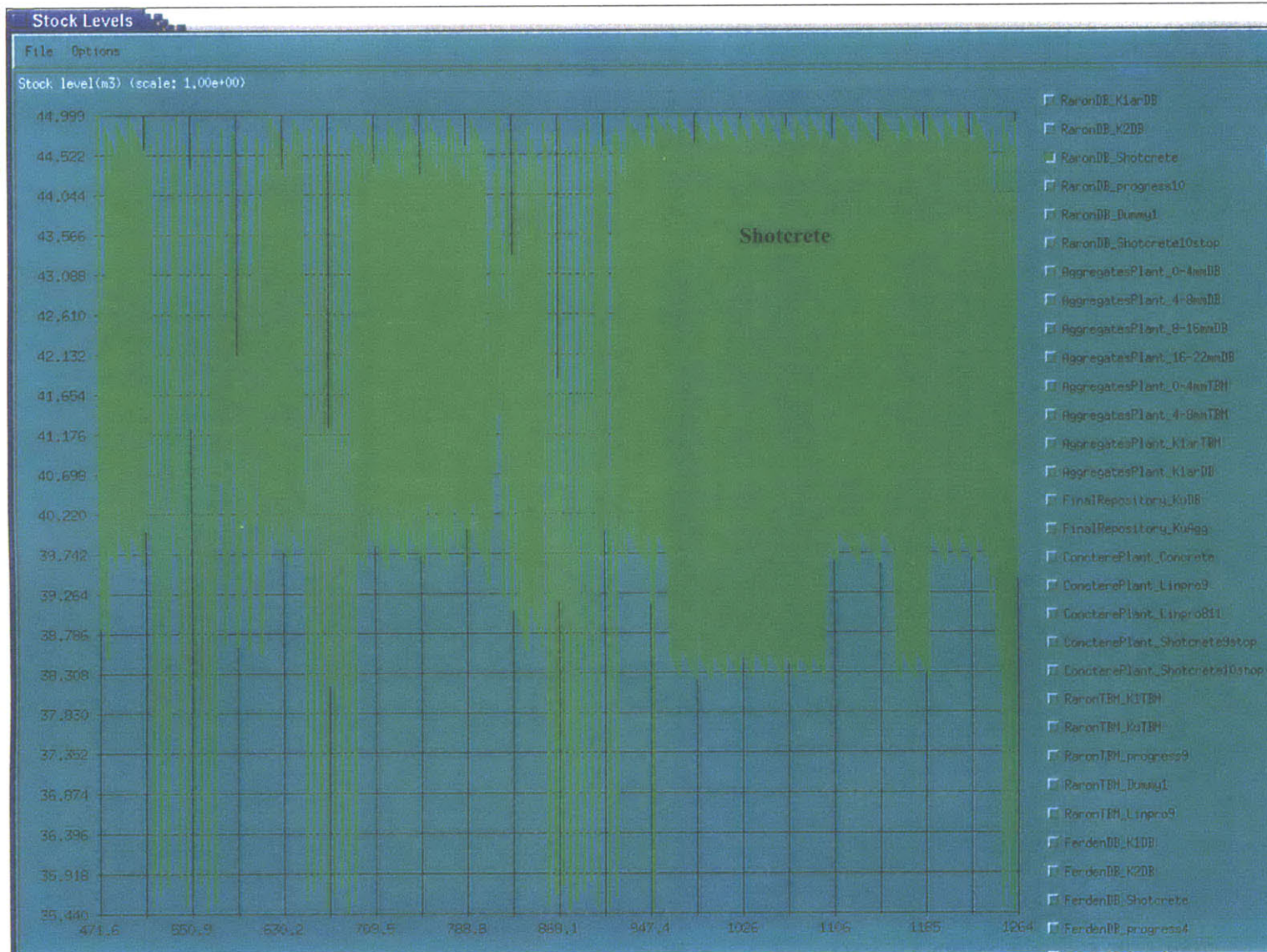

Figure 77. **Scenario A** “Example” Simulation Results of the Shotcrete Stock at the Raron DB Repository

## Simulation B Results

As stated before in this simulation we are using only non-alkali reactive K1 type of excavation materials. Concrete aggregates are produced only from K1DB materials and shotcrete aggregates are produced as in the previous simulation only from K1TBM materials.

After a careful observation of the results from Simulation A, one can predict the results of Simulation B. In Figure 72 of Simulation A one can see that most of the aggregates used for concrete production came from K1ar materials. Since K1ar materials are not used for Simulation B, it is likely that the simulation will stop due to lack of aggregates used for concrete production. As a result lining of the tunnels will not be completed.

Specifically, the simulation results for every tunnel, after 30 simulations were run, are summarized in Table 11. Less than 5% of the total lining was completed after 30 simulations.

Table 11. **Simulation B** Average Results for Excavation and Lining

<b>Tunnel Name</b>	<b>Av. End Time (days)</b>
10 Raron DB	1281
10 Raron DB Lining	Did not Finish
9 Raron TBM	1082
9 Raron TBM Lining	Did not Finish
8 AccesSteg	455
8 Steg Lining	Did not Finish
11StegTBM	823
11StegTBM Lining	Did not Finish
6 Ferden DB	800
6 Ferden DB Lining	Did not Finish
7 Ferden DB	799
7 Ferden DB Lining	Did not Finish
5 Ferden DB	1322
5 Ferden DB Lining	Did not Finish
4 Ferden DB	1400
4 Ferden DB Lining	Did not Finish

The results of the scenario B “example” simulation will be presented similarly to those of simulation A. In Figure 78 (similar to Figure 69) the results of the excavation and initial support are shown, while in Figure 79 the final support results are added. Figure 79 shows clearly that lining has barely started in this simulation. This can be seen by looking at the lining lengths, which are very small relative to the total lengths of their corresponding tunnels. Also one can see that lining has not even started for the 4 and 5 Ferden DB and 10 Raron DB tunnels.

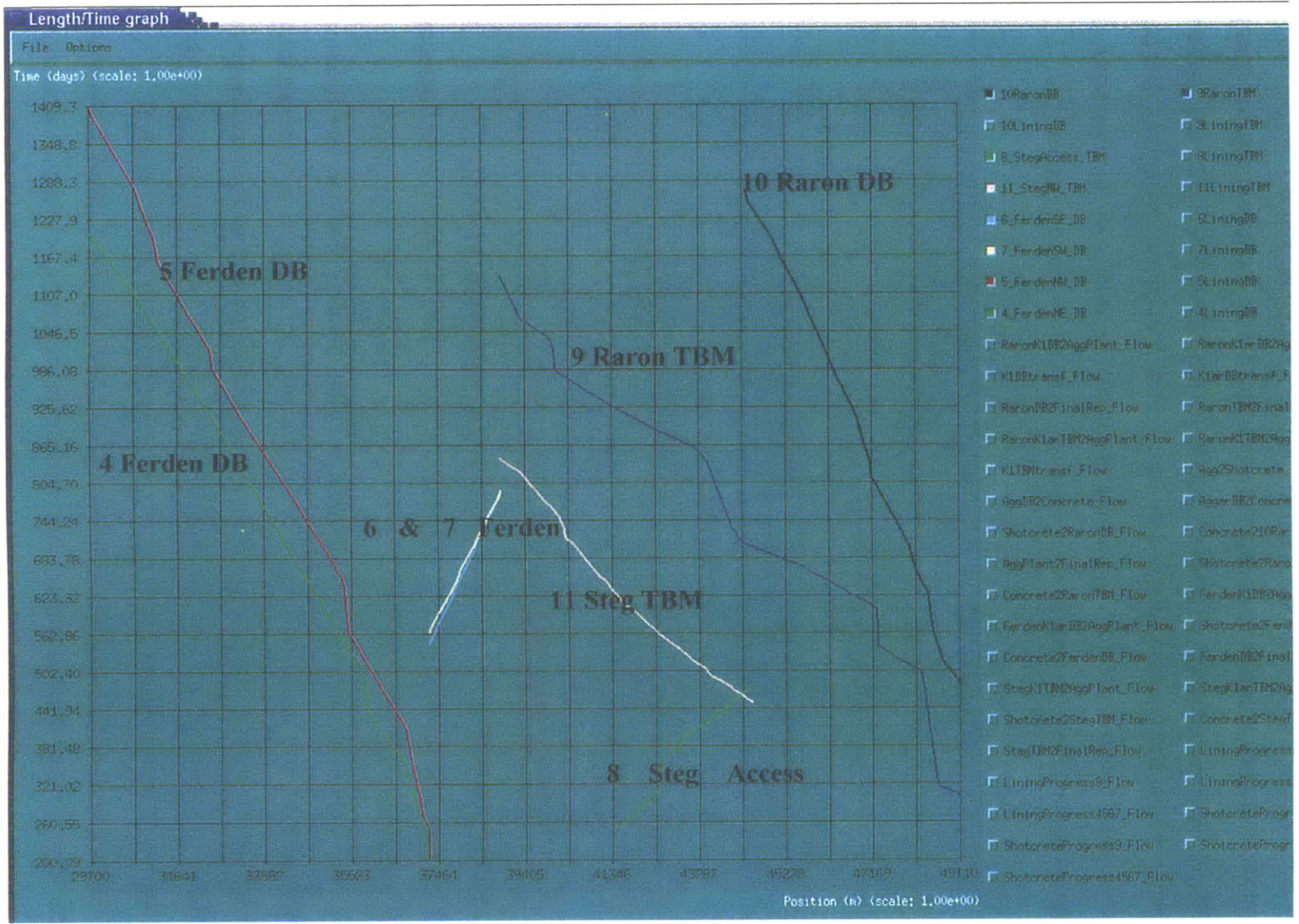

Figure 78. Scenario B “Example” Simulation Results of the Excavation and the Initial Support of the Tunnels

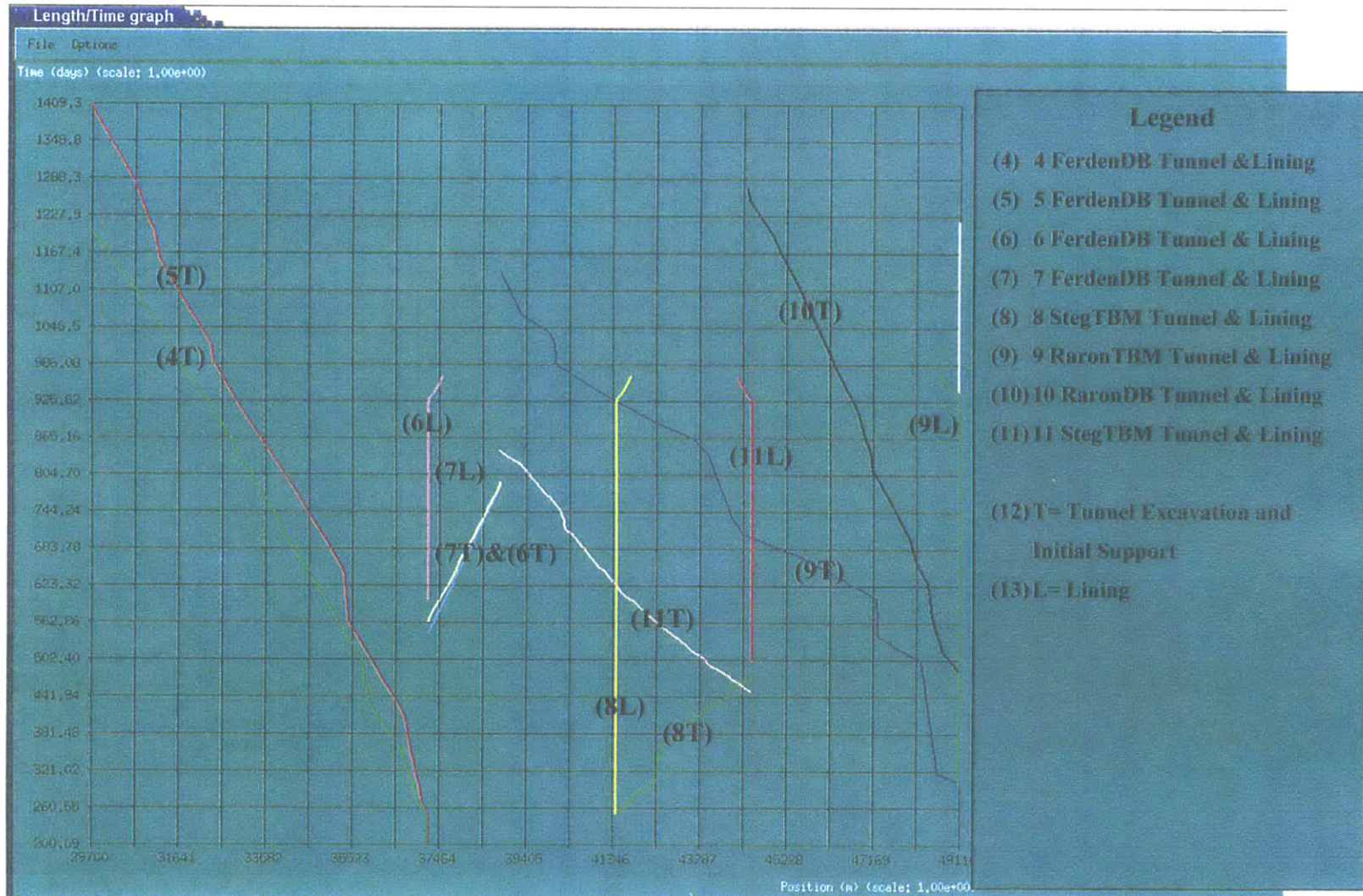

Figure 79. **Scenario B** “Example” Simulation Results of the Excavation, the Initial and the Final Support of the Tunnels  
 (Note that lining does not start before day 925, which is when K1DB material production begins. (See Figure 65))

Apart from the tunneling and lining process interesting results can again be seen when looking at materials. Shotcrete aggregates were discussed in the paragraph “Simulation A Results” and do not change in this simulation since we again only use K1TBM materials for shotcrete in scenario B. In contrast, for concrete aggregates in scenario B only K1DB materials are used. The results show that there are not enough K1DB materials and therefore the simulations stop due to lack of resources.

The stocks of K2 and K1arTBM materials remain the same as in scenario A and therefore will not be presented in this paragraph. However in scenario B there is a stock of K1arDB materials in the final repository, shown in Figure 80. This stock should be compared with the stocks of K1arDB materials formed at Raron DB and Ferden DB repositories, shown in Figure 65 and Figure 68. One can see that the stock in Figure 80 is approximately the sum of the K1arDB materials stocks in Figure 65 and Figure 68.

Also Figure 81 shows the stocks of all the useless materials that are formed in the final repository. Note in this figure that fewer useless materials are produced at the aggregates plant than in Simulation scenario A, since fewer materials are processed by the plant. In simulation A both K1DB and K1arDB materials were processed by the aggregates plant vs. simulation B in which only K1DB materials were processed.

A summary of all what is discussed above is displayed in Table 12. One should note that 97.59% of the excavated materials remain in the repositories.

Table 12. Stocks in Repositories for Scenario B “Example” Simulation

Stock Name	Quantity (t)	Percentage
0/4 mm TBM	110,000	1.47%
4/8 mm TBM	74,000	0.99%
0/4 mm DB	0	0.00%
4/8 mm DB	0	0.00%
8/16 mm DB	0	0.00%
16/22 mm DB	0	0.00%
K2 Raron DB	345,000	4.60%
K2 Ferden DB	45,000	0.60%
K2 Raron TBM	727,000	9.69%
K2 Steg TBM	215,000	2.87%
K1ar DB	1,340,000	17.87%
K1ar TBM	179,500	2.39%
Ku AggPlant	70,000	0.93%
Ku DB	2,174,000	28.99%
Ku TBM	2,040,000	27.20%
<b>Total</b>	<b>7,319,500</b>	<b>97.59%</b>

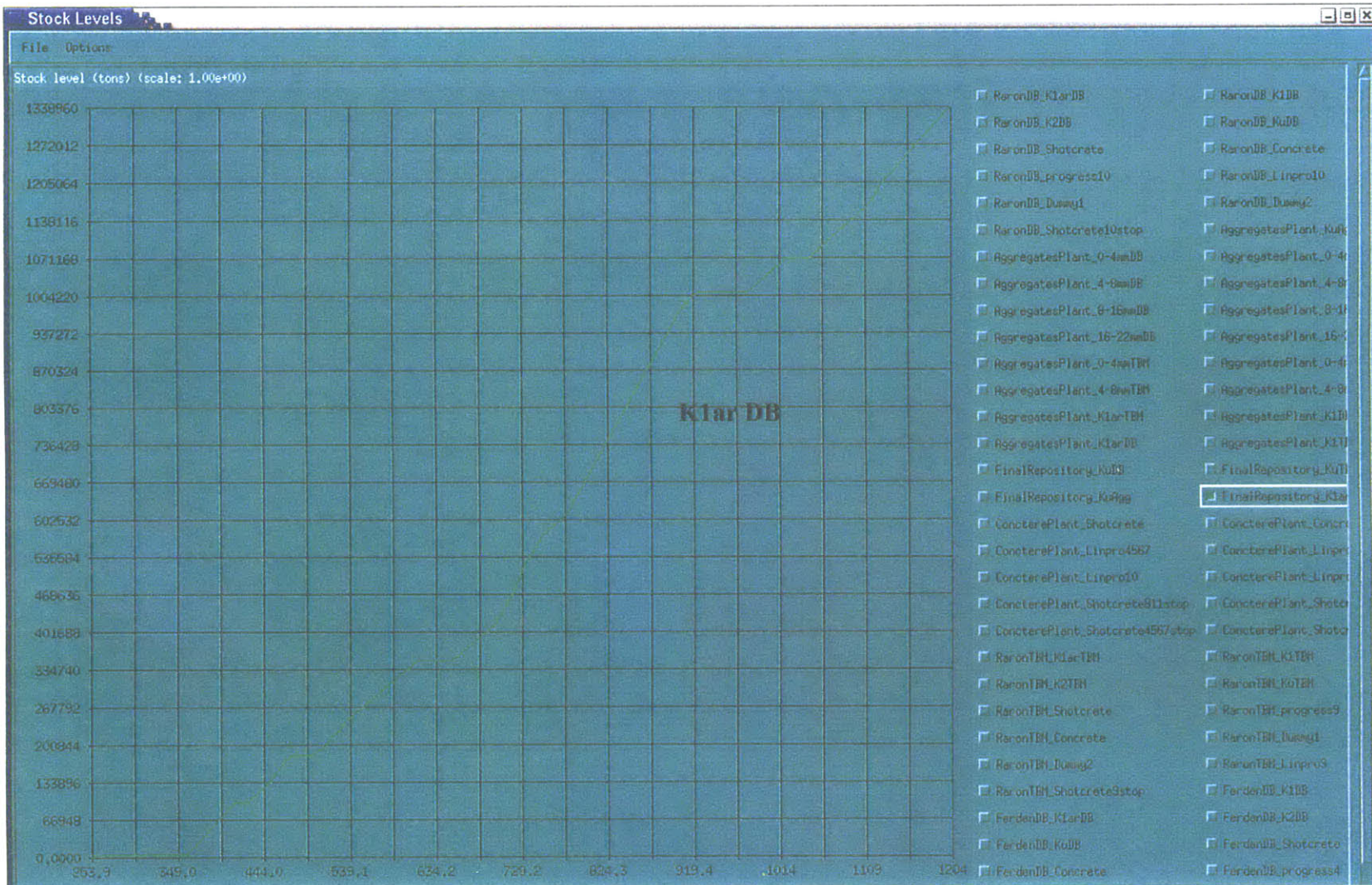

Figure 80. Scenario B “Example” Simulation Results of the K1ar DB Stock

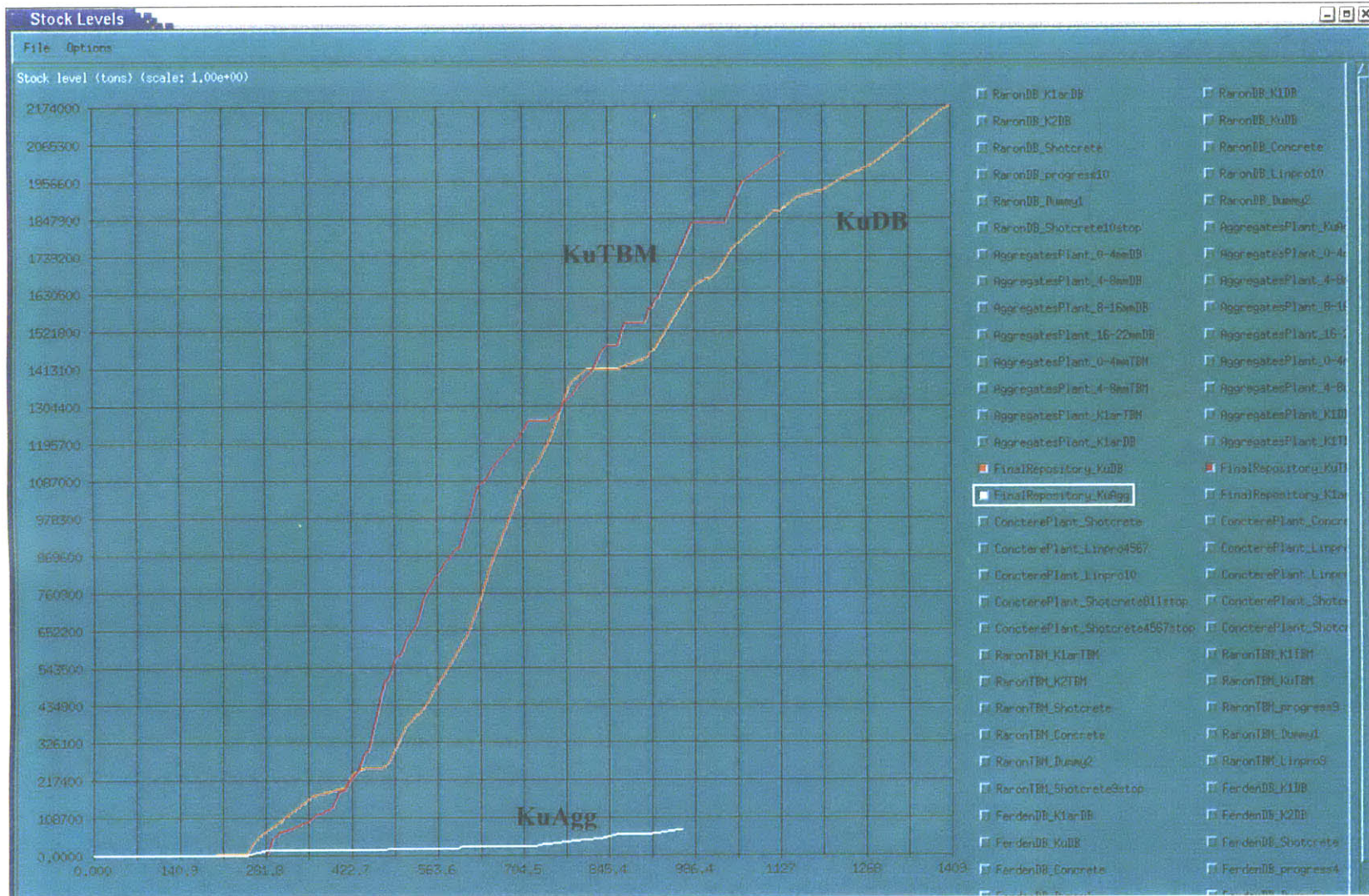

Figure 81. Scenario B “Example” Simulation Results of the Final Repository Stocks

## Simulation C Results

As stated before in this simulation we are using only non-alkali reactive K1 and K2 types of excavation materials. Concrete aggregates are produced from K1DB and K2DB materials and shotcrete aggregates are again produced only form K1TBM materials.

The simulation results for every tunnel, after 30 simulations were run, are summarized in Table 13. Approximately 40% of the total lining was completed after 30 simulations.

Table 13. **Simulation C** Average Results for Excavation and Lining

<b>Tunnel Name</b>	<b>Av. End Time (days)</b>
10 Raron DB	1,298
10 Raron DB Lining	Did not finish
9 Raron TBM	1,098
9 Raron TBM Lining	Did not finish
8 AccesSteg	452
8 Steg Lining	Did not finish
11StegTBM	830
11StegTBM Lining	Did not finish
6 Ferden DB	798
6 Ferden DB Lining	Did not finish
7 Ferden DB	793
7 Ferden DB Lining	Did not finish
5 Ferden DB	1,298
5 Ferden DB Lining	Did not finish
4 Ferden DB	1,289
4 Ferden DB Lining	Did not finish

In Figure 82 (similar to Figure 69 and Figure 78) the results of the excavation and initial support of the scenario C “example” simulation is shown, while in Figure 83 the final support results are added.

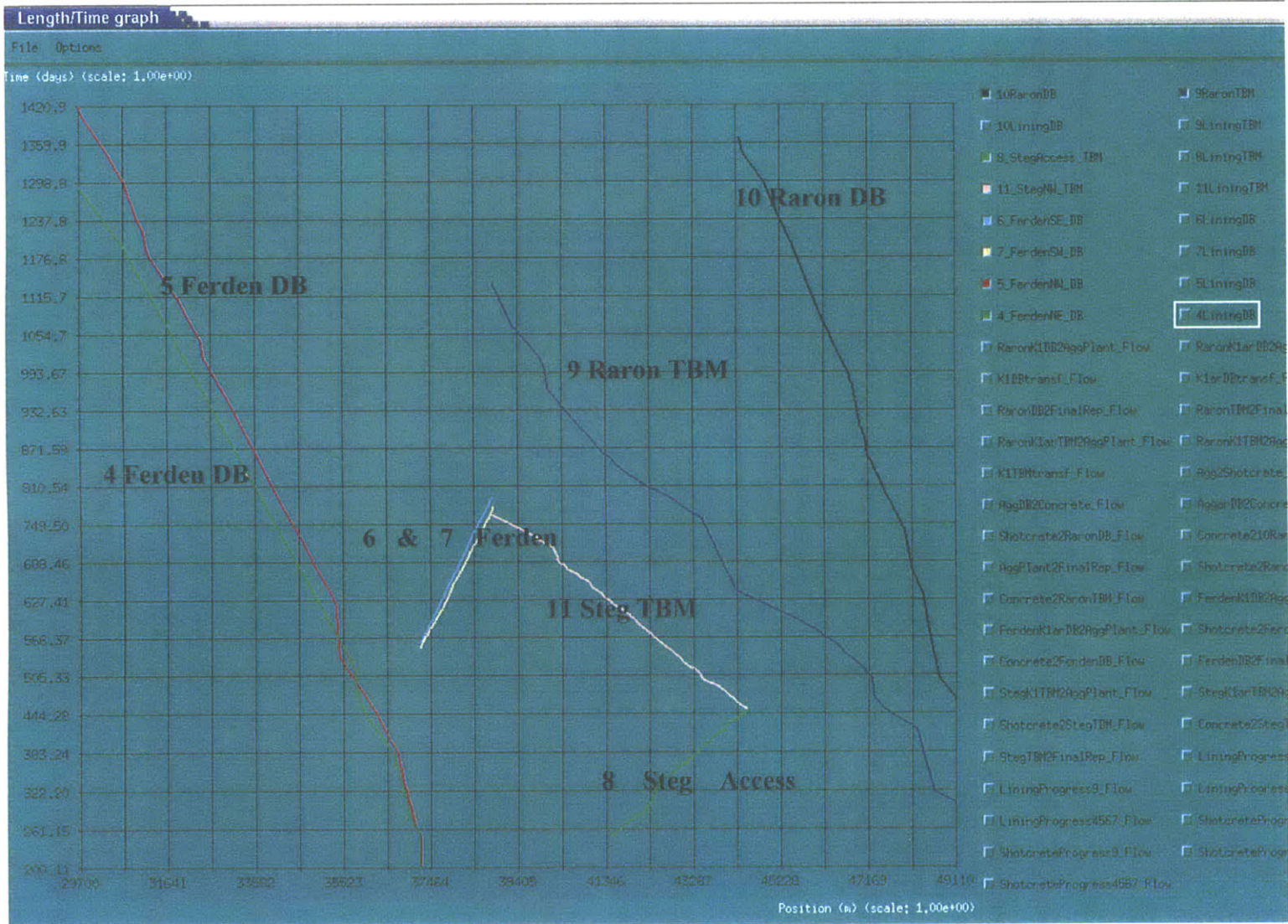

Figure 82. Scenario C “Example” Simulation Results for Excavation and Initial Support of the Tunnels

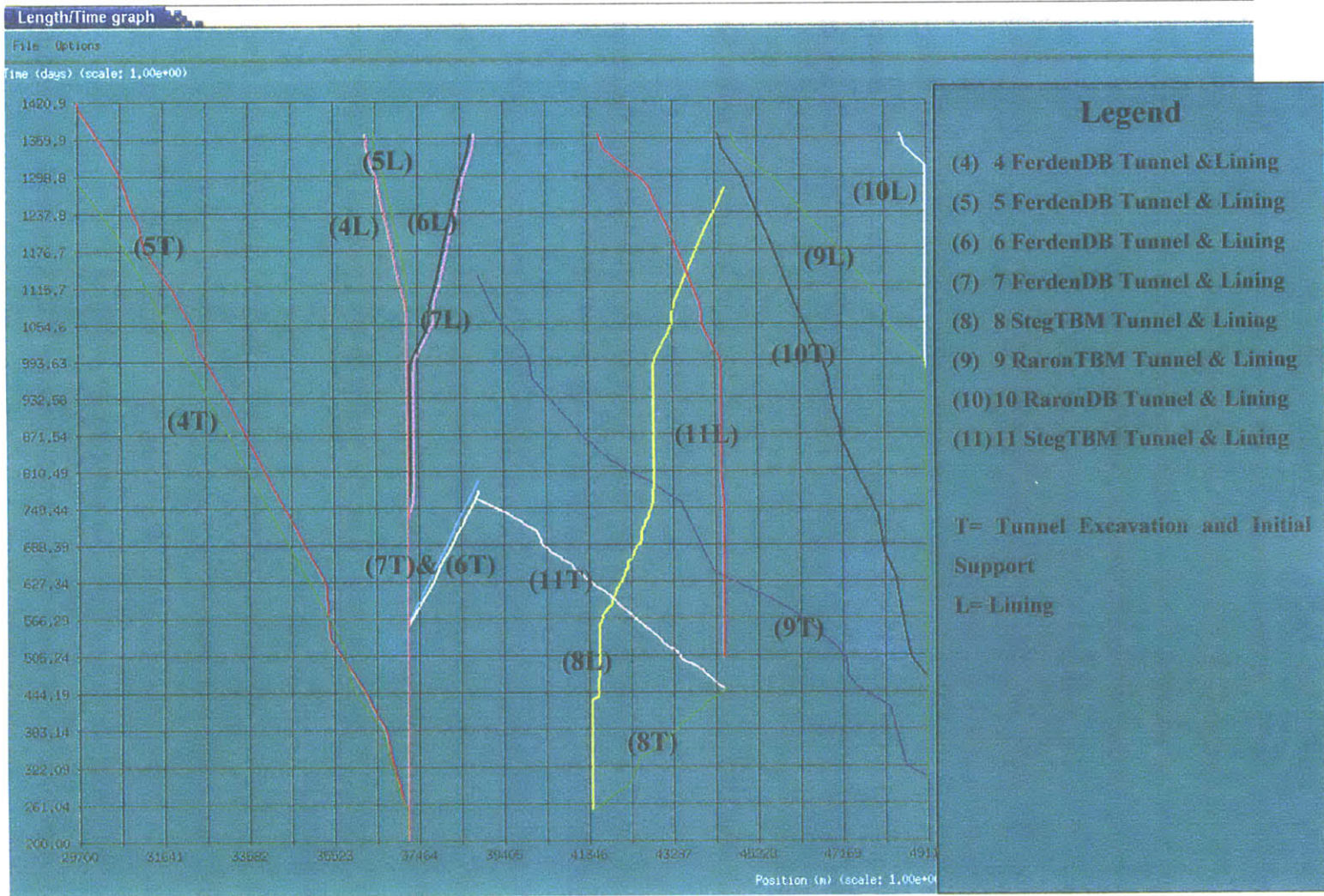

Figure 83. **Scenario C** “Example” Simulation Results for the Excavation, the Initial and the Final Support of the Tunnels  
 (Note that lining stops on day 1367, which is related to the concrete production, which stops at that time, see Figure 84)

Apart from the tunneling and lining process interesting results can again be seen when looking at materials. Shotcrete aggregates were discussed in the paragraph “Simulation A Results” and do not change in these simulations since we again only use K1TBM materials for shotcrete in simulation C. In contrast, for concrete aggregates in simulation C K1 and K2 Drill & Blast materials are used. K1DB materials are given a priority in the process. As soon as they are produced they are transported and transformed to concrete aggregates. So when K1DB materials are not produced K2DB materials are processed if they are available. The results show that there are not enough K1DB and K2DB materials and therefore the simulations stop due to lack of resources.

In Figure 65 and Figure 68 one can see the excavated quantities of K2DB materials at Raron DB and Ferden DB repositories. In Figure 84 the stocks of the non alkali-reactive 0/4 mm, 4/8mm, 8/16mm and 16/22mm aggregates formed at the Aggregates Plant are shown. We following can be seen in Figure 84:

- In stage A (day 300 to day 570) the stock increases because concrete production has not started.
- In stage B (day 570 to 600) the stock decreases because lining starts and at the same time K2DB materials are not produced. So the stock decreases.
- In stage C (day 600 to 620) the stock increases K2DB materials are produced again.
- In stage D (day 600 to 620) the stock decreases because concrete is produced at a faster pace than K2DB materials are produced.
- In stage E (day 620 to 740) the stock increases as K2DB are produced at a faster pace than concrete is produced.
- In stage F (day 740 to 770) the stock decreases because concrete is produced at a faster pace than K2DB materials are produced.
- In stage G (day 770 to 1000) the stock almost remains constant because K2DB materials are produced at the same pace as aggregates for concrete are produced.
- In stage H (day 1000 to 1367) the stock increases because K2DB materials are produced at a faster pace than aggregates for concrete are produced. The aggregate production stops approximately 150 days after the K2DB production stops, which was expected. At the end of this stage one can observe the cycles of the process. Aggregates are produced and used and

the graph in going up and down correspondingly. This performance is the same in every resources graph but the scale of the graph usually does not allow one to see this.

Similar to Simulation A, aggregates produced from K1DB materials are used first and finish first and therefore no stock is formed at the Aggregate Plant repository (see Figure 72).

The stocks of K2 and K1arTBM materials remain the same as in Simulation A scenario and therefore will not be presented in this paragraph. Also similar to Simulation B, in simulation C there is a stock of K1arDB materials in the final repository. More information can be seen in the “Simulation B results” paragraph.

Figure 85 shows the stocks of all the useless materials that are formed in the final repository.

A summary of all what was discussed above is displayed in Table 14. One should notice that 93.53% of the excavated materials remain in the repositories.

Table 14. Stocks in Repositories for Scenario C “Example” Simulation

<b>Stock Name</b>	<b>Quantity (t)</b>	<b>Percentage</b>
0/4 mm TBM	110,000	1.47%
4/8 mm TBM	74,000	0.99%
0/4 mm DB	2,000	0.03%
4/8 mm DB	650	0.01%
8/16 mm DB	1,800	0.02%
16/22 mm DB	0	0.00%
K1 arDB	1,340,500	17.87%
K2 Raron DB	0	0.00%
K2 Ferden DB	0	0.00%
K2 Raron TBM	727,000	9.69%
K2 Steg TBM	215,000	2.87%
K1ar TBM	179,500	2.39%
Ku AggPlant	150,000	2.00%
Ku DB	2,174,000	28.99%
Ku TBM	2,040,000	27.20%
<b>Total</b>	<b>7,014,450</b>	<b>93.53%</b>

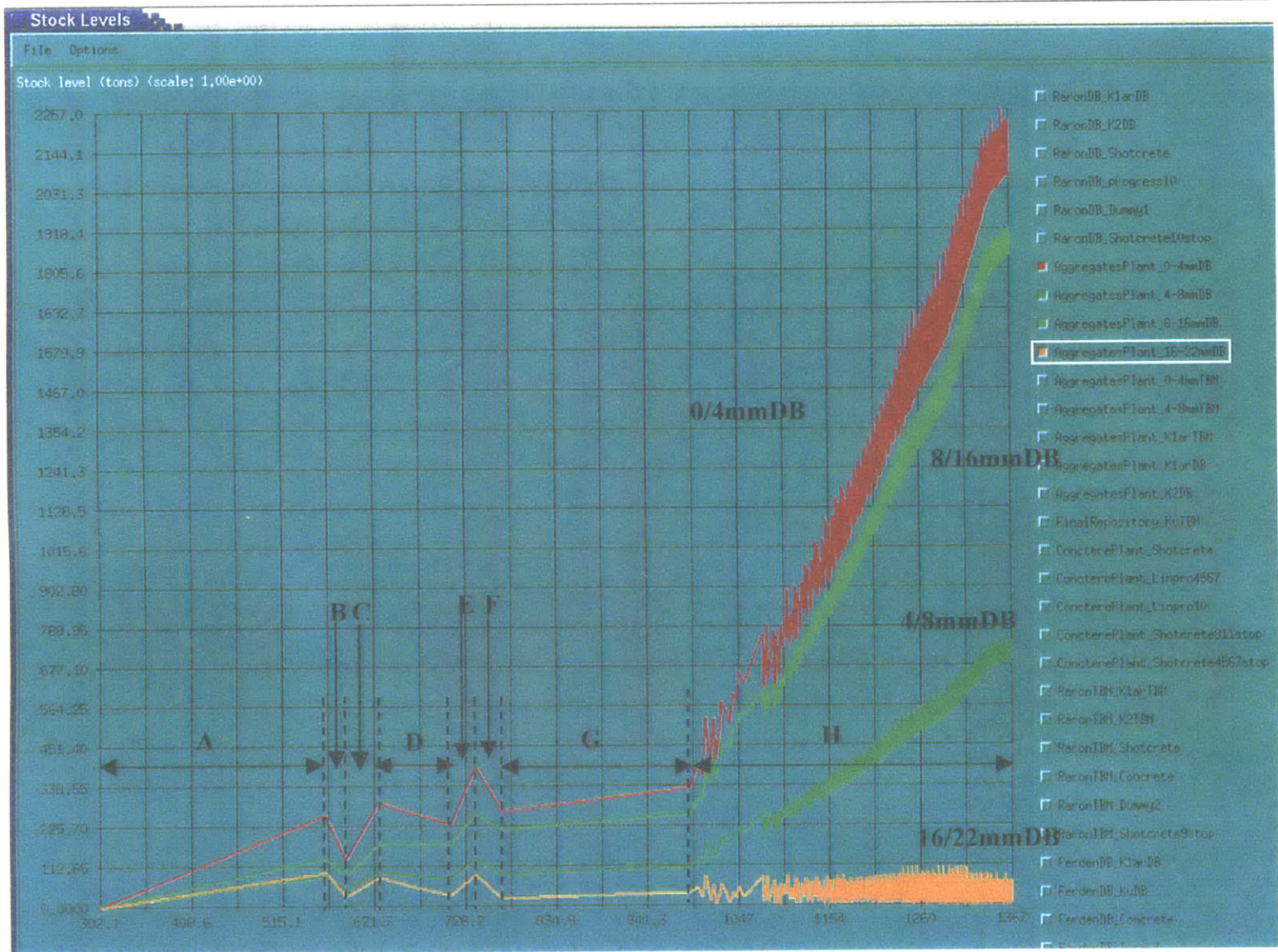

Figure 84. Scenario C “Example” Simulation Results for the Aggregates for Concrete Stocks

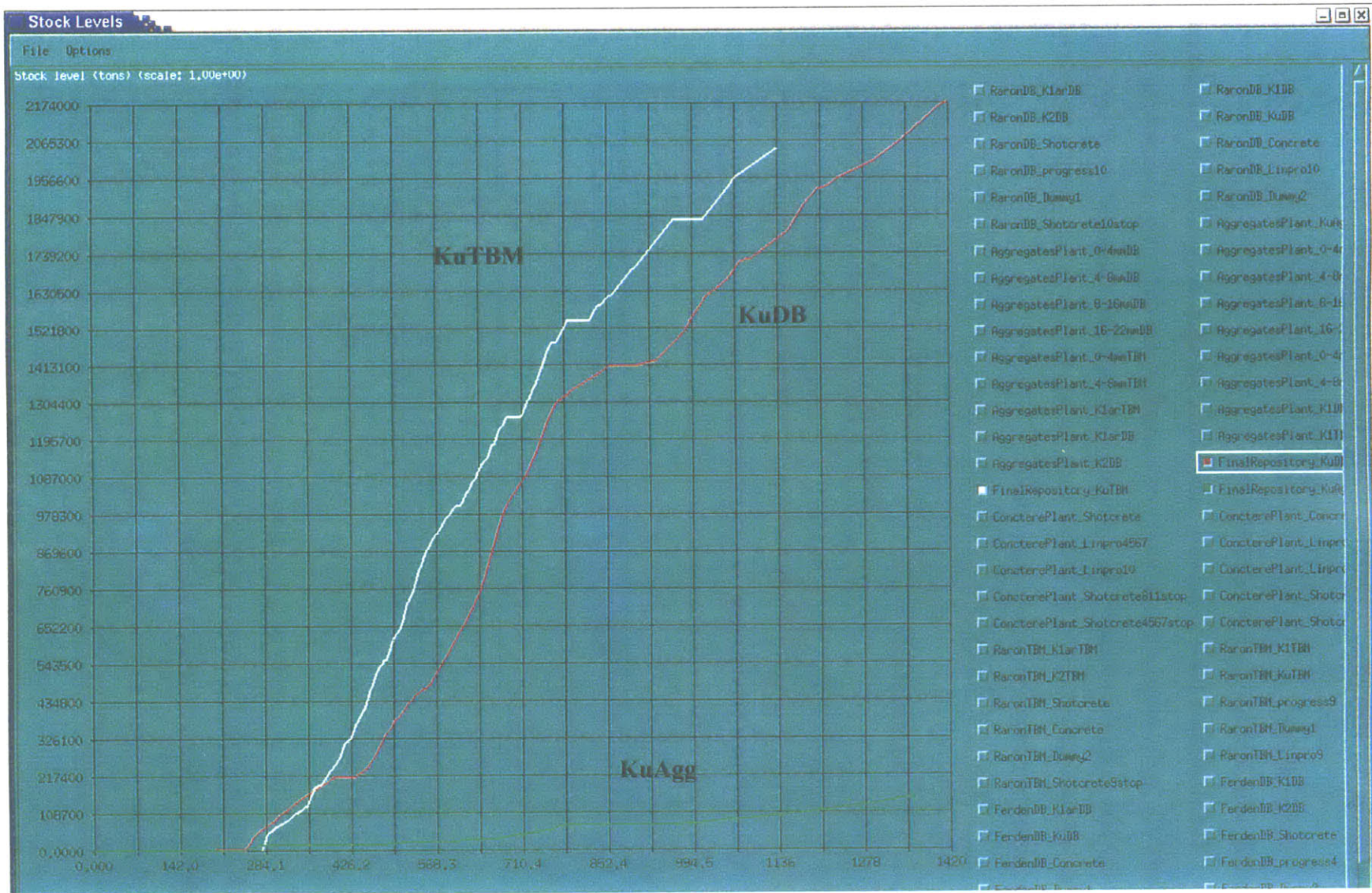

Figure 85. Scenario C “Example” Simulation Results of the KuDB, KuTBM and KUAgg in the Final Repository Stock

## Simulation A1 Results

In this scenario the transition probabilities of the Markov matrices for the excavation materials were modified by approximately 5%.

The simulation results for every tunnel after 30 simulations were run are summarized in Table 15. In the same table the results of scenario A are displayed. One can see that there are very few changes in terms of time. On the other hand the lining did not finish completely in 2 out of 30 simulations (7% vs 33% of Scenario A). This means that the 5% change is more than enough to produce more favorable results.

Table 15. **Simulation A1** Duration Results for Excavation and Lining

Tunnel Name	Av. End Time (days)	
	Scenario A	Scenario A1
10 Raron DB	1,254	1,317
10 Raron DB Lining	1,354	1,410
9 Raron TBM	1,045	1,077
9 Raron TBM Lining	1,204	1,281
8 AccesSteg	450	453
8 Steg Lining	542	540
11StegTBM	832	821
11StegTBM Lining	989	1,014
6 Ferden DB	787	788
6 Ferden DB Lining	831	838
7 Ferden DB	787	805
7 Ferden DB Lining	837	842
5 Ferden DB	1,328	1,317
5 Ferden DB Lining	1,351	1,437
4 Ferden DB	1,374	1,402
4 Ferden DB Lining	1,432	1,494

In Table 16, similarly to Simulation A, all the quantities of the “example” simulation are presented. Since the quantities have not significantly changed there is no need to present graphical results again in this paragraph.

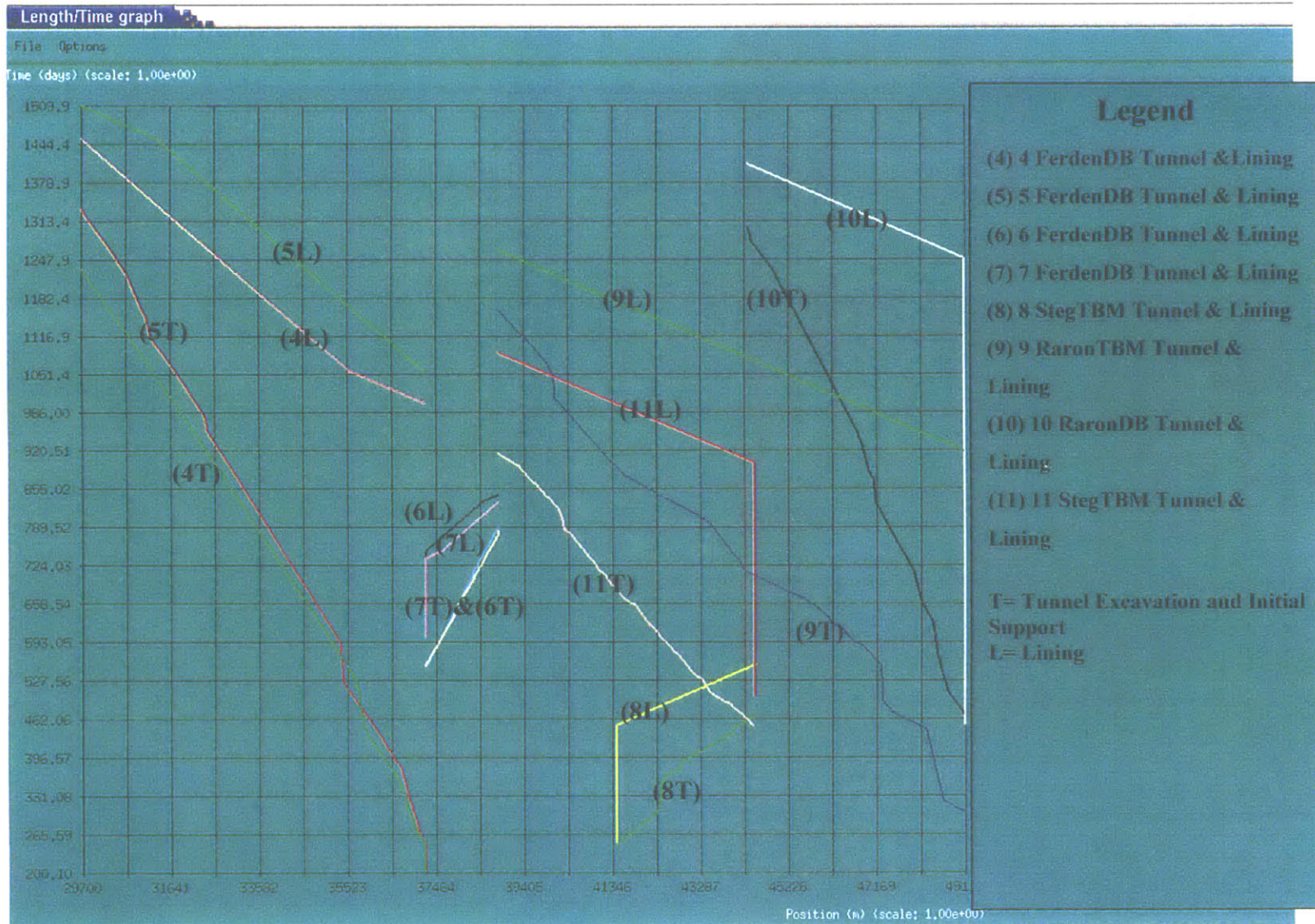

Figure 86. **Scenario A1** “Example” Simulation Results for the Excavation, the Initial and the Final Support of the Tunnels

Table 16. Stocks in Repositories for Scenario A1 & Scenario A “Example” Simulation

<b>Stock Name</b>	<b>Quantity (t) Scenario A</b>	<b>Quantity (t) Scenario A1</b>	<b>Percentage Scenario A1</b>
0/4 mm TBM	110,000	110,000	1.47%
4/8 mm TBM	74,000	74,000	0.99%
0/4 mm DB	0	0	0.00%
4/8 mm DB	0	0	0.00%
8/16 mm DB	0	0	0.00%
16/22 mm DB	0	0	0.00%
0/4 mm arDB	83,000	10,000	0.13%
4/8 mm arDB	27,000	35,000	0.47%
8/16 mm arDB	41,000	52,000	0.69%
16/22 mm arDB	33,000	42,000	0.56%
K2 Raron DB	345,000	346,000	4.61%
K2 Ferden DB	45,000	44,000	0.59%
K2 Raron TBM	727,000	727,000	9.69%
K2 Steg TBM	215,000	215,000	2.87%
K1ar TBM	179,500	179,500	2.39%
Ku AggPlant	340,000	354,000	4.72%
Ku DB	2,174,000	2,108,000	28.11%
Ku TBM	2,040,000	2,040,000	27.20%
<b>Total</b>	<b>6,433,500</b>	<b>6,336,500</b>	<b>84.49%</b>

## Simulation A2 Results

In this scenario the correlation table was modified so that certain restrictions apply concerning the cross-section and the excavation materials.

In the previous simulations the correlation factor was 0.5 meaning that all possible combinations can apply. In simulation A2 this was changed and the following correlation tables were input for every tunnel:

**10 Raron DB Correlation Table**

	ESA1	ESA2	ESA3a	ESA3b	ESA4a	ESA4b	ESA5ak4	ESA5ak5	ESA5b5
K1arDB	0.7	0.6	0.5	0.5	0.5	0.5	0.3	0.2	0.2
K1DB	0.7	0.6	0.5	0.5	0.5	0.5	0.3	0.2	0.2
K2DB	0.5	0.5	0.5	0.5	0.5	0.5	0.5	0.5	0.5
KuDB	0.2	0.3	0.5	0.5	0.5	0.5	0.6	0.7	0.7

As can be seen we considered more/less possibilities for ESA1 and ESA2 cross-sections to occur with K1arDB and K1DB/KuDB materials and similarly ESA5ak4, ESA5ak5 and ESA5b5 to occur with KuDB/K1arDB and K1DB materials.

Similarly the rest correlation tables are presented below:

**9 Raron TBM, 8StegAccess TBM and 11 Steg TBM Correlation Table**

	ET1a	ET1b	ET2	ET3a	ET3b	ET4a	ET4b	ET5a	ET5b
K1arTBM	0.7	0.6	0.5	0.5	0.5	0.5	0.5	0.3	0.2
K1TBM	0.7	0.6	0.5	0.5	0.5	0.5	0.5	0.3	0.2
K2TBM	0.5	0.5	0.5	0.5	0.5	0.5	0.5	0.5	0.5
KuTBM	0.2	0.3	0.5	0.5	0.5	0.5	0.5	0.6	0.7

**6 & 7 Ferden DB Correlation Table**

	ESx1a	ESx2a	ESx2b	ESx3a	ESx3b	ESx4a	ESx5a	ESx6a	ESx6b
K1arDB	0.7	0.6	0.5	0.5	0.5	0.5	0.3	0.2	0.2
K1TDB	0.7	0.6	0.5	0.5	0.5	0.5	0.3	0.2	0.2
K2DB	0.5	0.5	0.5	0.5	0.5	0.5	0.5	0.5	0.5
KuDB	0.2	0.3	0.5	0.5	0.5	0.5	0.6	0.7	0.7

**4 & 5 Ferden DB Correlation Table**

	ES1a	ES2a	ES2b	ES3a	ES3b	ES4a	ES5a	ES6a	ES6b
K1arDB	0.7	0.6	0.5	0.5	0.5	0.5	0.3	0.2	0.2
K1TDB	0.7	0.6	0.5	0.5	0.5	0.5	0.3	0.2	0.2
K2DB	0.5	0.5	0.5	0.5	0.5	0.5	0.5	0.5	0.5
KuDB	0.2	0.3	0.5	0.5	0.5	0.5	0.6	0.7	0.7

The simulation results for every tunnel after 30 simulations were run are summarized in Table 17. One can see that there are not many changes in the tunnel results, What was different in scenario A2 was that neither the tunnels nor the lining stopped due to lack of resources during the 30 simulations.

Table 17. **Simulation A2** Duration Results for Excavation and Lining

Tunnel Name	Av. End Time (days)	Av. End Time (days)
	Scenario A	Scenario A2
10 Raron DB	1,254	1,316
10 Raron DB Lining	1,354	1,427
9 Raron TBM	1,045	1,028
9 Raron TBM Lining	1,204	1,245
8 AccesSteg	450	466
8 Steg Lining	542	550
11StegTBM	832	846
11StegTBM Lining	989	1,014
6 Ferden DB	787	834
6 Ferden DB Lining	831	856
7 Ferden DB	787	842
7 Ferden DB Lining	837	862
5 Ferden DB	1,328	1,442
5 Ferden DB Lining	1,351	1,527
4 Ferden DB	1,374	1,410
4 Ferden DB Lining	1,432	1,521

In Figure 87 the results of the “example” simulation for the excavation and initial support together with the final support results are shown. In Table 18, similar to Simulation A, all the quantities of the “example” simulation are presented. In this table one can see that the quantities especially of materials produced from K1arDB have changed significantly. This is a very interesting result and shows that the correlation matrix should be used and accurately defined, since it can be a very significant factor.

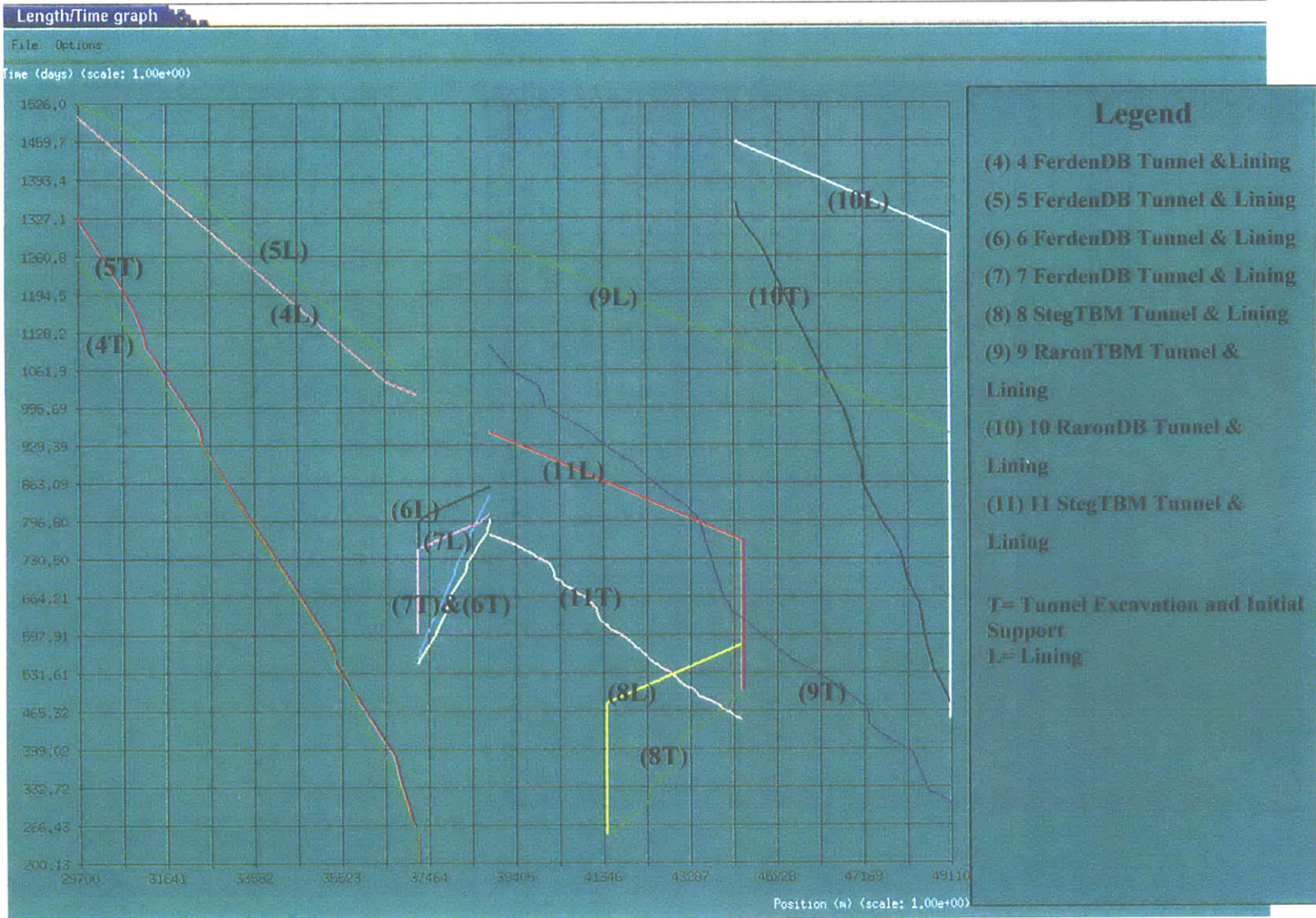

Figure 87. **Scenario A2** “Example” Simulation Results for the Excavation, the Initial and the Final Support of the Tunnels

Table 18. Stocks in Repositories for Scenario A2 & A “Example” Simulation

<b>Stock Name</b>	<b>Quantity (t) Scenario A</b>	<b>Quantity (t) Scenario A2</b>	<b>Percentage Scenario A2</b>
0/4 mm TBM	110,000	109,000	1.45%
4/8 mm TBM	74,000	72,000	0.96%
0/4 mm DB	0	0	0.00%
4/8 mm DB	0	0	0.00%
8/16 mm DB	0	0	0.00%
16/22 mm DB	0	0	0.00%
0/4 mm arDB	83,000	330,000	4.40%
4/8 mm arDB	27,000	110,000	1.47%
8/16 mm arDB	41,000	156,000	2.08%
16/22 mm arDB	33,000	135,000	1.80%
K2 Raron DB	345,000	342,000	4.56%
K2 Ferden DB	45,000	73,500	0.98%
K2 Raron TBM	727,000	698,500	9.31%
K2 Steg TBM	215,000	238,000	3.17%
K1 ar TBM	179,500	173,000	2.31%
Ku AggPlant	340,000	477,000	6.36%
Ku DB	2,174,000	1,467,000	19.56%
Ku TBM	2,040,000	2,050,000	27.33%
<b>Total</b>	<b>6,433,500</b>	<b>6,431,000</b>	<b>85.75%</b>

## **Chapter 9 A System Dynamics Approach in Tunneling**

### **System Dynamics Concept**

System dynamics is a method for studying the world around us. Unlike other scientists, who study the world by breaking it up into smaller and smaller pieces, system dynamicists look at things as a whole. The central concept to system dynamics is understanding how all the objects in a system interact with one another. System Dynamics is after all a set of conceptual tools that enable us to understand the structure and dynamics of complex systems.

A system can be anything from a steam engine, to a bank account, to a basketball team. The objects and people in a system interact through "feedback" loops, where a change in one variable affects other variables over time, which in turn affects the original variable, and so on. These feedback processes, along with stock and flow structures, time delays, and nonlinearities, determine the dynamics of a system. All dynamics arise from interaction of just two types of feedback loops the positive (self- reinforcing) and the negative (self- correcting) loops.

So what system dynamics attempts to do is understand the basic structure of a system, and thus understand the behavior it can produce. Many of these systems and problems, which are analyzed, can be built as models on a computer. System dynamics takes advantage of the fact that a computer model can be of much greater complexity and carry out more simultaneous calculations than can the mental model of the human mind.

System Dynamics must be used to model and solve a problem, not to model a system. A model must have a clear purpose and that purpose must be to solve a problem or a concern.

## **Steps of SD modeling**

The steps presented in this paragraph are from the Business Dynamics book by John Sterman.

### **1. Problem Articulation (Boundary Selection)**

- Theme selection: What is the problem? Why is it a problem?
- Key variables: What are the key variables and concepts we must consider?
- Time horizon: How far in the future should we consider? How far in back in the past lie the roots of the problem
- Dynamic problem definition (reference modes): What is the historical behavior of the key concepts and variables? What might their behavior be in the future.

### **2. Formulation of Dynamic Hypothesis**

- Initial hypothesis generation: What are current theories of the problematic behavior?
- Endogenous focus: Formulate a dynamic hypothesis that explains the dynamics as endogenous consequences of the feedback structure.
- Mapping: Develop maps of causal structure based on the initial hypotheses, key variables, reference modes, and other available data, using tools such as: model boundary diagrams, subsystem diagrams, causal loop diagrams, stock and flow maps, policy structure diagrams and other facilitation tools.

### **3. Formulation of a Simulation Model**

- Specification of structure, decision rules.
- Estimation of parameters, behavioral relationships and initial conditions.

### **4. Testing**

### **5. Policy Design and Evaluation**

## System Dynamics in Tunneling

In rapidly changing business environment, the construction industry has been seeking a new method to ensure a faster and more economic project delivery. On the other hand it is very common for most projects to run behind the schedule and over budget. Specifically, in tunneling there are two major examples for this:

- **The Channel Tunnel** -- original estimate, \$3 billion; final cost, \$10 billion
- **Boston's "Big Dig"** -- original mid-1980's estimate, \$2.5 billion; latest estimate, \$14.5 billion (9/2001).

Construction is inherently dynamic and involves multiple feedback processes that produce self-correcting or self-reinforcing side effects of decisions [J. Sterman, 1992].

In this section we will present an initial attempt to identify these feedback processes and demonstrate how these feedback processes can impact the development, design and construction, of a tunnel project. We will not differentiate between the different delivery construction methods (fast-tracking construction<sup>27</sup> or sequential construction), since as stated above this is only an initial and general attempt to describe the tunneling process and not a detailed study.

In most civil engineering project total cost is divided into design cost and construction cost. As stated above the cost together with the schedule are the parameters that cause problems to projects. In order to use system dynamics modeling we have to identify the key variables which affect the parameters and then link them together by creating feedback loops.

So, the key variables in this case are considered to be the following:

- **Geological Exploration:** Is a costly operation, which defines the geological parameters used during the tunnel design.
- **Defined Geology:** This is the result of the geological exploration.
- **Uncertainties:** Geology, more than other parameters, causes uncertainties in tunnel and general underground projects.

---

<sup>27</sup> Briefly stated, fast tracking compresses the project schedule by running design and construction phases simultaneously. For example, in a typical fast-track project, foundation and steel packages are purchased before the building layout is fixed. Design may run as little as a week ahead of construction, and myriad design decisions are made in the field.

- **Design Changes:** During the design all the parameters are identified and all the major decisions are made. If there is a need to redesign, this causes delays and increases the cost.
- **Construction Changes:** When design changes, construction is strongly effected, both in cost and in time.
- **Claims:** When an unforeseen factor occurs during a project usually contractors use legal means “claims” to manage cost and delays. This most times leads to further delays and in some extreme cases projects have to be abandoned.
- **Delays.**
- **Safety:** Safety means in general increase the total cost.

As a result the causal loop diagram that follows is an initial attempt to model this problem.

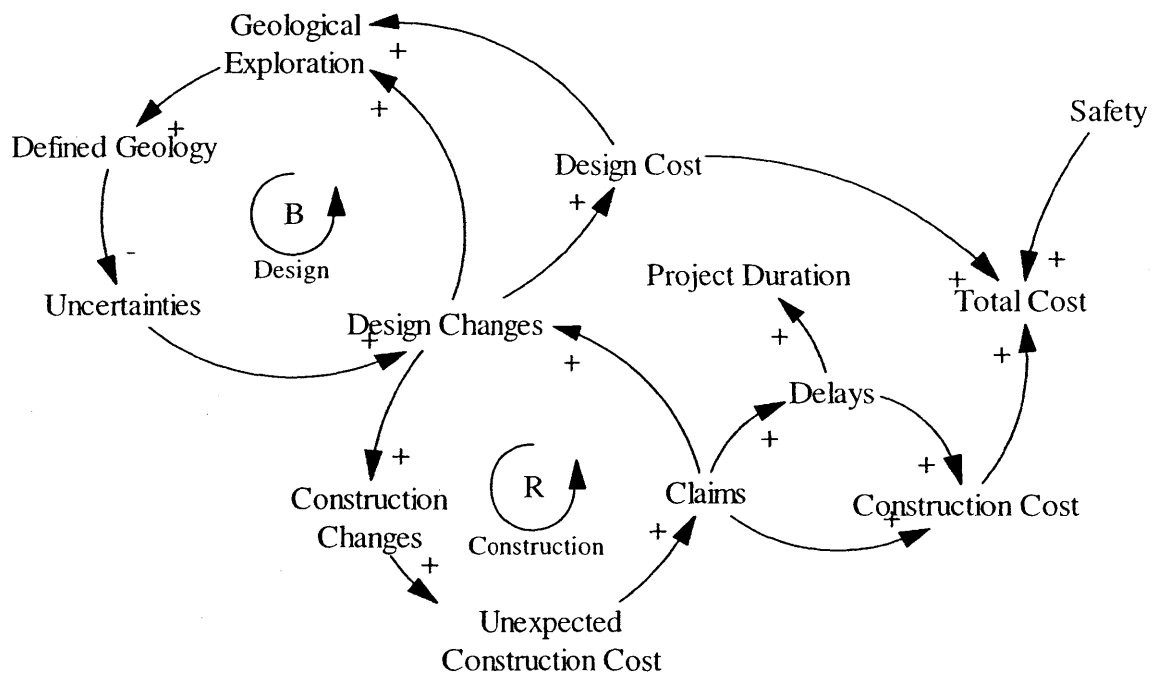

There are two feedback loops in this causal loop diagram. One is the “Design” self-correcting feedback loop and the other is the “Construction” self-reinforcing/ positive feedback loop.

- The “Design” feedback loop is explained below:

The more we explore (Geological Exploration) the more defined the geology will be. The more the defined the geology the fewer uncertainties will arise. The more uncertainties the more design changes and the more design changes the more exploration is needed. Also more design changes increase design cost and thus total cost.

- The “Construction” feedback loop is explained below:

The more design changes the more the construction changes. The more the construction changes the more the unexpected construction cost. The more the unexpected construction cost, the more the claims that the contractor will submit. The greater the claims the more the changes in design. Also the more the claims the more the delays and the more the delays, cause increase in the project duration and also increase in the construction cost.

To conclude, the design feedback loop contributes to a decrease of the design changes vs. the construction loop, which reinforces the design changes. Depending on the size, complexity and the project team, the feedback process discussed can have a significant impact on the project performance. The causal loop presented above proves that the success of a tunnel project heavily depends on the design and the elimination of the design changes.

The DAT contributes to both feedback loops presented above. Since it simulates the geology of the tunnel, it minimizes the uncertainties and thus the design changes, which cause increase of the cost. Also by conducting construction simulations one can get significant information about the unexpected cost, the delays and the overall project duration distribution.



## Chapter 10 Conclusions and Perspectives

Resources management in tunneling is definitely a factor which should be considered in tunnel design. Economic and environmental issues appear to favor the reuse of materials but due to the variety of the uncertainties and the risk involved it is very difficult to predict and thus plan and manage such operations. The research results presented in this thesis contribute to this area by proving that computer simulations can be conducted for the reuse of the excavation materials, since this was done for an actual and very complex tunnel project, the Loetschberg Base Tunnel (Southern Part). The simulations were conducted using the DAT with the associated computer code SIMSUPER, which prove to be a powerful tool for tunneling and underground construction.

A short review of the conclusions drawn from this research is presented below. Then some perspectives for future research are developed.

### Conclusions drawn from the Simulations

Results from the different simulation scenarios A, B and C show that if alkali reactive materials are not used in this project, then concrete aggregate will have to be purchased in order to cover the needs of the final support. Specifically, it can be seen that the only simulation, in which excavation, initial and final support can be completed for all tunnels, is scenario A, in which alkali reactive materials are used for concrete production.

Also, it is known that the geometry of TBM excavation materials may be unsuitable for concrete aggregate production. Hence the use of the TBM as an excavation method in this project can be questioned from a materials management point of view (clearly there are also other considerations). Otherwise expressed, if Drill & Blast were used instead of the TBM less alkali reactive materials would have to be used.

Also from simulation A1 we can conclude that a 5% change in the Markov matrices for the excavation materials, which determine the probability that particular excavation materials occur with particular geologies, does affect the results. Specifically, the results from simulation A1 show that there is a shift towards more K1DB and K1arDB excavation materials, relative to the total excavation volume, due to the changed Markov matrices. This

in turn means that the probability that the lining is not completed decreases in scenario A1 to 7% vs. 33% in scenario A. This means that there is a high probability that there will be enough internal concrete production for the needs of the tunnels.

From simulation A2 we can conclude that a few modifications in the correlation matrix could also cause changes in the results. Apart from the fact that the excavation and the lining were completed in every simulation, the results of the A2 scenario simulations were less scattered both regarding time and material quantities. This was expected since when the correlations have an effect this increases or reduces the probability of the different parameters (geologic profiles and excavation material types) existing together and thus reduces the variability within the resulting zones.

## General Conclusions

Assessing the risks involved in a tunneling project is difficult. This research, together with several simulations made in the past proves that with the help of the DAT risk can be reduced.

Using a resource model while designing a tunnel project can lead to completely different decisions concerning the excavation methods and excavation means. Materials management simulations, using the DAT, indicate the time at which every material is excavated. These results in combination with the tunnel excavation simulations can significantly assist in choosing the excavation method.

The results of the simulations showed that the reuse of the excavation materials for the support of a tunnel uses only 10% of the total excavated volume. This means that if the rest of the materials are not used (in other parts of the project or in nearby construction projects) the only important reason for reusing the materials is cost. It also indicates that reuse for other purposes should be considered, at least from an environmental point of view.

## Future Research and Development

The resource model of the DAT is a powerful means for conducting materials management simulations. Further research could look into the possibility of a more realistic

model for the simulation of resources like the initial support of a tunnel. The quantity that is needed for every meter of the excavation of such resources (i.e. shotcrete, rock bolts etc.) can not be predefined, since it is subject to the geology. Therefore a more realistic model should first simulate the geology, then identify the quantity of the resource needed and then use this exact quantity in the transportation of the resource.

Also in the present resources model there is no time dependency between the resources and the flows. The flows start when resources are available and then stop when they are not. In reality there are often delays between these processes, which with the current resource model can not be simulated. The user should be able to decide when (exact time) to start or stop a flow. The only way to link resources with time in the current model is by using “virtual” resources, which is a complicated way and not always applicable.

Another future development would be to create a version of SIMSUPER that will include in one data file all the different simulation scenarios (possibly create different layers for every scenario). In the current version of SIMSUPER this is impossible and the user has to create different simulation scenarios in different data files. Having all the scenarios in one data file could also include the possibility of running them in parallel. This would definitely help both during the creation of the files as well as during the evaluation of the results. The user would thus be able to compare the results before and after the resources are used.

The graphical output as well as the interface of SIMSUPER is something that should be further developed in order for the program to be more attractive. Also, there are many options in the current version of the program, which are not used. Especially for educational purposes these should be eliminated and the software should be as simple as possible.

Finally, the DAT could also be used in the future for simulations regarding the equipment and the machinery needed for the project. Since one can follow the steps of the simulations all the bottlenecks caused by the equipment (e.g. crusher for aggregates production), can be identified. Therefore decisions concerning specific technical characteristics of a machine (i.e. speed, capacity and size) could also be made.



**Appendix A**  
**Initial Support Profiles**

Table A-1. Initial Support for Different Profiles

	Profile	Section m <sup>2</sup>	Excavation class	Application conditions	Support	Floor
FULL FACE  TYPE A	ESA1	63.8	I	No rock dislocation	Shotcrete	Lean concrete
	ESA2	63.8	II	Slight dislocation	Swellex bolts Shotcrete	Lean concrete
	ESA3a	63.8	III	Average dislocation	Swellex bolts Shotcrete + mesh	Protection concrete
	ESA3b	63.8	III	Average rock bursts	Yielding Swellex or Split Set bolts Wire mesh Shotcrete	Protection concrete or lean concrete
	ESA4a	65.0	IV	Significant dislocation	Fibreglass bolts on tunnel face Steel ribs Steel plates Shotcrete	Protection concrete
	ESA4b	65.0	IV	Severe rock bursts	Yielding Swellex or Split Set bolts Wire mesh Shotcrete + mesh	Protection concrete
	ESA5a	74.0	V	Extreme dislocation	Fibreglass bolts Steel plates Reinforced steel ribs + formwork mesh Poured-in-place concrete	Steel ribs Floor concrete
	ESA5b	79.0	V	High deformations	Fibreglass bolts on tunnel face Grouted rebars Sliding ribs Shotcrete + mesh	Sliding ribs + grouted rebars Shotcrete Floor concrete + mesh
HALF FACE  TYPE B	ESB3a	64.1	III	Average dislocation	Grouted rebars and Swellex Shotcrete + mesh	Protection concrete
	ESB4a	65.1	IV	Significant dislocation	Grouted rebars + fibreglass bolts Steel ribs Steel plates Shotcrete	Protection concrete
	ESB5a	79.0	V	High deformations	Rebars and fibreglass bolts Sliding ribs Shotcrete + mesh	Sliding ribs Protection concrete + mesh
DIVIDED FACE  TYPE C	ESC4a	79.2	IV	Significant dislocation	Rebars and fibreglass bolts Sliding ribs Shotcrete + mesh	Sliding ribs Shotcrete
	ESC5a	79.2	V	Extreme dislocation	Rebars and fibreglass bolts Sliding ribs Shotcrete + mesh	Rebars and fibreglass bolts Sliding ribs

# Profiltyp ESA1

1:50

Ausbruchklasse I

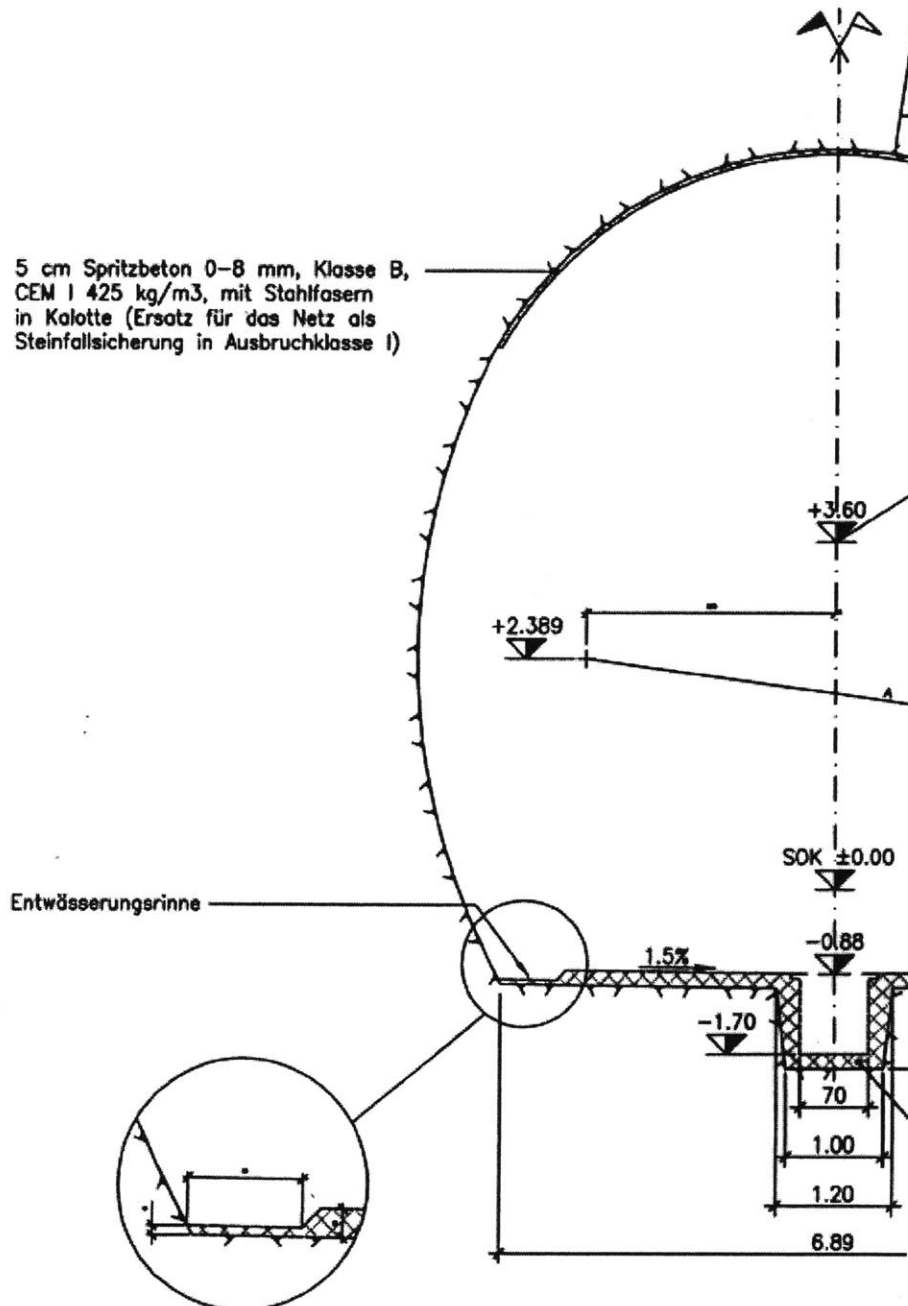

Figure A-1. Drill & Blast Profile ESA1



# Profiltyp ESA3a

1:50

Ausbruchklasse III

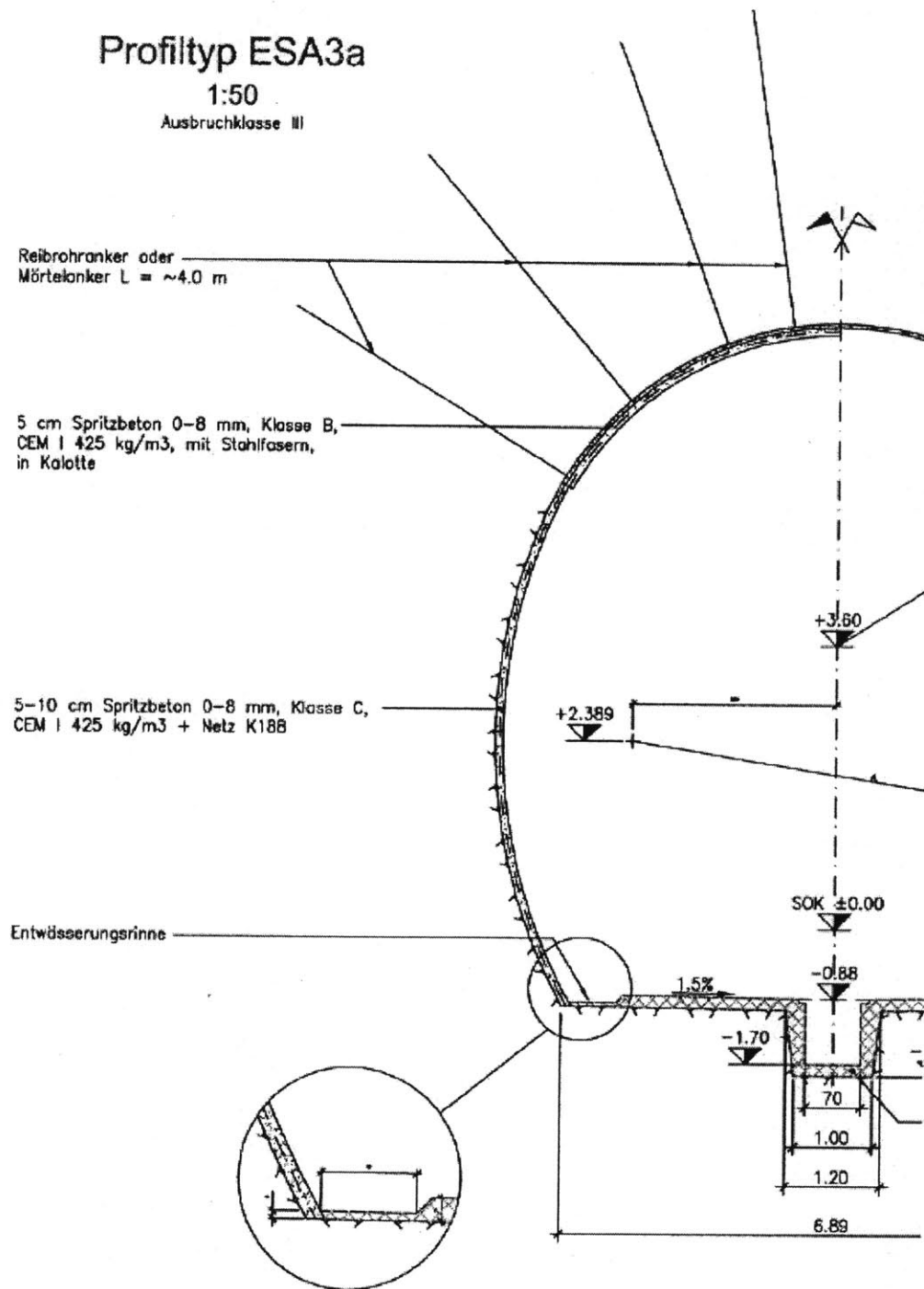

Figure A-3. Drill & Blast Profile ESA3a

# Profiltyp ESA3b

(bei mässigem Bergschlag)

1:50

Ausbruchklasse III

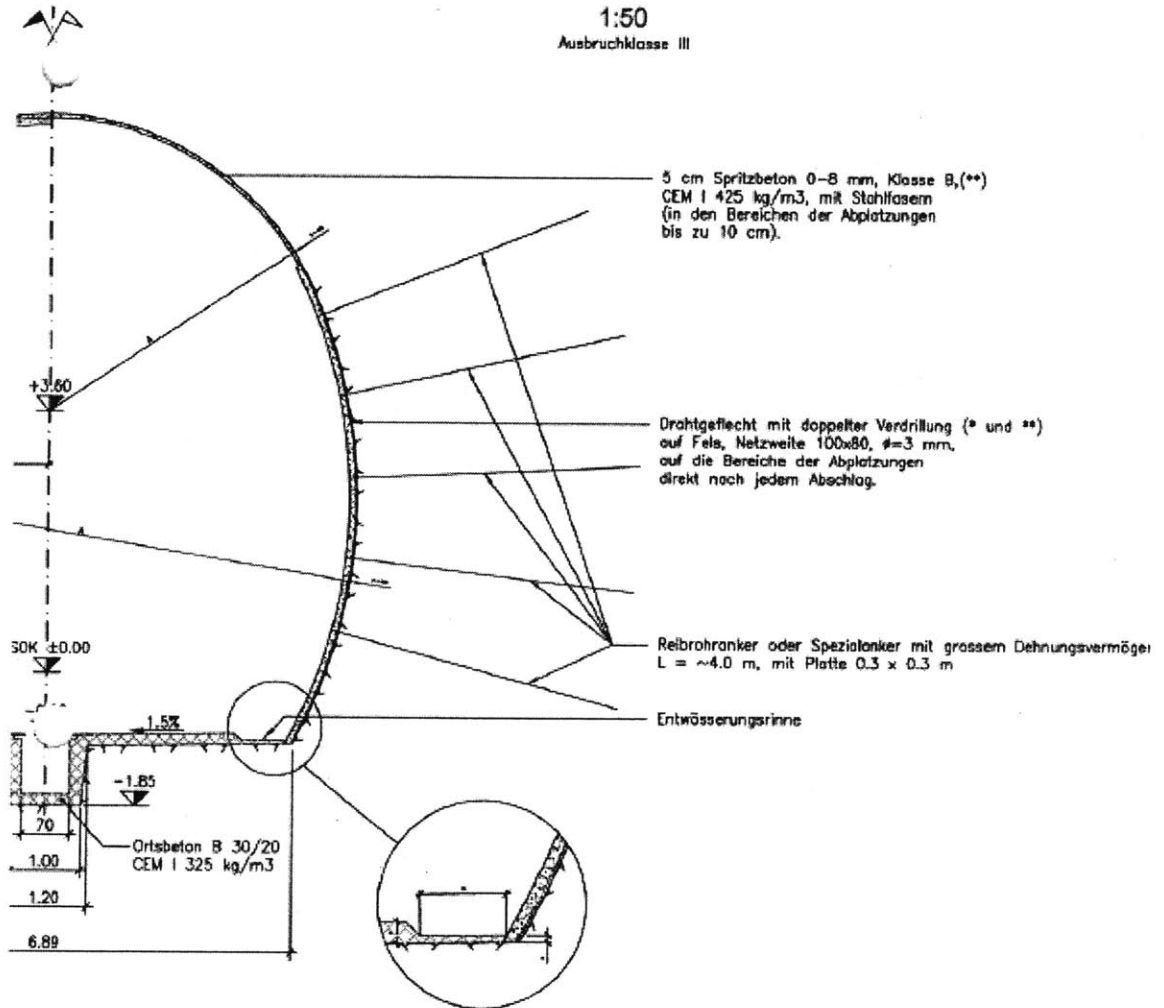

Figure A-4. Drill & Blast Profile ESA3b

# Profiltyp ESA4a

1:50

Ausbruchklasse IV

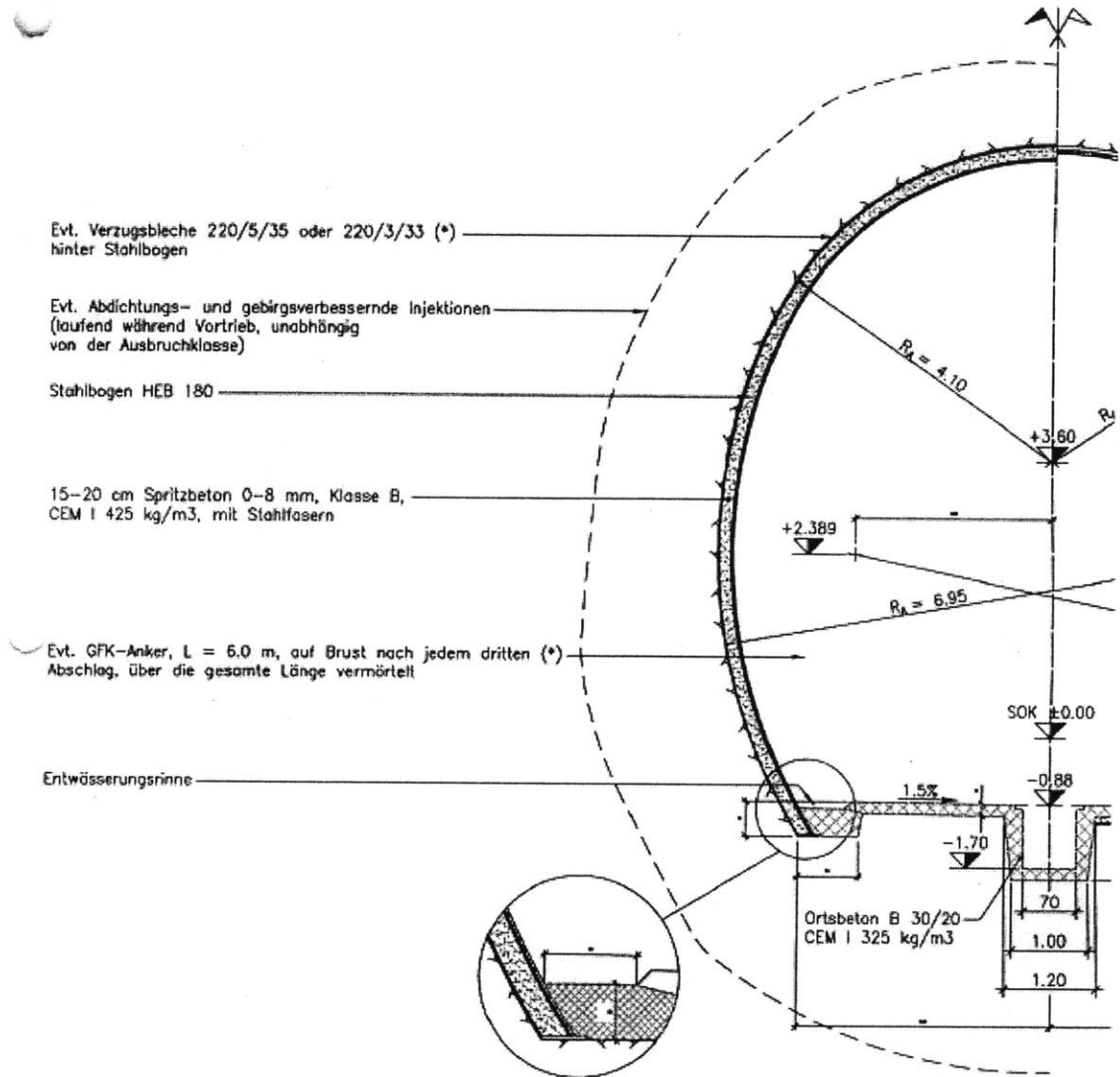

Figure A-5. Drill & Blast Profile ESA4a

# Profiltyp ESA4b

(bei beträchtlichem Bergschlag)

1:50

Ausbruchklasse IV

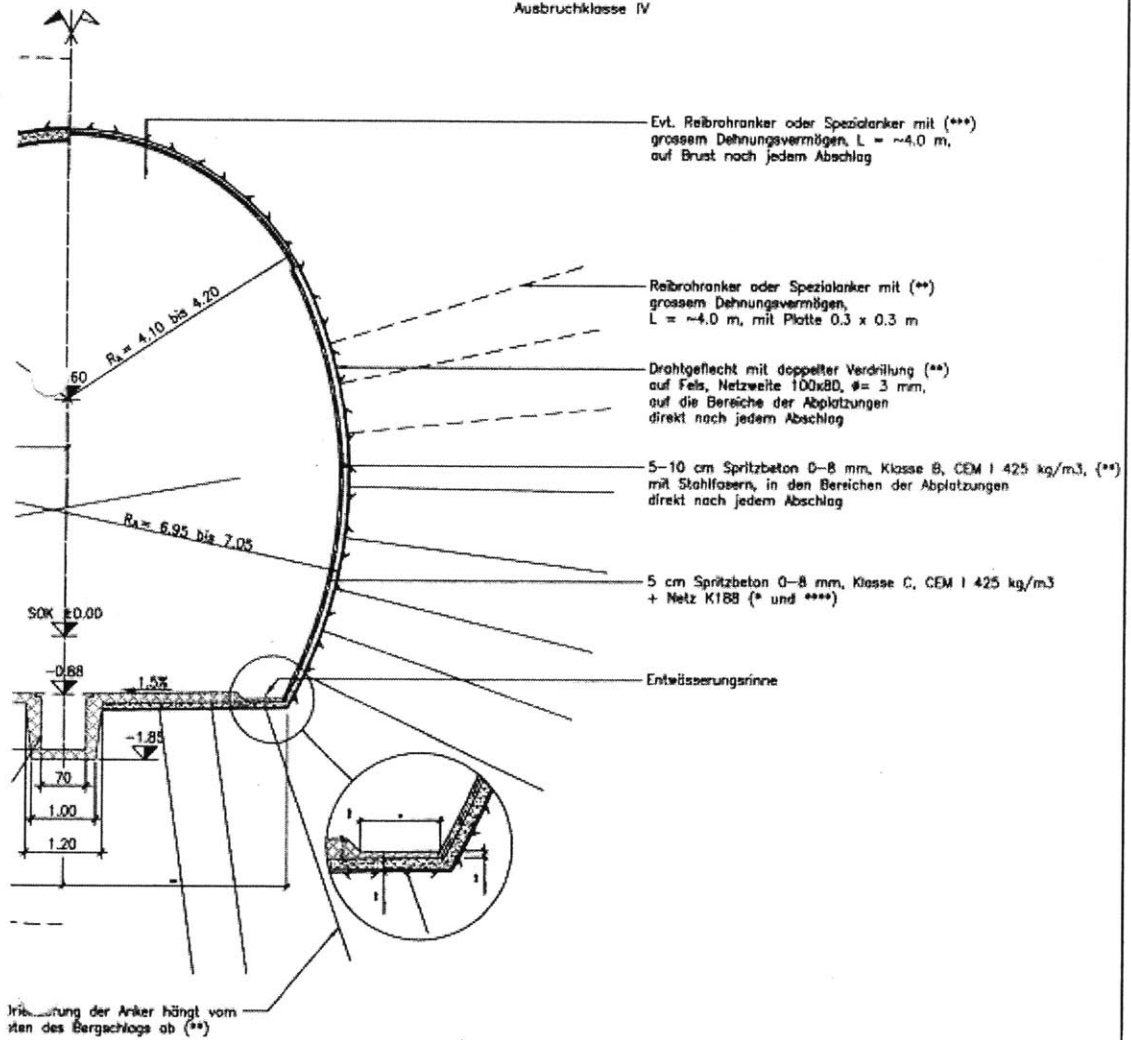

Figure A-6. Drill & Blast Profile ESA4b

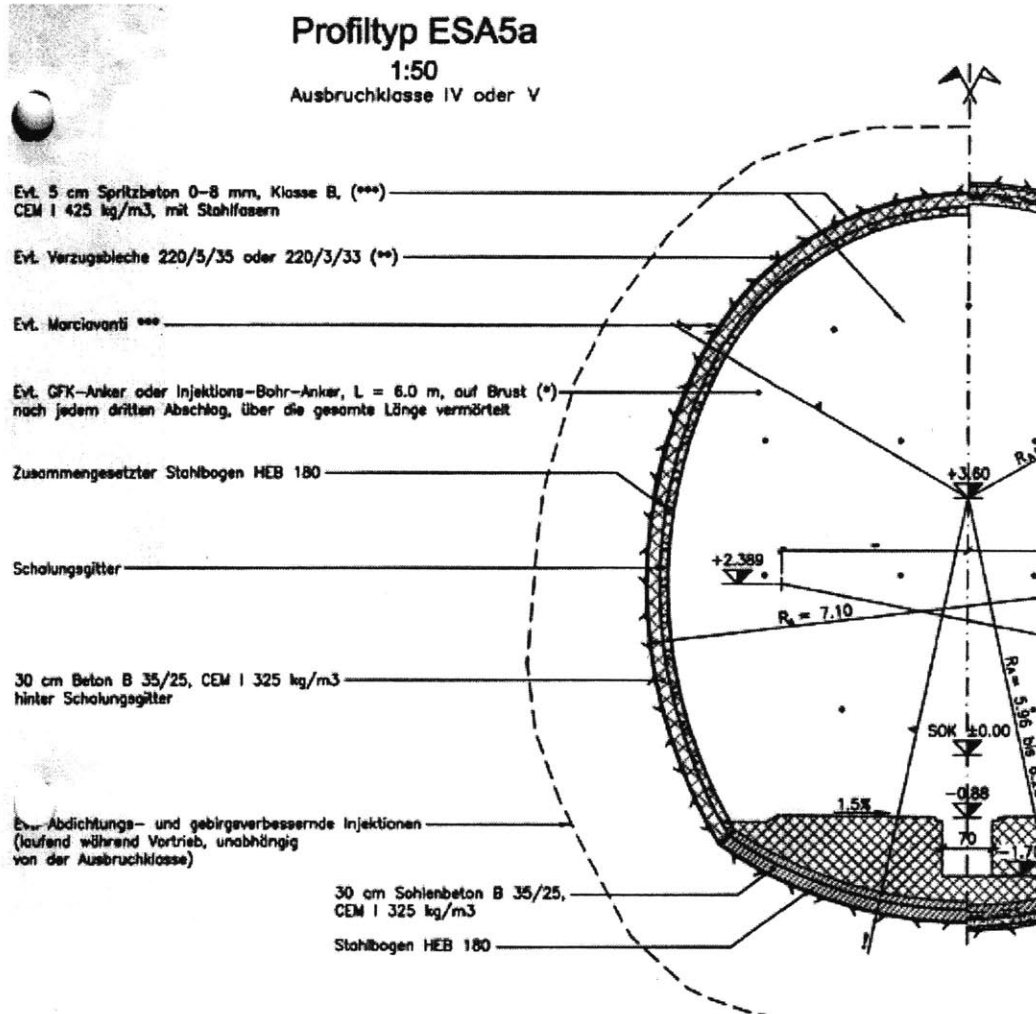

Figure A-7. Drill & Blast Profile ESA5a



**Appendix B**  
**Tunnel Input Data**

## 9 Raron TBM Tunnel

Table B-1 summarizes all the information, which will be used in the simulations.

Figure B-1 shows the MBK “tunnel” window for 9 Raron TBM tunnel. The information in this window is briefly discussed below.

File Edit View Help

Tunnel No 1 (2/16)

< >

Add Insert Delete

Tunnel Name: 9RaronTBM

Start X Position: 780.0

Start Y Position: 800.0

End X Position: 530.0

End Y Position: 600.0

Position on Graph: 0.0

Begin Loc.: 49108.0

End Loc.: 38950.0

Minimum Delay: 100.0

Mode Delay: 100.0

Maximum Delay: 100.0

Repository: 9RaronTBM

Circle Sect.	Area (m2)	Min. m/day	Mode m/day	Max. m/day	Prob. Min.	Prob. Max.
ET1a	69.4	12	24.5	38	0.1	0.1
ET1b	69.4	12	20.2	37	0.1	0.1
ET2	69.4	12	24	35	0.1	0.1
ET3a	69.4	11	22.2	32	0.1	0.1
ET3b	69.4	9	16.7	26	0.1	0.1
ET4a	69.4	4	8.55	13	0.1	0.1

ID	Zone	Min L	Mode L	Max L	P Min	LP Max	Min EP	Mode	Max EP	P Min	P Max	Gen
0	Dum.	0	0	0	0	0	38,850	38,850	38,850	0	0	2
1	Abstr.	2,420	2,755	3,100	0.1	0.1	0	0	0	0	0	1
2	Abstr.	60	165	265	0.1	0.1	0	0	0	0	0	1
3	Abstr.	240	260	280	0.1	0.1	0	0	0	0	0	1
4	Abstr.	850	890	910	0.1	0.1	0	0	0	0	0	1
5	Abstr.	240	260	280	0.1	0.1	0	0	0	0	0	1

Accident	Area (m2)	Min. m/day	Mode m/day	Max. m/day	Prob. Min.	Prob. Max.	Material
Bw2a	80	1	3	3.5	0.1	0.1	0.1 KuTBM
Bw2c	80	0.5	1	1.5	0.1	0.1	0.1 KuTBM
Bw2e	80	4.5	5.7	7.5	0.1	0.1	0.1 KuTBM

Acc. Zone	Accident	Min	Mode	Max	Prob. Min.	Prob. Max.	Type
No 0	Dummy Z.	38,850	-1	42,800	0	0	Position
No 1	Zone Bw.	0	0	100	0.47	0.53	Length
No 2	Zone Bw.	0	0	30	0.47	0.53	Length
No 3	Zone Bw.	0	0	15	0.47	0.53	Length
No 4	Dummy Z.	43,700	-1	45,560	0	0	Position
No 5	Zone Bw.	0	0	100	0.6	0.41	Length

Material	Min3
K1aTBM	2.7
K1TBM	2.7
K2TBM	2.7
KuTBM	2.7

Figure B-1. Tunnel 9 Raron TBM MBK Window

Table B-1. 9 Raron TBM Information Table

Tunnel	Dummy Tunnel	9 Raron TBM Tunnel															
Zone Nb	1	2	3	4	5	6	7	8	9	10	11	12	13	14	15	16	
Zone	Dummy	Altkristallin					Zent Aaregranit	Zent Aaregranit	Zent Aaregranit	Altkristallin	Malm	Dogger Aalenien	Lias	Schuppenzone	Altkristallin	Trias	
END POSITION (m)	38,850	41,605	41,770	42,030	42,910	43,170	43,285	44,225	44,340	46,530	46,790	47,640	48,370	48,650	49,100	49,108	
Meters		2755	165	260	880	260	115	940	115	2190	260	850	730	280	450	8	
K1TBM (t)			30,947					167,024			51,331						
K1aTBM (t)													115,298				
K2TBM (t)																	
KuTBM (t)			596,874			173,737		115,298			432,367t Partly Ku		251,918			88,843	

**Begin Location (m):** 49108, **End Location (m):** 38850.

**Starting Delays (days):** minimum: 300.0, mode: 300.0, maximum: 300.0

**Repository:** Raron TBM

**Cross- sections:** ET1a, ET1b, ET2, ET3a, ET3b, ET4a, ET4b, ET5a and ET5b.

**Difficult cross- sections:** BwszA, BwszC, BwszE.

The area (m<sup>2</sup>) and the advance rates of all the cross- sections are in Table2 in Chapter 3.

**Geologic Zones:** Information about the geologic zones as shown in SIMSUPER is presented in Figure B-2, Figure B-3 and Figure B-4. As can be seen this tunnel has sixteen geologic zones. Two Markov matrices characterize each zone. One is the Markov matrix that characterizes the cross- sections. The cross- section Markov matrices are taken from the original data file of the Loetschberg (It can be seen in Appendix C). The second Markov matrix, which describes the excavation materials, was created based on Table B-1. The calculations and the Markov matrices are presented in the next paragraph.

**Difficult Zones:** The data are shown in Figure B-5<sup>28</sup>. For these zones the excavation material is a deterministic value and therefore a Markov value is not needed.

---

<sup>28</sup> The two tables presented in this figure should be considered as one, since the bottom table is the right part of the top table. They are displayed here separately due to limitations of the page width.

## Calculations and Markov Transition Matrices

- *Zone Nb. 2, 4, 5, 6 Altkristallin, Nb 7 Zent Altkristallin, Nb 9 Zent Aaregranit, Nb 12 Dogger Aalenien, Nb 14 Schuppenzone, Nb 15 Altkristallin and Nb 16 Trias*

From Table B-1 we can see that all the excavated materials are Ku. This means that the possibility of excavating a material suitable for aggregate production in this zone is low. In these cases we will not consider any distribution on the other material types and therefore the resulting excavated materials transition Markov Matrix  $P_{zone2-6} = P_{zone7} = P_{zone9} = P_{zone12} = P_{zone14-16}$  will be the following:

$$P_{zone2} = \begin{matrix} & \begin{matrix} K1ar & K1 & K2 & Ku \end{matrix} \\ \begin{matrix} K1ar \\ K1 \\ K2 \\ Ku \end{matrix} & \begin{pmatrix} 0 & 0 & 0 & 1 \\ 0 & 0 & 0 & 1 \\ 0 & 0 & 0 & 1 \\ 0 & 0 & 1 & 0 \end{pmatrix} \end{matrix}$$

- *Zone Nb.3 Alktristallin and Zone Nb.8 Zentr Aaregranit*

In these zones both K1 and Ku materials will be excavated. The Altkristallin zone is 165m and the average cross-section area is 69.4m<sup>2</sup>, so the total tons excavated will be 165m\*69.4m<sup>2</sup>\*2.7 t/m<sup>3</sup> = 30,917.7tons. In Table B-1 we can see that 30,947tons will be the K1 materials.

The Zentr Aaregranit zone is 940m and the average cross-section area is 69.4m<sup>2</sup>, so the total tons excavated will be 940m\*69.4m<sup>2</sup>\*2.7 t/m<sup>3</sup> = 176,137.2tons. In Table we can see that 167,024tons will be the K1 materials. These calculations show that the percentage of the Ku materials in these zones is extremely low and thus we will not take it into account. The resulting excavated materials transition Markov Matrix  $P_{zone3} = P_{zone8}$  is:

$$P_{zone3} = \begin{matrix} & \begin{matrix} K1ar & K1 & K2 & Ku \end{matrix} \\ \begin{matrix} K1ar \\ K1 \\ K2 \\ Ku \end{matrix} & \begin{pmatrix} 0 & 1 & 0 & 0 \\ 0 & 0 & 0 & 1 \\ 0 & 1 & 0 & 0 \\ 0 & 1 & 0 & 0 \end{pmatrix} \end{matrix}$$

• **Zones Nb. 10 Altkristallin**

As one can see in Table B-1 this zone will produce mainly K2 non alkali- reactive materials with “partly” Ku materials. We have translated this “partly” as a 20% possibility and so the excavated materials Markov transition Matrix  $P_{zone10}$  will be the following:

$$P_{zone10} = \begin{matrix} & \begin{matrix} K1ar & K1 & K2 & Ku \end{matrix} \\ \begin{matrix} K1ar \\ K1 \\ K2 \\ Ku \end{matrix} & \begin{pmatrix} 0 & 0 & 0.8 & 0.2 \\ 0 & 0 & 0.8 & 0.2 \\ 0 & 0 & 0 & 1 \\ 0 & 0 & 1 & 0 \end{pmatrix} \end{matrix}$$

This 20% possibility can be varied in different simulations and the differences in the results can be observed. For this particular zone any variation will not effect the simulations significantly since K2 and of course KU materials will not be used for aggregate production.

• **Zones Nb. 13 Lias**

The information we have on this zone is that both K1ar and Ku materials will be excavated. The zone is 730m and the average cross- section area is 69.4m<sup>2</sup>, so the total tons excavated will be 730m\*69.4m<sup>2</sup>\*2.7 t/m<sup>3</sup>= 136,787.4tons. In Table B-1 we can see that 115,298tons will be the K1ar materials. This means that the percentage of the Ku materials is:

$$\%Ku = \frac{136,787.4 - 115,298}{136,787.4} \approx 0.15 = 15\%$$

So,

$$P_{zone13} = \begin{matrix} & \begin{matrix} K1ar & K1 & K2 & Ku \end{matrix} \\ \begin{matrix} K1ar \\ K1 \\ K2 \\ Ku \end{matrix} & \begin{pmatrix} 0 & 0 & 0 & 1 \\ 0.85 & 0 & 0 & 0.15 \\ 0.85 & 0 & 0 & 0.15 \\ 1 & 0 & 0 & 0 \end{pmatrix} \end{matrix}$$

Zones							
File Options Table							
	Zone 12	Zone 13	Zone 14	Zone 15	Zone 16	Zone 17	Zone 18
Name	Dummy_9RaronTBM	Altkristallin_43_to_	Altkristallin_55	Altkristallin_56a	Altkristallin_56b	Altkristallin_56c	Zentr_AareGranit_57a
Generation mode	2	1	1	1	1	1	1
Min length	--	2420,00	65,00	240,00	850,00	240,00	105,00
Mode length	--	2755,00	165,00	260,00	880,00	260,00	115,00
Max length	--	3100,00	265,00	280,00	910,00	280,00	125,00
Prob. Min length	--	0,10	0,10	0,10	0,10	0,10	0,10
Prob. Max length	--	0,10	0,10	0,10	0,10	0,10	0,10
Min end pos	38850,00	--	--	--	--	--	--
Mode end pos	38850,00	--	--	--	--	--	--
Max end pos	38850,00	--	--	--	--	--	--
Prob. Min pos	0,00	--	--	--	--	--	--
Prob. Max pos	0,00	--	--	--	--	--	--
Ground param. set	13	14	15	16	17	18	19

Figure B-2. Geologic Zones 12-18 of the 9 Raron TBM Tunnel

Zones					
File Options Table					
	Zone 19	Zone 20	Zone 21	Zone 22	Zone 23
Name	Zentr_AareGranit_57b	Zentr_AareGranit_57c	Altkristallin_58&Bal	Malm_60	Dogger_61_to_63
Generation mode	1	1	3	1	1
Min length	900,00	105,00	1360,00	120,00	685,00
Mode length	940,00	115,00	2190,00	260,00	850,00
Max length	980,00	125,00	2940,00	440,00	1005,00
Prob. Min length	0,10	0,10	0,10	0,10	0,10
Prob. Max length	0,10	0,10	0,10	0,10	0,10
Min end pos	--	--	46440,00	--	--
Mode end pos	--	--	--	--	--
Max end pos	--	--	46620,00	--	--
Prob. Min pos	--	--	--	--	--
Prob. Max pos	--	--	--	--	--
Ground param. set	20	21	22	23	24

Figure B-3. Geologic Zones 19-23 of the 9 Raron TBM Tunnel

Zones				
File Options Table				
	Zone 24	Zone 25	Zone 26	Zone 27
Name	Lias_64	Schuppenzone_65_to_6	Altkristallin	Trias
Generation mode	1	3	1	2
Min length	675.00	205.00	400.00	--
Mode length	730.00	280.00	450.00	--
Max length	785.00	355.00	500.00	--
Prob. Min length	0.10	0.10	0.10	--
Prob. Max length	0.10	0.10	0.10	--
Min end pos	--	48630.00	--	49108.00
Mode end pos	--	--	--	49108.00
Max end pos	--	48670.00	--	49108.00
Prob. Min pos	--	--	--	0.00
Prob. Max pos	--	--	--	0.00
Ground param. set	25	26	27	28

Figure B-4. Geologic Zones 24-27 of the 9 Raron TBM Tunnel

	State Name	Generation Mode	Min. Position	Mode Position	Max. Position	Prob Min.	Prob Max.
Row 1	None	Position	38850,00	-1,00	42800,00	0,00	0,00
Row 2	BwszE	Length	---	---	---	---	---
Row 3	BwszA	Length	---	---	---	---	---
Row 4	BwszC	Length	---	---	---	---	---
Row 5	None	Position	43700,00	-1,00	45580,00	0,00	0,00
Row 6	BwszE	Length	---	---	---	---	---
Row 7	BwszC	Length	---	---	---	---	---
Row 8	None	Position	45701,00	-1,00	47950,00	0,00	0,00
Row 9	BwszE	Length	---	---	---	---	---
Row 10	BwszC	Length	---	---	---	---	---
Row 11	BwszC	Length	---	---	---	---	---
Row 12	None	Position	49108,00	49108,00	49108,00	0,00	0,00
Row 13							

	Mean Position	Min. Length	Mode Length	Max. Length	Prob Min.	Prob Max.	Mean Length
Row 1	40825,00	---	---	---	---	---	---
Row 2	---	0,00	0,00	100,00	0,47	0,53	53,00
Row 3	---	0,00	0,00	30,00	0,47	0,53	15,90
Row 4	---	0,00	0,00	15,00	0,47	0,53	7,95
Row 5	44640,00	---	---	---	---	---	---
Row 6	---	0,00	0,00	100,00	0,60	0,40	40,00
Row 7	---	0,00	0,00	15,00	0,60	0,40	6,00
Row 8	46825,50	---	---	---	---	---	---
Row 9	---	0,00	0,00	100,00	0,60	0,40	40,00
Row 10	---	0,00	0,00	30,00	0,60	0,40	12,00
Row 11	---	0,00	0,00	15,00	0,60	0,40	6,00
Row 12	49108,00	---	---	---	---	---	---
Row 13							

Figure B-5. Difficult Zones in 9 Raron TBM Tunnel

## 8 Steg Access TBM Tunnel

Table B-2 summarizes all the information, which will be used in the simulations.

Figure B-6 shows the MBK “tunnel” window. The information in this window is briefly discussed below.

File Edit View Help

Tunnel No 4 (5/16)

< > Add Insert Delete

Tunnel Name: 8\_StegeAccess\_TBM

Start X Position: 700.0

Start Y Position: 200.0

End X Position: 600.0

End Y Position: 400.0

Position on Graph: 41439.0

Begin Loc.: 0.0

End Loc.: 3085.0

Minimum Delay: 750.0

Mode Delay: 750.0

Maximum Delay: 750.0

Responsibility: StegeTBM

Cross Sect.	Area (m <sup>2</sup> )	Min. m/day	Mode m/day	Max. m/day	Prob. Min.	Prob. Max.
ET1a	69.4	13	24.5	38	0.1	0.1
ET1b	69.4	12	20.2	37	0.1	0.1
ET2	69.4	12	24	35	0.1	0.1
ET3a	69.4	11	22.2	32	0.1	0.1
ET3b	69.4	9	18.7	28	0.1	0.1
ET4a	69.4	4	8.56	13	0.1	0.1

ID	Zone	Min L	Mode L	Max L	Min P	Mode P	Max P	Min EP	Mode EP	Max EP	Min P	Max P	Gen.
0	Mal	145	155	165	0.05	0.05	0	0	0	0	0	0	1
1	Dog	30	35	40	0.05	0.05	0	0	0	0	0	0	1
2	Dog	90	100	110	0.05	0.05	0	0	0	0	0	0	1
3	Dog	30	35	40	0.05	0.05	0	0	0	0	0	0	1
4	Dog	30	35	40	0.05	0.05	0	0	0	0	0	0	1
5	Non	20	30	35	0.05	0.05	0	0	0	0	0	0	1

Accident	Area (m <sup>2</sup> )	Min. m/day	Mode m/day	Max. m/day	Prob. Min.	Prob. Max.	Material
DummyAc	80	3	3	3	0.1	0.1	KUTBM

Act. Zone	Accident	Min.	Mode	Max.	Prob. Min.	Prob. Max.	Type
No 0	Dummy Z	1	1	1	0.1	0.1	Length
No 1	Zone Du.	1	1	1	0.1	0.1	Length
No 2	Dummy Z	3,085	3,085	3,085	0	0	Position

Material	l/m <sup>3</sup>
K1aTBM	2.7
K1TBM	2.7
K2TBM	2.7
KUTBM	2.7

Figure B-6. Tunnel 8 Steg Access TBM MBK Window

Table B-2. 8 Steg TBM Information Table

Tunnel	8 Steg Access TBM Tunnel													
Zone Nb	13	12	11	10	9	8	7	6	5	4	3	2	1	
Zone	Altkristallin	BaltsGranod	BaltschGranodiorit	BaltschGranodiorit	BaltsGranod	Sch/zone	Malm	Dogger	Dogger	Dogger	Dogger	Dogger	Malm	
END POSITION (m)	3085= 44523	2,565	2,210	1,440	885	530	505	390	360	325	290	190	155	0= 41,438
Meters	520	355	770	555	355	25	115	30	35	35	100	35	155	
K1TBM (t)						99,533								
K1arTBM (t)														
K2TBM (t)														
KuTBM (t)		67,937	147,273 t Partly Ku	106,300 t Partly Ku	69,832									

**Begin Location (m):** 0.0, **End Location (m):** 3085.

**Starting Delays (days):** minimum: 250.0, mode: 250.0, maximum: 250.0

**Repository:** Steg TBM

**Cross- sections:** ET1a, ET1b, ET2, ET3a, ET3b, ET4a, ET4b, ET5a and ET5b.

**Difficult cross- sections:** Dummy Accident<sup>29</sup>.

The area (m<sup>2</sup>) and the advance rates of all the cross- sections are in Table 2 in Chapter 3.

**Geologic Zones:** Information about the geologic zones as are shown in SIMSUPER is presented in Figure B-7, Figure B-8. As can be seen this tunnel has thirteen geologic zones. Two Markov matrices characterize each zone. One is the Markov matrix that characterizes the cross- sections. The cross-section Markov matrices are taken from the original data file of the Loetschberg file (It can be seen in Appendix C). The second Markov matrix, which relates the excavation materials, was created based on Table B-2. The calculations and the Markov matrices are presented in the next paragraph.

**Difficult Zones:** The data are shown in Figure B-9<sup>25</sup>. For these zones the excavation material is a deterministic value and therefore a Markov value is not needed.

---

<sup>29</sup> When “Dummy Accident” is displayed it means that there is no accident in this zone. We just use it because it is needed for the software.

## Calculations and Markov Transition Matrices

### • *Zones Nb. 1&7 Malm, Zones 2-6 Dogger and Zone 8 Schuppenzone*

From Table B-2 one can see that all the excavated materials are K1. In these case (as explained in “Zone Nb. 4 Malm” in 10 Raron DB Tunnel of Chapter 7) the resulting excavated materials transition Markov Matrix  $\mathbf{P}_{\text{zone2-8}}$  will be the following:

$$\mathbf{P}_{\text{zone2}} = \begin{matrix} & \begin{matrix} \text{K1ar} & \text{K1} & \text{K2} & \text{Ku} \end{matrix} \\ \begin{matrix} \text{K1ar} \\ \text{K1} \\ \text{K2} \\ \text{Ku} \end{matrix} & \begin{pmatrix} 0 & 1 & 0 & 0 \\ 1 & 0 & 0 & 0 \\ 0 & 1 & 0 & 0 \\ 0 & 1 & 0 & 0 \end{pmatrix} \end{matrix}$$

### • *Zone Nb. 9& 12BaltischGarnodiorit and Zone Nb. 13 Altkristallin*

From Table B-2 we can see that all the excavated materials are Ku. This means that the possibility of excavating a suitable for aggregate production material in this zone is low. In these cases we will not consider any distribution for the other material types and therefore the resulting excavated materials transition Markov Matrix  $\mathbf{P}_{\text{zone9,12,13}}$  will be the following:

$$\mathbf{P}_{\text{zone9}} = \begin{matrix} & \begin{matrix} \text{K1ar} & \text{K1} & \text{K2} & \text{Ku} \end{matrix} \\ \begin{matrix} \text{K1ar} \\ \text{K1} \\ \text{K2} \\ \text{Ku} \end{matrix} & \begin{pmatrix} 0 & 0 & 0 & 1 \\ 0 & 0 & 0 & 1 \\ 0 & 0 & 0 & 1 \\ 0 & 0 & 1 & 0 \end{pmatrix} \end{matrix}$$

• *Zone Nb.10 and Zone Nb.11 BaltschGarnodiorit Zentr Aaregranit*

As one can see in Table B-2 these two zones will produce mainly K2 non alkali-reactive materials with “partly” Ku materials. We have translated this “partly” as a 20% possibility and so the excavated materials Markov transition Matrix  $\mathbf{P}_{\text{zone10, 11}}$  will be the following:

$$\mathbf{P}_{\text{zone10}} = \begin{matrix} & \begin{matrix} \text{K1ar} & \text{K1} & \text{K2} & \text{Ku} \end{matrix} \\ \begin{matrix} \text{K1ar} \\ \text{K1} \\ \text{K2} \\ \text{Ku} \end{matrix} & \begin{pmatrix} 0 & 0 & 0.8 & 0.2 \\ 0 & 0 & 0.8 & 0.2 \\ 0 & 0 & 0 & 1 \\ 0 & 0 & 1 & 0 \end{pmatrix} \end{matrix}$$

This 20% possibility can be varied in different simulations and the differences in the results can be observed. For this particular zone any variations will not effect the simulations significantly since K2 and of course KU materials will not be used for aggregate production.

Zones							
File Options Table							
	Zone 30	Zone 31	Zone 32	Zone 33	Zone 34	Zone 35	Zone 36
Name	Malm_Steg_1	Dogger_Steg_2	Dogger_Steg_3	Dogger_Steg_4	Dogger_Steg_5	Dogger_Steg_6	Malm_Steg_7
Generation mode	1	1	1	1	1	1	3
Min length	145,00	30,00	90,00	30,00	30,00	20,00	105,00
Mode length	155,00	35,00	100,00	35,00	35,00	30,00	115,00
Max length	165,00	40,00	110,00	40,00	40,00	35,00	125,00
Prob. Min length	0,05	0,05	0,05	0,05	0,05	0,05	0,05
Prob. Max length	0,05	0,05	0,05	0,05	0,05	0,05	0,05
Min end pos	--	--	--	--	--	--	455,00
Mode end pos	--	--	--	--	--	--	--
Max end pos	--	--	--	--	--	--	535,00
Prob. Min pos	--	--	--	--	--	--	--
Prob. Max pos	--	--	--	--	--	--	--
Ground param. set	34	35	36	37	38	39	40

Figure B-7. Geologic Zones 1-7 of the 8 Steg Access TBM Tunnel

Zones						
File Options Table						
	Zone 37	Zone 38	Zone 39	Zone 40	Zone 41	Zone 42
Name	Schuppenzone_Steg_8	BaltschGranod_Steg_9	BaltschGranod_Steg_9	BlatschGranod_Steg_9	BaltschGranod_Steg_9	Altkristallin_Steg_1
Generation mode	1	1	1	1	1	2
Min length	5,00	300,00	494,00	685,00	300,00	--
Mode length	25,00	355,00	555,00	770,00	355,00	--
Max length	35,00	401,00	627,00	870,00	401,00	--
Prob. Min length	0,05	0,05	0,05	0,05	0,05	--
Prob. Max length	0,05	0,05	0,05	0,05	0,05	--
Min end pos	--	--	--	--	--	3085,00
Mode end pos	--	--	--	--	--	3085,00
Max end pos	--	--	--	--	--	3085,00
Prob. Min pos	--	--	--	--	--	0,00
Prob. Max pos	--	--	--	--	--	0,00
Ground param. set	41	42	43	44	45	46

Figure B-8. Geologic Zones 8-13 of the 8 Steg Access TBM Tunnel

File	Option	Table					
	State Name	Generation Mode	Min. Position	Mode Position	Max. Position	Prob Min.	Prob Max.
Row 1	None	Length	---	---	---	---	---
Row 2	DummyAccident	Length	---	---	---	---	---
Row 3	None	Position	3085,00	3085,00	3085,00	0,00	0,00
Row 4							

File	Option	Table					
	Mean Position	Min. Length	Mode Length	Max. Length	Prob Min.	Prob Max.	Mean Length
Row 1	---	1,00	1,00	1,00	0,10	0,10	1,00
Row 2	---	1,00	1,00	1,00	0,10	0,10	1,00
Row 3	3085,00	---	---	---	---	---	---
Row 4							

Figure B-9. Difficult Zones in 8 Step Access TBM Tunnel

# 11 Steg TBM Tunnel

Table B-3 summarizes all the information, which will be used in the simulations. Figure B-10 shows the MBK “tunnel” window for 11 Steg TBM tunnel. The information in this window is briefly discussed below.

The screenshot displays the MBK software interface for Tunnel 11 StegNW TBM. The window title is "Tunnel No 6 (7/16)". The interface includes a menu bar (File, Edit, View, Help) and a toolbar with "Add", "Insert", and "Delete" buttons. On the left, there are input fields for Tunnel Name, Start X Position, Start Y Position, End X Position, End Y Position, Position on Graph, Begin Loc., End Loc., Minimum Delay, Mode Delay, Maximum Delay, and Repository. The main area contains several data tables and lists, each with "Add", "Delete", "Insert", and "Edit" buttons.

Cross Sect.	Area (m2)	Min. m/day	Mode m/day	Max m/day	Prob. Min.	Prob. Max.
ET1a	69.4	13	24.5	38	0.1	0.1
ET1b	69.4	12	20.2	37	0.1	0.1
ET2	69.4	12	24	35	0.1	0.1
ET3a	69.4	11	22.2	32	0.1	0.1
ET3b	69.4	9	18.7	28	0.1	0.1
ET4a	69.4	4	8.55	13	0.1	0.1

ID	Zone	Min L	Mode L	Max L	Min P	Mode P	Max P	Min EP	Mode EP	Max EP	Min P	Max P	Gen
0	Dum	0	0	0	0	0	0	38,850	38,850	38,850	0	0	2
1	Allkri	40	45	50	0.1	0.1	0	0	0	0	0	0	1
2	Allkri	566	620	675	0.1	0.1	0	0	0	0	0	0	1
3	Allkri	95	110	125	0.1	0.1	0	0	0	0	0	0	1
4	Allkri	100	115	130	0.1	0.1	0	0	0	0	0	0	1
5	Allkri	740	780	340	0.1	0.1	0	0	0	0	0	0	1

Accident	Area (m2)	Min. m/day	Mode m/day	Max m/day	Prob. Min.	Prob. Max.	Material
BwSzA	80	1	3	3.5	0.1	0.1	KuTBM
BwSzC	80	0.5	1	1.5	0.1	0.1	KuTBM
BwSzE	80	4.5	5.7	7.5	0.1	0.1	KuTBM

Acc. Zone	Accident	Min	Mode	Max	Prob. Min.	Prob. Max.	Type
No 0	Dummy Z.	38,850	-1	42,800	0	0	0 Position
No 1	Zone BwS.	0	0	100	0.47	0.53	Length
No 2	Zone BwS.	0	0	30	0.47	0.53	Length
No 3	Zone BwS.	0	0	15	0.47	0.53	Length
No 4	Dummy Z.	44,488	44,488	44,488	0	0	0 Position

Material	bm3
K1aTBM	2.7
K1TBM	2.7
K2TBM	2.7
KuTBM	2.7

Figure B-10. Tunnel 11 StegNW TBM MBK Window

Table B-3. 11 StegNW TBM Information Table

Tunnel	Dummy	11 StegNW_TBM Tunnel																		
Zone Nb	0	1	2	3	4	5	6	7	8	9	10	11	12	13	14	15	16	17	18	19
Zone		Altkristallin																Zentr_Aaregranit		
END POSITION (m)	38,850	38,895	39,515	39,625	39,740	40,030	40,085	40,395	41,020	41,390	41,480	41,555	41,605	41,770	42,030	42,910	43,170	43,305	44,200	44,488
Meters		45	620	110	115	290	55	310	625	370	90	75	50	165	260	880	260	135	895	288
K1TBM (t)														29,997					154,154	
K1arTBM (t)																				
K2TBM (t)																				
KuTBM (t)		590,564												1,580	49,758	168,410	49,758	25,838	17,129	

**Begin Location (m):** 44488, **End Location (m):** 38850.

**Starting Delays (days):** minimum: 450.0, mode: 450.0, maximum: 450.0

**Repository:** Steg TBM

**Cross- sections:** ET1a, ET1b, ET2, ET3a, ET3b, ET4a, ET4b, ET5a and ET5b.

**Difficult cross- sections:** BwszA, BwszC, BwszE.

The area (m<sup>2</sup>) and the advance rates of all the cross- sections are in Table 2 in Chapter 3.

**Geologic Zones:** Information about the geologic zones as are shown in SIMSUPER is presented in Figure B-11, Figure B-12 and Figure B-13. As can be seen this tunnel has nineteen geologic zones. Two Markov matrices characterize each zone. One is the Markov matrix that characterizes the cross- sections. The cross-section Markov matrices are taken from the original data file of the Loetschberg file (It can be seen in Appendix C). The second Markov matrix, which relates the excavation materials, was created based on Table B-3. The calculations and the Markov matrices are presented in the next paragraph.

**Difficult Zones:** The data are shown in Figure B-14<sup>25</sup> For these zones the excavation material is a deterministic value and therefore a Markov value is not needed.

## Calculations and Markov Transition Matrices

### • Zones Nb. 1- 12 & 14-16 Altkristallin and Zones 17 & 19 Zent.Altkristallin

From Table B-3 we can see that all the excavated materials are Ku. This means that the possibility of excavating a suitable for aggregate production material in this zone is low. In these cases we will not consider any distribution of the other material types and therefore the resulting excavated materials transition Markov Matrix  $\mathbf{P}_{\text{zone1-12}} = \mathbf{P}_{\text{zone14-16}} = \mathbf{P}_{\text{zone17}} = \mathbf{P}_{\text{zone19}}$  will be the following:

$$\mathbf{P}_{\text{zone1}} = \begin{matrix} & \begin{matrix} \text{K1ar} & \text{K1} & \text{K2} & \text{Ku} \end{matrix} \\ \begin{matrix} \text{K1ar} \\ \text{K1} \\ \text{K2} \\ \text{Ku} \end{matrix} & \begin{pmatrix} 0 & 0 & 0 & 1 \\ 0 & 0 & 0 & 1 \\ 0 & 0 & 0 & 1 \\ 0 & 0 & 1 & 0 \end{pmatrix} \end{matrix}$$

### • Zone Nb.13 Alkristallin

In this zone both K1 and Ku materials will be excavated. The information we have shows that 29,997tons of K1 materials and 1,580tons of Ku will be excavated. So the percentage of Ku materials will be:

$$\% \text{Ku} = \frac{31,577 - 29,997}{31,577} \approx 0.05 = 5\%$$

So the resulting excavated materials transition Markov Matrix  $\mathbf{P}_{\text{zone13}}$  is:

$$\mathbf{P}_{\text{zone13}} = \begin{matrix} & \begin{matrix} \text{K1ar} & \text{K1} & \text{K2} & \text{Ku} \end{matrix} \\ \begin{matrix} \text{K1ar} \\ \text{K1} \\ \text{K2} \\ \text{Ku} \end{matrix} & \begin{pmatrix} 0 & 0.95 & 0 & 0.05 \\ 0 & 0 & 0 & 1 \\ 0 & 0.95 & 0 & 0.05 \\ 0 & 1 & 0 & 0 \end{pmatrix} \end{matrix}$$

• *Zone Nb.8 Zentr Aaregranit*

In this zone both K1 and Ku materials will be excavated. The information we have shows that 154,154tons of K1 materials and 17,129tons of Ku will be excavated. So the percentage of Ku materials will be:

$$\%Ku = \frac{171,283 - 154,154}{171,283} \approx 0.1 = 10\%$$

So the resulting excavated materials transition Markov Matrix  $\mathbf{P}_{\text{zone8}}$  is:

$$\mathbf{P}_{\text{zone8}} = \begin{matrix} & \begin{matrix} \text{K1ar} & \text{K1} & \text{K2} & \text{Ku} \end{matrix} \\ \begin{matrix} \text{K1ar} \\ \text{K1} \\ \text{K2} \\ \text{Ku} \end{matrix} & \begin{pmatrix} 0 & 0.9 & 0 & 0.1 \\ 0 & 0 & 0 & 1 \\ 0 & 0.9 & 0 & 0.1 \\ 0 & 1 & 0 & 0 \end{pmatrix} \end{matrix}$$

Zones							
File Options Table							
	Zone 44	Zone 45	Zone 46	Zone 47	Zone 48	Zone 49	Zone 50
Name	Dummy_11_Step	Altkristallin_43_25	Altkristallin_44_24	Altkristallin_45_23	Altkristallin_46_22	Altkristallin_47_21	Altkristallin_48_20
Generation mode	2	1	1	1	1	1	1
Min length	--	40,00	566,00	95,00	100,00	240,00	45,00
Mode length	--	45,00	620,00	110,00	115,00	290,00	55,00
Max length	--	50,00	675,00	125,00	130,00	340,00	65,00
Prob. Min length	--	0,10	0,10	0,10	0,10	0,10	0,10
Prob. Max length	--	0,10	0,10	0,10	0,10	0,10	0,10
Min end pos	38850,00	--	--	--	--	--	--
Mode end pos	38850,00	--	--	--	--	--	--
Max end pos	38850,00	--	--	--	--	--	--
Prob. Min pos	0,00	--	--	--	--	--	--
Prob. Max pos	0,00	--	--	--	--	--	--
Ground param. set	50	51	52	53	54	55	56

Figure B-11. Geologic Zones 1-7 of the 11 Step NW TBM Tunnel

Zones							
File Options Table							
	Zone 51	Zone 52	Zone 53	Zone 54	Zone 55	Zone 56	Zone 57
Name	Altkristallin_49_19	Altkristallin_50_18	Altkristallin_51_17	Altkristallin_52_16	Altkristallin_53_15	Altkristallin_54_14	Altkristallin_55_13
Generation mode	1	1	1	1	1	1	1
Min length	270,00	565,00	330,00	70,00	60,00	40,00	65,00
Mode length	310,00	625,00	370,00	90,00	75,00	50,00	165,00
Max length	350,00	685,00	410,00	120,00	90,00	60,00	256,00
Prob. Min length	0,10	0,10	0,10	0,10	0,10	0,10	0,10
Prob. Max length	0,10	0,10	0,10	0,10	0,10	0,10	0,10
Min end pos	--	--	--	--	--	--	--
Mode end pos	--	--	--	--	--	--	--
Max end pos	--	--	--	--	--	--	--
Prob. Min pos	--	--	--	--	--	--	--
Prob. Max pos	--	--	--	--	--	--	--
Ground param. set	57	58	59	60	61	62	63

Figure B-12. Geologic Zones 8-14 of the 11 Step NW TBM Tunnel

Zones						
File	Options	Table				
	Zone 58	Zone 59	Zone 60	Zone 61	Zone 62	Zone 63
Name	Altkristallin_56_12c	Altkristallin_56_12b	Altkristallin_56_12a	Zentr_AareGranit_57	Zentr_AareGranit_57	Zentr_AareGranit_57
Generation mode	1	1	1	1	1	3
Min length	237,64	804,32	237,64	112,00	743,00	112,00
Mode length	260,00	880,00	260,00	135,00	895,00	288,00
Max length	282,36	955,68	282,36	170,00	1119,00	170,00
Prob. Min length	0,10	0,10	0,10	0,10	0,10	0,10
Prob. Max length	0,10	0,10	0,10	0,10	0,10	0,10
Min end pos	---	---	---	---	---	44488,00
Mode end pos	---	---	---	---	---	---
Max end pos	---	---	---	---	---	44488,00
Prob. Min pos	---	---	---	---	---	---
Prob. Max pos	---	---	---	---	---	---
Ground param. set	64	65	66	67	68	69

Figure B-13. Geologic Zones 15-20 of the 11 Steg NW TBM Tunnel

Semi Deterministic Values, Set: 70 - Parameter: 11_StegNW_TBM_Accident (ref. Area)							
File	Option	Table					
	State Name	Generation Mode	Min. Position	Mode Position	Max. Position	Prob Min.	Prob Max.
Row 1	None	Position	38850,00	-1,00	42800,00	0,00	0,00
Row 2	BvSzE	Length	---	---	---	---	---
Row 3	BvSzA	Length	---	---	---	---	---
Row 4	BvSzL	Length	---	---	---	---	---
Row 5	None	Position	44488,00	44488,00	44488,00	0,00	0,00
Row 6							

Semi Deterministic Values, Set: 70 - Parameter: 11_StegNW_TBM_Accident (ref. Area)							
File	Option	Table					
	Mean Position	Min. Length	Mode Length	Max. Length	Prob Min.	Prob Max.	Mean Length
Row 1	40825,00	---	---	---	---	---	---
Row 2	---	0,00	0,00	100,00	0,47	0,53	53,00
Row 3	---	0,00	0,00	30,00	0,47	0,53	15,00
Row 4	---	0,00	0,00	15,00	0,47	0,53	7,95
Row 5	44488,00	---	---	---	---	---	---
Row 6							

Figure B-14. Difficult Zones in 11 Steg NW TBM Tunnel

## 6 Ferden SE and 7 Ferden SW Drill & Blast Tunnels

Table B-4 summarizes all the information, which will be used in the simulations. Figures B-15 and B-16 show the MBK “tunnel” window for 6 Ferden SE and 7 Ferden SW Drill & Blast tunnels. The information in this window is briefly discussed below.

File Edit View Help

Tunnel No 0 (B/16)

< > Add Insert Delete

Tunnel Name: 6\_FerdenSE\_DB

Start X Position: 470.0

Start Y Position: 600.0

End X Position: 530.0

End Y Position: 600.0

Position on Graph: 0.0

Begin Loc.: 37245.0

End Loc.: 38850.0

Minimum Delay: 540.0

Mode Delay: 554.0

Maximum Delay: 582.0

Repository: FerdenDB

Cross Sect.	Area (m2)	Min. m/day	Mode m/day	Max. m/day	Prob. Min.	Prob. Max.
ESx1a	64.59	7.5	8.45	9.5	0.1	0.1
ESx2a	64.59	7	7.5	9	0.1	0.1
ESx2b	64.59	4	5.35	6.8	0.1	0.1
ESx3a	64.59	5.5	6.8	7.5	0.1	0.1
ESx3b	66.28	4	5.5	6	0.1	0.1
ESx4a	67	7	7.7	4	0.1	0.1

ID	Zone	Min L	Mode L	Max L	P	Min LP	Max LP	Min EP	Mode EP	Max EP	P	Max	Gen
0	Dum.	0	0	0	0	0	37,245	37,245	37,245	0	0	0	2
1	Phyll.	1,541	1,605	1,661	0.1	0.1	38,850	0	38,850	0	0	0	3

Accident	Area (m2)	Min. m/day	Mode m/day	Max. m/day	Prob. Min.	Prob. Max.	Material
BWSZC	80	0.5	1	1.5	0.1	0.1	KuDB
BWSZE	80	4.5	5.7	7.5	0.1	0.1	KuDB
BWSZA	80	1	3	3.5	0.1	0.1	KuDB

Acc. Zone	Accident	Min	Mode	Max	Prob. Min	Prob. Max	Type
No 0	Dummy Z.	37,245	-1	38,700	0	0	Position
No 1	Zone BWS	0	0	100	0.73	0.27	Length
No 2	Zone BWS	0	0	30	0.73	0.27	Length
No 3	Zone BWS	0	0	15	0.73	0.27	Length
No 4	Dummy Z.	38,850	38,850	38,850	0	0	Position

Material	tn3
K1arDB	2.7
K1DB	2.7
K2DB	2.7
KuDB	2.7

Figure B-15. Tunnel 6 Ferden SE Drill & Blast MBK Window

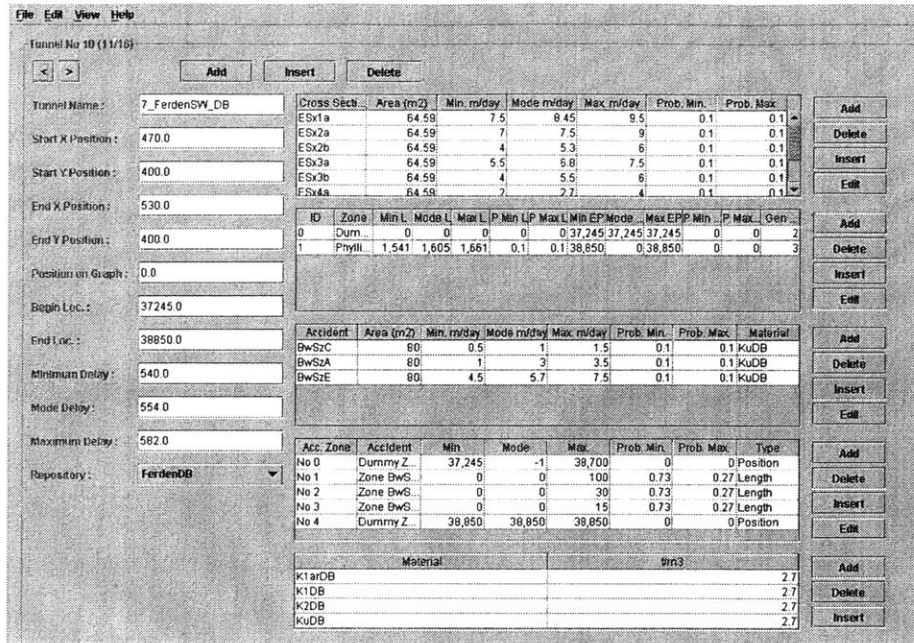

Figure B-16 Tunnel 7 Ferden SW Drill & Blast MBK Window

Table B-4. 6 Ferden SE and 7 Ferden SW Drill & Blast Tunnels Information Table

Tunnel	Dummy	6 Ferden SE and 7 Ferden SW Drill & Blast Tunnels
Zone Nb	0	1
Zone		Phyllit Feldumbach
END POSITION (m)	37,245	38,850
Meters		1,605
K1DB (t)		
K1arDB (t)		
K2DB (t)		
KuDB (t)		500,640

**Begin Location (m):** 37245, **End Location (m):** 38850.

**Starting Delays (days):** minimum: 540.0, mode: 554.0, maximum: 582.0

**Repository:** Ferden DB

**Cross- sections:** ESx1a, ESx2a, ESx2b, ESx3a, ESx3b, ESx4a, ESx5a, ESx6a and ESx6b.

**Difficult cross- sections:** BwszA, BwszC, BwszE.

The area (m<sup>2</sup>) and the advance rates of all the cross- sections are shown in Table 2 in Chapter 3.

**Geologic Zones:** As can be seen both tunnels have one geologic zone. Information about this zone as shown in SIMSUPER is presented in Figure B-17. Two Markov matrices characterize the zone. One is the Markov matrix that characterizes the cross- sections. The cross-section Markov matrix is taken from the original data file of the Loetschberg file (It can be seen in Appendix C). The second Markov matrix, which relates the excavation materials, was created based on Table B-4. The Markov matrix is presented in the next paragraph.

**Difficult Zones:** The data are shown in Figure B-18<sup>25</sup>. For these zones the excavation material is a deterministic value and therefore a Markov value is not needed.

### Calculations and Markov Transition Matrices

#### • *Zone Nb. 1 Phyllit\_Faldumbach*

From Table B-4 we can see that all the excavated materials are Ku. So the resulting excavated materials transition Markov Matrix  $\mathbf{P}_{zone1}$  will be the following:

$$\mathbf{P}_{zone1} = \begin{matrix} & \begin{matrix} \text{K1ar} & \text{K1} & \text{K2} & \text{Ku} \end{matrix} \\ \begin{matrix} \text{K1ar} \\ \text{K1} \\ \text{K2} \\ \text{Ku} \end{matrix} & \begin{pmatrix} 0 & 0 & 0 & 1 \\ 0 & 0 & 0 & 1 \\ 0 & 0 & 0 & 1 \\ 0 & 0 & 1 & 0 \end{pmatrix} \end{matrix}$$

	Zone 65	Zone 66
Name	Dummy_6_SE	Phyllit_Faldumbach_4
Generation mode	2	3
Min length	--	1541,00
Mode length	--	1605,00
Max length	--	1661,00
Prob. Min length	--	0,10
Prob. Max length	--	0,10
Min end pos	37245,00	38850,00
Mode end pos	37245,00	--
Max end pos	37245,00	38850,00
Prob. Min pos	0,00	--
Prob. Max pos	0,00	--
Ground param. set	73	74

Figure B-17. Geologic Zones of the 6 Ferden SE and 7 Ferden SW Drill & Blast Tunnels

State Name	Generation Mode	Min. Position	Mode Position	Max. Position	Prob Min.	Prob Max.	
Row 1	None	Position	37245,00	-1,00	38700,00	0,00	0,00
Row 2	BuSzE	Length	---	---	---	---	---
Row 3	BuSzA	Length	---	---	---	---	---
Row 4	BuSzC	Length	---	---	---	---	---
Row 5	None	Position	38850,00	38850,00	38850,00	0,00	0,00
Row 6							

Mean Position	Min. Length	Mode Length	Max. Length	Prob Min.	Prob Max.	Mean Length	
Row 1	37972,50	---	---	---	---	---	
Row 2	---	0,00	0,00	100,00	0,73	0,27	27,00
Row 3	---	0,00	0,00	30,00	0,73	0,27	8,10
Row 4	---	0,00	0,00	15,00	0,73	0,27	4,05
Row 5	38850,00	---	---	---	---	---	
Row 6							

Figure B-18. Difficult Zones in 6 Ferden SE and 7 Ferden SW Drill & Blast Tunnels

## 5 Ferden NW and 4 Ferden NE Drill & Blast Tunnels

Table B-5 summarizes all the information, which will be used in the simulations. Figures B-19 and B-20 show the MBK “tunnel” window for 5 Ferden NW and 4 Ferden NE Drill & Blast tunnels. The information in this window is briefly discussed below.

File Edit View Help

Tunnel No 12 (13/16)

< > Add Insert Delete

Tunnel Name: 5\_FerdenNW\_DB

Start X Position: 450.0

Start Y Position: 400.0

End X Position: 300.0

End Y Position: 400.0

Position on Graph: 0.0

Begin Loc.: 37245.0

End Loc.: 29700.0

Minimum Delay: 200.0

Mode Delay: 200.0

Maximum Delay: 200.0

Repository: FerdenDB

Cross Sect.	Area (m <sup>2</sup> )	Min. m/day	Mode m/day	Max. m/day	Prob. Min.	Prob. Max.
ES3a	65.15	3.5	7	7.5	0.1	0.1
ES3b	66.95	3.5	5.7	6	0.1	0.1
ES4a	70	2.5	2.8	4.5	0.1	0.1
ES5a	79.23	1.5	1.9	2.6	0.1	0.1
ES6a	77.94	1	1.2	2	0.1	0.1
ES6b	79.23	0.8	1	1.5	0.1	0.1

ID	Zone	Min L	Mode L	Max L	P Min	P Max	Min EP	Mode EP	Max EP	P Min	P Max	Gen
0	Dum	0	0	0	0	0	0.29700	29700	29700	0	0	2
1	Alk	964.8	1,005	1,040	0.1	0.1	0	0	0	0	0	1
2	Gast	4.65	4.845	5.01	0.1	0.1	0	0	0	0	0	1
3	Ran	1.06	1,110	1,040	0.1	0.1	0	0	0	0	0	1
4	Jung	388.8	405	419	0.1	0.1	0	0	0	0	0	1
5	Alkri	1.72	1.80	1.86	0.1	0.1	37.245	37.245	37.245	0	0	2

Accident	Area (m <sup>2</sup> )	Min. m/day	Mode m/day	Max. m/day	Prob. Min.	Prob. Max.	Material
BwSZA	80	1	3	3.5	0.1	0.1	0.1 KuDB
BwSzC	80	0.5	1	1.5	0.1	0.1	0.1 KuDB
BwSzE	80	4.5	5.7	7.5	0.1	0.1	0.1 KuDB

Acc. Zone	Accident	Min.	Mode	Max	Prob. Min.	Prob. Max.	Type
No 0	Dummy Z.	29,700	-1	34,050	0	0	0 Position
No 1	Zone BwS	0	0	30	0.6	0.6	0.4 Length
No 2	Zone BwS	0	0	15	0.6	0.6	0.4 Length
No 3	Dummy Z.	37,245	37,245	37,245	0	0	0 Position

Material	lim3
K1arDB	27
K1DB	27
K2DB	27
KuDB	27

Figure B-19. Tunnel 5 Ferden NW Drill & Blast MBK Window

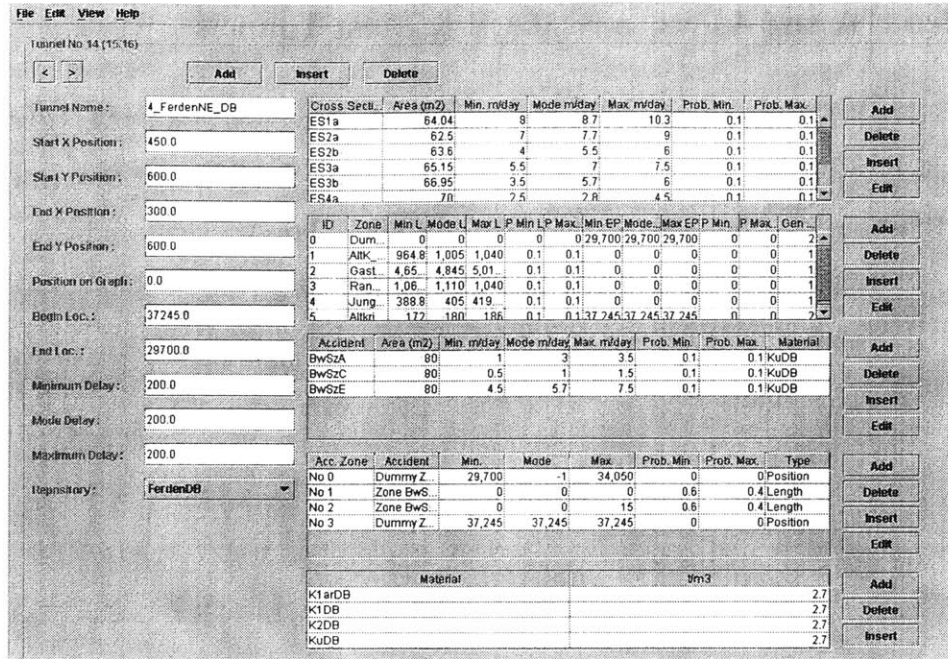

Figure B-20. Tunnel 4 Ferden NE Drill & Blast MBK Window

Table B-5. 5 Ferden NW and 4 Ferden NE Drill & Blast Tunnels Information Table

Tunnel	Dummy	5 Ferden NW and 4 Ferden NE Drill & Blast Tunnels				
Zone Nb	0	1	2	3	4	5
Zone		Alt/lin-Gastern Granit	Gastern Granit	Randbereich	Jungfrau keil	Alt/lin
END POSITION (m)	29,700	30,705	35,550	36,650	37,065	37,245
Meters		1005	4845	1110	405	180
K1DB (t)						
K1arDB (t)		83.00%	75.00%	64.00%		50.00%
K2DB (t)						
KuDB (t)		17.00%	25.00%	36.00%	100.00%	50.00%

**Begin Location (m):** 29700, **End Location (m):** 37245.

**Starting Delays (days):** minimum: 200.0, mode: 200.0, maximum: 200.0

**Repository:** Ferden DB

**Cross- sections:** ES1a, ES2a, ES2b, ES3a, ES3b, ES4a, ES5a, ES6a and ES6b.

**Difficult cross- sections:** BwszA, BwszC.

The area (m<sup>2</sup>) and the advance rates of all the cross- sections are in Table 2 in Chapter 3.

**Geologic Zones:** As can be seen both tunnels have five geologic zones. Information about these zones as are shown in SIMSUPER is presented in Figure B-21. Two Markov matrices characterize each zone. One is the Markov matrix that characterizes the cross- sections. The cross-section Markov matrices are taken from the original data file of the Loetschberg file (It can be seen in Appendix C). The second set of Markov matrices, which relates to the excavation materials, were created based on Table B-5. These Markov matrices are presented in the next paragraph.

**Difficult Zones:** The data are shown in Figure B-22<sup>25</sup>. For these zones the excavation material is a deterministic value and therefore a Markov value is not needed.

## Calculations and Markov Transition Matrices

### • *Zone Nb. 1 Alkristallin Gastern Granit*

The information from Table B-5 shows that 83% of K1ar materials and 17% of Ku will be excavated for both tunnels. So the resulting excavated materials transition Markov Matrix  $P_{zone1}$  is:

$$P_{zone1} = \begin{matrix} & \begin{matrix} K1ar & K1 & K2 & Ku \end{matrix} \\ \begin{matrix} K1ar \\ K1 \\ K2 \\ Ku \end{matrix} & \begin{pmatrix} 0 & 0 & 0 & 1 \\ 0.83 & 0 & 0 & 0.17 \\ 0.83 & 0 & 0 & 0.17 \\ 1 & 0 & 0 & 0 \end{pmatrix} \end{matrix}$$

• **Zone Nb. 2 Gastern Granit**

The information we from Table B-5 show that 75% of K1ar materials and 25% of Ku will be excavated for both tunnels. So the resulting excavated materials transition Markov Matrix  $\mathbf{P}_{\text{zone2}}$  is:

$$\mathbf{P}_{\text{zone2}} = \begin{matrix} & \begin{matrix} \text{K1ar} & \text{K1} & \text{K2} & \text{Ku} \end{matrix} \\ \begin{matrix} \text{K1ar} \\ \text{K1} \\ \text{K2} \\ \text{Ku} \end{matrix} & \begin{pmatrix} 0 & 0 & 0 & 1 \\ 0.75 & 0 & 0 & 0.25 \\ 0.75 & 0 & 0 & 0.25 \\ 1 & 0 & 0 & 0 \end{pmatrix} \end{matrix}$$

• **Zone Nb. 3 Randbereich**

The information we from Table B-5 show that 64% of K1ar materials and 36% of Ku will be excavated for both tunnels. So the resulting excavated materials transition Markov Matrix  $\mathbf{P}_{\text{zone3}}$  is:

$$\mathbf{P}_{\text{zone3}} = \begin{matrix} & \begin{matrix} \text{K1ar} & \text{K1} & \text{K2} & \text{Ku} \end{matrix} \\ \begin{matrix} \text{K1ar} \\ \text{K1} \\ \text{K2} \\ \text{Ku} \end{matrix} & \begin{pmatrix} 0 & 0 & 0 & 1 \\ 0.64 & 0 & 0 & 0.36 \\ 0.64 & 0 & 0 & 0.36 \\ 1 & 0 & 0 & 0 \end{pmatrix} \end{matrix}$$

• **Zones Nb.4 Jungfraikeil**

The information we have from Table B-5 show that only Ku materials will be excavated for both tunnels. So the resulting excavated materials transition Markov matrix  $\mathbf{P}_{\text{zone4}}$  is:

$$\mathbf{P}_{\text{zone4}} = \begin{matrix} & \begin{matrix} \text{K1ar} & \text{K1} & \text{K2} & \text{Ku} \end{matrix} \\ \begin{matrix} \text{K1ar} \\ \text{K1} \\ \text{K2} \\ \text{Ku} \end{matrix} & \begin{pmatrix} 0 & 0 & 0 & 1 \\ 0 & 0 & 0 & 1 \\ 0 & 0 & 0 & 1 \\ 0 & 0 & 1 & 0 \end{pmatrix} \end{matrix}$$

• *Zone Nb.5 Alkristallin*

The information we from Table B-5 show that 50% of K1ar materials and 50% of Ku will be excavated for both tunnels. So the resulting excavated materials transition Markov

Matrix  $\mathbf{P}_{\text{zone5}}$  is:

$$\mathbf{P}_{\text{zone5}} = \begin{matrix} & \begin{matrix} \text{K1ar} & \text{K1} & \text{K2} & \text{Ku} \end{matrix} \\ \begin{matrix} \text{K1ar} \\ \text{K1} \\ \text{K2} \\ \text{Ku} \end{matrix} & \begin{pmatrix} 0 & 0 & 0 & 1 \\ 0.5 & 0 & 0 & 0.5 \\ 0.5 & 0 & 0 & 0.5 \\ 1 & 0 & 0 & 0 \end{pmatrix} \end{matrix}$$

Zones						
File Options Table						
	Zone 78	Zone 79	Zone 80	Zone 81	Zone 82	Zone 83
Name	Dummy_4_FNE	AltK_Gastern_40	Gastern_Granit_39	Randbereich_38	Jungfraukeil_JFK_37	Altkristallin_31
Generation mode	2	1	1	1	1	2
Min length	--	964.80	4651.20	1066.60	388.80	--
Mode length	--	1005.00	4845.00	1110.00	405.00	--
Max length	--	1040.00	5014.50	1040.00	419.17	--
Prob. Min length	--	0.10	0.10	0.10	0.10	--
Prob. Max length	--	0.10	0.10	0.10	0.10	--
Min end pos	29700.00	--	--	--	--	37245.00
Mode end pos	29700.00	--	--	--	--	37245.00
Max end pos	29700.00	--	--	--	--	37245.00
Prob. Min pos	0.00	--	--	--	--	0.00
Prob. Max pos	0.00	--	--	--	--	0.00
Ground param. set	92	93	94	95	96	97

Figure B-21. Geologic Zones of the 5 Ferden NW and 4 Ferden NE Drill & Blast Tunnels

Semi Deterministic Values, Set: 89 - Parameter: 5_FerdenNW_DB_Accident (ref. Area)							
File Option Table							
	State Name	Generation Mode	Min. Position	Mode Position	Max. Position	Prob Min.	Prob Max.
Row 1	None	Position	29700.00	-1.00	34050.00	0.00	0.00
Row 2	Bu5a	Length	--	--	--	--	--
Row 3	Bu5c	Length	--	--	--	--	--
Row 4	None	Position	37245.00	37245.00	37245.00	0.00	0.00
Row 5							

Semi Deterministic Values, Set: 89 - Parameter: 5_FerdenNW_DB_Accident (ref. Area)							
File Option Table							
	Mean Position	Min. Length	Mode Length	Max. Length	Prob Min.	Prob Max.	Mean Length
Row 1	31875.00	--	--	--	--	--	--
Row 2	--	0.00	0.00	30.00	0.60	0.40	12.00
Row 3	--	0.00	0.00	15.00	0.60	0.40	5.00
Row 4	37245.00	--	--	--	--	--	--
Row 5							

Figure B-22. Difficult Zones of the 5 Ferden NW and 4 Ferden NE Drill & Blast Tunnels

## **Appendix C**

### **Cross- Section Markov Transition Matrices**

Appendix C presents the Markov matrices for all the different cross-sections and the Markov mean lengths for tunnel 10 Raron DB that have been taken from the original Loetschberg data file, prepared by EPFL. Similar information for the rest of the tunnel networks can be seen in the original Loetschberg data file.

Transition Matrix 2, parameter: 10RaronDB\_XSection (1)

	Esa1	Esa2	Esa3a	Esa3b	Esa4a	Esa4b	Esa5ak4	Esa5ak5	Esa5b5
Esa1	0.00	0.47	0.25	0.12	0.06	0.04	0.03	0.02	0.01
Esa2	0.29	0.00	0.29	0.18	0.09	0.06	0.04	0.03	0.02
Esa3a	0.14	0.26	0.00	0.26	0.14	0.08	0.05	0.04	0.03
Esa3b	0.08	0.13	0.25	0.00	0.25	0.13	0.08	0.05	0.04
Esa4a	0.06	0.08	0.12	0.24	0.00	0.24	0.12	0.08	0.06
Esa4b	0.04	0.05	0.08	0.13	0.25	0.00	0.25	0.13	0.08
Esa5ak4	0.03	0.04	0.05	0.08	0.14	0.26	0.00	0.26	0.14
Esa5ak5	0.02	0.03	0.04	0.06	0.09	0.18	0.29	0.00	0.29
Esa5b5	0.01	0.02	0.03	0.04	0.06	0.12	0.25	0.47	0.00

Start proba: <

Figure C-1. Cross-Section Markov Matrix for 10 Raron DB Tunnel.

Transition Matrix 14, parameter: 9RaronTBM\_XSection (1)

	ET1a	ET1b	ET2	ET3a	ET3b	ET4a	ET4b	ET5a	ET5b
ET1a	0.00	0.47	0.25	0.12	0.06	0.04	0.03	0.02	0.01
ET1b	0.29	0.00	0.29	0.18	0.09	0.06	0.04	0.03	0.02
ET2	0.14	0.26	0.00	0.26	0.14	0.08	0.05	0.04	0.03
ET3a	0.08	0.13	0.25	0.00	0.25	0.13	0.08	0.05	0.04
ET3b	0.06	0.08	0.12	0.24	0.00	0.24	0.12	0.08	0.06
ET4a	0.04	0.05	0.08	0.13	0.25	0.00	0.25	0.13	0.08
ET4b	0.03	0.04	0.05	0.08	0.14	0.26	0.00	0.26	0.14
ET5a	0.02	0.03	0.04	0.06	0.09	0.18	0.29	0.00	0.29
ET5b	0.01	0.02	0.03	0.04	0.06	0.12	0.25	0.47	0.00

Start proba: <

Figure C-2. Cross-Section Markov Matrix for 9 Raron, 8 Steg, and 11 Steg TBM Tunnels.

Transition Matrix 74, parameter: 6\_FerdenSE\_DB\_XSection (1)

	ESx1a	ESx2a	ESx2b	ESx3a	ESx3b	ESx4a	ESx5a	ESx6a	ESx6b
ESx1a	0.00	0.47	0.25	0.12	0.06	0.04	0.03	0.02	0.01
ESx2a	0.29	0.00	0.29	0.18	0.09	0.06	0.04	0.03	0.02
ESx2b	0.14	0.26	0.00	0.26	0.14	0.08	0.05	0.04	0.03
ESx3a	0.08	0.13	0.25	0.00	0.25	0.13	0.08	0.05	0.04
ESx3b	0.06	0.08	0.12	0.24	0.00	0.24	0.12	0.08	0.06
ESx4a	0.04	0.05	0.08	0.13	0.25	0.00	0.25	0.13	0.08
ESx5a	0.03	0.04	0.05	0.08	0.14	0.26	0.00	0.26	0.14
ESx6a	0.02	0.03	0.04	0.06	0.09	0.18	0.29	0.00	0.29
ESx6b	0.01	0.02	0.03	0.04	0.06	0.12	0.25	0.47	0.00

Start proba: <

Figure C-3. Cross-Section Markov Matrix for 6 Ferden and 7 Ferden DB Tunnels

Transition Matrix 84, parameter: 5\_FerdenNW\_DB\_XSection (1)

	ES1a	ES2a	ES2b	ES3a	ES3b	ES4a	ES5a	ES6a	ES6b
ES1a	0.00	0.47	0.25	0.12	0.06	0.04	0.03	0.02	0.01
ES2a	0.29	0.00	0.29	0.18	0.09	0.06	0.04	0.03	0.02
ES2b	0.14	0.26	0.00	0.26	0.14	0.08	0.05	0.04	0.03
ES3a	0.08	0.13	0.25	0.00	0.25	0.13	0.08	0.05	0.04
ES3b	0.06	0.08	0.12	0.24	0.00	0.24	0.12	0.08	0.06
ES4a	0.04	0.05	0.08	0.13	0.25	0.00	0.25	0.13	0.08
ES5a	0.03	0.04	0.05	0.08	0.14	0.26	0.00	0.26	0.14
ES6a	0.02	0.03	0.04	0.06	0.09	0.18	0.29	0.00	0.29
ES6b	0.01	0.02	0.03	0.04	0.06	0.12	0.25	0.47	0.00

Start proba: <

Figure C-4. Cross-Section Markov Matrix for 5 Ferden and 4 Ferden DB Tunnels

Mean Lengths, Table 50, Parameter: SPV

File	Table	Min Length	Mode Length	Max Length	Mean Length
ESA1		21,0900	105,4400	189,7900	105,4400
ESA2		59,6700	298,3700	537,0700	298,3700
ESA3a		16,4200	82,1200	147,8200	82,1200
ESA3b		26,0900	130,4300	234,7700	130,4300
ESA4a		19,7900	98,9700	178,1400	98,9667
ESA4b		0,0010	0,0010	0,0010	0,0010
ESA5ak4		2,0500	10,2700	18,4800	10,2667
ESA5ak5		2,2400	11,1900	20,1400	11,1900
ESA5b		0,0010	0,0010	0,0010	0,0010

Figure C-5. Markov Mean Lengths for Zone 2 of the 10Raron DB Tunnel

Mean Lengths, Table 51, Parameter: SPV

File	Table	Min Length	Mode Length	Max Length	Mean Length
ESA1		146,8400	734,1800	1321,5300	734,1833
ESA2		83,1100	415,5300	747,9600	415,5334
ESA3a		95,3000	476,5200	857,7400	476,5200
ESA3b		54,4900	272,4600	490,4300	272,4600
ESA4a		55,1300	275,6500	496,1800	275,6533
ESA4b		0,0010	0,0010	0,0010	0,0010
ESA5ak4		0,0010	0,0010	0,0010	0,0010
ESA5ak5		0,0010	0,0010	0,0010	0,0010
ESA5b		0,0010	0,0010	0,0010	0,0010

Figure C-6. Markov Mean Lengths for Zone 3 of the 10Raron DB Tunnel

Mean Lengths, Table 52, Parameter: SPV

File	Table	Min Length	Mode Length	Max Length	Mean Length
ESA1		0,0010	0,0010	0,0010	0,0010
ESA2		17,9400	89,7000	161,4500	89,6967
ESA3a		18,5200	92,5800	166,6400	92,5800
ESA3b		0,0010	0,0010	0,0010	0,0010
ESA4a		5,9500	29,7500	53,5500	29,7500
ESA4b		0,0010	0,0010	0,0010	0,0010
ESA5ak4		0,0010	0,0010	0,0010	0,0010
ESA5ak5		0,0010	0,0010	0,0010	0,0010
ESA5b		0,0010	0,0010	0,0010	0,0010

Figure C-7. Markov Mean Lengths for Zone 4 & 6 of the 10Raron DB Tunnel

File	Table	Min Length	Mode Length	Max Length	Mean Length
ESA1		0,0010	0,0010	0,0010	0,0010
ESA2		3,2100	16,0700	28,9200	16,0667
ESA3a		4,9100	24,5700	44,2200	24,5667
ESA3b		0,0010	0,0010	0,0010	0,0010
ESA4a		1,8900	9,4700	17,0500	9,4700
ESA4b		0,0010	0,0010	0,0010	0,0010
ESA5ak4		0,0010	0,0010	0,0010	0,0010
ESA5ak5		0,0010	0,0010	0,0010	0,0010
ESA5b		0,0010	0,0010	0,0010	0,0010

Figure C-8. Markov Mean Lengths for Zone 5 of the 10Raron DB Tunnel

File	Table	Min Length	Mode Length	Max Length	Mean Length
ESA1		0,0010	0,0010	0,0010	0,0010
ESA2		56,6800	94,4600	132,2400	94,4600
ESA3a		190,6500	317,7500	444,8500	317,7500
ESA3b		0,0010	0,0010	0,0010	0,0010
ESA4a		83,5500	139,2500	194,9500	139,2500
ESA4b		0,0010	0,0010	0,0010	0,0010
ESA5ak4		8,6700	14,4400	20,2200	14,4433
ESA5ak5		9,4500	15,7400	22,0400	15,7433
ESA5b		0,0010	0,0010	0,0010	0,0010

Figure C-9. Markov Mean Lengths for Zone 7 of the 10Raron DB Tunnel

File	Table	Min Length	Mode Length	Max Length	Mean Length
ESA1		0,0010	0,0010	0,0010	0,0010
ESA2		41,2400	206,1800	371,1300	206,1833
ESA3a		54,0400	270,2200	486,4000	270,2200
ESA3b		0,0010	0,0010	0,0010	0,0010
ESA4a		15,6300	78,1600	140,6800	78,1567
ESA4b		0,0010	0,0010	0,0010	0,0010
ESA5ak4		0,0010	0,0010	0,0010	0,0010
ESA5ak5		0,0010	0,0010	0,0010	0,0010
ESA5b		0,0010	0,0010	0,0010	0,0010

Figure C-10. Markov Mean Lengths for Zone 8 of the 10Raron DB Tunnel

**Mean Lengths, Table 56, Parameter: SPV**

File	Table	Min Length	Mode Length	Max Length	Mean Length
ESA1		0.0010	0.0010	0.0010	0.0010
ESA2		0.0010	0.0010	0.0010	0.0010
ESA3a		2.1700	10.8700	19.5600	10.8667
ESA3b		0.0010	0.0010	0.0010	0.0010
ESA4a		1.6800	8.3800	15.0900	8.3833
ESA4b		0.0010	0.0010	0.0010	0.0010
ESA5aK4		0.2200	1.0900	1.9600	1.0900
ESA5aK5		0.2400	1.1800	2.1300	1.1833
ESA5b		0.0010	0.0010	0.0010	0.0010

Figure C-11. Markov Mean Lengths for Zone 9 of the 10Raron DB Tunnel

**Mean Lengths, Table 60, Parameter: SPV**

File	Table	Min Length	Mode Length	Max Length	Mean Length
ESA1		39.2600	196.2900	353.3200	196.2900
ESA2		18.5200	92.5800	166.6400	92.5800
ESA3a		25.4800	127.4000	229.3200	127.4000
ESA3b		0.0010	0.0010	0.0010	0.0010
ESA4a		16.3800	81.8900	147.4000	81.8900
ESA4b		0.0010	0.0010	0.0010	0.0010
ESA5aK4		0.0010	0.0010	0.0010	0.0010
ESA5aK5		0.0010	0.0010	0.0010	0.0010
ESA5b		0.0010	0.0010	0.0010	0.0010

Figure C-12. Markov Mean Lengths for Zone 10 of the 10Raron DB Tunnel



# Bibliography

1. BLS Alptransit website <http://www.blsalptransit.ch/>
2. C. Indermitte, H.H. Einstein, Decision Aids for Tunneling, Simsuper User's Manual, Cambridge, Massachusetts, 2000
3. C. Marzer, Decision Aids for Tunneling (DAT): Development of the Resource Model, 2001
4. C. Marzer, M. Nikolinakou, H. H. Einstein, Decision Aids in Tunneling, SimJava User's Manual, MIT, January 2002.
5. Donn E. Hancher, John A. Havers, Mathematical model of aggregate plant production: a construction engineering and management research report from the School of Civil Engineering, Purdue University, West Lafayette, Indiana, New York: American Society of Civil Engineers, 1972.
6. F. Vuilleumier, P. Teuscher, R. Beer, The Loetschberg Railway Base Tunnel, Tunnelling and Underground Space Technology, Vol 1, No3, p. 361-368, 1997.
7. F. Pena-Mora and M. Park, Dynamic Planning for Fast-Tracking Building Construction Projects, Journal of Construction Engineering and Management , November 2001
8. H. F. W, Taylor. Cement Chemistry, Thomas Telford Ltd., London, 2<sup>nd</sup> Edition 1997.
9. H. H. Einstein, C. Indermitte, J. Sinfield, F. P. Descoedres and J-P Dudt, Decisions Aids for Tunneling, Transportation Research Report No. 1656, National Academy Press, 1999.

10. H.H Einstein, J-P Dubt, V. B. Halabe, F. Descoeurdes, Decision Aids in Tunneling. Monograph in conjunction with the research project for the Swiss Federal Office of Transportation, Massachusetts Institute of Technology, 1992.
11. Ingenieurgesellschaft E+B / IUB, BLS Alp Transit AG, Materialbewertshaftung und Riskobeurteilung bei Vernung von AAR-Gefahrdetem Ausbruchmaterial als Betonzuschlagstoffe, Switzerland, 2000 (*in German*).
12. J. M. Lyneis, Pugh- Roberts Associates, System and Project Management ESD.185J & 1.432J, System Dynamics Class One, MIT September 2001
13. J. Sterman, Business Dynamics, 2000
14. J. V. Sinfield and H. H. Einstein. Evaluation of Tunneling Technology Using the Decisions Aids of Tunneling.
15. Tunneling and Underground Space Technology, Vol. 11, No. 4, 1996, pp.491-504.
16. K. Kovari, F. Descoeurders, Tunnelling Switzerland, Germany, 2001.
17. M. G. Peterson, F-J Ulm, Chemoplasticity of the Alkali-Silica Reaction in Concrete: Modeling of Stress-Induced Anisotropy, MIT, 2000.
18. Martiag SA website. <http://www.martiag.ch>
19. P. Kumar Mehta, Paulo J. M. Monteiro, Concrete, Structure, Properties and Materials, 2nd Edition 1993.

20. P. Zuber, The AlpTransit Scheme: New Railway Lines in Base Tunnels under the Swiss Alps, *Tunneling and Underground Space Technology*, Vol. 12, No. 3, pp. 357-36-, 1997.
21. V. B. Halabe, *Resource Modeling for DAT*, Massachusetts Institute of Technology, 1995.