

PRESENTATION BASED USER INTERFACES

by

Eugene Charles Ciccarelli IV

B.S., Massachusetts Institute of Technology
(1975)

M.S., Massachusetts Institute of Technology
(1978)

Submitted to the Department of
Electrical Engineering and Computer Science
in partial fulfillment of the
requirements for the
degree of

Doctor of Philosophy

at the

Massachusetts Institute of Technology

August 1984

(C) Massachusetts Institute of Technology 1984

Signature of Author *Eugene Charles Ciccarelli IV*

Department of Electrical Engineering and Computer Science

August 27, 1984

Certified by *Prince W*

Thesis Supervisor

Certified by *Carl E. Heath*

Thesis Supervisor

Accepted by *John J. ...*

Chairman, Departmental Committee

ARCHIVES

MASSACHUSETTS INSTITUTE
OF TECHNOLOGY

OCT 04 1984

LIBRARIES

PRESENTATION BASED USER INTERFACES

by

Eugene Charles Ciccarelli IV

Submitted to the
Department of Electrical Engineering and Computer Science
on August 27, 1984 in partial fulfillment of the requirements
for the Degree of Doctor of Philosophy

Abstract

A prototype *presentation system base* is described. It offers mechanisms, tools, and ready-made parts for building user interfaces. A general user interface model underlies the base, organized around the concept of a *presentation*: a visible text or graphic form conveying information. The base and model emphasize domain independence and style independence, to apply to the widest possible range of interfaces.

The *primitive presentation system model* treats the interface as a system of processes maintaining a semantic relation between an *application data base* and a *presentation data base*, the symbolic screen description containing presentations. A *presenter* continually updates the presentation data base from the application data base. The user manipulates presentations with a *presentation editor*. A *recognizer* translates the user's presentation manipulation into application data base commands. The primitive presentation system can be extended to model more complex systems by attaching additional presentation systems. In order to illustrate the model's generality and descriptive capabilities, extended model structures for several existing user interfaces are discussed.

The base provides support for building the application and presentation data bases, linked together into a single, uniform network, including descriptions of classes of objects as well as the objects themselves. The base provides an initial presentation data base network, graphics to continuously display it, and editing functions. A variety of tools and mechanisms help create and control presenters and recognizers. To demonstrate the base's utility, three interfaces to an operating system were constructed, embodying different styles: icon, menu, and graphical annotation.

Thesis Supervisor: Professor Carl Hewitt

Title: Associate Professor of Electrical Engineering and Computer Science

Thesis Supervisor: Dr. Richard Waters

Title: Principal Research Scientist, Artificial Intelligence Laboratory

Acknowledgments

My thesis committee, Carl Hewitt, Dick Waters, and Hal Abelson, have been helpful and encouraging. They have all aided significantly in shaping this thesis and improving its quality.

Norton Greenfeld and Martin Yonke introduced me to the world of the presentation concept. It was while working in their group at BBN that I began to think that the concept could serve to explain what was going on in various user interfaces.

Several people have helped with discussions and suggestions at various stages in the development of the ideas, including Lee Blaine, Ron Brachman, Charles Davis, Jeff Gibbons, Earl Killian, Henry Lieberman, Fanya Montalvo, Chuck Rich, Jan Walker, Bill Woods, and Frank Zdybel.

Dan Halbert and Bruce Roberts provided information and the sample screen images for the Xerox Star and Steamer systems, respectively.

Table of Contents

Chapter One: Introduction and Overview	8
1.1 The Primitive Presentation System Model	9
1.2 Constructing Larger Presentation System Models	16
1.3 Describing Presentation Systems	17
1.4 PSBase: A Presentation System Base	18
1.5 Constructing User Interfaces	20
1.6 Related Work	21
Chapter Two: The Primitive Presentation System (PPS) Model	28
2.1 PPSCalc	28
2.2 The Application Data Base	32
2.3 The Presentation Data Base	35
2.4 The Presentation Editor	39
2.5 The Presenter	39
2.6 The Recognizer	43
2.7 The Representation Shift Model and Direct Manipulation	48
Chapter Three: Constructing Larger Presentation System Models	54
3.1 Adding a Planned Data Base	54
3.2 Adding a Data Base of Commands	58
3.3 Adding Interfaces to PPS Components	60
3.4 Shared Screen Space and Presentation Structure	62
3.5 Concluding Remarks	66
Chapter Four: Describing Presentation Systems	67
4.1 Emacs Dired	68
4.2 Zmacs	74
4.3 Xerox Star	80
4.4 Steamer	90
4.5 Summary of Structural Features	97
Chapter Five: PSBase: A Presentation System Base	100
5.1 Data Base Mechanisms	103
5.2 Graphics Redisplay	114
5.3 Presentation Editor Functions	115
5.4 Presenter Support	115
5.5 Recognizer Support	124

5.6 Basic Style Packages	127
5.7 Summary	141
Chapter Six: Constructing Presentation Systems	142
6.1 The User's View of the Three Interfaces	142
6.2 Common Implementation Details	167
6.3 Icon-Style Interface Implementation	173
6.4 Menu-Style Interface Implementation	178
6.5 Annotation-Style Interface Implementation	181
6.6 Other Style Possibilities	183
6.7 Summary	184
Chapter Seven: Areas for Further Research	187
7.1 PSBase Limitations	187

Table of Figures

Figure 1-1: A Rudimentary User Interface	11
Figure 1-2: The Representation Shift Model	13
Figure 1-3: The Primitive Presentation System (PPS) Model	15
Figure 1-4: Structure of PSBase	19
Figure 2-1: The Primitive Presentation System (PPS) Model	29
Figure 2-2: PPSCalc -- Formula Display	30
Figure 2-3: PPSCalc -- Value Display	30
Figure 2-4: PPSCalc -- After Editing	31
Figure 2-5: PPSCalc -- After Recalculation	31
Figure 2-6: PPSCalc -- New Formulas	31
Figure 2-7: PPSCalc -- Values of New Formulas	32
Figure 2-8: World Model	34
Figure 2-9: Presenter Parts	40
Figure 2-10: Recognizer Parts	44
Figure 2-11: PPSCalc -- Value Moved	45
Figure 2-12: PPSCalc -- Formula Moved	46
Figure 2-13: PPSCalc -- Preparing to Copy Formula	46
Figure 2-14: Representation Shift Model	49
Figure 2-15: Functional Mapping in the PPS Model	52
Figure 3-1: Planned Data Base Extension	56
Figure 3-2: Extension with Both Planning and Immediate Changes	57
Figure 3-3: Command Data Base Extension	59
Figure 3-4: Presenter Interface Extension	61
Figure 3-5: Presenter Commands Extension	63
Figure 4-1: Dired Model	72
Figure 4-2: Zmacs Model	75
Figure 4-3: Zmacs Scroll Bar	81
Figure 4-4: Xerox Star -- Desktop Display	83
Figure 4-5: Xerox Star -- Opened Folder	84
Figure 4-6: Xerox Star -- Property Sheet	86
Figure 4-7: Xerox Star -- Delete Confirmation	87
Figure 4-8: Xerox Star Model	88
Figure 4-9: Sample Steamer Schematic	91
Figure 4-10: Steamer Menu Console	93
Figure 4-11: Steamer Model	94
Figure 4-12: Sample of Steamer Icons	95
Figure 5-1: PSBase Support of PPS Components	101
Figure 5-2: Structure of PSBase	102
Figure 5-3: A Class Description Network	105

Figure 5-4: Sample Presentation Data Base Structure	107
Figure 5-5: Inter-Presentation Relationships	108
Figure 5-6: Command Description Support	110
Figure 5-7: Reference Resolution	113
Figure 5-8: Result of a Presentation Style	122
Figure 5-9: Result of Phrasal Presenter	131
Figure 5-10: Before Curve Recognition	133
Figure 5-11: After Curve Recognition	134
Figure 6-1: Icon-Style Interface	144
Figure 6-2: Icon-Style Interface	145
Figure 6-3: Icon-Style Interface	147
Figure 6-4: Icon-Style Interface	148
Figure 6-5: Icon-Style Interface	149
Figure 6-6: Icon-Style Interface	151
Figure 6-7: Icon-Style Interface	152
Figure 6-8: Icon-Style Interface	153
Figure 6-9: Menu-Style Interface	155
Figure 6-10: Menu-Style Interface	156
Figure 6-11: Menu-Style Interface	158
Figure 6-12: Menu-Style Interface	159
Figure 6-13: Menu-Style Interface	160
Figure 6-14: Menu-Style Interface	161
Figure 6-15: Menu-Style Interface	163
Figure 6-16: Annotation-Style Interface	165
Figure 6-17: Annotation-Style Interface	166
Figure 6-18: Annotation-Style Interface	168
Figure 6-19: Application Data Base Management	171

Chapter One

Introduction and Overview

Building good user interfaces is a slow and difficult process. Good user interfaces are generally large, complex, and hard to understand, and these characteristics tend to be exacerbated when the interface is modified. All too often, interfaces are built that lack flexibility in their use, lack some functionality, or lack uniformity with interfaces to different applications.

The primary result of this research is the development of a prototype *presentation system base*, called PSBase. PSBase contains tools, mechanisms, and ready-made parts for the construction of user interfaces. Independence of particular interface styles and application domains is emphasized, in order to maximize the generality and utility of the base. PSBase also provides a conceptual framework for user interfaces. Underlying the base is a general model of user interfaces, called the *presentation system model*. The thesis claims that, with a presentation base, interface construction is easier and quicker, and the results are better.

To demonstrate the utility of PSBase, a user interface was constructed on top of it, and three different styles were implemented for this interface. A presentation system base should be independent of any particular application domain or any particular interface style. It should support the construction of (and experimentation with) many different kinds of applications and styles.

For example, consider the following spectrum of styles. At one end is *direct manipulation* [Shneiderman 83]: the object of interest is continually displayed, and the user's actions appear to be manipulating the object with no intervening command language. An alternative style is preparing a desired *future version*. (This style *looks* the same as direct manipulation, but the object of interest is not continually changing -- the specification of the future version is.) Another style is *annotating* the current view with commands for how to

change the object. At the other extreme from direct manipulation is a separate *command language* for describing the manipulation. Examples of these alternative styles can be seen when readers request changes in a draft paper: sometimes the original file is edited, sometimes a new file is created, sometimes the (paper) draft is annotated, and sometimes the changes are discussed separately.

Another result of this research is the presentation system model itself. This is a general model of user interfaces, and it is the foundation of PSBase. Even by itself, however, it has benefits. It aids the understanding of user interfaces in general by providing a unifying set of concepts for thinking about user interfaces. There are two ways that it helps someone building a user interface in the absence of a presentation system base. It serves as a checklist of the possible kinds of functionality in a user interface. The structure of the model serves as an architectural framework for the interface.

The model may also be of aid to people studying interface styles in general. One problem in such a study is the large number and diversity of possible styles. The model defines various classes of general parameters for interfaces. One can define styles as patterns of these parameter specifications.

The following five sections provide an overview of the five major chapters in this thesis. These chapters divide into two groups. The first group, comprising chapters two, three, and four, discusses the presentation system model that underlies the presentation system base. The second group, comprising chapters five and six, discusses the presentation system base and its application.

1.1 The Primitive Presentation System Model

This section introduces the primitive presentation system (PPS) model of user interfaces, which is discussed further in chapter two. Two simple models of a data base interface will first be introduced. They will be used to focus attention on certain aspects and to motivate the development of the full PPS model. The first model focuses on the data base, considering a *rudimentary interface* to it. The second model, the *representation shift model*,

focuses on the user's need for a more useful and coherent representation of the data base information and commands. The representation shift model is also useful in itself, as it is a special case of the full PPS model and applies to some common interface styles. The PPS model extends the representation shift model to allow more flexibility in the relationship between the screen and the data base.

A Rudimentary User Interface. Figure 1-1 shows the basic interface to an application data base and a rudimentary user interface constructed from it. The data base has three external inputs and outputs. *Commands* change the state of the data base (adding, changing, or deleting information). *Queries* allow the state of the data base to be examined, producing the relevant information at the *observables* output.

These inputs and outputs are not directly usable by a person -- they are in a format designed for use by programs. (The user is not the only one using data bases, after all.) In order to provide even a rudimentary user interface, some simple kind of *transducers* must be placed on each input and output line.

The transducer on the command input, for example, might convert a text version of a command to the binary form required by the data base. The transducers do not provide a different overall model of data base use -- the user still must use the commands and queries provided by the data base. The language used to express them has been changed slightly so that it is printable and mnemonic, much the same kind of translation that a simple assembler performs.

The rudimentary interface is usable, but suffers from two basic problems from the user's point of view. First, the user must express the data base modification in terms of the data base commands available. Second, the results of such modification, as well as any viewing desired, must be explicitly requested via queries.

Representation Shift. Figure 1-2 shows an expanded user interface. Here, two data bases are involved, the application data base as before and a new one, called a *presentation* of the data base, introduced to allow the user more direct modification and viewing. The

Figure 1-1: A Rudimentary User Interface

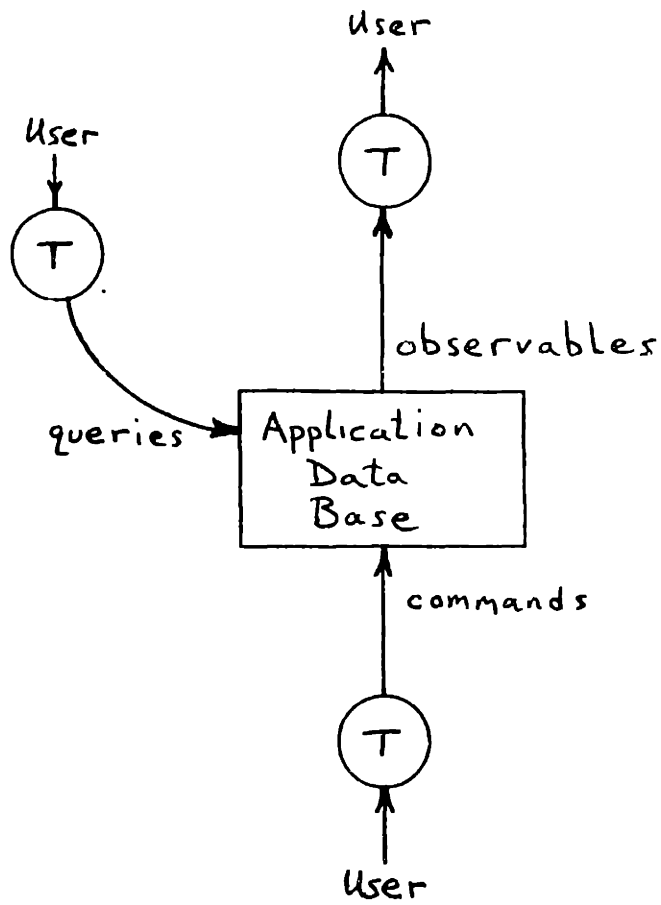

presentation data base contains the same information as the application data base, but it is represented in a way that is directly viewable, i.e., in terms of text and graphic forms. It is continuously displayed (on the user's terminal), so that the user does not have to explicitly request information to be viewed.

The presentation -- or, loosely speaking, the screen -- can be directly edited by the user, by means of the *presentation editor*. The editor allows the user to manipulate the forms on the screen, creating new forms or changing or deleting existing ones. Conceptually, it combines capabilities of a text editor with those of a graphics (diagram) editor. As these changes are made, their results are immediately visible.

In addition, the commands for presentation editing are chosen to be convenient for the user. For example, they might include a base of general text-editing and graphics-editing commands, so that the user does not have to learn a special language for each particular application data base.

The *presenter* creates the presentation data base from the application data base. At appropriate times as the user edits the presentations, the *recognizer* creates a new version of the application data base from the presentation data base. In the representation shift model the presentation contains all and only the information contained in the application data base. The presenter uses a single application data base query (labeled *get-db* in the figure) to get a representation of the entire application data base, converts the representation, and then uses a single presentation data base command (labeled *load-db*) to load the entire presentation data base. Similarly, the recognizer gets the entire presentation contents, converts it, and loads the entire application data base.

In the representation shift model, the presenter relation must be invertible, since the recognizer must be able to specify the entire application data base from the presentation data base. In general the presenter relation is a subset of the recognizer relation, or in other words, the recognizer will recognize several different variants of the same presentation, allowing the user more latitude. For example, the recognizer might allow the user to create any of "12", "12.0", "12.000", etc., whereas the presenter might always choose "12.0".

Figure 1-2: The Representation Shift Model

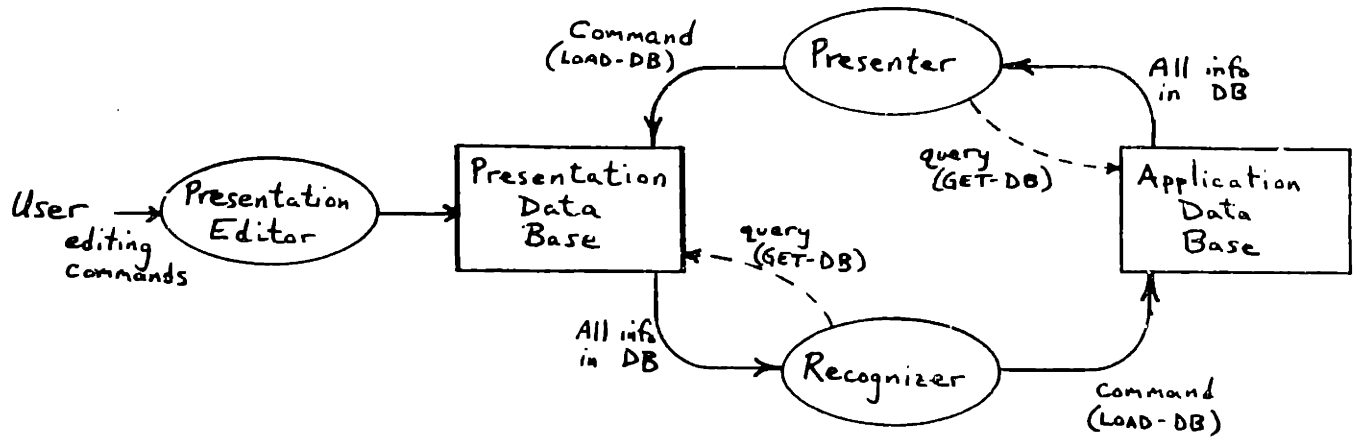

The representation shift model is a *direct manipulation* interface [Shneiderman 83]. The screen continuously displays the data base. Whenever the data base changes, the screen is updated. Similarly, the user manipulates the data base by manipulating the forms on the screen, and the data base is continually updated from this.

The major restriction of the representation shift model is that the *entire* application data base be viewed (and in an invertible presentation). This can lead to inefficiency. It can also lead to the inconvenience of visual clutter -- the user cannot view just a relevant subset of a complex data base. The ability to control the selection of information to be viewed and the way it is to be viewed can be crucial to the successful use of the data base.

The Full PPS Model. The full PPS model, shown in figure 1-3, relaxes the restriction that the entire application data base must be viewed. The presentation, i.e., the visual data base, may convey only a small part of the information in the application data base. The screen thus can no longer be recognized in a simple manner as specifying all the information in the application data base. This necessitates a generalization in the recognizer from that in the representation shift model: the recognizer translates *editing actions* into data base commands, rather than translating editing results into data base data. (The term *editing actions* includes both the editing command and the editing result. Therefore, the PPS recognizer includes, as a special case, the possibility of just having to examine the editing result.)

The *presenter* is responsible for making the screen continually show the relevant part of the data base. It creates the initial display and updates the display when the data base changes. The presenter collects the relevant information from the application data base, converts that information to text and/or graphics, and organizes the layout of this visual information on the screen.

The *recognizer* causes the data base to change to reflect the user's editing of the presentation. Specifically, in addition to affecting the screen, the user's editing operations are recognized as -- i.e., translated into -- operations on the data base. Thus, the PPS model is also a *direct manipulation* interface: the data base is continually presented on the screen,

Figure 1-3: The Primitive Presentation System (PPS) Model

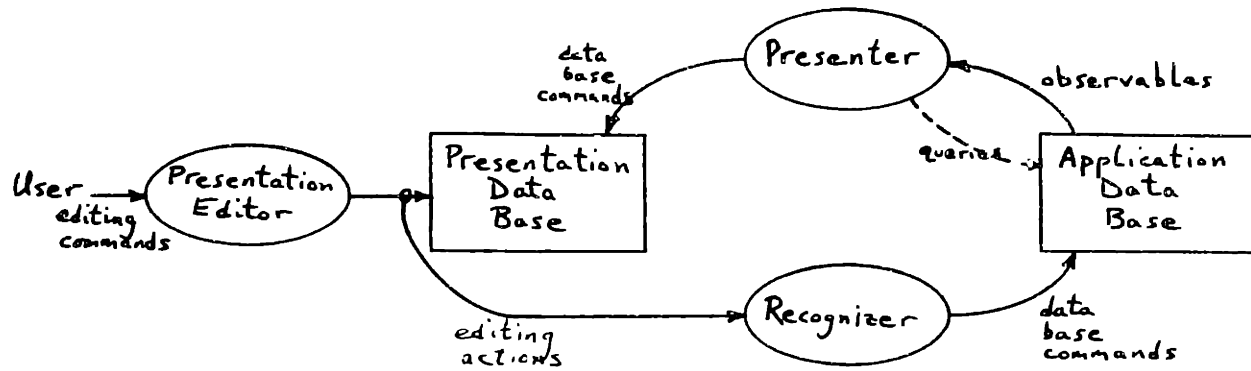

with screen following data base changes (by presenter action) and data base following screen changes (by recognizer action).

1.2 Constructing Larger Presentation System Models

The primitive presentation system model can be extended to model more complex presentation systems as discussed in chapter three. The basic technique for extending the presentation system model is to attach an additional presentation system to it, either replacing or augmenting some part of it. The resulting presentation system may thus contain several smaller presentation systems. The extensions discussed in this section are suggested by examining the major limitations of the PPS model.

Adding a Planned Data Base. In the PPS model changes to the data base are immediate. To avoid this, a second application data base can be added to a presentation system: a future (i.e., planned) version of the original data base. The user can edit the planned version's presentation, separate from the presentation of the current state of the data base. When the planned version looks acceptable, the user gives a *do it* command that causes the actual data base to be updated.

Adding a Data Base of Commands. In the PPS model the user cannot see a description of the changes or the commands to effect them presented explicitly. (Only the data base that results from these commands is seen.) Using a technique similar to the previous one of adding a planned version of the data base, a data base of commands can be added. In this extension, the planned changes are represented in the new data base explicitly, and can be presented in a style different from the style for the application data base.

Adding Interfaces to PPS Components. In the PPS model the editor, presenter, and recognizer are not presented; the user only has an interface of primitive signals to them (e.g., keystrokes or a pointing device). To circumvent this limitation, presentation system interfaces to these components can be added. One technique involves adding a data base for the particular component's state, e.g., some options controlling the presenter's style, and constructing presenters and recognizers for showing and manipulating it. Alternatively, a

data base of commands for the component can be added, just as in the previous section a command data base was added for the application data base.

1.3 Describing Presentation Systems

The presentation system model can be used as a descriptive tool. The model provides a set of concepts for enumerating and categorizing basic functions and interactions in a user interface, even when that interface was not designed with the model in mind.

In chapter four several user interfaces will be described using the presentation system model. The selection exhibits a variety of interface styles in order to illustrate the model's generality. In each example the focus will be on those presentation system mechanisms that play the most important part in defining that particular style. Two interfaces, drawn from those described in chapter four, are sketched below.

Xerox Star / Apple Lisa. The Xerox Star [Smith, Irby, Kimball, Verplank & Harslem 83] and the Apple Lisa [Lisa 84] systems offer an interface using icons -- pictorial presentations of commands and data. Some recognition is simple reference resolution such as pointing to an icon that presents a particular command. Other recognition involves more complicated inter-icon relations such as proximity. For example, in Lisa the user deletes a file by moving the file's icon to a trash can icon. In both Star and Lisa the user prints the file by moving its icon to the printer icon.

Emacs Dired. A subsystem of the Emacs editor [Stallman 81], Dired is used to perform various directory operations. It is an example of an extended presentation system that provides both *direct manipulation* of the data base (the directory being edited), e.g., when certain file properties are changed, and *planned operations*, e.g., when files are marked for later deletion. The planned deletions are presented as annotations to the presentation of the current directory.

1.4 PSBase: A Presentation System Base

Chapter five discusses PSBase, the prototype presentation system base that was implemented in the course of this research.

PSBase explicitly incorporates the presentation system model structure. It includes tools, mechanisms, and ready-made parts for building an interface consisting of an application data base, presentation data base, presenters, recognizers, and presentation editor. Domain-independent and style-independent mechanisms are provided and may be combined largely independently. These characteristics cause PSBase to be useful in constructing a wide range of interfaces.

Figure 1-4 shows the overall structure of PSBase. The *data base mechanisms* provide support for building application data bases structured in a network somewhat similar to knowledge representation networks. The network includes descriptions of the classes of objects as well as the objects themselves, and class inheritance is supported. An important point is that this network is used to build the presentation data base as well, and the presentation and application data bases are linked together into a large, uniformly structured data base. This uniformity is an important factor in the power of the PSBase mechanisms. PSBase predefines a large part of the presentation data base class network.

PSBase also provides mechanisms that accompany the presentation data base: *Graphics redisplay* ensures that the presentation data base is continuously displayed on the terminal. Several *presentation editor functions* are provided; the interface builder may select these, as desired.

The *presenter support* and *recognizer support* modules provide a variety of tools and mechanisms for creating and controlling presenters and recognizers. Most important among these mechanisms is a language for describing presentation styles and general presenters that interpret these languages. The interface builder need only describe how the presentation structure relates to the application data base structure, and the presenters perform the actual creation and updating of the presentations.

Figure 1-4: Structure of PSBase

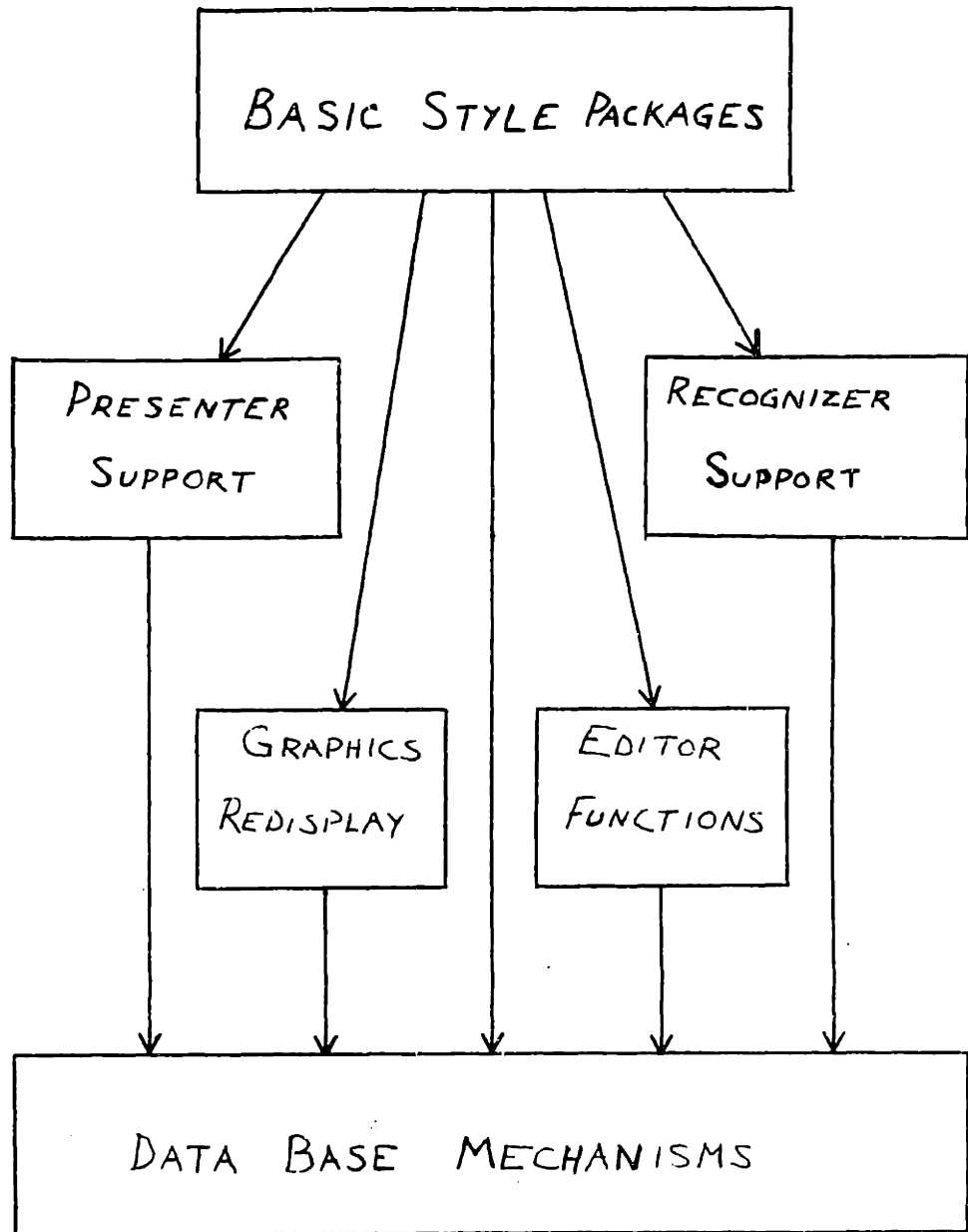

A number of *basic style packages* offer specific components of domain-independent interface styles that the interface builder may choose to include. Some general presenters and recognizers are provided. For example, a presenter is provided to produce command menus. As another example, a recognizer is provided to interpret simple rule descriptions in order to recognize icon movement, similar to the Xerox Star and Apple Lisa systems (see section 1.3).

No claim is made that PSBase would serve as a production presentation system base. It is a prototype, and needs more and improved features of many kinds. It provides only a part of the presentation editor functions that would be needed. Many more domain-independent presenters and recognizers could be included. The presentation style description language could be improved and used to drive recognition as well. This would result in more uniformity in what the system can present and what it can recognize, providing the user with increased consistency and power.

1.5 Constructing User Interfaces

In order to demonstrate the utility of PSBase, three interfaces were constructed using the PSBase mechanisms and tools. The three interfaces share the same application data base, but embody different styles. The first style uses icons, similar to the Xerox Star and Apple Lisa system described in section 1.3. The second style uses text displays with accompanying command menus. The third style is a graphical annotation style, an extension of the Dired style described in section 1.3.

Some of the work was done once and shared between the three implementations, namely, the style-independent development of the application data base. Once that work was completed, implementing a particular style was largely a matter of writing a few small pieces using PSBase tools and choosing some standard PSBase ready-made parts from the *basic style packages* module.

1.6 Related Work

This thesis discusses two developments, a domain-independent, style-independent presentation system base for building user interfaces, and its underlying model of user interfaces. This section discusses characteristics of the base and the model that distinguish it from other research. Two characteristics of both the base and the model are particularly important:

First, the model and the base attempt to concentrate on general *mechanisms*, independent of any particular domain and independent of any particular style. The intent has been that they should be free of value judgments concerning styles. Discussing what constitutes a *good* style or developing *new* styles are separate efforts; this research offers a conceptual vocabulary in which such a discussion can be phrased and offers a base for experimenting with or combining alternative styles.

Second, the model and the base center about the high-level concept of the *presentation*. This concept considers the semantic connection between the screen and the application. The model is structured to show how the presentation is used as a medium for communication between the user and the application. The emphasis in both the model and the presentation system base has been on the *system* aspects: how the system of processes and data bases are structured and interact regarding the presentation relationship. This research has not emphasized any one particular part of this system: several other studies emphasize the application data base, or the presentation data base, or presenters, or recognizers.

Other research that this work resembles can be classed into three broad areas: human factors, systems and techniques, and presentation systems. Although this research is related to these areas, the author knows of no other research that directly addresses the same goals of studying and providing support for a system of general user interfaces mechanisms. Rather than being an alternative approach, this work complements the others that are mentioned. The third area, presentations systems, is the closest to this research, in that it includes systems for aiding user interface construction, based on concepts similar to the

presentation concept used here.

Human Factors. At the psychological end of the spectrum, there have been several efforts to which this research is somewhat related. Two major kinds of work is described, first, *user modeling* and, second, interface *specification techniques* and guidelines. Some representative research is mentioned.

There have been efforts to develop models of user behavior, user performance, and user understanding of systems. Often these studies concentrate on particular classes of users or interface styles. Shneiderman, for example, has examined a class of interface styles that he terms *direct manipulation* [Shneiderman 83]. These interfaces are marked by "visibility of the object of interest; rapid, reversible, incremental actions; and replacement of complex command language syntax by direct manipulation of the object of interest." He discusses direct manipulation style, and its affect on and acceptance by different kinds of users, in terms of a *semantic/syntactic* model of user behavior [Shneiderman & Mayer 79] [Shneiderman 80]. According to this model, two kinds of knowledge about user interfaces reside in long-term memory, syntactic and semantic. Syntactic knowledge includes details of command syntax; it has an arbitrary character and is easily forgotten unless frequently used. Semantic knowledge includes the hierarchically-structured concepts of functionality and processes for performing various tasks. Semantic knowledge is largely independent of particular systems and is more easily retained. The success of the direct manipulation style follows from the fact that "the object of interest is displayed so that actions are directly in the high-level problem domain," requiring little need for syntactic knowledge.

Modeling the user can be a tool for evaluating the behavioral style of an interface, by studying the match between the interface behavior and the user behavior. The presentation system model, on the other hand, complements the user model by approaching the problem from the other end, discussing the kinds and internal structures of interface mechanisms that will by their interaction produce the particular overall behavior as seen by the user.

Some guidelines and formal techniques have been developed for specifying user interface dialogs, a part of the user interface style. *Formal grammars* (or, equivalently, *state transition*

networks) are one technique for describing and designing the dialog between user and computer [Reisner 81] [Reisner 82] [Bleser & Foley 82] [Jacob 82] [Brown 82]. Formal grammars describe the interaction between user actions and system responses. Some grammars include cognitive information, describing what a user has to learn and remember. A grammar can be used as a design tool, evaluating designs for consistency and simplicity. Problems users might have and mistakes they might make can be predicted.

As with user models, dialog descriptions are complemented by the work reported here. One may identify three layers of study, all requiring models and description techniques: general user interface mechanisms (presentation system model), overall user interface style (dialog specifications), and the user (user models).

Systems and Techniques. The second area of related work is the building of systems, from *cooperative user interfaces* to *graphics systems*, and the development of techniques to use in such systems. Some of these projects tend to concentrate on one side or the other of the presentation relation: on representing the knowledge in the application data base or on manipulating and displaying the presentation data base. Others tend to concentrate on the development of particular interface styles.

Research into cooperative user interfaces, such as the Cousin effort at CMU [Hayes 84] and the Consul/Cue effort at Information Sciences Institute [Kaczmarek, Mark & Wilczynski 83] [Mark 81], study various ways that user interface can be more easily constructed to actively aid the user. An important part of such systems is the provision of a uniform view of the applications and a helpful assistant, based on an extensive description of those applications or the interface styles. Such an assistant might try to understand why the user is having difficulty or try to understand requests made in an unexpected form.

A large part of the Consul/Cue work concentrates on the representation of knowledge about the application and its commands (services). The different applications are described in a uniform manner. This is separated from the particular choice of styles used to interface to these applications, such as windows/pointing, command languages, or natural language. The user interface assistant understands the data base representation and uses it to provide

explanations, flexible recovery from command language errors, and assistance in using several different applications by understanding their functionality.

The research reported here is closer to the Cousin project. The Cousin project does not concentrate on incorporating knowledge about application semantics, but rather on developing a uniform interface style to support a user interface assistant. The assistant corrects erroneous or abbreviated input, interacts with the user to resolve errors, and offers integral and automatically generated on-line help and documentation. The Cousin system provides a common interface base, separate from the application, that interprets an interface definition provided by the application builder. This definition expresses the user interface as a set of forms, with fields that convey information between the user and the application.

There is an emphasis in these research efforts on developing cooperative styles, developing techniques for them (such as more intelligent recognizers), and for Consul/Cue, investigating the problems of representing knowledge about the application's functionality. The work reported in this thesis also relies heavily on the separation and uniformity of the application data base mechanism. But this work has not studied the issues of knowledge representation involved. Nor has it been involved with developing particular styles. And unlike the cooperative systems projects, this work attempts to be able to model and support arbitrary existing interface styles.

There are several research efforts studying different uniform styles of information presentation and interaction, and several efforts at developing presentation and interaction techniques for specific domains. For example, spatial data base management systems [Herot 80] [Donelson 78], the Boxer system [diSessa 85], the Xerox Star [Purvy, Farrell & Klose 83] [Smith, Irby, Kimball, Verplank & Harslem 83], and the Query-by-Example-based office systems [Zloof 82] [Zloof & de Jong 77] all offer the user a consistent way of interacting with a variety of applications. In a spatial data base management system, the user accesses information by "moving through" the data base -- information from many different domains is organized spatially, with related information nearby. Retrieval is something like flying over a land of information: information is found by moving to it, and

detail is controlled by zooming. In the Query-by-Example systems, on the other hand, the user accesses different kinds of information by providing an example of the kind of information desired. Several systems have been developed that offer complex presentation techniques and styles for particular domains. Simulators are perhaps the most widely known; the Steamer system [Stevens, Roberts & Stead 83], discussed in chapter four, is one example. Another area of increasing interest is the presentation of the organization and execution of programs, such as the Computer Corporation of America's program visualization system [CCA 79], Henry Lieberman's Tinker system [Lieberman 84] [Lieberman 83], and the Brown University system for program animation [Brown & Sedgewick 84a] [Brown & Sedgewick 84b] [Brown & Sedgewick 84c]. The intent of the work reported in this thesis is to develop a model and system that can be used to describe and build any of these kinds of styles.

The books by Newman and Sproull [Newman & Sproull 79] and Foley and Van Dam [Foley & Van Dam 82] primarily discuss low-level drawing and interaction techniques for graphics systems. For the most part, they are concerned with only one kind of application data base -- geometric models of solids, surfaces, etc. Within the framework of the model of this thesis, their books discuss detailed techniques for building presentation editors and presentation data bases. However, concerning the presentation data base, their emphasis is more on representation at a low level, suitable for display processors, and does not attempt to offer a general representation technique. This is in contrast to the presentation system base of chapter five, for example, which uses a general description mechanism for both the presentation data base and the application data base. The standard graphics systems are less in need of such a scheme, as they are not involved with any sort of "reasoning" about the data bases, and instead need to perform computations efficiently. Thus, the graphics system should be viewed as a low-level component of a presentation data base as described in this thesis.

Information Presentation Systems. The research reported in this thesis most closely resembles research developing what have been called *information presentation systems* or *systems for automatically synthesizing graphics environments*, for example the Bharat system

[Gnanamgari 81], the View system [Friedell 83], and the AIPS system [Zdybel, Gibbons, Greenfeld & Yonke 81][Zdybel, Greenfeld, Yonke & Gibbons 81]. These systems all emphasize a knowledge-based approach to creating what this thesis would call *intelligent presenters*. The systems explicitly incorporate concepts similar to the presentation concept used here, particularly the AIPS system. All three systems have interesting and individual aspects, but from the point of view of this research, it will suffice to discuss the AIPS work as representative. (It was while working with the AIPS group that the author first started thinking about the presentation's use as an organizing concept for modeling user interfaces.)

The goal of AIPS as an information presentation system is to provide an interface to a large knowledge base or knowledge-based system. The system automatically generates displays from content-oriented (i.e., domain) specifications. (E.g., "display the ships in the Mediterranean.") AIPS is itself a knowledge-based system. Using a large knowledge base describing how structures of domain information can be related to structures of graphical displays, the system automatically selects or constructs an appropriate presentation style. A full information presentation system would include knowledge about the user, general domains, a wide variety of presentation styles, and human factors decisions involved in graphical display.

There are three aspects in which the work reported in this thesis differs from the AIPS research. First, this thesis addresses a more general class of interfaces than information presentation systems. Information presentation systems currently exist only in prototype form; there are many other kinds of interfaces to be supported now and, presumably, even when full information presentation systems are available. Most interfaces do not have intelligent or automatic presenters. One reflection of this difference is seen in the general model of interfaces developed in this thesis.

Second, this thesis emphasizes the *system* aspects of the interface, rather than concentrating on any one component of the system. This is one reason why this research and the others are complementary: the AIPS work considers presenters in detail; this work considers the relationship between presenters and the rest of the user interface system.

Third, the most distinguishing characteristic of the AIPS work is its emphasis on issues of knowledge representation. This thesis does not address those issues, again because the emphasis here is not on intelligent presenters or on techniques of describing presentation styles. Relatively simple description techniques suffice for the PSBase system. However, the results of research into the representation of knowledge about graphical display could be incorporated into a production version of a presentation system base to great effect.

Chapter Two

The Primitive Presentation System (PPS) Model

This chapter discusses the PPS model in detail. Figure 2-1 reproduces figure 1-3 of chapter one, except that here two new primitive-signal inputs are added, controls for the presenter and recognizer. Each of the components of the PPS model will be discussed in turn in sections below.

2.1 PPSCalc

The sections in this chapter use an example program called PPSCalc. This is a simple spreadsheet program, a trivial version of VisiCalc [Beil 82]. PPSCalc was designed specifically for this explanation -- its behavior strictly follows the PPS model. PPSCalc is illustrated in figures 2-2 and 2-3.

The spreadsheet consists of cells, organized in rows and columns. Each cell may be empty, contain just a numeric value, or contain a formula and a numeric value. In a cell with a formula, the numeric value is computed by the formula from the values in other cells. Cells which just have a numeric value -- no formula -- are called *independent cells*. Their values are set by the user. Cells which have a formula are called *dependent cells*. Their values are recomputed periodically, as will be discussed below. Cells with neither a formula nor a value are *empty*.

PPSCalc has two display modes, formula display and value display, illustrated by the two figures. Figure 2-2 shows the mode that displays the dependent cells' formulas. Figure 2-3 shows the mode displaying the dependent cells' values computed by those formulas.

PPSCalc is shown in figure 2-2 with an assignment of cell formulas for computing a simple bill, based on the prices for two kinds of items and the numbers of the items

Figure 2-1: The Primitive Presentation System (PPS) Model

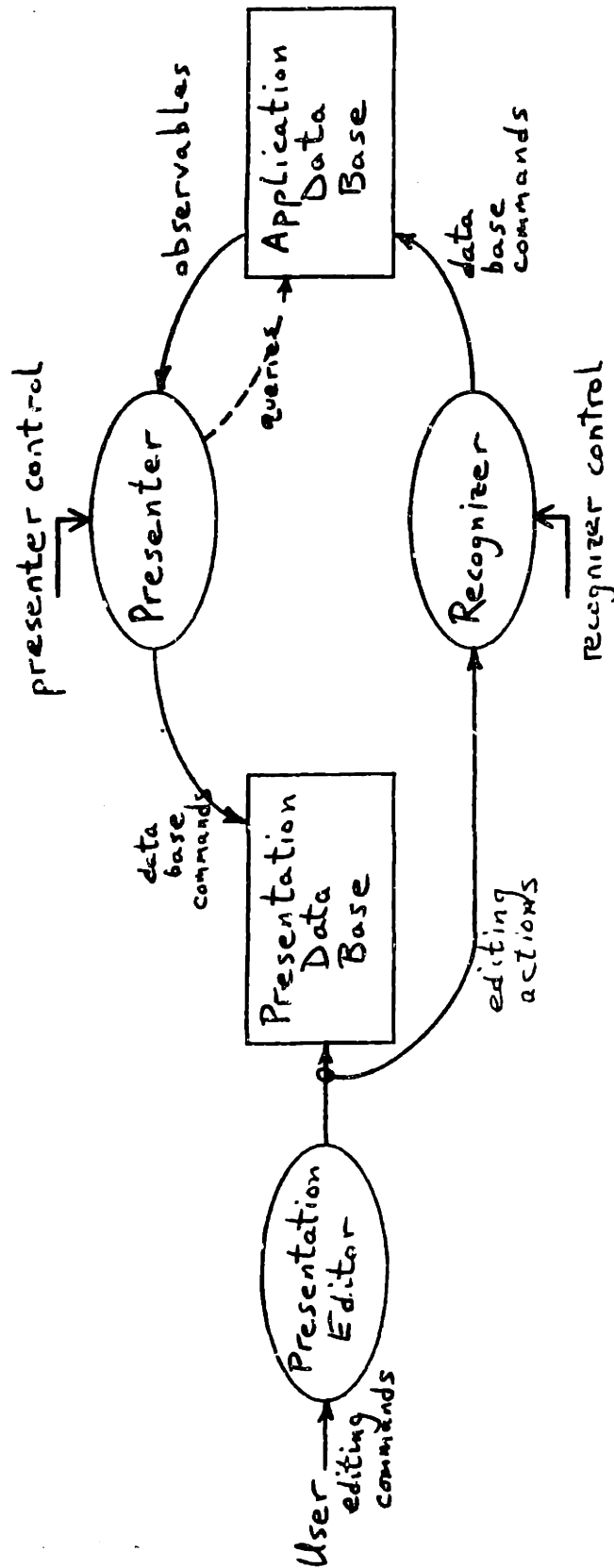

	A	B	C
1	100	20	A1*B1
2	75	5	A2*B2
3			C1+C2

Figure 2-2: PPSCalc -- Formula Display

	A	B	C
1	100	20	2000
2	75	5	375
3			2375

Figure 2-3: PPSCalc -- Value Display

purchased. The A1 and A2 independent cells specify the prices, and the B1 and B2 independent cells specify the number purchased. Dependent cells C1 and C2 compute the amount to be paid for the two items, and dependent cell C3 computes the total amount to be paid. Cells A3 and B3 are empty.

In both display modes, the visible contents of the cells can be edited, using the text editor Emacs. After a certain amount of editing, typically just changing the contents of one cell, the user types the return key. This signals PPSCalc to update the spreadsheet based on the edits to the visible text. *Recalculation* is then performed: each dependent cell, from left to right, top to bottom, has its formula evaluated and its numeric value recalculated. After that, the visible text is updated to display any of the cells that changed.

For example, the user might edit the "5" in the B2 cell display to be "11", in order to indicate that 11 items of the second kind are being purchased, instead of 5. The display now looks like figure 2-4.

The user types a return, and PPSCalc recalculates the dependent cells C1, C2, and C3. C2

	A	B	C
1	100	20	2000
2	75	11	375
3			2375

Figure 2-4: PPSCalc -- After Editing

changes its value because of B2, and C3 because of C2. PPSCalc redisplay the spreadsheet, showing the new bill, as in figure 2-5.

	A	B	C
1	100	20	2000
2	75	11	825
3			2825

Figure 2-5: PPSCalc -- After Recalculation

The user now decides to change the cell formulas, to add accumulation of a 5 percent sales tax. The user requests the formula display mode, types formulas into the previously empty A3 and B3 cells, and edits the formula in the C3 cell. Cell A3 totals the amounts, cell B3 computes the sales tax, and cell C3 computes the total charge. This is illustrated in figure 2-6.

	A	B	C
1	100	20	A1*B1
2	75	11	A2*B2
3	C1+C2	A3/20	A3+B3

Figure 2-6: PPSCalc -- New Formulas

When the user switches back to displaying the dependent values, these new formulas result in the display shown in figure 2-7.

	A	B	C
1	100	20	2000
2	75	11	625
3	2825	141	2966

Figure 2-7: PPSCalc -- Values of New Formulas

A question arises as to what should happen when dependent values are being displayed, and the user edits a dependent value to a different numeric value. PPSCalc has two modes regarding this. In one mode PPSCalc will ignore the edit -- when the user types return, PPSCalc beeps, recomputes the dependent value normally, and displays the result. In the other mode PPSCalc interprets the edit as changing that dependent cell to be an independent cell with that value.

PPSCalc will be further discussed in the sections below as it is used to illustrate issues in presentation system modeling.

2.2 The Application Data Base

A user interface does not exist by itself -- its whole purpose is to provide the user with the ability to use something, typically a program or system of programs. It may also be something that the user does not consider to be an active agent -- for example, a collection of values, or in general a data base. In some applications the user's view is of a passive data base, even though in the background (external or internal to the data base) there is some active agent managing the data base. For example, typically a user will view a file system as passive, though in the background various operating system programs maintain the integrity and reliability of the file system. (Backup and salvager programs are examples.)

Any application can be viewed, from the perspective of the user interface, as a data base.

In other words, interfacing to a data base, besides being an important case in itself, can simulate the situation with other applications. For example, consider a user interface to an application program where there is no obvious data base in the implementation. One such example is a process control system, allowing the user to monitor and control the state of a power generator, say. Here, much of the state is not in the program but in the physical world: temperatures, pressures, etc. However, from the point of view of the user interface, the *behavior* of the application program is similar to the behavior of a data base. The system can thus be treated as a system that maintains a data base describing this world state and the control options. In the model the job of the user interface system is to let the user view and manipulate this world description.

Since any application can be viewed as a data base, for the model developed in this thesis we will treat the user interface as providing the user with access to a data base. The user's task will be to view and manipulate the contents of the data base.

The PPSCalc spreadsheet can be considered a data base. It has an active component, namely recalculation, which determines the values of the dependent cells in the spreadsheet.

World Models. The basic data base model being used does not specify anything about the internals of what is being called the application data base. It only matters that the data base takes commands and queries and returns observables. Nothing is said about whether the data base is implemented by information records, or by computation, or by connection to the physical world. Its external behavior is that of a data base.

It may well be reasonable to implement an application that connects to physical objects by having a world model, i.e., an explicit description of the world. This situation is really just an extension of the primitive presentation model proposed for the user interface. Here the world model data base is a representation of the outside world. Figure 2-8 shows this modularization of the implementation.

In this approach programs (and not only programs of the user interface system) deal with a data base describing the relevant parts of the physical world. Separately, the world model

Figure 2-8: World Model

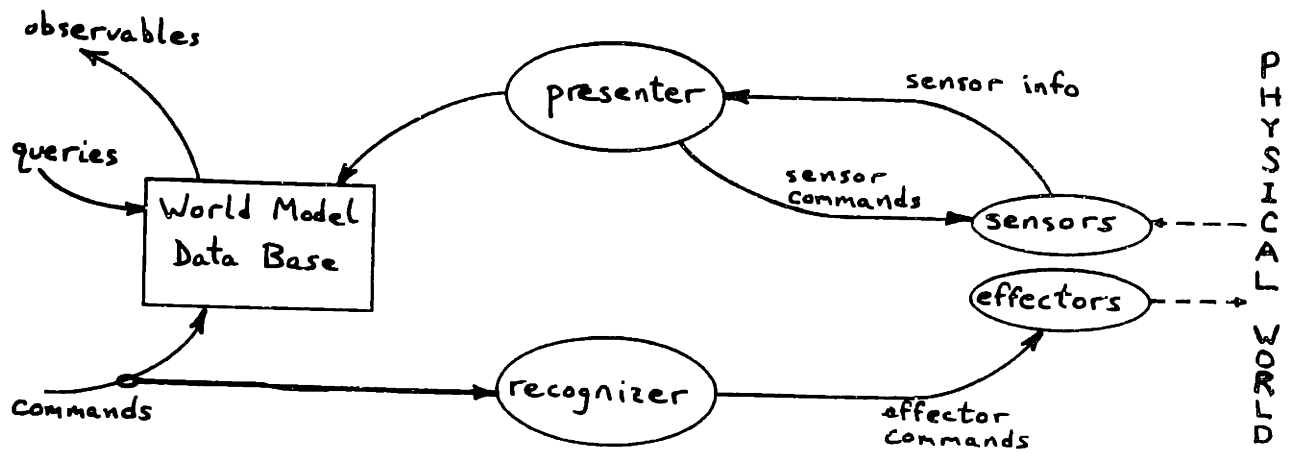

presenter and recognizer perform the job of keeping the world model up to date and effecting changes to the physical world as the world model is manipulated. The interface to the physical world is much like an interface to another data base. Instead of queries, there are commands to sensors; instead of data base observables, there is the information returned by those sensors. Instead of data base commands, there are commands to effectors, the hardware that performs some physical-world action.

Cascaded Interfaces. This approach to modularizing a system can just as well apply to the case where there is another data base, instead of the physical world. In this case one set of programs (user interface programs in the special case) view and manipulate one data base, which is a representation of a second data base, viewed and manipulated by another set of programs.

This is *not* a symmetrical communication between two groups of programs. The second set of data base programs are generally unaware of the first set -- the first data base is intended to serve as an extended interface to the second, i.e., main, data base. In the special case of the user interface, ideally the application programs are unaware or at least not dependent on the structure, style, or operation of the presentation data base and its associated programs.

As a final note on this asymmetry, consider the presenter and recognizer in the user interface. They are not under shared responsibility of user and application program -- *both are acting entirely for the user, under the user's control*. The entire user interface subsystem is an internal agent of the user, not an impartial intermediary between two equal communicators.

2.3 The Presentation Data Base

We now consider the other components of the PPS, those strictly within the user interface system. The presentation data base is the symbolic description of the screen comprising presentations and their properties and relations; it conveys information about the data base. Though it is not the purpose of this research to study in detail such representation issues,

this section will identify the basic properties of presentation structure that concern a presentation system.

The Simplicity of Two Data Bases. An interface containing two data bases, the presentation data base and the application data base, may at first seem to be more complex for the user than the rudimentary data base user interface discussed in chapter one. However, the situation for the user is actually much better in a PPS user interface.

Many of the details of the application data base's interface are hidden from the user. The application data base still has an interface of commands, queries, and observables, but the user does not deal with that interface -- only the presenter, recognizer and any outside programs do. The user is no longer concerned with the access and organization of the application data base -- the user deals only with the presentation data base.

The presentation data base has a more direct interface than the rudimentary data base model did. The presentation editor has taken the place of the command transducer. The commands for presentation editing are chosen to be convenient for the user. For example, they might include a base of general text-editing commands, so that the user does not have to learn a special language for a particular application data base.

Also, as mentioned above, the presentation data base is in a form directly viewable by the user. There is essentially no need for queries to the presentation data base, since the presentation is directly and continuously viewed. There are only a few vestigial queries, remaining in the form of viewing commands to scroll the screen, for example.

Name Presentations. Name presentations are the most fundamental of presentations, conveying no other information other than the identity of a data base object. Complex, structured presentations are built out of name presentations. In PPSCalc, column names (e.g., "A") are examples of name presentations presenting a particular column. Single digits are name presentations presenting the numbers 0 through 9. Formula operation symbols (e.g., "+") are name presentations presenting particular arithmetic operations.

Name presentations do not have parts or properties that are also presentations. A name presentation may have structure, e.g., smaller text or graphical forms that are part of it, but any parts are not in themselves presenting domain information. For example, from the point of view of a map, the letters in the name "Boston", while parts of the text string, do not individually present information.

Composite Presentations. Composite presentations, on the other hand, have graphical structure in which a larger presentation is constructed from smaller presentations. The composite presentation as a whole presents some domain information, and in addition some of its parts or properties present domain information as well. Generally, the hierarchical structuring of sub-presentations into a composite presentation follows a similar structure of the information in the data base. For example, the entire PPSCalc text table is a presentation of the spreadsheet. The presentation is composed of text string presentations for the values and formulas of cells, and those cells in turn are parts of the spreadsheet.

In PPSCalc the presentation "A2" is composed of the name presentations "A" and "2", presenting column and row. The presentation "A2" as a whole presents a particular cell or the value contents of it. Similarly the numeral presentation "75" is composed of digit presentations. However, the presentation "75" is generally not just a presentation of the number 75 -- in figure 2-2 on page 30, for example, it is a presentation of *the number in the A2 cell*, i.e., a presentation of a property of or fact about the A2 cell. It is the value of this property that is the number 75. The presentation style here presents the property by presenting its value. It is essentially a composite presentation composed of just one sub-presentation.

Composite presentations, as well as name presentations, may have parts or properties that are not in themselves presentations. For example, the overall PPSCalc presentation has the grid as one of its parts. The grid, however, is not a presentation. It serves a purpose in the overall presentation -- it makes the communication more effective -- but it is not itself presenting anything in the data base. It is a kind of template, in which presentations are placed. A common example of template presentations is a bibliographic reference, such as

"[Carroll65]". The brackets are a part of the composite presentation, but do not present anything. The parts "Carroll" and "65", on the other hand, are presentations.

Relations and Properties. Relations between presentations and properties of presentations can themselves convey information. Presentation style frequently imposes strong conventions on such "non-object" presentations. A relation between two presentations, such as nearness, alignment, or comparative size, can be chosen to convey information, frequently reinforcing information presented in some other way. A property of a presentation, such as its size, color, font, position, or direction, can similarly present information. The information presented by the property is usually very closely related to the information presented by the presentation form, just as composite presentation structure generally follows domain structure.

PPSCalc as shown above has no example of property presentations. However, if it were to display dependent values in a manner different from independent values, e.g., in a different font, the font of the text would be a property presentation. Many examples of property presentations can be found in road maps. A line, for example, presents a particular road, and the line's color presents the class of road (highway, street, dirt road). Frequently, a property presentation presents a property of the object presented by the presentation form. For example, the color of an area of a map may present the amount of rainfall in the geographical area presented.

One common relation presentation is alignment used to present some kind of similarity. In other words it shows that the domain objects presented by the aligned presentations share some common property. In the PPSCalc example, the fact that "75" is aligned with "100" above indicates that the cells whose contents are presented are both in the same data base column.

2.4 The Presentation Editor

The presentations can be directly edited by the user by means of the presentation editor. It allows the user to manipulate the forms on the screen, creating new forms or changing or deleting existing ones. It combines capabilities of a text editor with those of a graphics (diagram) editor. As changes are made, their results are immediately visible.

Graphics Redisplay. The screen is continually updated to reflect changes in the presentation data base, in a process called graphics redisplay. It is this process that involves traditional graphics (drawing) routines. Graphics redisplay is in effect another presentation system, taking the information in the presentation data base, expressed in terms of symbolic graphic forms (text, circles, lines, etc.), and converting it to a data base of pixels, for instance.

This thesis will not concentrate on this level of presentation system, for two reasons. First, it has been studied extensively elsewhere [Newman & Sproull 79] [Foley & Van Dam 82]. Second, it is usually not the level at which the user is interacting conceptually. The user typically does not think about or use commands that are defined in terms of pixels, but rather in terms of symbolic forms. These symbolic forms are the ones that present the application data base. A presentation style presents a number as text, for example, but it does not matter whether the graphics system chooses a bitmap or vector display technique to present that text on the screen.

2.5 The Presenter

The presenter process models the decisions and actions of constructing or updating a presentation. The presenter can be divided into three major parts, the domain collector, the semantic presenter, and the organizational presenter, as shown in figure 2-9.

This division of the presenter allows the identification and study of its basic functions and the interactions between them. They can be classified by the kind of knowledge the functions depend upon: knowledge about the structure of information in the application data base, knowledge about the mapping between domain information and the presentation

Figure 2-9: Presenter Parts

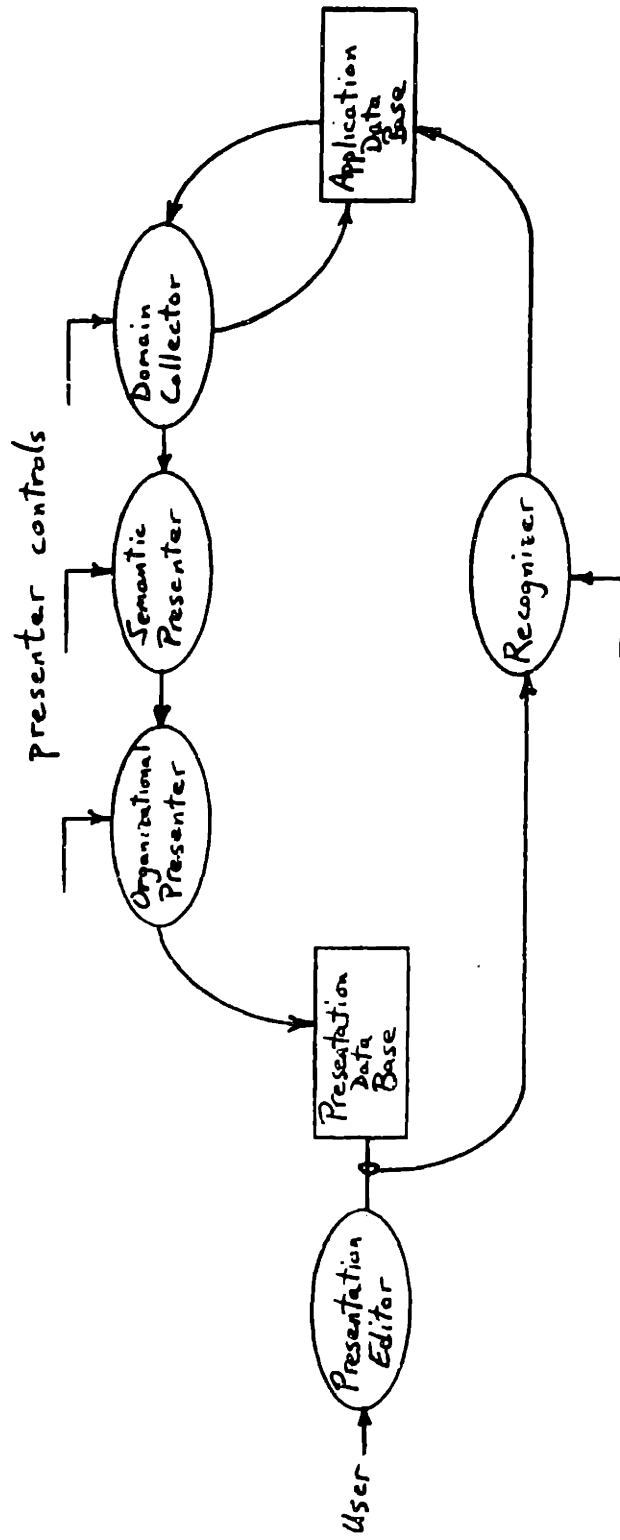

data base, and knowledge about purely visual considerations.

The domain collector finds and interprets the relevant part of the data base. The domain collector understands the organization of the application data base, the query language, and the format of the observables. It is the part of the presenter that connects with the data base. Given the specification of what is to be selected, it constructs the needed queries and passes them to the data base. The observables (or parts of them) are then assembled into the information needed by the semantic presenter.

The domain collector thus has knowledge about the kind of domain information that will be relevant for the user interface, and about the way that information is represented in the application data base. It does not, on the other hand, know anything about the way such information will be presented to the user. In PPSCalc the domain collector accesses the internal variables that implement the data base cells, collecting the formulas or cell values for use by the semantic presenter.

The semantic presenter embodies the primary mapping from data base domain to visual domain, the kind of mapping specified by a map legend, for example. It specifies the particular visual elements (text strings, circles, lines, etc.) to be used, and those relationships between them that directly convey data base information. It may partially specify some of these relationships, e.g., that some text string (a label) should be near some other object, leaving the organizational presenter to specify the exact position (taking into account purely spatial relationships, such as overlap and clutter).

In PPSCalc the semantic presenter converts the numeric values and formulas (formulas are stored in the data base as small programs) to text strings. It also creates the text strings that label the rows and columns.

The organizational presenter imposes purely visual organization on the presentation. The organizational presenter, unlike the semantic presenter and the domain collector, is domain-independent. It uses knowledge about spatial layout and, more generally, about improving the effectiveness of visual communication. It uses various tabular layouts, alignment,

positioning to avoid clutter, fonts, spacing, and highlighting. The semantic presenter might sometimes partially specify some of these, e.g., specifying that some text or graphic form should be highlighted. The organizational presenter, however, has the job of pinning down these specifications. It typically takes into account the other forms that will be on the screen. Once the semantic presenter has made its typically local decisions about visual styles, the organizational presenter reasons about the larger groups of forms and their visual interactions.

This view, that the presenter stages successively restrict the specification of the visual presentation, can be extended into the presentation data base itself. Part of the job of the presentation data base is to maintain a screen image reflecting the presentation information. As discussed in section 2.4, this is a task of traditional graphics packages. They too restrict the specification of the visual presentation, e.g., determining which pixels are to be set or choosing fonts if not otherwise specified.

In PPSCalc the organizational presenter uses a tabular layout for the overall presentation. The organizational presenter also is responsible for creating the table's grid. (Some much more intelligent organizational presenter might decide whether or not to use a grid, embodying various kinds of human factors knowledge. The decision is fixed in PPSCalc.) Within the grid cells, numeric values are aligned in one style (right ends of the number strings aligned), and formulas are aligned in another style (left justified in the cell).

One issue not discussed in chapter one is user control of the presenter and recognizer. The presenter has an input, called *presenter control*. This is a primitive command signal interface to the presenter that controls the style it uses and what it will present from the data base. In PPSCalc there is just one such control, a key that toggles whether formulas or dependent values are presented. In general, there may be different presenter control inputs, affecting the three components of the presenter.

2.6 The Recognizer

The recognizer process observes the user's editing of the screen presentations and interprets this as manipulation of the data base. As with presenters, recognizers are divided into three major parts, namely, the organizational recognizer, the semantic recognizer, and the domain changer, as shown in figure 2-10.

The **organizational recognizer** identifies the spatial relationships, presentations, and actions upon them that are relevant. It imposes a syntactic structure on these. Organizational recognition is generalized parsing. Text parsing is a special case; the more general organizational recognition works with text, graphical forms, visual properties and relationships, and editing actions. In general, the organizational recognizer is looking for changes to the presentation structure from the user's editing.

The **semantic recognizer** translates the syntactic structure into a semantic structure describing changes to the data base information. Generally this involves assigning interpretations to the text forms, graphic forms, spatial properties, spatial relationships, editing actions, and the syntactic relationships among these elements.

The separation of recognition of presentation structure from recognition of the semantic structure can be seen in the division of natural language parsers and compilers into syntactic and semantic modules.

The **domain changer** translates this description of changes into the actual data base commands necessary to effect those changes.

In PPSCalc the organizational recognizer, when considering the presentation structure for the presentation of the C2 cell's formula, for instance, starts by finding the position where this presentation is located within the grid presentation. It then parses the formula from the surrounding spaces and decomposes it into tokens (e.g., "A2", "*", and "B2"). The semantic recognizer converts this into the program required for the data base cell. The domain changer performs the actual modifications of the internal variables.

Figure 2-10: Recognizer Parts

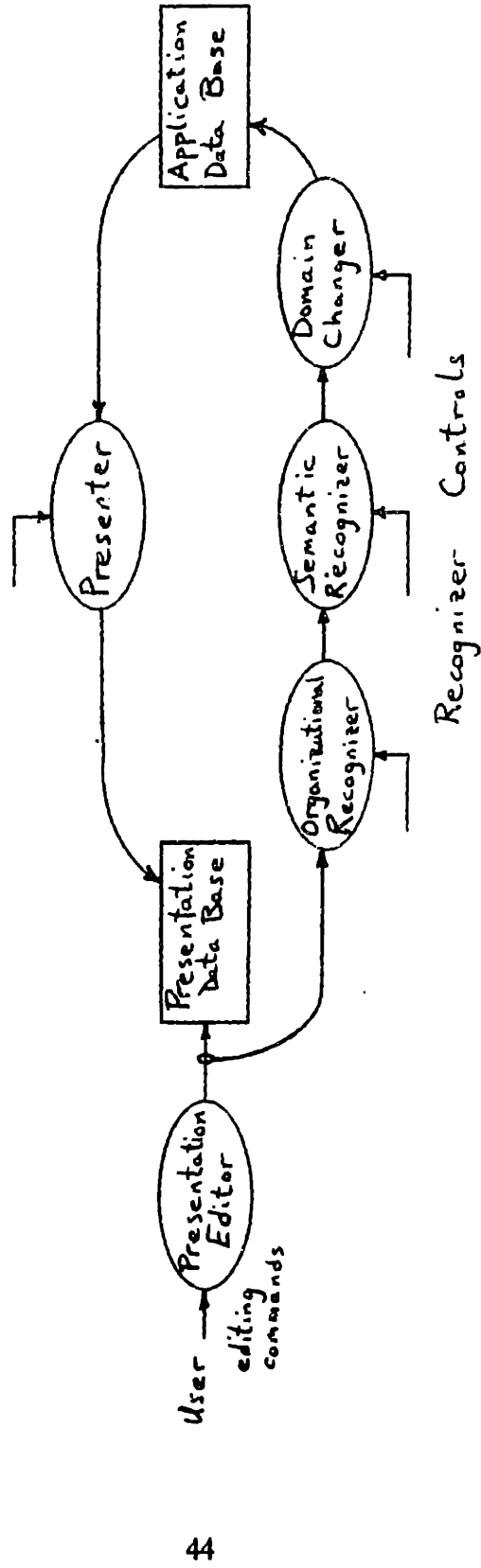

The PPSCalc example just given illustrates only a special case of recognition, namely recognition based on just the visible presentations, the results of whatever editing took place. This special case is very similar to the representation shift model discussed earlier, and is an inverse operation to that of the presenter. However, the more general kind of recognition takes account of the editing actions as well. Different edits that produce the same result might be recognized as different changes to the data base. (Whether such recognition is performed, or the extent to which it is performed, depends on the particular application and user community. But a general model should be able to account for such behavior.)

Consider some examples in PPSCalc. Suppose that the spreadsheet is currently in the state corresponding to figures 2-2 and 2-3 on page 30. The user is viewing dependent values, as in figure 2-3. Consider the possible recognition when the user moves the "2375" in the C3 cell to the A3 cell, e.g., by deleting the text in the C3 cell, and undeleting it into the A3 cell. The presentation that results is shown in figure 2-11.

	A	B	C
1	100	20	2000
2	75	5	375
3	2375		

Figure 2-11: PPSCalc -- Value Moved

One possible recognition style is similar to the representation shift model in that it only depends on the visible result. It would recognize this as two changes, first that the C3 cell become empty, and second that the A3 cell be given an *independent* value of 2375. This case is indistinguishable from that where the user typed "2375" into the A3 cell instead of moving that text into the A3 cell.

However, another recognition style might treat that move of "2375" as moving what the "2375" presents -- the dependent value computed by the formula $C1 + C2$. Thus moving

the "2375" from the C3 cell to the A3 cell might be recognized as the two actions, first that the A3 cell be given the C3 cell's formula C1+C2, and second that the C3 cell be emptied (as before). The visible result is as in figure 2-11 above. However, switching into the mode displaying formulas shows the different effect of the recognition:

	A	B	C
1	100	20	A1*B1
2	75	5	A2*B2
3	C1+C2		

Figure 2-12: PPSCalc -- Formula Moved

A similar kind of recognition, providing an effect found in commercial spreadsheet programs such as VisiCalc, is to recognize certain copy actions as meaning that the formula be partially copied -- but with changes based on the row or column. For instance, say during the initial creating of the spreadsheet the user had:

	A	B	C
1	100	20	A1*B1
2	75	5	
3			

Figure 2-13: PPSCalc -- Preparing to Copy Formula

If the user now uses a copy-with-changes command to copy the "A1*B1" formula presentation from the C1 cell to the C2 cell, recognition would interpret this as putting the formula A2*B2 into the C2 cell. (The references to row 1 have been changed to row 2.)

Reference and Recognition. An important class of presentation editor commands are those providing the user with the ability to refer to text, graphic forms, areas, or positions on the screen. Examples include pointing devices such as tablets and "mice." There are other

possibilities, such as using arrow keys to move a pointer around the screen, or keyboard commands that refer to positions, quadrants, etc. by name or coordinates. The reference capabilities provided by a pointing device can be extended by tracking the pointer, thus achieving the ability to refer to areas or groups of forms, for instance. Although reference does not change the visible presentations, it is an important editor action since it undergoes recognition.

PPSCalc could be extended to include reference recognition. For example, a reference to an independent value presentation could be recognized as a command to increment that value. As another example, a reference to a cell containing a formula and then to a blank cell could be recognized as a command to copy the formula to the second cell. (This could perhaps include changes to accommodate different columns and rows as mentioned earlier).

When Recognition Happens. In the PPS model recognition happens continually and is in effect over the entire screen (i.e., over the entire presentation data base). The intent is that the screen continually present the state of the data base, providing the user with direct manipulation of the data base by continual presenter and recognizer action. Some presentation editor command sets may allow such continuity at the granularity of single commands, i.e., allow recognition to happen after every single command. However, in general there may be groups of commands that, taken together, form a larger atomic unit from the recognizer's point of view.

For instance, in PPSCalc the recognizer is not be able to act upon a partially typed, syntactically incomplete formula such as ") + A2". (It would be possible, though, to have a more tolerant organizational recognizer -- in this case parser -- that allows this string and assigns some sort of interpretation to it, such as the interpretation for "(0) + A2".) In PPSCalc typing the return key signals the end of an atomic edit. After each return, the recognizer is invoked, the data base changed, the presenter invoked, and the presentation data base updated.

Recognizer Controls. Figure 2-10 on page 44 shows *recognizer controls*, a primitive command signal that affects the operation of the recognizer. In PPSCalc a single-key

command toggles how the recognizer will treat edits of a dependent value (for the mode when dependent values, not formulas, are displayed). One choice is to treat the edit as an error and just ignore it. The other choice is to treat the edit as changing that cell to be an independent cell with that value. (The formula is erased.) In general, there may be recognizer control inputs for each of the recognizer components.

2.7 The Representation Shift Model and Direct Manipulation

The representation shift model, introduced in chapter one, is a special case of the PPS model. It is shown in figure 2-14. In the representation shift model, the presentation data base contains all and only the information in the application data base. As a result, the presenter and recognizer have simpler, more restricted tasks. The presenter gets a representation of the entire application data base, converts it, and loads the entire presentation data base. The recognizer has the opposite operation: the recognizer gets a representation of the entire presentation data base, converts it, and loads the entire application data base.

The representation shift model and the PPS model embody different metaphors. In the representation shift metaphor the presenter creates a picture of the data base. The user edits the picture. At the end of an atomic edit, the recognizer makes the data base be what is depicted. In the PPS metaphor the presenter creates a picture of typically a small view of a subset of the data base. The user edits the picture. The recognizer watches how the user makes the changes and changes the data base in the same way.

In the representation shift model, the presentation data base must contain all the information in the application data base. This is equivalent to saying that the entire application data base be viewed. (And because of this restriction, the converter can simply load the entire application data base from its translations of the presentation data base.) This restriction can be inefficient for large data bases or when rapid user interaction with the application is desired. The restriction is unacceptable when the size of the data base gets so large that the time to perform the translation cycle between the application and

Figure 2-14: Representation Shift Model

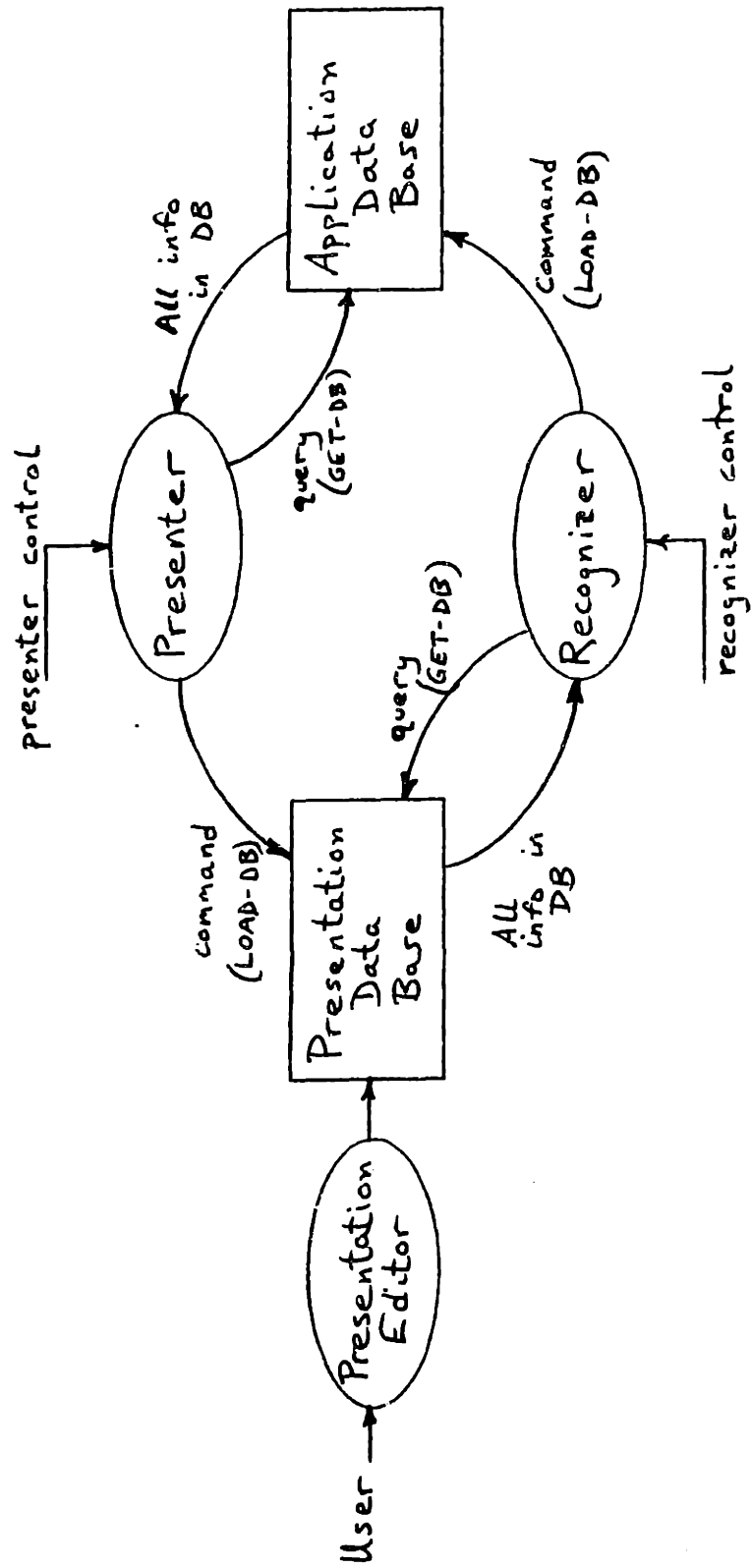

presentation data bases is slower than the desired interaction time. It also leads to inconvenient visual clutter; the user cannot view just a relevant portion of the data base. This is a serious problem for complex data bases. The ability to control the selection of information to be viewed and the way it is to be viewed can be crucial. However, for small application data bases, the representation shift model can be advantageous by virtue of its great simplicity.

Because of the no-formula display mode, PPSCalc is not presenting all the information in the application data base. (The data base is the collection of spreadsheet cells). PPSCalc is therefore not simply a representation shift user interface, and must be modeled with the full PPS model. However, if the display of spreadsheet cells were modified to show *both* the formula and the value, PPSCalc could be modeled as a representation shift interface.

Because of the restriction that the presentation data base convey all the information in the application data base, the representation shift model has another difference from the PPS model -- the representation shift recognizer need only look at the current state of the presentation data base, not the sequence of editing operations that produced it. The editing operations cannot matter: if two editing actions result in the same visual data base state, they must be equivalent.

For example, there can be no difference between (1) moving a presentation from one place to another and (2) first deleting that presentation and then creating at the second position a new presentation that looks exactly like the first one. Similarly, there can be no such thing as renaming an object by editing its name. Editing its name must be equivalent to deleting the object and then creating a new one with the second name. In fact renaming really has no meaning for the application data base, since it is produced completely from the recognizer's data. In other words, *all* the objects are created anew.

For the full PPS model we assume that the presentation data base conveys only a subset of the information in the application data base, often a small subset. The representation shift model can be slightly extended to apply to some cases of subset presentation. When the subset of the application data base is *separable* from the rest of the application data base,

i.e., there are no references into or out of the subset, the presentation data base can show all the information of that part of the application data base. In effect, that subset is being treated as an entire application data base in its own right.

The restriction of the PPS model that produces the representation shift model can be summarized by examining the functions between the presentation and application data bases, as defined by the presenter and recognizer operations. Define the *presenter function* to be the mapping of presentation data base states from application data base states as produced by the presenter. Similarly, define the *recognizer function* to be the mapping of application data base states from presentation data base states as produced by the recognizer.

The presenter function must be invertible, so that the presentation data base conveys all the information about the application data base. The recognizer function is an extension of the presenter's inverse. The recognizer generally extends the inverse for the convenience of the user: the user can create any of several variations on the form that the presenter would have chosen. For example, the PPSCalc recognizer allows latitude in positioning of formulas within cell presentations, even though the presenter always aligns the formulas with the left edge of the cell. We can say that there are generally sets of presentation data base states that are equivalent: the presenter produces only one of these states, but the user and the recognizer interpret the others as conveying the same information.

In the PPS model, however, the presenter and recognizer functions are of a different nature, because of the need to allow operations on only partial presentations. The major difference is that the domain of the recognizer function is not the range of the presenter function. The presenter maps from application data base to presentation data base. The recognizer, however, maps from sequences of presentation editing commands to sequences of data base commands. Figure 2-15 shows a schematic form of the PPS model that highlights these mappings.

A restriction is placed on the decoupling of the presenter and recognizer functions in the full PPS model. This restriction gives the PPS model a direct manipulation style similar to

Figure 2-15: Functional Mapping in the PPS Model

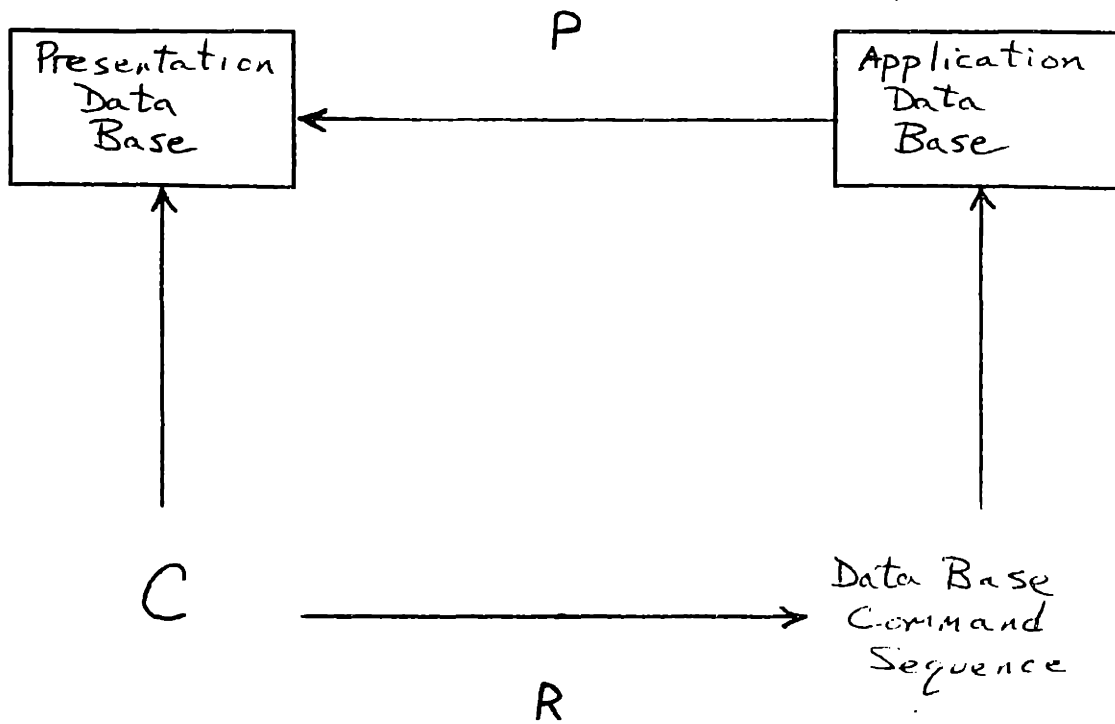

the style of the representation shift model. The restriction can be stated by expanding the notion of inverse presenter and recognizer functions, as discussed for the representation shift model:

Consider sequences of presentation editing commands as functions, mapping one presentation data base state to another. Similarly, sequences of data base commands map one application data base state to another. If P is the presenter relation, R is the recognizer relation, and C is any particular atomic presentation editing command sequence, the restriction can be stated in the following form (using "*" for function composition and "==" for equivalence of two presentation data base states due to recognizer tolerance):

$$C * P == P * R(C)$$

In other words, the editing commands C acting on a presentation data base created by the presenter P should result in the same presentation data base as would result from the presentation of the application data base that results from recognition of those editing commands.

There are interfaces where the style of recognition is very different from the style of presentation -- i.e., the above rule is not even approximated. In such an interface the editing action may directly but temporarily result in a presentation data base state very different from what the presentation data base will be after recognition and presenter update. This thesis does not attempt to argue whether such a user interface style is good or bad, nor does the restriction on the PPS model eliminate such a user interface from consideration. Rather, the restriction changes the way the user interface would be modeled -- it cannot be modeled as a PPS. The techniques discussed in chapter three can be used, however, to model such a user interface as an extended presentation system. In particular it will be modeled as a combination of one PPS capturing the presentation and another PPS capturing the recognition. By modeling the user interface as an extended system, the very different nature of presentation and recognition is highlighted.

•

Chapter Three

Constructing Larger Presentation System Models

This chapter shows how the primitive presentation system (PPS) model can be extended to model more complex presentation systems. Chapter four contains several examples of complex presentation system models of existing user interfaces. The basic technique for extending a presentation system model is to attach an additional presentation system to it, either replacing or augmenting some part of it. The resulting presentation system may thus contain several smaller presentation systems. The particular extensions discussed in this chapter are suggested by an examination of the major limitations of the PPS model:

- * The user can only make *immediate changes* to the data base -- there is no planning.
- * The user can only see the *current state* of the application data base resulting from the commands to change it -- there is no presentation of the commands themselves or the differences between states.
- * The user can only interact with the presentation editor, presenter, and recognizer through *primitive signals* -- there are no presentation system interfaces to these components.

Each of these limitations suggests a particular extension. The limitations and the extensions are discussed in the following sections.

3.1 Adding a Planned Data Base

The first major limitation of the PPS model is that it only allows immediate changes to the application data base. In the PPS model, as the user edits the presentation, continual recognition causes the application data base to change accordingly. This can be inconvenient if the user would like to see what the result looks like before committing to it. Immediate change can also be a more serious problem if the application data base changes

are irreversible. This is often the case when an application program or physical process is being controlled through the data base. Therefore, if the presentation system model is to support the construction of user interfaces where the user can postpone the effects of commands -- i.e., where the user can *plan* changes -- the PPS model must be extended.

One method of postponing changes is to add a new, second, data base that is a future (i.e., planned) version of the original data base. This is illustrated in figure 3-1. The user can edit the planned version's presentation, separate from the presentation of the actual data base, and when the planned version looks acceptable, give a "do it" command that causes the actual data base to be updated. The "do it" command, like the other commands affecting the application data base, emanates from the recognizer. The user may cause this to happen either by a direct recognizer control signal or by performing some presentation editing command that is recognized as a "do it."

In general the planned version of the application data base will behave similarly to the actual data base, ideally reproducing all the active components. For example, in PPSCalc a planned data base ideally would include all the recalculation capabilities of the actual data base. When this is the case, the user does not lose power or convenience in manipulating the planned version over what the user would have had manipulating the actual data base.

As with the other extensions discussed in this chapter, this is only an illustration of the technique of extending a presentation system to achieve some goal. This extension technique may be used in combination with other presentation system structures.

For example, figure 3-2 shows a combination of the straightforward PPS model and the future data base model discussed above. This combination allows the user to have two presentations at once, one showing the future version of the data base, the other showing the current version of the data base. With two separate presentations and presentation editors, the user can interact with both, planning some changes and effecting some changes immediately.

Figure 3-1: Planned Data Base Extension

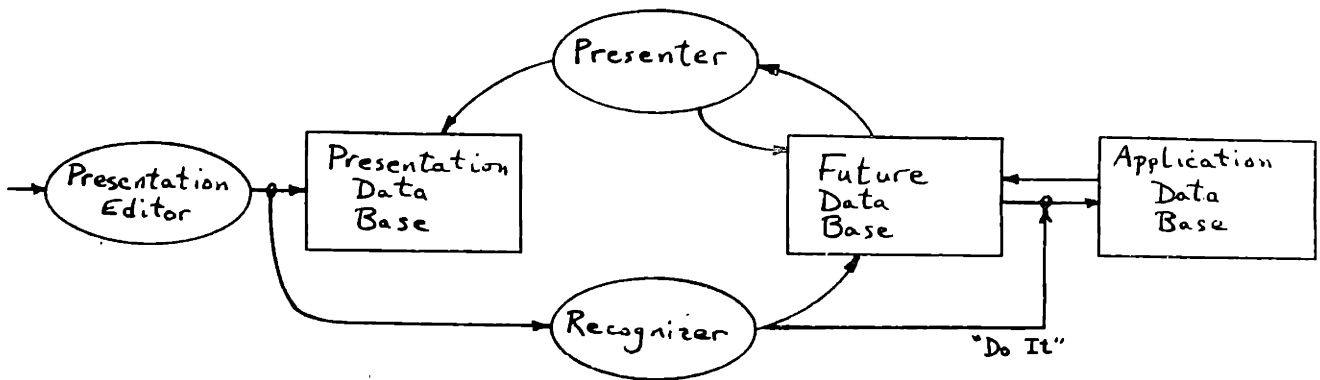
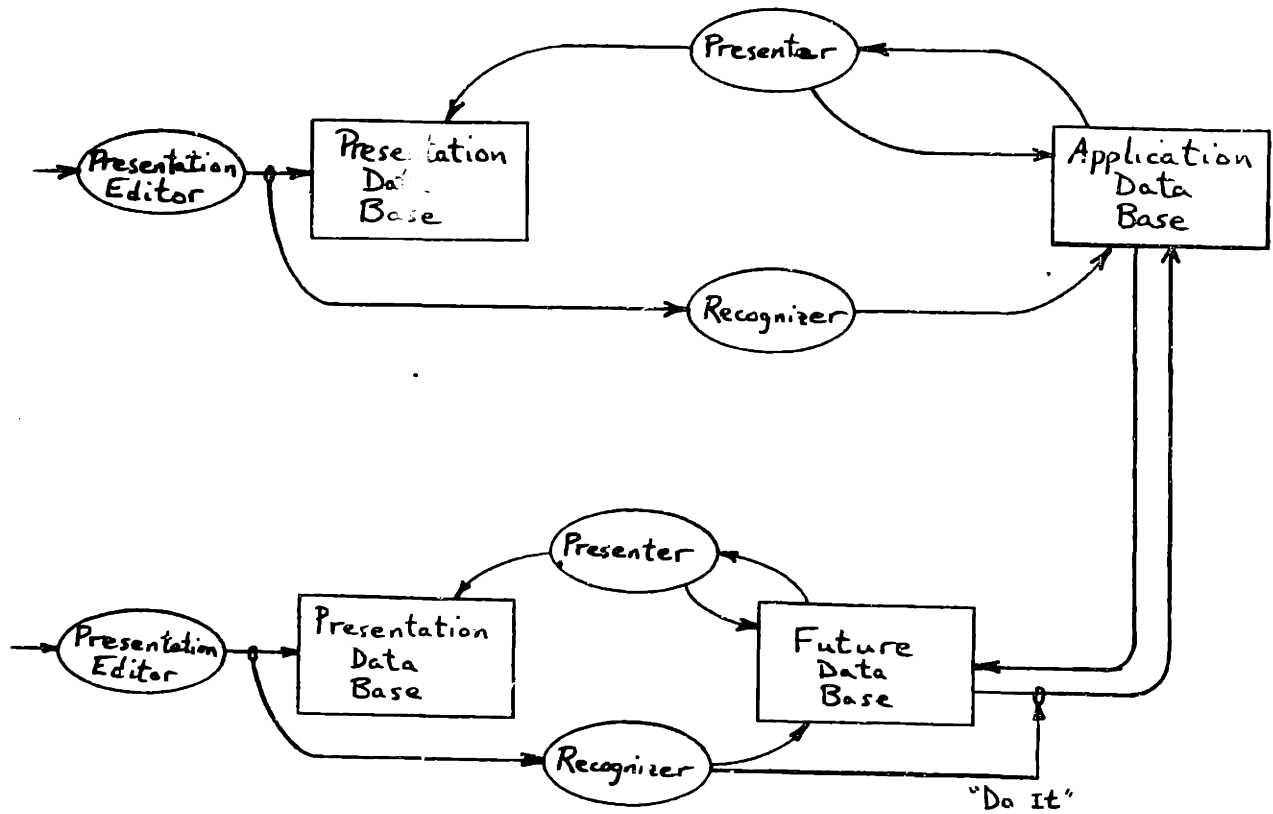

Figure 3-2: Extension with Both Planning and Immediate Changes



3.2 Adding a Data Base of Commands

The second major limitation of the PPS model is that the user cannot see a description of the changes or the commands to effect them presented explicitly. The PPS model offers the user a feeling of direct manipulation of the application data base contents. However, it is sometimes safer or more convenient to see and edit a command or a description of the change to be made. So, although direct manipulation is becoming more and more common and is undeniably useful, a complete model must support the construction of interfaces in which change is described or seen. Some systems may offer a combination of direct manipulation and command editing. Others may offer the ability to see or prescribe the kinds of changes desired -- goals -- without specifying the particular operations needed to achieve these goals.

Instead of adding a planned version of the data base, with content and presentation style mirroring the actual data base, a data base of the plans or commands themselves can be added. In this extension, the planned changes are represented in the new data base explicitly and can be presented in a style different from that of the actual data base.

Figure 3-3 shows an extended presentation system in which the user can interact with the application data base *directly*, via the PPS at the top of the figure, and also *indirectly*, by giving commands to the application data base via the PPS at the bottom of the figure. The bottom PPS has a data base containing commands for the application data base above. The user can see and edit these commands presented in the presentation data base in the bottom PPS. When the user gives the "do it" command, these data base commands are passed to the application data base.

Thus this extension also gives the user a planning capability, and is similar in structure to the previous extension in that a new data base has been added as a buffer. The difference is that the data base in this case has commands, whereas in the previous case it was a copy of the application data base.

As in the future data base extension, the figure shows two copies each of the presentation

Figure 3-3: Command Data Base Extension

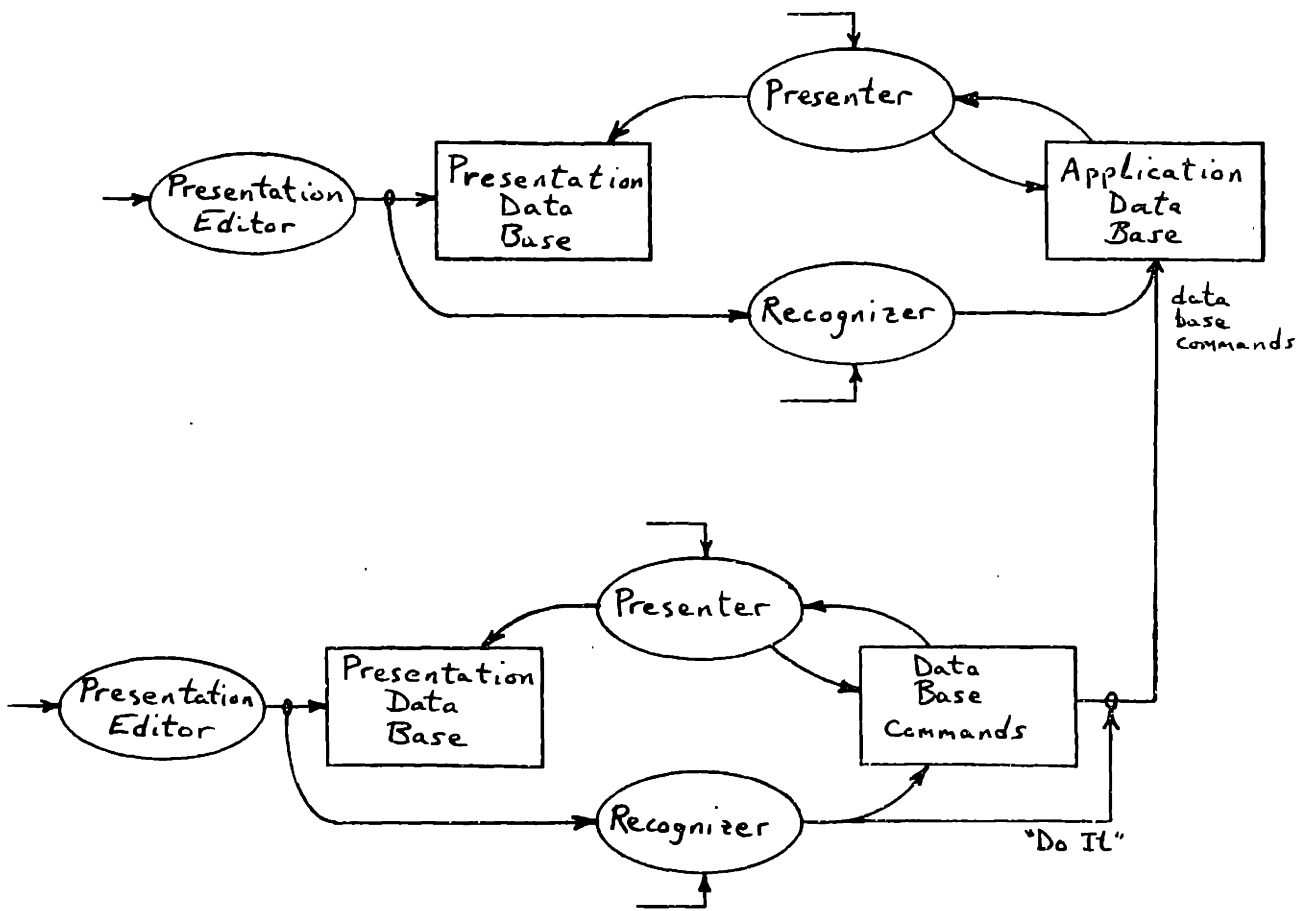

editor, presentation data base, presenter, and recognizer. Though their general purpose is the same and they are labeled the same, they are in general different. In this extension this is especially the case for the presenters and recognizers. The application data base in the top PPS, and the data base of commands in the bottom PPS, have very different kinds of information in them. The presentation and recognition styles will therefore in general be quite different.

3.3 Adding Interfaces to PPS Components

The third major limitation of the PPS model is that the presentation editor, presenter, and recognizer are not presented. The user controls them through presentation editing commands, presenter controls, and recognizer controls. There are two aspects to this problem in the PPS model:

First, these controls are only *primitive signals*, such as keystrokes. There is no ability to see the commands the user is typing, edit them, or get help in their use. The only thing being seen and edited (i.e., presented) is the application data base.

Second, the user must give *commands* to affect the editor, presenter, and recognizer. The user cannot directly see the state of those processes, their modes, control variables, etc. As the user interface becomes more powerful and complex, the user interface components, as well as the application data base, become important objects to present. The text editor Emacs, for instance, has nearly fifty options variables in its simplest, initial form. Many systems have many option variables controlling presenter style, modes, etc.

Instead of primitive signals to control the presentation editor, presenter, and recognizer, and no ability to present their state, PPS interfaces to these components can be added. This involves adding a data base for the particular component's state (e.g., a data base of the presenter's options controlling its visual style) or using the previous technique of adding a data base for the component's commands.

Figure 3-4 shows one such interface, providing a representation shift interface to the

Figure 3-4: Presenter Interface Extension

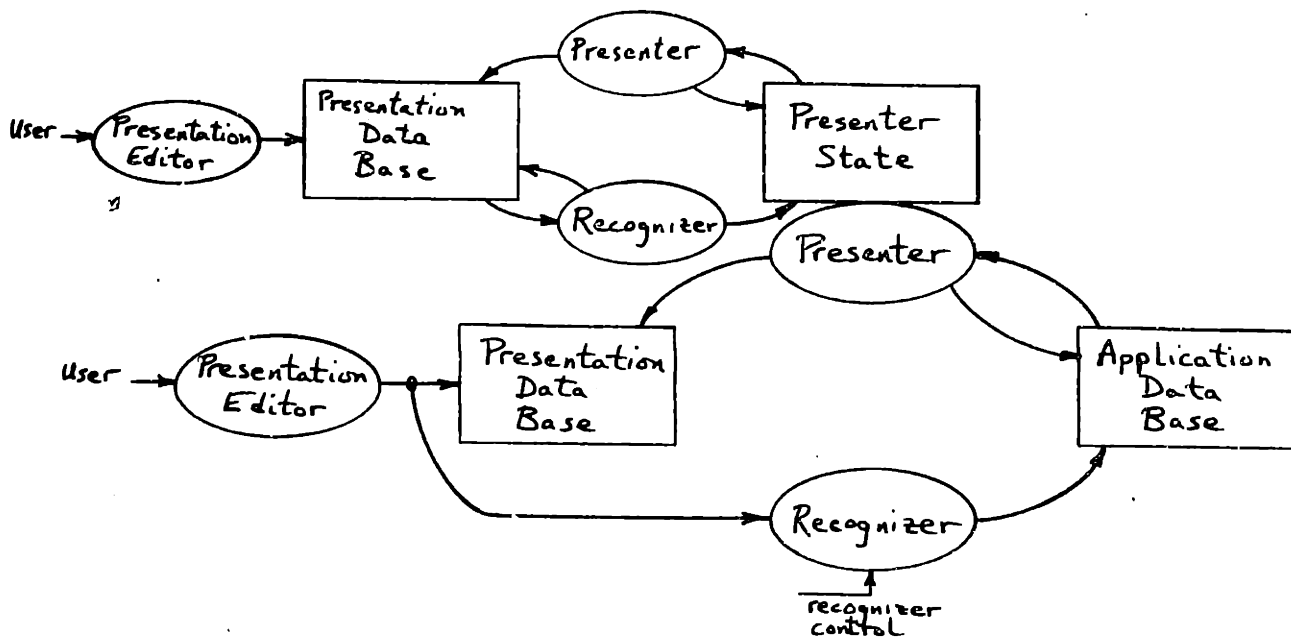

presenter. The presenter's state has been expanded into a data base presented by the representation shift presentation system at the top. As with all the additional presentation systems in this chapter, there are many possible presentation systems that could be added. A PPS could have been used instead of the representation shift, for example.

In this extended presentation system the user can interact with the application data base, via the main presentation system at the bottom. The user can also interact with the presenter, via the presentation system at the top, which has replaced the original presenter control input. The user can change the way the presenter behaves by editing the presenter's state presentation. For instance, this might include changing the amount of detail shown in the presentation of the application data base. It might include changing how the presenter shows different kinds of domain information, e.g., whether tables or graphs are used. Finally, it might include changing what parts of the application data base are being presented. (Recall that the PPS model allows that the application data base to be only partially presented.)

Figure 3-5 shows an alternative extension for controlling the presenter. Here, instead of editing the presenter's state, the user edits commands to the presenter, just as in the previous section the technique was used to allow the user to give commands to the application data base. The top presentation system (again a representation shift model, but as before it could be any kind of presentation system) hooks directly into the presenter control input to the presenter.

This technique of adding a presentation system to allow the user to interact more conveniently with the presenter can be applied to the other presentation system components as well, e.g., to the presentation editor and recognizer.

3.4 Shared Screen Space and Presentation Structure

This section examines three kinds of sharing that can occur in presentations systems. In general, sharing occurs when some part of a presentation system, e.g., a particular part of the screen space or a particular presentation, simultaneously fulfills two different roles. There

Figure 3-5: Presenter Commands Extension

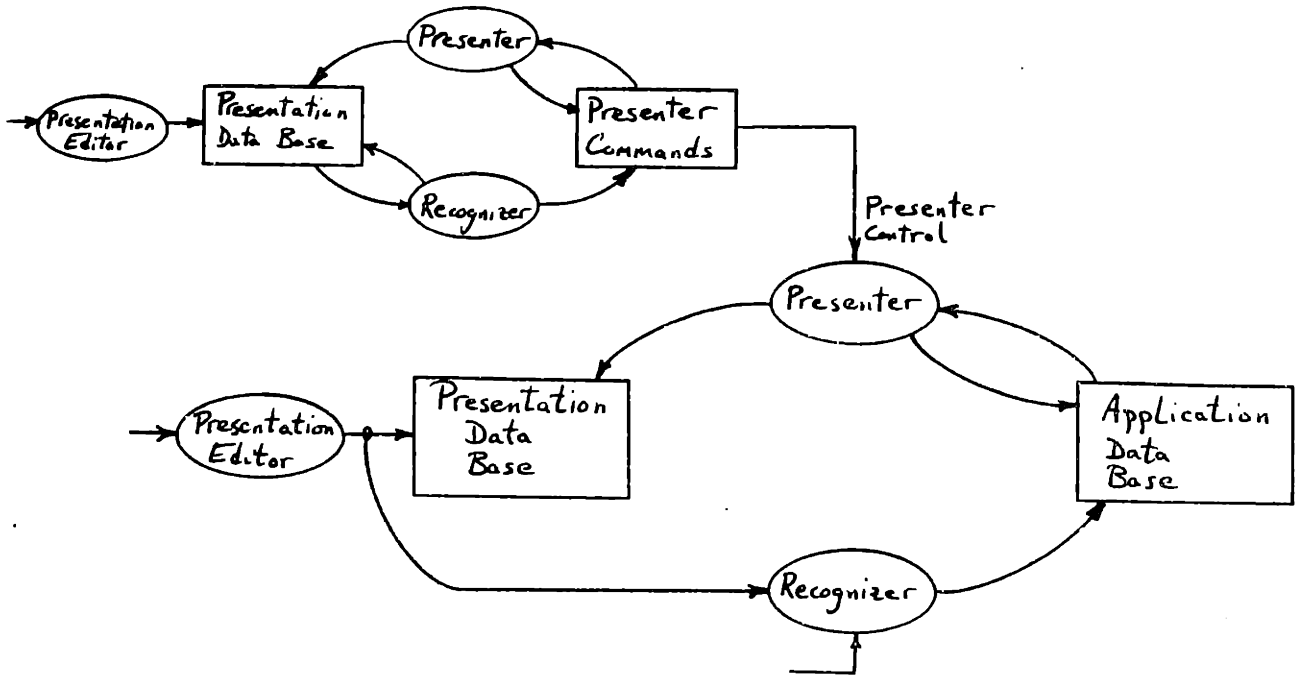

are tradeoffs between benefits of compactness and costs of ambiguity.

The first kind of sharing is sharing of screen space between two presentation systems, e.g., two PPS components in a larger, extended presentation system. Presentations that conceptually belong to the different presentation systems are often intermingled within the same space. For example, in the Emacs Dired system to be discussed in section 4.1, a directory listing (a presentation in one PPS) is annotated with "D"s, which are presentations of plans to delete files and which belong to a separate, command-planning PPS. This is contrasted with an interface that has two such presentation systems occupying completely separate areas of the screen, e.g., different windows.

The second kind is sharing of one presentation form between two presentation systems. The shared presentation presents two different pieces of information, in the two different application data bases. Consider, for example, a directory listing. An interface could use a directory listing for more than just presenting a directory: it could also use it as a means of controlling the directory listing presenter. The user could trim the directory listing to inform the presenter that certain files should not be included. This editing, and recognition of it, conceptually occurs in a separate PPS. The directory presentation is shared between the two PPSs. In the presenter-control PPS, the directory listing functions as a presentation of the presenter's state.

A third kind is sharing of one presentation between two presented domain objects in one PPS. This occurs when one domain object is presented in order to present another domain object. A typical case is presentation of a file's creation-date property in a directory listing. To present the property, the *value of that property* is presented, namely, the particular date. (And the process may continue: to present the month property of the date, the particular month is presented.) Thus, a single presentation form (e.g., the text "3/4/83") presents both the creation-date property and the particular date (3/4/83) that satisfies that property.

Sharing of screen space or presentation structure can provide convenience to the user because it results in a compact presentation. Sharing can achieve what might be called *visual locality*: two presentations of related domain objects are located near each other.

Unfortunately, sharing can also lead to ambiguity, both for the user and for the implementor. The user may not know which editing functions apply to presentations shared between two presentation systems. When screen space is shared, the user may not know what kind of recognition to expect when editing the different presentations. The implementation must also keep the two kinds of presentation distinct, so that the proper editing and recognition happen to each. When presentation structure is shared, the user may not be aware how presentation editor functions are recognized differently by the recognizers in the two presentation systems. The implementation must include a means for selecting the recognizer based on the kind of editing performed. The ambiguity is most severe when the capabilities of the presentation editors overlap. The choice between the two recognizers then must depend on context or user choice.

The designer should identify ambiguities in the proposed presentation system, and decide which ones to resolve. Such a decision must take into account the prospective users, conventions in the style of the interface, the particular tasks to be performed, and the application domain. Sharing might be eliminated. Conventions might be imposed on the kinds of sharing and the methods of user or system resolution.

However, regardless of the outcome of the decision, the designer must consider that there is always *ambiguity due to potential sharing*. The user cannot tell, merely by viewing the directory listing, whether deleting a line in a directory listing, for example, will mean *don't present that file* (manipulating the presenter), or whether it will mean *delete the file* (manipulating the application data base). Ambiguity of presentation structure, unlike ambiguity of shared space, is an inherent possibility of the view. Resolving an ambiguity by eliminating sharing of presentation structure does not make the presentation appear different. (However, another presentation may be introduced nearby to perform the eliminated function.)

Sharing of presentation structure *within* a PPS, such as arises from presenting a property by presenting its value, is less troublesome. Its ambiguity can be resolved by the recognizer, by deciding which of the possibilities is appropriate for the command being recognized.

For example, if user editing of the creation-date presentation for a file is recognized as a change command, then only the creation-date *property* fits the recognition -- one cannot change a date. (By changing the property, one is *selecting* a different date to be the value of the property. The original date value is left unchanged.) This technique is offered by the PSBase system, and so further discussion of this technique appears in section 5.1.

3.5 Concluding Remarks

This chapter has discussed only a few examples of how presentation systems can be constructed by hooking primitive presentation systems together. There are many more possibilities, including combining these extensions and creating new kinds of extensions using similar techniques. (For example, a system might offer cascaded presentation systems, presenting the presentation data base.) In modeling actual user interfaces, the next chapter illustrates several of these possibilities.

Chapter Four

Describing Presentation Systems

This chapter illustrates the use of the presentation system model as a descriptive tool. The model provides a set of concepts for enumerating and categorizing basic functions and interactions in user interfaces, whether or not those interfaces were designed with this model in mind. The behavior of four different user interfaces will be described in terms of the presentation system model. In each example the focus will be on those presentation system mechanisms that play the most important part in defining the style of interaction.

A secondary aim of this chapter is to offer support for claims of the model's generality, i.e., that the model applies to a wide range of user interfaces. The selection of user interfaces described here has been chosen to show the descriptive process by example. The reader should then be able to apply this process to other interfaces and thereby gain confidence in the model's generality.

The selection thus emphasizes different approaches in user interface techniques. At the same time, an effort was made to choose user interfaces that exemplify different aspects of user interface research and development. Part of that effort was an informal poll of people involved with developing, studying, or just interested in user interfaces. They were asked to name three "exemplary user interfaces." The interfaces used in this chapter all have followers. There were many favorites and strong opinions, but nothing near a consensus except on the Xerox Star [Purvy, Farrell & Klose 83] [Smith, Irby, Kimball, Verplank & Harslem 83] and Apple Lisa systems [Lisa 84].

PPSCalc was discussed and modeled in chapter two. Because PPSCalc is a simple version of VisiCalc [Beii 82], VisiCalc has already been treated to some extent. Actually modeling VisiCalc would involve describing extensions to the main PPS. Such extensions will be suggested by those used in modeling the user interfaces of this chapter. To avoid this

redundancy, VisiCalc or other spreadsheet programs will not be discussed further.

4.1 Emacs Dired

Dired is a subsystem of the Emacs editor that allows the user to perform several directory operations by manipulation a directory listing. The version of Dired described here is the one in Emacs on the ITS operating system [Stallman 81].

Dired is an extended presentation system, allowing both immediate changes to the application data base (the file system directory) and planned operations. Annotations to the directory's presentation present the planned operations. Dired has two other component presentation systems. One recognizes presentation editing as changing the state of the presenter. The other confirms the user's planned operations by offering an alternative presentation of the planned operations.

Dired Scenario. The following scenario will illustrate the use of Dired. After the scenario, the presentation system model of Dired will be discussed.

The user invokes Dired, initially viewing the full directory listing shown below:

```
MC   NSR
FREE BLOCKS #0=1666 #1=625 #13=1163 #15=1461 #14=1549 #16=1149
 0  BABYL  BUGS    26 +486    4/02/84 14:09:26 (4/02/84) .MAIL.
13  BABYL  INFO    27 +488    8/31/83 14:37:09 (11/16/83) .MAIL.
L   FIXLIB 209      ==> EMACS1;FIXLIB > (5/06/83)
13  MAINT  BABYL    5  +27     2/18/84 17:01:42 (3/01/84)
 1  QUEUE  NOTES    2  +83     3/10/84 10:20:13 (3/23/84)
 1  TEST   VALUES  0  +69     1/17/84 19:20:14 (4/03/84)
 1  TMSG   2        1  +34    $ 3/28/84 11:03:39 (4/03/84)
 1  TMSG   3        1  +20    ! 4/03/84 21:53:21 (4/03/84)
 1  TMSG   4        1 +248    ! 4/03/84 21:57:45 (4/03/84)
 1  TMSG   5        2  +94    ! 4/03/84 22:14:15 (4/03/84)
 1  TMSG   6        2  +86    ! 4/03/84 23:34:36 (4/03/84)
L   TS     NSRMAC  ==> NSR;TSNSRM > (2/24/84)
15  TSNSRM 1320    13 +463    8/19/83 20:44:23 (2/24/84)
```

The user wishes to restrict attention to those files that might plausibly be deleted or moved to a secondary disk pack. In particular, several files are related to the maintenance of the mail reader Babyl and should definitely not be considered for deletion. Using the

Emacs command Delete Matching Lines, lines containing the text "BABYL" are re
 This does not delete those files -- it only affects the view the user has of the direc
 resulting in the trimmed directory listing shown below:

```
MC   NSR
FREE BLOCKS #0=1666 #1=625 #13=1163 #15=1461 #14=1549 #16=1149
L   FIXLIB 209      ==> EMACS1;FIXLIB >          (5/06/83)
1   QUEUE  NOTES    2  +83    3/10/84 10:20:13 (3/23/84)
1   TEST   VALUES  0  +69    1/17/84 19:20:14 (4/03/84)
1   TMSG   2        1  +34   $ 3/28/84 11:03:39 (4/03/84)
1   TMSG   3        1  +20   ! 4/03/84 21:53:21 (4/03/84)
1   TMSG   4        1 +248   ! 4/03/84 21:57:45 (4/03/84)
1   TMSG   5        2  +94   ! 4/03/84 22:14:15 (4/03/84)
1   TMSG   6        2  +86   ! 4/03/84 23:34:36 (4/03/84)
L   TS     NSRMAC   ==> NSR;TSNSRM >           (2/24/84)
15  TSNSRM 1320     13 +463   8/19/83 20:44:23 (2/24/84)
```

Deciding that the file named "QUEUE NOTES" is no longer needed, the user moves the Emacs cursor to that line in the directory and types a "D", marking that file for deletion. The file marked for deletion is shown by annotating that line in the directory listing with a "D". There are several versions of the "TMSG" file, and using the "H" (Delete Help) command instructs Dired to mark old versions for deletion. The "H" command generally marks all but the two most recent versions. However, in this case the version "TMSG 2" has a property protecting it from automatic deletions or migrations to tape (indicated by the "\$" in the listing). Dired will therefore leave that version alone. The resulting directory listing is shown below:

```
MC   NSR
FREE BLOCKS #0=1666 #1=625 #13=1163 #15=1461 #14=1549 #16=1149
L   FIXLIB 209      ==> EMACS1;FIXLIB >          (5/06/83)
D 1  QUEUE  NOTES    2  +83    3/10/84 10:20:13 (3/23/84)
1   TEST   VALUES  0  +69    1/17/84 19:20:14 (4/03/84)
1   TMSG   2        1  +34   $ 3/28/84 11:03:39 (4/03/84)
D 1  TMSG   3        1  +20   ! 4/03/84 21:53:21 (4/03/84)
D 1  TMSG   4        1 +248   ! 4/03/84 21:57:45 (4/03/84)
1   TMSG   5        2  +94   ! 4/03/84 22:14:15 (4/03/84)
1   TMSG   6        2  +86   ! 4/03/84 23:34:36 (4/03/84)
L   TS     NSRMAC   ==> NSR;TSNSRM >           (2/24/84)
15  TSNSRM 1320     13 +463   8/19/83 20:44:23 (2/24/84)
```

Next, the user moves the file named "TEST VALUES" from the primary to the secondary disk pack with the "S" command, changing the line

```
1 TEST VALUES 0 +69 1/17/84 19:20:14 (4/03/84)
```

to

```
13 TEST VALUES 0 +69 1/17/84 19:20:14 (4/03/84)
```

The leftmost "1" and "13" in these two lines indicate the disk pack numbers (0 and 1 are primary packs, 13 is the secondary pack). The "S" command takes effect immediately, moving the file to the secondary pack when the "S" is typed. In this respect, the "S" command is unlike the "D" and "H" commands, which mark the files for *later* deletion.

The "\$" command changes the property protecting against automatic deletion. The user moves the Emacs cursor to the "TMSG 6" line and types "\$". That immediately sets that property and updates the display, changing the line

```
1 TMSG 6 2 +86 ! 4/03/84 23:34:36 (4/03/84)
```

to

```
1 TMSG 6 2 +86 !$ 4/03/84 23:34:36 (4/03/84)
```

The full directory listing now looks like:

```
MC NSR
FREE BLOCKS #0=1666 #1=625 #13=1163 #15=1461 #14=1549 #16=1149
L FIXLIB 209 ==> EMACS1;FIXLIB > (5/06/83)
D 1 QUEUE NOTES 2 +83 3/10/84 10:20:13 (3/23/84)
13 TEST VALUES 0 +69 1/17/84 19:20:14 (4/03/84)
1 TMSG 2 1 +34 $ 3/28/84 11:03:39 (4/03/84)
D 1 TMSG 3 1 +20 ! 4/03/84 21:53:21 (4/03/84)
D 1 TMSG 4 1 +248 ! 4/03/84 21:57:45 (4/03/84)
1 TMSG 5 2 +94 ! 4/03/84 22:14:15 (4/03/84)
1 TMSG 6 2 +86 !$ 4/03/84 23:34:36 (4/03/84)
L TS NSRMAC ==> NSR;TSNSRM > (2/24/84)
15 TSNSRM 1320 13 +463 8/19/83 20:44:23 (2/24/84)
```

The user types a "Q" to indicate that the deletion plan is complete, and is offered the following alternative display of the deletion plan for confirmation:

```
Deleting the following files:
  QUEUE NOTES ! TMSG 3 ! TMSG 4
Ok?
```

The confirmation shows only the files to be deleted and some of their important properties. For instance, "!" indicates that a file has not yet been backed up on tape. In this case, that is all right for "TMSG 3" and "TMSG 4", since those are not the most recent versions of the file. (If the user had marked the most recent version of a file for deletion, a ">" would indicate that fact.) Typing "YES" causes the plan to be executed and the files are thereby deleted.

Dired Presentation Model. Figure 4-1 shows the structure of the extended presentation system model of Dired. It has four component presentation systems, labeled "Presenter Control," "Directory Listing," "Deletion Planning," and "Confirmation."

Directory Listing PPS. The main PPS presents the directory and recognizes the immediate commands, such as "S" (move file to secondary pack) and "\$" (change property protecting against automatic deletion). The presentation data base PDB1 comprises the text that makes up the directory listing. A line of text is a composite presentation presenting a file or link; the text within the line presents properties of the file, such as the file's name ("QUEUE NOTES"), creation date ("3/10/84 10:20:13") and last-reference date ("(3/23/84)"). Several of these presentations are in turn composites of smaller presentations (e.g., "3", "23", and "84" are components of "3/23/84").

The presentation editor PE1 offers the "S" and "\$" commands, both of which are references to the current file presentation within the directory, as well as Emacs commands for moving the cursor and scrolling text. Recognizer R1 immediately translates the "S" command into the command to the file system to move the file. Presenter P1 then updates the directory listing to show the "13" presenting the disk pack. Similarly, the "\$" command is translated by the R1 into the file system command to change the file property. P1 then changes the directory listing to show the "\$" presenting this property.

Presenter Control PPS. The PPS at the top of the figure is an interface to the presenter P1 of the directory listing PPS. The application data base of this extension is the state of P1 describing which files are to be listed. The presentation data base of the extension, PDB2, is *shared* with the directory listing PPS. In other words, the same presentation data base is

Figure 4-1: Dired Model

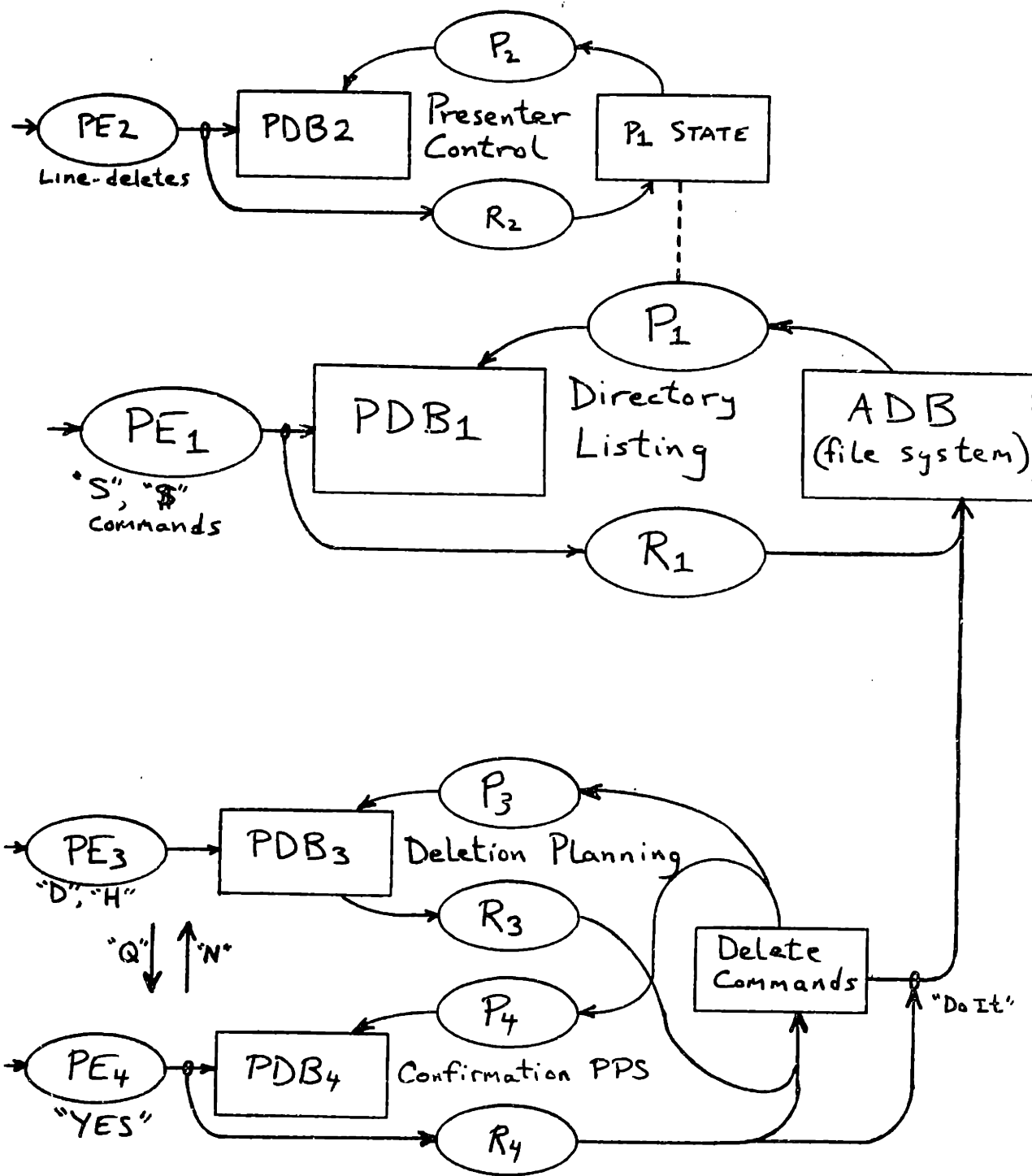

involved in both presentation systems.

The extension's presentation editor, PE2, however, is not the same. It does share Emacs cursor movement and scrolling commands, however. The primary editing commands for PE2 are those Emacs commands that delete lines, such as the Delete Matching Lines command mentioned in the scenario above. The recognizer R2 translates these line deletions into changes to the directory presenter P1, informing it that certain files (those files whose presentations were deleted) are no longer to be presented.

Since this extension shares the presentation data base of the directory listing PPS, P2 is an implicit presenter, tied to P1 in that P1's output (the presentation data base) is itself a presentation of P1. In general, the output of a process can serve as a presentation of the state of that process.

Deletion Planning PPS. The third PPS is an extension of the main directory listing PPS using the technique of adding a data base of planned commands. A delete command is presented by an annotation to the directory listing presentation: a "D" placed at the left of the line presenting the file to be deleted. Again there is a close relationship between the presentation data base of the deletion planning PPS, PDB3, and that of the directory listing PPS, PDB1, although the two are not the same in this case. They share some of the same screen space, but the component text presentations are different.

The deletion planning PPS is a representation shift presentation system: the state of the presentation data base conveys all the information about the delete commands. The presentation editor PE3 contains the Dired "D" and "H" commands discussed in the scenario, as well as a wide range of other Emacs editing commands. The user can use "D" or "H" commands to create the annotation presentations. They simply insert "D" annotations on file presentation lines. Alternatively, the user can use any Emacs editing method of inserting a "D" at the beginning of a line, and that "D" will be recognized as a delete command.

Confirmation PPS. The presentation system at the bottom of the figure is an extension to

the deletion planning presentation system. The job of the confirmation system is to give the user a different presentation of the planned delete commands, and recognize the "do it" signal for the deletion planning commands. When the user types "Q" after creating the plan of deletions, the deletion planning PPS is suspended, and control passes to the confirmation PPS. (If the user does not confirm the deletion plan, control will pass back to the deletion planning PPS.) The planned delete commands are presented by presenting the files to be deleted -- their names and those properties most frequently useful for checking the plan.

Unlike the other presentation data bases, PDB4 is a completely separate presentation data base. It has a trivial presentation editor, PE4, which allows the user to type in the confirmation answer. Recognizer R4 watches for these answers, and signals "do it" if the answer is "YES". (Other than the "do it," R4 sends no commands to the delete-commands application data base.)

4.2 Zmacs

Zmacs [Zmacs 84] is the text editor for the MIT Lisp machine [Weinreb, Moon & Stallman 83]. Zmacs has many capabilities, and a complete model of its presentation system behavior would be very large. This section will describe the major presentation systems aspects and sample the rest.

Buffer PPS and Screen PPS. Figure 4-2 shows the most important structure of the presentation system model of Zmacs. The PPS labeled "Buffer PPS" and that labeled "Screen PPS" model the primary presentation. In the buffer PPS the application data base ADB is presented as text in the buffer, i.e., PDB1. (Text files are treated here as long-term storage of presentation data bases. Therefore, this section will concentrate only on the buffer.) The application data base can be of many forms and is frequently not realized as any explicit set of programs or information. For example, when PDB1 contains English text, the application data base would comprise language constructs (words, sentences, paragraphs, etc.) and the subject matter they discuss. These things do not exist in the

Figure 4-2: Zmacs Model

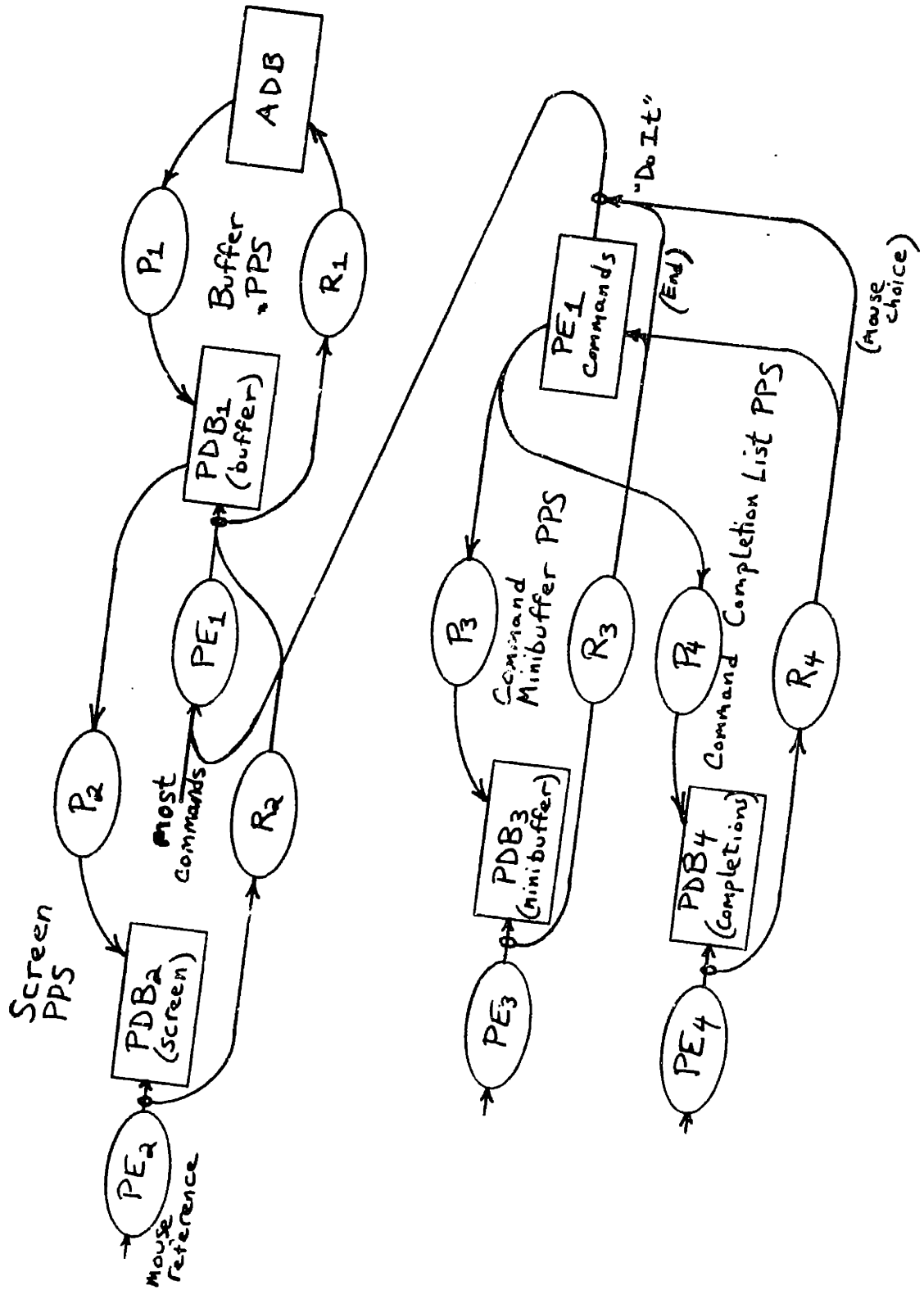

computer anywhere, but they are nevertheless being presented. When the text is a Lisp program, on the other hand, the application data base is the Lisp machine's computational environment.

The screen PPS cascades with the buffer PPS, further presenting the buffer as the text that appears on the screen. Most user interfaces can be modeled with this extra stage, but often the operation at this level is trivial. For Zmacs, however, it is useful to discuss the screen PPS, as certain Zmacs commands depend on the distinction of PDB1 (the buffer) and PDB2 (the screen).

The buffer contains text (a large amount possible -- much more than fits on the screen). It has an associated current position called *point*; user-typed text is inserted at *point*, for instance. There is sometimes another position called the *mark*, and the interval between *point* and the *mark* is called the *region*.

Presenter P2 presents a window of text around *point*, i.e., a contiguous section of PDB1 text that will fit on the display window. *Point* is presented by the cursor. The *region* is highlighted on the screen, either by underlining or by reverse video. This choice is made by a user option, i.e., a P2 presenter control. In addition to choosing the window of text P2 must also consider what to do with lines of text that are too wide for the window. In Zmacs these lines are *wrapped*, so that they continue on the next screen line, with an exclamation point to present the fact that wrapping has occurred.

Buffer PPS commands. To a large degree, the operation of a text editor concerns only PE1 and PDB1, with most user editing going unrecognized until much later. Zmacs is, however, more than *just* the combination of PE1 and PDB1 (and the screen PPS) -- there are several commands whose behavior involves recognizer and presenter action.

For instance, consider the Fill Paragraph command to P1, which edits the paragraph of text around *point* to have lines that achieve a good fit within the margins. As the user types and edits the text of the paragraph, R1's organizational recognizer determines the block of text presenting the paragraph, creating that paragraph in ADB. The Fill Paragraph

command signals P1's organizational presenter to perform the filling, updating the presentation data base to present the ADB paragraph in the filled style. Finally, P2 updates PDB2, the screen, and the user sees the result.

Similarly, consider the Indent For Lisp command, which indents the current line of a Lisp expression according to its syntactic structure. Recognition has been proceeding (in effect) as the user edits, constructing and editing the Lisp object in the Lisp environment ADB. Up to this point, P1's organizational presenter has followed the user -- i.e., done nothing to change the text. The Indent For Lisp command signals the organizational presenter to update the presentation according to the presenter's indenting style. P2 then updates the screen to reflect the PDB1 changes.

The Mark Thing command sets the region around some presentation at point, the kind of presentation being determined by exactly where point is. If point is in a word or Lisp symbol presentation, that presentation is marked. If point is at the start of a Lisp expression, the whole expression presentation is marked. Recognition of this command translates into a mark of the object in the ADB followed by presenter update. The PDB1 region is set to present that selected ADB object. This illustrates the need to consider more than just text as presentation forms -- the region, and also point and mark separately, can present information in the application data base.

Finally, consider the Evaluate Region and Evaluate Into Buffer commands. Evaluate Region causes the Lisp expression recognized from the region text (or if there is no region, then the Lisp definition around point) to be evaluated in the Lisp computational environment. The value is presented in a small window at the bottom of the screen. Evaluate Into Buffer takes its text to be recognized from a different area (a *minibuffer*, to be discussed below), and after evaluation, presents the resulting Lisp value in PDB1 as text.

Screen PPS commands. Most Zmacs user commands go to PE1, the presentation editor for the buffer PPS. Commands to the screen PPS components involve the screen appearance as opposed to the underlying buffer text. Such commands concern mouse references, window scrolling, window reshaping, and any text commands that depend on

whether lines are wrapped. (For instance, such a command might move the cursor down one screen line, moving forward in the buffer text line to a point presented on the screen as directly below.) Window movement and reshaping commands go to the presenter P2.

Consider the PE2 mouse command to move point. The user points to a buffer position presented on the screen and clicks a mouse button. Recognizer R2 translates the reference in screen coordinates to a reference to the position within PDB1's text, the position which is presented by the referenced screen position, and a command to move point to that position. Presenter P2 then updates the screen so that the cursor presents the new position of point.

Consider also the PE2 mouse command to mark the thing at the mouse position. The user points to a presentation, e.g., a word or Lisp expression, and clicks a mouse button. Again R1 must translate a screen coordinate reference into a buffer text position reference and a command to move point to that position. In addition the reference translation includes a mark-thing command. That mark-thing command is further recognized, within the buffer PPS by R1, as described above. Thus, the mouse command to mark a thing requires action by PE2, R2, R1, P1, and P2.

Command Minibuffer and Completion. The lower half of figure 4-2 shows the model for the Zmacs *extended command minibuffer*, by which Zmacs commands can be given by name. Many Zmacs commands are connected to keys, so that they may be invoked by a single keystroke. However, all commands may be invoked from the minibuffer, relieving the user of the need to remember infrequently used keys. Thus, the minibuffer offers a presentation system to the Zmacs commands. (For simplicity, we will consider only PE1 commands.)

The minibuffer is a two-line buffer at the bottom of the screen and is edited almost entirely as is the main buffer; i.e., PE3 is almost a duplicate of PE1. PE3 does have some additional commands, primarily concerning *command completion* [Zmacs 84]. As the user constructs the command name, the command name recognizer, R3, attempts to determine the possible commands that have the user text as a partial string. The user can signal the command presenter P3 to aid in constructing the command name by filling in more of the

name -- as much as can unambiguously be completed. (E.g., if the user has typed "L Mo", and the only command whose first word starts with "L" and second word starts with "Mo" is Lisp Mode, then "L Mo" can be completed to "Lisp Mode".) The user causes the command to be executed by typing Return; this causes R3 to signal the "do it."

In addition, the user can invoke a command that lists the possible completions of the text constructed so far. This command triggers the presenter P4 in the command completion list PPS. It creates a new presentation data base PDB4 on the screen, a window of the completions. The command minibuffer PPS and the command completion list PPS both interface to the same application data base of PE1 commands. PE4 allows the user to select a completion from PDB4 with the mouse. That reference is recognized by R4 as choosing that particular PE1 command and signalling the "do it."

Other Presentation Aspects of Zmacs. This section will briefly discuss two of the many other presentation and interaction mechanisms in Zmacs. Most of those not discussed here are very similar to the ones that are discussed.

Mode Line. One of the constant features of the Zmacs screen is the mode line, a small one-line window near the bottom of the screen that presents important information about the state of Zmacs and the buffer of text being displayed.

For instance, the mode line presents a list of the control modes that affect the action of presenter P1, recognizer R1, and some of the connections of keystrokes to commands. One of these is the *major mode*, which describes the kind of application data base information: text, lisp programs, etc. There are also a set of *minor modes*, with more localized effects; an example is a mode causing lines to be continually filled as they are being typed. The mode line's text presents these modes, and thus presents the states of PPS components, with labels such as "Text" and "Fill". The mode line as described thus far would be an example of a representation shift except that it cannot be directly edited. (For example, one cannot change the major mode by editing its presentation in the mode line.)

The mode line also contains a presentation of the screen PPS presenter, P2, and PDB2's

relation to PDB1. Small arrows pointing up or down can appear at the right of the mode line. An upward-pointing arrow, for example, presents the fact that P2 has chosen a window with more of PDB1 above it.

Scroll Bar. The scroll bar is a small display that appears inside the left edge of the Zmacs window when the mouse moves to that edge. (See figure 4-3.) The scroll bar consists of a vertical line segment juxtaposed against the left window border. The line segment, by its position along the border and its relative size compared with the border, shows the size and position of the PDB2 window relative to the size of PDB1. In figure 4-3 the PDB2 window is about one fourth the size of PDB1 and is at about the two thirds position in PDB1.

The line segment presents PDB2; the border line presents PDB1. By presenting PDB2 and its relation to PDB1, the scroll bar is presenting the state of the presenter P2. (In general, the state of a process can be presented by presenting the state of its inputs and/or outputs.)

The user can interact through the scroll bar using the mouse. For instance, the PDB2 window can be scrolled by a quarter of its size by making one kind of mouse reference to a position a quarter of the way down the line segment (PDB2 presentation). Or, the PDB2 window can be repositioned within PDB1 by pointing to the relative position along the border (PDB1 presentation). The scroll bar thus offers a simple PPS interface to the presenter of the screen PPS, P2.

4.3 Xerox Star

The Xerox Star [Purvy, Farrell & Klose 83] [Smith, Irby, Kimball, Verplank & Harslem 83] and the Apple Lisa [Lisa 84] systems offer an interface organized around the manipulation of icons -- pictorial presentations of commands and data. The two systems are similar in many respects, so only the Xerox Star will be discussed.

Xerox Star Scenario. The Xerox Star models the user's environment after an office desktop. (The desktop is, in effect, a directory.) Arranged about the desktop are various

Figure 4-3: Zmacs Scroll Bar

Always do right. This will gratify
some people, and astonish the rest.

- Mark Twain

When angry, count ten before you
speak; if very angry, an hundred.

- Thomas Jefferson

When angry, count four;
when very angry, swear.

- Mark Twain

Nothing so needs reforming
as other people's habits.

- Mark Twain

ZMACS (Text Fill Abbrev) SAMPLE.TXT PS:

documents, in-boxes, out-boxes, and folders. These are depicted on the screen by *icons*, small pictures. A document icon looks like a piece of paper with a title on it. An in-box icon looks like an in-box. Folders contain documents, and their icons look like manila folders. (Folders are, in effect, sub-directories.) Figure 4-4 shows a sample desktop display.

Also on the screen are icons for more things than would normally appear on a real desk, such as printers and file-drawers. File-drawer icons look like small file cabinets and indicate directories on remote file servers.

Interaction involves a mouse and command keys. The user *selects* something, such as a document icon, by pointing to it with the mouse and clicking the left mouse button. The selected icon is highlighted. The user then gives a command that affects the selected icon. Special keys are provided for several commands.

One important command key is *open*. It causes the contents of the selected thing to be displayed. For example, opening a document displays the text of that document. Opening a folder displays the documents within that folder. Figure 4-5 shows a display after the user opens the folder *Backup*.

There are four *universal command keys*: *move*, *copy*, *delete*, and *properties*. These commands can be applied to any Xerox Star object. In its simplest usage the move command allows the user to reorganize the visual desktop. The user selects the document icon and gives the move command. Then, as the user moves the mouse, the document icon follows it. Clicking again releases the icon from the mouse.

Another important use of the move command is to manipulate the document itself, not just the organization of the visual display. The document is printed by moving the document icon to a printer icon. The document is moved into a folder by moving its document icon into the display of the opened folder. A document is moved to a directory on a remote file server by moving the document icon to the file-drawer icon.

Typing the *properties* command key produces a *property sheet* for the selected item.

Figure 4-4: Xerox Star -- Desktop Display

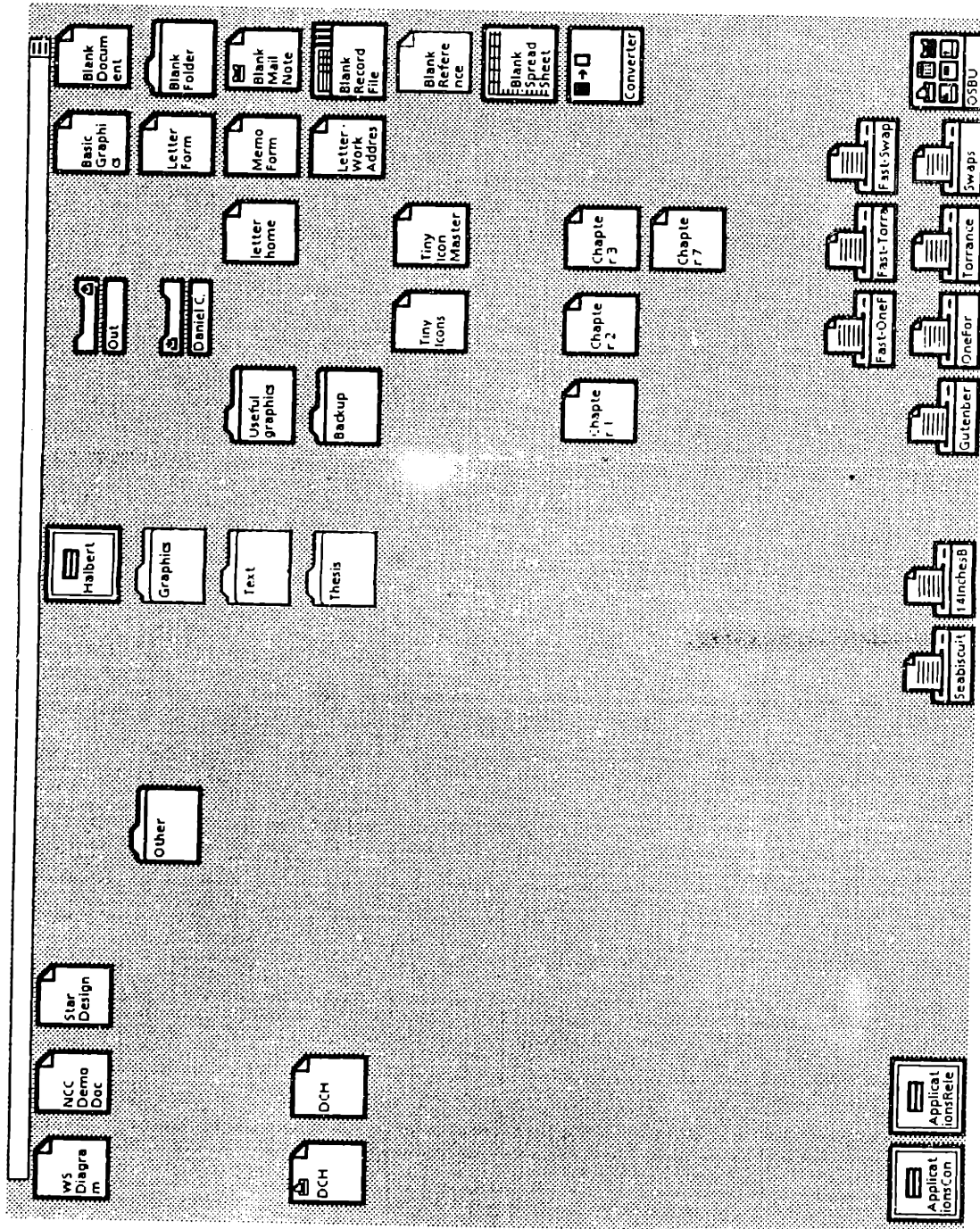

Figure 4-5: Xerox Star -- Opened Folder

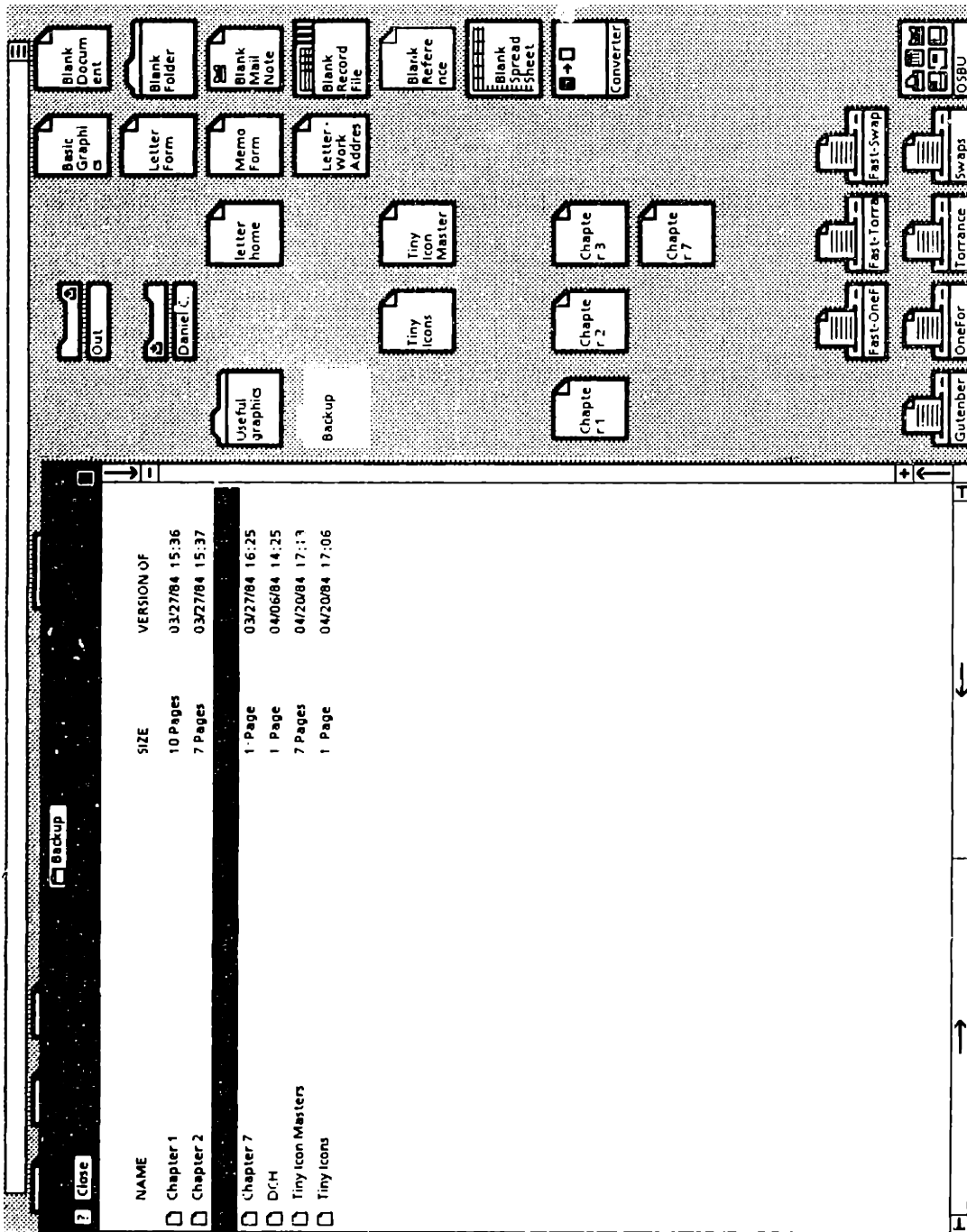

Figure 4-6 shows the part of the desktop displaying the property sheet for the document named *Chapter 7*. The property sheet is a table, displaying properties such as the document's name, creation date ("version of:"), and whether to display a *cover sheet* when the document is opened. (A cover sheet contains fields that help in mailing the document, such as *from*, *to*, *subject*, and an accompanying remark.)

The user may modify the *name* and *show cover sheet* properties. Editing the name property is the way one renames a document.

A document or folder is deleted by selecting its icon and then typing the delete command key. (Similarly, a selected section of document text in an opened document is deleted with the same command.) Because deletions are currently not retractable, Xerox Star requires confirmation from the user. A one-line message is displayed at the top of the screen, together with a yes/no choice. The user confirms the deletion by choosing "yes" with the mouse. Figure 4-7 shows the upper part of the screen during a delete of the *Backup* folder.

Xerox Star Presentation Model. Figure 4-8 shows the presentation model for the part of the Xerox Star system discussed in the previous scenario. The model comprises four PPS components. As in the model for Zmacs, a window-display PPS cascades with the primary PPS.

Desktop PPS. The desktop PPS is the primary PPS. The application data base ADB contains documents, folders, remote file servers, in-boxes, out-boxes, and printers. These are presented by icons and windows in the presentation data base PDB1 (the picture of the desktop). Windows present domain objects, such as documents, by presenting their contents or properties.

Icons have little presentation structure, but even icons are not primitive, i.e., they are not name presentations. Two kinds of presentation structure occur. Icons present the name of the document, printer, etc., and the appearance of the icon presents the type of the object, by depicting a stylized typical example.

Figure 4-6: Xerox Star -- Property Sheet

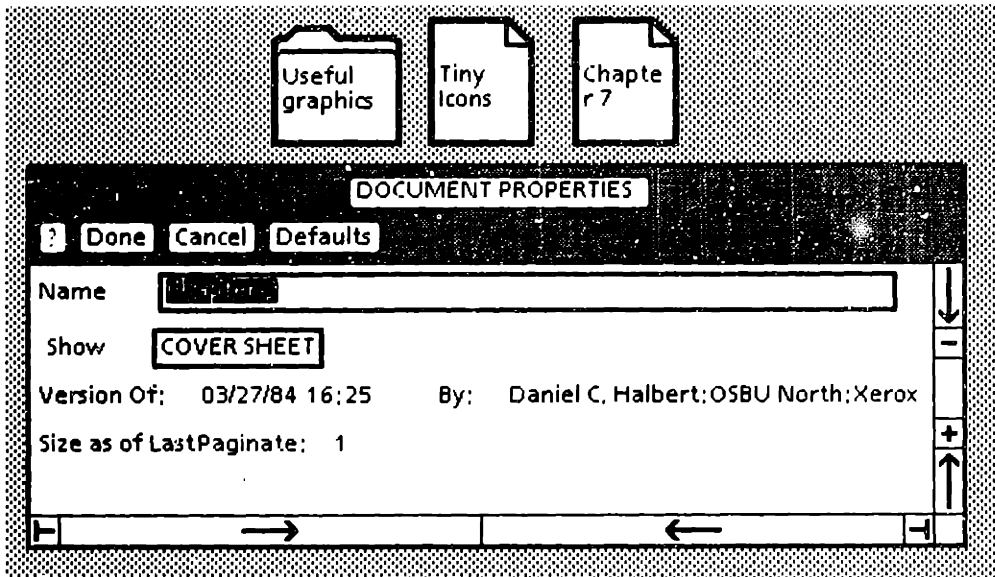

Figure 4-7: Xerox Star -- Delete Confirmation

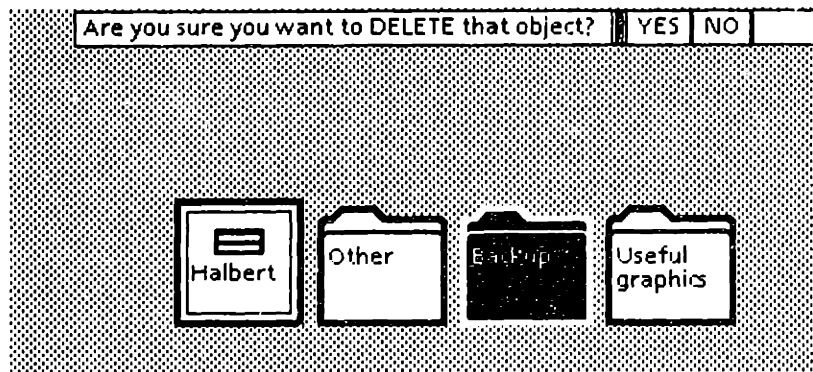
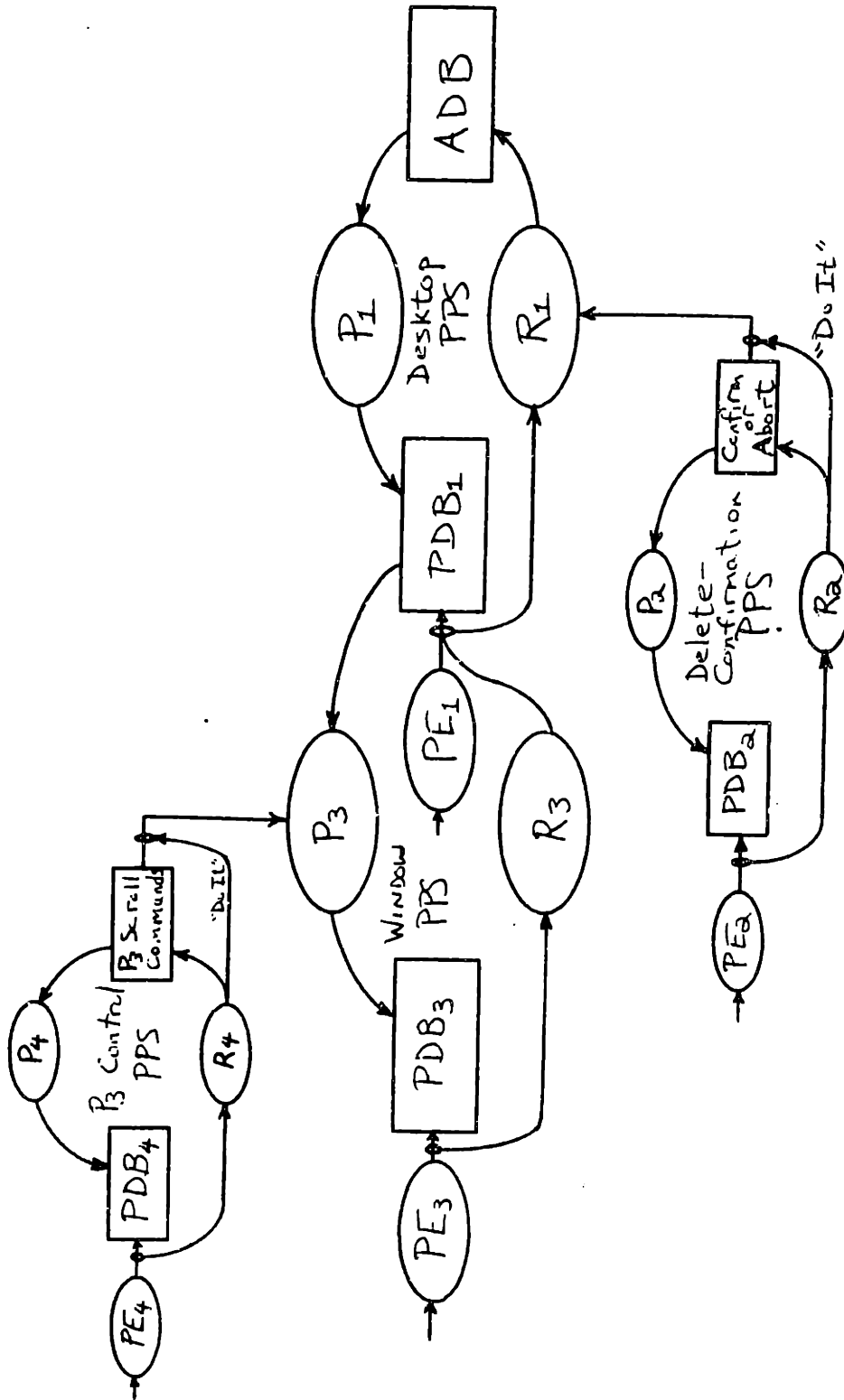

Figure 4-8: Xerox Star Model



Windows are composite presentations with many sub-presentations. Folder windows, for example, present the collection of documents and sub-folders in the folder by presenting them as icons within the window.

Consider the move command discussed in the scenario, an operation provided by the presentation editor PE1. The move may go unrecognized, merely changing the position of icons on the desktop. However, when a document icon is moved next to a printer icon, recognizer R1 translates the move into a print command. When a document icon is moved into a window presenting an opened folder, R1 translates the move into a command to move the document into that folder. In other words, spatial adjacency to a printer icon presents the fact that a document is being printed; spatial containment within a folder window presents the containment of a document within a folder. The user can create these spatial relations using PE1, and R1 implements the commands to create those presented conditions.

The delete command in the scenario refers to a selected document icon. Recognizer R1 translates this into a delete-document command, but does not immediately send it to the application data base. The delete-confirmation PPS is used to allow the user to first confirm the deletion.

Delete-Confirmation PPS. The application data base of the delete-confirmation PPS contains two recognizer control commands: a confirmation ("do it") and an abort. These commands are presented in PDB2 by presenting the delete command in the question and by presenting the choice between the two commands as a yes/no box.

The user references the yes/no box with the mouse, using presentation editor PE2. Recognizer R2 translates this into the confirmation or abort command and sends the command to R1. If confirmed, R1 proceeds to send the delete command to ADB.

Window PPS. Some text and graphical objects in PDB1 are within windows for opened documents, property sheets, etc. From these PDB1 objects, presenter P3 selects those objects that will appear in the window. These visible icons and text are the contents of the

presentation data base PDB3.

Mouse references to text or icons within the window are made with presentation editor PE3 and translated into references to the presentation data base PDB1 by recognizer R3. These are then further recognized by R1 as commands to the application data base.

P3-Control PPS. The window presenter P3 accepts presenter control commands for scrolling the window. Scroll commands are presented by arrows in the margin of the window, i.e., in presentation data base PDB4, by presenter P4. The user can point to those arrows with presentation editor PE4. Recognizer R4 translates those references into selection of scroll commands, together with a "do it" causing them to be sent to P3.

4.4 Steamer

Steamer is a prototype system designed to help train operators of U.S. Navy steam propulsion systems, incorporating color graphics, knowledge-based instruction, and comprehensive simulation models [Stevens, Roberts & Stead 83] [Stevens & Roberts 83]. Only the user interface aspects of the graphics and its connected simulation model will be considered here.

Steamer uses a simulation model that consists of about eight thousand state variables, together with updating functions, which are processed once a second. (The simulation proceeds in real-time.) The user watches an animated schematic view of the simulation. There are several such views, one of which is shown in figure 4-9. The schematic is continually updated, producing an animated view of the system. Certain elements in the system can be made to fail (e.g., a valve sticks open), to provide training for emergencies.

The user controls the system by pointing to various parts of the schematic with a mouse and by using menus. Pointing to a valve icon changes its state, opening or closing it. Throttles are set by pointing to the position within them that indicates the new value. Fluid levels are changed by pointing to a new level position within the fluid tank icon. In addition to pointing, another console displays different menus of operations and choices for

Portions of the text
on the following page(s)
are not legible in the
original.

Figure 4-9: Sample Steamer Schematic

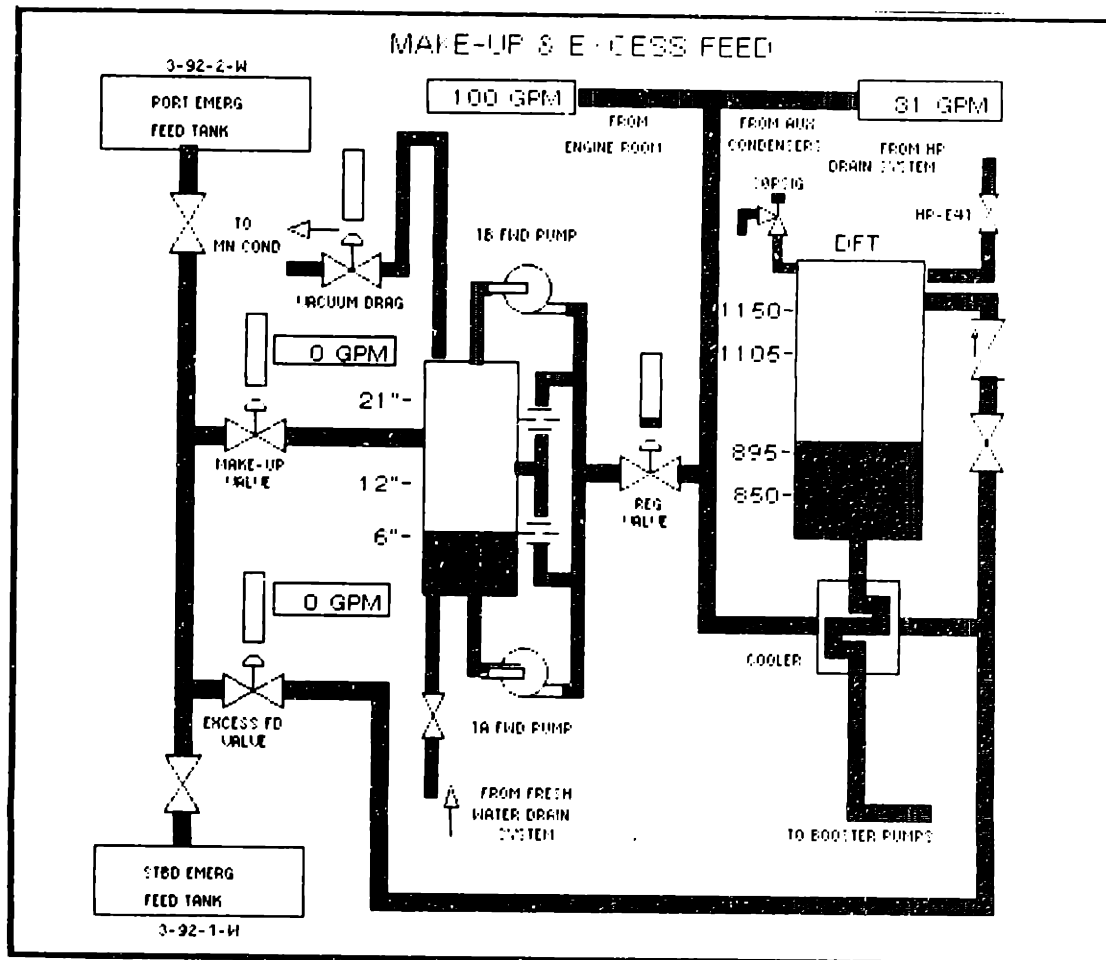

controlling the simulation and choosing displays. Figure 4-10 shows a sample display of the menu console.

In what follows, two kinds of users will be mentioned, the student and the instructor. Both use Steamer's schematic editor. The instructor uses the schematic editor to build the schematic views of the system. The student uses the schematic editor to build controllers for a process.

The Feedback MiniLab [Forbus 81] is an extension to Steamer designed to teach control system concepts. For instance, one exercise is to ensure that the temperature of oil in a sump remains at a specified value. The student builds a controller by selecting graphical icons of a measurement device, comparator, actuator, etc., and connecting them together on the screen. Steamer builds the underlying simulation for this device and connects it into the main simulation model so that the student can study the resulting operation.

Steamer Presentation Model. The heart of the Steamer user interface is the continual schematic view of the state of the simulation. This view is modeled by the PPS labeled "Simulation Schematic PPS" in figure 4-11. The application data base ADB1 contains the set of simulation state variables and various functions of these variables. The presentation data base PDB1 is the color graphics schematic.

Steamer schematic presentations are constructed from icons, e.g., symbols for valves, gauges, pipes, etc. Figure 4-12 shows a sample of these icons. These present state variables or functions of state variables. Each kind of icon presents information in a particular way. Valve icons are green to present an open valve, red to present a closed valve. Dials have indicators that point to the presented values. Pipe presentations (rectangular pathways between other icons) use color map techniques to show animated fluid, with small colored blocks moving through the pipes. The apparent speed of movement presents the speed of the fluid, as computed from state variables. The kind of fluid (e.g., steam, water, oil) is presented by the color of the moving blocks.

The schematic presentation is updated by presenter P1 after each cycle of the simulation,

Figure 4-10: Steamer Menu Console

Steamer

No view selected.			
Acknowledgement			
Probe Tick Initialize	Res Rup Sto	Rate Status Help	Screen Malops Casualties
Comments	Initially underway at 15 knots with on Loading at Make Up and Excess Feed		
Status	SHUT		
Speed (kts)	15	RPM	
Current Views	<ul style="list-style-type: none"> 18 BIPREP FRONT FO CONTROL VALVE 1B FUEL OIL SYSTEM BASIC FO SYSTEM GLAND SEAL EP GLAND SEAL UNLOADER MAIN ENGINE LUBE OIL Lube Oil Unloader Make Up and Excess Feed Mt Air Ejector MC Pump Submergence Main Condensate EP Main Feed Control MFP Lube Oil Cooler MFP-Pecirc-Sys-1A Main Feed System MAIN CIPIC SYSTEM EP THPOTTLEBOARD Fuel Oil Service Pump 1A 		
Speed (kts)	12.76	Condenser (Hg)	23
<i>Beginning of Procedure</i>			
<p>Component Procedure FOPM (START)</p> <ol style="list-style-type: none"> 1. Verify fuel oil service system (FOSS) is aligned. 2. Ensure pump pressure switch cutoff valve is opened. 3. Open the pump suction valve. 4. Open the pump discharge valve. 5. Ensure pump unloading valve handwheel indicator is positioned in auto. 6. Start the pump motor controller high/low. 7. Verify boiler burner fuel oil supply manifold pressure is not less than 350. 8. Report to Boiler Technician of the Watch (BTOU) that pump is started. 			
<i>End of Procedure</i>			
<i>List Interaction Window</i>			

08/23/84 17:35:52 BRobert
10011 Menu Choose

Figure 4-11: Steamer Model

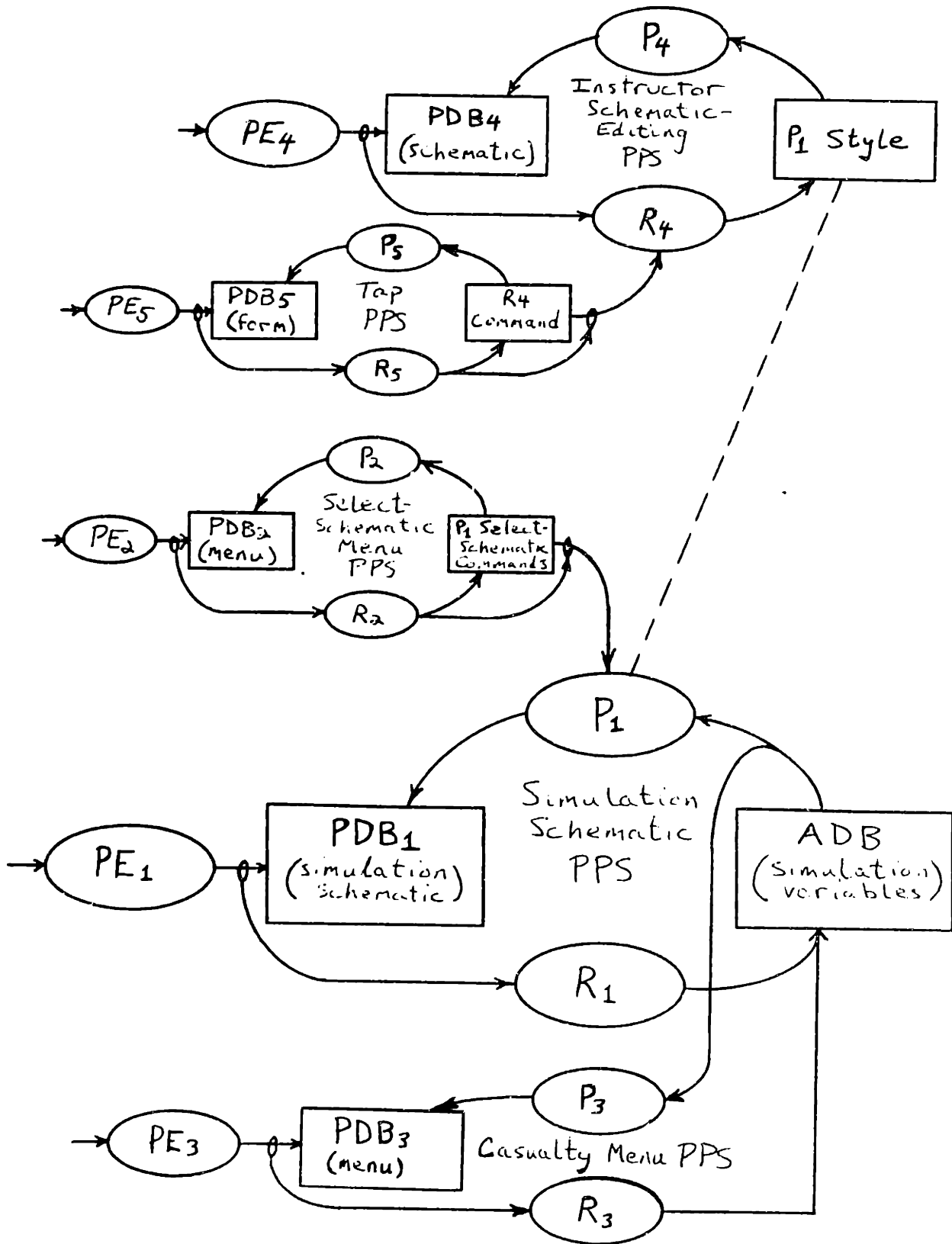
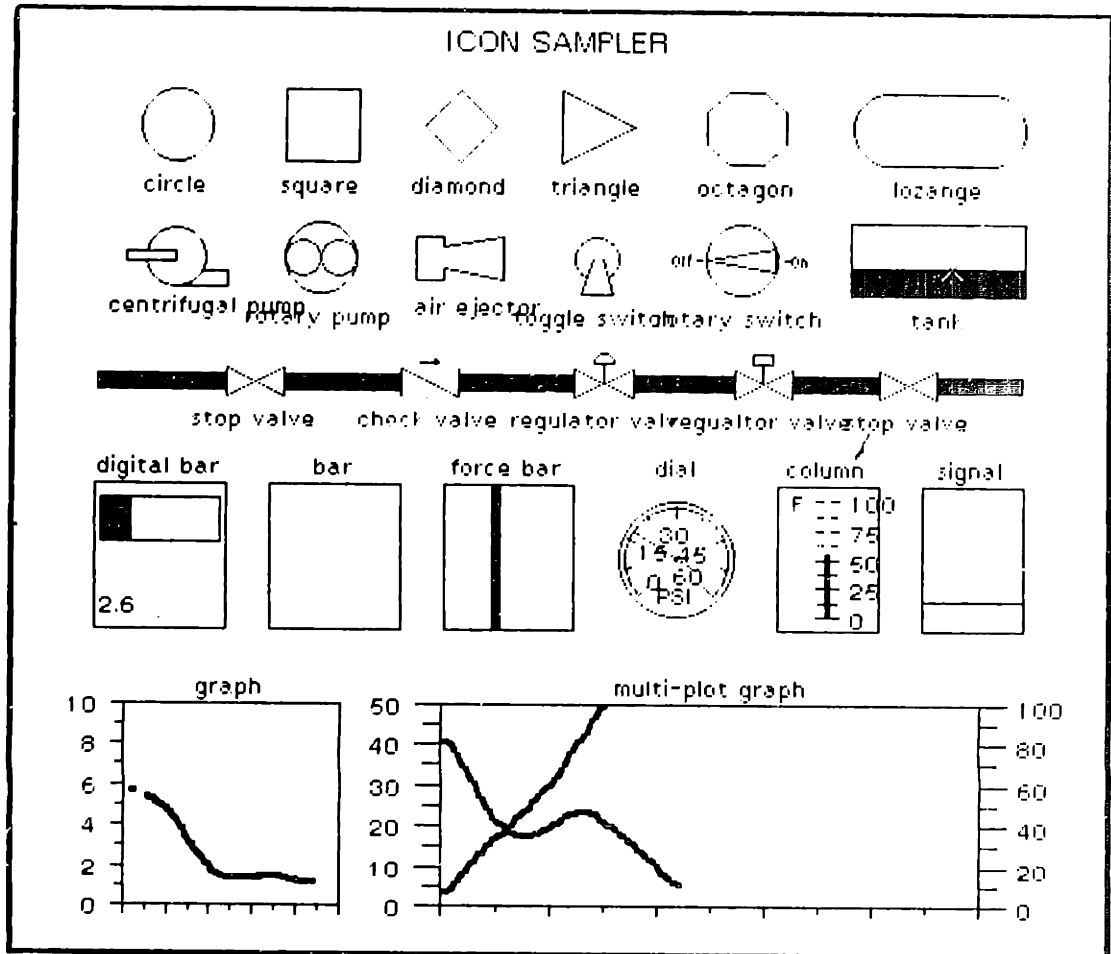

Figure 4-12: Sample of Steamer Icons



when the set of state variables is consistent. Thus the user sees an animated presentation of the ongoing process. This is a different situation from the other user interfaces discussed in this chapter.

There are two kinds of animation in this presentation. First is the overall schematic animation just mentioned, produced by continually updating a presentation of a changing process. The other kind of animation, however, is an explicit graphics technique used as a presentation itself -- the presentation of fluid flow within pipes. This animation is produced by graphics routines from a *static description of the process*, i.e., computed from a single, instantaneous simulation state. (The pipe flow animation continues even when the simulation is halted -- just as other information about that single state is still visible, such as dial readings or valve colors.)

Presentation editor PE1 lets the user interact in the simulation schematic PPS by mouse references. Recognizer R1 interprets these references in many ways, depending on their positions within the different kinds of icons, translating the references into changes to state variables.

Presentation editor PE1 in the Feedback MiniLab also lets the user create, move, connect, and edit icons for the process controller. Recognizer R1 translates these created controller presentations into commands to create the simulation for that controller and connect it to the rest of the Steamer simulation.

Steamer Menus. Steamer has many menus, occupying a second screen. Several of these are modeled in figure 4-11. The select-schematic menu PPS models the menu that lets the user select which schematic to view. This PPS is an interface to the presenter P1, with an application data base of P1 commands to select the various schematics. Presentation data base PDB2 is a menu, a set of text presentations, each naming a schematic. Presentation editor PE2 models the user's selecting a menu item with the mouse. Recognizer R2 then translates that into a choice of the presented select-schematic command and sends it to presenter P1.

The casualty menu PPS is another interface to the main application data base ADB1, the set of simulation variables. With this menu, the student or instructor chooses a casualty, recognized as a command to change some set of variables to simulate the particular device failure.

Creating Views. The instructor schematic-editing PPS enables the instructor to build and alter the main presenter P1's schematic views of the simulation. The schematic editing offered by presentation editor PE4 is similar to what the student has when creating a process controller, except for this PPS the simulation is not being changed. Instead, the style of schematic presentations that P1 builds of the simulation is changed or extended.

The PPS labeled "Tap PPS" extends the instructor's interface to the recognizer, R4, of the schematic editing PPS. As the instructor builds a schematic presentation for a new view, R4 must be able to determine what simulation variables or functions on them these new icons will present. (In Steamer terminology, R4 has the job of establishing *taps* from the icons to the state variables.) Presentation data base PDB6 in the tap PPS offers a form for the instructor to fill in, e.g., specifying an expression of some state variables. R4 combines this information with mouse references to the new icons by PE4 to establish the icon-simulation specification for the P1 style.

4.5 Summary of Structural Features

This section summarizes the features characterizing the structures of the extended presentation system models used in this chapter to model the computational behavior of the different user interfaces. Although the interfaces discussed appear very different, there are some strong underlying computational similarities, and the presentation system model highlights these. The overall appearance to the user, the use of icons versus menus, etc., is certainly very important to the success of the interface. However, these are questions of interface style; the presentation system model looks below the style to identify common components and behavior. The success of the presentation system base concept, as developed in chapter five, depends on this commonality.

The primary structural feature to be discussed is the way in which one PPS is attached to another. There were several kinds:

PPS to a Presenter. In Dired, the main presentation data base, the directory listing, is also used as a presentation of the directory presenter's state. Editing the directory listing is recognized as controlling the presenter's state. Presenter scroll commands are presented by icons in Xerox Star and the scroll bar in Zmacs. Steamer has two kinds of presenter interfaces: a menu allows selecting schematics, and schematics can be edited by the instructor to change the schematic style. The latter capability is similar to Dired's use of the directory listing.

PPS with Commands. A PPS with commands to a component in some other PPS allows *planning* -- to postpone the action while the action is being specified. Dired includes an annotation interface to the main application data base in order to plan delete commands. The Zmacs minibuffer interface allows the user to compose a presentation editor command. Star and Steamer include command interfaces to recognizers, the delete confirmation PPS in Star and the *tap* PPS in Steamer.

Multiple PPS Interfaces. An application data base can be presented in two or more separate PPS interfaces. In Dired, the deletion planning PPS and the deletion confirmation PPS present the same data base of delete commands. In Zmacs, the command minibuffer PPS and command completion list PPS both present the same data base of presentation editor commands. In Steamer, the main (simulation schematic) PPS and the casualty menu PPS both offer interfaces to the main (simulation) application data base.

Cascaded PPS Interfaces. Zmacs and Xerox Star both include a similar cascade of screen/window PPS and main (buffer/desktop) PPS. The screen/window PPS provides such features as clipping, scrolling, line wrapping, and mouse reference. Some user commands operate within the screen/window PPS, others within the main PPS, depending on whether they depend on the visual aspect within the window.

Sharing. Section 3.4 discussed the kinds of sharing that can occur within presentation

systems. Two important examples have occurred in this chapter. First, Dired and Steamer include a presentation shared between two PPS interfaces, the main presentation data base (directory listing or schematic) and a PPS interface to the main presenter. By editing the directory listing or schematic, the user controls the main presenter's presentation style.

Second, in Dired, screen space is shared: directory annotations are intermingled with the parts of the directory listing. Somewhat simpler, hierarchical space sharing occurs in the Xerox Star, where windows appear within the overall desktop area, and such things as scroll icons control the window presenter appear within the windows.

Chapter Five

PSBase: A Presentation System Base

A *presentation system base* is a collection of mechanisms and tools for building user interfaces whose architecture follows the structure of the presentation system model. A prototype, called PSBase, has been implemented on the MIT Lisp machine [Weinreb, Moon & Stallman 83] and will be discussed in this chapter. With a presentation system base, the job of building good user interfaces becomes much easier. Chapter six illustrates the utility of PSBase by discussing the implementation of an interface built on top of PSBase.

In certain respects the architecture of PSBase resembles the presentation system model proposed in chapters two and three. Some of the PSBase modules support particular PPS components, and in general, domain-independent and style-independent mechanisms are isolated. This structure in turn encourages good modularity in the user interfaces constructed. Figure 5-1 shows the fundamental support of PSBase modules for PPS components. Figure 5-2 shows the overall structure of PSBase, with arrows indicating *uses* relations. The reason the PSBase architecture does not exactly resemble the PPS model (see figure 2-1 on page 29) is due to the different goals of the model and the base. The PPS model analyzes the *activity* of a user interface. PSBase is structured to emphasize the *sharing of knowledge*; information is not redundantly represented. Also, figure 5-1 shows only some of the PSBase support: the *basic style packages* module supports the construction of combinations of PPS components and PPS extensions.

Each PSBase module will be discussed in a section below. There are three layers in the structure: The **data base mechanisms** module at the bottom of the figure is (to a large extent) a general support package, not specific to user interfaces. The four middle-layer modules represent general presentation-system support, i.e., tools and mechanisms used to construct various interface styles. The **basic style packages** module at the top of the figure comprises specific components of interface styles that the interface builder may or may not

Figure 5-1: PSBase Support of PPS Components

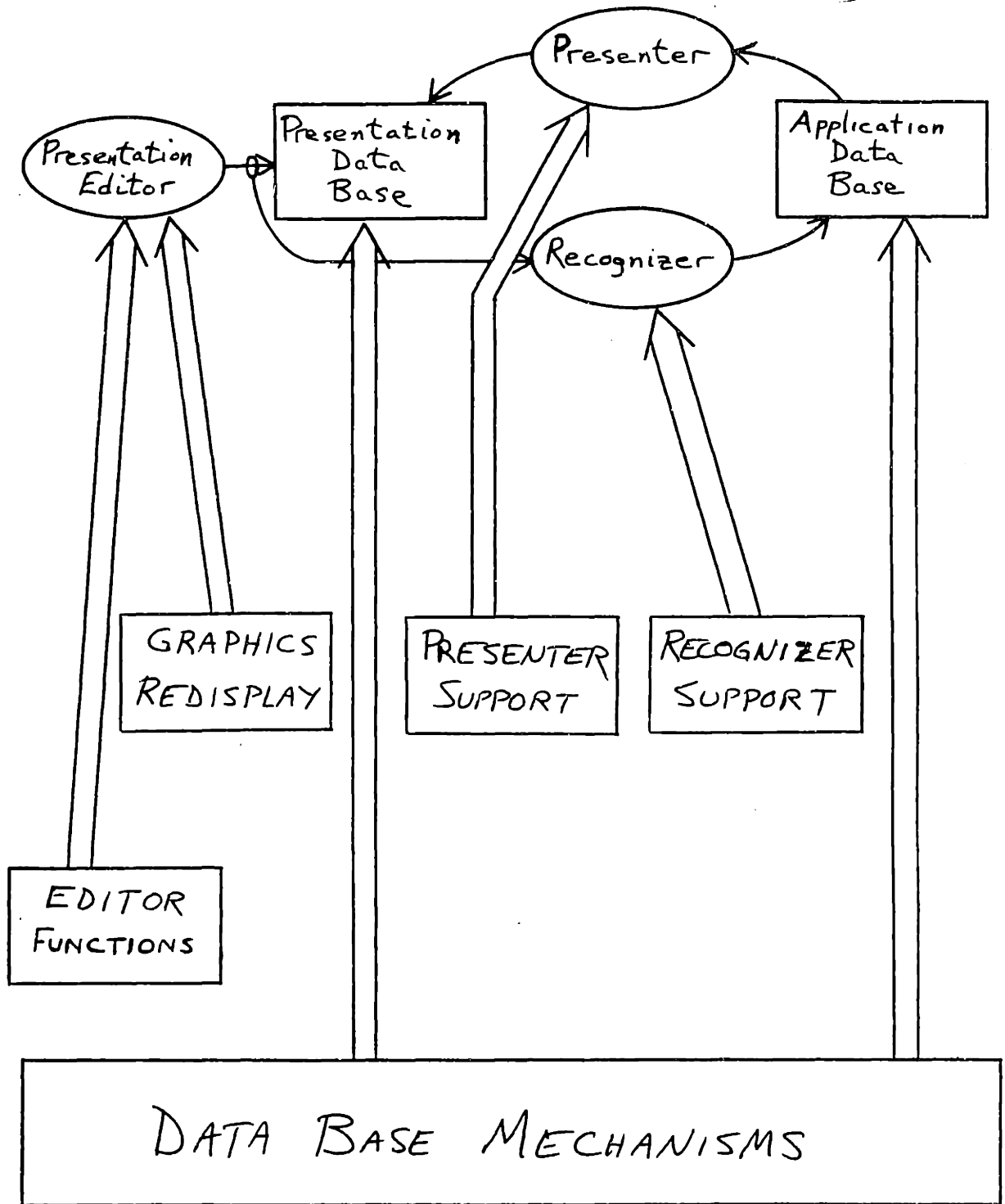
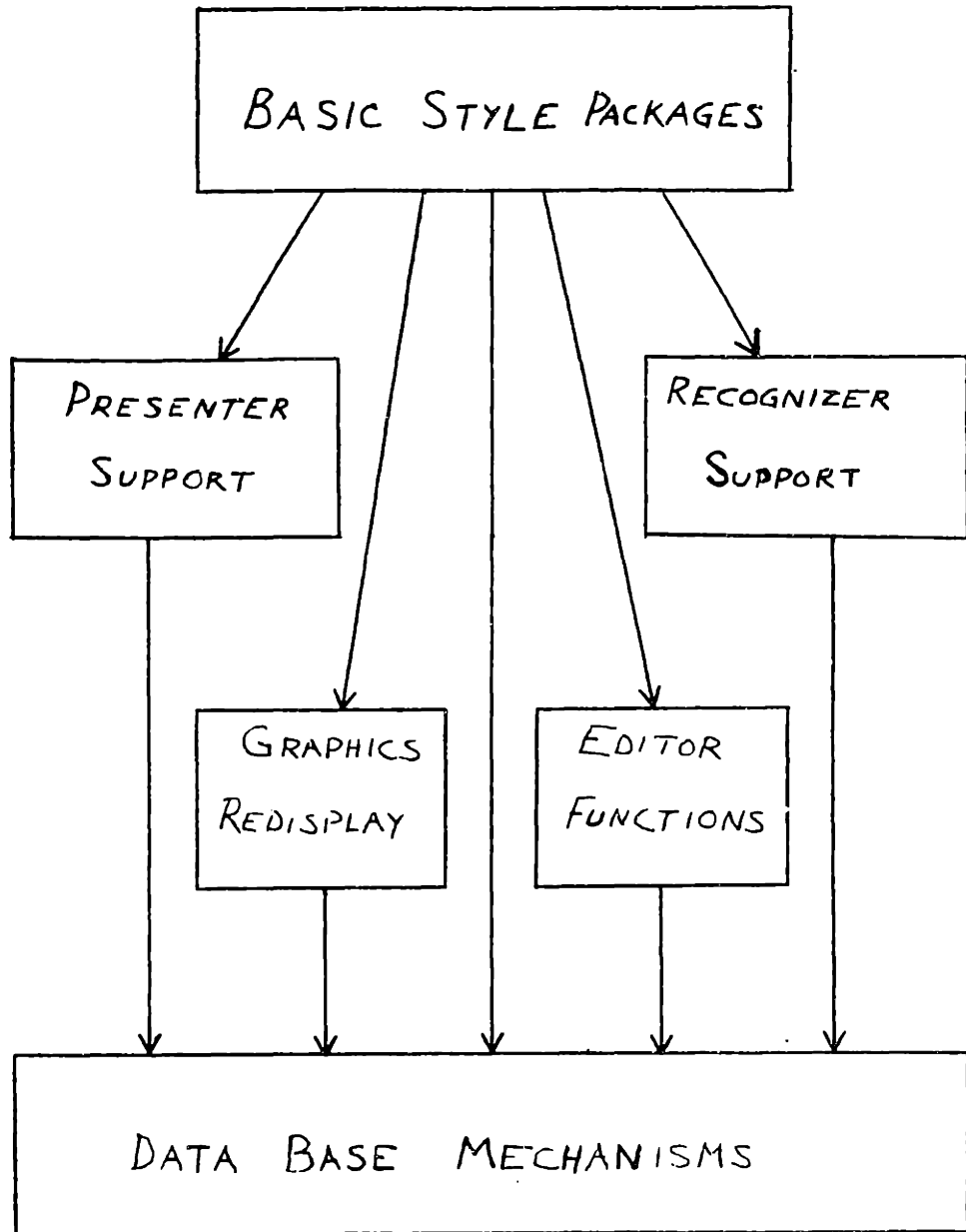

Figure 5-2: Structure of PSBase



choose to include. These packages, however, are independent of any particular application domain.

5.1 Data Base Mechanisms

PSBase includes support for building data bases structured as networks of objects. Much of this support is provided by the Lisp machine's *flavor system* for object-oriented programming. PSBase imposes certain conventions, provides an existing flavor structure for the descriptions, and provides tools for manipulating and extending the network structure. The Lisp machine flavor mechanism allows multiple inheritance of classes of objects (*flavors*). PSBase extends this slightly to allow limited inheritance and description of properties of objects (*instance variables* of flavor instances).

The basic data base mechanism is used for building application data bases (descriptions of files, directories, mail, and commands, for example) and the presentation data base (various kinds of presentations, their properties, and their relationships). An important point is that the presentation and application data bases are linked together, so that in effect they are both part of a large, uniformly structured data base. Many of the PSBase mechanisms rely strongly on the fact that the same data base mechanism is used throughout. Because of the importance of the data base mechanisms, they will be discussed in detail in this section.

One example of the benefits of having a uniform representation technique is that the presenter's domain collector and other domain-dependent modules can be minimized and more presentation mechanisms can be shared. The interface builder can experiment and change the implementation more easily, changing the presentation styles or adding new presentations, for example. Uniformity facilitates the construction of presenters.

This research did not attempt to build a state-of-the-art knowledge representation system. However, the data base mechanisms in PSBase are inspired by such systems (c.g., KL-One and its successors NIKL and KL-Two [Brachman 78] [Brachman & Schmolze 85] and Omega [Attardi & Simi 81] [Barber 82]), and a full-scale presentation system base may very well benefit from such a system.

An important capability of the data base mechanism is allowing the description of classes of objects and the relationships between classes -- particularly specialization and the inheritance of properties of objects of a class. Figure 5-3 shows an example, part of an application data base network describing files and directories. The application data base contains both class descriptions and also *instances* of them.

The style of the figure is based on that used for drawing KL-One networks. Ellipses show class descriptions; shaded ellipses show instances of classes. Double-stemmed arrows show the containing class. Small boxes connected to ellipses show properties; these properties are inherited by more specialized classes. (In addition, as will be seen later in this chapter, other mechanisms in effect "hang off" of particular classes of the data base, and these also undergo a sort of inheritance.)

For example, the class *file* is shown by the ellipse labeled "file"; it is a specialization of the class (i.e., a kind of) *generalized file*, which in turn is a specialization of the class *operating system object* and *domain object*. A *file link* is also a kind of *generalized file*. The network shows that generalized files have several properties: *directory*, *pathname*, etc. Files and links inherit these properties.

Each particular file in the application data base would be represented by an instance of *file*. One such instance is shown. Its *reference date* property is shown, linking that file instance with a particular instance of the class *date*. The file instance also has several other properties (*directory*, *path*, etc.), linking the file instance to *directory*, *pathname*, etc., instances, though they have not been shown in this figure.

Single-stemmed arrows from a box shows the value of that property, or for classes, the type of such a value. Some properties are specified as having a list of values; directories, for instance, have a property whose value is a list of files. A list property is shown as a box with a circumscribed circle. (One of the limitations of PSBase is that these type-restriction links are not fully implemented in the current implementation. They are shown here to better document the relationships of classes when instantiated. However, PSBase does include a simplified type restriction mechanism used for certain parts of the data base.)

Figure 5-3: A Class Description Network

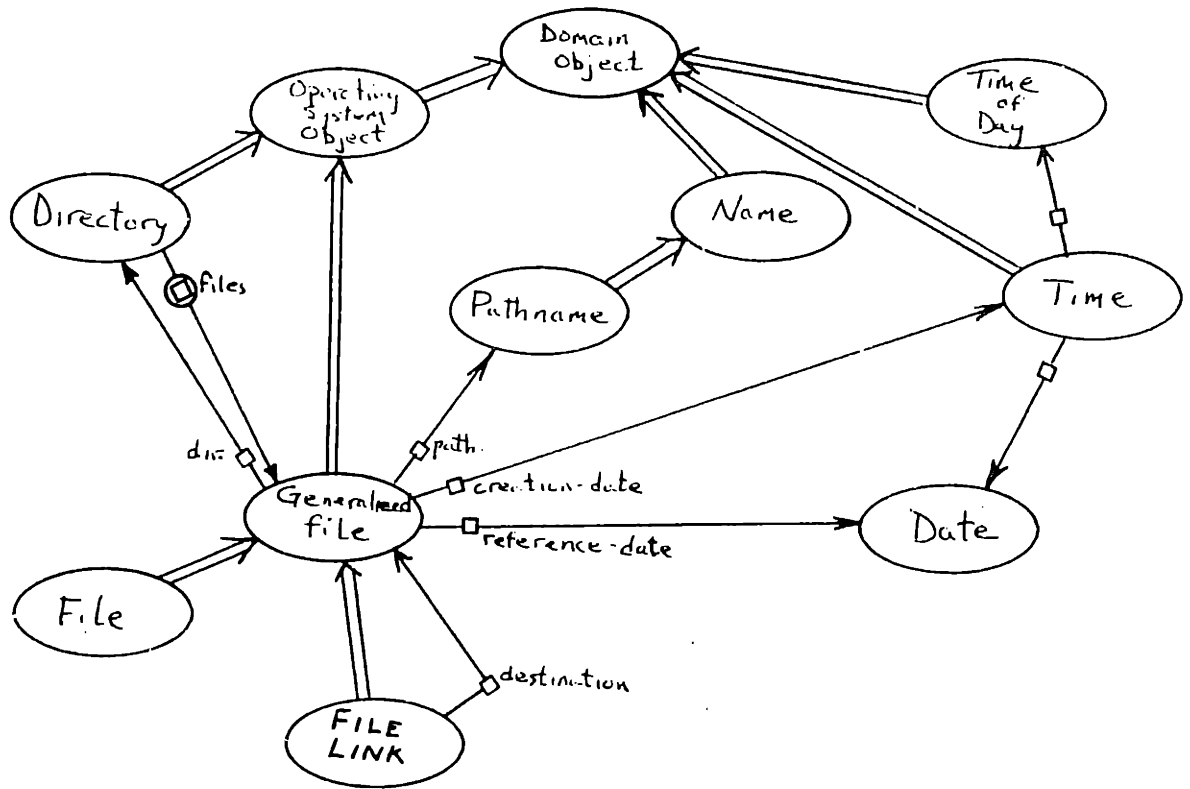

PSBase also offers a rudimentary ability to classify properties. This ability is not reflected in these figures, in the interest of clarity. For instance, circles, text, and other presentations typically have properties defining their positions. The description mechanisms allows these properties to be labeled as defining positions. One example of the benefit of such a scheme occurs in the implementation of the presentation editor function that moves presentations: the function can examine the description of the presentation to find its position-defining properties and change them, without any knowledge about the particular kind of presentation.

Presentation Data Base. PSBase provides a mechanism for building the presentation data base. This includes an already-constructed part of the data base network structure that defines several classes of presentations, inter-presentation relationships, and the properties that connect the presentation data base with the application data base. (As already discussed, they are not really separate data bases, but rather different parts of the same, overall data base network.) Each presentation can have a record of the presented data base object and the presentation style used. Most of the modules in PSBase (presenters, recognizers, graphics redisplay, etc.) depend on the known organization of the presentation data base and on the fact that it is part of the overall, uniform data base structure.

Figure 5-4 shows part of the presentation data base and its relation to the application data base. The main class is *presentation*. All presentations have a property called *presented domain object*, which records the domain object being presented. For example, text presentation *T1* (an instance of the *text* presentation class) is shown presenting the file OZ:<NSR>QUEUE.NOTES. This is recorded by *T1*'s presented-domain-object property linking *T1* with the file instance.

Figure 5-5 illustrates three kinds of inter-presentation relationships supported by the presentation data base network structure. First, *composite presentations* may be constructed; these have a property whose value is a list of sub-presentations. Second, a *connecting arrow* joins two presentations; the arrow's end positions (x_1, y_1, x_2, y_2) are derived from its end presentations' positions. Third, two presentations may be *attached*.

Figure 5-4: Sample Presentation Data Base Structure

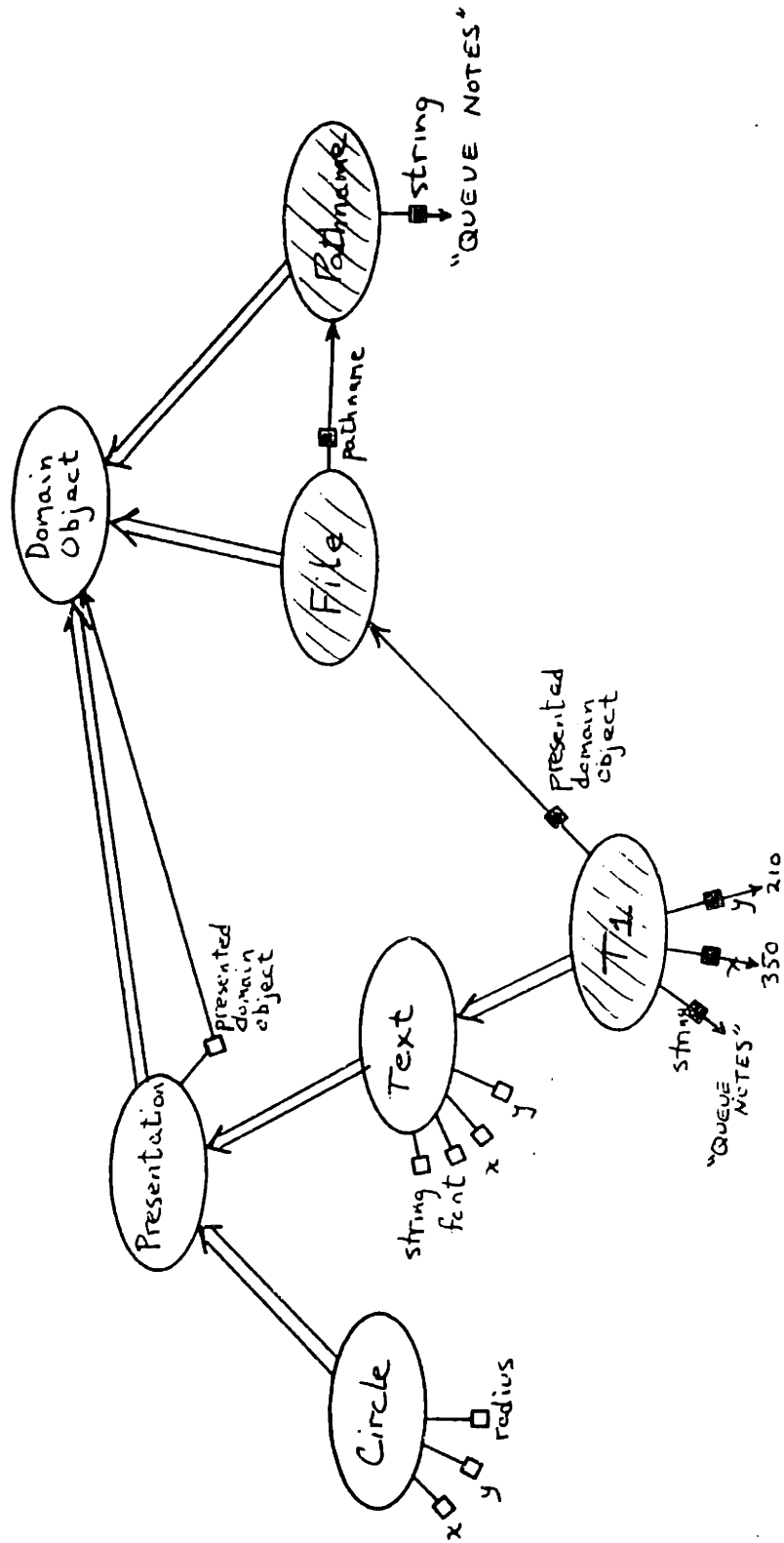
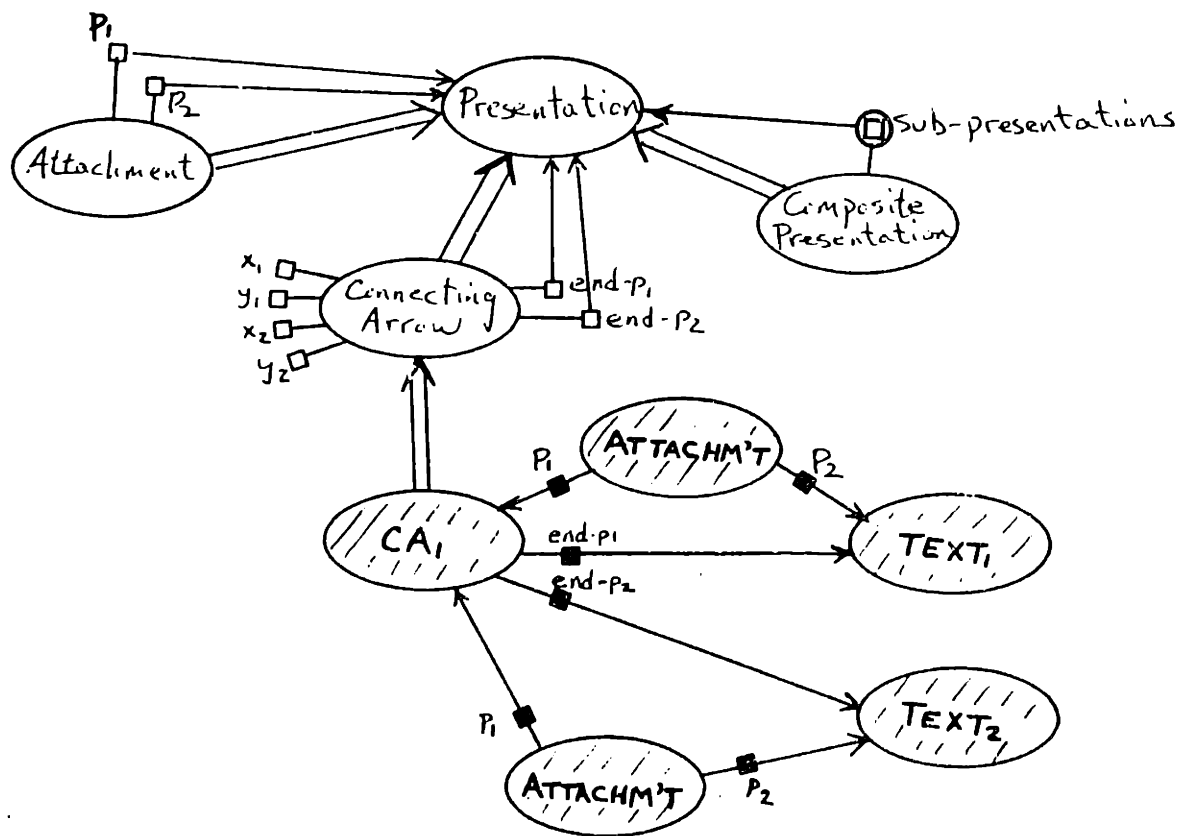

Figure 5-5: Inter-Presentation Relationships



Connecting arrows cause themselves to be attached to their end presentations; in general, any two presentations may be attached. The attachment relationship is asymmetric and has the following meaning: $p1$ attached to $p2$ implies that $p1$ is repositioned or deleted whenever $p2$ is repositioned or deleted, respectively. In the figure connecting arrow *CAI* is shown connecting *Text1* and *Text2*. If *Text1*, say, is moved, *CAI* will have its end positions rederived. The arrow will be redrawn, and the arrow will remain connected to the two pieces of text.

The important fact about this scheme for structuring the presentation data base is that the general data base mechanism is being used, rather than a representation tailored to particular kinds of pictures. The presentation data base fits within an overall data base network with a uniform method of organization.

This has four implications. First, the data base mechanisms can be shared. Second, the data base mechanism does not limit the kinds of presentations that can be used -- the network can be extended by the interface builder to add new kinds. Third, ancillary information about the presentation can be recorded; such information can be useful to presenters, recognizers, and presentation editing commands that need to make decisions about the presentation. Fourth, the presentation data base can itself be treated as an application data base -- it can be presented.

The last of these is important for matching the structure of the implementation to the structure of the model. One kind of example is the cascaded presentation systems of Zmacs and Xerox Star as modeled in chapter four.

Command Description Support. PSBase has a mechanism for describing commands in the data base and connecting these descriptions to the actual Lisp machine functions. User options (Lisp variables) can also be described, and command documentation can refer to these variable descriptions. Variable descriptions themselves can have associated documentation.

The classes of description involved are shown in figure 5-6. The primary kinds of objects

Figure 5-6: Command Description Support

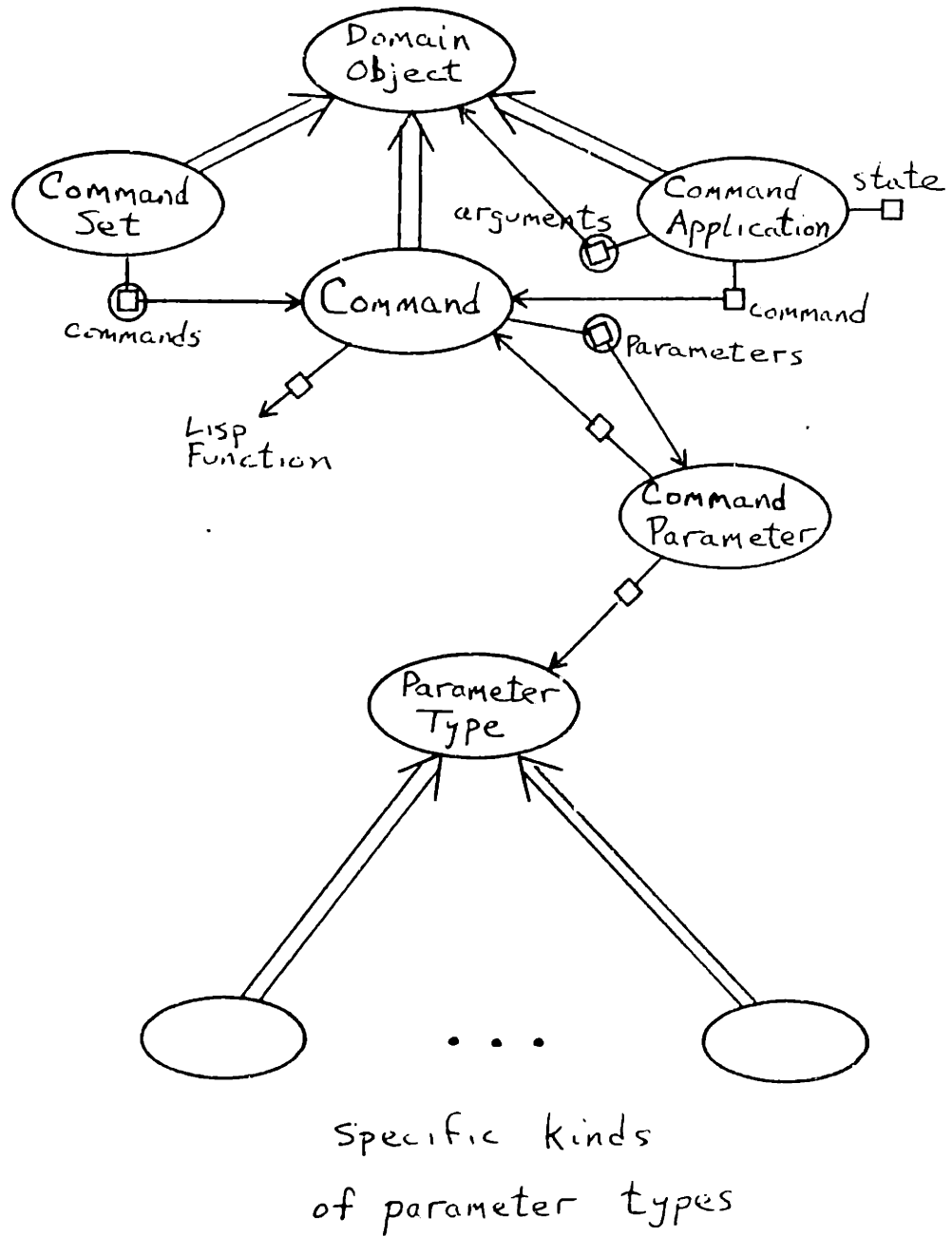

are *commands*, describing Lisp functions, *command sets*, describing groups of related functions, and *command applications*, describing the invocation of a Lisp function with a list of arguments. A command application has a *state*, which specifies whether the function has not yet been invoked on these arguments, is currently being executed, or has completed. Functions may be invoked by building a command application description and then, using the Lisp machine's flavor-system message-passing, sending the command application object an *execute* message.

In addition to the properties shown in the figure, commands also include properties specifying the name, documentation, sub-commands, variables used, and the verbs that may be used to describe the command.

Each command description includes a list of parameter descriptions, which must match the arguments given to the command application. The command application object checks its arguments for validity when it is formed. Each command parameter description includes properties specifying name, documentation, and a description of the type of the argument required. There are several specializations of *command parameter type*, one for each kind of argument that may be supplied to user commands.

For example, one of the Lisp functions printing files takes two arguments: a file and a printer, which is to say two instances in the application data base, a file instance and a printer instance. The command instance for this function includes a list of two parameter descriptions that describe these restrictions: the first parameter specifies the type *file*, and the second parameter specifies the type *printer*. To invoke this function, a command application instance is created, its argument list containing the particular file and printer instances. As the command application is formed, the arguments are automatically checked against the parameter types for validity. The command application is then sent the *execute* message, causing the function to be applied to the arguments, and the file is printed.

Execution Monitor. The command description mechanism is extended by automatic connections to the Lisp environment, for use by the PSBase execution monitor. When a command instance is created, the Lisp function it corresponds to is automatically modified

so that the execution monitor is notified when the function is invoked and when it returns. The execution monitor maintains a stack indicating the current execution state in terms of the described procedures. In addition, command application descriptions are placed on the stack while they execute.

Reference Resolution. Presenters and recognizers must often resolve a presentation reference to an instance in the data base of a particular type (or, in general, to an instance that satisfies some predicate). In the simple case, the value of the presentation's *presented domain object* property is of the correct type and no resolution is needed. For cases when this is not true, PSBase includes a mechanism for finding a related data base instance that is of the correct type.

An example will serve to introduce the three kinds of resolution provided. The user invokes a command that requires a directory as one of its arguments: the user selects a presentation as this argument. In the simple case, the presented domain object property links the presentation to a directory, and the resolution is trivial -- just follow the presented domain object link. Figure 5-7 illustrates this case and the others to be discussed. The dotted arrow indicates the path followed by the resolution mechanism in order to reach the directory instance. (It is the directory instance in all cases that will be returned by the resolution mechanism.)

The first (and most common) kind of resolution applies when the presented domain object is a property, and the property's value is of the desired type. Resolution is to the *property's value*. In the case illustrated in the second part of figure 5-7, the user has selected a presentation of the directory property of a file.

The second kind of resolution applies only to certain kinds of properties, termed *essential properties*. These are properties for which the value is, in some sense, equivalent to the object owning the property -- equivalent in terms of its use as a referent. The pathname property of a file is essential -- any name property is. (Specifying which properties are essential is part of the task of defining the application data base class network.) For essential properties, the resolution mechanism walks to the owning object. In the case

Figure 5-7: Reference Resolution

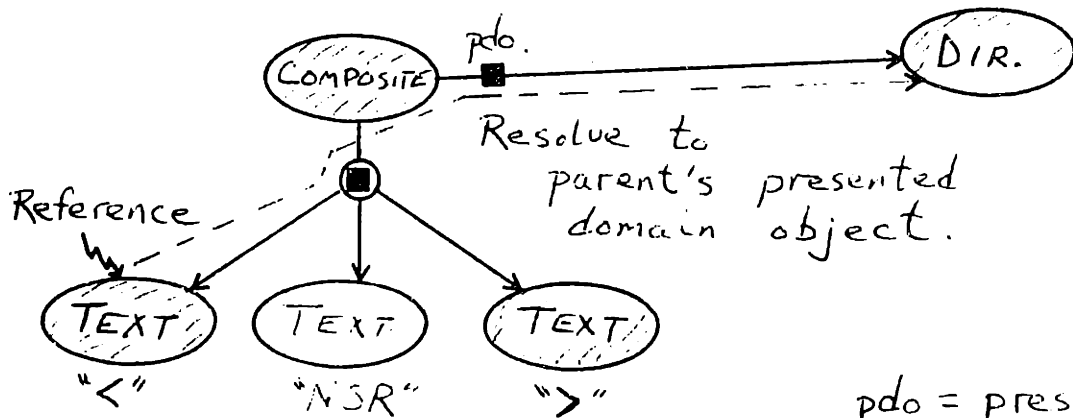
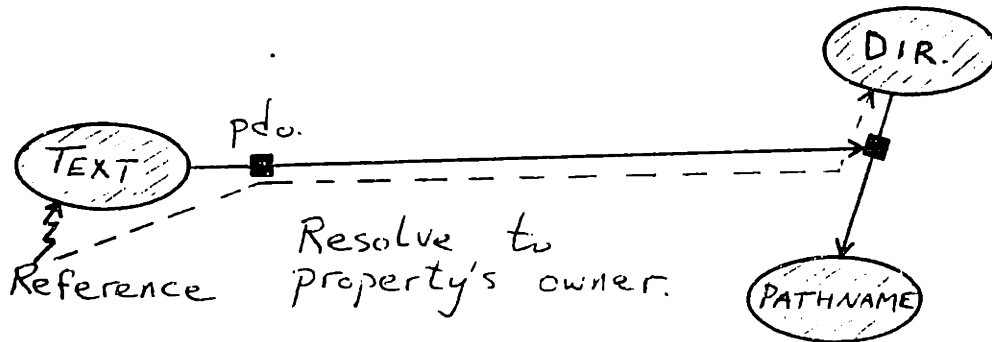
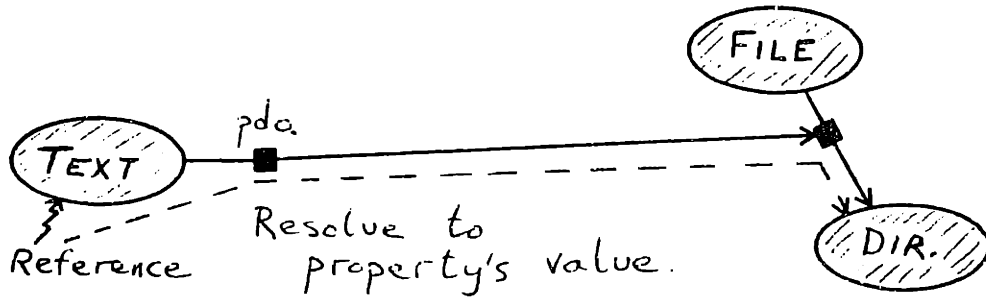
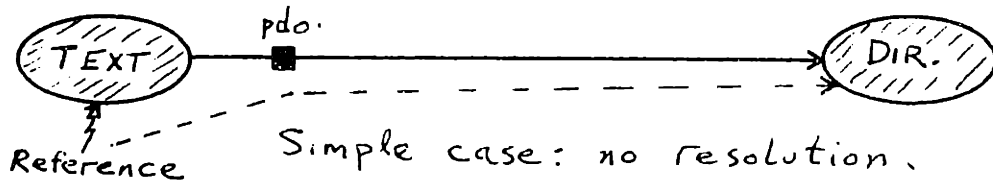

pdo = presented domain object

illustrated in the third part of figure 5-7, the user has selected a presentation of the name of the directory.

The third kind of resolution walks up the presentation hierarchy, from the referenced presentation to the composite presentation that contains it, looking for a satisfactory presented domain object. In the case illustrated in the fourth part of figure 5-7, the user has selected a presentation that is a part of a directory presentation, but which does not itself present something that can be resolved to a directory.

5.2 Graphics Redisplay

This section discusses the next PSBase module shown in figure 5-2, an incremental graphics redisplay mechanism that has the responsibility for continually displaying the presentation data base. The graphics redisplay module maintains a description of the forms drawn on the screen. It continually compares this with the presentation data base description. Those presentations whose defining properties have changed are redrawn and the screen description is updated, new presentations are drawn, and deleted ones erased.

Each presentation instance has a timestamp that is automatically set whenever any change is made to that presentation. Graphics redisplay restricts its attention to those presentations that have changed since the last graphics redisplay. Composite presentations are marked changed whenever one of their sub-presentations is changed. Therefore, the search for changed presentations is substantially reduced: entire composite presentations can be skipped by a single check of the composite presentation's timestamp.

Graphics redisplay connects the presentation data base to the Lisp machine's graphics package (extended slightly for PSBase). The defining properties of the forms to be drawn or erased are passed as arguments to the appropriate drawing procedures.

5.3 Presentation Editor Functions

PSBase offers a set of presentation editing functions that as a whole can be used as a general presentation editor, or the functions can be selectively combined as part of a specific user interface. The presentation editor functions are independent of the data base domain, presenters, recognizers, and their styles. The editor functions also have a history-keeping mechanism that records commands used and the presentations affected. This history is used by some editor functions (e.g., the command to undo a previous erase command) and by other PSBase modules if needed (e.g., a recognizer may need to inspect the editing history).

The presentation editor is a combination of a text editor and a diagram editor. The user can place text at any point on the screen and use Emacs-like commands to edit the text. There are only a few such text-editing commands in PSBase. However, this is due to the limited nature of the project, and not to any inherent limitations. A full-scale presentation system base following this approach would include a much larger editor module. The diagram-editing capabilities in PSBase include the following:

- * Creating lines and arrows between two positions or between two presentations
- * Creating ellipses, circles, and rectangles
- * Creating an ellipse or rectangle around a given presentation, computing the size and position from the presentation
- * Moving a presentation to a new position
- * Erasing a presentation or undoing an erase
- * Attaching or unattaching two presentations and presenting attachments visually
- * Aligning one presentation with another, by center or edge positions

5.4 Presenter Support

This section discusses three kinds of presenter support provided by PSBase: first, a data base mechanism for describing certain properties of presentation styles, second, three general semantic presenters that are driven by these style descriptions, and third, some

organizational presenters that may be independently combined with the semantic presenters in order to specify a style's layout method.

Presentation Style Descriptions. A presenter has an associated style, which describes how the presentation is structured and related to the presented information. There are four basic classes of style descriptions in the current PSBase implementation:

Primitive presentation styles do not refer to other presentation styles, nor do they describe the structure of the presentation. Instead, they specify a procedure that creates it (a "canned" presenter). One goal of PSBase is to reduce the number of primitive presentation styles that must be written, as they require considerably more effort than do the other styles discussed here.

Graphical presentation styles do not refer to other styles either, but do include a specification of the presentation forms and their properties. These properties may be computed from properties of the presented domain object and from properties of the composite presentation being constructed.

Sequence presentation styles specify how to present sequences of objects in the application data base. For instance, a directory contains a sequence of files, along with other properties of the directory, such as its name and protection. Sequence presentation styles specify a presentation style to use for the element presentations. They also optionally may specify prefix, infix, and suffix presentations to separate the presentations of the elements of the sequence.

Template presentation styles build larger presentation styles out of a fixed number of smaller ones, interspersed with text presentations that do not present any domain information, but merely serve as the template.

Each kind of style description also specifies a style name, the class of domain object (in the data base network) for which this style is appropriate, a flag specifying whether this is the default style for that class, information concerning semantic redisplay, and an

organizational presenter. Since domain object classes can be specialized, styles can apply to a wide variety of objects or to just a specific few. One can think of presentation styles as being attached to classes in the data base. These attachments drive the process of selecting a suitable presentation style.

For example, PSBase provides a very general presenter, called the phrasal presenter. This presenter produces (in most cases) noun phrases for a given domain object. This style description for this presenter specifies that it applies to the class *domain object*, i.e., it applies to any instance in the data base. This applicability derives from the fact that the phrasal presenter can always produce something -- at least something of the form "a" followed by the name of the domain object class, e.g., "a file". Furthermore, it takes advantage of the uniformity of the description mechanism and inspects the properties of the object to see if it has any property that is a kind of name. If so, it uses the name, e.g., "the file OZ:<NSR>QUEUE.NOTES.1". The phrasal presenter will be more fully discussed below.

On the other hand, another presentation style applies to the specific class *time of day*, producing text presentations such as "02:04:46".

The presentation style mechanism supports two major operations, finding a named presentation style and finding the most specific presentation style applicable for a given instance in the data base. Typically, several styles have a matching class, i.e., attach to classes to which the instance belongs. The one with the most specific matching class is chosen. (E.g., *time of day* would be preferred over *domain object* if both match.) If there are two or more styles with the same, most-specific class, the default is chosen. Styles that are not defaults are invoked specifically by name. In a larger presentation system base the comparison could be more involved, taking into account specific properties of the domain object to be presented.

Style-Driven Semantic Presenters. PSBase offers three semantic presenters whose behavior is determined by the kinds of style descriptions described above. It also provides a *semantic redisplay* mechanism that periodically invokes the presenters so that they update existing presentations. Examples of the three major kinds of style descriptions will be used

to discuss the action of their associated presenters.

The first example is a simple clock presentation. The presented domain object is the *current time of day* instance in the application data base. Here, the presentation is a composite of two sub-presentations, a circle (the face of the clock) and a vector (the hour hand). In this simple clock there is no minute hand and there are no text labels on the face. The following is what the interface builder would write to construct this presentation style (the small function *angle-from-hours-and-minutes*, which performs the simple trigonometric calculations, would also have to be written):

```
(def-graphics-presentation-style CLOCK TIME-OF-DAY nil t 120
  ((NIL
    (circle-presentation
     :x (relative-to-parent-x 25)
     :y (relative-to-parent-y 25)
     :radius 25))
   (:HOURS
    (vector-presentation
     :length 14
     :angle (angle-from-hours-and-minutes
             (send presented-domain-object ':hours)
             (send presented-domain-object ':minutes))
     :x1 (relative-to-parent-x 25)
     :y1 (relative-to-parent-y 25))))))
```

The first line specifies five general parameters: the style name, the applicable domain object class, a flag specifying whether this is the default style for that class (*nil* here indicating that it is not the default), and two parameters for semantic redisplay. The first of the two, *t*, is a flag specifying that this is an active presentation and therefore should be updated periodically. The second, 120, specifies how often it should be updated, every 120 seconds. (This updating will be discussed below.)

Next is a list of presentation specifications. The first one specifies the circle. The *nil* indicates that the circle does not present any domain information. Then comes a Lisp property list, (*circle-presentation ...*), specifying that this presentation is a circle and specifying its properties. For instance, the first property specified is the *x* coordinate of the circle's center. Its value is given by a form to evaluate, which relates the circle's position to the composite's position (which generally is its upper-left corner).

Next is the specification of the hour-hand vector. The first item gives the property this presentation presents, namely, the *hours* property. The property list for the vector is similar to the one for the circle, except that it has a more complicated form to specify the angle. In particular, it has two message-passing forms that access properties of the presented domain object. (The symbol *presented-domain-object* will be bound to the composite presentation's presented domain object.) The first, for example, (*send presented-domain-object ':hours*), retrieves the value of the *hours* property of the presented *time of day* object.

The following is what the interface builder would write to create a presentation style, named *set-notation*, for presenting instances of the *object-sequence* class:

```
(def-sequence-presentation-style SET-NOTATION OBJECT-SEQUENCE
                                nil nil nil
  "{" " ", "  }"
  just-name
  :horizontal-layout
  :border-box)
```

An object-sequence has an *elements* property containing a list of objects. For example, if this were a list of objects with the names *ONE*, *TWO*, and *THREE*, the sequence would be presented in this style as

```
{ONE, TWO, THREE}
```

The first five arguments are the same as for the graphical presentation style. (In this case, the last two *nils* indicate that the style is not active, i.e., it will not be periodically updated.)

The third line of the definition specifies that there will be prefix ("{"), infix (" ", " "), and suffix ("}") text presentations. The fourth line, *just-name*, names the style to use for presenting the elements. The fifth line, *:horizontal-layout*, names the organizational presenter to use, so that in this case the element presentations will be laid out horizontally (with the infix presentations interspersed). The last line, *:border-box*, specifies that a rectangle should be created, fitting around the presentation.

The following is an example of the last of the three style descriptions, a template style for

presenting objects of the class *time*:

```
(def-template-presentation-style DEFAULT-TIME TIME t
  " "
  (:date default-date)
  (:time-of-day default-time-of-day))
:horizontal-layout)
```

The presenter constructed produces composite presentations that look like "04/15/84 14:22:65". The name of the presentation style is *default-time*. The *t* after the name indicates that this is the default style for class *time*.

The next three lines specify the domain collector and semantic presenter, building the template and specifying the sub-presentations' presenters. The domain collector is described by naming the properties of the *time* object whose values should be collected. (In more complicated presenter specifications, this can be a list of properties, "walking" from one domain object to another, starting from the object being presented.)

The first specification, *(:date default-date)*, causes the *date* property of the time object to be presented as the first sub-presentation, using the style *default date*.

The second specification is a text string containing a single space. This causes the composite presentation to contain that text as a constant sub-presentation. (I.e., it does not present any domain object -- it is just part of the template.)

The third specification, *(:time-of-day default-time-of-day)*, causes the *time of day* property to be presented as the third sub-presentation, using the style *default time of day*.

The last form specifies the organizational presenter, namely *horizontal layout*. This takes the presentation structure created and positions the three sub-presentations within the composite presentation, juxtaposed horizontally.

The template below illustrates the use of the property-walking capability that can be used in presentation styles. The examples given previously have all specified a direct property of the presented domain object, e.g., the hours of the time, or the elements of the object-

sequence. However, in general it is necessary to specify a *property path*, a list of properties to follow, starting from the presented domain object.

Here, a presenter is created for the class *user-at-host*, and the style is named *RFC733-User-At-Host*. ("RFC733" is the name of a network protocol, which includes this format for specifying recipients.) This produces a form of electronic mail address, such as: "Norman S. Rafferty <NSR at MIT-OZ>". Figure 5-8 shows a sample section of the data base network.

```
(def-template-presentation-style USER-AT-HOST
                                RFC733-USER-AT-HOST
                                nil
                                (((:user :personal-name) default-name)
                                 " <"
                                 (:self simple-atword-user-at-host)
                                 ">")
                                :horizontal-layout)
```

The specification *((:user :personal-name) default-name)* tells the domain collector to walk from the *user at host* object to its user and from there to the user's personal name. The result is presented in the *default name* style; for the example in the figure, it is the string "Norman S. Rafferty". The *:self* "property" in the second domain collector specification means that the *user at host* itself is to be presented, rather than one of its properties. Thus, the composite presentation, which presents the *user at host*, will have a sub-presentation that also presents that *user at host*, though in a simpler style: "NSR at MIT-OZ".

Organizational Presenters. PSBase provides four general organizational presenters, and these may be combined with any of the semantic presenters by the style description. Each organizational presenter positions the sub-presentations of a composite presentation according to a specific layout method.

The first has already been mentioned above: the horizontal organizational presenter positions the sub-presentations in a horizontal line, each presentation juxtaposed against the right edge of the previous one. This organizational presenter, as well as the others, takes advantage of a facility provided by the presentation data base mechanism: each presentation can be asked for its *extent*, a specification of the upper-left and lower-right

Figure 5-8: Result of a Presentation Style

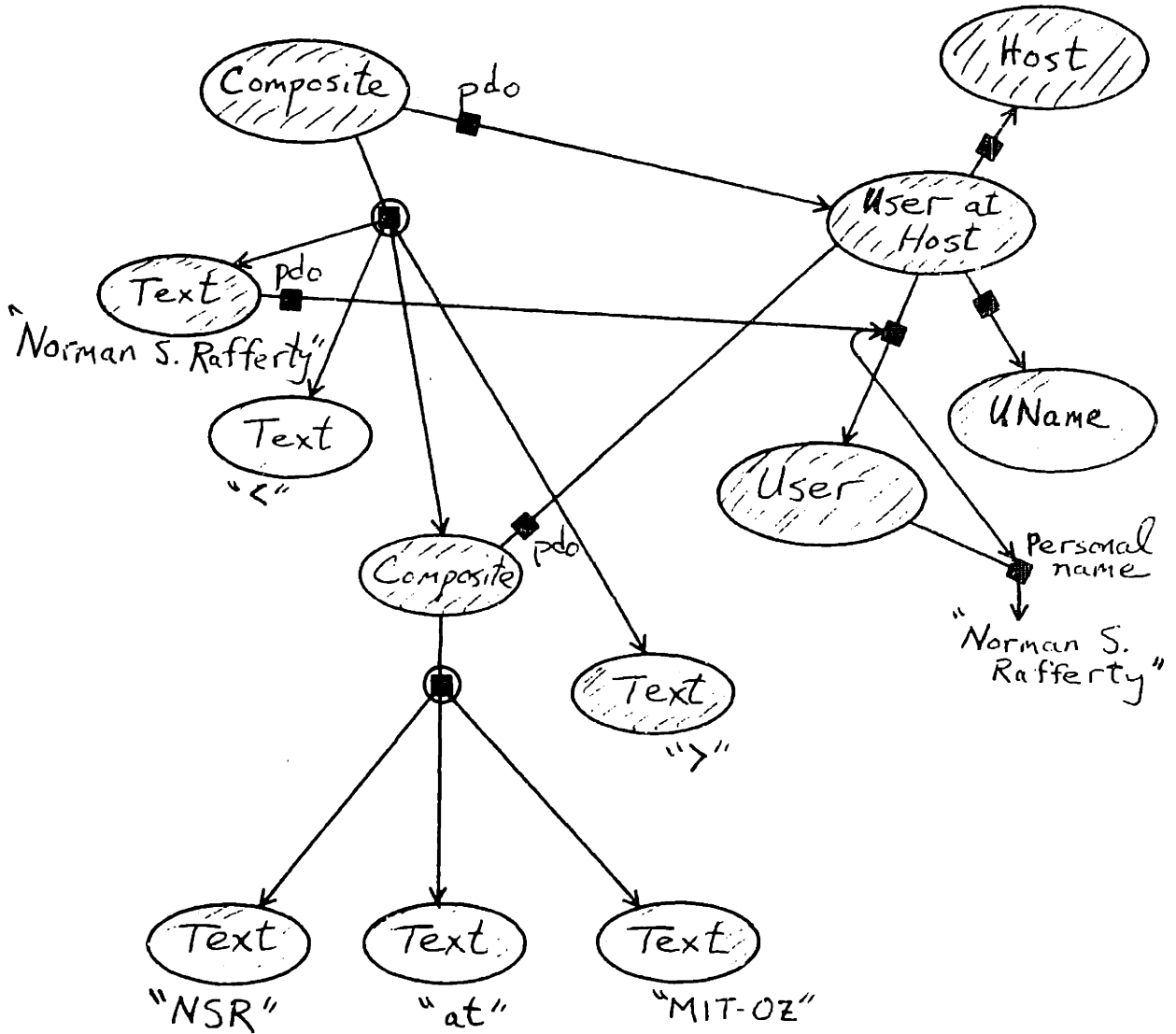

pdo = presented domain object

corners of a rectangle that would enclose the presentation. In addition, the presentation editor mechanism offers a general facility for moving presentations. Using these capabilities, the organizational presenter does not need to consider the particular kind of presentation: the presentations are moved so that their extent boxes are juxtaposed. Note that the extent box technique works as well for sub-presentations which are themselves composites of further sub-presentations: the entire composite has an extent computed from those of its sub-presentations.

Similar to the horizontal layout presenter is the vertical layout presenter. It juxtaposes sub-presentations vertically, again using the extent boxes as a guide.

The third organizational presenter uses a tabular layout method. The composite presentation is assumed to have sub-presentations which will be the rows of a table. These row presentations will be laid out vertically. Furthermore, each row presentation is itself a composite (in general), whose sub-presentations are the elements of the row. These element presentations are positioned so that those presenting the same kind of property are aligned under each other. For example, in a directory listing, those presentations presenting file-length properties appear aligned under each other.

The fourth organizational presenter is a paragraph filler, positioning the sub-presentations (generally single-word text presentations) within a rectangular area.

The PSBase graphics presentation style descriptions do not use standard organizational presenters. Instead, the styles define their own layout in the style description itself by explicitly positioning the component presentations.

Semantic Redisplay. Each presentation style specifies whether presentations created in that style will be *active*, i.e., whether it is to be periodically updated, and if so, how often it is to be updated. Thus, for example, an active sequence presentation will be updated to reflect changes in the elements or in the order of the elements of the presented sequence. Or, for the clock example given above, the properties of the vector presentation (the hour hand) will be recomputed from the presented current-time-of-day object.

Each time an active presentation is created, a *semantic redisplay task* is created for it and added to a list of all current semantic redisplay tasks. Each task specifies the presentation, its presentation style, and the next time that the presentation should be updated.

A background process manages these semantic redisplay tasks. When a task's semantic redisplay time has arrived, the presenter for its presentation style is invoked on the presentation. This invocation is similar to, but slightly different from, that for creating the presentation in the first place. Here, emphasis is on retaining presentations that can be re-used and avoiding computation for presentations that do not present anything. After updating the presentation, the presentation style's organizational presenter is invoked again to adjust the presentation's layout.

5.5 Recognizer Support

PSBase provides two kinds of support for recognizer control: First is a mechanism that records the presentations on which a particular recognition depends. The dependency mechanism allows some recognition to be retracted if changes occur in the presentations that recognition was based upon. Second is a recognizer-invocation mechanism.

PSBase divides recognizers into three kinds, differing in how and when they are invoked. *Continual recognizers* have the effect of acting continually as the user gives commands. *General recognizers* are invoked on demand, by particular commands. Invocation of general recognizers is slower than for continual recognizers, and the invocation involves consideration of a larger portion of the presentation data base. PSBase offers two invocation mechanisms, one for continual and one for general recognizers. The remaining recognizers are invoked specifically by other recognizers, to perform particular sub-tasks in the recognition process.

Recognition Dependencies. Each recognition depends on a set of presentations. For example, section 4.1 described the Emacs Dired style of annotations to a directory listing: the user places a "D" by files to mark them for later deletion. Recognition of a "D" (as a plan to delete a particular file) depends on two presentations: the "D" and the file

presentation. If the user moves that "D" to a different line, however, its original recognition must be retracted and new recognition performed -- it now presents a plan to delete a different file.

The PSBase recognition dependency mechanism allows recognizers to record the presentations on which they depended, together with the actions necessary to retract that recognition. Recognizers specify this information as they build the application data base commands.

Invocation of Continual Recognizers. The interface builder specifies a list of continual recognizers. Each is invoked immediately after each keystroke or mouse command.

Each continual recognizer has two phases. First, it quickly decides whether it is in fact applicable to the command that the user just gave. Second, if applicable, it *triggers* and performs whatever recognition is necessary.

The recognizer has access to the presentation editing history entry for the command just completed. It also has access to the list of recognizers triggered so far, if any. The latter allows the recognizer to trigger dependent on whether or not others did. The presentation editing history entry specifies what kind of editing function was performed and which presentations were affected by it. This information allows the recognizer to quickly determine whether it is applicable, without performing a search of the presentation data base. If the recognizer triggers, it too creates an entry in the presentation editing history, specifying that a recognition was performed, its kind, and the presentations it affected.

Currently, the mechanism for invoking continual recognizers does not use the recognition dependency mechanism, because of efficiency reasons and because the continual recognizers do not in general benefit as much from the possibility of recognition retraction.

Invocation of General Recognizers. A second kind of recognizer invocation mechanism is provided by PSBase for general recognizers. In contrast to the invocation of continual recognizers (including their quick checks for applicability), which considered a fixed set of

recognizers and a small, given set of presentations (those affected by the latest presentation editing function), invocation of general recognizers involves searching the presentation data base and a larger set of potential recognizers.

PSBase supports two kinds of general recognizers. Both are invoked upon a particular presentation, though they may (and typically will) examine other presentations and related domain information in the data base. The first kind of general recognizer interprets user edits to presentations that were created by presenters. These recognizers are typically simple, taking advantage of the existing links from the presentation to the presented domain object. For example, one such recognizer might interpret a change in text presenting the *reference date* property of a file. This recognizer simply parses the text, creates a new date instance, and changes the value of the file property. Note that it does not need to decide between recognition as a date and as something else -- it already knows that it should be a date presentation from the presenter-recorded information, namely, the *presented domain object* property that links it to the file's *reference date* property.

The second kind of general recognizer is invoked upon presentations for which there is no *presented domain object* link, i.e., presentations whose meaning is unknown. This kind of recognizer must determine the kind of recognition to be performed.

Both kinds of general recognizers are attached to classes of presentations in the presentation data base. For example, the parser for a file's reference date property would be attached to the *text* presentation class.

The invocation mechanism begins by scanning the edit history, determining which presentations have changed since the last recognition. Any recognition that depended on those changed presentations is retracted if possible. This has the effect of allowing the user to make changes in a plan (such as the Dired plan of deletions): the effect is incremental recognition of the changes, but no specific recognizers for incremental changes need to be provided.

Second, all presentations that had been created by presenters, but edited by the user

(since the previous general recognition), are collected. For each of these presentations, a general recognizer (of the first kind discussed above) is invoked. Selection of this recognizer is based on the class of the presentation and the kind of property (such as *reference date*).

Third, recognition is performed on all presentations with no *presented domain object* property value, i.e., those presentations that are unrecognized. (Note that some presentations may have been previously recognized, but are now unrecognized because of recognition retraction.) These recognizers are also invoked based on the class of the presentations they are to recognize.

5.6 Basic Style Packages

PSBase offers a supply of presenters, recognizers, and combinations that the user interface builder may choose to use as components in a user interface. In a sense, one such component has already been mentioned: the presentation editor functions, taken as a whole.

Presenters. Three presenters are provided, for presenting command sets as menus, for presenting the execution monitor's current state by highlighting the current command, and for presenting any domain object by a noun phrase. Like the other components described here, these are all independent of any particular application domain. (This is not strictly true, as the first two deal with the domain of commands; however, that domain, like the domain of presentations, is universal in that it is always included in any user interface.)

Command Menus. This component is very simple, consisting of a few style descriptions. Since a command set is a specialization of *object-sequence*, where the *elements* property is a list of command descriptions, a sequence presentation style can be used. The following is the description for a vertical command menu style. (The style definition for horizontal menus is similar.)

```
(def-sequence-presentation-style VERTICAL-COMMAND-MENU
                                COMMAND-SET t
  nil nil                        ; Not active.
  nil nil nil                    ; No prefix, infixes, or suffix.
  just-name
  :vertical-layout :border-box fonts:cptfontb)
```

Execution State Presenter. PSBase provides a simple presenter for the execution monitor discussed on page 111. The presenter is invoked whenever the execution monitor places a command or command application instance on its stack, i.e., when the command is executed. The presenter examines the presentation data base to determine whether the command or command application is being presented. If it finds a presentation, it highlights it.

For example, when the user invokes the *erase* presentation editing command, the execution state presenter might find the command presented in a menu of editor commands. Whether the user invoked the command by referencing that item in the menu or by typing the *delete* key, the menu item is highlighted to present the current state.

There are other possibilities. Consider the following scenario: A command's documentation is currently being presented. The documentation comprises three paragraphs, each presenting a step in the command. As that command executes, the execution state presenter will highlight the three paragraphs in sequence. (The presentation of the documentation is not strictly a presentation of the command. The presenter will still consider the documentation presentation as a suitable reference, using a special version of the mechanism for resolving references to essential properties discussed in section 5.1.)

Phrasal Presenter. The phrasal presenter produces a phrase describing a domain object, in most cases a noun phrase such as "the file OZ:<NSR>LOGIN.CMD.4", "a plan to delete the file OZ:<NSR>DEMO.TXT.1", or "the reference date of the file OZ:<NSR>QUEUE.NOTES.1, Friday, March 23, 1984".

The presentations have composite presentation structure that follows the semantic and grammatical structure. The user can therefore reference part of the phrase to indicate a

domain object other than the one presented by the entire phrase. For example, given the reference-date presentation mentioned above, the user could reference just the sub-phrase "the file OZ:<NSR>QUEUE.NOTES.1" and therefore indicate the file, instead of its reference-date property. Similarly, the user could reference just the date.

The interface builder provides a set of dictionary entries, templates used by the phrasal presenter. The phrasal presenter and its dictionary entries are simple in comparison with those developed in natural language systems (e.g., [McDonald 83]). They should, however, give an idea how natural language presenters would fit into a more powerful presentation system base, and the scheme used here is quite useful as it is.

In essence, the dictionary entry hangs off a class node in the data base network. The most specific entry for a given instance is chosen. This section illustrates the phrasal presenter by showing a sample entry for the class of *date* instances. Each *date* instance has four properties: *day of month*, *month*, *year*, and *day of week*. The dictionary entry for *date* refers to dictionary entries for the values of these properties.

The entry is written as the *:phrasal-presenter-dictionary-entry* method for the Lisp flavor *date*, the flavor implementing the *date* class in the data base. The Lisp details below can be largely ignored, since the definition is simply a template. The template has slots that are filled in by evaluating Lisp expressions; these slots are indicated by commas. The values filling the slots may be other filled-in dictionary entries. The result is a grammatically structured tree of text. The tree is annotated with the domain objects being presented.

The definition therefore drives the domain collector and semantic presenter, but has left the text positioning details up to a standard organizational presenter. (The organizational presenter used is the one that fills a rectangular area with the text, as a paragraph would be filled.)

The following is the dictionary entry as the builder would write it, to produce text such as "Thursday, August 9, 1984."

```
(defmethod (DATE :PHRASAL-PRESENTER-DICTIONARY-ENTRY) ()
  '(:SAY ,self
    (:FURTHER-INFO
      (:SAY-PROPERTY (.self :DAY-OF-WEEK)
        ,(phrasal-presenter-dictionary-entry day-of-week)))
      (:SAY-PROPERTY (.self :MONTH)
        ,(phrasal-presenter-dictionary-entry month))
      (:SAY-PROPERTY (.self :DAY-OF-MONTH)
        ,(phrasal-presenter-dictionary-entry day-of-month))
      ", "
      (:SAY-PROPERTY (.self :YEAR)
        ,(phrasal-presenter-dictionary-entry year))))
```

The tree produced has the following items:

- * An identifying symbol, *:say*
- * The presented domain object -- the *date* instance, since *self* will be bound to it
- * A sub-tree, flagged as carrying non-restrictive further information, that accesses the dictionary entry for the *day of week* property, labeled as presenting the *day of week* property
- * A sub-tree that accesses the dictionary entry for the *month* property
- * A sub-tree that accesses the dictionary entry for the *day of month*, similarly labeled as a property presentation
- * Some template text, a comma
- * A sub-tree that accesses the dictionary entry for the *year* property

The sub-trees invoke other phrasal dictionary entries. For the case of "Thursday, August 9, 1984.", the sub-tree entries would produce, respectively, the text "Thursday", "August", "9", and "1984". (These are single words; in general, the sub-trees might themselves specify more complex phrases.)

The general phrasal semantic presenter takes this specification tree and produces a composite presentation structure. Figure 5-9 illustrates the resulting presentation structure and its relation to the data base network. Some very simple anaphora processing is performed if possible (not possible here). Commas are added around the non-restrictive

further-info structures. The first letter is capitalized, and a period is added at the end. The presenter can optionally be invoked to produce a briefer presentation, in which case it ignores the sub-trees marked as further information.

Recognizers. The next two sub-sections describe particular recognizers and recognizer frameworks that PSBase provides, for recognizing presentation editor commands from sketches and for recognizing commands from the movement of presentations.

Curve Recognizers. Presentation editor commands may be invoked in two general ways, by primitive command signals (such as keystrokes or mouse clicks) and by recognition. Section 4.2 showed examples of Zmacs editor commands invoked by recognition: the user can type command names or select commands from a menu.

PSBase offers another kind of extension to the presentation editor: recognition of presentation editor commands by "sketching curves". Figure 5-10 shows the screen's display as the user "sketches" an arrow from the ellipse to the rectangle. The user sketches by moving the mouse, holding a mouse button down until the curve has been completed. The curve is displayed as a set of dots while the user is drawing it. When the button is released, an immediate recognizer interprets the creation of this curve as a presentation editor command, in this case a command to connect the ellipse to the rectangle by an arrow. Figure 5-11 shows the result.

Note that these sketched curves are not just recognized as presentations, e.g., not just an arrow. They are recognized as *presentation editor commands*. This has two advantages. First, the user can understand the semantics of the recognition, since the results are just as if the user had invoked the editor command directly (assuming that the interface provides the user with that editor command). Second, recognition can be more powerful -- it can do more than just create a presentation. For example, one could write a curve recognizer that interpreted a sketched line through a presentation as a command to delete that presentation.

The curve recognizers are, in a simple sense, a series of rules. (This is not a complex rule-based system -- there is no iteration over the set of rules, for instance. Also, these rules

Figure 5-10: Before Curve Recognition

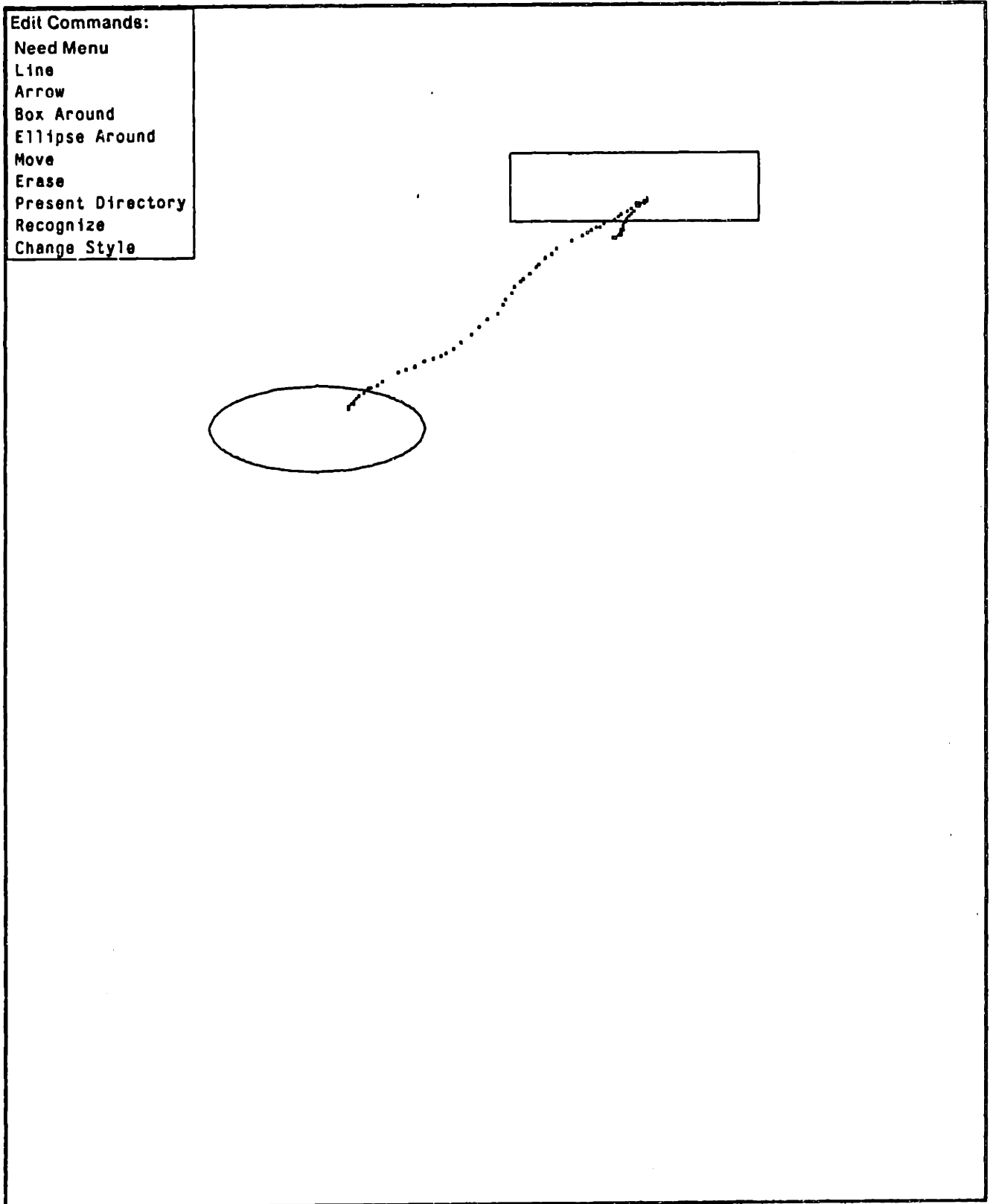
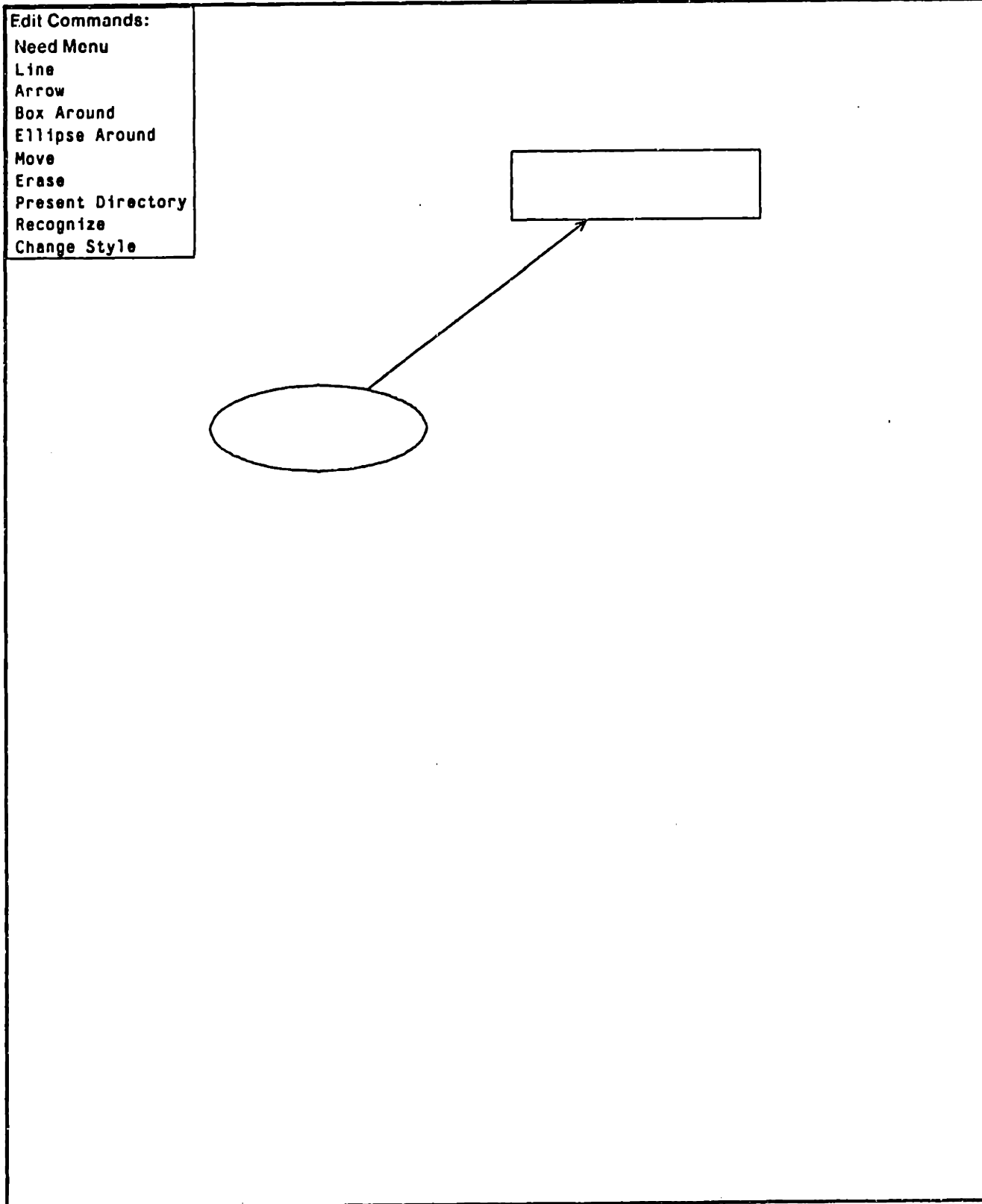

Figure 5-11: After Curve Recognition



do not have declarative patterns, but instead are implemented by special procedures.) The rules are simple, and the success of the recognizers, is due to four, inter-related facts. First, there are few possibilities to distinguish. These will be listed below. Second, the recognition is fast enough to be usually preferred over other ways of invoking the same commands. Third, the user can see the result and change it if the recognizers were mistaken. Fourth, the recognizers are able to use the presentation data base to great advantage. A discussion of the curve recognition rules will clarify the last point.

There are three functions that examine only the list of positions defining the curve. (These functions do not examine the presentation data base.) They are largely responsible for determining the kind of presentation the curve appears most like: line, arrow, circle, ellipse, or rectangle. The first function determines whether the curve is open or closed. The second determines, for open curves, whether there are arrowheads at one or both ends. The third produces a ranked match to a circle, ellipse, and rectangle, specifying the defining parameters (e.g., center and radius for a circle).

These functions are not necessarily always invoked -- they are invoked by the rules, depending on the presentation data base structure. As these determinations are made, a description of the curve is built up and can be used by later rules. The current set of rules first invokes the function to determine whether the curve is open or closed. If open, a rule asks whether the end positions lie within presentations; if so, the curve is an object of class *connecting thing* (line or arrow). If open, another rule determines whether there are arrowheads, and extends the description to distinguish between line, single-headed arrow, or two-heading arrow. Finally, if open and connecting, a rule examines whether the ends can be "pulled out", i.e., whether there is a surrounding ellipse or box. If so, the line or arrow will be connected to that outer form.

If the curve is closed, a rule asks whether the curve encloses a presentation. If so, the recognized command will be *ellipse around* or *rectangle around*. The type is determined either by the style of the diagram (e.g., only ellipses surround text) or by the rule that classifies closed curves. In the latter case, the default parameters for the form are ignored;

the command will compute these from the circumscribed presentation.

There are a few other rules, which deal with particular styles of diagrams. These rules produce editor commands to create particular patterns of presentations.

Move Recognizer Mechanism. PSBase offers a framework for implementing continual recognizers that interpret movement of presentations as commands, in the style of, for example, the Xerox Star and Apple Lisa systems. Section 4.3 illustrated some kinds of move recognition; for example, moving a document presentation to a printer presentation is recognized as a command to print that document.

A *move recognition driver* (or just *driver* when the context is clear) is a predefined continual recognizer; it provides the first phase of a continual recognizer, checking for applicability. It checks for a move command and, if so, determines the presentation being moved and the (possibly several) presentations to which it has been moved. It then matches these possible candidates against a set of patterns that attach to the data base network.

Each pattern has an associated second-phase recognizer, which is invoked if that is the pattern that matches. (In this implementation there is no consideration of multiple matches -- the first entry whose pattern matches is used.) It is this associated recognizer that performs the actual recognition of the move as a data base command. This division of the recognition process follows the division described in section 2.6: the driver is the organizational recognizer, and the selected recognizer is the semantic recognizer.

A sample definition of one of these pattern-to-recognizer associations is the following, the one for recognizing movement of document icons to printer icons:

```
(def-move-recognition-rule move-document-to-printer
  (:overlap (file (document-icon))
            (printer (printer-icon)))
  :recognize-printer-movement)
```

The second and third lines specify the pattern, which consists of three parts. The first part specifies the kind of overlap between the presentation being moved and the candidate destination presentation. This can be, in order of increasing restrictiveness, *near*, *overlap*, or

within. This relation is determined from the presentations' extent boxes.

The next two elements of the pattern specify the class of presented domain object and the presentation styles. This entry specifies that the presentation being moved must present a file in the document-icon style. (Each presentation has properties connecting it to both the presented domain object and the presentation style used to create the presentation.) The entry also specifies that the destination presentation must present a printer in the printer-icon style.

The fourth line specifies the recognizer that will create a command application for printing the file.

Combinations. The next three sections describe modules that combine presenters and recognizers into larger control structures.

Mouse-Tracking Reference. This module provides a mouse-based reference and documentation facility. A simple fast recognizer continually watches the movement of the mouse and determines whether the mouse cursor is within any presentation. This check is made using the presentations' extent boxes; in the case of more than one presentation containing the mouse, the one with the smallest extent box is selected. The presentation data base records this choice.

At the same time, the current choice is presented by being highlighted on the screen. Thus, as the user moves the mouse, the highlighting continually shows what presentation contains the mouse cursor.

In addition, about once every second (i.e., at a rate considerably slower than the operation of the tracking recognizer and presenter just described), a *documentation line* at the bottom of the screen is updated. It presents the current choice by using the phrasal presenter, described earlier. This can help to disambiguate some cases where the highlighting box alone would be insufficient. It can also be helpful in providing documentation about the presentation style -- e.g., to find out that a particular number in a directory listing is the

length of a file. No presentation structure is created for the documentation line -- the result is simply a text string -- though the anaphora and other processing is performed. Further-information sub-trees are eliminated if the resulting string is too long.

An additional reference mechanism is provided that allows the user to move the selection choice up and down the hierarchy of presentations, e.g., moving from a text presentation in a directory listing up to the row presenting a file or to the entire directory presentation. Again, this choice is reflected by the highlighting and phrasal presenters automatically: these commands affect the presentation data base's record of the current choice, which is continually and automatically presented by them.

Open/Close Mechanism. Like the move recognition driver discussed above, this mechanism provides a general framework for implementing opening and closing of domain objects, like that used in the Xerox Star and Apple Lisa styles (see section 4.3). In those systems, opening a document icon, for example, causes the text of the file to be displayed.

Opening and closing domain objects can be thought of as changing presentation styles. The interface builder specifies links between the domain object class and the opened and closed presentation styles. The following specification is typical:

```
(def-open-close-presentation-style file-document
  file
  document-icon
  text-file-contents
  fonts:cptfont)
```

This specifies that for instances of class *file* the *document icon* style will be used for the closed presentation and the *text file contents* style for the opened presentation. The default font for the opened style is also specified.

The open command is given a presentation as an argument and a position. It finds the entry for the presentation, based on the presented domain object, and invokes the presenter for the opened presentation style specified by the entry. The presenter creates the opened presentation at the given position. The original presentation is erased but remembered as a property of the opened presentation. This allows the original presentation to be redrawn

when the opened presentation is later closed, if possible, for efficiency and so that its original position is restored.

The decisions to erase and record the original presentation are a matter of style and are easily changed. This style attempts, by having only one presentation of a domain object at a time, to give a feeling of directness -- that the visual presentation *is* the domain object, and opening is a "physical" act. However, this always-erase rule is probably too simple: there are probably certain kinds of presentations, e.g., icons, that do seem "to be" their presented domain objects, while others, e.g., phrasal presentations, may merely "talk about" them.

Earlier it was mentioned that opening and closing can be considered to be a matter of changing presentation styles. However, there is another consideration that must generally be made: signalling the application data base that more detail is needed from the outside world or that it is time to save such detail. This issue is raised when the application data base is a model of some outside world. An opened presentation typically involves presenting much more domain information than a closed presentation. (For example, a document icon may only be labeled with the file name, while an opened presentation contains the file's text.)

Therefore, the open command also sends a message to the presented domain object to be sure that its contents are fully described and updated. For a file, this may involve getting the file's text. Each class of domain object can provide its own method for handling this message, or inherit a more general one. The default method is to do nothing.

Closing an object requires two actions in addition to the presentation style change. First, recognition of editing changes to the open presentation must be performed. Thus, in general, the user may have changed some of the parts of the opened presentation, and these changes are reflected in changes to the presented domain object's contents in some way. Second, the domain object is sent a message to save its contents. For a file, this involves saving the file's text. Again, the inherited default is to do nothing.

Top-Level Control Structures. PSBase provides two alternative control structures that

processes command signals (keystrokes and mouse clicks), invoke immediate and other recognizers, and cause graphics redisplay to be performed. They differ primarily in the method of command invocation and command argument selection. In the first top-level style, the user first specifies a command, then selects its arguments; in the second style, the user selects the arguments first, then specifies the command.

The first style has the benefit of the command's description while selecting the arguments for the command. The parameter descriptions have control of the selection, prompting the user with the parameter name and documentation, and checking that the argument selected is of the proper type. For example, if the parameter specifies that a file must be selected, it will immediately reject any selection that is not a file, letting the user make the selection again. Though the style as provided does not do this, it would be a relatively simple matter to tailor the mouse-tracking mechanism so that only presentations of the correct type would be sensitive to selection, i.e., only those being highlighted as the mouse moved across them.

The second style collects selected arguments, presenting them by keeping them highlighted until the command is chosen, and then when a command presentation is selected, creates a command application for it, letting the command application check that the arguments are of the proper type.

Each style allows two kinds of mouse clicks to be made: a left-button click selects a presentation or its presented domain object, and a right-button click selects a position. In the second style, positions are highlighted with a small circle-cross mark.

Both styles select commands (as opposed to their arguments) similarly. If the user types a key, that key is translated into a command, using a standard dispatch table. On the other hand, when the user selects a presentation, the top level checks whether its presented domain object can be resolved to a command -- i.e., a simple command recognition is performed. This is, for example, what happens when the user selects an item in a command menu.

Similarly, when the user selects a presentation of a command application, that command

application is executed. In this case, however, the command application already supplies the arguments.

After each selection, whether argument or command, immediate recognizers are invoked, and graphics redisplay is performed if there is no typeahead to process. In addition, the second top-level style executes any command applications that have been accumulated, by recognizers such as move recognizers. On the other hand, the first style allows command applications to be accumulated without, in general, immediate execution. This is the case when those command applications are presented, as just mentioned above. Section 4.1 illustrated such "plan presentations" in Emacs Dired.

5.7 Summary

This chapter opened with some general comments about the benefits of a presentation system base, and in particular, PSBase. Summarizing these briefly: The structure of PSBase is based on the structure of the general presentation system model. This is the source of much generality and modularity, in both PSBase and the interfaces built on top of it. In particular, domain-independent and style-independent parts can be identified and provided in the base. Furthermore, most of the modules in PSBase rely heavily on the uniformity of the data base network, which is used to implement both the presentation data base and the application data base.

Chapter Six

Constructing Presentation Systems

This chapter illustrates the utility of the presentation system base, PSBase, by discussing three user interfaces constructed on top of the base. The interfaces differ in style, but share the same purpose, to provide an interface to the Tops-20 operating system top level [Tops20 80], as does the Exec, Tops-20's normal top level. The sections below will describe how these interfaces are constructed, emphasizing how much of the PSBase mechanism is shared between them and how relatively little needs to be written by the interface builder. (Throughout this chapter, the term *user* refers to the *user of the constructed interface*. The term *interface builder* or just *builder* refers to the person who constructs the interface using the PSBase tools and mechanisms.)

6.1 The User's View of the Three Interfaces

The sections below will briefly illustrate the three interfaces by discussing scenarios in which the user views directories, files, mail, and user information; edits some of these; prints and deletes files; and sends messages. Each scenario has the same fictitious user, Norman S. Rafferty, whose login name is NSR. The host computer is MIT-OZ. The discussion will be accompanied by diagrams showing the screen at various points during the scenarios. In order to save space, not all steps in the scenarios will be shown.

The first interface incorporates a style similar to the Xerox Star discussed in chapter four, emphasizing the manipulation of icons. The second interface incorporates a style emphasizing the use of text displays with associated command menus. The third style incorporates a style emphasizing the use of graphical annotations, an extension of the Emacs Dired style discussed in section 4.1.

The annotation interface is somewhat less complete than the other two in that it offers an

interface to the file system only. This is not an inherent limitation, but instead reflects the fact that the current implementation of PSBase offers less support for building the annotation interface than for building the others.

It is not the intention of this thesis to argue that these particular interface styles are ideal or even good as implemented here. The styles represent three different, important classes of styles. The important point is how these interfaces can be designed, constructed, and changed more easily given a presentation system base on which to construct them.

Icon-Style Interface. The initial screen display of the icon-style interface scenario is shown in figure 6-1. At the top left is a clock, updated every minute. Below it are icons for an in-box (received mail), out-box (for sending mail), two printers (the *Dover* laser printer and a line printer), and a campfire (used for deleting files). Across the top are icons showing the users currently logged in. (One of the user figures is not in his chair. This indicates that the user has not typed anything within the last twenty minutes and is perhaps away from the terminal.) The user.display is updated every few minutes. Below the users are three folder icons, presenting NSR's three directories, *NSR*, *NSR.R*, and *NSR.R.T*. (These happen to be hierarchically nested directories, the directories owned by this user, though any set of directories can be displayed.)

The user *opens* the *NSR.R.T* folder: First, the folder icon is selected, by pointing to it with the mouse and pressing a mouse button. While selected, the icon is displayed in reverse video. The mouse is used to select a position for the opened presentation. The user types a special *open* command key. The folder icon disappears and a new display showing the contents of the directory appears at the selected position, as shown in figure 6-2. This display shows the files in the directory, as a set of document icons, the full directory name, and disk space information. The "6/20221" indicates that this directory uses 6 disk blocks, and 20221 disk blocks remain free.

While this opened directory is displayed, it will be periodically updated. If the number of free disk blocks changes, the "20221" will be replaced by the new amount. Also, the document icons will change if the set of files in the directory changes.

Portions of the text
on the following page(s)
are not legible in the
original.

Figure 6-1: Icon-Style Interface

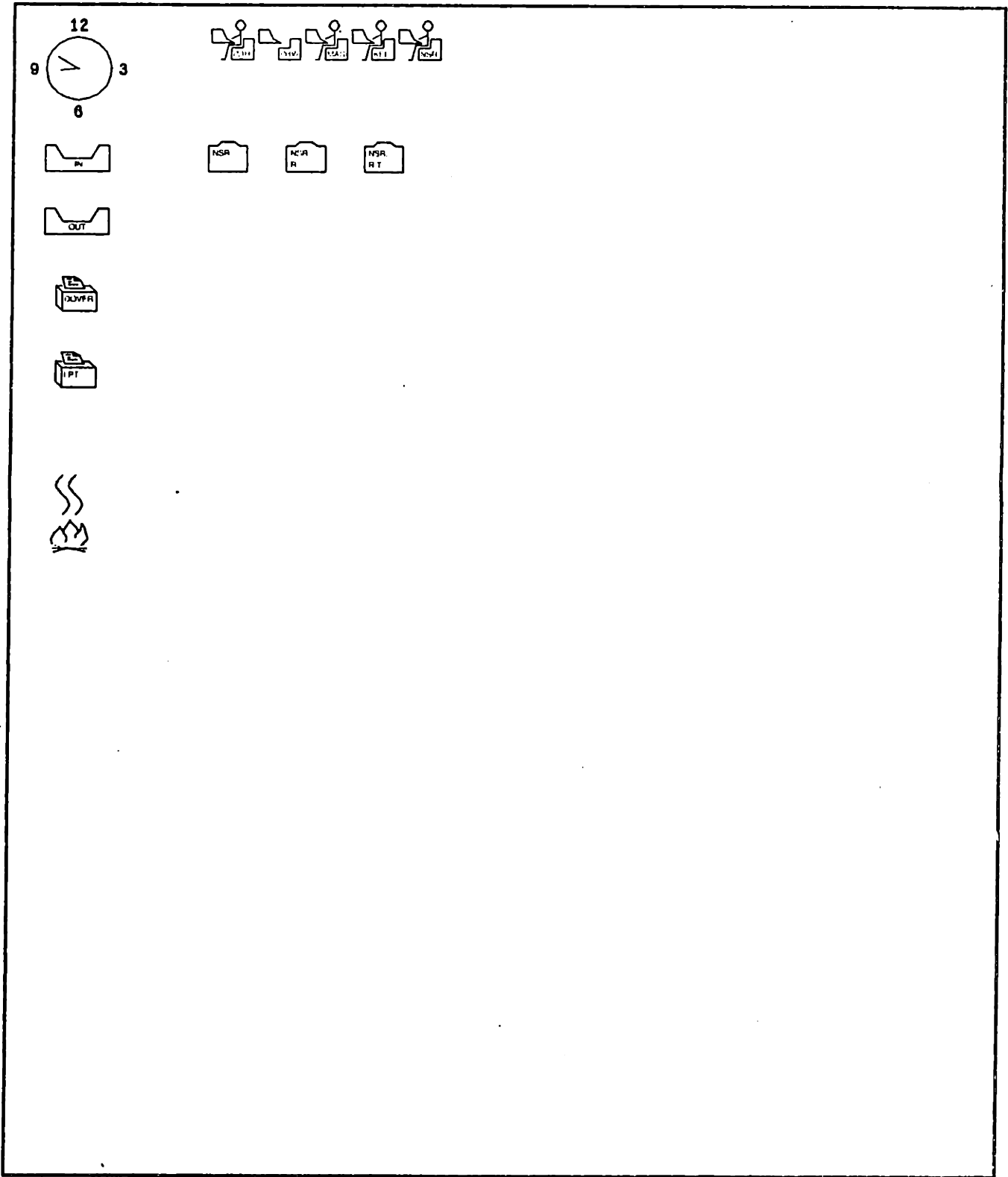
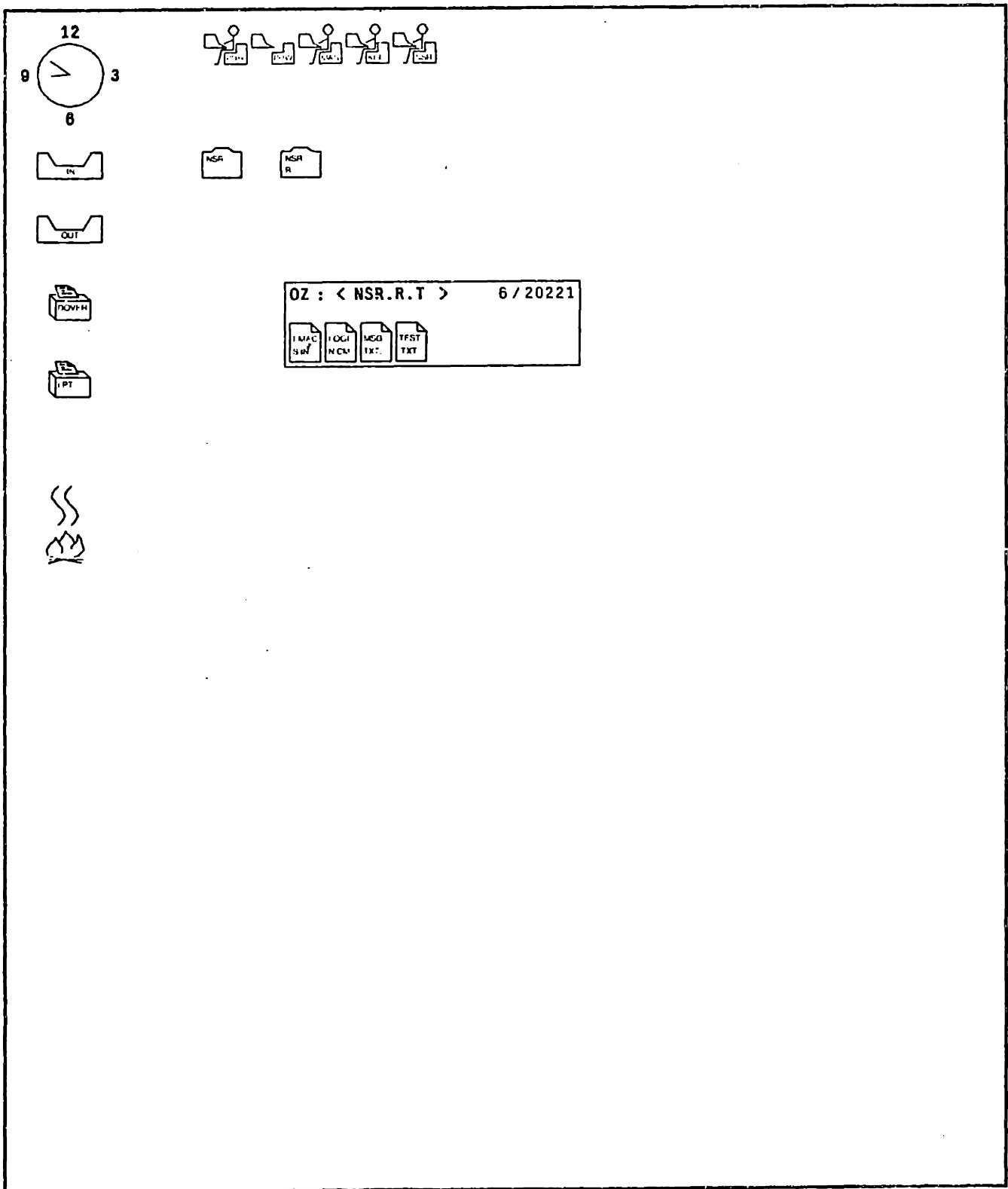

Figure 6-2: Icon-Style Interface



Next, the user opens the file *MSG.TXT*. The process is the same as before: the document icon is selected, a position is selected, and the *open* command key is typed. Figure 6-3 shows the screen at this point. The *MSG.TXT* icon no longer appears in the directory display, since it has been brought out to the *desktop* area and opened. When closed, it will retake its place in the directory display as a document icon.

Figure 6-3 also shows a change in the logged-in user display: the set of users has changed.

The user edits the text of the *MSG.TXT* file. A position within the text is selected, and the *set edit point* command key is typed. A text-editing cursor appears at that place in the text. Editing takes place by using simple Emacs-like command keys. For instance, typing letters inserts them, and typing certain control-characters moves the cursor or deletes characters.

The user also edits the *To* field (i.e., destination specification) at the top of the opened file display. This indicates the user who will receive this file if it is mailed (put in the out-box). This editing is performed in the same manner as the text editing just discussed. The result, shown in figure 6-4, is that the user ECD at MIT-OZ will receive a copy of this file when mailed.

The user now closes *MSG.TXT*, by selecting it and typing the *close* command key. The opened file display disappears, and the document icon reappears in the opened directory.

Next, the file *TEST.TXT* is printed. The document icon is selected, a position at the *Dover* icon is selected, and the *move* command key is typed. The print icon is highlighted to show that the print command has been understood and is underway. (The background process sends a request is made to the host computer to print the file.) The highlighting is then turned off, and the document icon is positioned adjacent to the printer icon. See figure 6-5.

After printing, the user deletes the file by moving the *TEST.TXT* document icon to the

Figure 6-3: Icon-Style Interface

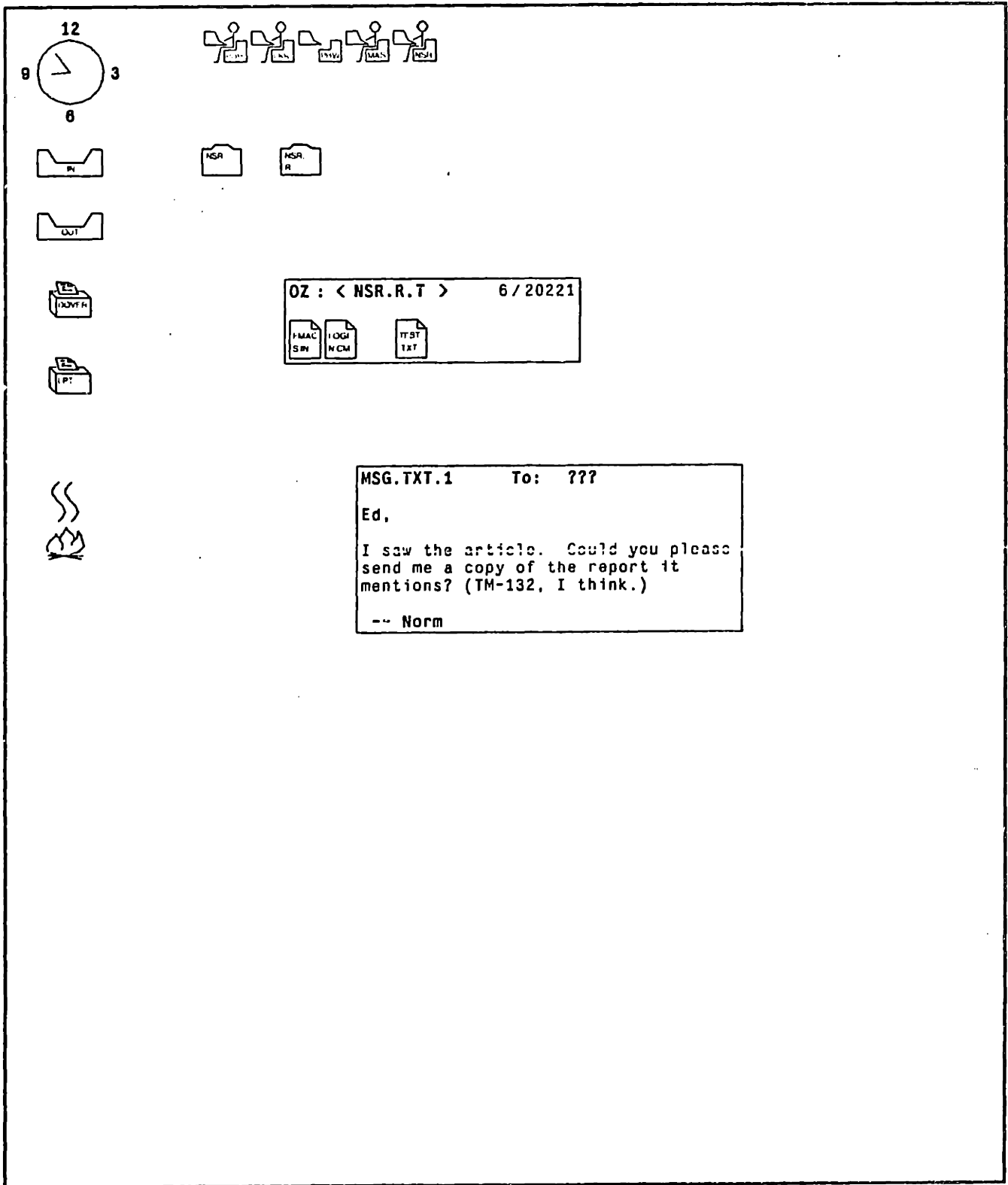

Figure 6-4: Icon-Style Interface

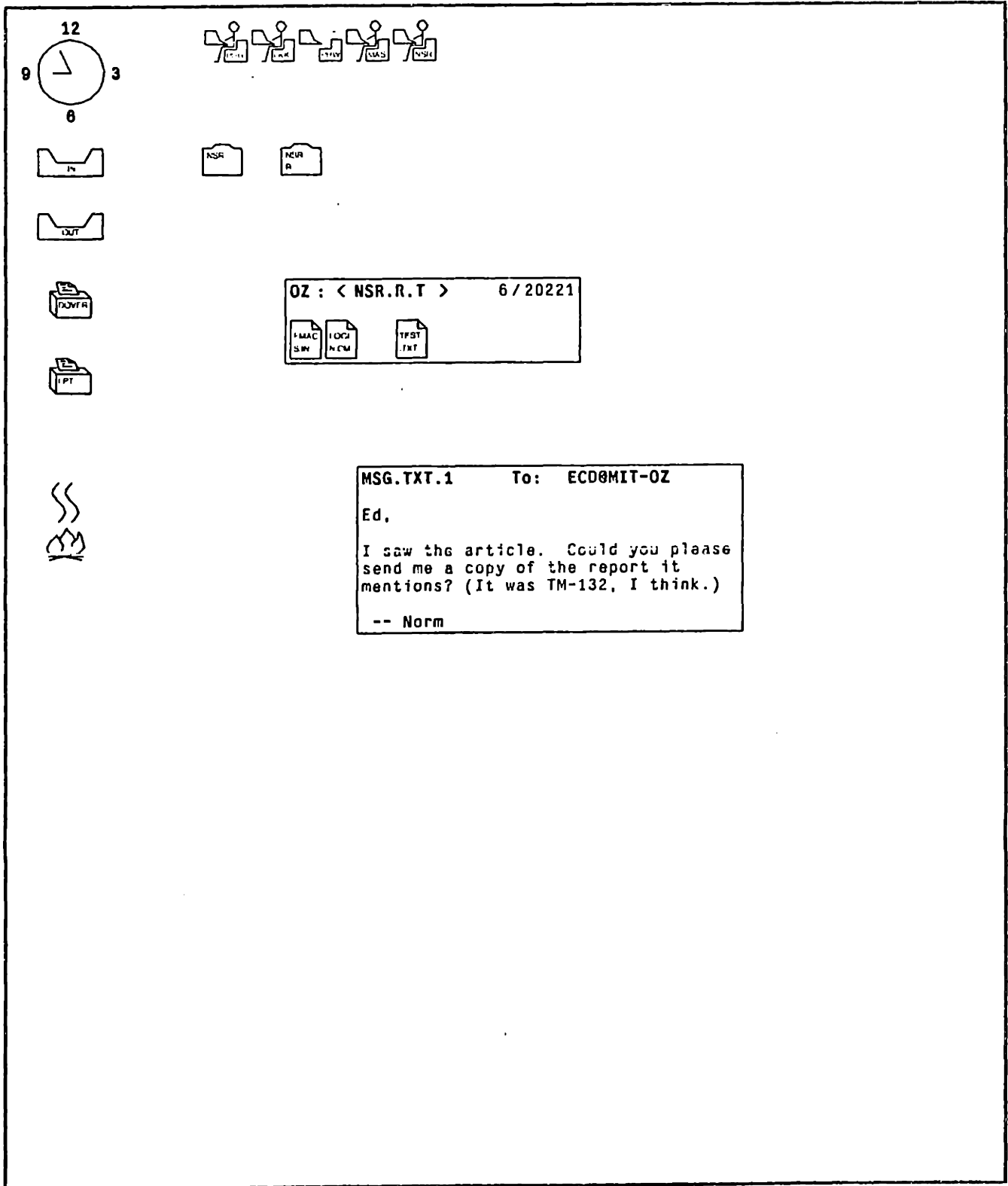
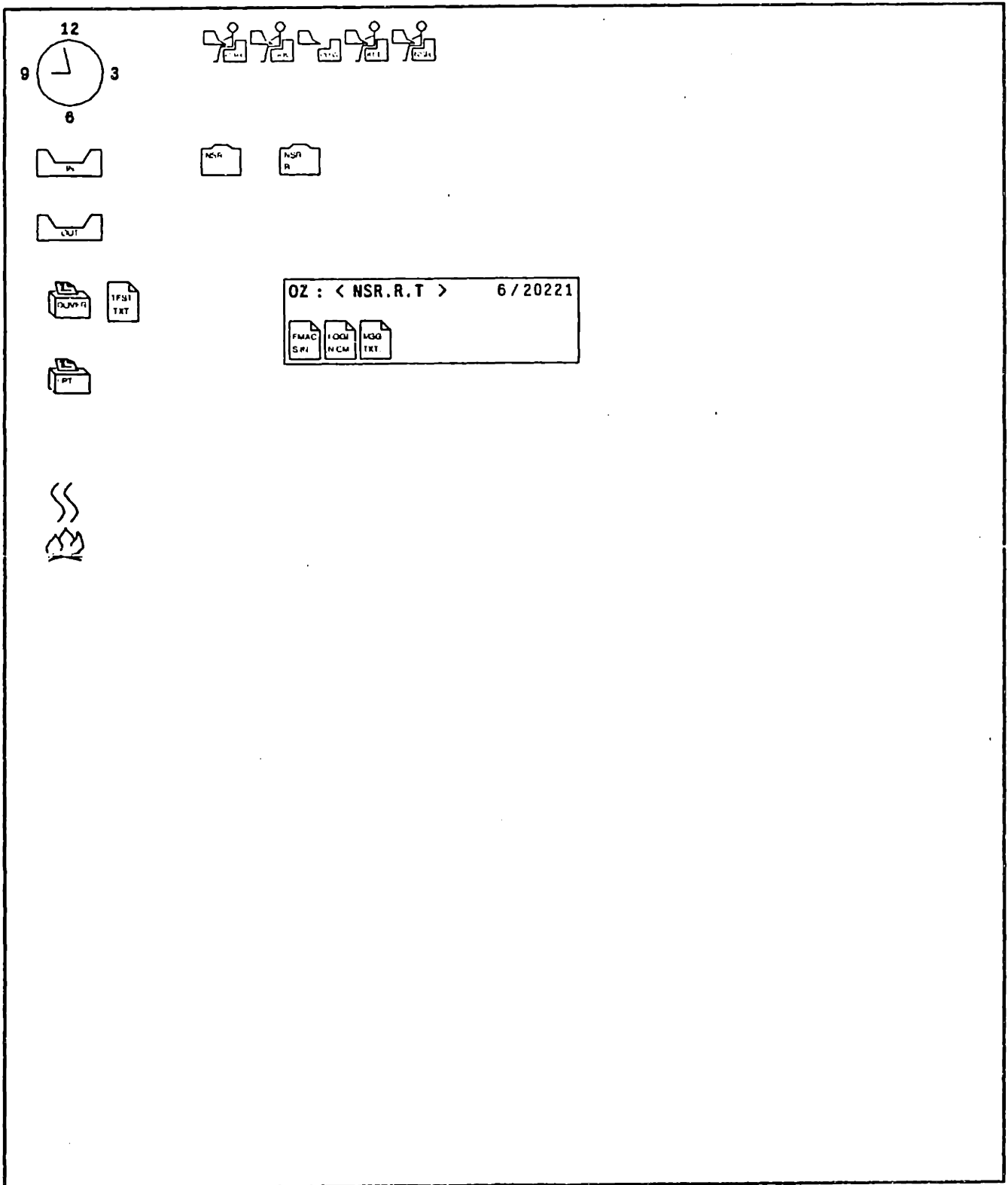

Figure 6-5: Icon-Style Interface



campfire. The campfire is highlighted as the file is deleted. The highlighting is then turned off and the document icon disappears.

The user moves the *MSG.TXT* document icon out of the directory to the *desktop*, i.e., the open part of the screen. The user now closes the directory; the original folder icon is displayed, instead of the opened directory display. See figure 6-6.

Mail is viewed by opening the in-box icon. This opened presentation shows the messages in the mail file as summary lines, shown in figure 6-7. A summary line can be opened, showing the text of the message. This process is similar to that for viewing directories and files.

The user can send the contents of a file in two ways. First, he can move the document icon to one of the user icons at the top of the screen. This causes the text of the message to appear as a message on that user's terminal. Second, the document icon can be moved to the out-box. The user takes the latter action, moving the *MSG.TXT* document icon to the out-box, causing the contents of the file to be mailed to the user ECD.

Finally, the user opens the *NSR* icon representing himself, displaying information about his terminal location and personnel information, such as office, supervisor, etc. This is shown in figure 6-8. He updates the office information, using the same text-editing process described above, and then closes the display.

Figure 6-6: Icon-Style Interface

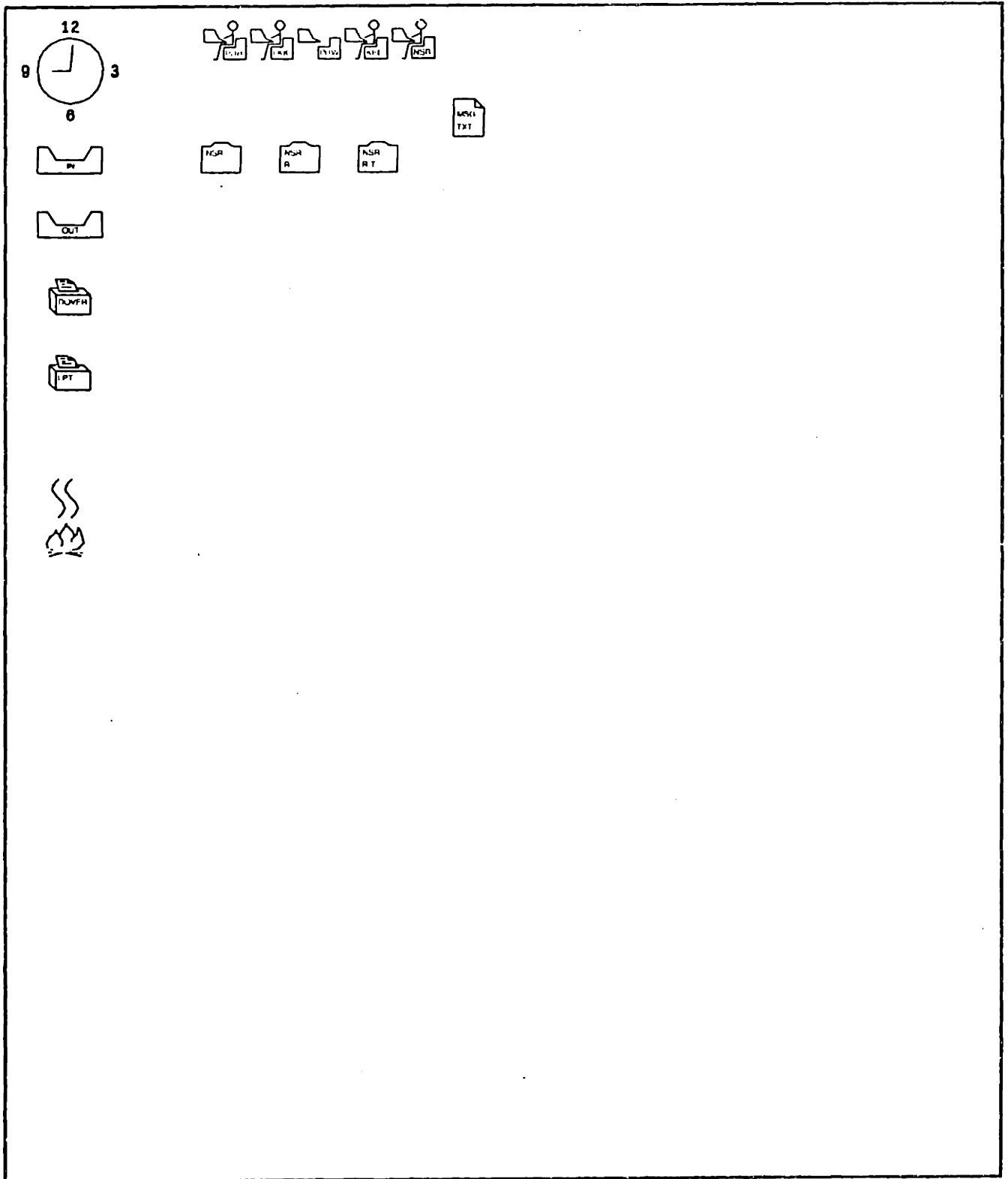

Figure 6-7: Icon-Style Interface

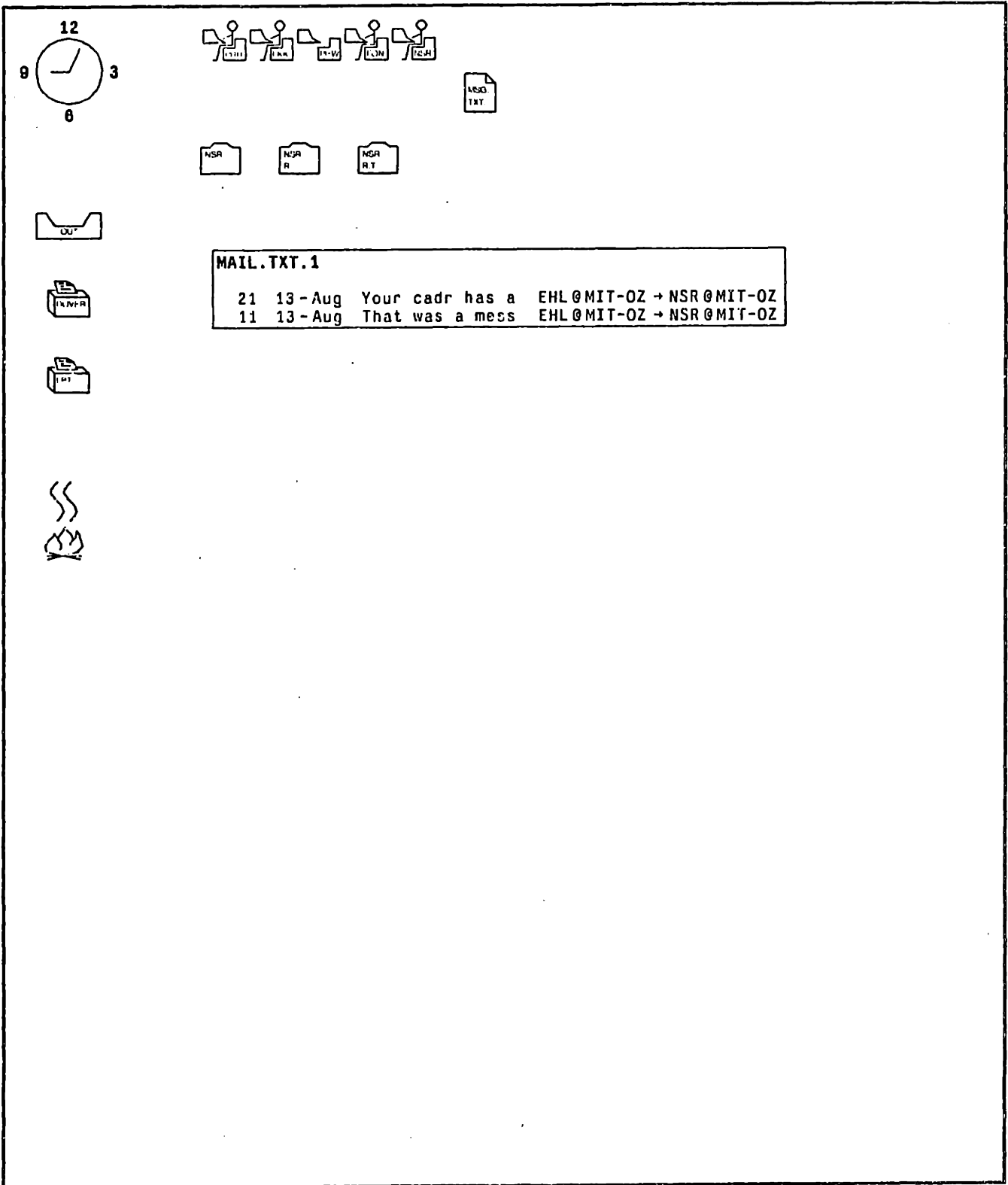
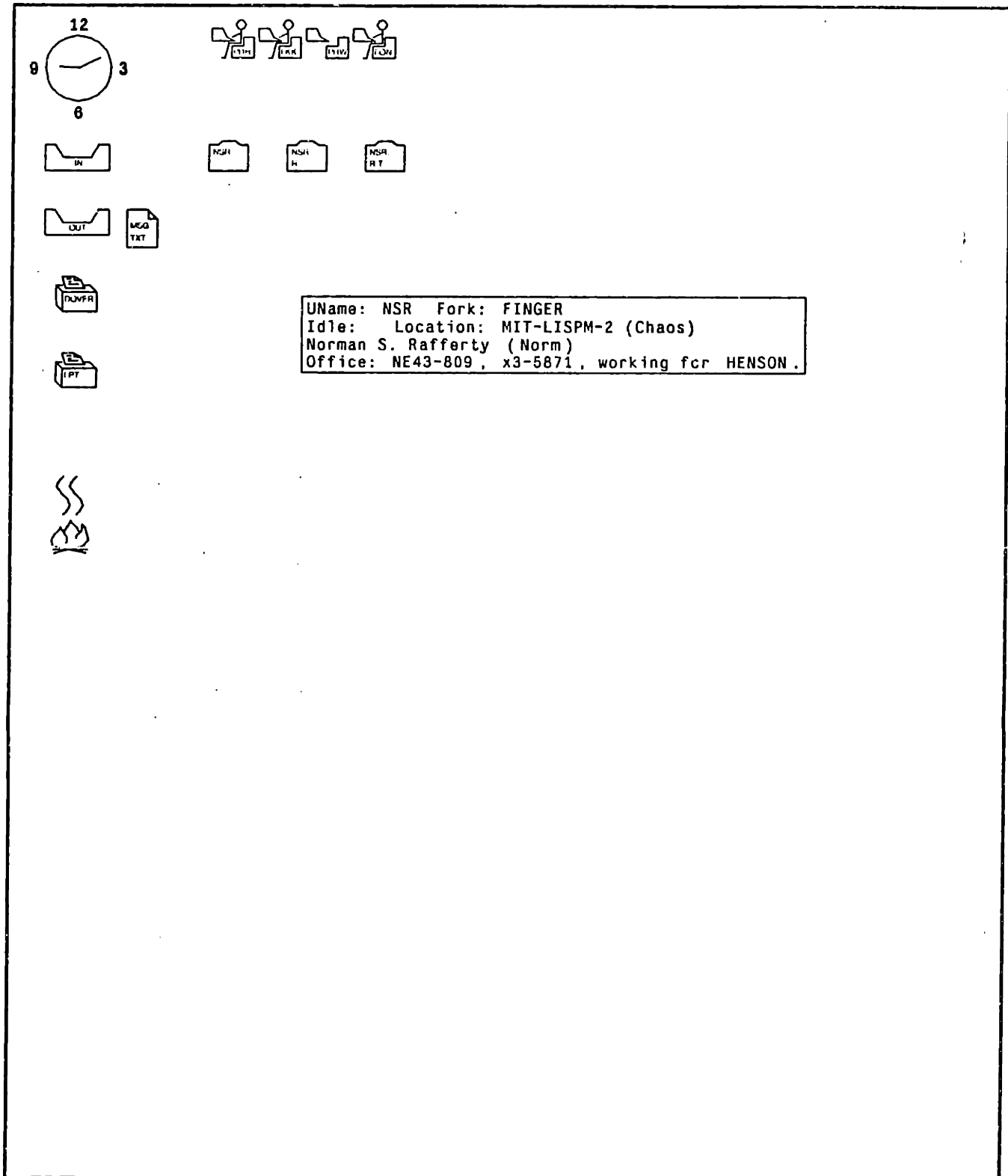

Figure 6-8: Icon-Style Interface



Menu-Style Interface. Figure 6-9 shows the initial screen display at the start of the scenario for the menu-style interface. Across the top is a display of current information about the status of the host computer: the time, the time-sharing load, and the number of jobs. (The time-sharing load on Tops-20 is represented by three *load averages*, the first specifying the load at the current time, the second, the average load over the past 5 minutes, and the third, the average load over the past 15 minutes.) This display is updated every few minutes.

Two command menus are displayed below the host information. The top menu contains commands for choosing what to present and for updating the host's information from user editing of the presentations. (The latter is the *perform changes* command.) The bottom menu contains presentation editor commands. These commands are invoked by command keys in the icon-style interface.

The scenario starts with the user invoking the *present directory* command (the result of which is shown in figure 6-10): The user first points to the menu item and selects it by pressing a mouse button. A small window appears at the bottom of the screen, requesting that the user type the directory's pathname. The user types the pathname "<NSR.R.T>" (and can edit it using the text-editing commands). When the user types the End key, the small window disappears, and the user is prompted for the next argument, the position for the directory presentation. The interface displays these prompts (for domain object, presentation, and position selection) briefly, in a line at the bottom of the screen (not shown in these pictures), by specifying the kind of command argument expected. Here, the prompt is "Position". The user selects a position with the mouse, and the directory is displayed as shown in figure 6-10. While the command is being executed, i.e., until the directory display appears, the *present directory* item in the menu is highlighted by reverse video.

The directory display is accompanied by a menu of commands that view, delete, and print files. The user invokes the *present file* command from that menu, and then selects (as an argument to the command), the *MSG.TXT* file. This selection can be done by pointing to

Figure 6-9: Menu-Style Interface

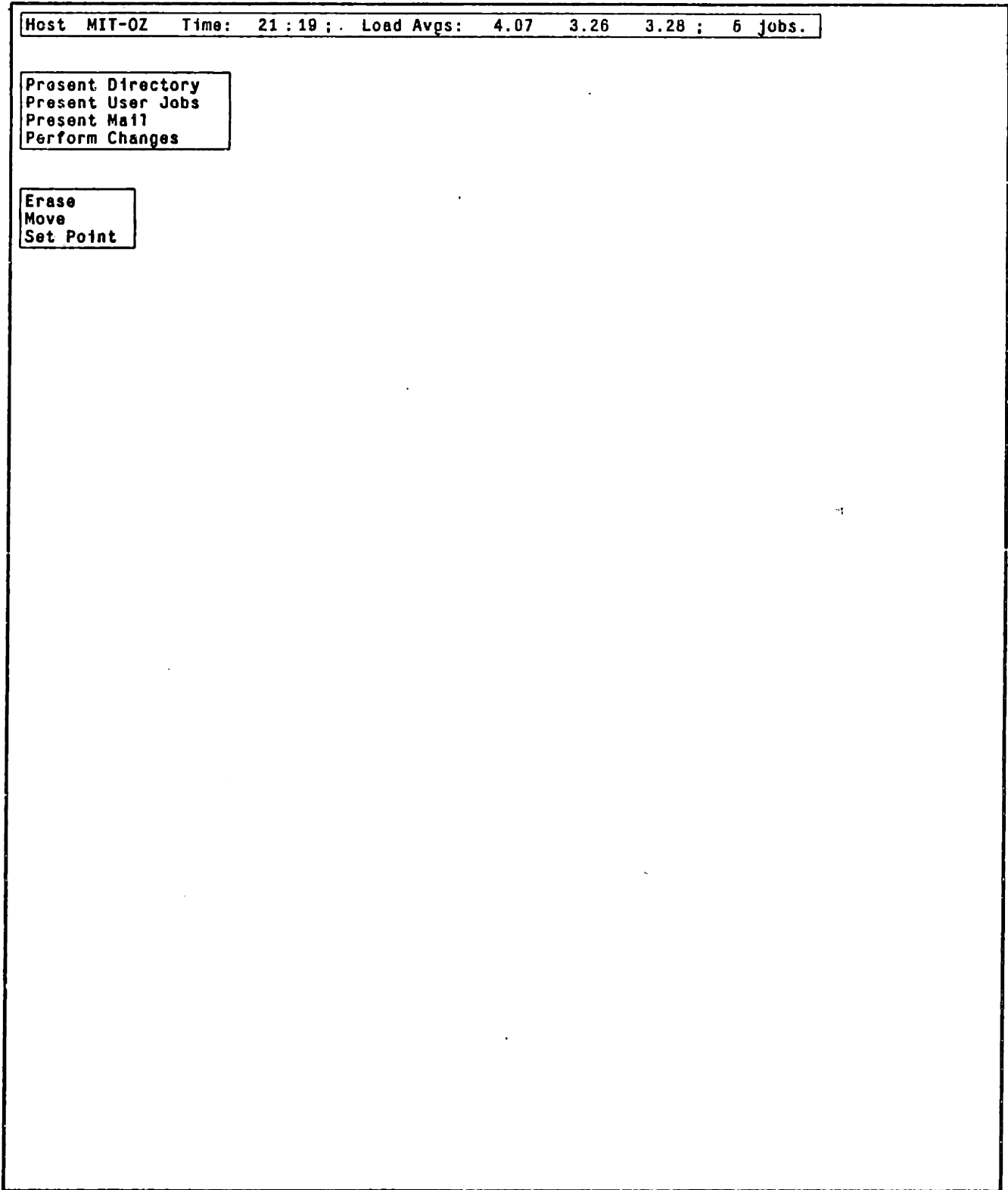

Figure 6-10: Menu-Style Interface

Host MIT-OZ Time: 21:23 ; Load Avgs: 4.07 3.26 3.28 ; 6 jobs.

Present Directory
Present User Jobs
Present Mail
Perform Changes

Erase
Move
Set Point

Present File
Delete File
Dover Print File
Line-Print File

OZ : < NSR.R.T > 6/19053

EMACS.INIT.374	3	07/26/84	10:34:57	???	NSR	???
LOGIN.COMD.34	1	07/03/84	02:47:05	???	NSR	???
MSG.TXT.1	1	08/13/84	20:58:27	08/13/84	NSR	ECD@MIT-OZ
TEST.TXT.1	1	08/13/84	20:39:15	08/13/84	NSR	???

just the text presenting the name of the file, "MSG.TXT", the entire file row, or even the presentations of the file's properties (such as the "1" presenting the file length). The user also selects a position for the file display.

The user at this point can edit the file and its *To* field, just as in the icon-style scenario. See figure 6-11.

The user prints the file *LOGIN.CMD* by selecting *Dover Print File* and the file entry in the directory. (Note that if the user wished to print *MSG.TXT* at this point, he could either select its entry in the directory or select the file display.) As before, while the command executes, its item in the menu is highlighted.

The user next deletes *LOGIN.CMD*. Now, in addition to the highlighting of the delete command menu item, the *LOGIN.CMD* line is removed from the display, as shown in figure 6-12.

The user now erases the directory listing. (This is not a delete command -- it just removes the directory display from view.)

A display of the current user jobs is next displayed, illustrated in figure 6-13. From left to right, the fields in this display are: login name, user name, current job, and terminal information. The terminal information starts, in some cases, with the time the terminal has been idle (1:17 for one user, 1 minute for another here) and follows with the terminal location. The user can get the identification of these fields by pointing to them with the mouse; the documentation line at the bottom of the screen (not shown here) shows a phrase identifying the field. For example, pointing to the text "MIT-LISPM-2 (Chaos)", the user sees "the location of the terminal of the user NSR, Norman S. Rafferty". The user edits this field to add more information, changing it to "LM2: 7th floor". He makes this change take effect by invoking the *perform changes* command from the menu at the top left. See figure 6-14.

The user next erases the user display and invokes *present mail*, resulting in the display

Figure 6-11: Menu-Style Interface

Host MIT-OZ Time: 21:24 : Load Avgs: 4.07 3.28 3.28 ; 6 jobs.

Present Directory
Present User Jobs
Present Mail
Perform Changes

Erase
Move
Set Point

Present File
Delete File
Dover Print File
Line-Print File

OZ : < NSR.R.T > 6/19053

EMACS.INIT.374	3	07/26/84	10:34:57	???	NSR	???
LOGIN.CMD.34	1	07/03/84	02:47:06	???	NSR	???
MSG.TXT.1	1	08/13/84	20:58:27	08/13/84	NSR	ECD@MIT-OZ
TEST.TXT.1	1	08/13/84	20:39:15	08/13/84	NSR	???

MSG.TXT.1 To: ECD@MIT-OZ

Ed,

I saw the article. Could you please send me a copy of the report it mentions? (It was TM-132, I think.)

-- Norm

Figure 6-12: Menu-Style Interface

Host MIT-OZ Time: 21:26 ; Load Avgs: 4.07 3.26 3.28 ; 6 jobs.

Present Directory
Present User Jobs
Present Mail
Perform Changes

Erase
Move
Set Point

Present File
Delete File
Over Print File
Line-Print File

OZ : < NSR.R.T > 6/19053

EMACS.INIT.374	3	07/26/84	10:34:57	???	NSR	???
MSG.TXT.1	1	08/13/84	20:58:27	08/13/84	NSR	ECD@MIT-OZ
TEST.TXT.1	1	08/13/84	20:39:15	08/13/84	NSR	???

MSG.TXT.1 To: ECD@MIT-OZ

Ed,

I saw the article. Could you please send me a copy of the report it mentions? (It was TM-132, I think.)

-- Norm

Figure 6-13: Menu-Style Interface

Host MIT-OZ Time: 21:29 ; Load Avgs: 4.07 3.26 3.28 ; 6 jobs.

Present Directory
Present User Jobs
Present Mail
Perform Changes

Erase
Move
Set Point

User jobs:

PHW	Patrick H. Winston	EXEC	1:17	MIT-NE43-8A-HUB (Chaos)
FONER	Leonard N. Foner	VDIRECT		x8-8260: Dialup
BERWICK	Robert C. Berwick	ZEMACS	1	x8-8268: Dialup
SECRETARY	Jerry Roylance	LISP	???	???
NSR	Norman S. Rafferty	FINGER		MIT-LISPM-2 (Chaos)

Figure 6-14: Menu-Style Interface

Host MIT-OZ Time: 21:30; Load Avgs: 4.07 3.26 3.28; 5 jobs.

Present Directory
Present User Jobs
Present Mail
Perform Changes

Erase
Move
Set Point

User jobs:

PHW	Patrick H. Winston	EXEC	1:17	MIT-NE43-8A-HUB (Chaos)
FONER	Leonard N. Foner	VDIREC		x8-8260: Dialup
BERWICK	Robert C. Berwick	ZEMACS	1	x8-8268: Dialup
SECRETARY	Jerry Roylance	LISP	???	???
NSR	Norman S. Rafferty	FINGER		LM2: 7th floor

shown in figure 6-15. The mail summary display is accompanied by a menu of commands for viewing messages or sending the contents of files as messages. The user can *mail* or *qsend* (i.e., send to a terminal, so the recipient sees the message quickly) by selecting the command, the *MSG.TXT* file, and then a user. There are a number of ways of selecting the recipient user, because there can be a number of user presentations displayed: in the *To* of a file display, in a display of user jobs, and in message summary lines.

Figure 6-15: Menu-Style Interface

Host MIT-OZ Time: 21:32; Load Avgs: 4.07 3.28 3.28; 6 jobs.	
Present Directory Present User Jobs Present Mail Perform Changes	
Erase Move Set Point	
Present Message Mail File QSend File	MAIL.TXT.1 21 13-Aug Your cadr has a EHL@MIT-OZ → NSR@MIT-OZ 11 13-Aug That was a mess EHL@MIT-OZ → NSR@MIT-OZ

Annotation-Style Interface. The initial screen display for the annotation-style interface is very similar to that for the menu-style interface. A new command, *recognize*, appears at the top menu, and the presentation editor menu has been expanded to include commands for drawing lines and arrows. In addition, the interface offers the user the curve-rendering facility for creating lines and arrows. This expanded menu reflects the larger role the presentation editor plays in this style of interface: the user creates graphical annotations to presentations displayed by the system. See the upper left portion of figure 6-16.

The user starts by presenting the directory `<NSR.R.T>`. As with the menu-style interface, the user selects the menu item and is prompted for pathname and position. The directory display in this interface, however, does not include an associated menu of commands.

The user first decides to correct some information in the directory, namely, that the author of the file *EMACS.INIT.374*, currently *NSR*, really should be *EAK*. To do this, the user invokes the *set point* command to place the text-editing cursor in an area above the display and then types the text "CHANGE". The text "EAK" is created nearby in a similar manner. The user then connects "CHANGE" to the author presentation by a line, and connects "CHANGE" to "EAK" by an arrow. The result is shown in 6-16.

To check that the system will correctly understand this annotation command, the user invokes the *recognize* command. Up to this point, the text, line, and arrow created by the user had not been recognized by the interface. The *recognize* command specifically invokes the annotation recognizer. The menu item is highlighted while the recognition is being performed. The user then checks the result of the recognition by pointing to the text "CHANGE". The documentation line now displays "a plan to change the author of the file `OZ:<NSR.R.T>EMACS.INIT.374`, *NSR*, to *EAK*." This change has not yet been made -- the user has only had the system confirm the meaning of the planned command.

The user next makes several more annotations, as shown in figure 6-17. These tell the system to set the reference date of the file *EMACS.INIT.374* to be the same as its creation date, delete the file *LOGIN.CMD.34*, and print the file *TEST.TXT.1*.

Figure 6-16: Annotation-Style Interface

Host MIT-OZ Time: 21:45 ; Load Avgs: 2.64 2.83 2.94 ; 6 jobs.

Present Directory
Present User Jobs
Present Mail
Recognize
Perform Changes

Line
Arrow
Erase
Move
Set Point

CHANGE → EAK

OZ : < NSR.R.T >		6 / 18561				
EMACS.INIT.374	3	07/26/84	10:34:57	???	NSR	???
LOGIN.CMD.34	1	07/03/84	02:47:05	08/13/84	NSR	???
MSG.TXT.1	1	08/13/84	20:58:27	08/13/84	NSR	ECD@MIT-OZ
TEST.TXT.1	1	08/13/84	20:39:15	08/13/84	NSR	???

Figure 6-17: Annotation-Style Interface

Host MIT-OZ Time: 21:48; Load Avgs: 2.84 2.83 2.94; 6 jobs.

Present Directory
Present User Jobs
Present Mail
Recognize
Perform Changes

Line
Arrow
Erase
Move
Set Point

OZ: < NSR.R.T > 6/18561

	EMACS.INIT.374	3	07/26/84	10:34:57	???	NSR	???
DELETE	→ LOGIN.CMD.34	1	07/03/84	02:47:05	08/13/84	NSR	???
	MSG.TXT.1	1	08/13/84	20:58:27	08/13/84	NSR	ECDGMIT-OZ
LINE-PRINT	→ TEST.TXT.1	1	08/13/84	20:39:15	08/13/84	NSR	???

CHANGE → (points to LOGIN.CMD.34)

CHANGE → (points to TEST.TXT.1)

EAK → (points to TEST.TXT.1)

The user now tells the system to perform these commands, by invoking the *perform changes* command. The command's menu item is highlighted. The first thing the interface must do is recognize the new annotations, so the *recognize* command is automatically invoked by the interface. The user sees that this is taking place: the *recognize* menu item is now highlighted. After recognition, the commands are executed one by one. As with the highlighting of the *recognize* command, the user sees the progress of the *perform changes* command: the annotation commands are highlighted while they are being executed.

When the annotation commands have all been performed, the display is updated in two ways. First, the line in the directory presenting the file *LOGIN.CMD.34* is removed, since the file has been deleted. Second, the annotation verbs are changed to past tense. The resulting display is shown in figure 6-18.

6.2 Common Implementation Details

The basic order of development of the user interface was as follows:

- * Create application data base network and a background process to connect it with the operating system.
- * Define some initial presentation styles so that further development can be tested with them (e.g., icons).
- * Enable selected PSBase basic style packages, especially top-level control structure, edit functions, and the mouse-tracking reference mechanism.
- * Define and describe commands and command sets, select menu presentation styles.
- * Specify move recognition and open/close rules.
- * Write recognizers as needed (move recognizers, direct-edit recognizers).
- * Define and change presentation styles as desired.

Common Implementation. Certain parts of the user interface implementation are shared between all three of the styles. These parts, once constructed, are invariant under further

Figure 6-18: Annotation-Style Interface

Host MIT-OZ Time: 21:49; Load Avgs: 2.64 2.83 2.94; 6 jobs.

Present Directory
Present User Jobs
Present Mail
Recognize
Perform Changes

Line
Arrow
Erase
Move
Set Point

changed → EAK

changed

OZ : < NSR.R.T >	6 / 18561						
EMACS.INIT.374	3	07/26/84	10:34:67	???	NSR	???	
MSG.TXT.1	1	08/13/84	20:58:27	08/13/84	NSR	ECD@MIT-OZ	
TEST.TXT.1	1	08/13/84	20:39:15	08/13/84	NSR	???	

line printed →

development and experimentation with interface styles.

The most important of these parts is the application data base, whose development will be discussed separately in the following sub-section. The application data base models the operating system, and at first it seems redundant. Yet it is well worth the modest effort to construct it: The uniformity of the data base network is vital to the utility of the PSBase mechanisms. In future systems, applications may be built from the first with this kind of data base, completely relieving the interface builder from this work. (The benefits of a uniform data base mechanism in modeling the application are not limited to the mechanisms of the user interface.) A sub-section below discusses the continual updating of the application data base in more detail.

A number of simple parsers are provided as part of the general recognizer mechanism that recognizes user edits of property presentations. These are called *direct edits* and are also discussed in detail in a sub-section below.

Finally, all the styles share a number of PSBase components. Since these components are simply selected and enabled, requiring almost no work on the part of the interface builder, the components that appear in the three style implementations will be listed here:

- * The two top-level control structures (argument-first for the icon-style implementation; command-first for the menu-style and annotation-style implementations)
- * The command execution presenter (for highlighting commands as they execute)
- * The mouse-tracking/reference mechanism
- * Vertical command menu presentation styles (for the menu-style and annotation-style implementations)
- * Presentation editor functions: all styles include *move*, *set text cursor position*, and text-editing commands; menu style adds *erase*; annotation style adds *line* and *arrow*
- * Curve recognizers for the annotation style.

The Application Data Base. Like PSBase, this interface is implemented on the MIT Lisp machine. The Lisp machine acts as the user's terminal; the Lisp machine communicates with the host computer via network connections. The user of the interface, however, does not need to be aware of these connections.

The large scale structure of this system is shown in figure 6-19. The application data base models the current state of relevant parts of the host computer, using the uniform data base mechanism provided by PSBase. A background process maintains the application data base by periodically polling the host computer, getting information about the users currently logged in, the time-sharing load, the contents of relevant directories, and the contents of the user's mail file ("in box").

Some host information is retrieved or saved upon demand, rather than by regular polling. For instance, when the user opens a document icon, the presented file instance in the application data base receives a *make-contents* message; the file instance must expand its description to include the text contents of the file. At this point, therefore, the file is read into the Lisp machine from the host computer. Similarly, when the file instance receives a *save-contents* message, the text of the file is written back to the host computer.

Recognizers for Direct Editing. Three instances of direct editing of a presentation occur in the icon-style interface scenario: editing of the file text, the file destination field, and fields in the user information display. All such direct editing is handled in the same manner. The PSBase recognizer control structure finds those presentations created by presenters and edited by the user. For each of these, it invokes a specific recognizer to handle that kind of presentation; currently, only text presentations have such a recognizer. This recognizer, still part of the general mechanism, checks for a parser specifically for the kind of presented domain object and invokes it.

The interface builder must therefore provide such parsers for those kinds of application data base instances that are specific to this interface. The following are two sample parsers. Note that both are specified not by the class of domain object, but by the property name. Text presentations that are directly edited are presentations of properties (since they are

Figure 6-19: Application Data Base Management

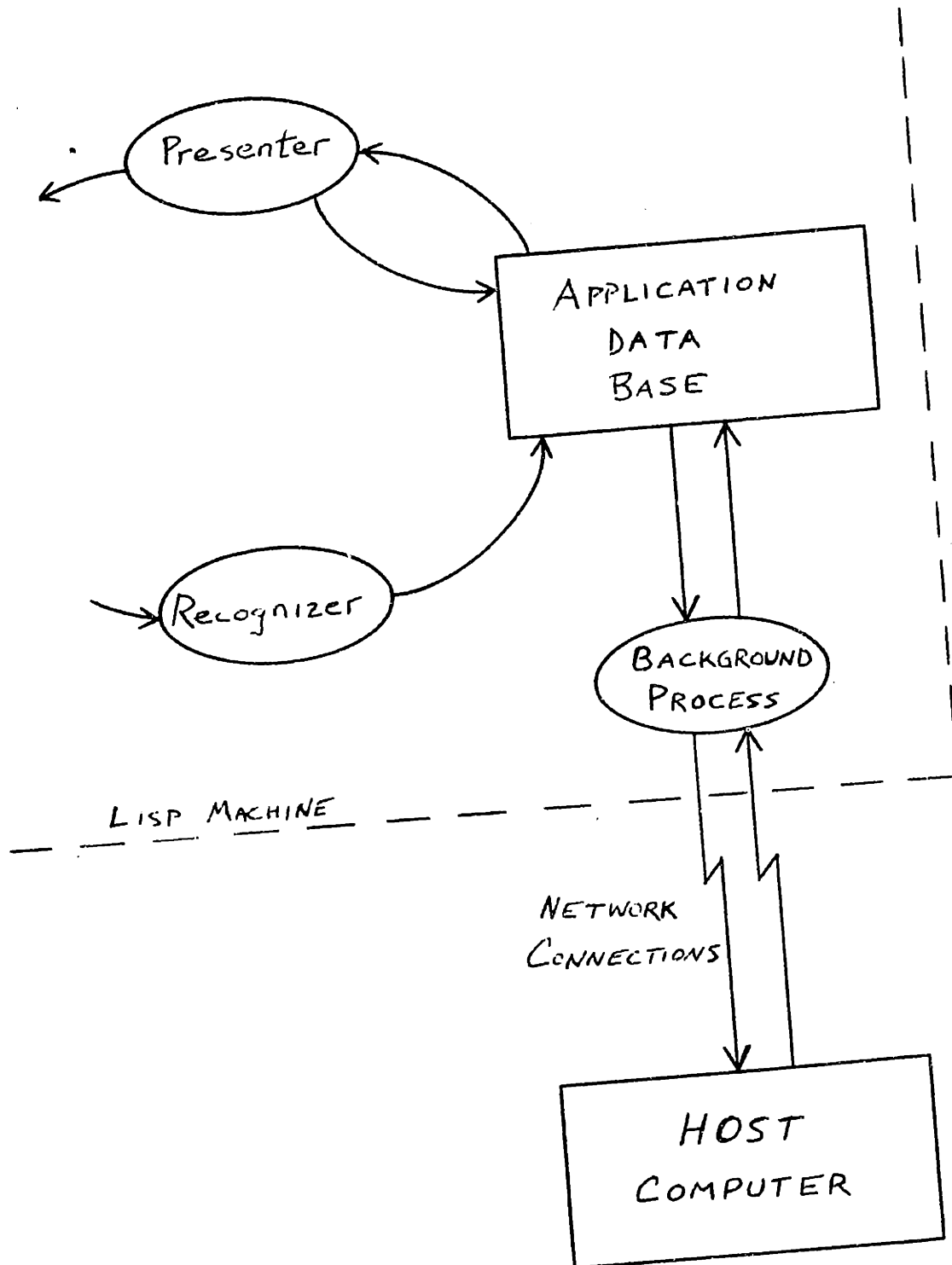

parts of a larger style). This approach is clearly limited; for instance, even if based on the property name, the specification really should include the kind of owning object or the kind of property value, since property name alone may be ambiguous.

```
(defmethod (TEXT-PRESENTATION
  :PARSE-WORK-PHONE-PRESENTED-DOMAIN-OBJECT) ()
  string)

(defmethod (TEXT-PRESENTATION
  :PARSE-REFERENCE-DATE-PRESENTED-DOMAIN-OBJECT) ()
  (make-instance 'date
    ':universal-time (time:parse-universal-time string
      0 nil nil)))
```

The first parser simply returns the string of the text presentation as the string to use for the value of the presented domain object's property. In fact, most of the parsers for these interfaces have such trivial parsers, since most of these properties have string values. Here, for example, the *user* instance in the application data base has a *work phone* property; its value is not a data base instance, but is simply a string.

The second parser is only slightly more complicated. The *reference date* property of a file instance has a value that is a *date* instance. The date instance in turn has a *universal time* property, encoding a time or date as a number. The Lisp machine provides a package of functions for manipulating such time representations, including the parsing function used here that returns a universal time given a string. Thus, there are two phases, the actual parsing of the string and the creation of the data base instance. (These phases are simple cases of what section 2.6 described as the *semantic recognizer* and *domain changer* parts of the recognizer.)

The number of parsers to be specified varies with the number of properties in the application data base that will be edited. It does not depend on the number of presentation styles presenting these properties. Thus, the interface can become quite extensive without requiring much additional work in this regard. For example, the icon and menu styles both show a user's terminal location, but they embed this in different styles, one in a display of information about a single user, and the other in a table of information about all the users.

However, once the parser for the *location* property has been created, both presentation styles immediately offer the user the ability to edit this field.

6.3 Icon-Style Interface Implementation

This section and the following two describe the implementation of the interfaces just described, building on PSBase. The icon-style interface implementation consists of five major parts: presentation style descriptions, open/close mechanism, move recognition, recognizers for direct editing, and simple use of various PSBase components.

Presentation Style Descriptions. In general, the icon-style interface uses a graphical presentation style to define the icons, and template and sequence presentation styles to define the opened presentations. Examples of these styles' specifications will be given below.

The icon style descriptions are simple, though somewhat verbose (as each line, circle, rectangle, etc., must be specified by listing its properties). These descriptions are easily generated, though one would expect a full-scale presentation system base to provide more tools for creating icons by editing pictures. (Whether the pictures are constructed from lines, circles, etc., as here, or from bitmap, or a combination, is an independent issue. The non-bitmap approach used here was chosen because it used existing PSBase facilities.)

The presentation style description for the document icon is shown below:

```

(def-graphics-presentation-style DOCUMENT-ICON FILE nil
                               nil nil
  ((nil
    (LINE-PRESENTATION          ; Top
     :x1 (relative-to-parent-x 0)
     :y1 (relative-to-parent-y 0)
     :x2 (relative-to-parent-x 16)
     :y2 (relative-to-parent-y 0)))
   (nil
    (LINE-PRESENTATION          ; Left
     :x1 (relative-to-parent-x 0)
     :y1 (relative-to-parent-y 0)
     :x2 (relative-to-parent-x 0)
     :y2 (relative-to-parent-y 30)))
   ...
  ( (:PATHNAME :STRING-FOR-EDITOR)
    (TEXT-PRESENTATION
     :x (relative-to-parent-x 2)
     :y (relative-to-parent-y 9)
     :font 'fonts:h16
     :mouse-trackable-p ':no-track
     :string (substring-or-null-string
              (send presented-domain-object ':component-walk
                '(:pathname :string-for-editor))
              0 4)))
  ( (:PATHNAME :STRING-FOR-EDITOR)
    (TEXT-PRESENTATION
     :x (relative-to-parent-x 2)
     :y (relative-to-parent-y 19)
     :font 'fonts:h16
     :mouse-trackable-p ':no-track
     :string (substring-or-null-string
              (send presented-domain-object ':component-walk
                '(:pathname :string-for-editor))
              4 8))))
  nil)

```

Just as with the example shown in section 5.4, the first two lines of this style description specify the name, *document-icon*, the application data base class to which it applies, *file*, and flags specifying here that it is not the default style for files, nor is it an active presentation. The first presentation description in the following list specifies the line across the top of the icon. The *nil* that starts the specification indicates that this line alone does not present anything. The description for the line down the left side of the icon is similar, as are the five line descriptions that have been elided.

The style description ends with entries for the two lines of text presenting the file name.

Each starts with a specification of the presented domain object, (*:pathname :string-for-editor*). This means that the text is computed from the *string-for-editor* property of the file's pathname. (A pathname has several string properties, specifying different ways of writing the pathname.) The strings for the two text presentations are computed by forms that extract the first four letters for the first line, and the second four for the second line.

The text presentation entries also specify *mouse-trackable-p* properties. A *:no-track* value informs the mouse-tracking mechanism that these text presentations should not be mouse-sensitive. The intent of the style is that an icon be an atomic unit, and therefore no smaller part of it should be mouse-sensitive. By default these presentations would be mouse-sensitive, since they present something. The lines, on the other hand, would not be mouse-sensitive by default.

The following are representative of style descriptions for opened presentations, using template and sequence presentation styles. There are three primary styles here: a template style for the directory label and disk usage line, a sequence style for the row of document icons, and a template style that combines the label and row styles.

The following is the template for the directory header. This style is also used by the other directory styles, those used in the other two interfaces.

```
(def-template-presentation-style TOPS20-DIRECTORY-HEADER
                                DIRECTORY nil
  ((:self tops20-directory-name fonts:cptfontb)
   "      "
   (:disk-space-used active-text)
   "//"
   (:free-disk-space active-text))
  :horizontal-layout
  nil)
```

Two other styles are referred to by this template. The *tops20-directory-name* style simply presents the directory's host and name in a text template of colon and brackets, e.g., "OZ: <NSR>". The *active-text* style is a simple graphical presentation style that defines a text presentation whose string is the same as that it presents, and which is specified as being active, updated every minute. Unlike most graphical presentation styles, it only specifies

one presentation, the text presentation. The reason for having it is simply to specify its active nature.

The following is the presentation style description for the row of document icons in the directory display:

```
(def-sequence-presentation-style
  ICON-DIRECTORY-FILE-GROUP-STYLE
  (LIST-PROPERTY DIRECTORY :FILES FILE)
  nil t 999999
  nil nil nil
  document-icon
  :horizontal-layout)
```

The third line of this description, (*list-property ...*), specifies the property of the directory being presented, namely, the *files* property, and the kind of objects in the list, namely, file instances. The fourth line specifies that this is not the default style for such properties, and that, while it is an active presentation, it should not (in effect) be periodically updated -- it will instead be updated automatically whenever the directory instance in the application data base is changed.

This sequence has no prefix, infix, or suffix presentations (fifth line). The style used to present the elements of the *files* list is *document-icon*. The document icons will be positioned in a horizontal row.

Finally, the following is the template style description that composes the above two styles into the overall opened-directory style:

```
(def-template-presentation-style
  TOPS20-DIRECTORY-ICON-LISTING-STYLE DIRECTORY nil
  ( (:self tops20-directory-header)
    ""
    (:files icon-directory-file-group-style))
  :vertical-layout
  :border-box)
```

The third line of this template specifies that the directory (*self*) will be presented both by the whole composite and by the header line. The null string in the fourth line effectively produces a blank line separating the header from the document row. And, as mentioned previously, the *files* property of the directory, a list of files, will be presented in the style

which lines them up as a row of document icons. The header, blank line, and document row are laid out vertically, and a border box is placed around the entire directory presentation.

Opening, Closing. The PSBase mechanism for opening and closing presentations is driven by a set of specifications linking domain object classes and the presentation styles for their opened and closed presentations. These are easily provided; the following is one of these specifications (there are four others, all similar):

```
(def-open-close-presentation-style message-open-close
  message
  message-summary
  full-message
  fonts:cptfont)
```

Move Recognition. Chapter five described the general move recognition mechanism provided by PSBase. To use this mechanism, the interface builder must provide the move recognition rules and some small semantic recognizers to handle the recognition, once the general organizational recognizer has determined that it applies. The following specifies the move recognition rule used for recognizing movement of a document icon to a directory (either a folder icon or an opened directory display) as a command to move the file to that directory (there are four other similar rules specified for the interface):

```
(def-move-recognition-rule move-document-to-directory
  (:overlap (file (document-icon))
            (directory (folder-icon
                       tops20-directory-icon-listing))))
  :recognize-file-directory-movement)
```

The semantic recognizers for move recognition are all very similar. The following is a sample:

```
(defmethod (PRESENTATION :RECOGNIZE-MAIL-FILE-MOVEMENT)
  (out-box-presentation edit-history-entry)
  (let* ((file (send self ':resolve-presented-domain-object
                       #'typep 'file))
         (command-application
          (make-command-application
           (intern-command 'send-file-as-mail-1)
           (list file))))
    (send command-application ':execute)
    (send self ':move-next-to-presentation
              out-box-presentation edit-history-entry ':right)))
```

This recognizer is invoked by sending a *recognize-mail-file-movement* message to the presentation being moved, the document icon. It is given the out-box icon as one of its arguments. The first binding form in the *let** resolves the presented domain object to a file instance. The second binding form creates the command application, specifying the *send-file-as-mail-1* command and an argument list with the file as the single argument.

The body of the *let** executes the command application (the general PSBase command execution presenter will take care of the highlighting automatically) and ends by moving the document icon to a standard position to the right of the out-box.

The other move recognizers are about this simple. Unfortunately, some need to specify highlighting themselves because of inadequacies in the general command execution presenter. (Specifically, the presenter looks for presentations of the command or the command application. However, moving a document to a printer does not involve a command presentation -- the printer icon presents a printer, not a command. The out-box, on the other hand, presents the mail command. Perhaps the command execution presenter could be improved to handle such cases. In any case, the highlighting is a simple matter to specify.)

6.4 Menu-Style Interface Implementation

The implementation of the menu-style interface consists primarily of presentation style descriptions. For example, the host information at the top of the screen is produced by the following template style:

```
(def-template-presentation-style HOST-INFO HOST nil
  ("Host "
   (:name nil)
   " Time: "
   (:current-time digital-clock-no-border)
   "; "
   (:load-averages host-info-load-averages)
   "; "
   (:number-of-jobs nil)
   " jobs.")
  :horizontal-layout :border-box)
```

This style is similar to the other template styles discussed. One distinguishing feature here is the presentation style specified for the *name* and *number of jobs* properties: *nil* indicates that the data base network should be searched for the best applicable default style. The two other sub-styles named are straightforward templates.

Implementing displays with associated menus has two parts: specifying the relevant command set in the application data base and defining the presentation styles. The directory presentation will be used here as an example.

The directory presentation and menu combination is a template-style composite presentation, and as a whole it presents the directory. It has two sub-presentations, the menu and the directory display. These must, by the nature of PSBase template presentation styles, present properties of the directory (or the directory itself again -- the directory display falls into the latter category.) Thus, the interface builder must be sure that a *command set* is defined, consisting of the relevant commands (present file, delete file, etc.), and that this command set serves as the value of some property of the directory to be presented. Since all directories will share the same command set, this is a property of the entire class, inherited by each directory instance.

This is implemented in the current PSBase data base mechanism by defining a method for *directory*. (All properties are accessed by the message passing. Some properties are defined by the contents of slots in the instances; but the Lisp machine message-passing system automatically creates methods to retrieve these as well. Thus, the property accessing is uniform.) This method is shown below:

```
(defmethod (DIRECTORY :FILE-COMMAND-SET) ()  
  *short-file-command-set*)
```

This defines the *file command set* property for directories. It returns the *command set* instance in the data base network that the variable **short-file-command-set** is bound to. That variable and the command set instance in turn are created from the following specification:

```
(defvar *SHORT-FILE-COMMAND-SET*
  (make-command-set-from-spec
    '(present-file
      delete-file
      dover-print-file
      line-print-file)))
```

This specification defines a command set instance by simply listing the names of the commands to be included. These commands are defined individually elsewhere. (They may be included in several different command sets. The PSBase command description mechanism interns command instances in the data base network based on their Lisp function specifications.) For example, the command description for the *present-file* command is written as follows:

```
(def-command PRESENT-FILE
  :arglist ((parameter :select :domain-object
                      :domain-object-type file
                      :presentation-type t)
            (parameter :select :position)))
```

The interface builder must also write the functions for the presentation commands that appear in these menus. The definition of the *present-file* function is as follows:

```
(defun PRESENT-FILE (file-instance position)
  (send file-instance ':make-contents)
  (present file-instance
    (position-x position) (position-y position)
    nil
    'text-file-contents))
```

This function (like the *open* mechanism discussed in chapter five) first ensures that the file instance includes the current contents (the text of the file). The file is then presented: the *present* function is a general one that takes as arguments the application data base object (the file instance) to be presented, the position for the presentation, the default font (none specified here), and the name of the presentation style to use (*text-file-contents*). Since these *present-...* functions all tend to have this same structure, there is potential for converting this task of writing functions to simply describing the action, as is done with *open/close* mechanism.

Some of the presentation styles were shared with the icon-style interface. (In the icon-style interface these were all used as opened presentations.) These shared styles are, first,

the presentation of files showing pathname, destination, and text contents; second, the presentation of the mail file by showing message summary lines; and third, the presentation of the text of messages.

The recognition of direct edits is exactly the same as in the icon-style interface. In fact, no additional work was done at all here, since all the parsers for the properties had already been defined.

6.5 Annotation-Style Interface Implementation

The annotation-style interface uses the same presentation styles as the menu-style interface, differing only in the choice of the command sets and top level presentation style for the directory. (In the annotation-style interface the top-level directory presentation is just the directory listing, without the associated menu.)

The command execution presenter provides the facility whereby the annotation verbs are changed to past tense (in addition to providing the command highlighting). The annotation recognizer only needs to record the presentation style (namely, the annotation presentation style) in the annotation presentation instance. The command execution presenter checks the command presentation (which it has been highlighting) for being of that style; if so, the verb is changed to past tense.

The bulk of the effort was devoted to writing the annotation recognizer. Unlike the other mechanisms discussed in these interface implementations, the annotation recognizer is fairly large and is both style-specific and domain-specific. It did not prove very difficult to modify at various times, as parts of the structure seem almost descriptive. However, a better approach for future development would be to abstract a general PSBase mechanism driven by a set of interface-specific annotation descriptions. This seems to be plausible, judging from the final structure of the programs.

Recognition of the annotations works by matching structural patterns against the presentation data base structure and checking presented domain objects of eligible

presentations. For example, consider the case of an arrow connecting the text "delete" with a presentation of a file. The recognizer starts by checking that the text presentation is a command verb. Its job is now to verify that this is indeed a presentation of a *delete* command application and to determine its arguments.

The organizational recognizer collects lines and arrows attached to the text presentation and collects the presentations at the other ends; here, only one arrow is collected.

The semantic recognizer part checks that the presentation at the other end of the arrow matches (by reference resolution if necessary) something that can be deleted. In this case, the domain object is a file, and the command application can be created, with the file as its single argument.

Even though the annotation recognizer is a fairly large and complex, hand-written program, compared with the other interface-specific parts of the project, the annotation recognizer still benefits from PSBase support. Its recognition task is simplified by having a structured presentation data base: it does not have to do any work to find arrows and lines connected to the verb text. And because the presentation data base records presented domain objects for the rich structure created by the directory presenter, recognition is an incremental task -- only the annotations to the directory need be recognized, and the recognizer can easily check that presentations at the ends of delete arrows present files, or those at the end of change lines present properties that may be changed, for instance.

These checks are aided too by the PSBase reference resolution mechanism: whether the presentation at the end of the change arrow presents a date, a time-and-date, a property whose value is one of those, etc., is immaterial -- when the recognizer checks a change-reference-date annotation, it need only ask the resolution mechanism to check for a date instance.

Part of the previous two points, and a more general benefit as well, is the fact that the application data base is constructed from a uniform data base mechanism.

And finally, the larger, interactive nature of the interface benefits from the general PSBase recognition dependency and retraction mechanism. The annotation recognizer does not need to consider changes in the annotation structure from a previously recognized state -- any such changes cause the previous recognition to be retracted automatically. The recognizer only needs to consider the recognition from an unrecognized state and to inform the dependency mechanism of the presentations on which the recognition depends and how to retract the recognition it specifies.

6.6 Other Style Possibilities

Combinations. These interfaces do not have to be (and were not in this project) constructed separately. The interface builder can develop them together, combining them at various times, experimenting with combinations of presentation styles in order to develop a desired overall style, and so on. One command that PSBase provides in this regard is the *change presentation style* command. The command is given a presentation as its argument. The set of all presentation styles applicable to the presentation's presented domain object is collected. The user selects one of the applicable styles from a menu, and the presentation is replaced with a new one, of the same domain object, in the selected style. Thus, the builder or user can be offered control over the way the objects in the application data base are presented.

Planning. In the interfaces developed here, only the annotation-style included planning -- the separation of accumulation and recognition of commands from their execution. The other styles appear to inherently be more of a *direct manipulation* style of interface. However, one can imagine developing extensions of those styles, adding features of the annotation style to add planning.

The user could create arrows between presentations in the icon-style interface to present a planned move -- and therefore a planned command using the move recognizer. For instance, the user could draw an arrow from a document icon to a printer icon. This could be recognized as a plan to print that file. The user could see this recognition documented,

as in the annotation-style interface, and accumulate a set of move-arrow plans before giving the command to execute them.

Similarly, some commands could be planned by drawing arrows in the menu-style interface, an arrow from the *delete file* menu item to a file presentation, for example. Some menu commands might require more than one input, which would require a somewhat more complicated visual style to distinguish and group the different inputs to a planned command application.

6.7 Summary

This chapter has described the construction of a user interface on top of the PSBase system described in chapter five. Three alternative styles were implemented. The implementation comprised two major phases:

The first phase was style-independent, primarily the creation of the application data base (and the background process that periodically updates the application data base). Other style-independent work is the writing of the simple direct-edit recognizers.

The second phase (for the icon-style and menu-style interfaces, at least) primarily consisted in using the PSBase-provided tools for defining and describing presentation styles, commands, command sets, move recognition rules, and presentation styles for opened and closed domain objects. These definitions have been illustrated in this chapter, and each is small and can be quickly and independently written. The examples given in this chapter are representative: the others are of about the same difficulty and size. The annotation-style interface required significant additional work in writing its recognizer. An improved PSBase would reduce this work to the scale of the other styles: the builder would simply write a few simple descriptions of the annotation style.

In other words, once the style-independent work has been completed, implementing a particular style is generally a matter of writing a relatively few small pieces using PSBase tools and choosing some standard PSBase components. This project has demonstrated that

even the small number of features provided by PSBase, a prototype presentation system base, covers a substantial amount of ground, enhanced by the ability to combine mechanisms in an independent manner.

Some rough statistics on the project reported here may help to support the claims about the ease and speed with which interfaces can be built on top of a presentation system base. (This discussion primarily covers just the icon-style and menu-style interfaces, since the annotation-style interface was developed together with PSBase at an earlier stage.) Of the roughly thirty days spent on the project, more than half were devoted to further work on PSBase itself. About five or six days were devoted to creating the application data base, the background management process, and the other common parts of the implementation. The background process took most of the time, more than anticipated, partly due to the problems of getting information from a distant host via communication network connections. (A few days involved determining the network scheme best suited for this experiment.)

About seven days were required to build the icon-style and menu-style interfaces (and the parts of the annotation-style interface that had not yet been completed -- the parts other than the annotation recognizer). This includes time spent at the end changing styles to experiment with the look of things.

Thus, six days were required for style-independent work and seven days for the style-specific work on the three different style implementations. An interesting note is that, while many interface builders will be constructing only one interface, some builders will want to experiment with different styles. This project illustrates how the experimentation process is helped too: the style-independent work, nearly half the effort here, is done just once.

Another statistic is the number of presentation styles. At the project's end there were about 80 styles defined. Several of the PSBase tools evolved during the project, and this number would be less if the presentation styles were defined from scratch now -- the number might be closer to 50 or 60. This chapter and chapter five have shown seven of these. These numbers, in any case, are not very large, and the definitions are simplified by

the fact that they do not have complex interactions. (They have few interactions, in fact -- merely the static inclusion of one style within another.)

Similarly, though only one move recognition rule and one open/close rule have been included here (and one of each in the previous chapter), there are only about five others in each category. The total in both categories is no more than a page of definitions.

The characteristics and statistics discussed lend credence to claims that a presentation system base greatly eases and speeds the development of a user interface. These are not flawless arguments, unfortunately. First, this has only been one project. It benefits in generality by including different styles, but there are a few categories that have not been included; one such is command completion [Tops20 80] [Zmacs 84] (and see section 4.2, page 78). Second, the project is a demonstration, not a user interface that will really be used. It lacks many features that would be required. The intent was to pick a representative sample of these features and to attempt to at least mimic styles and characteristics that are used in good-quality user interfaces. However, one cannot say that a good-quality, production user interface has yet been constructed on a presentation system base. More work needs to be done, to build more substantial presentation system bases and to discover just what benefits they can provide.

Chapter Seven

Areas for Further Research

This thesis discusses presentation based user interfaces in two major phases: first, discussion of the presentation system model and its use in describing existing user interfaces; and second, discussion of PSBase, the prototype presentation system base for building user interfaces. Each area can be further studied; both the model and PSBase have the character of a framework and need to be fleshed out.

The presentation system model could be developed further, its structure refined. More general parameters could be identified, kinds of presenter and recognizer control, for instance, or general ambiguities in recognizer action.

There is currently human factors research into what user interfaces *should* do for particular user groups, for instance, what properties they should have, what the structure of dialogs should be, and what error messages should say. However, there needs to be more work done from the opposite end, determining what user interfaces *can* do -- what the range of possible styles is. In terms of the definition of styles as patterns of presentation system parameters, the possible fundamental structures for these patterns should be determined, thus defining broad classes of styles.

7.1 PSBase Limitations

PSBase has several limitations. PSBase is a prototype, not a full-scale production system. Several parts of its implementation are patchy or somewhat inconsistent, resulting from the evolution of its design and the pressure of time. It provides examples of various features that a presentation system should have, enough in fact to build the interface discussed in the next chapter. However, more features in each category need to be provided, the existing mechanisms need to be improved, especially in order to better match the structure of the

presentation system model, and various mechanisms could benefit from being unified.

More Features Offered. Although this chapter has not fully enumerated all the features offered in each major category, most of the features have been illustrated. The following lists what would be required for a full-scale presentation system base:

- * More kinds of presentations, presentation relations
- * More presentation editor functions
- * More curve recognizers
- * More command argument parameter types
- * More (and cleverer) organizational presenters
- * More presenters
- * More recognizers, recognizer drivers

Better Mechanisms. In addition to providing more each kind of feature or mechanism, those that have been provided could be improved, by being made more general, more efficient, or more intelligent. The following lists the most important improvements needed; the first three are important in a general sense, in that they are requirements that PSBase match the structure of the model more closely:

- * Allow specification of semantic presenter style separate from domain collector, so it can be shared between styles, as organizational collector is
- * Allow identification of parts of presentation data base as PPS units
- * Allow recognizer invocation to depend on presentation context, or vary between PPS units
- * Improve the data base mechanism: richer structure, knowledge representation language, perhaps; better matching procedures
- * Have more recognizers driven more from descriptions, so interface builder does not need to write the semantic recognizers

Unified Mechanisms. Two major kinds of unification needs to be achieved in PSBase mechanisms. First is the invocation of continual and general recognizers. The distinction between the two kinds of recognizers does not seem to be an inherent one, nor is it a sharp distinction even in the current implementation. Perhaps there could be a single recognizer invocation mechanism.

Second, the various presentation style descriptions should be unified into a single language for describing presentation styles. The three kinds of descriptions shown in section 5.4, for defining graphical, sequence, and template presentation styles, are very similar. Making a single description language that merges the capabilities of these three kinds of defining forms should not be difficult.

Beyond that, however, the description of presentation style might be interpreted by more than just a presenter. Perhaps it could be interpreted by a recognizer as well. This would then ensure that many presenters and recognizers would be inverses, allowing the interface builder to provide greater uniformity in the interface style, between the presentation style used for output (constructed by presenters) and the presentation style used for input (recognized from user constructions).

References

- [Attardi & Simi 81]
Attardi, G., and Simi, M.
Semantics of Inheritance and Attributions in the Description System Omega.
In *Proceedings of IJCAI 81*. IJCAI, Vancouver, B.C., Canada, August, 1981.
- [Barber 82]
Barber, G.
Office Semantics.
PhD thesis, Massachusetts Institute of Technology, February, 1982.
- [Beil 82]
Beil, D.H.
The VisiCalc Book.
Reston Publishing Co., Inc., Reston, VA, 1982.
- [Bleser & Foley 82]
Bleser, T. and Foley, J. D.
Towards Specifying and Evaluating the Human Factors of User-Computer Interfaces.
In *Human Factors in Computer Systems*, pages 309-314. ACM, March, 1982.
- [Brachman 78]
Brachman, R. J.
A Structural Paradigm for Representing Knowledge.
Report 3605, Bolt Beranek and Newman, Inc., May, 1978.
- [Brachman & Schmolze 85]
Brachman, R.J., and Schmolze, J.G.
An Overview of the KL-ONE Knowledge Representation System.
Cognitive Science, 1985.
To appear.
- [Brown 82]
Brown, J. W.
Controlling the Complexity of Menu Networks.
Communications of the ACM 25(7):412-418, July, 1982.
- [Brown & Sedgewick 84a]
Brown, M. H. and Sedgewick, R.
A System for Algorithm Animation.
Technical Report CS-84-01, Brown University, January, 1984.

[Brown & Sedgewick 84b]

Brown, M. H. and Sedgewick, R.
Techniques for Algorithm Animation.
Technical Report CS-84-02, Brown University, January, 1984.

[Brown & Sedgewick 84c]

Brown, M. H. and Sedgewick, R.
Progress Report: Brown University Instructional computing Laboratory.
In *15th Annual Technical Symposium on Computer Science Education (ACM SIGCSE)*. ACM, February, 1984.
Also available as Brown University Technical Report No. CS-83-28

[CCA 79]

Program Visualization Concept Paper.
Computer Corporation of America.
Cambridge, MA

[diSessa 85]

diSessa, A.
A Principled Design for an Integrated Computational Environment.
Human-Computer Interaction 1(1), January, 1985.
To appear.

[Donelson 78]

Donelson, W.
Spatial Management of Data.
ACM, Atlanta, GA, 1978.

[Foley & Van Dam 82]

Foley, J. D. and Van Dam, A.
Fundamentals of Interactive Computer Graphics.
Addison-Wesley, Reading, MA, 1982.

[Forbus 81]

Forbus, K. D.
An Interactive Laboratory for Teaching Control System Concepts.
Report 4752, Bolt Beranek and Newman, Inc., September, 1981.

[Friedell 83]

Friedell, M.
Automatic Graphics Environment Synthesis.
Technical Report CCA-83-03, Computer Corporation of America, 1983.

[Gnanamgari 81]

Gnanamgari, S.

Information Presentation through Default Displays.

Computer and Information Sciences technical report 81-05-02, University of Pennsylvania, 1981.

[Hayes 84]

Hayes, P. J.

Executable Interface Definitions Using Form-Based Interface Abstractions.

In H. R. Hartson, editor, *Advances in Computer-Human Interaction*. Ablex, New Jersey, 1984.

[Herot 80]

Herot, C. F.

Spatial Management of Data.

ACM Transactions on Database Systems 5(4):493-513, December, 1980.

[Jacob 82]

Jacob, R. J. K.

Using Formal Specifications in the Design of a Human-Computer Interface.

In *Human Factors in Computer Systems*, pages 315-321. ACM, March, 1982.

[Kaczmarek, Mark & Wilczynski 83]

Kaczmarek, T., Mark, W., and Wilczynski, D.

The CUE Project.

In *SoftFair -- Software Development: Tools, Techniques, and Alternatives*, pages 383-389. IEEE, July, 1983.

[Lieberman 83]

Lieberman, H.

Designing Interactive Systems from the User's Viewpoint.

In P. Degano and E. Sandewall, editors, *Integrated Interactive Computer Systems*, pages 45-59. North-Holland, Amsterdam, 1983.

[Lieberman 84]

Lieberman, H.

Seeing What Your Programs Are Doing.

International Journal of Man-Machine Studies, July, 1984.

[Lisa 84]

Apple Lisa reference manual.

1984.

[Mark 81]

Mark, W.

Representation and Inference in the Consul System.

In *Proceedings of IJCAI 81*, pages 375-381. IJCAI, Vancouver, B.C., Canada, August, 1981.

[McDonald 83]

McDonald, David D.

Natural Language Generation as a Computational Problem: an introduction.

In Brady & Berwick, editors, *Computational Models of Discourse*, pages 209-264. MIT Press, 1983.

[Newman & Sproull 79]

Newman, W. M. and Sproull, R. F.

Principles of Interactive Computer Graphics, 2nd edition.

McGraw-Hill, New York, 1979.

[Purvy, Farrell & Klose 83]

Purvy, R., Farrell, J., and Klose, P.

The Design of Star's Records Processing: Data Processing for the Noncomputer Professional.

***ACM Transactions on Database Systems* 1(1):3, January, 1983.**

[Reiser 81]

Reiser, P.

Formal Grammar and Human Factors Design of an Interactive Graphics System.

***IEEE Transactions on Software Engineering* SE-7(2):229-240, March, 1981.**

[Reiser 82]

Reiser, P.

Further Developments Toward Using Formal Grammar as a Design Tool.

In *Human Factors in Computer Systems*, pages 304-308. ACM, March, 1982.

[Shneiderman 80]

Shneiderman, B.

Software Psychology: Human Factors in Computer and Information Systems.

Little, Brown, and Co., Boston, MA, 1980.

[Shneiderman 83]

Shneiderman, B.

Direct Manipulation: A Step Beyond Programming.

***IEEE Computer*, August, 1983.**

[Shneiderman & Mayer 79]

Shneiderman, B., Mayer, R.

Syntactic/Semantic Interactions in Programmer Behavior: A Model and Experimental Results.

International Journal of Computer and Information Sciences 8(3):219-239, 1979.

[Smith, Irby, Kimball, Verplank & Harslem 83]

Smith, D.C., Irby, C., Kimball, R., Verplank, B., and Harslem, E.

Designing the Star User Interface.

In P. Degano and E. Sandewall, editors, *Integrated Interactive Computer Systems*, pages 297-313. North-Holland, Amsterdam, 1983.

[Stallman 81]

Stallman, R. M.

EMACS Manual for ITS Users.

AI Memo 554, Massachusetts Institute of Technology Artificial Intelligence Laboratory, April, 1981.

Now only available as report AD-A093-186 from the National Technical Information Service, U.S. Dept. of Commerce, Reports Division, 5285 Port Royal Road, Springfield, Virginia 22161.

[Stevens & Roberts 83]

Stevens, A., and Roberts, B.

Quantitative and Qualitative Simulation in Computer Based Training.

Journal of Computer-Based Instruction 10(1,2):16-19, summer, 1983.

[Stevens, Roberts & Stead 83]

Stevens, A., Roberts, B., and Stead, L.

The Use of a Sophisticated Graphics Interface in Computer-Assisted Instruction.

IEEE Computer Graphics and Applications :25-31, March/April, 1983.

[Tops20 80]

TOPS-20 User's Guide.

Digital Equipment Corporation, Marlboro, MA, 1980.

Order no. AA-4179C-TM. Sections 2.2-2.4 discuss command completion.

[Weinreb, Moon & Stallman 83]

Weinreb, D. L., Moon, D. A., and Stallman, R. M.

Lisp Machine Manual.

Fifth edition, Massachusetts Institute of Technology Artificial Intelligence Laboratory, Cambridge, MA, 1983.

[Zdybel, Gibbons, Greenfeld & Yonke 81]

Zdybel, F., Gibbons, J., Greenfeld, N. & Yonke, M.
*Application of Symbolic Processing to Command and Control: An Advanced
Information Presentation System.*
Report 4752, Bolt Beranck and Newman, Inc., August, 1981.

[Zdybel, Greenfeld, Yonke & Gibbons 81]

Zdybel, F., Greenfeld, N., Yonke, M. & Gibbons, J.
An Information Presentation System.
In *Proceedings of IJCAI 81*. IJCAI, Vancouver, B.C., Canada, August, 1981.

[Zloof 82]

Zloof, M. M.
Office-by-Example: A Business Language that Unifies Data and Word Processing
and Electronic Mail.
IBM Systems Journal 21(3):272-304, 1982.

[Zloof & de Jong 77]

Zloof, M. M. and de Jong, S. P.
The System for Business Automation (SBA): Programming Language.
Communications of the ACM 20(6), June, 1977.

[Zmacs 84]

Zmacs Manual
Symbolics Inc., Cambridge, MA, 1984.