

ON THE NATURE OF GRAMMATICAL RELATIONS

by

ALEC PAUL MARANTZ

A.B., Oberlin College
(1978)

SUBMITTED TO THE DEPARTMENT OF
LINGUISTICS AND PHILOSOPHY
IN PARTIAL FULFILLMENT OF THE
REQUIREMENTS OF THE
DEGREE OF

DOCTOR OF PHILOSOPHY

at the

MASSACHUSETTS INSTITUTE OF TECHNOLOGY

September 1981

© Alec Paul Marantz 1981

The author hereby grants to M.I.T. permission to reproduce and
to distribute copies of this thesis document in whole or in part.

Signature of Author _____
Department of Linguistics and Philosophy
July 31, 1981

Certified by _____
Noam Chomsky
Thesis Supervisor

Accepted by _____
Samuel Jay Kayser
Chairman, Departmental Graduate Committee

HUM MASSACHUSETTS INSTITUTE
OF TECHNOLOGY

OCT 15 1981

LIBRARIES

ON THE NATURE OF GRAMMATICAL RELATIONS

by

ALEC PAUL MARANTZ

Submitted to the Department of Linguistics and Philosophy
on August 3, 1981 in partial fulfillment of the
requirements for the degree of Doctor of Philosophy

ABSTRACT

In this dissertation, I develop and support a theory of grammatical relations, i.e., a theory about the connection between semantic roles and dependencies and their expressions in sentences. Grammatical relations are defined as the syntactic counterparts of certain logico-semantic relations, such as the predicate-subject and modifier-modifiee relations. Associated with each sentence in a language is a "logico-semantic (l-s) structure" which displays the logico-semantic relations among sentential constituents. Within the theory of this dissertation, a structure called "syntactic (s) structure" stands between the l-s and surface structure in the analysis of any sentence. Just as the l-s structure of a sentence displays the logico-semantic relations among constituents, so the syntactic structure displays the grammatical relations constituents bear. One general principle governs the mapping between l-s and s structure: If X bears an l-s relation with respect to Y, then the s structure counterpart of X must bear a grammatical relation with respect to the s structure counterpart of Y, Y', or with respect to a phrase headed by Y'. S structures are mapped onto surface structures, which serve as input to the rules of phonology.

Chapter One describes the model of grammar I assume and provides an over-view of the dissertation. In Chapter Two, I explain in detail the formation and properties of l-s structure, the source and characteristics of grammatical relations, and the principles and lexical information which govern the mappings between l-s and s structure and between s and surface structure. Chapter Three contains evidence for the theory of grammatical relations described in the earlier chapters. In this chapter, I provide analyses for certain constructions whose derivations are often believed to involve lexical rules, rules referring to grammatical relations, or structure preserving movements transformations. The present theory predicts the syntax of these constructions from the features of the verbs which head them. The theory includes no "lexical rules" in the usual sense to derive these verbs; rather, I assume that the only truly productive process in the lexicon is affixation. The features of a derived word are determined from the features of its constituent parts according to simple

feature "percolation" conventions. Many of the constructions discussed in Chapter Three, e.g., the passive, display an alternate expression of a verb's semantic dependents from what might be expected from general considerations. The first set of constructions discussed -- the passive and antipassive constructions and constructions headed by a reflexive verb form -- result in the theory from the affixation to a verb of a morpheme lacking its own argument structure. The theory is shown to force analyses of these constructions which explain a wide range of phenomena related to them as well as account for their well-known properties. Another set of constructions analyzed in this chapter contain verbs derived through affixation to verbs roots of morphemes bearing their own argument structures. These include the "applied" verbs of the Bantu literature and derived causative verbs. The roots and affixes in such constructions are assumed to be separate l-s constituents which "merge" between l-s and surface structure. On this assumption, the theory predicts the syntax of applied verb and derived causative constructions. Differences in such constructions between various languages are explained by the hypothesis that the affix and root verb merge between l-s and s structure in some of these languages but between s and surface structure in others. Chapter Three also includes a discussion of a class of alternations in the expression of a verb's dependents, including the dative shift alternation and the alternation between the transitive and inchoative uses of a verb, which cannot be mediated by simple affixation within the present theory. The theory is shown to make correct predictions about such alternations in a variety of languages.

Ergativity is given a precise definition in Chapter Three and the theory is shown to predict striking differences between nominative-accusative and ergative languages. These predictions are confirmed with data from the ergative languages Dyirbal and Central Arctic Eskimo.

In Chapter Four, I consider how the theory of grammatical relations developed in the dissertation might be incorporated into the Government-Binding framework of Chomsky (1981) and the Lexical-Functional framework of Bresnan (1981a). I also briefly and critically review alternative approaches to grammatical relations. I compare the theory of this dissertation to other theories with regard to the source the theories postulate for grammatical relations and to the approach the theories take toward accounting for generalizations that seem true of grammatical relations. The present theory locates the source of grammatical relations in (logico-) semantic relations. It is explanatory in the sense that generalizations true of grammatical relations follow in the theory from fundamental principles of syntax and from the inherent properties of grammatical relations.

Thesis Supervisor: Noam Chomsky

Title: Institute Professor

ACKNOWLEDGEMENTS

I owe my greatest intellectual debt to my advisor, Noam Chomsky. I must thank him not so much for teaching me how to do linguistics as for leading me to discover what it means to do linguistics. This dissertation progressed only because Noam was willing to read and discuss with me weekly installments. I would also like to thank the other members of my dissertation committee. Ken Hale spirited me along with his constant encouragement and enthusiasm, while Joan Bresnan, by continually disagreeing, forced me to think more deeply.

Other professors in the Department of Linguistics and Philosophy should be acknowledged here for their starring roles in my education. Morris Halle has been guiding my linguistic career since I was a kid in his introductory phonology class in the Fall of 1976. Paul Kiparsky has set an example in the quality of his research and teaching, which I have tried to emulate.

I received much of my linguistic education just talking to people hanging around the MIT linguistics department. I am probably forgetting important names, but some of the people who listened to, argued with, and lectured to me over the past few years include Hagit Borer, Lori Levin, David Pesetsky, Bill Poser, Malka Rappaport, Tim Stowell, and Edwin Williams. Providing particular intellectual and/or emotional support during the production of this dissertation were the following sine qua probably nots: Shelly Lieber, K.P. Mohanan, David Nash, Barry Schein, Jane Simpson, Donca Steriade, and my parents.

A host of individuals and organizations aided with certain technical details associated with dissertation writing. I am indebted to Anthony Woodbury and Marion Johnson for happily providing requested Eskimo data. The people at MIT's Interlibrary Loan office proved remarkable, securing needed books and articles for me no matter how obscure or incomplete the reference. The support staff in the Department of Linguistics and Philosophy has been helpful beyond the call of duty. As the reader may notice, this dissertation was typed by committee, each member of which had his/her own ideas about spelling, punctuation, margins, etc. I thank the committee for helping me produce at least a neat document. Finally, I must acknowledge the National Science Foundation, whose graduate study fellowship supported me for the duration.

TABLE OF CONTENTS

ABSTRACT.....	2
ACKNOWLEDGEMENTS.....	4
CHAPTER ONE: INTRODUCTION.....	9
FOOTNOTE.....	27
CHAPTER TWO: THE NATURE OF GRAMMATICAL RELATIONS.....	28
2.0 Introduction.....	28
2.1 Logico-semantic (l-s) structure.....	28
2.1.1 Semantic roles and l-s relations.....	29
2.1.2 Constraints on l-s structure.....	42
2.1.3 Evidence for the present conception of logico-semantic structure.....	47
2.1.3.1 The asymmetry between the logical subject and a verb's arguments.....	47
2.1.3.1.1 Range of predicates.....	47
2.1.3.1.2 Idioms.....	51
2.1.3.2 Independent semantic role assignment.....	51
2.2 Semantic roles and the construction of predicate- argument structures.....	53
2.3 Syntactic (s) structure.....	60
2.3.1 Syntactic roles and grammatical relations.....	61
2.3.2 Constraints on s structure.....	68
2.4 The mapping between l-s and s structure.....	70
2.4.1 Mapping principles.....	70
2.4.2 Correspondences between l-s and s structure relations.....	73
2.4.2.1 The s structure counterpart of the modifier-modifiee relation.....	75
2.4.2.2 The s structure counterpart of the predicate-subject relation.....	77
2.4.2.3 The s structure counterpart of an l-s object in an argument phrase.....	77
2.4.2.4 The s structure counterpart of the argument taking item-argument relation.....	78
2.4.2.4.1 The logical object as SUB.....	79
2.4.2.4.2 The logical object as OBJ.....	81
2.4.2.4.3 The logical object as argument.....	81
2.4.2.5 Summary.....	85

2.5	Surface structure and the mapping between s and surface structure.....	86
2.5.1	General principles.....	87
2.5.2	Unusual expressions of grammatical relations.....	91
2.5.3	Structural positions and case markings as syntactic role assigners.....	97
2.6	Bearing multiple grammatical relations: Empty nodes at surface structure.....	98
2.6.1	General principles governing the appearance of constituents in surface structure.....	102
2.6.2	Some special cases of constituents bearing multiple grammatical relations.....	112
2.6.2.1	Raising.....	112
2.6.2.2	A note on obligatory control.....	118
2.6.2.3	The expression of SUBs as OBJs of tense/agreement related items.....	120
	FOOTNOTES.....	126
CHAPTER THREE: ALTERNATIONS IN THE EXPRESSION OF A VERB'S SEMANTIC DEPENDENTS.....		131
3.0	Introduction.....	131
3.1	Alternations in the expression of a verb's semantic dependents mediated by affixation of morphemes without independent argument structures.....	140
3.1.1	Passivization.....	143
3.1.1.1	Passivization in English.....	143
3.1.1.1.1	The passive affix.....	143
3.1.1.1.2	The <u>by</u> phrase.....	146
3.1.1.1.3	Passivization of raising verbs.....	149
3.1.1.1.4	Against a promotion analysis of passivization.....	150
3.1.1.2	Passivization crosslinguistically.....	158
3.1.1.3	The 1 Advancement Exclusiveness Law.....	166
3.1.2	Antipassivization.....	174
3.1.3	Lexical reflexivization.....	178
3.2	Alternations in the expression of a verb's semantic dependents not mediated by affixation.....	196
3.2.1	Dative Shift: Alternations in semantic role assigning properties.....	197
3.2.1.1	Dative shift with goal arguments.....	198
3.2.1.2	Dative shift with benefactives.....	208
3.2.1.3	The status of the dative shift alternations....	210
3.2.2	Alternations in argument structures.....	214

3.2.2.1 Anticausatives.....	214
3.2.2.2 Indefinite object deletion.....	230
3.3 Ergativity.....	234
3.3.1 Passive in ergative languages.....	238
3.3.2 Dative shift in ergative languages.....	241
3.3.3 Lexical reflexives in ergative languages.....	249
3.3.4 Appendix to 3.3: unmarked intransitive forms of Eskimo transitive verbs.....	256
3.4 Alternations in the expression of a verb's semantic dependents mediated by affixation of morphemes with independent argument structures.....	259
3.4.1 Applied verbs.....	267
3.4.1.1 Applied verbs with goals, benefactives, sources, and malefactives.....	268
3.4.1.1.1 Languages which allow one object/verb in the unmarked case.....	268
3.4.1.1.2 Languages which allow more than one object/verb in the unmarked case.....	277
3.4.1.2 Instrumental applied verbs.....	281
3.4.2 Causative constructions.....	299
3.4.2.1 Causative constructions without merger.....	305
3.4.2.2 Merger between s and surface structure.....	306
3.4.2.3 Merger between l-s and s structure.....	314
FOOTNOTES.....	326
CHAPTER FOUR: THEORIES OF GRAMMATICAL RELATIONS.....	339
4.0 Introduction.....	339
4.1 The present theory of grammatical relations and broader theoretical frameworks.....	340
4.1.1 The Government-Binding framework.....	340
4.1.2 The Lexical-Functional framework.....	349
4.2 Alternative theories of grammatical relations.....	352
4.2.1 Grammatical relations from structural relations.....	353
4.2.2 Grammatical relations from semantic roles.....	354
4.2.3 Grammatical relations from compositional semantics.....	356
4.2.4 Grammatical relations from clusters of properties.....	357
4.2.5 Grammatical relations as primitives.....	358
4.2.6 Relational Grammar.....	359
FOOTNOTES.....	364

BIBLIOGRAPHY..... 366
BIOGRAPHICAL NOTE..... 374

CHAPTER ONE: INTRODUCTION

Grammatical relations of some sort appear in virtually every grammatical theory from Pāṇini to the present. Within a grammar they are intimately connected with thematic or semantic roles such as "agent" or "theme" on the one hand, and with cases and structural relations such as nominative or accusative case or "NP immediately dominated by S" on the other. Often linguists define grammatical relations in terms of, or give them up in favor of, semantic or structural relations or nominal cases. In this dissertation, I will develop and support a theory of grammatical relations which places them as intermediaries in the connection between semantic roles and dependencies and the expression of these roles and dependencies in structural and positional relations and in case marking.

Consider sentence (1).

(1) Elmer threw the porcupine to Hortense.

Elmer appears as the NP immediately dominated by S ([NP, S]) in (1) because it is the subject of the verb, threw, and it is the subject of the verb because it names the bearer of the "thrower" role in the action described by threw. Conversely, because it is the [NP, S] in (1), Elmer is interpreted as the subject of threw, and because it is the subject, it is interpreted as the "thrower." Grammatical relations such as "subject" and "object" stand between the semantic roles constituents bear with respect to argument-taking words and phrases and the expressions of these semantic roles in sentences. The diagram in (2) represents this central idea, around which the dissertation is constructed,

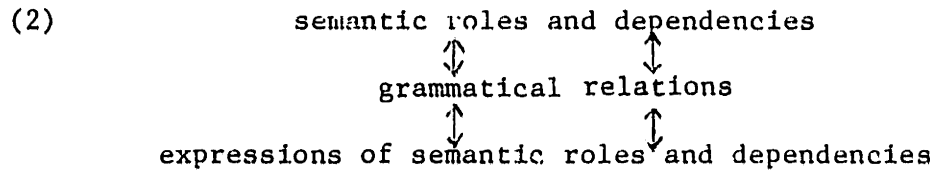

The conception of grammatical relations as mediating the connection between semantic roles and their expressions can be found in Pāṇini (see Kiparsky 1981, Kiparsky and Staal 1969, and Shibatani 1977).

Grammatical relations are not objects of study that can be identified outside a particular theory of grammar. Terms like "subject" and "object" have no clear pretheoretical reference. Since there is no general agreement over what grammatical relations are, one can not ask such questions as whether rules of verb agreement refer to grammatical relations without specifying some theory of grammatical relations to identify the objects of inquiry. It is widely believed that a crucial question for linguists is whether grammatical relations are definable or primitive. But because grammatical relations have different characterizations -- and grammatical relational terms different extensions -- in different theories, the question of the definability of grammatical relations arises only within particular theories of grammar.

So we may ask whether in theory T the grammatical relational terms are primitive or defined. As Chomsky (1981) points out, this question is of some interest when the theory of grammar is considered to represent the child's innate linguistic knowledge. Whatever the primitives of a linguistic theory qua innate linguistic knowledge are, the child must be able to associate them with the stream of speech which constitutes his linguistic experience. If grammatical relations are primitives in a theory,

the child must still have some means to pick subjects and objects out of the utterances which confront him. Any theory is suspect which postulates grammatical relations as primitives but which does not provide a reasonable account of how children manage to learn the extensions of grammatical relational terms.

The definability of grammatical relations within particular theories is an important issue from the standpoint of language acquisition. The debate in the literature over whether grammatical relations are primitive covers important issues as well, but they are not in fact issues of definability. When linguists appear to be arguing over whether grammatical relations are definable or primitive, they are often really arguing over whether the connection between semantic roles and structural positions or case marking is direct or indirect. If the connection is direct in a theory, grammatical relations are said (without proper justification) to be "defined" in the theory because rules which are often believed to refer to grammatical relations, e.g., subject-verb agreement, will refer instead within the theory to groups of constituents classified according to their semantic roles or according to their structural positions or case marking. When the mapping between semantic roles and their expressions is indirect in a theory, i.e., mediated by grammatical relations as shown in (2), the theory's grammatical relations are considered "primitive."

The issue of whether grammatical relations are defined or primitive is also confused with the issue of how a theory should account for alternations in the expressions of semantic roles like the passive alternation illustrated in (3).

- (3) a. Elmer threw the porcupine to Hortense.
 b. The porcupine was thrown to Hortense.

It is clear that the "thrown" argument in (3a) and (3b) -- the porcupine -- is expressed in different structural positions in the two sentences. If a theory accounts for alternations like the passive with a rule which refers only to semantic roles or with a rule which maps phrase markers onto phrase markers, the theory is considered (without proper justification) to have defined grammatical relations in semantic or structural terms. If a theory accounts for the passive alternation with a rule which refers directly to grammatical relations, the grammatical relations in the theory are said to be "primitive."

The important problems to be addressed by a theory of grammatical relations include the nature of the connection between semantic roles and their expressions and the proper account of alternations in the expression of semantic roles like the passive alternation illustrated in (3). As explained above, the technical question of whether grammatical relations are defined or primitive arises only within particular theories and is of general interest only in connection with the acquisition problem. In claiming that grammatical relations are primitives within their theory, Relational Grammarians like Perlmutter (see, e.g., Perlmutter 1980a) really mean to emphasize that the association of semantic roles and their expressions is mediated by grammatical relations in Relational Grammar and that alternations like the passive are handled by rules referring directly to grammatical relations. In fact it is quite likely that the grammatical relations of Relational Grammar may be defined in terms of primitives of the theory. Relational Grammar assumes that the initial assignment of grammatical relations to semantic roles is fixed in universal grammar.

For example, an agent in a sentence will be the initial subject of the sentence in every language. Given that the semantic role terms are primitives in Relational Grammar, as is the concept "assign a grammatical relation to a semantic role," the grammatical relations of Relational Grammar may be defined in the following manner. Suppose S is the set of semantic roles assigned the subject relation by the universal initial assignment of grammatical relations to semantic roles. We define "subject" as the grammatical relation universally assigned to S. The remaining grammatical relations are defined in a parallel manner. Within Relational Grammar it is an important question whether the universal initial assignment of grammatical relations to semantic roles is consistent with the other laws of the theory and with data from natural languages. In that sense, then, it is important within the theory whether grammatical relations are definable or primitive. However, in evaluating the merits of Relational Grammar, the crucial consideration is not whether grammatical relations are primitives in the theory but whether the theory provides the best account of the connection between semantic roles and their expressions.

To repeat, a theory of grammatical relations is a theory about the connection between semantic roles and their expressions in sentences. This dissertation presents one such theory and demonstrates its explanatory power; some alternative theories are discussed in Chapter 4.

What is the nature of grammatical relations in the theory of this dissertation? Grammatical relations are the syntactic counterparts -- the "grammaticalizations" so to speak -- of certain logico-semantic relations such as the predicate-subject and modifier-modifiee relations. Associated with each sentence in a language is a "logico-semantic structure"

(l-s structure) which displays the logico-semantic relations or interdependencies among the constituents of the sentence. The l-s structure of a sentence is not its semantic representation in the usual sense; it merely represents the syntactically encoded semantic dependencies among sentential constituents. Logically, it would be possible for languages to connect l-s structures directly to the surface structures of sentences, i.e., to express the logico-semantic relations directly in surface structure case marking, structural configurations, etc. Although a direct mapping between l-s structures and surface structures cannot be ruled out a priori, I will claim that there is a structure called "syntactic structure" similar in form and make-up to l-s structure which stands between the l-s structure and surface structure in the analysis of any given sentence. Corresponding to each type of logico-semantic relation in l-s structure there is a type of grammatical relation in syntactic structure. Just as the l-s structure of a sentence displays the logico-semantic relations among constituents, so the syntactic structure of a sentence displays the grammatical relations constituents bear with respect to one another.

The model of grammar I will adopt in this dissertation is schematized in (4). I have drawn (4) to emphasize its similarities with the model proposed in Chomsky (1980b) and elaborated in Chomsky (1981). In Chapter 4 I will discuss the few but important differences between the two models.

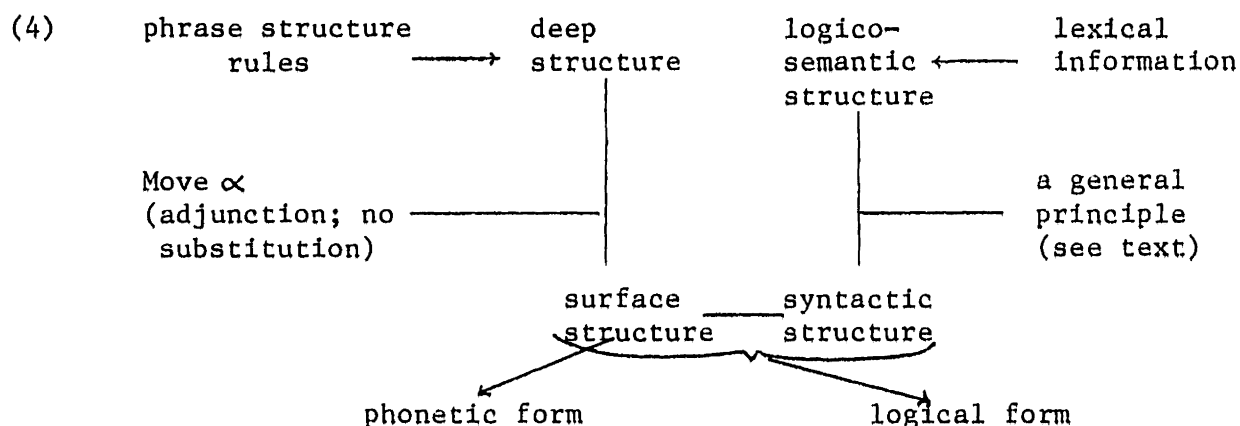

On the left-hand side of the grammar in (4) the phrase structure rules of a language generate deep structures into which lexical items are inserted. Although nothing in this dissertation hinges on the treatment of the long-distance dependencies captured by wh-movement in transformational grammars, I assume that a general trace-leaving movement and adjunction rule, Move α , generates surface structure from deep structures. A framework without "Move α ," in which traces are generated directly by the phrase structure rules in such constructions as constituent questions and relative clauses, would be completely compatible with the present work. Note that Move α in (4) merely (Chomsky-)adjoins the moved constituent to a node; there are no structure-preserving, i.e., substitution, transformations, in this model. The rules of phonology map the surface structure of a sentence onto a phonetic form.

On the right-hand side of the grammar in (4), information contained in the lexical entries of morphemes determines a logico-semantic (l-s) structure. As stated above, the l-s structure of a sentence displays the logico-semantic relations among constituents. These include the relation between a predicate and its subject and that between a verb and a constituent for which the verb determines a semantic role in a sentence, i.e., to which the verb "assigns" a semantic role. In (1) above the verb threw determines that the porcupine will bear the "theme" role; in other words, threw assigns the theme role to the porcupine. An l-s structure may be represented as a constituent structure tree in which only the dominance relations, and not linear order, are significant. Each phrasal constituent at l-s structure consists of a logico-semantic "operator," like a predicate or semantic role assigner, and its l-s dependents, like the subject of

the predicate or the constituents to which the role assigner assigns semantic roles.

The syntactic (s) structure of a sentence displays the grammatical relations among constituents, such as the relation between a verb phrase and its subject or the relation between a verb and its object. Recall that grammatical relations are "grammaticalizations" of l-s relations in the sense described above. An s structure may also be represented as a constituent structure tree in which linear order has no interpretation. Each phrasal constituent at s structure consists of a grammatical "operator," e.g., a VP, and its grammatical dependent(s), e.g., the subject of the VP.

Every l-s constituent has a counterpart in s structure, but because two l-s constituents may correspond to a single constituent in s structure, the mapping between constituents is not one to one. The grammar must include certain definitions and principles to determine the s structure counterpart of each constituent at l-s structure. Once the correspondence between l-s and s structure constituents is fixed, one general principle governs the mapping between l-s and s structures: If X bears an l-s relation with respect to Y, Y the "operator" in the relation, then the s structure counterpart of X must bear a grammatical relation with respect to the s structure counterpart of Y, or with respect to a phrase headed by the s structure counterpart of Y. A constituent is the "head" of a phrase if it determines the category of the phrase. The mapping between l-s and s structures is also heavily governed by lexical properties of constituents. For example, only if a verb is grammatically transitive may it take an object at s structure. If a constituent, X, bears an l-s relation with respect to a verb, V, at l-s structure, and the s structure counterpart of the verb, V', is intransitive, then the s structure counter-

part of the constituent, X', may not be the object of V' although this correspondence may be allowed by the principle stated above.

No grammatical rules in the usual sense forge the connection between l-s and s structure in (4); there are no movements, substitutions, promotions, demotions, or clause unions, only the general principle described above and features of lexical items. Nor do I posit "lexical rules" in the usual sense to handle, e.g., passive constructions or sentences containing morphologically derived causative forms. Rather, I assume that the only truly productive process in the lexicon is affixation. Affixes, such as the passive affix and the causative affix, carry features just like any other morpheme with a lexical entry. The features of a derived word are determined from the features of its constituent parts according to simple "percolation" conventions described and independently motivated in Lieber (1980): Features of constituent morphemes "percolate" up in a word tree, which displays the internal structure of a derived word, to become the features of the derived word. The features of affixes take precedence over the features of roots in percolation, although where an affix is unspecified for a feature, that feature percolates up from the root morpheme to become a feature of the derived verb. For example, a derived word consisting of a transitive verb and an intransitive affix will be intransitive, since the ⁽¹⁷⁾transitivity feature of the affix will take precedence over the transitivity feature of the root in percolation. If the affix were unmarked for transitivity, however, the derived word would be transitive, receiving the transitivity feature of the root when the affix is unspecified for that feature. Assigning the correct features to affixes like the passive affix accounts in the present framework for the constructions analyzed in other theories as implicating lexical rules,

relation changing rules, rules of clause union, or structure preserving NP movement transformations.

The s structure and surface structure of a sentence are related in (4) by specific statements in a language about the expression of grammatical relations in surface structure. For example, a language might generally require that objects of verbs in s structure appear in the accusative case in surface structure, although individual verbs in the language might also make special demands on the expression of their objects. A principle to be discussed in Chapter Two governs the association of surface and s structures. Informally put, the principle insures that the expression of a constituent, X, at surface structure is dictated by the lexical item, Y, in s structure, with respect to which the s structure counterpart of X bears a grammatical relation. This principle, when stated precisely, has consequences for the distribution of PRO (see Chomsky 1981) and for the behavior of "raising" constructions. For example, the principle explains why only grammatical subjects "raise" and why raising only raises constituents to subject or object.

I call the level of structure between l-s and surface structure "syntactic" or "s" structure to emphasize its association with the S-structure of Government-Binding (GB) theory (Chomsky 1981). The principles of GB theory which apply at S-structure and which make crucial reference to the notion "government" will apply to s structure in the present theory; "X governs Y at S-structure" in GB theory is roughly equivalent to "Y bears a grammatical relation with respect to X" in the present framework. One set of GB principles which should apply to s structure in the present framework is "binding theory," which deals with possible reflexive-antecedent connections and with the possibilities of coreference among pronominal

and nonpronominal noun phrases in a sentence.¹

Rules of the "logical form component" (see Chomsky 1981 and the references cited there) apply to the pair consisting of the *s* structure and the surface structure of a sentence to derive a "logical form" for the sentence. The logical form serves as input to rules of semantic interpretation.

In Chapter Two I explain in detail the formation and properties of *l-s* structure, the source and characteristics of grammatical relations, and the principles and lexical information which govern the mappings between *l-s* and *s* structure and between *s* and surface structure. To provide a complete picture of that portion of the model in (4) which falls between *l-s* and surface structure -- the goal of Chapter Two -- is to provide a theory of grammatical relations, i.e., a theory of the mapping between semantic roles and their expressions. At the end of Chapter Two I discuss the distribution of "PRO" -- the phonologically null pronominal anaphor of Chomsky (1981) -- and the analysis of the so-called "raising to subject" and "raising to object" constructions.

Although some motivation is provided in Chapter Two for certain aspects of the theory of grammatical relations presented there, convincing evidence for the present theory is reserved for Chapter Three. To begin Chapter Three I outline the theory of morphology I will be assuming, adopted from Lieber (1980). In this theory affixes have lexical entries essentially like those of root morphemes, with the exception that affixes have morphological subcategorization features which specify what constituents they may attach to in the lexicon. The properties of derived words are determined by the percolation of features from the lexical entries of their constituent morphemes, as described above.

In the remainder of the chapter, I provide analyses for certain constructions whose derivations are often believed to involve lexical rules, rules referring to grammatical relations, or structure preserving movement transformations. The analyses are intended to apply to any language, and data from many languages are examined. Many of the constructions to be considered display an alternate expression of a verb's semantic dependents from what might be expected from general considerations. For example, although the logical object of a transitive verb generally appears as its direct object, the logical object of a passive participle in a passive construction is expressed as the subject of the verb phrase the passive participle heads. The first set of constructions discussed -- passive sentences, antipassive sentences, and sentences containing reflexive verb forms -- all result in the present theory from the affixation to a verb of a morpheme lacking an argument structure of its own. The theory of grammatical relations developed in Chapter Two is shown to force analyses of these constructions which account for the well-known properties of the constructions but which also explain a wide range of phenomena related to them. For example, the theory explains the presence of passive morphology in sentences which do not involve the "promotion" of a noun phrase to subject; it explains the crosslinguistically widespread homophony between passive and reflexive verb forms; and it explains data used to support the "1 Advancement Exclusiveness Law" of Relational Grammar (see Perlmutter and Postal 1978a). It should be emphasized that the analyses of passive and reflexive constructions which explain the phenomena just mentioned are not merely compatible with the theory presented in Chapter Two; they are demanded by the theory.

The second major section of Chapter Three explores a special set of

alternations in the use of verbs, including the "dative shift" alternation illustrated in (5), the "inchoative" alternation displayed in (6), the "stative" alternation shown in (7), and the "indefinite object deletion" alternation illustrated in (8).

- (5) a. Elmer gave a porcupine to Hortense.
b. Elmer gave Hortense a porcupine.
- (6) a. Elmer broke the porcupine.cage
b. The porcupine cage broke.
- (7) a. Elmer hung the clothes on the line.
b. The clothes hung on the line.
- (8) a. Elmer ate mock-porcupine pie all evening.
b. Elmer ate all evening.

Within the present theory, the alternation in (5) must be analyzed as an alternation in which semantic role the verb give assigns; give assigns the theme role in (5a) and the goal role in (5b). The alternations illustrated in (6-8) result from alternations in the argument structures of break, hang, and eat. If alternations like those in (5-8) are correctly analyzed as involving alternations in the semantic role assigning properties or argument structures of verbs, the theory precludes relating the verbs in the a. sentences of (5-8) to the verbs in the b. sentences through affixation to either the a. or b. verbs of a morpheme specific to these alternations, e.g., a "dative shift" affix for the alternation in (5). To put it another way, the theory does not permit the alternations in (5-8) to be mediated by affixation alone. Moreover, on the assumption that the alternations in (5-8) implicate alternations in semantic role assigning properties or argument structures, the theory provides no productive mechanism which could associate the verbs in the a. sentences to the verbs in the b. sentences. That it cannot relate the a. verbs to the b. verbs in (5-8) by productive rule is shown to be an advantage rather

than a defect of the present theory. Crosslinguistically, the alternations illustrated in (5-8) are limited to a small, semantically coherent set of verbs in each language, the members of each set largely synonymous from language to language. In addition, alternations like those between the a. verbs and b. verbs in (5-8) are never signalled by an affix on one of the verbs distinctive to the alternation in question. The theory leads one to expect these characteristics of alternations in the expression of a verb's semantic dependents which result from alternations in the semantic role assigning properties or argument structures of verbs and therefore can not be mediated by affixation within the theory.

The theory developed in Chapter Two also predicts the existence of "ergative languages." Ergativity is given a precise definition in Chapter Three and the theory is shown to predict striking differences between nominative-accusative and ergative languages. These predictions are confirmed with data from Dyirbal (Dixon 1972) and Central Arctic Eskimo (Johnson 1980).

The last major section of Chapter Three treats constructions containing verbs derived through the affixation to verb roots of morphemes bearing their own argument structures. First, I provide an account of "applied verb" constructions like the Chi-Mwi:ni (Kisseberth and Abasheikh 1977) benefactive applied verb construction illustrated in (9b) (the abbreviations in (9) will be explained in Chapter Three).

- (9) a. Hamadi \emptyset -sh-pishiŋe cha:kuja.
 Hamadi SP-OP-cooked food
 'Hamadi cooked the food.'
- b. Hamadi \emptyset -wa-pik-il-ile wa:na cha:kuja.
 Hamadi SP-OP-cook-APPL-T/A children food
 'Hamadi cooked food for the children.'

Applied affixes are assumed to have the same lexical entries as prepositions like English for and to, with the exception that the affixes but not the prepositions contain the morphological subcategorization features of a bound affix; i.e., they attach to verbs to make verbs. In l-s structure the root verb -pik- 'cook' and the applied affix -il- in (9b) are separate argument-taking items just like the verb cook and the preposition for in the l-s structure of the English gloss of (9b). Most of the syntactic features of applied verb constructions follow immediately in the theory from this assumption that the applied affix is just like a preposition. For example, the theory explains why the benefactive NP wa:na 'children' in (9b) displays direct object properties while cha:kuja 'food,' the logical object of the root verb -pik- 'cook,' does not, although cha:kuja 'food' does display object properties in (9a), which lacks the applied affix. The theory also explains the expression of cha:kuja 'food' as a postverbal NP without case marking even though it is not the direct object of the main verb of the sentence.

Instrumental applied verbs are given special attention in Chapter Three. Instrumental applied affixes resemble the benefactive applied affix in (9b) except that they have the logico-semantic properties of English with rather than those of English for. An observation made by Dick Carter (personal communication) about the semantics of instrumentals is formalized and shown to explain syntactic differences between instrumental and other applied verb constructions in some languages. Otherwise puzzling facts about instrumental applied verb constructions in certain Niger-Congo languages follow immediately if we assume that in some languages the root verb and instrumental applied affix -- distinct l-s constituents -- form a single s structure verb, while in other languages, the root and affix

remain separate at s structure but form a single verb in surface structure.

Morphologically derived causative verbs are the topic of the last section of Chapter Three. I assume that the causative affixes in languages with derived causatives have the same argument structures and syntactic features as independent causative verbs like English make. The only difference between causative affixes and independent causative verbs is that the former but not the latter are bound morphemes, i.e., attach to verb roots in the lexicon. The major syntactic properties of derived causative constructions, described, e.g., in Comrie (1976) and in the Relational Grammar literature, follow immediately in the theory from this assumption about causative affixes. Derived causative constructions are shown to divide into two classes crosslinguistically according to their syntactic behavior. A schematic English gloss of the paradigmatic causative sentence is shown in (10).

- (10) causer causes [causee to lower-verb (logical-object-of-lower-verb)]
 Elmer caused [Hortense to eat (cake)]

In the first sort of causative construction, found in Japanese and many of the Bantu languages, the "causee" is the direct object of the derived causative verb (in its active form) regardless of the transitivity of the root (lower) verb onto which the causative affix is attached. The logical object of the root verb is never a direct object of the (active) derived verb in this sort of causative construction. The Japanese sentences in (11) illustrate this sort of derived causative.

- (11) a. Taroo ga Hanako o hatarak-ase-ta.
 Taro NOM Hanako ACC work-CAUSE-PAST
 'Taro made Hanako work.'
 b. Taroo ga Hanako ni sashimi o tabe-sase-ta.
 Taro NOM Hanako DAT sashimi ACC eat-CAUSE-PAST
 'Taro let/ma Hanako eat sashimi.'

The second type of causative construction, called the "paradigm case" in Comrie (1976), is found in Turkish, Malayalam, and many other languages discussed by Comrie. In these languages, the logical object of the root (lower) verb, if it takes one, is always a direct object of the (active) derived verb. The Turkish sentences in (12) illustrate this second sort of derived causative.

- (12) a. Ali Hasanı öl-dür-dü.
 Ali Hasan-ACC die-CAUSE-PAST
 'Ali caused Hasan to die.'
- b. Dişçi mektub-u müdür-e imzala-t-tı.
 dentist letter-ACC director-DAT sign-CAUSE-PAST

The theory predicts the above-mentioned differences between the two types of causatives on the assumption that the causative affix and root verb -- separate l-s structure items -- form a single s structure constituent in the second type of causative construction, but remain distinct constituents until surface structure in the first. Other differences between the two sorts of derived causative constructions are shown to follow from the same assumption about the differing locus of merger of root verb and causative affix between the two sorts.

The theory of grammatical relations developed and supported in this dissertation is only a piece of a theory of grammar. In Chapter Four I consider how this theory of grammatical relations might fit into theoretical frameworks with wider scope, in particular, the Government-Binding (GB) framework of Chomsky (1981) and the Lexical-Functional framework of Bresnan (1981a). Although the theory is broadly compatible with both these theoretical frameworks, both would require modifications to incorporate the present theory as a subpart. For example, if the present theory were implanted in the GB framework, the principles connecting l-s with s structure would replace Chomsky's "projection principle" (see Chomsky 1981). The

few essential differences between the theory of this dissertation and GB theory are noted in Chapter Four.

In the second part of the chapter, alternative approaches to grammatical relations are briefly and critically examined, with special attention given to Relational Grammar. I compare the theory of grammatical relations supported in this dissertation to other theories in the literature with regard to the source the theories postulate for grammatical relations and the approach the theories take toward accounting for phenomena which seem to implicate grammatical relations. The present theory locates the source of grammatical relations in semantic relations; grammatical relations are grammaticalizations of logico-semantic relations. In contrast, many other theories consider semantic roles, not semantic relations, to be the source of grammatical relations in one sense or another of "source." For example, some theories identify semantic roles as the source of grammatical relations in the language acquisition process; others consider semantic roles the source of grammatical relations in the syntactic derivation of every sentence. In the present theory, generalizations true of grammatical relations are shown to follow from fundamental principles of syntactic theory and from the inherent properties of grammatical relations. In contrast, most other theories account for generalizations true of grammatical relations by postulating laws or rules which refer to specific grammatical relations and which are logically independent of the fundamental principles of the theories and of the proposed inherent properties of grammatical relations within the theories. At the end of Chapter Four data discussed earlier in the dissertation are shown to raise difficulties for the particular assumptions of Relational Grammar.

FOOTNOTE

1. "Binding theory" should apply to s structure if it is correctly stated solely in terms of "government" and "governing category." Mohanan (1981c) has presented evidence from Malayalam and other languages that at least the determination of possible coreference between a pronoun and an NP is dependent on the linear order of these constituents in some languages. Because linear order is not a feature of s structure, pieces of binding theory may have to refer to surface structure in (4), at which linear order of constituents is established.

CHAPTER TWO: THE NATURE OF GRAMMATICAL RELATIONS

2.0. Introduction. In this chapter I develop that section of the model of grammar in (4) of Chapter One which leads from logico-semantic (l-s) structure through syntactic (s) structure to surface structure. I describe and discuss the types of constituents found at each level of analysis and the sorts of relations that interconnect the constituents at each level. I also present and explore the consequences of a few general principles which constrain the mapping between l-s and s structures and between s and surface structures.

Much of this chapter is highly technical. I introduce principles and explore their formal consequences within the grammar without giving considerable attention to the relationship of these consequences to natural language data. The application of the principles to particular problems in syntactic analysis is reserved, for the most part, for Chapter Three. The reason for separating the introduction of grammatical principles from the predictions they make concerning properties of natural languages is that the predictions do not follow from individual principles but rather from the interactions of principles. All the essential principles must be in place before the theory makes predictions about grammars of particular languages. I will provide motivation for the principles introduced in this chapter, but not extensive demonstration of their validity.¹

2.1. Logico-semantic (l-s) structure. Logico-semantic (l-s) structure is a representation of the syntactically relevant semantic interdependencies among sentential constituents. In this section I introduce the types of constituents which are found at l-s structure and the sorts of relations in which these constituents stand with respect to one another. The discussion of l-s structure begins with the semantics of verbs -- the

canonical "heads" or "pivots" of sentences.

2.1.1. Semantic roles and l-s relations. A verb is associated with some number of "inherent" semantic roles, roles inextricably connected with the meaning of the verb. Although locative, benefactive, temporal, and other such arguments may be interpreted freely with a wide range of verbs, certain semantic roles are implicated in the semantics of verbs themselves, and arguments bearing these roles appear only with the verbs which select them. In (1) I list some verbs with their associated semantic roles; see section 2.2 below for a discussion of the semantic role terms, e.g., "agent," appearing in (1).

- (1) a. touch: agent, patient,
 b. give: agent, theme, goal
 c. buy: source (seller), goal (buyer), theme (thing bought),
 means (money exchanged)

Although it may be difficult in practice to tell whether or not a constituent in a given sentence bears one of the inherent semantic roles of the verb heading the sentence, the distinction between inherent and non-inherent semantic roles may be clearly stated: The verb dictates how to incorporate the constituents bearing its inherent semantic roles into the semantics of the clause of which it is the head. Non-inherent semantic roles are "adverbial" in the sense that the semantic effect on a clause of the constituent bearing them is not determined by the head of the clause.

The inherent semantic roles associated with a verb constitute its "case frame" in the terminology of Case Grammar.² Although they argue about specific examples, case grammarians and others who work on thematic or semantic roles³ more or less agree on the number and sorts of semantic roles to attribute to verbs. I refer the reader to Ostler (1979) for an overview of the literature on thematic/semantic roles and Abraham (1978) for a

number of articles on case frames. According to general consensus, verbs possess from no to perhaps a maximum of four inherent roles. English weather verbs like rain fall at the low end of the spectrum with no inherent semantic roles while transactional verbs like buy or sell fall at the high end with four roles each -- see (1c).

Various attempts have been made to provide an adequate account of the semantic roles which seem to be involved in verb semantics. The work of Jackendoff (1976) and Ostler (1979) (see also Carter 1976) illustrates one of the most interesting of these attempts. Although I will argue for a radically different conception of semantic roles from that offered by these authors, an understanding of their approach is an almost indispensable prerequisite to an understanding of mine.

Jackendoff (1976) and Ostler (1979) decompose the meanings of verbs into complexes of primitive predicates such as CAUSE (x,y) and GO (x,y,z) (I follow Jackendoff 1976 in this discussion). Constituents bear one or another semantic role by virtue of appearing in a particular slot in one of these primitive predicates. For example, a constituent falling into the first slot of the GO (x,y,z) predicate bears the theme role, that appearing in the second slot bears the source role, that in the third slot the goal role. To say that the subject of fly, e.g., bears the theme role is to say that the GO predicate appears in the semantic decomposition of fly and that fly's subject is inserted into the first slot of this predicate. Jackendoff (1976, p. 94) gives (2) as a semantic representation for fly.

(2) fly $\left[\begin{array}{l} \text{GO (x,y,z)} \\ \text{THROUGH THE AIR} \end{array} \right]$

In Jackendoff's system, the inherent semantic roles of a verb are simply

the roles associated with the slots in the primitive predicates which constitute the verb's semantic decomposition.

The issue of whether words are semantically decomposable is irrelevant to this dissertation (but see Fodor, Fodor, and Garrett 1975, Fodor et. al. 1980). However, I must assume that the linguistically relevant representation of a verb's argument structure generally involves no decomposition. Each verb is viewed as a function⁴ from arguments bearing certain specified semantic roles to predicates, which may assign an additional semantic role to their subjects. The semantic roles born by the arguments which serve as input to the function the verb names plus the semantic role assigned by the predicate which is the output of this function, constitute the verb's inherent semantic roles. Consider a verb like give, which we claimed in (1) to have for its inherent semantic roles a "giver" or agent, a "receiver" or goal, and a "given" or theme. The function give names takes as input an argument bearing the goal role and an argument bearing the theme role and yields a predicate which we might paraphrase as the open sentence (x give theme-NP to goal-NP). The predicate assigns the agent, or more properly, the "giver of theme-NP to goal-NP" role to its subject, the constituent which substitutes for its free variable to form a proposition.

We may represent a verb's semantics in the functional notation shown in (3).

(3) 'give' (theme, goal)

The representation in (3) indicates that the 'give' function requires an argument bearing the theme semantic role to fill its first slot and an argument bearing the goal role to fill its second slot. The value of the function in (3) is a predicate assigning the giver role to its subject. For typographical convenience we place the names of the semantic roles born

by arguments filling each slot in a function like (3) inside rather than underneath the slots, as shown in (4).

(4) 'give' (theme, goal)

I will call representations such as (4) "predicate-argument structures" or P-A structures.

One essential difference between predicate-argument structures and Jackendoff's notation for primitive predicates is that, while constituents in Jackendoff's framework receive their semantic roles by virtue of occupying positions within predicates, the constituents inserted in the slots of a P-A structure like (4) already bear the indicated semantic roles, which must be assigned to them in some manner independent of the verb's function from arguments to predicates. The give function in (4) is defined only over ordered pairs of constituents, the first bearing the theme role, the second the goal role. In the present theory, we separate the organization of arguments into a predicate, performed by the function a verb names, from the assignment of semantic roles to these arguments.

Since it is crucial to this dissertation, the notion of semantic role assignment warrants further clarification here. Consider sentence (5).

(5) Elmer gave a porcupine to Hortense.

Speakers of English know from sentence (5) that Elmer denotes a giver, that a porcupine denotes something which underwent a transference of possession, and that Hortense denotes the recipient of a porcupine. One general approach to accounting for this knowledge is to suppose that the verb gave in (5) names a machine which organizes the NPs into some sort of structure suitable for semantic interpretation. On this account, speakers may deduce the semantic roles of the various NPs in (5) from the semantic interpretation of the sentence. In this dissertation I adopt the alternate view that con-

stituents in sentences assign semantic roles to -- determine the semantic roles of -- other constituents independent of the semantic organization of the entire sentence or clause in which the constituents appear. For example, the preposition to assigns the goal or recipient role to Hortense in (5). On this view a speaker's knowledge of the semantic role of a constituent need not be deduced from the semantic representation of a sentence but may be computed directly from a syntactic analysis of the sentence. A determination of the semantic roles born by constituents is in fact logically prior to the derivation of a semantic representation since, for example, verbs name functions from constituents bearing certain semantic roles to predicates. Although I present some direct support in 2.1.3.2. below for the notion of semantic role assignment I adopt, the convincing argument for the notion is the explanatory power of the theory built on it, the theory of this dissertation.

So in the present theory constituents do not receive semantic roles by virtue of occupying slots in predicates like GO (x,y,z), but are assigned their semantic roles. Semantic roles may be assigned by the items listed in (6).

- | | | |
|-----|--|---------------------------------|
| (6) | a. predicates | c. case markings |
| | b. lexical items (verbs, pre-positions, nouns, adjectives) | d. certain structural positions |

In sentence (7), in addition to naming a function from arguments to a predicate, gave assigns the "given" or theme role to the porcupine. The preposition to assigns the goal role to Hortense, and the predicate (x give the porcupine to Hortense) assigns the "giver of the porcupine to Hortense" role to Elmer.

- (7) Elmer gave the porcupine to Hortense

I will underline within the predicate-argument structure of a verb the

semantic role or roles the verb assigns, as in (8).

(8) 'give' (theme, goal)

In the unmarked case, each of the semantic role assigners in (6) will assign only one semantic role. Predicates are limited to one semantic role by principle (9).

(9) All predicates in natural languages are (at most) monadic; that is, a predicate will assign (at most) one semantic role.

The ability of case markings and structural positions to assign semantic roles is special and will be discussed below. It turns out that an independent principle, related to the special nature of these semantic role assigners will rule out the possibility of a given instance of a case marking or structural position assigning more than one role in 1-s structure. As for lexical items, (6b), two claims must be made. First, I assume that the unmarked case crosslinguistically is for lexical items to be limited to assigning only one role. However, a language may be marked in allowing its verbs to assign more than one semantic role without being "marked" within the language. I am using "marked" and "unmarked" here in the sense of markedness theory, i.e., as rough synonyms to "usual" and "unusual," not in the morphological sense. If a language limits unmarked verbs to n semantic roles, it may include "marked" verbs which assign more than n roles, this markedness information being encoded within the lexical entries of these verbs.

A constituent assigned a semantic role by an item in (6b, c, or d) will be called the "logical object" of the item. The predicate assigns a semantic role to its "subject." To distinguish the subject of a predicate from the grammatical subject of a sentence, we call the former the "logical subject." The constituents which serve as input to the function a verb names will be called "arguments" of the verb.

A verb names a function from arguments bearing semantic roles to a predicate. It may also assign a semantic role to one of its arguments. Similarly, what I have called a "predicate" is a function from arguments bearing a semantic role to propositions. Unlike verbs, predicates take at most one argument and must assign the semantic role which that argument bears. However, there are really only two basic semantic relations here: "argument-taking item - argument" and "semantic role assigner - semantic role assignee." We call the argument of a predicate its "logical subject." An intransitive verb like dance may name a function from no arguments to a predicate, (x dance). Similarly, a predicate may be a function from no arguments to a proposition, for example, the "predicate" (rain) in It rains.

To repeat, constituents are assigned their semantic roles in the present theory; they do not receive roles by virtue of occupying slots in predicates. Another important difference between P-A structures and the sort of predicate notation employed by Jackendoff and others is that the former but not the latter imply an asymmetry among the inherent semantic roles of a verb. In the Jackendoff (1976) framework and in many current theories, all semantic dependents of a verb simply fill slots in n-ary predicates such as GO (x,y,z). The asymmetric P-A structures incorporated into the present theory assure that the choice of arguments to fill P-A slots will affect the predicate the P-A function produces and thus the semantic role of the logical subject of the predicate, while choice of subject for the predicate cannot affect the semantic roles assigned to the input arguments. Thus the verb give in (7), repeated here as (10a), will yield the predicate displayed in (10b), while give in (10c) will yield the predicate shown in (10d).

- (10) a. Elmer gave the porcupine to Hortense.
 b. 'give' (the porcupine, Hortense) = (x give the porcupine to Hortense)
 c. Elmer gave two aardvarks to Horace.
 d. 'give' (two aardvarks, Horace) = (x give two aardvarks to Horace)

Since the different choice of arguments as theme and goal in (10a) and (10c) produce different predicates, Elmer, the logical subject of both sentences, will bear a distinct role in each, the "giver of the porcupine to Hortense" role in (10a) and the "giver of two aardvarks to Horace" role in (10c). However, regardless of what NP is chosen as subject of give the porcupine to Hortense, the porcupine will be assigned the same theme role by give, Hortense the same goal role by to. In section 2.1.3.1. below I will provide evidence for this asymmetric treatment of a verb's semantic dependents; for the moment, it is only necessary that the reader understand what the asymmetry entails.

Although verbs are the canonical predicate producers in English, adjectives, nouns, and prepositions may also have predicate-argument structures, taking in arguments to yield predicates, which, given a logical subject, make propositions. In the sentences in (11) we see an adjective (11a), a noun (11b), and a preposition (11c) operating as predicate producers.

- (11) a. I consider Elmer [_{AP}overly afraid of aardvarks].
 b. I consider Elmer [_{NP}a slick operator].
 c. I consider Elmer [_{PP}in debt beyond help].
 d. I consider Elmer [_{VP}to lead a strange life].

Leaving aside the question of the proper surface constituent structure for sentences like those in (11), we may conclude that the labeled phrases in these sentences form predicates taking Elmer as their logical subjects and head propositions at l-s structure which serve as the logical object of consider. Afraid in (11a), for example, though an adjective, has a pre-

dicade-argument structure much like that of the related verb fear.

- (12) a. 'afraid' (feared)
 b. 'fear' (feared)

In addition to P-A structures, nouns may have what might be called "nominal-argument structures." Some nouns, particularly nominalizations of verbs, take in arguments and produce "substantives," i.e., constituents which may bear semantic roles. For example, destruction, from the verb destroy, takes in an argument bearing the destroyed role, which it itself assigns, and yields a nominal, "destruction of NP," designating some event of destruction.

- (13) a. nominal-argument structure: 'destruction' (destroyed)
 b. P-A structure: 'destroy' (destroyed)

Since the nominal-argument structure yields a nominal, not a predicate, there is no logical subject associated with the nominal, destruction of NP. How the genitive NP in (14a) and the NP in the prepositional phrase headed by by in (14b) receive their semantic roles is a topic to which we shall return in the discussion of passivization in Chapter Three (see section 3.1.1.).

- (14) a. Elmer's destruction of the porcupine cage.
 b. The destruction of the porcupine cage by Elmer.

Adjectives have "modifier-argument" structures as well as P-A structures; that is, they name functions from arguments to modifiers. The modifier-argument structure of afraid is shown in (15).

- (15) 'afraid' (feared)

The relationship between a modifier and the constituent it modifies is the last logico-semantic relation to be introduced in this dissertation. The paradigmatic instantiations of the modifier-modifiee relation are the relation between an adjective and a noun or noun phrase and that between an

adverb and verb or verb phrase. In (16) I give examples of the modifier-modifiee relation, underlining the modifiers and bracketing them with their modifiees.

- (16) a. [the porcupine on the table] is for sale.
 b. [The porcupine red in the face from exhaustion] just jogged a mile.
 c. Elmer [sold porcupines all day in the pet store].

Modifiers are functions from constituents of type X to constituents of type X. For example, nominal modifiers like adjectives take in a nominal and yield a nominal. The modifier-modifiee relation involves no new basic semantic relation; 'modifiee' is simply what we call the argument of a modifier.

The logico-semantic structure of a sentence is basically a representation of semantic role assignment and semantic dependencies among constituents. It might be represented as a list of l-s constituents and the l-s relations which connect them. However, since constituents at l-s structure are built of other l-s constituents, a constituent structure representation of l-s structure seems warranted. I will introduce a pictorial constituent structure representation for l-s structure here. Since aspects of the pictorial representation will have no interpretation in the theory, the reader is asked to pay careful attention to the explanation of the relationship between the representation of l-s structure and l-s structure itself. For example, writing constituents on a page requires putting them in some order, but the order of constituents in our constituent structure representation of l-s structure will have no significance.

An argument-taking item and its arguments⁵ form a constituent at l-s structure, either a predicate, a nominal, or a modifier depending on whether the item has a P-A structure, a nominal-argument structure, or a

modifier-argument structure. In the pages to follow, an argument-taking item which yields a predicate will be given the l-s category label "V" and one which yields a nominal will be given the label "N". An item which produces modifiers of nominals will be called an "A," one which produces modifiers of predicates a "P." The constituent structure representation of a constituent consisting of an argument-taking item and its arguments is shown in (17). In this and all other l-s structure trees, the order of constituents may be arbitrarily chosen.

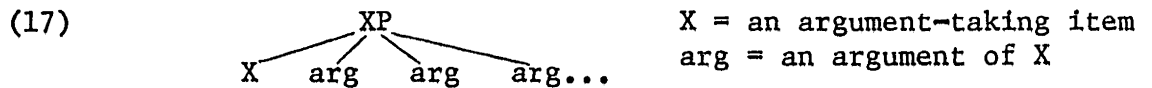

By the definition given above, an argument is something which is inserted into the slots of a function represented in a predicate/nominal/modifier-argument structure -- it is a constituent bearing a semantic role. So in a sentence like (18), neither to Hortense nor Hortense alone is technically an argument. Rather, the argument inserted in the goal slot of the 'give' function is Hortense bearing the goal role.

(18) Elmer gave a porcupine to Hortense.

For present purposes, let us say that the combination of a semantic role assigner lacking an argument structure and its logical object form a constituent called an "argument phrase." I will use "P" as the label for a semantic role assigner without an argument structure.

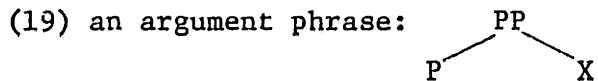

P = a semantic role assigner without an argument structure
X = the logical object of P

We will say that it is the combination of semantic role assigner and logical object -- the argument phrase -- which bears the argument relation with respect to an argument-taking item. When an argument-taking item also

assigns a semantic role to one of its arguments, we say that its logical object alone is an argument of the argument-taking item. The reader is asked to keep in mind that an argument is technically a constituent bearing a semantic role and that these terminological decisions are made for notational and formal convenience.

A predicate, XP, and its logical subject form a proposition, which we may call an "S" or 1-s structure.

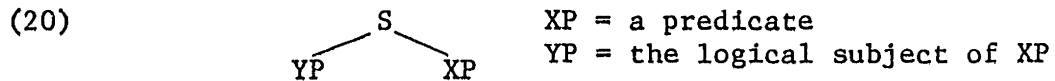

For each of the relations, argument-taking item - argument, semantic role assigner - logical object, and predicate-subject, it is the "operator" or left hand member of the relation which determines the category of the constituent immediately dominating both members of the relation. In contrast, the constituent consisting of a modifier and its modifiee is of the same logico-semantic category as the modifiee.

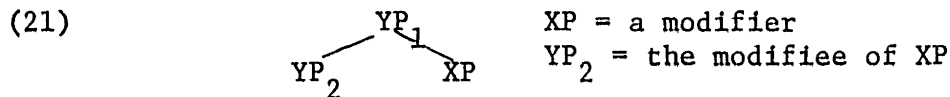

To illustrate the constituent structure notation of 1-s structure, a partial 1-s structure of sentence (22) is given in (23).

(22) Elmer gave a porcupine weak from exhaustion to his favorite charity.

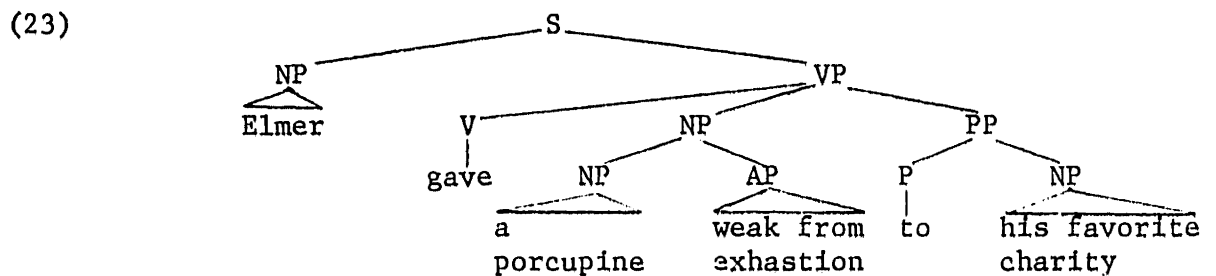

In (23) the verb, give, and its arguments, a porcupine weak from exhaustion and to his favorite charity, form a predicate. The preposition, to, as-

signs the goal role to its sister, his favorite charity, just as gave assigns the theme role to its sister, a porcupine.... As a semantic role assigner without argument structure, to heads an argument phrase, the PP, consisting of itself and its logical object. The argument phrase serves as argument to give in (23). The modifier, weak from exhaustion, modifies its sister, the nominal a porcupine, to produce a new nominal. The function give names takes in gave's sisters and yields a predicate, the VP, which, with its logical subject, Elmer, forms a proposition.

In (24), I list the l-s relations introduced in this section along with a notation for referring to the relations. If Y stands in l-s relation r with respect to X, where X is the "operator" as described above, we write $r(X, Y)$.

(24)	<u>X -- operator</u>	<u>Y</u>	<u>notation</u>
a.	semantic role assigner	- logical object	$obj(X, Y)$
b.	argument-taking item	- argument	$arg(X, Y)$
c.	predicate	- subject	$sub(X, Y)$
d.	modifier	- modifiee	$mod(X, Y)$

An operator and its l-s dependents form a constituent in l-s structure. For the $obj(X, Y)$, $arg(X, Y)$ relations, and $sub(X, Y)$ the operator, X, is called the "head" of the phrase of which it is an immediate constituent because it determines the category type of this phrase. Since the modifiee determines the category of the phrase consisting of modifier and modifiee, the modifiee is the head of this phrase.

The constituent types at l-s structure are listed in (25).

- (25) I. Lexical Items
- A. argument-taking items
 1. with predicate-argument structures
 2. with nominal-argument structures
 3. with modifier-argument structures
 - B. semantic role assigners

II. Phrases

<u>phrase type</u>	<u>internal structure</u>
A. predicates	element from I.A.1. and its arguments <u>or</u> a predicate and a modifier
B. nominals	element from I.A.2. and its arguments <u>or</u> a nominal and a modifier
C. modifiers	element from I.A.3. and its arguments <u>or</u> a modifier and a modifier
D. propositions	a phrase from II.A. and its subject <u>or</u> a proposition and a modifier
E. argument phrases	element from I.B. which does not also belong to I.A. and its object <u>or</u> an argument phrase and a modifier

As mentioned above, a lexical item may both take arguments and assign a semantic role, i.e., fall under both I.A. and I.B.. Only nominals (II.B.) and propositions (II.D.) may receive semantic roles, and only a constituent bearing a semantic role may be an argument (in the narrow sense; see fn. 5). We decided above that, with respect to an argument-taking item X, an argument phrase (II.E.) and a logical object of X would count as constituents bearing semantic roles and thus would qualify to serve as arguments of X.

The lists of l-s relations and constituents presented in (24) and (25) are probably not complete; missing, for example, are the mechanisms needed to account for conjunction. However, I have introduced all the l-s machinery I claim is required to account for the core syntax of a language including the variety of constructions to be discussed at the end of this chapter and in Chapter Three.

2.1.2. Constraints on l-s structure. A few general principles should be sufficient to constrain the formation of l-s structures. Consider l-s structure as a list of pairs of constituents, the first member of each pair standing in some l-s relation with respect to the second. We wish to insure that these pairs describe a single, well-formed constituent structure tree headed by an S or "proposition" node. Formally there are a number

of ways to accomplish this goal. For example, we could write phrase structure rules corresponding to the structures in (17, 19-21) and have these phrase structure rules generate l-s structures beginning with an S node. Or we could build l-s structures Montague-style from the bottom up, taking the trees in (17, 19-21) as rules of construction. The exact means we employ to guarantee that the l-s constituents of a sentence fit together as a single proposition are not important here. What is important is the general principle, which is restated informally in (26).

- (26) A well-formed l-s structure must be representable as a single constituent structure tree headed by an S node and conforming to the constituent structure specifications implicit in (25) above.

Principle (26) has the desirable consequence that any constituent appearing in l-s structure will be either the operator or operand of an l-s relation. To appear in l-s structure is to stand in an l-s relation with respect to another constituent. Principle (26) obviates the need for the part of Chomsky's (1981) theta-criteria (discussed in Borer 1980) which states, in our terms, that every nominal or embedded proposition must receive a semantic role. If a nominal or embedded proposition appears in l-s structure, it will have to be a subject, an object, an argument, or a modifiee. If it is a subject, an object, or an argument, the nominal or proposition receives a semantic role by the definition of these relations. As a modifiee, the nominal or proposition will head another nominal or proposition which, to appear in l-s structure, must be assigned a semantic role (be a subject, object, or argument) or be a modifiee.

In addition to principle (26), some principle or condition must insure that an argument-taking item receive the arguments it requires at l-s structure and that semantic role assigners, which could enter l-s structure

as the argument taker in an $\text{arg}(X, Y)$ relation, assign their semantic role(s). How many and what sort of arguments an argument-taking item takes and how many and which semantic roles a semantic role assigner assigns are specified in the lexical entries of these constituents. Clearly, lexical requirements relating to arguments and semantic roles must be met at l-s structure. However, it is not a peculiarity of l-s structure that lexically specified requirements must be met. Some principle like (27) is assumed implicitly or explicitly in most grammatical theories.

(27) Lexical requirements are met at all levels or structure.

Principle (27) does not imply that all the requirements of a lexical item be met at every level of structure, rather that the requirements relevant to each level of structure be met at that level. So if a constituent is specified to assign semantic role R, it must assign R at l-s structure, at which semantic role assignment takes place, but not at s structure, where semantic role assignment is not a relevant concept.

In practice, principle (27) might follow from principle (26) at l-s structure. For example, if an argument taking item were not provided with all its required arguments, the function it names could not produce a predicate and presumably the l-s structure in which the item appeared would be ill formed for this reason. To derive (27) from (26) for the special case of l-s structure, however, one would have to deal with the problem of optional arguments and related issues.

It may be necessary to stipulate some additional constraints on l-s structure corresponding to Chomsky's (1981) "theta-criteria." A restatement of the theta-criteria in the terminology of this dissertation is provided in (28).

- (28) a. If X assigns a semantic role, it may assign it only once at l-s structure.
 b. Each nominal or embedded proposition is assigned one and only one semantic role.

Parts of (28) follow from independent principles. For example, we saw earlier in this section that each nominal or embedded proposition which appears in l-s structure must, by virtue of principle (26), be assigned a semantic role (or be a modifiee). In the most obvious cases, principle (26) also prevents a semantic role assigner X from assigning the same role twice (cf. 28b). Suppose X has the P-A structure shown in (29) and assigns SR_i twice.

(29) 'X' (\underline{SR}_i)

Since the P-A structure in (29) is a function from a single argument bearing SR_i to a predicate, only one of the constituents assigned SR_i by X may serve as the argument of X. But, according to our conventions for the construction of l-s structure, a constituent assigned a semantic role which is not also an argument of an argument-taking item (either an argument of the constituent which assigns it its semantic role or the object in an argument phrase which serves as an argument of an argument-taking item) will not appear in l-s structure. To be integrated into the semantics of a sentence, a constituent assigned a semantic role must be an argument of some other constituent. So the second constituent to which X assigns SR_i could not appear in a well-formed l-s structure. It is not clear, however, that the theory correctly rules out all cases in which a semantic role assigner assigns the same role twice in l-s structure.

The theory does not as yet prohibit more than one semantic role from being assigned to a single constituent. Consider l-s structure (30) in which the co-indexed Elmer's are the same l-s nominal. Elmer is assigned

two semantic roles in (30), the "liker" role and the "likee" role.

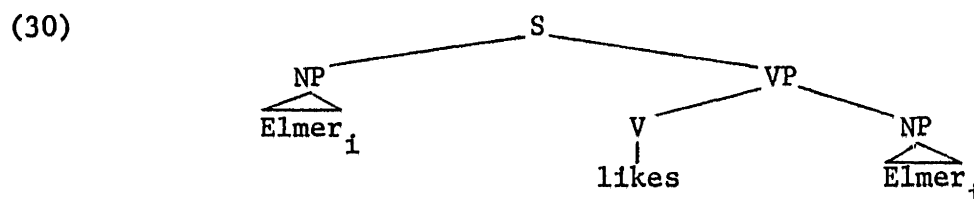

The principles which govern the connection between l-s and s structure (see section 2.4 below) would allow (30) to correspond to the s structure in (31).

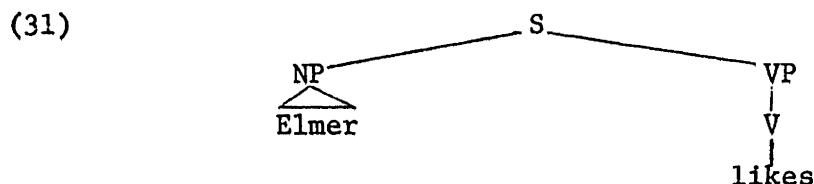

Some condition is required to prevent the grammar from analyzing Elmer likes as a grammatical sentence meaning, "Elmer likes himself." One condition which would have the correct effect is the piece of the theta-criteria in (32).

(32) A nominal or proposition may bear only one role in l-s structure. Other conceivable principles would yield the proper results in the obvious cases but make different predictions in other constructions. Since they do not involve the major results of this dissertation, I will not explore the possibilities here.⁶ Rather, I will just assume (32) for the remainder of the work.

In addition to specifications of the logico-semantic relations and their properties, only general principles like (26) and (32) are needed to constrain the construction of l-s structure in grammars. The argument structures of lexical items chosen for an l-s structure will specify the number of arguments they require, which semantic roles the arguments must bear, and what sort of constituent they, taken with their arguments, yield. The properties of constituents such as predicates, argument phrases,

and modifiers, derive from properties of their lexical heads. In an important sense, then, logico-semantic structure is a projection of lexical properties.

2.1.3. Evidence for the present conception of logico-semantic structure. It is not the purpose of this dissertation to propose a semantics for natural languages, nor will later chapters be heavily concerned with semantic issues. The partial analysis of compositional semantics presented above is important only in its relevance to the study of grammatical relations. Only two aspects of the analysis are crucial for what follows, and these will be given some support in this section. The first is the proposed asymmetry between the semantic roles of the arguments which serve as input to the function that an argument-taking word names and the semantic role assigned by the predicate which this function produces. The second crucial aspect of the semantic analysis is the presumed assignment of semantic roles to arguments of an argument-taking word independent of the function from arguments to predicates this word names. Recall that the arguments which fill slots in a P-A structure are assumed to bear semantic roles assigned to them by one of the items listed in (6); they do not receive their semantic roles by virtue of occupying those slots.

2.1.3.1. The asymmetry between the logical subject and a verb's arguments. 2.1.3.1.1. Range of predicates. A verb names a function from arguments bearing specified semantic roles to a predicate. It does not combine semantic roles in some fashion to derive a predicate; rather, it dictates how to assemble a predicate from arguments bearing the named roles. Since the predicate that a verb produces is a function of the verb's arguments, which arguments one provides the verbs affects the predicate it produces and, consequently, the semantic role born by the logical

subject of the predicate. On the other hand, the choice of logical subject for a predicate can in no way affect the semantic roles assigned to the arguments which serve as input to the function which yields the predicate. The clear prediction of the proposed distinction between the logical subject and the verb's arguments is this asymmetry between the effects of changing the arguments of a verb and the effects of changing the logical subject of a predicate.

Although the predictions of this asymmetric treatment of a verb's semantic dependents are clear, they are not easy to test. Compare sentences (10a,c) repeated here as (33), with sentences (34).

- (33) a. Elmer gave the porcupine to Hortense.
 b. Elmer gave two aardvarks to Horace.

- (34) a. Elmer sold two porcupines to Hortense.
 b. Horace sold two porcupines to Hortense.

Recall that I claimed without argument that Elmer bears the "giver of the porcupine to Hortense" role in (33a) but the "giver of two aardvarks to Horace" role in (33b), two clearly distinct roles assigned to Elmer by the distinct predicates which the give function produces when handed distinct sets of arguments (see 10b,d). However, we could with equal justification claim that two porcupines bears the "sold by Elmer" role in (34a) but the "sold by Horace" role in (34b) instead of bearing simply the sold or theme role in both sentences. Clearly, being sold by Elmer differs from being sold by Horace. What is not clear is whether this difference demonstrates that two porcupines is assigned different roles in (34a,b).

If we restricted our attention to examples like (33) and (34), we could not argue for the proposed asymmetry among verb dependents. In such examples, changing the logical subject seems to have as much effect on the semantic role born by the verb's logical object as changing the logical

object has on the semantic role born by the verb's logical subject, i.e., very little effect. By expanding our data base, however, we do find convincing evidence in English for the hypothesized asymmetry. Just about every simple transitive English verb expresses a wide range of predicates depending on the choice of direct objects.

- (35) a. throw a baseball
 b. throw support behind a candidate
 c. throw a boxing match (i.e., take a dive)
 d. throw a party
 e. throw a fit
 f. take a book from the shelf
 g. take a bus to New York
 h. take a nap
 i. take an aspirin for a cold
 j. take a letter in shorthand
 k. kill a cockroach
 l. kill a conversation
 m. kill an evening watching T.V.
 n. kill a bottle (i.e., empty it)
 o. kill an audience (i.e., wow them)

We might distinguish the basic or "literal" uses of the verbs in (35) from their "metaphoric" and "idiomatic" uses, yet no clear lines divide the classes. Although the different predicates formed by adding different direct objects to most simple transitive verbs assign different semantic roles to their subjects, one would be hard-pressed to argue that a different predicate implies a different (homophonous) verb in each case. The person throwing a baseball propels it through the air with a motion of his arm; the person throwing a party may do no more than telephone a caterer and a few guests; the person throwing a fit thrashes about on the floor. Despite these differences, may we not maintain that the verb throw in at least the majority of its uses in (35) names the same function from arguments to predicates, the variety of predicates displayed in (35) being attributable to the variety of input arguments to this function? Killing a cockroach involves causing it to become not alive, killing an evening

may be accomplished by sitting motionless in front of a T.V., and killing a bottle implies causing it to become empty, yet some thread of meaning ties these uses of kill together, a thread we may weave into a single function, kill, from arguments to predicates.

It might be claimed that the semantic roles born by the direct objects in (35) also differ from use to use of the verbs. Thus a book in (35f) may be called a "theme" since it undergoes a change in position while a letter in (35j) is something created, undergoing a change in state, perhaps, but not necessarily a change in position. However, regardless of whether the direct objects in (35) do differ in semantic role from use to use of the verbs, the choice of subject for the verbs in (35) does not determine the semantic role of their object. Consider the sentence schemas in (36).

- (36) a. The policeman threw NP.
 b. The boxer threw NP.
 c. The social director threw NP.
 d. Aardvarks throw NP.
 e. Throw NP!
 f. Harry killed NP.
 g. Everyone is always killing NP.
 h. The drunk refused to kill NP.
 i. Silence can certainly kill NP.
 j. Cars kill NP.

Although the more material these sentence fragments contain, the more they suggest particular direct objects and, therefore, particular predicates, the different subjects for the verbs in (36) do not imply different semantic roles for the object NPs. By varying the subject of a transitive verb, we simply do not obtain a range of "predicates on objects" similar to the range of predicates on subjects we obtain by varying the objects of transitive verbs. This is the asymmetry which confirms our conception of verb semantics: choice of object (or other argument of a verb) affects

the semantic role of the logical subject while choice of logical subject does not affect the semantic role of the object.

2.1.3.1.2. Idioms. We create new predicates in English by modifying a verb's function from arguments to predicates. That is, we give new values to the function for certain special input arguments. As a result of the asymmetric compositional semantics of sentences, then, there are countless "object idioms" in English like kick the bucket while "subject idioms" which are not also full phrasal idioms do not to my knowledge exist. Object idioms are combinations of verb plus object with slightly or highly unusual semantics from what one would expect from the canonical uses of the verb. A subject idiom would be an idiomatic combination of subject and verb. I know of no such combinations which have a free argument position.⁷ That is, although we do find idiomatic expressions with fixed subjects, e.g., The shit hit the fan (we cannot use The garbage hit the fan with anything but the literal reading), the objects in such expressions are also fixed. One cannot say, The shit hit the air conditioner, when things really go wrong.

The evidence from the existence of numerous object idioms but the non-existence of subject idioms with free argument positions simply reinforces the conclusions of the previous section. Predicates are created by functions on objects and other arguments excluding the logical subject.⁸

2.1.3.2. Independent semantic role assignment. The second feature of the compositional semantics presented above which proves necessary for the theory of grammatical relations is the assignment of semantic roles to arguments before they enter the function from arguments to predicates which an argument-taking word names. I will derive support for this treat-

ment of semantic role assignment from an analysis of "dative movement" below. However, direct support for the independent assignment of semantic roles comes from the marking of verbs' arguments.

Consider verbs like give, put, and steal, which we may assume to have predicate-argument structures something like those shown in (37).

- (37) a. 'give' (theme, goal)
 b. 'put' (theme, location)
 c. 'steal' (theme, source)

Note that the prepositions used to mark the second arguments of the verb in (37) assign the semantic roles of these arguments to their objects when they are used as predicate or modifier producers and not to mark the arguments of verbs. Compare the sentences in (38) and (39).

- (38) a. Elmer gave two porcupines to Hortense.
 b. Elmer put the porcupine on the table.
 c. Elmer stole a porcupine from the zoo.

- (39) a. The train to Pittsburgh arrived at the station.
 b. The porcupine on the table slipped its leash.
 c. The porcupine from the zoo was tamer than the rest.

The underlined NPs in the sentences in (38) bear the same semantic roles as those born by the underlined NPs in the corresponding sentences in (39). If we assumed that arguments receive their semantic roles simply by virtue of filling argument slots in P-A structures, then it would be an accident that the items which are used to mark a verb's arguments independently assign the semantic roles that the argument they mark bear when these items are not being used to mark a verb's arguments. If the "source" argument of steal, for example, received its semantic role by occupying the second slot in P-A structure (37c), it would be an accident that from, which assigns the source role in other constructions (see, e.g., (39c)), is used to mark steal's source argument. Since steal in this case would, in effect, be assigning the source role itself, from would be unnecessary.

If all of a verb's arguments received their semantic roles from the verb, we might expect all the arguments to be marked in the same manner, or with some arbitrary marking to specify which argument goes in which slot in a P-A structure. That arguments of a verb are marked in the same manner as NPs bearing identical semantic roles which are not arguments of a verb is the strongest evidence for viewing the assignment of semantic roles to arguments as independent of P-A structures.

2.2 Semantic roles and the construction of predicate-argument structures. To this point I have been somewhat loose in my identification of the semantic roles associated with verbs. The assumption underlying the above pages was that each semantic role assigner may, in principle, assign a unique role or a unique set of roles. For example, although their logical objects are both things acted upon so that they move, throw and push need not assign precisely the same semantic role; that is, the "throwee" and "pushee" roles may be distinct. However, although semantic role assigners may assign their own roles, there are, apparently, linguistically significant classes of semantic roles. I view such terms as "agent" and "theme" as naming semantic role classes.⁹ On this view, there is no reason to exclude a given semantic role, say that role assigned by "swim down the river," from being both an agent and a theme, i.e., from belonging to more than one semantic role class.

Among the grammatical machinery which makes reference to semantic role classes we may include P-A structures. Consider a verb like put, which requires some sort of locative argument but does not specify exactly what sort. A variety of prepositions may be used to express put's locative argument, each assigning this argument a different semantic role;

however, some locative preposition must be used.

- (40) Elmer put the porcupine
- a. in the box
 - b. on the table
 - c. under the hedge
 - d. through the window
 - e. *during the movie
 - f. *after the fall
 - g. *on weekends
 - h. *quietly
 - i. *aardvarks

In the P-A structure for put, we must specify that it takes a locative argument without insisting on a particular prepositional phrase expression for the argument. Therefore, we must have access to some semantic role class term, "location," to use in P-A structures as shown in (41).

(41) 'put' (theme, location)

From the fact that classes of semantic roles have linguistic significance, one should not conclude that all semantic roles fall into one or more linguistically significant classes. It is quite possible that the semantic roles assigned by some items are not classifiable. For example, the logical object of like is neither a theme (thing moved) or patient (thing affected by the action of a verb). Perhaps the only linguistically significant thing an English speaker knows about the role assigned by like is that it is the role assigned by like.

In addition to appearing in some P-A structures, semantic role classes seem necessary to express generalizations about the organization of P-A structures within a language. In English and many other languages, it is generally true that if one of the inherent roles associated with a verb is an "agent" role, i.e., is the role of an active, animate being who intentionally causes something, then this role will be assigned to the logical subject of the predicate that the verb produces. It is also

generally true in these languages that "theme" inherent roles -- roles of objects that the verb specifies to undergo a change of state -- and "patient" inherent roles -- roles of objects that bear the brunt of the action described by the verb -- are assigned by verbs, i.e., are born by logical objects. These generalizations must be stated within the grammar of a language. A straightforward statement is given in (42).

- (42) a. agent roles - logical subject
 b. theme/patient roles - logical object

The existence of generalizations like (42) raises two important questions. First, why should languages incorporate such generalizations at all; that is, why shouldn't some verbs assign agent roles to their logical objects and have theme/patient roles assigned to their logical subjects while others conform to generalizations (42)?

In Marantz (1980a) I report the results of two experiments I conducted with 3- to 5-year-old children which suggest an answer to this question. These experiments support the hypothesis that, until about the age of five, children's knowledge of language connects semantic roles directly to their surface structure expressions. For example, English-speaking children know that agents are placed preverbally and theme/patients postverbally. The experiments show that 3- and 4-year-old children have greater difficulty learning to use verbs whose P-A structures lead the verbs to violate these generalizations about the connection of semantic roles and surface positions (in active declarative sentences) than verbs whose P-A structures lead the verbs to conform to these generalizations. Consider the made-up verb moak, meaning "to pound with the elbow," with P-A structure (43).

(43) moak 'pound with the elbow' (agent); logical subject = patient.

Sentences like (44) containing moak violate English-speaking 3- and 4-year-old's generalizations that agents come preverbally, patients post-verbally.

(44) The book is moaking Larry.

My experiments demonstrate that English-speaking 3- and 4-year-olds have more difficulty learning to use verbs like moak than made-up verbs conforming to the generalizations in (42). When 3- and 4-year-olds are shown a video-tape of Larry pounding a book with his elbow and are told, "The book is moaking Larry," they tend to make moak conform to their generalizations about the association of semantic role and surface positions. For example, they tend to say, "Cindy is moaking the ball," when shown Cindy pounding a ball with her elbow. For the child's spontaneous use of moak to be correct in the adult language, moak would have to be given the P-A structure in (45), which accords with the generalizations in (42).

(45) moak 'pound with the elbow' (patient)

The performance of the children in the experiments of Marantz (1980a) suggests that verbs violating the generalizations in a language corresponding to generalizations (42) in English would be regularized to conform to these generalizations through the acquisition process. Children's early linguistic knowledge establishes a direct connection between semantic roles and their expression in sentences. Generalizations like (42) insure that most verbs in a language will conform

to the young child's linguistic knowledge, at least in the simple active declarative sentences he most often produces.

Assuming that a grammar incorporating generalizations like (42) is somehow more highly valued than a grammar without them for the reasons outlined above, the second question one should ask about these generalizations is why English and many other languages employ the particular generalizations in (42) and not, say, the reverse generalizations given in (46).

- (46) a. agent roles - logical object
 b. theme/patient roles - logical subject

Nothing in our characterization of P-A structures would demand or even suggest that predicates but not verbs should assign agent roles while verbs but not predicates assign theme/patient roles. We have tied the l-s relations "subject" and "object" not to semantic roles themselves but rather to the assignment of semantic roles. Therefore, we might expect to find languages in which the generalizations of English (42) are reversed as in (46). The answer to the second question, then, would be that it is an accident that English employs generalizations (42) in place of (46). I will claim that languages employing (46) do exist; they are the true "ergative languages." In section 3.3. below I will examine the consequences within the present theory of choosing one or the other of the sets of generalizations (42) and (46) and demonstrate that Dyirbal and Central Arctic Eskimo are true ergative languages, i.e., choose set (46). Languages choosing (42) are the "nominative-accusative languages."

The P-A structure for a verb meaning 'hit' in a nominative-accusative language is shown in (47a); that for 'hit' in an ergative language is given in (47b).

- (47) a. 'hit' (patient) ; logical subject = agent
 b. 'hit' (agent) ; logical subject = patient

Note that the existence of ergative languages still leaves quite a lot unexplained about generalizations like (42) and (46). For example, why should themes and patients group together; do these classes of semantic roles share some semantic property? Why should these semantic role classes and not others, like "location" or "instrument," be canonically associated with logical subjects and objects, i.e., with verbs?

The incorporation of generalizations like (42) and (46) within a grammar leads one to expect the existence of two sorts of verbs with a single inherent semantic role. If the sole role of an intransitive verb in a nominative-accusative languages falls into the agent class, by (42a) we expect the verb's P-A structure to look like (48a). If, on the other hand, the sole role falls into the theme or patient class, generalization (42b) indicates that this role should be assigned by the verb, necessitating the P-A structure in (48b).

- (48) a. 'intransitive-verb-type 1' (\emptyset); logical subject = agent
 b. 'intransitive-verb-type 2' (theme/patient); no logical subject role.

The predicate returned by the P-A structure in (48a) assigns an agent role to its logical subject. The predicate returned by the P-A structure in (48b), however, assigns no semantic role; it is a degenerate predicate,

requiring no arguments to make a proposition. English swim might be a verb of type 1 in (48); English arrive a verb of type 2.

- (49) a. 'swim' (\emptyset)
 b. 'arrive' (theme)

Just as arrive produces a degenerate predicate, swim operates as a degenerate argument-taking word: it names a function from no argument to a predicate. Approximate 1-s structures for sentences (50a,b) containing swim and arrive are given in (50c,d) (the location of the adverbial modifiers is unimportant here). Note the lack of arguments in the VP of (50c) and the lack of a logical subject in (50d).

- (50) a. Elmer swam yesterday.
 b. Elmer arrived yesterday.

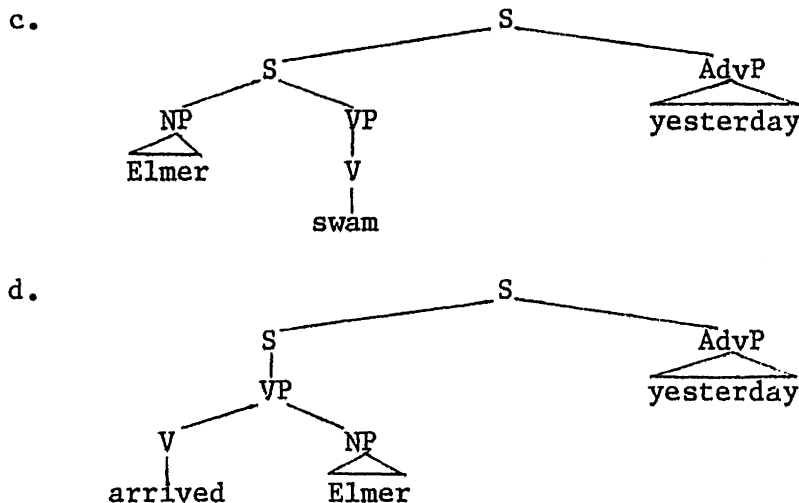

Relational Grammar should be credited with distinguishing the two classes of intransitive verbs whose P-A structures are schematized in (48).¹⁰ Relational Grammarians call type 1 intransitives "unergative" and type 2 intransitives "unaccusative," and have amassed convincing evidence for keeping the two types distinct in grammar (see, e.g., Perlmutter 1978; Perlmutter and Postal 1978a). Burzio (1981) provides considerable support from Italian for the proposed distinction between intransitive verb classes.

Below I shall demonstrate how the characterization of the distinction between unergative and unaccusative verbs implicit in (48), which is essentially the characterization of Relational Grammar and Burzio (1981), correctly predicts one contrasting property of these verbs within the present theory (see 3.1.1.3. below).

We will find it convenient to have some formal means for distinguishing verbs whose P-A structure produce predicates which assign no semantic role from verbs whose P-A structure produce role-assigning predicates. Verbs of the former sort, e.g., arrive in (49b), will be assigned the negative value of the feature, [\pm Pred SR]; those of the latter sort, e.g., swim in (49a), will be given the positive value of this feature. Technically, for a verb to be [\pm Pred SR] is for it to form an l-s phrase which takes -- is sister to -- a logical subject at l-s structure. A [$-$ Pred SR] verb heads an l-s phrase which is not sister to a logical subject.

The existence of generalizations referring to semantic role classes like agent and patient is supported by the simple fact that in English, if we identify a verb associated with an agent and a patient as defined above, chances are overwhelming that the agent argument of the verb will behave grammatically like the agent argument of hit and the patient argument will behave grammatically like the patient argument of hit. Evidence for the particular formulation of these generalizations as in (42) and (46) will be drawn from the existence and behavior of ergative languages and unaccusative verbs; see sections 3.3 and 3.1.1.3 below.

2.3. Syntactic (s) structure. In diagram (4) of chapter 1, I proposed a model of grammar in which a level of syntactic analysis, the syntactic structure (or "s structure") stands between l-s structure

and surface structure. As l-s structure encodes the logico-semantic relations between constituents of a sentence, so s structure displays the grammatical relations between constituents. To each l-s relation of l-s structure there corresponds a grammatical relation of s structure; that is, there is a type correspondence between l-s and grammatical relations. Though a constituent bearing l-s relation type R may not map onto or be associated with a constituent bearing the corresponding type of grammatical relation, R', there will be such a corresponding type within grammatical theory.

2.3.1. Syntactic roles and grammatical relations. Corresponding to the semantic roles of l-s structure are syntactic roles of s structure. Syntactic roles are assigned by the items listed in (51).

- (51) a. the s structure counterparts of predicates
 b. lexical items (verbs, prepositions, tense/agreement)
 c. some case markings
 d. certain structural positions

As with semantic roles, we distinguish the phrasal syntactic role assigners under (51a) from the other syntactic role assigners. The relation between the non-phrasal syntactic role assigners in (51b-d) and the constituents to which they assign syntactic roles we call the "grammatical object relation." If the s structure counterpart of a predicate, P, assigns a syntactic role to a constituent X, and P and X together form a sentence (the s structure counter-part of a proposition) at s structure, X is called the "syntactic" or "grammatical subject" of P. To distinguish the grammatical subject and object relations from the logical subject and object relations, I will sometimes use the abbreviations SUB and OBJ for the grammatical relations.

In sentence (52) below the porcupine is the grammatical object (OBJ)

of gave, Hortense the grammatical object of the preposition to, and Elmer the grammatical subject (SUB) of the VP, [gave the porcupine to Hortense], which is the s structure counterpart of the predicate, (x give the porcupine to Hortense).

(52) Elmer gave the porcupine to Hortense

Following the ideas of Chomsky (1980a; 1981), we will say that Elmer in (52) is also the OBJ of the tense/agreement morphology on the verb, gave. This way of talking will be seen to make sense when we examine the connection between the object relation and the expression of constituents in surface structure. Basically, a noun phrase will have to bear a grammatical relation with respect to some lexical item in order to be expressed in surface structure. It is the lexical item with respect to which the NP bears a grammatical relation which determines its surface structure expression. Since the SUB relation is born with respect to a phrase -- the s structure counterpart of a predicate -- a SUB will have to be an OBJ or argument to appear overtly in surface structure. It is clearly the tense/agreement on the verb in (52) which sanctions the presence of an overt nominative subject in the sentence. If the verb were tenseless, the subject of the sentence would have to be an object of something else to appear overtly, e.g., of the preposition, for, as in (53a), or of a higher verb, as in (53b).

- (53) a. For Elmer to give the porcupine to Hortense would cause an uproar.
 b. Horace caused Elmer to give the porcupine to Hortense.
 c. *Elmer to give the porcupine to Hortense (would cause an uproar).

A fuller account of the relationship between tense/agreement and subjects will be given in section 2.6.2.3. below.

Semantic roles are assigned to nominals and propositions. Projecting the properties of l-s structure into s structure, we may state that syntactic roles are assigned to the s structure counterparts of nominals and propositions, noun phrases and sentences. The number of syntactic roles a language allows a constituent to assign in the unmarked case is assumed to be tied to the number of semantic roles it allows a constituent to assign. Since predicates are universally monadic (see principle (9) above), the s structure counterparts of predicates will be strictly limited to one SUB each. The unmarked case for verbs crosslinguistically was hypothesized above to be one semantic role per verb. Similarly, I will propose that verbs are limited to one syntactic role -- one OBJ -- in the unmarked case. Some languages are marked in allowing an unmarked verb to assign more than one semantic role. I propose that these languages allow an unmarked verb more than one syntactic role as well. In Chapter Three, section 3.4.1.1.2, we shall examine languages which differ essentially in how many semantic and syntactic roles they allow a verb to assign in the unmarked case.

Now an (l-s) argument-taking item in l-s structure will correspond to a (syntactic) argument-taking item in s structure. An argument in l-s structure is, technically, a constituent bearing a semantic role. A grammatical argument, therefore, should be a constituent bearing a syntactic role. The s structure counterpart of a constituent with a P-A structure together with its s structure arguments form the s structure counterpart of a predicate. Just as an l-s predicate and its logical subject form a proposition, the s structure counterpart of a predicate and its SUB form a sentence, which is the s structure counterpart of a proposition. The s structure counterpart of a constituent with a nominal-argument structure together with its s structure arguments form the s structure counterpart of

a nominal, a noun phrase. The s structure counterpart of a constituent with a modifier-argument structure together with its s structure arguments form the s structure counterpart of a modifier, a grammatical modifier. A grammatical modifier serves as operator for the s structure counterpart of the l-s modifier-modifiee relation, the grammatical modifier-modifiee relation.¹¹

Just as logico-semantic structure is a representation of semantic role assignment and semantic dependencies, so syntactic structure is a representation of syntactic role assignment and grammatical dependencies. We could represent s structure as a list of s structure constituents and the grammatical relations which interconnect them. However, since s structure constituents are built of other s structure constituents, a constituent structure representation of s structure most transparently displays all the information essential to s structure -- which constituents are built from which constituents and which constituents bear what grammatical relations with respect to which constituents. I will describe here a pictorial constituent structure representation for s structure which parallels that introduced for l-s structure above. Again, the representation will contain some features without linguistic significance; for example, the order of constituents in this representation may be arbitrarily chosen -- the order has no interpretation.

An argument-taking item and its arguments form a constituent at s structure. The argument-taking item and its arguments make up the s structure counterpart of an l-s predicate, nominal, or modifier, depending on whether the l-s structure counterpart of the argument-taking item has a P-A structure, a nominal-argument structure, or a modifier-argument structure.

- (54)
- $$\begin{array}{c} \text{XP} \\ \swarrow \quad \downarrow \quad \searrow \\ \text{X} \quad \text{arg} \quad \text{arg...} \end{array}$$

X = an argument-taking item
arg = an argument of X

In general, the category node labels of s structure constituents will be those of their l-s counterparts. For example, the s structure counterpart of an l-s item with a P-A structure will be a "V."

Just as an l-s argument is a constituent bearing a semantic role, so a syntactic argument is a constituent bearing a syntactic role. For present purposes, let us say that the combination of a syntactic role assigner which is not the counterpart of an l-s argument-taking word and the constituent to which it assigns a syntactic role form a constituent at s structure called an "argument phrase."

- (55) an s structure argument phrase:

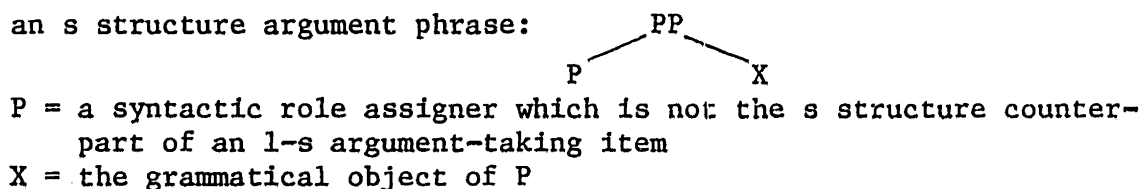

When a constituent Y bearing a syntactic role is the argument of X but not also X's grammatical object, we will say that it is the argument phrase containing Y which is the argument of X. When an s structure argument-taking item X also assigns a syntactic role to one of its arguments Y, we say that Y (X's OBJ) by itself is X's argument. So in sentence (56), a porcupine, the grammatical OBJ of gave, and to Hortense, an argument phrase consisting of the syntactic role assigner to and its OBJ, are arguments of gave at s structure.

- (56) Elmer gave a porcupine to Hortense.

The s structure counterpart of a predicate and its grammatical subject form a sentence at s structure.

- (57)
- $$\begin{array}{c} \text{S} \\ \swarrow \quad \searrow \\ \text{YP} \quad \text{XP} \end{array}$$

XP = the s structure counterpart of a predicate
YP = the SUB of XP

The s structure counterpart of a modifier and its syntactic modifiee also form an s structure constituent.



Note that the "operator" or left-hand member of the grammatical relations, argument-taking item - argument, syntactic role assigner - OBJ, and s structure counterpart of a predicate - SUB relations determines the category of the node immediately dominating both members of the relations. The operator is thus the head of the dominating node for these relations. In contrast, the node immediately dominating a modifier and a modifiee is of the same s structure category as the modifiee, making the modifiee the head of this node.

To illustrate the constituent structure notation of s structure, a partial s structure for sentence (59a) is given in (59b).

(59) a. Elmer gave a porcupine weak from exhaustion to his favorite charity.

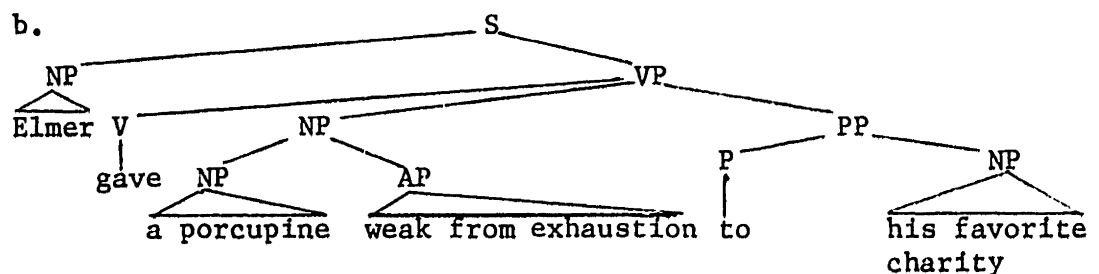

In (59b) the verb give and its syntactic arguments, its OBJ a porcupine weak from exhaustion and the argument phrase to his favorite charity, form the s structure counterpart of a predicate -- a VP. The verb assigns a syntactic role to its OBJ, a porcupine..., while the preposition to assigns a syntactic role to its sister, his favorite charity. The syntactic modifier, weak from exhaustion, combines with its modifiee, the NP a por-

cupine, to produce a new NP, a porcupine weak.... The VP in (59b) and its SUB, Elmer, make up a sentence.

In (60), there is a list of the grammatical relations described in this section along with a notation for referring to the relations. Note that we use capital letters in naming the s structure relations to distinguish them from the corresponding l-s relations.

(60)	<u>X - the operator</u>	<u>Y</u>	<u>notation</u>
a.	syntactic role assigner	- OBJ	OBJ(X, Y)
b.	argument-taking item	- argument	ARG(X, Y)
c.	s structure counterpart of a predicate	- SUB	SUB(X, Y)
d.	modifier	- modifiee	MOD(X, Y)

The X item in each relation is the "operator." The operators of relations (60a-c) head the phrase nodes which immediately dominate them in s structure, while the operand of relation (60d) — the modifiee — serves as head of its immediately dominating node.

In (61) I summarize the types of s structure constituents discussed in this section. Note that there is a one-to-one correspondence between the types of s structure constituents listed in (61) and the types of l-s constituents listed in (25) above.

(61) I. Lexical items

A. argument-taking items

1. s structure counterparts of items with predicate-argument structures.
2. s structure counterparts of items with nominal-argument structures
3. s structure counterparts of items with modifier-argument structures

B. syntactic role assigners.

II. Phrases

<u>phrase type</u>	<u>internal structure</u>
A. counterparts of predicates	an element from I.A.1. and its arguments <u>or</u> an element from II.A. and a modifier
B. noun phrases	an element from I.A.2. and its arguments <u>or</u> an element from II.B. and a modifier
C. modifiers	an element from I.A.3. and its arguments <u>or</u> an element from II.C. and a modifier

- D. sentences a phrase from II.A. and its SUB
 or an element from II.D. and a modifier
- E. argument phrases an element from I.B. which does not also
 belong to I.A. and its OBJ
 or an element from II.E. and a modifier

The following characteristics of the s structure constituents in (61) are projections of characteristics of the corresponding l-s constituents: A given lexical item may belong to both class I.A. and class I.B., i.e., may both assign a syntactic role and take arguments. Only noun phrases (II.B.) and sentences (II.D.) may receive syntactic roles, i.e., be grammatical subjects or objects, and only a constituent bearing a syntactic role may be an argument. It was stipulated that, with respect to an argument-taking item X, an argument phrase (II.E.) and a grammatical object of X would count as constituents bearing syntactic roles and would thereby qualify to serve as arguments of X.

2.3.2. Constraints on s structure. Aside from the properties of s structure constituents just discussed and the principle governing the connection between l-s and s structure to be discussed below, two principles constrain the construction of s structure. The first principle parallels the principle for l-s structure stated in (26) above.

- (62) A well-formed l-s structure must be representable as a single constituent structure tree headed by an S node and conforming to the constituent structure specifications implicit in (61) above.

It is possible that (62) need not be stated as an independent principle. In most cases simply obeying the principles governing the mapping from l-s to s structure guarantees a well-formed s structure. Whether this is true in all cases is a matter for investigation.

In addition to principle (62), principle (27) above, repeated here, must govern the construction of s structures.

(27) Lexical requirements are met at all levels of structure.

Principle (27) has a number of implications for s structure. For example, just as a lexical item may indicate whether or not it assigns a semantic role, so it may indicate whether or not it assigns a syntactic role, i.e., takes an OBJ. An item taking an OBJ will be given the positive value of the feature [\pm transitive]. Obviously, principle (27) prevents a constituent from bearing the OBJ relation with respect to a [-transitive] item at s structure. In Chapter Three we will examine a couple of constructions which require analyzing a verb as demanding that one of its l-s arguments correspond to its OBJ at s structure. Principle (27) would rule out an s structure containing such a verb in which this demand were not met.

The grammatical transitivity of a verb is highly predictable. Recall that a verb which produces predicates which may not be sisters to logical subjects at l-s structure is given the feature [-Pred SR]. A verb which is either logically intransitive, i.e., assigns no semantic role, or [-Pred SR] or both is almost invariably [-transitive]. Similarly, a verb which is [+Pred SR] and assigns a semantic role will usually be [+transitive]. The implication in (63) may be a universal; I will consider this possibility briefly in the section on passivization in Chapter Three. (However, we will be led to postulate entries which violate (63) in sections 3.1.1.3. and 3.3.2 below.)

(63) [-Pred SR] \rightarrow [-transitive]

Implication (63) is to be understood to mean that if a lexical item has [-Pred SR] in its lexical entry, the entry will also contain the feature [-transitive]. If (63) is a universal, it is not to my knowledge derivable from independent principles.

2.4. The mapping between l-s and s structure. 2.4.1. Mapping principles. Lexical items anchor the connection between the l-s structure and s structure for a given sentence. Any lexical item appearing in the l-s structure of a sentence will appear in the s-structure, and the surface structure as well.¹² However, two l-s constituents may form a single constituent at s structure. For example, in certain causative constructions with derived causative verbs to be discussed in Chapter Three, two lexical items, the causative affix and a root verb, are separate argument-taking items at l-s structure but merge into a single s structure verb. Keeping in mind that certain lexical mergers may change the number of category nodes between l-s and s structure, we may state that the relationship between lexical items in the l-s structure and s structure of a given sentence is identity.

In l-s structure constituents bear l-s relations with respect to lexical items or with respect to phrases headed by lexical items. Given that we can identify the s structure constituents corresponding to l-s constituents through the identity of lexical items in both structures, we want to know for each l-s constituent, X, bearing l-s relation, R, what grammatical relation the corresponding s structure constituent, X', will bear. Informally put, the basic principle constraining the mapping between l-s and grammatical relations runs as follows: If constituent X bears an l-s relation with respect to constituent Y, the constituent corresponding to X in s structure, X', will bear a grammatical relation with respect to the constituent corresponding to Y in s structure, Y', or with respect to a phrase which Y' heads.

A convenient and precise statement of the principle governing the

mapping between l-s and s structure requires some easily definable notions. First it will be useful to have some shorter way to say, "X bears a logico-semantic/grammatical relation with respect to Y, Y an operator."

(64) Definition: Y governs X iff X bears a logico-semantic relation with respect to Y, Y an operator (i.e., iff $r(Y, X)$ for some r a logico-semantic relation)

Y Governs X iff X bears a grammatical relation with respect to Y, Y an operator (i.e., iff $R(Y, X)$ for some R a grammatical relation)

Recall that the "head" of a phrase is the constituent which determines the category type of the phrase. The head relation is transitive: If X is the head of Y and Y is the head of Z, then X is also the head of Z. Thus an X which heads a predicate, XP, or its s structure counterpart, XP', will also head the proposition or sentence headed by XP or XP'. An extended notion of government/Government plays a crucial role in the mapping principle.

(65) Definition: X head-governs/head-Governs Y iff X governs/Governs Y or a phrase which X heads governs/Governs Y

The principle which constrains the connection between l-s and s structure may now be precisely stated as in (66).

(66) Principle: If X governs Y at l-s structure then the s structure counterpart of X head-Governs the s structure counterpart of Y

The correct application of principle (66) depends on the ability of the grammar to identify the s structure counterparts of l-s constituents. I stated above that the s structure counterpart of a lexical item in l-s structure will be the lexical item itself, except in the case of merger of lexical items. Some additional principle is required to determine the s structure counterparts of l-s phrases. We may define the s structure counterpart of an l-s phrase recursively as in (67).

- (67) Definition: The s structure counterpart of an l-s phrase X with immediate head Y is the s structure constituent whose immediate head is the s structure counterpart of Y.

As we shall see when we examine the merger of l-s items in s structure, definition (67) is incomplete; however, I will postpone any discussion of merger until Chapter Three (see section 3.4). As an example of the operation of definition (67), consider the l-s structure (68a) and its s structure counterpart, (68b).

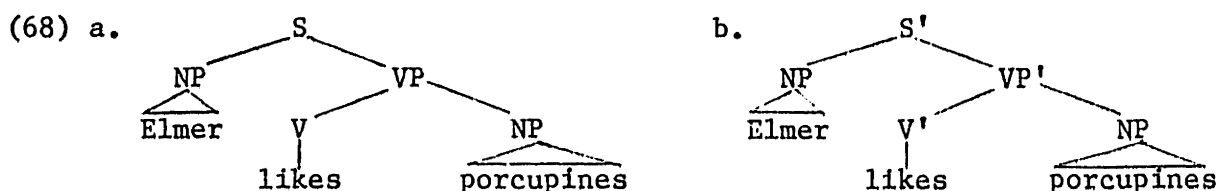

The lexical item likes in (68a) serves as its own s structure counterpart in accordance with the principle that the identity of lexical items in l-s and s structure anchors the connection between the two levels of structure. By definition (67), the s structure counterpart of the VP in (68a) is the phrase headed by the s structure counterpart of its immediate head, the verb likes. Since the s structure counterpart of likes -- V in (68a) -- is likes -- V' in (68b) -- the s structure counterpart of VP is VP', which is headed by V'. The immediate head of S in (68a) is VP and, as we have just seen, the s structure counterpart of VP is VP'. Therefore, by definition (67), the s structure counterpart of S is S', which is headed by VP'.

Principle (66) and idiosyncratic information about lexical items, such as whether or not they are transitive, determine the mapping between l-s and grammatical relations. We need not postulate rules of the form, "associate the logical object with the grammatical object" or "promotion rules" of the form, "associate the logical object with the grammatical

subject" (e.g., for passive sentences). Some principle is needed to govern the connection of l-s and s structures; for example, any theory would have to prevent the logical object of a verb from freely corresponding to the grammatical object of a verb several clauses up in l-s structure. There is no reason to believe the principle in question does not take some general form, like that in (66), which obviates the need for more specific rules. The relative attractiveness of principle (66) over rules which connect specific l-s relations with specific grammatical relations lies in the restrictiveness of the general principle approach. If we allowed into grammar a rule explicitly connecting a logical object of a verb with its grammatical object, we would have to explain why no rule exists to associate the logical subject of a verb with its grammatical object. When we examine the phenomena accounted for by the relation-changing rules of Relational Grammar, we shall see that many rules conceivable in a framework which incorporates rules like "associate the logical object with the grammatical object" simply are not instantiated. Rather, principle (66) proves necessary and sufficient to account for the relation-changing phenomena -- and does not lead us to expect rules that do not occur crosslinguistically.

2.4.2 Correspondences between l-s and s structure relations. I have asserted that principle (66) and the constraints on s structure discussed in section 2.3.2. above are sufficient to determine what s structure relation a constituent will bear given that its l-s counterpart bears a certain l-s relation. Since principle (66) is stated in a very general form, one might imagine that it leaves open a number of possibilities for the s structure counterpart of each l-s relation. In fact, various constraints interact to severely limit the possible correspondences between

l-s and s structure relations. In this section I will examine the possible s structure counterparts of each l-s relation under the assumption that no l-s constituents merge at s structure. Cases of merger will be handled in Chapter Three (see section 3.4).

I summarize the conclusions of this section in (69). The rest of the section consists mainly of proofs that the correspondences between l-s and s structure relations listed in (69) exhaust the possibilities allowed by the theory. The reader may skip these proofs without seriously impairing his/her understanding of the remainder of the dissertation. Subsections 2.4.2.4.1. and 2.4.2.4.3. should be read with some care, however.

(69)	<u>if</u>	<u>and</u>	<u>then</u>	<u>under these conditions</u>
I	mod(X,Y)	---	MOD(X',Y')	
II	sub(X,Y)	---	SUB(X',Y')	
III	obj(X,Y)	\sim arg(X,Y)	OBJ(X',Y')	
IV	arg(X,Y)	\sim obj(X,Y)	ARG(X',Y')	
V	obj(X,Y)	arg(X,Y)	$\left\{ \begin{array}{l} \text{a. SUB(Z,Y') where} \\ \text{X' heads Z} \\ \text{b. OBJ(X',Y') and} \\ \text{ARG(X',Y')} \\ \text{c. ARG(X',Z) and} \\ \text{OBJ(W,Y'), where} \\ \text{Z is an argument} \\ \text{phrase consist-} \\ \text{ing of W and Y'} \end{array} \right.$	X is [-Pred SR] X' is [+transitive] see text section 2.4.2.4.3.

X', Y' = s structure counterparts of X and Y; \sim = not

As an example of how to read table (69), consider row II. This row states that if Y bears the logical subject relation with respect to X, then the s structure counterpart of Y must bear the grammatical subject relation with respect to the s structure counterpart of X. Where a single l-s relation may correspond to one of a set of grammatical relations, I list in (69) the conditions under which each correspondence is possible. For

example, when $\text{arg}(X,Y)$, in order for $\text{obj}(X,Y)$ to correspond to $\text{OBJ}(X',Y')$, X' must be [+transitive] -- see row Vb.

2.4.2.1. The s structure counterpart of the modifier-modifiee relation. Consider a constituent X which stands in the modifier-modifiee relation with respect to modifier Y at l-s structure, i.e., $\text{mod}(Y,X)$. To satisfy principle (66), the s structure counterpart of the modifier Y , Y' , must head-Govern the s structure counterpart of X , X' . Y' will be an s structure modifier, capable of participating in a grammatical modifier-modifiee relation. As a modifier, Y' will only head a phrase if it is the modifiee in a modifier-modifiee relation. Consider the case in which the modifier Y' is not a modifiee at s structure. Since Y' does not head a phrase, X' must be Governed by Y' in order to be head-Governed by Y' . But Y' will only Govern a modifiee. So X' must be the modifiee of Y' ; i.e., the $\text{mod}(Y, X)$ relation must correspond to the $\text{MOD}(Y', X')$ relation at s structure.

Consider now the case in which Y' is a modifiee at s structure. More generally, consider a situation in which the s structure counterpart of a constituent Y , Y' , is a modifiee in a modifier-modifiee grammatical relation as illustrated in (70), in which M' is the modifier.

(70)

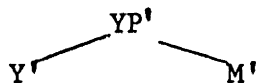

I will make the simplifying assumption that there are no "degenerate modifiers" at l-s structure, i.e., that modifiers must take arguments. (Since a modifier is a function from constituents of type C to constituents of type C, a degenerate modifier would be a function from no arguments to a constituent of type C. But such a modifier might just as well be treated

as the constituent of type C which it produces when given no argument.) Under the assumption that the l-s structure counterpart of M' in (70), M, must take an l-s modifiee, we may conclude that Y is the modifiee of M at l-s structure from the following line of reasoning. Call the modifiee of M "W." M' must head-Govern the s structure counterpart of W, W', at s structure. If M' Governs W', we know from (70) that W' must be Y' and therefore W must be Y. But we also know from diagram (70) that M' does not head a phrase (the modifiee heads the phrase consisting of a modifier and a modifiee and Y' is the modifiee in (70)). So the only way M' may head-Govern W' is by Governing it. Since M' Governs Y', W' must be Y' and W must be Y. "W" was the name we gave to the l-s modifiee of M, so mod(M, Y) -- see (71).

(71)

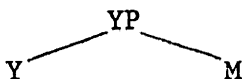

But if mod(M, Y), then Y is an operand at l-s structure and cannot serve as an operator in any l-s relation -- the constituent structure of l-s structure prohibits a single constituent from serving both as an operand and as an operator. In general, then, if r(Y, X) for some l-s relation r, then the s structure counterpart of Y, Y', will not be modified. If Y' were modified, we just proved that mod(M, Y) for some modifier M, and mod(M, Y) is incompatible with r(Y, X) since Y may not be both operator and operand.

Returning to the specific situation relevant to this section, in which mod(Y, X), the discussion of the last paragraph proved that there is no case in which Y' is a modifiee. Therefore, mod(Y, X) must correspond to MOD(Y', X'), our conclusion from the situation in which Y' is not a modifiee.

2.4.2.2. The s structure counterpart of the predicate-subject relation. The feature [\pm Pred SR], contained in the lexical entries of verbs (and other predicate producers), encodes whether or not the predicates the verb produces may take logical subjects. If the verb is [+Pred SR], the predicate phrase P it heads in l-s structure will have a logical subject, X -- sub(P, X), as illustrated in (72).

(72)

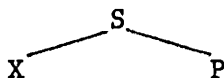

By principle (66), the s structure counterpart of the predicate phrase, P', must head-Govern the s structure counterpart of its logical subject, X'.

Given sub(P, X), there are two cases to consider. First, P' may be modified at s structure. This possibility was ruled out in the last section, where we proved that $r(Y, X)$ for any l-s relation r implies that the s structure counterpart of Y is not an s structure modifiee. Since sub(P, X), P' may not be modified. If P' is not modified, it may only head a sentence. But sentences do not Govern constituents. So for P' to head-Govern X', P' must Govern X'. Since the only grammatical relation a constituent may bear with respect to the s structure counterpart of a predicate is the SUB relation, X' must be the SUB of P'. So sub(P, X) must correspond to SUB(P', X').

2.4.2.3. The s structure counterpart of an l-s object in an argument phrase. If X is the object of Y, Y a semantic role assigner without an argument structure, then X and Y make up an argument phrase at l-s structure (see (73)) and by principle (66), the s structure counterpart of Y, Y', must head-Govern the s structure counterpart of X, X'.

(73)

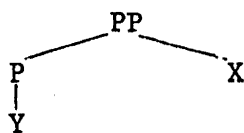

Y' will be a syntactic role assigner, if [+transitive], which does not take arguments and thus will head an s structure argument phrase. Since an s structure argument phrase is not the operator in any grammatical relation, X' will not be Governed by any phrase Y' heads and must therefore be Governed by Y' itself to be head-Governed by Y' . So Y' must be [+transitive] and X' must be the OBJ of Y' . When merger is excluded, then, the logical object in an l-s argument phrase will correspond to a grammatical OBJ in an s structure argument phrase -- see (69) row III.

2.4.2.4. The s structure counterpart of the argument-taking item - argument relation. As described above, there are two sorts of l-s arguments: arguments which are logical objects of the argument-taking item with respect to which they bear the argument relation, and argument phrases consisting of a semantic role assigner and its logical object. Recall that an argument phrase may not bear a semantic role. Corresponding to each type of l-s argument, there is a type of s structure argument: arguments which are also OBJs of the argument-taking item with respect to which they bear the argument relation, and argument phrases consisting of a syntactic role assigner and its OBJ. Recall that an argument phrase is not the sort of constituent which may bear a syntactic role.

We shall consider the two sorts of l-s arguments separately. First, suppose an argument phrase X bears the argument relation with respect to the argument-taking item Y at l-s structure -- $\text{arg}(Y, X)$ but not $\text{obj}(Y, X)$ (see (69) row IV). The s structure counterpart of Y , Y' , must head-Govern the s structure counterpart of X , X' , to satisfy principle (66). Since the

s structure counterpart of an l-s semantic role assigner without an argument structure is an s structure syntactic role assigner which takes no arguments, the head of the argument phrase X will correspond to an s structure syntactic role assigner which takes no arguments, and X' will be an argument phrase. Because argument phrases cannot bear syntactic roles, X' may be neither a SUB nor an OBJ. If the possibilities are examined, it turns out that, for Y' to head-Govern the argument phrase X', X' must be an s structure argument of Y'.¹³ So when merger is excluded, an l-s argument phrase bearing the l-s argument relation must correspond to an s structure argument phrase bearing the grammatical argument relation; i.e., $\text{arg}(Y, X)$ corresponds to $\text{ARG}(Y', X')$ when not $\text{obj}(Y, X)$.

Suppose now that X bears the argument relation with respect to Y and X is the l-s object of Y, i.e., $\text{arg}(Y, X)$ and $\text{obj}(Y, X)$ (see (69) row V). To satisfy principle (66), the s structure counterpart of Y, Y', must head-Govern the s structure counterpart of X, X'. Since Y is an argument-taking item at l-s structure, Y' will be an argument-taking item. To satisfy principle (66), X' could be an argument of Y', an OBJ of Y' (if Y' is [+transitive]), or the SUB of a phrase Y' heads (if Y has a P-A structure). X' could not be a modifiee of a phrase Y' heads for the reasons outlined in footnote 13. Each of the possibilities for the s structure counterparts of $\text{obj}(Y, X)$ and $\text{arg}(Y, X)$ is in fact instantiated, but in different circumstances.

2.4.2.4.1. The logical object as SUB. Consider l-s constituents X and Y such that $\text{obj}(Y, X)$ and $\text{arg}(Y, X)$, and Y has a P-A structure. We saw above that if an l-s argument-taking item is [+Pred SR], the logical subject of the predicate it heads will correspond to the SUB of the s

structure counterpart of this predicate. Therefore, if the s structure counterpart of X, X', is to correspond to the SUB of the phrase headed by the s structure counterpart of Y, Y', Y must be [-Pred SR] (see (69) row Va). If obj(Y, X) satisfies principle (66) by corresponding to SUB(Z, X'), where Y' heads Z, then arg(Y, X) will also satisfy principle (66) by corresponding to SUB(Z, X').

Below I shall analyze English passivization as the affixation to a verb of the passive affix, -en, carrying the features [-Pred SR], [-transitive]. The lexical entry in (74) approximates that for the passive participle of give, given.

(74) [[give]en] 'give' (theme, goal) [-Pred SR], [-transitive]

Since the s structure counterpart of the logical object of given must be head-Governed by given, since the verb, given, being [-transitive], takes no OBJ, and since English has no general means for making the s structure counterpart of the logical object of a verb an s structure argument of the verb by embedding it in an argument phrase (see section 2.4.2.4.3. below), the logical object of given must correspond to the grammatical SUB of the s structure phrase given heads (or of a phrase headed by this phrase in the case that given heads a VP which is modified at s structure). Compare the lexical entry (74) with the entries assumed for the unaccusative verbs, e.g., (48b) above. Clearly, whatever mechanism tells us that the sole semantic role associated with an unaccusative verb will be born by the syntactic SUB of the phrase the verb heads will account for the "promotion" of the logical object to SUB in passive constructions as well. My claim is that this mechanism is just the general principle, principle (66), which constrains the association of l-s and s structures.

2.4.2.4.2. The logical object as OBJ. If $\text{obj}(Y, X)$ and $\text{arg}(Y, X)$, and Y is [+transitive] then the s structure counterpart of X, X' , may bear the OBJ relation with respect to the s structure counterpart of Y, Y' , i.e., $\text{OBJ}(Y', X')$. The way I have set things up formally, a constituent which is simply the OBJ of an argument-taking item and not also an argument will not appear in the constituent structure representation of s structure. Constituents which are merely OBJs only appear in s structure if they are embedded in an argument phrase. Therefore, to satisfy principle (62) above, that an s structure be representable as a single well-formed constituent structure tree, X' must also be a grammatical argument of Y' ; i.e., $\text{arg}(Y, X)$ will correspond to $\text{ARG}(Y', X')$ (see (69) row Vb). Since English has no general means for making the s structure counterpart of a verb's logical object an s structure argument of the verb embedded in an argument phrase (see section 2.4.2.4.3. immediately below), the logical object of a [+Pred SR], [+transitive] English verb must correspond to its OBJ.

2.4.2.4.3. The logical object as argument. Consider again 1-s constituents X and Y such that $\text{obj}(Y, X)$ and $\text{arg}(Y, X)$.

(75)

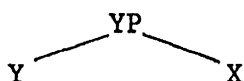

As the theory has been developed, the s structure counterpart of X, X' , may not be the OBJ in an argument phrase which is an argument of the s structure counterpart of Y, Y' , as in (76), and still satisfy principle (66).

(76)

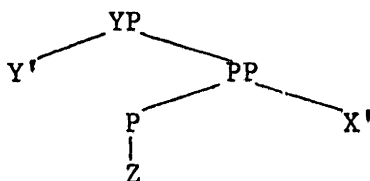

Y' does not Govern X' in the argument phrase PP in (76) serving as its

argument. However, returning to the technical definition of an s structure argument as a constituent bearing a syntactic role, we see that the OBJ in an argument phrase which is an argument of Y', like X' in (76), should count as Governed by Y' for the purposes of principle (66). Suppose X' is the OBJ of some Z in an argument phrase serving as an s structure argument of Y', as in (76). Then, technically speaking, it is X' bearing the role assigned by Z which is the argument of Y' -- X' does bear a grammatical relation with respect to Y'. Therefore, if $\text{obj}(Y, X)$ and $\text{arg}(Y, X)$, principle (66) should be satisfied if $\text{ARG}(Y', \text{PP})$, where PP consists of X' and some syntactic role assigner Z. Note that Z will have no l-s counterpart; it must be introduced into s structure in some manner.

As an example of a logical object corresponding to an argument in an argument phrase, consider the nominalizations of verbs discussed briefly above. A noun like destruction, it was claimed, has a nominal-argument structure related to the P-A structure of its source verb, destroy.

(77) 'destruction' (destroyed)

The function destruction names takes in a "destroyed" argument, to which it assigns the "destroyed" role, and yields a nominal. Above, I simply stated that nouns do not take OBJs, i.e., do not assign syntactic roles. Also, since nominals, not being predicates, do not take logical subjects, their syntactic counterparts should not take grammatical subjects (for independent support for the contention that nouns do not take SUBs or OBJs, see Rappaport 1980 and Williams 1980b). Therefore, if our assumptions are correct, to satisfy principle (66), the logical object of destruction must correspond to an OBJ in an argument phrase which is an argument of destruction in s structure. In fact, a preposition without semantic con-

tent may appear to mark the logical object of destruction within an NP.

(78) the destruction of the city

The preposition of in (78) is the syntactic role assigner Z discussed in the last paragraph; compare the s structure of (78) in (79) with (76) above.

(79)

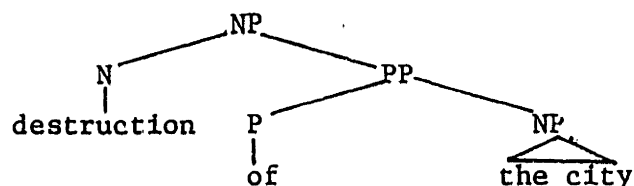

The logical object of a verb which is [+Pred SR], [-transitive] finds itself in the same predicament as the logical object of a noun. It cannot correspond to the SUB of the s structure VP the verb heads because the SUB must be the counterpart of the logical subject (see section 2.4.2.2. above). It cannot correspond to the OBJ of the verb in s structure because the verb, being [-transitive], takes no OBJ. As in the case of nominalizations, some syntactic role assigner without an l-s counterpart must appear in s structure to allow the s structure counterpart of the logical object to satisfy principle (66) by serving as the argument of the verb. In Chapter Three, section 3.1.2., we will examine morphemes, called "antipassive" morphemes, with the feature [-transitive] which attach to [+Pred SR], [+transitive] verbs to yield [+Pred SR], [-transitive] derived verbs. The derived antipassive verbs do introduce syntactic role assigners (e.g., oblique case marking, prepositions) to mark their logical objects.

If in fact logical objects may correspond to OBJs in argument phrases, we must ask what constrains the introduction into s structure of the heads of these argument phrases -- the introduction of the constituent Z discussed above. Since the theory posits no rules in the mapping between l-s structure and s structure, no rule could introduce the preposition of

in the course of a derivation of a sentence containing a derived nominal like destruction. Within the theory, the only way to effect the introduction of lexical material in s structure without inventing new machinery is to exploit principle (27) that the demands of lexical items are met at every level of structure. The nominal destruction must demand that its logical object correspond to the OBJ of of in s structure, thereby insuring the introduction of of in s structure to meet principle (27).¹⁴ I mentioned earlier that certain verbs must require their logical objects to correspond to their s structure OBJs (see sections 3.1.1.3. and 3.3.2. below for examples). The requirement that destruction's logical object be expressed as the OBJ of of may be viewed as a lexical specification of the same sort. The nominalization process could provide this specification to destruction, or it may be made available to nouns through a more general redundancy rule in the lexicon. Any such specification would be optional in the lexical entry of destruction, of course; if no such specification was provided, destruction's logical object would be unable to meet principle (66). (80) displays one possible notation of the fact that destruction's logical object is specified to correspond to the OBJ of of in s structure.

(80) 'destruction' (destroyed)
 pp [of]

Locating the introduction of syntactic role assigners without l-s counterparts within lexical entries as described above places severe constraints on their use in the mapping between l-s and s structure. In particular, these syntactic role assigners must be associated with particular semantic roles -- there is no way to specify that destruction introduces an of into s structure without specifying that some l-s argument of

destruction corresponds to the OBJ of of. Restricting elements introduced into s structures to the expression of some l-s relation of the lexical items which introduce the elements will be shown in section 2.6.2.1. below to rule out "raising to argument" constructions and raising within noun phrases. Note also that allowing lexical items to fix the association of l-s and s structure relations does not weaken the theory to any great extent. We saw in the above paragraphs that the theory already fixes the correspondence between l-s and s structure relations in most cases. The only l-s relations whose s structure counterpart is not fixed by general principles (outside of merger) is the obj(X, Y) relation, where Y is also an argument of X (see table (69)). The obj(X, Y) relation may have its s structure counterpart fixed within the lexical entry of X, either to OBJ(X, Y'), Y' the s structure counterpart of Y, or to OBJ(Z, Y'), Z a syntactic role assigner with no l-s counterpart. The counterpart of obj(X, Y) may not be fixed to a SUB relation because X will not Govern a SUBJ at s structure, and it is generally true that a lexical item may not make explicit demands of elements it does not govern or Govern.

2.4.2.5. Summary. I demonstrated in the above paragraphs that principle (66) places severe constraints on the possible grammatical relations the s structure counterparts of l-s constituents may bear. When merger of l-s items in s structure is excluded, only logical objects of argument-taking items are allowed any flexibility in their s structure expression. This flexibility accounts for the "relation changing" alternations observed in many languages. The alternation of a logical object corresponding to either an OBJ or a SUB is the "passive" alternation (see section 3.1.1. below); the alternation of a logical object corresponding to either an OBJ

or a constituent within an argument phrase is the "antipassive" alternation (see section 3.1.2. below).

2.5. Surface structure and the mapping between s and surface structure. The theory of grammatical relations I have been developing here is intended to be universal. No matter what the surface structures of a language look like, the language will have s structures and l-s structures like those described above. Though the theory makes claims about constituency in the syntactic analysis of sentences, it does not necessarily imply anything about constituency in the phrase structure of languages. Every language has s structure VPs, i.e., grammaticalizations of predicates, for example, but a language may lack phrase structure VPs. The surface structure of a sentence in a given language, we have assumed, is derived via Move α from a deep structure generated by the phrase structure rules of the language, whatever they may be. It is the responsibility of a theory of phrase structure, like X-bar theory, to delimit the range of possible phrase structure rules for a language. Such rules may vary from the $S \rightarrow W^*$, W a word, rule Hale (1980) proposes for Warlpiri through rules like $\bar{V} \rightarrow \bar{X}^* V$, \bar{X} a maximal projection, $\bar{V} = S$, which Farmer (1980) proposes for Japanese, to the highly explicit rules Jackendoff (1977) suggests for English. Whatever the rules, the structures produced by them and Move α must be associated with s structures.

Perhaps because of a concentration on English in transformational linguistics, the connection between relational structure and constituent structure, a central topic of linguistic theory, has until recently received little attention in the transformational-generative tradition. As we have seen, it is generally possible to represent s structure, a relational struc-

ture, in constituent structure trees resembling the phrase structure trees of English. Because English seems to encode grammatical relations in phrase structural relations in a transparent manner, it has been tempting to claim that the connection between surface -- or "surfacy" -- structures and relational structures is trivial. However, recent studies of languages with widely different or impoverished phrase structures compared with English have forced linguists working within the transformational-generative framework to examine more carefully the possible mappings between relational and constituent structure representations (see, e.g., the work of Hale 1980, Farmer 1980, and the studies in Bresnan 1981a). The results of these studies are leading to a new understanding of the place of grammatical relations in linguistic theory (see Chomsky 1980b, and Bresnan 1981a). Even if I had the space here, I could not possibly hope to present anything near a complete story about the mapping between s structure and surface structure encompassing the range of languages which have been the object of intensive study over the last few years. No one has completed the necessary preliminary work on describing the possible range of surface structures in universal grammar. We must content ourselves here with a discussion of some general principles governing the mapping between s and surface structures and some remarks about this mapping relevant to the central issues of the dissertation.

2.5.1. General principles. First, every lexical item in s structure will appear in surface structure. This principle anchors the association of s and surface structures as the parallel principle anchors the association of l-s and s structure, allowing us to identify the surface structure counterparts of s structure constituents. Because some distinct

s structure constituents will "merge" in s structure (i.e., correspond to a single, complex surface structure item; see Chapter Three, section 3.4., and below), there will not be a one-to-one correspondence between constituents at s structure and constituents at surface structure.

Although the identity of lexical items in s and surface structures establishes a correspondence between the constituents of the two structures, some additional principle is required to guarantee that the grammatical relations of s structure find counterparts in surface structure. Because a theory of surface structure is wanting, the principle governing the mapping between s and surface structure relations (corresponding to principle (66) above) may only be given a general, imprecise formulation, something like (81).

(81) Grammatical relations must be expressed in surface structure. Grammatical relations are "expressed" in surface structure in a variety of ways. In languages like English with developed phrase structure components, the grammatical relation between two s structure constituents X and Y might be expressed as a structural relation between the surface structure counterparts of X and Y. For example, given an s structure verb, X, its OBJ, Y, and their surface structure counterparts, X' and Y', the OBJ(X, Y) relation might be expressed as the [NP, VP] (NP immediately dominated by VP) structural relation, where the NP is X' and Y' "heads" the VP in the sense of X-bar theory. In other languages, the relationship between two s structure constituents X and Y might be expressed by placing a certain case marking on the surface structure counterpart of Y, Y', or by placing an element agreeing with Y' on the surface structure counterpart of X. For example, the OBJ(X, Y) relation might be expressed through the appearance

of accusative case on the surface structure counterpart of Y. And a grammatical relation between X and Y might also be expressed through the merger of the lexical heads of X and Y at surface structures. Consider the Japanese causative sentence (82), which I will claim in section 3.4.2. below, has the biclausal s structure shown in (83).

(82) John ga Mary ni okasi o tabe-sase-ta.
 NOM DAT cake ACC eat-CAUSE-PAST
 'John let Mary eat cake'

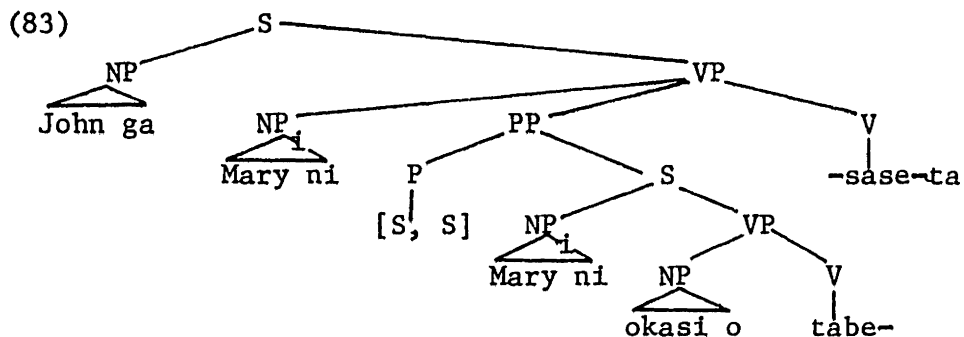

Note that the structural position, [S, S], assigns the embedded clause its syntactic role in (83) (see below for some discussion of structural positions assigning syntactic roles). The merger of tabe- 'eat' and -sase 'CAUSE' in surface structure expresses the argument relation between -sase and its clausal complement. (There are some technical difficulties with this analysis associated with our treatment of s structure arguments. Although the second argument of -sase in (83) is represented as a PP, the argument is technically the embedded S bearing the syntactic role assigned to it by [S, S]. Thus the merger of -sase and tabe- in (83) does technically merge -sase with the lexical head of its argument, expressing the argument relation between -sase and its clausal argument.) A fully developed account of the mapping between s and surface structure would explain what implications the merger of tabe- and sase- holds for the determination of the surface structure counterparts of the various s structure constitu-

ents in (83). A likely surface structure for (83) is given in (84) (see Chapter Three, section 3.4.2.).

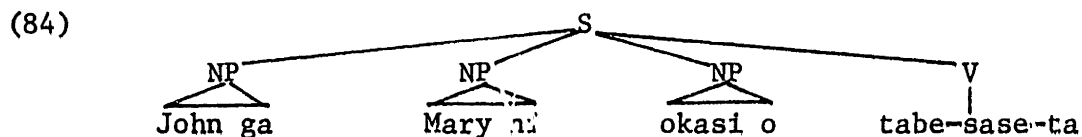

I assume that some version of X-bar theory (cf. Jackendoff 1977; Marantz 1978, 1980b) provides grammars with phrase structure rules, with S the maximal projection of V (see Marantz 1980b). There are languages in which the surface structure counterparts of constituents of s structure NPs and Ss do not stick together as units in surface structure, intermingling instead with the counterparts of constituents of other NPs and Ss (see Nash, 1980 for a description of one such language -- Warlpiri). To the extent that a language keeps the surface structure counterparts of constituents of s structure NPs and Ss together, we may state generalizations constraining the mapping between s and surface structures related to constituent structure. For example, a constituent Governed by X in s structure will correspond to a constituent contained within the maximal projection of the surface structure counterpart of X. Within the present framework, we may interpret the GB theory of Chomsky (1981) as making a very strong claim about the mapping between surface and s structure for a language like English with highly articulated phrase structure rules. A notion of surface structure structural government may be defined as in (85).

- (85) Definition: X structurally governs Y at surface structure iff X and Y are sisters immediately dominated by Z and X is the head of Z.

Following the spirit of Chomsky (1981), we could claim that the principle which constrains the mapping between s and surface structure in a language like English demands a strict correspondence between structural government

and Government:

- (86) Principle: If X Governs Y in s structure then the surface structure counterpart of X must structurally govern the surface structure counterpart of Y.

Although there would be difficulties incorporating (86) into the present framework (the modifier-modifiee relation is particularly troublesome here), the general approach represented by principle (86) seems extremely promising, and a modified version of (86) will most likely work. The insight captured by the GB framework, an insight encoded in (86), is that English and other highly configurational languages express grammatical relations (Government) in structural relations (structural government).

2.5.2. Unusual expressions of grammatical relations. Although each language specifies the unmarked expression of grammatical relations, individual operators may make idiosyncratic demands on the expression of the relations they control. For example, although the usual expression of the OBJ relation in a language may be the appearance of accusative case on the surface structure counterpart of the OBJ, a verb in the language might require an unusual case on its OBJs. If such information were carried within the lexical entry of the verb, principle (27), that lexical requirements are met at every level of structure, would guarantee compliance with demands for an unusual expression of the verb's OBJ. Japanese normally marks OBJs with the "accusative" particle o, as in (87).

- (87) Mary ga okasi o taberu.
 Mary NOM cake ACC eat
 'Mary eats cake.'

However, as explained in Marantz (1981a), certain Japanese verbs, such as soodan suru 'consult,' require the "dative" particle ni on their objects.

- (88) a. John ga Mary ni soodansita.
 NOM DAT consult-PAST
 'John consulted Mary.'
- b. Mary ga John ni soodans-(r)are-ta.
 NOM DAT consult-PASS-PAST
 'Mary was consulted by John.'

One indication that the "consulted" argument is an OBJ in (88a), even though it is marked with the dative particle, is that it passivizes, as shown in (88b).

Since the specification of an unusual expression of a grammatical relation is found in the lexical entry of the operator of the relation, grammatical relations with phrasal operators, like SUB(X, Y), should not have exceptional expressions. Phrases do not have lexical entries in which an exceptional expression of a grammatical relation might be recorded. Moreover, the lexical head of a phrase could not dictate the expression of a constituent that the phrase governs/Governs because an item may only make demands about a constituent it governs or Governs itself. These restrictions on the specifications of unusual expressions of grammatical relations predict that, although an OBJ may have an unusual expression dictated by the item which Governs it, a SUB may not be expressed unusually. Because it has no lexical entry, the verb phrase which Governs the subject may not dictate an exceptional expression for the SUB relation; because it does not Govern the SUB, the verb which heads the verb phrase may not specify such an exceptional expression either.

Rather than disconfirming this prediction about the exceptional expression of SUBs, the phenomenon of "quirky case marking" (see Andrews 1981), which appears to involve verb-determined exceptional case marking on subjects, actually provides striking support for it. In a discussion of case marking in Icelandic, Andrews (1981) points out that Icelandic

verbs may demand unusual case marking on their subjects or on their objects. For example, although objects are usually accusative and subjects (of matrix clauses) nominative, hjálpa 'help' requires a dative object and batna 'recover from' requires a dative subject (in matrix clauses), as illustrated in (89).

- (89) a. Ég hjálpa honum.
 I help him-DAT
 'I help him'
- b. Barninu batnaði veikin.
 child-DAT recover-from disease-NOM
 'The child recovered from the disease.'

The unusual feature of Icelandic "quirky case," the feature which sets it off from the exceptional case marking illustrated in Japanese above, is the so-called "case preservation effect." Note that the dative object of Japanese soodan suru in (88a) corresponds to a nominative subject of the passive in (88b); that is, the "consulted" argument bears the dative case as an OBJ but the nominative case as a subject. This change in case of the Japanese unusually case marked objects indicates that the unusual case marking is associated with the grammatical relation OBJ rather than with a semantic role. The verb soodan suru 'consult' demands that its grammatical OBJ be expressed in the dative case, not that its logical object appear in the dative case; if it made the latter demand, its logical object would appear in the dative case as SUB of the passive in (88b). In contrast to the behavior of Japanese exceptional case marking on objects, Icelandic quirky case is preserved in passivization and raising. In (90a-c) we see that the dative object of hjálpa 'help' corresponds to a dative subject of the passive (90a), a dative object of a raising to object verb when the passive is embedded under such a verb (90b), and a dative subject of a raising to subject verb when the passive is embedded

under this sort of verb (90c).

- (90) a. Honum er hjálpað.
 he-DAT is help-PASS
 'He is helped.'
- b. Ég tel honum hafa verið hjálpað.
 I believe him-DAT to-have been help-PASS
- c. Honum virðist hafa verið hjálpað.
 he-DAT seems to-have been help-PASS

Similarly, the dative subject of batna 'recover from' corresponds to a dative object in raising to object constructions (91a) and a dative subject in raising to subject constructions (91b).

- (91) a. Hann telur barninu hafa batnað veikin.
 he-NOM believes child-DAT to-have recovered-from disease-NOM
 'He believes the child to have recovered from the disease'
- b. Barninu virðist hafa batnað veikin.
 child-DAT seems to-have recovered-from disease-NOM
 'The child seems to have recovered from the disease.'

In (92) we see that a normal, nominative subject (92a) corresponds to an accusative OBJ in raising to object constructions (92b) and a nominative subject in raising to subject constructions (92c).

- (92) a. María hafi skrifað ritgerðina.
 Mary-NOM has written dissertation-ACC
 'Mary has written her dissertation.'
- b. Þeir telja Maríu hafa skrifað ritgerðina.
 they-NOM believe Mary-ACC to-have written dissertation-ACC
- c. María virðist hafa skrifað ritgerðina.
 Mary-NOM seems to-have written dissertation-ACC

Since lexical items may only make demands on elements they govern or Govern, and since batna 'recover from' in (89b) does not Govern its SUB barninu 'child-DAT', batna must govern barninu at i-s structure to specify that it receives dative case. We saw in section 2.4.2. above that for a constituent which is not the logical subject of a predicate to correspond to the SUB of the s structure counterpart of the predicate, the verb which heads the predicate must be [-Pred SR] and the constituent in question must

indicate a constraint on the expression of the semantic roles in surface structure. The dative case assigns neither a semantic nor a syntactic role to the "helped" or "recoverer" arguments (see Levin 1981); rather, the constituents bearing these roles are constrained to appear in the dative case in surface structure. Suppose the DAT case did assign semantic roles to the "helped" argument of hjalpa or the "recoverer" argument of batna. Then the constituents bearing these roles would not be logical objects of the verbs in question but only arguments of these verbs in argument phrases headed by the semantic role assigning DAT case. But we proved above that arguments of verbs which are not also logical objects of these verbs cannot correspond to the SUB of the VPs the verbs head at s structure. Since the "helped" argument is the SUB of the passive of hjalpa (see (90a)) and the "recoverer" is the SUB of the active of batna (see (89b)), the "helped" and "recoverer" arguments must be logical objects of hjalpa and batna and the DAT case may not assign these roles. Neither could DAT case assign a syntactic role to the constituents bearing the "helped" and "recoverer" roles of hjalpa and batna. If the "helped" argument could satisfy principle (66) by corresponding to the OBJ of DAT case, it would not have to correspond to the SUB of the passive of hjalpa. But the "helped" argument must be the SUB of the passive of hjalpa, demonstrating that the constituent bearing the "helped" role does not receive a syntactic role from the DAT case. Similarly, if the "recoverer" argument of batna received a syntactic role from DAT case, it would not have to correspond to the SUB of active batna to satisfy principle (66). Since the "recoverer" argument must be the SUB of active batna, DAT case may not assign it a syntactic role.

Just as the semantic asymmetries pointed out in section 2.1.3.1. above support the asymmetry between the logical subject and a verb's P-A

internal arguments essential to the present theory, so the absence of Japanese-type exceptional case-marking on SUBs supports the grammatical asymmetry between the SUB and the s structure arguments of a verb. A verb does not Govern the SUB of the VP it heads at s structure and so may not demand an unusual case marking on the SUB. It does Govern its OBJ and may demand an unusual case marking for this constituent, as in the Japanese example discussed above. Where it seems as if a verb is demanding a "quirky case marking" on its SUB, as in Icelandic, the verb is actually stipulating a connection directly between the case and a semantic role, where the semantic role is internal to its P-A structure. In such situations, we expect the "case preservation effect" illustrated in (90)-(91) above. We also expect to find evidence that the quirky case marked subjects are not logical subjects, such as the failure of Icelandic verbs taking quirky case marked subjects to undergo passivization.

2.5.3. Structural positions and case markings as syntactic role assigners. In (6) above I listed case markings and structural positions among the potential semantic role assigners; in (51) these items appear among the potential syntactic role assigners as well. The case markings and structural positions mentioned in (6) and (51) are surface structure case markings and positions. Within the present theory, the assignment of a semantic role by a case marking or structural position is intended to establish a direct link between the semantic role and its surface expression. Similarly, the assignment of a syntactic role to a constituent by a case marking or structural position should imply that the constituent receives its syntactic role in the sentence (is integrated into the syntactic analysis of the sentence) simply by virtue of bearing the case marking or

appearing in the structural position. To insure that these intentions are fulfilled by the theory, i.e., that the assignment of a semantic role by case or position does set up a direct link between the semantic role and its surface expression and that the assignment of a syntactic role by case or position implies that the constituent receiving the role appears bearing the case or in the position, I introduce principle (94).

- (94) Principle:
- a. If a case marking or structural position assigns a semantic role to a constituent X, the case marking or structural position will assign a syntactic role to the s structure counterpart of X.
 - b. If a case marking or structural position assigns a syntactic role to a constituent X, the surface structure counterpart of X will bear the case marking or appear in the structural position.

Part a. of principle (94) may not need to be stated independently; it follows from the theory given certain assumptions. Part b. of (94) may be considered a definition of what it means to say that a case marking or structural position assigns a syntactic role.

2.6. Bearing multiple grammatical relations: Empty nodes at surface structure. Some problems related to the mapping between s and surface structure deserve special attention here. First, it was claimed above that a constituent may bear more than one grammatical relation at s structure. The NP Elmer in (95a) is both the OBJ of tense/agreement on the verb, give, and the SUB of the VP, [give a porcupine to Hortense]. Elmer in (95b) is the SUB of both the VP, [seem to have given a porcupine to Hortense] and the VP, [to have given a porcupine to Hortense] (as well as the OBJ of tense/agreement on seem). In (95c) Elmer is the OBJ of

believe and the SUB of [to have given a porcupine to Hortense].

- (95) a. Elmer gave a porcupine to Hortense.
 b. Elmer seems to have given a porcupine to Hortense.
 c. I believe Elmer to have given a porcupine to Hortense.

If Elmer bears more than one grammatical relation in sentences (95), should it not have more than one "expression" in the surface structures of these sentences; that is, shouldn't Elmer appear more than once in sentences (95)? How may a constituent like Elmer in (95) acquire more than one grammatical relation in the mapping from l-s to s structure? When a constituent like Elmer in (95) bears multiple grammatical relations, why are all the grammatical relations it bears, except one, the SUB relation in a tenseless clause? Raising constructions will be dealt with explicitly in section 2.6.2.1. below; section 2.6.2.3. explores the role of tense/agreement in English sentences. In this section I discuss the general questions surrounding a constituent's ability to bear more than one grammatical relation at s structure.

Related to the above questions is the problem of accounting for the distribution of "PRO," the phonologically null anaphoric pronominal discussed, e.g., in Chomsky (1979). PRO is the element assumed to appear in the "Equi" or "control" constructions illustrated in (96).

- (96) a. Elmer_i thought it would be nice [PRO_i to sell his last porcupine].
 b. Elmer_i tried [PRO_i to sell his last porcupine].
 c. Hortense persuaded Elmer_i [PRO_i to sell his last porcupine].

PRO is also assumed to appear with an "arbitrary" or indefinite interpretation in sentences like (97).¹⁵

- (97) a. It would be nice [PRO to sell porcupines for a living],
 b. [PRO to err] is human, [PRO to quill] porcupine.

Just as the SUB of the embedded VP in (95b) does not appear overtly in the sur-

face structure of the sentences, the PRO subject in (96b) has no overt surface structure realization. The major observational difference between the construction in (95b) and that in (96b) is that Elmer bears two semantic roles in (96b), the "trier" role by virtue of being the subject of try and the seller role by virtue of serving as the antecedent for the PRO, while Elmer in (95b) bears only the role of the giver. Similarly, (95c) and (96c) differ crucially in that the object of the matrix verb in (95c), Elmer, bears only the role of the logical subject of the lower clause while the object of the matrix verb in (96c), Elmer, bears two semantic roles. See Chomsky (1981) for a summary of the evidence which distinguishes raising (95b,c) from control (96b,c) constructions.

When it bears a grammatical relation at least¹⁶, PRO occurs only as the subject of a tenseless clause. Recall that if a constituent bears multiple grammatical relations, all but one will be SUB relations in tenseless clauses. While PRO does not appear overtly, no overt constituent appears as the subject of the embedded clauses in (95a-c). Since constructions in which a constituent bears multiple grammatical relations are so similar to constructions containing PRO, an account of the restrictions on the ability of a constituent to bear multiple grammatical relations should account for the distribution of PRO as well.

What is required here is an account of constituents which bear grammatical relations but do not appear in surface structure by virtue of bearing these relations. Recall that a lexical item may appear only once in surface structure because we individuate lexical items (i.e., tokens of lexical items) by their appearance in surface structure. If a lexical item is to bear multiple grammatical relations, then, all but one of the grammatical

relations it bears must be such that bearing the grammatical relation does not force the item to appear in surface structure. Since PRO is an element which does not appear in surface structure, i.e., has no surface structure effects, it may not bear any grammatical relation which forces it to appear in surface structure. Since from (95)–(97) above we can tell that the grammatical relation a constituent may bear without appearing in surface structure is the subject relation in a tenseless clause, the theory should contain a principle or principles which yield the result that subjects of tenseless clauses do not appear in surface structure.

In contrast to PRO and the subjects of the tenseless clauses in (95), the trace of Move α must appear in surface structure. This follows immediately from the model of grammar I presented in (4) of Chapter One. Since Move α generates surface from deep structure and leaves traces, traces of Move α will appear in surface structure. Since traces of Move α appear in surface structure, they should be in complementary distribution in s structure with the constituents like PRO which do not show up in surface structure. That is, trace of Move α will not be the subject of a tenseless clause. Since traces of Move α do occur in surface structure, they feed into the phonology and may have phonological effects. There are examples of the phonological effects of the trace of Move α in the literature (see, e.g., Jaeggli 1980).

I will not offer a new account of raising and control constructions here. Rather, I will translate the Government-Binding (GB) account (Chomsky 1981) into the present framework, making modifications as necessary to fit my assumptions. At the moment, it is not clear to me whether the analysis of these constructions in the present framework is significantly simpler or more

complicated than that in the GB framework. The insights of the present analysis are borrowed from the GB framework; the execution forced by the theory is novel.

2.6.1. General principles governing the appearance of constituents in surface structure. Suppose we say that, although all grammatical relations must be expressed by virtue of principle (81) above, a constituent will not appear in surface structure by virtue of bearing a grammatical relation unless it bears this relation with respect to a lexical item.

(98) Principle: The surface structure counterpart of a constituent X will appear in surface structure by virtue of X's bearing a grammatical relation, $R(Y, X)$, iff Y is a lexical item (or structural position).

That is, for the surface structure counterpart of a constituent to appear in surface structure by virtue of the constituent's bearing a grammatical relation, the constituent must be lexically Governed. Of course, a constituent may appear in surface structure for other reasons, e.g., by virtue of being the head of a phrase or by virtue of being the surface structure counterpart of an operator in a grammatical relation. Principle (98) has the consequence that SUBs, being Governed by phrases and not lexical items, will not have their surface structure counterparts appear in surface structure by virtue of bearing the SUB relation.¹⁷ If the SUB relation is expressed in surface structure but the SUB does not appear in surface structure by virtue of being the SUB, what could the surface expression of the SUB relation be? Suppose in English the $SUB(X, Y)$ relation is expressed as the $[NP, S]$ (NP immediately dominated by S) structural relation, where NP is the surface structure counterpart of Y and the surface structure counterpart of X, X', heads the S. (This expression of the SUB relation follows from the mapping principle (86) suggested above for languages with highly developed

phrase structure rules.) If the surface structure counterpart of Y cannot appear in surface structure by virtue of Y's bearing the SUB(X, Y) relation, then the NP in the [NP, VP] structural relation expressing the SUB(X, Y) relation should be empty in surface structure -- see (99b).

(99) a. s structure

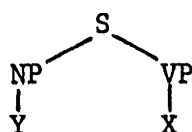

b. surface structure

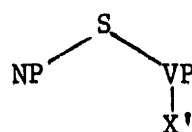

If (98) is correct, the question arises whether SUBs ever appear in surface structure. The answer to this question depends on the analysis of the role of such items as tense/agreement in determining the expression of constituents in sentences. When an NP, like Elmer in (95a) is both the SUB of a VP and the OBJ of tense/agreement, and the tense/agreement merges with the head V of the VP between s and surface structure, is the expression of the NP determined solely by tense/agreement, solely by the expression of the SUB(VP, NP) relation, or by some combination of these factors? I speculate on this issue in section 2.6.2.3. below.

It follows from the model of grammar I am assuming here (see (4) Chapter One) that only lexical items and traces of Move α appear in surface structure. Recall that lexical items are inserted into phrase structure trees generated by the phrase structure rules of a language. Move α , a general adjunction rule, creates surface structures from these trees. Nodes in surface structure will be filled by lexical insertion, empty because they were not filled at deep structure, or "empty" because their contents were moved via Move α (in this last case, the node is filled by a "trace"). If PRO is not a lexical item and thus is not inserted into deep structures, our principles yield the result that PRO may only bear SUB relations. If PRO were an OBJ

or argument, it would be lexically Governed and thus, by (98) above, would have to appear in surface structure. But if PRO appeared in surface structure, it would have to be a lexical item, since only lexical items are inserted into the phrase structure trees which are transformed via Move α into surface structures. So PRO cannot be a syntactic argument or OBJ. A PRO in s structure must correspond to an empty node in surface structure, i.e., a node not filled by lexical insertion.

Principle (98) also allows us to derive the result that, if a constituent X bears multiple grammatical relations, $R_1(Y_1, X), R_2(Y_2, X), \dots, R_n(Y_n, X)$, then for all R_i except one, R_i is a SUB relation. If X is PRO, we just demonstrated that all R_i must be SUB -- PRO cannot bear the OBJ or argument relations.¹⁸ Suppose then that X dominates lexical material. If X bears two non-SUB relations, then it will be lexically-Governed twice.¹⁸ According to principle (98), for each relation $R_j(Y_j, X)$ X bears such that Y_j is a lexical item, the surface structure counterpart of X, X' , will appear in surface structure by virtue of X' 's bearing the $R_j(Y_j, X)$ relation. So if X bears two non-SUB relations, its surface structure counterpart X' will be required to appear twice in surface structure. But to appear in surface structure, X' must be inserted into deep structure from the lexicon. Since the same token of a lexical item cannot be inserted into deep structure twice, each appearance of a node containing lexical material in surface structure is a different constituent. Therefore, the surface structure counterpart of an s structure item cannot appear twice in surface structure and X may bear only one non-SUB relation.¹⁹

So if a constituent bears more than one grammatical relation, all but one must be SUB relations (with the exception noted in f.n. 19). But how may a constituent acquire more than one grammatical relation in the first

place? Principle (66) constrains the mapping between l-s and s structure by demanding that each l-s relation correspond to a grammatical relation meeting certain requirements. As stated, principle (66) does not prohibit a constituent from bearing more than one grammatical relation at s structure. If we say nothing more, a constituent will be able to bear as many grammatical relations as allowed by other principles. Let us say nothing more. If a constituent bears multiple grammatical relations at s structure, "chains" of grammatical relations will be established (see Chomsky 1981). A grammatical relation chain is defined in (100).

- (100) A chain of grammatical relations (GR chain) in an s structure is the maximal set of relations $\{R_1(X_1, Y_1), R_2(X_2, Y_2), \dots, R_n(X_n, Y_n)\}$ such that for all i ,
- (a) $Y_i = Y_{i+1}$, and
 - (b) Y_i c-commands Y_{i+1}

By condition (100a) we mean that the contents of Y_i , a node at s structure, are identical to the contents of Y_{i+1} . This condition insures that the GR chain is born by a single s structure constituent. For "c-command" in (100b), I adopt the definition: X c-commands Y iff the node immediately dominating X dominates Y. The concept of a grammatical relation chain plays no direct role in the theory but proves extremely useful in explaining constraints on constituents' bearing multiple grammatical relations.

It is clear then that there are severe constraints on GR chains. For example, the relationship between each link in the chain must be "close" in some structural sense. The raising construction whose s structure is represented in (101) is ungrammatical because the two grammatical relations born by Elmer are not sufficiently close.

- (101) I believe Elmer_i [_S that it seems [_S Elmer_i to have sold his last porcupine]].

If we stipulated that, for Y_i, Y_{i+1} in a GR chain, $G_1(X_1, Y_1), \dots, Y_i$ and Y_{i+1} must stand in an antecedent-anaphor relation, then the binding theory of Chomsky (1981), which defines possible antecedent-anaphor relations, provides the proper notion of "closeness" to constrain GR chains. I will not stipulate that the links of a GR chain must be connected by antecedent-anaphor relations; this will follow from other considerations.

Before turning to these considerations, the binding theory of Chomsky (1981) should be introduced. I present the principles of binding theory in a somewhat simplified form; see Chomsky (1981) for details. "Government-bt" in (102) which will be defined below is a special sort of government relevant for the binding theory (bt).

- (102) i. If X is a pronominal, it must be free in its governing-bt category.
 ii. If X is an anaphor, it must be bound in its governing-bt category.
 iii. If X is neither a pronominal nor an anaphor, it must be free.

To be "bound" for the purposes of (102) is to be c-commanded by a co-indexed item (in an "argument" position, i.e., in our terms, c-commanded by a co-indexed Governed item). To be "free" is to be not bound. The "governing-bt" category for X may be defined for present purposes as the minimal NP or S containing a governor-bt of X (see Chomsky 1981, for a more adequate definition). Finally, the notion of "government-bt" must be defined. Government-bt is a combination of the notion, "lexical Government" and "exceptional government-bt."

- (103) Definition: X governs-bt Y iff
 a. X lexically Governs Y; or
 b. X exceptionally governs-bt Y.

X lexically Governs Y if X Governs Y and X is a lexical item (or structural position). What distinguishes items which head raising constructions from items which do not is their ability to govern-bt exceptionally into their

complement clauses. That is, although the constituents of the lower clause may not bear a grammatical relation with respect to the raising item, the raising item is considered to lexically Govern them for the purposes of the binding theory, i.e., to govern-bt these constituents. Technically, an exceptional governor-bt is considered to govern-bt the constituents head-Governed by the lexical head of the complement of the exceptional governor-bt. Consider again sentence (95b), repeated here as (104).

(104) Elmer seems [_S to have given a porcupine to Hortense].

What is special about seem in (104) is that it "governs-bt" the constituents head-Governed by the lexical head of the embedded sentence at s structure. Any anaphor in the embedded S in (104) which is not governed-bt within the embedded S would thus have the matrix S as its "governing-bt category." Exceptional government-bt will be further clarified in the section on raising below (2.6.2.1.).

Recall that in raising construction like (104) no overt surface structure constituent appears as subject of the embedded clause although the SUB relation must be expressed. We need some means to refer to the s structure counterpart of empty surface structure subjects in such situations. Given a constituent Y such that R(X, Y) and the surface structure counterpart of Y is null, Y may be a "β-trace" (I use the term "β-trace" to distinguish this entity from the trace of Move α, or an "α-trace," about which I will have nothing more to say in this dissertation). Y must be either a β-trace or a PRO or both. A PRO would be the contents of Y -- PROs are constituents which bear semantic roles and grammatical relations. The label "β-trace" is a classification of Y; it does not refer to Y's contents, only to its properties. Given R(X, Y) such that the surface structure counterpart of Y does not appear in the surface structure expression of R, Y must dominate

PRO or be classified as a β -trace. It may do both.

Consider (105), the s structure of the raising construction in (104).

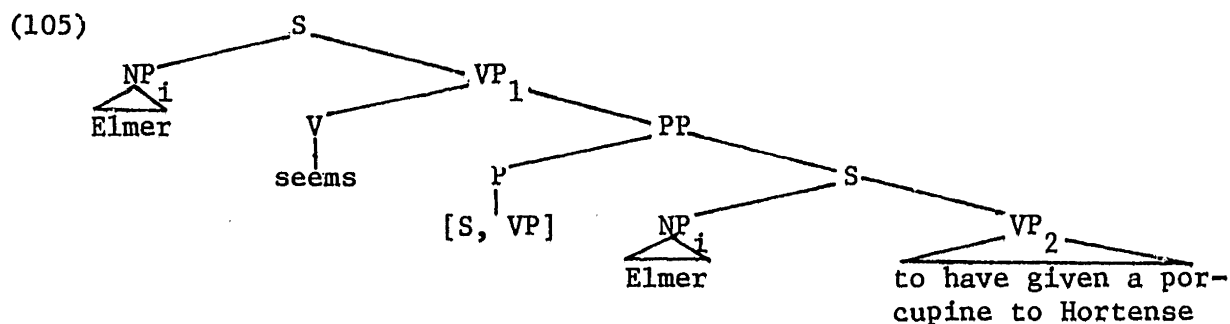

The SUB-of- VP_2 relation in (105) is expressed in surface structure as the [NP, S] structural relation, but according to (98) above, the surface structure counterpart of Elmer in the embedded sentence may not appear in surface structure by virtue of Elmer's bearing this relation. Therefore, the surface structure counterpart of Elmer in the lower S will be an empty node and NP_1 in the lower S of (105), which does not dominate PRO, will be classified as a β -trace. Again, β -traces are s structure counterparts of empty nodes in surface structure with certain characteristics.

We must attribute two properties to β -traces. First, they must be governed-by. If we identified β -traces as empty categories of the correct sort, this property of β -traces might follow from Chomsky's (1981) "Empty Category Principle" (or ECP) which states that empty categories must be "governed" in a special sense. Second, β -traces are anaphors which must be bound by an identical constituent at s structure. Recall that, although they correspond to empty surface structure categories, β -traces, like the second occurrence of Elmer in (105), are not empty categories at s structure. Although some co-indexed element, where co-indexation indicates co-reference, not identity, might happen to c-command a β -trace within its governing-by category, satisfying clause (ii) of (102) for the β -trace as

anaphor, we must stipulate that only an identical constituent will count as a binder for a β -trace to satisfy condition (ii) of (102). I do not know of any actual ungrammatical sentences in which this second property of β -traces comes into play, but hypothetical examples may be constructed. Consider the s structure in (106).

(106) [_{S₀} It [_{VP} r-verb Elmer_i [_{S₁} β -trace_i [_{VP} to have believed
[_{S₂} he_i seems that S]]]]] .

The r-verb (raising verb) in (106) exceptionally governs-bt into S₁, governing-bt the β -trace, whose contents is he_i. (This is not shown in (106).) That is, he_i is the subject of both S₁ and S₂ and the OBJ of tense/agreement on seem. The NP he_i receives its semantic role from the VP, [to have believed...], but appears in surface structure by virtue of bearing the OBJ relation with respect to tense/agreement on seem. Structure (106) might be seen as the result of "lowering" he from S₁ into S₂. Since it is c-commanded by and co-indexed with Elmer_i, the β -trace in (106) is technically bound by Elmer_i in the sense of binding theory, yet it is not bound to an identical constituent -- Elmer_i and he_i in (106) just happen to be coreferent; they are not the same constituent. The constraint that β -traces be bound by identical constituents to meet (102ii) rules out "raising" (really, lowering) constructions like (106). Such a constraint seems a defining property of "traces."²⁰

The machinery is all in place to derive some properties of GR chains (see (100) above). In the discussion to follow, we will be considering a GR chain, R₁(X₁, Y₁), R₂(X₂, Y₂), ..., R_n(X_n, Y_n), where for all i, Y_i = Y. First note that Y will dominate lexical material or PRO. These are the two possible bearers of grammatical relations at s structure.

Theorem 1: If Y dominates lexical material, R_1 may not be SUB.

Suppose Y dominates lexical material and R_1 is SUB. In this case, Y_1 in $R_1(X_1, Y_1)$ will be a β -trace since Y_1 in $SUB(X_1, Y_1)$ corresponds to an empty node in surface structure and Y is not a PRO. But β -traces must be bound by identical constituents. If Y_1 in $R_1(X_1, Y_1)$ were bound by an identical constituent, by the definition of "bound" it would be c-commanded by an identical constituent. But then, since GR chains are maximal (see (100)), this identical constituent should be Y_j in some $R_j(X_j, Y_j)$ higher in the GR chain than $R_1(X_1, Y_1)$. But there is no R_j higher than R_1 in the GR chain. So if Y dominates lexical material and R_1 is SUB, Y_1 will be an unbound β -trace, a violation of (102ii). Therefore, if Y dominates lexical material, R_1 must not be SUB.

Theorem 2: For all $i > 1$, $R_i(X_i, Y_i) = SUB(X_i, Y_i)$. Suppose $R_i(X_i, Y_i)$, for some $i > 1$, is not $SUB(X_i, Y_i)$. We demonstrated above that PRO may bear only SUB relations. Therefore, if $R_i(X_i, Y_i)$, $i > 1$, is not $SUB(X_i, Y_i)$, Y may not be PRO. So suppose Y dominates lexical material. By theorem 1, R_1 is not SUB. But we demonstrated above that a constituent dominating lexical material may not bear more than one non-SUB grammatical relation. Therefore, for all $i > 1$, R_i may not be distinct from SUB.

Theorem 3: If Y dominates lexical material, Y does not bear another GR chain. By theorem 1, each GR chain in which Y dominates lexical material must be headed by some R_1 distinct from SUB. So if Y bears more than one GR chain, it would have to bear more than one grammatical relation distinct from SUB. But we demonstrated above that a constituent dominating lexical material may not bear more than one grammatical relation distinct from SUB. So if Y dominates lexical material, it may bear no more than

one GR chain.

From the theorems and discussion above, we may conclude that each PRO will bear a GR chain (or chains) in which R_i is SUB for all i . A constituent dominating lexical material will bear a single GR chain whose R_1 is distinct from SUB, but for all $i > 1$, R_i will be SUB. Thus for $i > 1$ in a GR chain born by a constituent dominating lexical material, Y_i must be a β -trace. Since β -traces are anaphors subject to clause (11) of binding theory (102), the binding theory constrains the construction of GR chains, specifying how closestructurally each link of the chain must be to the next.

It will be useful to review here what assumptions and principles have been added to the theory to derive the distribution of PRO and the constraints on GR chains. First, I introduced principle (98). On the assumption that PRO is not a lexical item, principle (98) yields the distribution of PRO. Principle (98) also limits constituents dominating lexical material to one non-SUB relation each. Next, I presented a modified version of Chomsky's (1981) binding theory, (102), and specified that what is idiosyncratic about raising triggers is their ability to "govern-bt" (govern relevant to the binding theory) into their clausal complements. I defined a β -trace as an s structure counterpart of an empty node in surface structure with certain characteristics. I stipulated two properties of β -traces; first that they must be governed-bt and second that they are anaphors which must be bound to an identical constituent. The first property might follow from Chomsky's ECP; the second may be a defining property of traces. What seem to be the proper constraints on a constituent's ability to bear multiple grammatical relations, i.e., constraints on GR chains, follow from the theory given the characterization of β -traces.

2.6.2. Some special cases of constituents bearing multiple grammatical relations. 2.6.2.1. Raising. Raising phenomena are illustrated in sentences (107).

- (107) a. Elmer seems to have sold his last porcupine.
 b. I believe Elmer to have sold his last porcupine.

Elmer in (107a) is the SUB of both seems to have sold his last porcupine and to have sold his last porcupine while Elmer in (107b) serves as the OBJ of believe and the SUB of to have sold his last porcupine. Since the evidence for "raising" is well known and translates directly into the present framework, I will not justify here my identification of the grammatical relations born by Elmer in (107). It might appear that the claim that Elmer is the OBJ of believe in (107b) is controversial, but, in fact, what disagreement there is in the literature over "raising to object" centers on the surface constituent structure of (107b), not on the determination of grammatical relations. Some linguists claim (107b) has the surface phrase structure analysis shown in (108a), others that in (108b).

- (108) a. I believe [_S Elmer to have sold his last porcupine].
 b. I believe Elmer [_Sto have sold his last porcupine].

To claim that Elmer is the OBJ of believe in (107b) in the present theory does not commit one to either of the surface structures shown in (108). Linguists like Chomsky (1981) who support structure (108a) say that believe "governs" and "case marks" Elmer in (107b). As far as their consequences for the rest of the theory are concerned, "governing and case marking" in the GB framework correspond to "assigning a syntactic role to" in the present theory, at least in structures like (107b). If Elmer in (108a) is governed and case marked by believe in the GB framework, it has all the structure properties of the direct object of believe in (109).

(109) I believe Elmer.

In light of the discussion above, we may safely assume that Elmer bears the grammatical relations in (107) described above and move on to an analysis of these raising constructions.²¹

What is special about raising constructions like (107) is that a constituent, Elmer in (107a-b) is head-Governed by an item, seem in (107a) and believe in (107b), with respect to whose 1-s counterpart the 1-s counterpart of the constituent bears no 1-s relation. To put it another way, constructions like (107) are unusual in that Elmer bears a grammatical relation in the upper clauses but no semantic role in the 1-s counterparts of these clauses. I explained above that the special feature of raising verbs and adjectives will be attributed in the present theory to the ability of these items to exceptionally govern-*bt* constituents head-Governed by the lexical head of their clausal complements. If some constituent bears the SUB relation in the clausal complement of a raising item and this complement is tenseless (and lacks some other exceptional governer-*bt* of the SUB), the SUB will be the only element in the complement governed-*bt* by the raising item in the higher clause but not governed-*bt* by anything in the complement. The SUB in the complement clause will be a β -trace whose governing-*bt* category is the minimal S headed by the raising item which governs-*bt* it. By binding theory (102) clause (ii), the β -trace will have to be bound by an identical constituent in this minimal S. That is, the constituent bearing the SUB relation in a tenseless clausal complement to a raising item will have to bear some grammatical relation with respect to the raising item or to a phrase the item heads in order to bind the SUB of the clausal complement as β -trace. When the SUB of the clausal complement to a raising item bears such an additional grammatical relation "raising" has taken place.

Consider again sentence (107a). A partial l-s structure for (107a) is displayed in (111). A partial s structure for the sentence appears in (110).

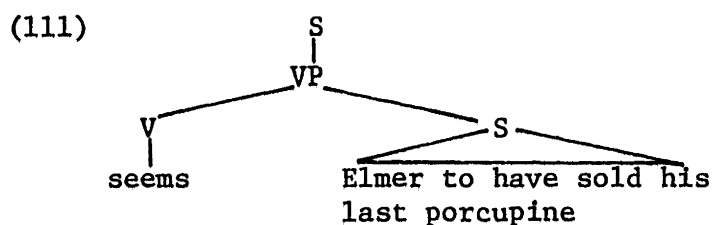
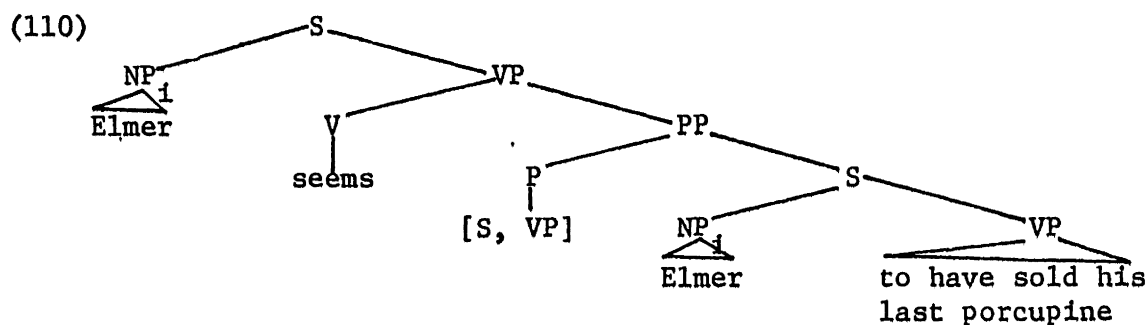

I assume that the structural position [S, VP] is provided to any verb to assign a syntactic role to the s structure counterpart of the verb's propositional l-s object. The lexical entry for seem is given in (112), where [+R] is the feature of raising items that indicates they govern-bt into their clausal complements.

(112) seem, V, 'seem' (appeared) [+R], [-Pred SR], [-transitive]

The second occurrence of Elmer in (110) will be identified as a β -trace. As a SUB, the second occurrence of Elmer corresponds to an empty node in surface structure. The s structure counterpart of an empty node is a PRO, a β -trace or both. Since Elmer is not PRO, the second occurrence of Elmer in (110) must be a β -trace. Since seem is [+R], it will govern-bt into its clausal complement at s structure. Since the second occurrence of Elmer is governed-bt by seem but not by anything in its own clause, the governing-bt category for this Elmer is the entire sentence (the minimal S containing

a governor-bt of Elmer). By (ii) of the binding theory (102), the second Elmer in (110) must be bound by an identical constituent within its governing-bt category, i.e., within the higher S in (110). Since seem is [-transitive], it will not take an OBJ which could serve as the antecedent for Elmer in the lower clause. Nor is there any way for an argument of seem which is not also seem's OBJ to serve as antecedent (see below). Thus, Elmer must occur as the SUB of the VP seem heads to bind the β -trace in the lower clause. Since seem is [-Pred SR], the predicate it produces takes no logical subject at l-s structure (see (111)), a constituent whose s structure counterpart would have to correspond to the SUB of the s structure counterpart of the predicate. Therefore, Elmer may serve as SUB of the VP seem heads in s structure (110), binding the second occurrence of Elmer from this position within its governing-bt category.

A partial s structure for sentence (107b) is given in (113).

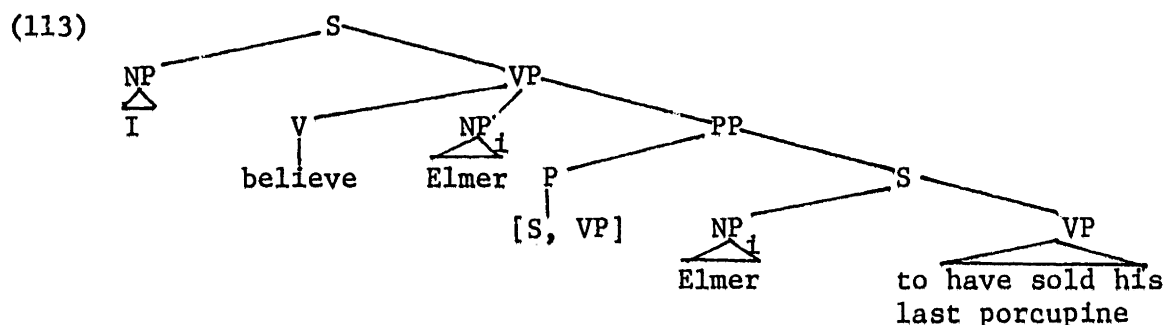

The lexical entry for believe in (113) is shown in (114).

(114) believe, V, 'believe' (believed) [+R], [+Pred SR], [+transitive]

The analysis of (113) is exactly parallel to that given for (110). Elmer₁ must bear some grammatical relation in the higher clause in (113) in order to bind the second occurrence of Elmer₁, a β -trace whose governing-bt category is the higher S. Since believe in (113) is [+Pred SR], Elmer may not bear the SUB relation with respect to the VP believe heads -- this relation is

reserved for the s structure counterpart of the logical subject of the predicate believe heads in l-s structure. For reasons to be reviewed below, Elmer could not be simply an argument but not an OBJ of believe. But because believe is [+transitive], Elmer may be the OBJ of believe and bind the second occurrence of Elmer_i in (113) from this position in the upper clause.

Raising must be from subject. This follows from the theorem proved above that all the links in a GR chain but the first must be SUBs. If raising were from object or argument, a GR chain would be established in which some R_i , $i > 1$, were not SUB, a violation of the constraints on GR chains derived from the theory. Constituents may not be "raised" from tensed clauses in English, because the SUB in a tensed clause is the OBJ of tense/agreement (see section 2.6.2.3. below). Therefore, raising from the SUB of a tensed clause is raising from object. Raising must be to subject or object. Raising to an argument which is not also the OBJ of the raising item is ruled out by the conditions imposed in section 2.4.2.4.3. above on the introduction into s structure of constituents without l-s counterparts. If a raised constituent were to be the argument of a raising item but not its OBJ, some syntactic role assigner would have to be introduced into s structure to assign the raised constituent its syntactic role -- see the discussion in section 2.4.2.4.3. Consider the s structure of a raising construction in (115), where X is the raised constituent in an argument phrase PP serving as argument to the raising item R. The s structure in (115) corresponds to the l-s structure in (116)

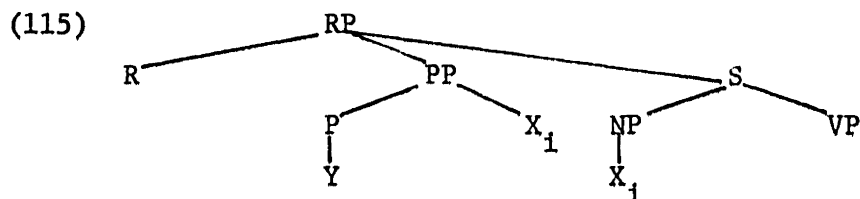

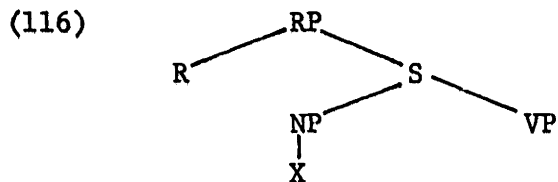

The head of the argument phrase, PP, in (115) is a syntactic role assigner without an argument structure. We stated in 2.4.2.4.3. above that if such syntactic role assigners are to be introduced into s structure, they must be explicitly linked to some semantic role in the lexical entry of a semantic role assigner. That is, the logical object relation between the semantic role assigner and its object is stipulated to correspond to the grammatical argument relation between the s structure counterpart of the semantic role assigner and an argument phrase headed by the syntactic role assigner to be introduced into s structure. If the raising construction in (115) were to be grammatical, X would have to be the s structure counterpart of a logical object of the raising constituent R so that the logical object relation between R and the l-s counterpart of X could be stipulated in the lexical entry of R to correspond to the argument relation between R and an argument phrase headed by Y. Since a raised constituent is not an l-s dependent of the raising item (see (116)), a raised constituent cannot be the argument of a raising item in an argument phrase.

If raising is only to SUB or OBJ, since nouns, we have claimed, do not take OBJs and do not head phrases which take SUBs,²² a noun may not be a raising item. No principle prevents a noun from exceptionally governing-
 bt into a clausal complement, i.e., from carrying the feature [+R]. However, as explained above, the OBJ of a [+R] item or the SUB of the phrase it heads must bind the SUB of its clausal complement. The failure of nouns to take OBJs or head SUB-taking phrases accounts for the fact that nominalizations

of raising verbs are not raising nouns.

- (117) a. *Elmer's appearance to have sold his last porcupine...
 b. *My belief of Elmer to have sold his last porcupine...

The "locality" restriction on raising -- the fact that a constituent "raised" from the clausal complement of a raising item must bear a grammatical relation in the clause headed by the raising item -- results from the binding theory (102). Since the raising item governs-bt the SUB of its clausal complement and the SUB is not governed-bt in its own clause, the clause headed by the raising item is the governing-bt category of the lower SUB. By clause (ii) of (102), some constituent within the clause that the raising constituent heads will have to bind the SUB.

2.6.2.2. A note on obligatory control. I have been assuming the analysis of "control" structures like (113) presented in, e.g., Chomsky (1981).

- (118) a. Elmer wished [PRO to sell his last porcupine].
 b. Elmer persuaded Hortense [PRO to buy his last porcupine].

The PRO SUBs of the bracketed clauses in (118) are assumed by Chomsky to be ungoverned-bt and subject to a "theory of control," yet to be worked out in detail, which determines their possible antecedents. Chomsky derives the principle that PRO must not be governed-bt from the binding theory (102) and the assumption that PRO is a pronominal anaphor. As an anaphor, PRO must be bound in its governing-bt category; as a pronoun, PRO must be free in its governing-bt category. The only way PRO could be both bound and free, logical opposites, in its governing-bt category would be for it not to have a governing-bt category, i.e., to be ungoverned. Since the PROs in (118) are ungoverned-bt in Chomsky's theory, the binding theory does not demand that they be bound to a constituent in the higher clause, and some

additional theory of control is necessary to insure that the PROs are correctly bound.

Assuming that PRO is not a lexical item, I have shown that it may not be lexically-Governed in the present theory. Recall that government-bt is a union of the notions "Government by a lexical item" and "exceptional government-bt" (see (103)). Suppose that PRO is only an anaphor, not a pronoun; i.e., suppose PRO is subject only to clause (ii) of the binding theory. If PRO is governed-bt, it must be bound in its governing-bt category; if ungoverned-bt, PRO need not be bound according to the binding theory. Since government-bt consists of lexical Government and exceptional government-bt and PRO may not be lexically Governed, PRO may only be exceptionally governed-bt, as by a raising item. In the present theory, then, we might analyze verbs of obligatory control like wish and persuade in (118) as having the same [+R] feature as raising verbs; they would govern-bt the constituents head-Governed by the head of their clausal complements. If the PROs in (118) were governed-bt by the matrix verbs, by (102ii) they would have to be bound by some constituent in the sentence headed by the matrix verbs. Treating verbs of obligatory control as exceptional governors-bt allows the binding theory to capture the local binding restrictions on PROs in sentences like (118). If the PROs in (118) were ungoverned-bt, as in Chomsky's theory, some condition in addition to binding theory would be necessary to force them to be bound to some constituent in the matrix clauses. Even if PROs may be governed-bt, when they are not so governed, as in (119), binding theory does not constrain their possible antecedents.

- (119) a. What is it necessary [PRO to do with porcupines on Sunday]?
 b. Elmer thinks it would be nice [PRO to hold a convention of porcupine dealers].

Note that principle (32) preventing a single l-s constituent from bearing more than one semantic role prohibits us from analyzing sentences (118) as involving β -traces. Suppose the PROs in (118) were replaced by β -traces. Recall that " β -trace" is a classification of an s structure constituent, not the contents of an s structure node. The contents of a β -trace must be identical to the contents of the node which binds it. If control structures contained β -traces, Elmer in (118a) would be both the SUB of the matrix clause and the SUB of the lower clause, which is the β -trace. But in order to be the SUB of both clauses at s structure, Elmer would have to bear both the "wisher" and the "seller" roles at l-s structure, in violation of (32). If we gave up principle (32) in favor of some other principle with the same effects in certain crucial cases, we might be able to support a β -trace analysis of control sentences like (118).

2.6.2.3. The expression of SUBs as OBJs of tense/agreement related items. In addition to the raising constructions discussed in the last section, which involve a verb governing- β t into its sentential complement, there are cases of SUBs expressed as OBJs which do not involve a higher verb. Some examples from English appear in (120).

- (120) a. For Elmer to sell his last porcupine would disturb Hortense.
 b. Elmer sold his last porcupine.

I claim that the SUB in sentences like the sentential subject of (120a) is expressed as the OBJ of the preposition for, the SUB of sentences like (120b) as the OBJ of tense/agreement. The expression of subjects in a language implicates the tense-aspect system²³ If I were to give a fully adequate account of examples like (120), I would have to work out the logico-semantics of the tense-aspect system of English. Since such an investigation would take us beyond the main topic of this dissertation, what follows must be

considered speculative. I will sketch the outlines of an analysis of the expression of SUBs in English first to demonstrate that sentences like (120) present no particular difficulties for the theory of grammatical relations described above and second to highlight what the present theory demands of such an analysis.

Suppose that an element determining the tense and/or aspect of a proposition appears in I-s structure as a modifier taking propositional modifyees. Such an analysis is in line with most accounts of the contribution of tense/aspect to the semantics of a sentence. An important property of modifiers is that, unlike the other items taking I-s dependents (predicates, argument-taking words, semantic role assigners), they combine with their modifyees to form an I-s constituent of the same type as the modifyee. A proposition modifier, like our proposed tense-aspect element, combines with a proposition to yield a proposition. We might identify the tense-aspect element as the I-s realization of Steele et al.'s (1981) Aux constituent. This I-s Aux element must contain all the lexical material directly connected with the tense-aspect system. I will assume that this material includes the tense morphology affixed to verbs, the infinitive marker to, and the so-called "complementizers" that and for. It is well known that complementizer selection is tied to the tense-aspect system; we will capture this dependence by placing at least the complementizers that and for within the Aux constituent. That is, the relationship between the tense-aspect system and complementizers will be stated in co-occurrence restrictions on elements in the Aux. The Aux element modifying the sentential subject of (120a) consists of the complementizer for and the infinitive marker to, along with all relevant information about the contribution of the Aux element

to the logical-semantics of sentences in which it appears. The Aux element in the l-s structure of (120b) contains the past tense morphology, which appears in surface structure on the head of the sentence, and various semantic information.

Since a proposition, S, in l-s structure bears the modiffee relation with respect to the Aux element, if no merger takes place between l-s and s structure, its s structure counterpart must bear the grammatical modiffee relation with respect to the s structure counterpart of the Aux -- see the table in (69) above. To account for the expression of Elmer in (120a-b) as the OBJ of for and of tense/agreement, we are forced by the present analysis to assume that the infinitival for-to Aux of (120a) and the tensed Aux of (120b) are [+R]. That is, these Aux elements, like raising verbs, govern-bt into their sentential complements at s structure. Because the Aux elements lack predicate-argument structures, they do not take logical subjects or head subject-taking phrases and, therefore, their s structure counterparts do not take grammatical SUBs or head SUB-taking phrases. Consequently, the [+R] Aux elements must be [+transitive] and the SUBs of their clausal complements must also be their s structure OBJs (cf. the discussion of raising above). The s structure of (120b) and of the sentential subject of (120a) look something like (121a-b) in the present analysis (irrelevant details omitted).

(121) a.

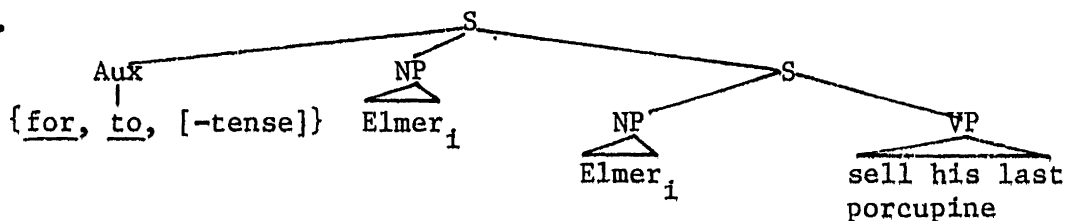

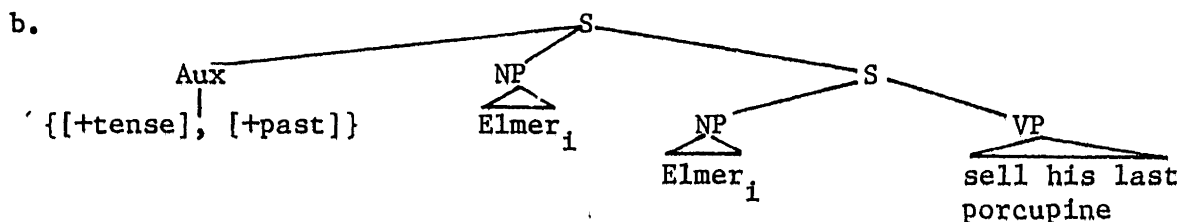

The modifier-modifiee relation between the Aux and its sentential complement in (121a) is expressed in surface structure as the structural relationship between the "complementizer," for, and the surface structure counterpart of the complement (actually, the structural relation is between a phrase headed by for and the complement -- see (122)). In addition, the modifier-modifiee relation is expressed by the appearance of lexical material from the Aux element, i.e., to, on the head of its sentential complement, i.e., the main verb sell. (Compare the expression of the OBJ relation between an oblique case and the NP to which it assigns a syntactic role as the appearance of the case marking on the head of the NP.) The OBJ relation between the Aux and Elmer in (121a) is expressed as the structural relation between for and Elmer in (122). The SUB relation between Elmer and the VP in (121a) is expressed as the [NP, S] structural relation, such that the surface structure counterpart of the VP heads the S. In accordance with (98), Elmer will not appear in surface structure by virtue of bearing the SUB relation with respect to the VP; therefore, the NP immediately dominated by the S which the surface structure counterpart of the VP heads will be empty in surface structure. A partial surface structure for (121a) is given in (122).

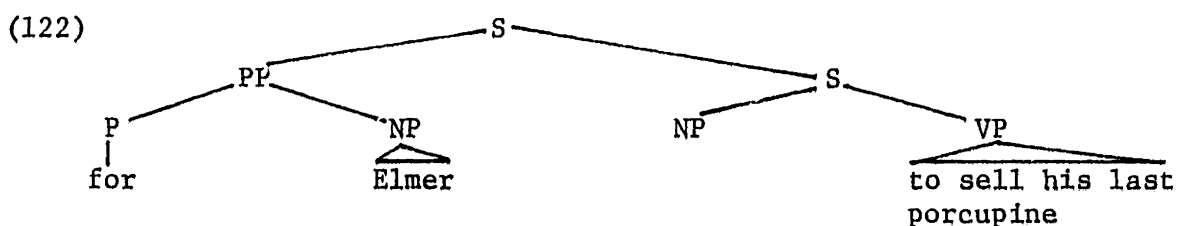

The modifier-modifiee relation in (121b) between Aux and its sentential complement is expressed in surface structure through the appearance of lexical material from the Aux element, i.e., the past tense and agreement morphology, on the head of its sentential complement, sell. The OBJ relation between the Aux and Elmer in (121b) is expressed through the agreement of Elmer with the agreement element in Aux, which ends up on the head of Aux's complement, i.e., on sell. A possible surface structure for (121b) is given in (123).

(123)

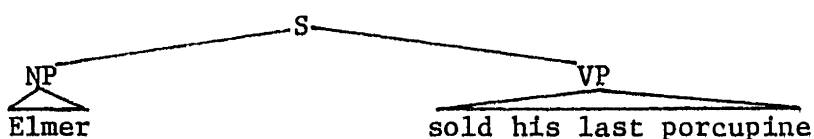

Since Aux, the sentence modifier in (121b), merges with sell, the head of the modifiee, neither the Aux nor the lower S in (121b) will have surface structure counterpart nodes. This follows from the principles of merger to be discussed in Chapter Three. According to (98), Elmer must appear in surface structure by virtue of bearing the OBJ relation with respect to the Aux element in (121b). However, the OBJ relation between Elmer and Aux is expressed through agreement of the Aux with Elmer. This expression of the OBJ relation does not determine the location of Elmer in surface structure. Recall that the SUB relation between Elmer and the VP in (121b) is expressed in surface structure as the [NP, S] relation where the surface structure counterpart of the VP heads the S. But, according to (98), Elmer will not appear as the NP immediately dominated by S by virtue of bearing the SUB relation. I assume that in cases where the SUB must appear by virtue of bearing an OBJ relation but does not have its surface structure location determined by the expression of the OBJ relation, the SUB may appear in the expression of its SUB relation. So Elmer may appear as the NP immediately dominated by the S headed by the surface structure counterpart of the VP

in (121b). The details of this analysis of the expression of SUBs whose location in surface structure is not fixed by an OBJ relation they bear remains to be worked out.

Our analysis of the expression of the SUBs in (120) began with the observation that the expression of SUBs cross-linguistically seems tied to the tense-aspect system of a language. Since the SUB of a sentence itself bears no l-s relation with respect to the tense/aspect of the sentence, the present theory demands that the sentence bear some l-s relation with respect to tense/aspect and that the tense-aspect elements behave like raising items. If sentences bore no l-s relation with respect to tense-aspect elements, our theory would provide no mechanism for capturing the dependence of the expression of SUBs on the tense-aspect system. Above, I have filled in some of the details of an analysis of the expression of SUBs in English within the constraints imposed by our theory; however, other analyses are possible within these constraints. A comparison of the possible analyses must await a study of the exact nature of the dependence of the expression of SUBs on tense and aspect and a thorough examination of the logical-semantics of the tense-aspect system.

FOOTNOTES

1. The reader might find sections of this chapter difficult to understand without reference to the data in Chapter Three. To aid the reader, I have included throughout Chapter Three extensive references to pertinent sections and principles of this chapter. A good strategy for attacking the dissertation would be to read through Chapter Two once, then read Chapter Three before returning to read Chapter Two a second time.
2. See Filmore (1968, 1977), Cook (1979), the papers in Abraham (1978), and the sources cited in these works.
3. In addition to the sources cited in f.n. 2, see Ostler (1979), Gruber (1976), Jackendoff (1972), and Carter (1976).
4. For the purposes of this dissertation, it is only necessary to claim that a verb names a mapping from arguments onto predicates. If the verb maps each set of arguments onto a single predicate, it names a function. I will continue to use the term "function" in the pages to follow even though it is not essential that verbs meet the uniqueness condition on functions.
5. I use "argument" here in the technical sense of a constituent bearing a semantic role which serves as input to a P-A structure, a nominal-argument structure, or a modifier-argument structure. I have also used "argument" to refer to one of the two primitive semantic relations, i.e., argument-taking item - argument and semantic role assigner - semantic role assignee. In this second sense, the modifiee is an argument of the modifier and the subject an argument of the predicate.
6. But see section 2.6.2.2. on structures of obligatory control.
7. A possible exception to the generalization that no "subject idioms"

exist in English is the expression, The cat has got X's tongue, where X represents the free argument position. Ken Hale informs me that Navajo has a great number of idiomatic expressions which would be analyzed as "subject idioms" on the basis of their English glosses. However, the identification of grammatical relations in Navajo is problematic. See Young and Morgan (1980, e.g., p. 313) for the Navajo data.

8. Nobuko Hasegawa informs me that arguments for the asymmetry among a verb's semantic dependents similar to those mustered above from English may be constructed with Japanese data. Lieber (1981) presents further evidence for this asymmetry from constraints on English compounding.

9. Alternatively, these terms may be seen as naming features of semantic roles. For example, the logical subject of run in Elmer ran away from the rabid porcupine might be [+agent], since Elmer is an active participant in the running, and [+theme], since Elmer undergoes a change of state (from a position near the rabid porcupine to a position farther away).

10. For an exposition of the assumptions and principles of Relational Grammar, see Perlmutter (1978, 1979, 1980a, 1980b) and Perlmutter and Postal (1978a, 1978b, 1980).

11. Just as there are only two basic l-s relations, i.e., semantic role assigner - semantic role assignee and argument-taking item - argument, so there are only two basic grammatical relations, i.e., syntactic role assigner - syntactic role assignee and syntactic argument-taking item - syntactic argument. I have defined the grammatical object (OBJ) as the syntactic role assignee of a non-phrasal constituent and the grammatical subject (SUB) as the syntactic argument of the s structure counterpart to a predicate. The grammatical modifiee is the syntactic argument of a grammatical modifier.

And the grammatical argument, in the narrow sense, is the syntactic argument of the s structure counterpart of an item with a predicate-, nominal-, or modifier-argument structure.

12. When we talk about a lexical item appearing at some level of structure, we are referring to a token of the lexical item. A given lexical item may appear more than once in surface structure if each occurrence is a different copy or token of the item.

13. The only other way Y' could head-Govern X' which is not ruled out by the inability of X' to bear a syntactic role would be for X' to serve as the modiffee of Y' or some constituent Y' heads. Since Y' is an argument-taking item at s structure, it is not a modifier and X' may not be the modiffee of Y'. However, if Y has a modifier-argument structure, Y' will head a modifier at s structure and X' could satisfy principle (66) by bearing the modiffee relation with respect to this modifier. This possibility is excluded because, in order to satisfy principle (66), some other constituent will have to bear the modiffee relation with respect to the modifier Y' heads and modifiers take only one modiffee each. The modifier headed by Y', M', will correspond to an l-s modifier M. Since, we have assumed, there are no degenerate l-s modifiers, i.e., modifiers without modiffees, M will take a modiffee at l-s structure. As we saw above, the s structure counterpart of this l-s modiffee must bear the grammatical modiffee relation with respect to the s structure counterpart of M, M'. Since modifiers take only a single modiffee, that the s structure counterpart of the modiffee of M serves as modiffee for M' prevents X' from bearing the modiffee relation with respect to M'. But M' is the modifier Y' heads at s structure. So X' may not bear the modiffee relation with respect to a phrase Y' heads.

14. That is, destruction must make this demand in sentences in which its logical object is expressed as the OBJ of of. For other possible expressions of the logical object of derived nominals, see section 3.1.1.1.2. below.

15. See Chomsky (1981) for some discussion of the principles which determine the antecedent for PRO in (96) and the conditions under which PRO may be "arbitrary" in reference, as in (97). For a slightly different proposal on the determination of PRO's antecedent in (96b-c), see section 2.6.2.2. below.

16. Chomsky and others have claimed that PRO may occur "in COMP," i.e., in a position in which it bears no grammatical relation.

17. Since modifiees are Governed by phrases, not lexical items or structural positions, principle (98) also implies that modifiees will not have their surface structure counterparts appear in surface structure by virtue of bearing the modifiee relation. However, modifiees are heads of phrases and may have to appear in surface structure for this reason.

18. We will not consider the grammatical modifier-modifiee relation in what follows. It turns out that no universal principle prevents PRO from bearing the modifiee relation -- see f.n. 17. In fact, certain constructions in some languages seem to involve PRO as modifiee. Raising from modifiee, although not ruled out by principle (98), will be prevented by Chomsky's (1981) "Empty Category Principle," although I will not demonstrate this.

19. The exception to this generalization is the situation in which X is both the OBJ and the argument of the same operator. We represent X in such a situation only once in our constituent structure representation of s structure, and principle (98) must be interpreted to allow the surface

counterpart of X to appear only once in surface structure.

20. In the Government-Binding theory of Chomsky (1981), a similar constraint on the trace of raising, that it be bound to the moved (raised) constituent, proves unnecessary to rule out "lowering" constructions like (106). Because Chomsky assumes that thematic-roles are assigned to "grammatical function chains," not to constituents or positions, his theta-criteria rule out (106). The demonstration that Chomsky (1981) does rule out (106) is left to the interested reader.

21. Cole and Hermon (1981) and Thráinsson (1980) present strong evidence that the raised object in raising to object constructions does not fall in the lower clause in the surface structures of Quechua (Cole and Hermon) and Icelandic (Thráinsson). That is, they argue for the equivalent of (108b) as the surface structure of raising to object constructions in these languages.

22. See Steele (1981) for a discussion of the relationship between the tense-aspect system and the expression of subjects in Luiseño.

CHAPTER THREE: ALTERNATIONS IN THE EXPRESSION OF A VERB'S SEMANTIC
DEPENDENTS.

3.0. Introduction. This chapter explores a wide range of grammatical phenomena often thought to implicate grammatical relations. These include passive and "antipassive" constructions, dative movement alternations, "applied verb" constructions, lexical reflexive forms, and causative sentences.

The grammatical phenomena under consideration involve alternations in the syntactic behaviour of verbs usually signaled by morphology on the verbs. The analysis of these phenomena will be shown to follow from the theory of grammatical relations developed in Chapter Two and an independently motivated theory of morphology. With an important class of exceptions to be discussed below, what have been called "lexical rules" in, e.g., the Lexical-Functional framework of Bresnan (1981a) reduce in the present framework to affixation. Two lexical items, a root and an affix, each with its own set of features, combine according to the subcategorization restrictions of the affix to yield a derived word whose features are a predictable combination of the features of the constituent morphemes. Passivization in English, for example, is the creation of a passive participle via affixation of the passive suffix to a transitive verb. The features of passive constructions are determined by the general principles discussed in Chapter Two and by features of the passive participles which passive constructions contain. The features of passive participles are in turn determined by the theory of morphology and by the features of the constituent transitive verb and passive suffix.

I will be adopting those aspects of the theory of morphology described in Lieber (1980) relevant to present concerns. Within this theory,

there are no word formation rules in the sense of Aronoff (1976). Rather, affixes as well as roots have their own lexical entries, and all morphemes are inserted into unlabelled binary branching word structure trees. The insertion of morphemes into word trees respects the subcategorization features contained in their lexical entries.¹ For example, since the passive suffix in English attaches to verbs, it carries the subcategorization feature, l_V , indicating it is to be inserted into a word tree to the right of a verb. Features of the morphemes inserted into the unlabelled trees percolate up through the tree according to the percolation conventions Lieber details. Feature percolation labels the nodes of the word trees and determines the features of the derived word, i.e., of the entire tree. Two of Lieber's percolation conventions will be of interest here. First, the features of affixes take precedence over the features of roots in percolation. For example, the affix -ment, although it attaches to verbs, is itself nominal. By the convention that features of suffixes take precedence over features of roots, the words derived by combining -ment and verbs become nouns.

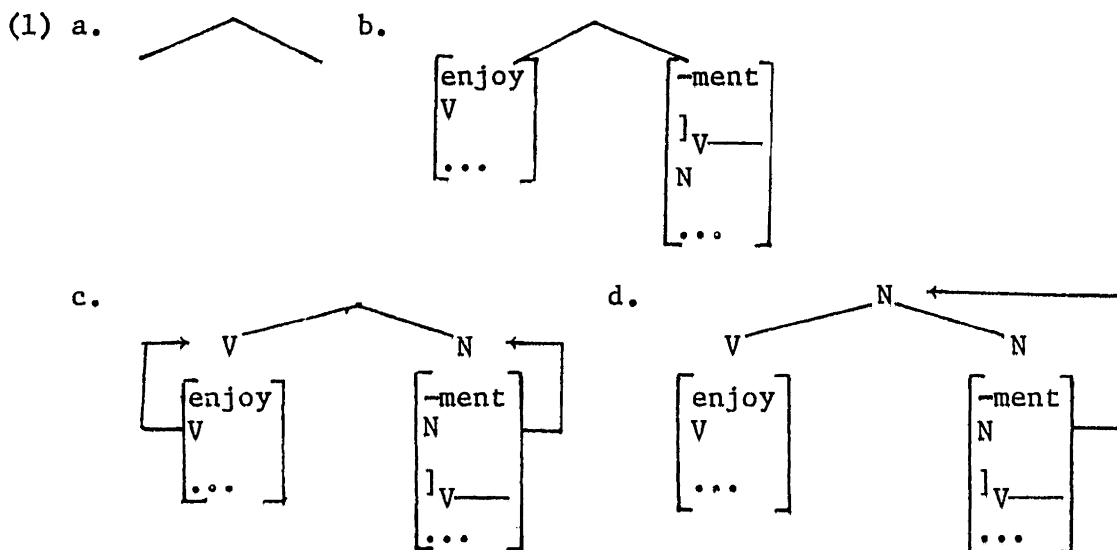

In (1a) we see an unlabelled binary branching word tree. Inserting lexical

items into (1a) respecting the subcategorization feature of the affix, -ment, yields (1b). Lexical items label the nodes immediately dominating them to yield (1c) from (1b). Percolation in accordance with the condition that features of affixes take precedence over features of roots derives (1d) from (1c).

A second percolation convention insures that when an affix is unspecified for the value of some feature, that feature of the root percolates up to become the value of the combination of root plus affix. For example, consider the Russian diminutive suffix, -ushka ~ -ushek. The majority of Russian nouns ending in -a are feminine. However, although they decline like feminine nouns in -a, a few nouns in -a take masculine adjectives, indicating they carry a masculine feature.

- (2) d'ad'a 'uncle'
- a. moj drugoj d'ad'a
my-masc. other-masc. uncle
'my other uncle'
- b. *moja drugaja d'ad'a
my-fem. other-fem. uncle

The variant of the diminutive suffix -ushka attaches to nouns in -a regardless of their gender. When -ushka attaches to a feminine noun in -a, such as baba 'grandmother,' the result, babushka, is feminine; when it attaches to a masculine noun in -a, such as d'ad'a 'uncle,' the result, d'ad'ushka, is masculine.

- (3) a. moj drugoj d'ad'ushka
my-masc. other-masc. uncle-dimin.
- b. moja drugaja babushka
ma-fem, other-fem, grandmother-dimin.
- c. *moja drugaja d'ad'ushka
- d. *moj drugoj babushka

Clearly, the diminutive suffix carries no gender feature of its own. Rather, since the diminutive suffix is unmarked for gender, the gender feature of the root noun percolates up to become the gender feature of the Russian

derived diminutive. The internal structures of the derived diminutives in (3) are displayed in (4).

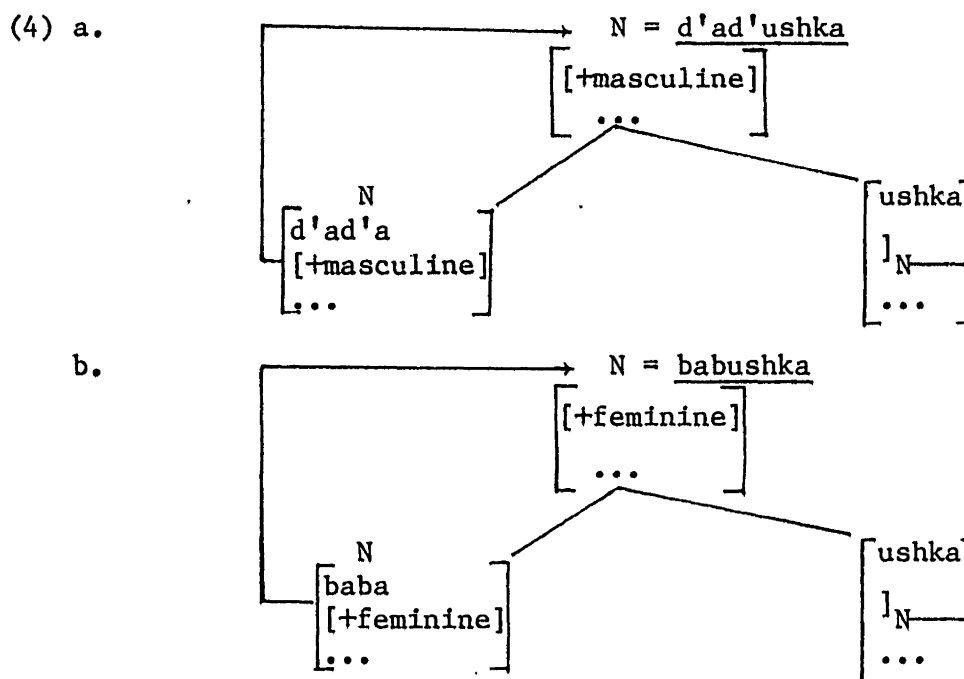

The interpretation of the percolation conventions with regard to the features [\pm Pred SR] and [\pm transitive] is straightforward. A given derived word may have only one value of each feature. If an affix of a derived word is [+Pred SR], for example, since the features of an affix take precedence over the features of a root in percolation, the derived word will be [+Pred SR]; if the affix is [-Pred SR], the derived word will be [-Pred SR] as well. Although there is no simple plus or minus feature for semantic role assignment, the percolation of semantic role assigning features will also operate as one might expect from the percolation conventions. Let us assume that derived words are subject to the same restrictions as simple words. So if a language allows simple words to assign only one semantic role in the unmarked case, it will allow its derived words only one role as well. Since the features of an affix take precedence over the features of a root in feature percolation, if an affix assigns a semantic role, its semantic role

assigning features will percolate to become the semantic role assigning features of a word it derives. In languages that allow words to assign only one role, percolation of the semantic role assigning features of the affix will preclude percolation of the semantic role assigning features of the root. If an affix does not assign a semantic role, of course, the second percolation convention discussed above would allow the semantic role assigning properties of the root to become the properties of the derived word.

The situation surrounding the percolation of argument structures is more complicated. If the affix has an argument structure but the root does not, the argument structure of the affix percolates to become the argument structure of the derived word. Similarly, if the root has an argument structure but the affix lacks one, the root's argument structure becomes the argument structure of the derived word. So much follows directly from the percolation conventions. If both root and affix have argument structures, however, the combination of root and affix in a single word expresses the 1-s relation between a constituent that the root heads (or the root itself) and a constituent that the affix heads (or the affix itself). Thus the argument structure of the derived word is some combination of the argument structures of root and affix. I will discuss many examples of this "merger" of argument structures in section 3.4 of this chapter. At this point, a schematic example of merger will be given to illustrate the principles involved.

Consider an affix, -AF, with a modifier-argument structure as shown in (5).

(5) 'AF' (semantic role₁)

The modifiers produced by the function which AF names modify predicates. Suppose we attach -AF to a verb root, V, which has the P-A structure shown

in (6).

(6) 'V' (semantic role₂)

The combination of -AF and V into a single verb, V-AF, will express the modifier-modifiee relation between the modifiers the 'AF' function produces and the predicates the 'V' function produces. The internal structure of the derived verb, V-AF, is shown in (7).

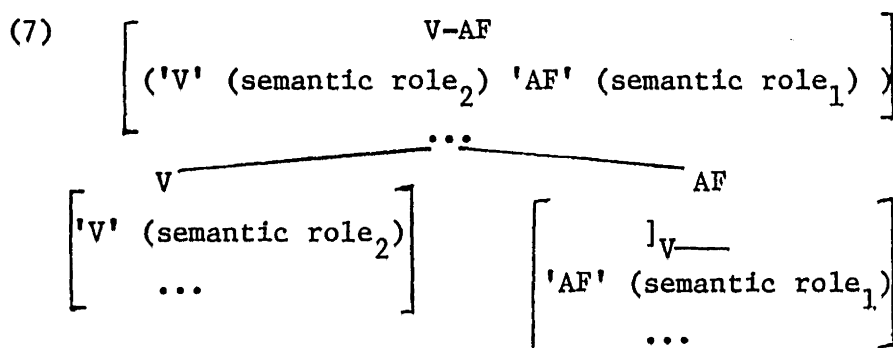

I have represented the combination of argument structures in the feature matrix of the derived verb by placing the argument structures of its constituent parts within parentheses, creating a complex argument structure. This complex argument structure is a predicate-argument structure, i.e., a function from arguments to predicates. Given arguments bearing the semantic roles indicated, the complex predicate-argument structure produces a modifier (using the 'AF' function) and a predicate (using the 'V' function), and applies the modifier to the predicate to yield a predicate.

In the first section of this chapter, I discuss alternations in the expression of a verb's semantic dependents mediated by the affixation of morphemes without argument structures of their own. These include the "passive" and "antipassive" alternations and alternations associated with reflexive verb forms.

Section two of this chapter examines alternations in the expression of a verb's arguments which cannot be mediated by simple affixation. Since

the features of derived words are entirely determined by percolation and/or the combination of argument structures described above, an affixation process could not change the argument structure or semantic role assigning properties of a root. Therefore, if an alternation in the expression of a verb's arguments involves a change in argument structure or semantic role assigning properties, it cannot be simply mediated by affixation. Consider the dative shift alternation illustrated in (8) and the "anticausative" alternation illustrated in (9).

- (8) a. Elmer gave a porcupine to Hortense.
 b. Elmer gave Hortense a porcupine.
 (9) a. Elmer broke the porcupine cage.
 b. The porcupine cage broke.

I will argue that the alternation in (8) is properly seen as an alternation in which semantic role the verb, give, assigns; it assigns the theme role in (8a), the goal role in (8b). If this analysis is correct, no affix could produce the verb in (8b) from the verb in (8a) or the verb in (8a) from the verb in (8b). The predicate produced by the verb break in (9a) assigns the agent role to its logical subject. The break in (9b), on the other hand, has no agentive implications; the cage just broke. Therefore, the predicates produced by the verb in (9b) must not assign an agent role. Since the argument structure of break changes between (9a) and (9b), the verb in (9b) cannot be produced by simple affixation from the verb in (9a). It is argued in section 3.2 that the theory correctly prevents affixation from mediating alternations like those illustrated in (8) and (9). Note, for example, that no overt affix mediates the alternations in English. (A language might place an affix on the verb corresponding to the break in (9b), but this will be a general [-transitive] affix used in other constructions to detransitivize a transitive verb.) Some discussion is devoted to what actually does me-

diate the alternations in (8) and (9) and related alternations.

The next section of this chapter (3.3) will exploit the conclusions of the preceding sections to demonstrate the existence of ergative languages. The theory is shown to predict differences between nominative-accusative and ergative languages related to the constructions discussed in earlier sections. The predictions are confirmed with data from the ergative languages Dyirbal and Central Arctic Eskimo.

Finally, I analyze constructions containing affixes which bear their own argument structures and semantic role assigning features (3.4). I assume the principle in (10).

- (10) Principle: If a lexical item assigns a semantic role or has an argument structure, it is an independent constituent at l-s structure.

Recall that lexical items are inserted from the lexicon into trees generated by the phrase structure rules of a language and that surface structures result from applying Move α to these trees. Since, by the theory of morphology I am adopting, all affixes are attached to roots within the lexicon, derived words are inserted whole into phrase structure trees and appear as units in surface structure. Since an affix and root form a unit in surface structure, an affix which assigns a semantic role or has an argument structure, and therefore appears as an independent constituent in l-s structure, must "merge" with the root to which it attaches somewhere between l-s structure and surface structure. The affix and root may be a single lexical item at s structure, in which case the "merger" is said to take place between l-s and s structure. Or the affix and root may remain separate at s structure, in which case the "merger" takes place between s and surface structure. As an example of merger, consider the Japanese causative construction. As

I argue below, the Japanese causative morpheme -sase has the same predicate-argument structure as the English causative verb, make. In l-s structure, then, the causative morpheme will be an independent constituent taking a propositional logical object. However, the lexical entry for -sase contains the (morphological)subcategorization information that it attaches to verbs to make verbs. Therefore, a single verb consisting of a root plus -sase will be inserted into the phrase structure tree for a Japanese causative sentence. The merger of the causative affix, -sase, with the head verb of its logical object between l-s and surface structure is dictated by the morphology, specifically, by the fact that -sase is a bound morpheme. The present theory does not postulate "transformations" -- like predicate or verb raising or clause union -- in the mapping between l-s and surface structure. The general principles introduced in Chapter Two and the feature percolation conventions discussed above determine the syntax of merger constructions without special statement. However, some additional principles must be introduced to fix the s structure counterpart of l-s constituents in cases of merger.

For each case of merger dictated by the morphology, however, the grammar must decide whether the merger occurs between l-s and s structure or between s and surface structure. As we shall see, this parameter may not be fixed once for all cases of merger, as some causative constructions, for example, will be shown to involve merger between s and surface structure (e.g., the Japanese), while others involve merger between l-s and s structures (e.g., the Malayalam).

In the section on merger constructions I discuss two sorts of affixes carrying independent argument structures. First I analyze affixes with argument structures like those of English prepositions such as for, to and with.

These are the "applied" affixes of the Bantu literature. Given the assumption that the applied affixes carry argument structures like those of prepositions in other languages, the theory correctly predicts the syntax of applied verb constructions. Instrumental applied affixes are given special attention. Otherwise mysterious differences between instrumental applied verb constructions in two languages are shown to follow immediately from the theory on the assumption that the instrumental applied affix merges with the root verb between l-s and s structure in one language but between s and surface structure in the other. Finally, derived causative verbs are examined. If we assume that causative affixes have the semantic and syntactic features of English causative make, the theory predicts the syntax of derived causative constructions crosslinguistically without additional rules or principles. Again, two sets of languages will be compared which differ crucially on the location in the grammar of the merger between the causative affix and the roots to which it attaches.

3.1. Alternations in the expression of a verb's semantic dependents mediated by affixation of morphemes without independent argument structures.

In section 2.4.2. I proved that, within the present theory, the correspondence between l-s and s structure relations is strictly fixed for all l-s relations save $\text{obj}(X, Y)$, where Y is also an argument of X and where there is no merger of l-s constituents at s structure (see the table in (69), Chapter Two).

The various options for the s structure counterpart of the $\text{obj}(X, Y)$ relation, given $\text{arg}(X, Y)$, depend on features of X: If X is [-Pred SR], $\text{obj}(X, Y)$ may correspond to $\text{SUB}(Z, Y')$, where Y' is the s structure counterpart of Y and the s structure counterpart of X heads Z. If X is [+transitive], the $\text{obj}(X, Y)$ relation may correspond to $\text{OBJ}(X', Y')$, where X' and Y' are the s structure

counterparts of X and Y. And if X provides a syntactic role assigner without an argument structure to give the s structure counterpart of Y, Y', a syntactic role, then $\text{obj}(X, Y)$ may correspond to $\text{arg}(X', Z)$, where X' is the s structure counterpart of X and Z is an argument phrase consisting of Y' and the syntactic role assigner provided by X. Suppose affixation is to affect the correspondence between the l-s and s structure relations in a sentence. If the affix neither assigns a semantic role nor takes arguments, it will not be an independent l-s constituent and thus will not merge with an l-s constituent at s structure; the affix will appear on the root to which it attaches at l-s structure. Since the only alternations allowed by the theory in the absence of merger are alternations in the expression of $\text{obj}(X, Y)$ when $\text{arg}(X, Y)$, affixation of a morpheme which is not an independent l-s constituent could only affect the expression of the $\text{obj}(X, Y)$ relation in s structure. It may affect this expression by transferring to X the features described above which determine the possible expression of the $\text{obj}(X, Y)$ relation.

We saw above that a [+Pred SR] verb which assigns a semantic role will be [+transitive] in the unmarked case. If affixation is to allow the logical object of such a verb to correspond to the SUB of the VP the verb heads at s structure, the affix must carry the feature [-Pred SR]. The addition of a [-Pred SR] morpheme (without semantic role assigning features or argument structure) to a verb is called "passivization." If affixation is to force the logical object of a verb to correspond to an object in an argument phrase, the affix must carry the feature [-transitive] and must provide a syntactic role assigner to head the argument phrase. The [-transitive] feature prevents the logical object from corresponding to the OBJ of the verb while the syntactic role assigner is necessary for the reasons

outlined in section 2.4.2.4.3. of Chapter Two. The addition to a verb of a [-transitive] affix which provides a syntactic role assigner to the s structure counterpart of a logical object is called "antipassivization."

Alternations in the expression of a verb's arguments mediated by the affixation of morphemes which are not independent l-s constituents are limited by the theory to alternations in the expression of a verb's logical object as either its OBJ, the SUB of the VP it heads, or an OBJ in an argument phrase which serves as its argument. Productive affixation processes are further restricted by the markedness principles discussed in Chapter Two. Thus even antipassivization is marked in the theory because it produces derived verbs which are [-transitive] although they both assign a semantic role and carry the feature [+Pred SR]. As expected within the theory, antipassivization as defined above is extremely rare crosslinguistically. A theory which postulates relation-changing rules in the syntax or lexicon must add constraints to account for the limited examples of alternations in the expression of a verb's arguments which we actually observe across languages. The present theory, which includes only a general principle governing the mapping of l-s onto s structures, correctly constrains affix-mediated alternations to just those we find in the world's languages.

In sub-sections 3.1.1. and 3.1.2. I discuss passivization and antipassivization in some detail. Among other things, I explain how the difference between languages that display "impersonal passives" and those that do not may be captured by postulating a difference in a single feature between the passive affixes in these languages. I also demonstrate that much of the data accounted for by the "1 Advancement Exclusiveness Law" of Relational Grammar follow from the same principle which accounts for

the restriction of passivization in English to [+transitive] verbs. Subsection 3.1.3. treats lexical reflexive verb forms. I show that the theory demands that lexical reflexivization share essential properties with passivization and thereby explains the crosslinguistic similarities between passive and lexical reflexive verb forms.

3.1.1. Passivization. The structures called "passives" in different languages are a varied lot. I will give here an analysis of English passivization and extend it to passivization crosslinguistically. In effect, I will be defining "passivization." That some construction called a "passive" by some linguist does not fall under my analysis cannot be counted against the analysis unless failing to relate this construction to those I have considered "passives" misses an important generalization.

3.1.1.1. Passivization in English. 3.1.1.1.1. The Passive affix. Quite simply put, English passivization involves the affixation to a verb of the passive morpheme, -en (following usual practice, I use the form, -en, as a cover symbol for the various allomorphs of the passive morpheme). The passive suffix subcategorizes for verbs and carries the features [-Pred SR], [-transitive], and whatever features specify its participle nature. The participle features of passive verbs will be summarized here in the symbol, [+participle].

- (11) -en V, []_V __],
[-Pred SR], [-transitive], [+participle]

A principle to be discussed below will insure that the passive affix attaches only to [+Pred SR], [+transitive] verbs. Since the features of an affix take precedence in percolation over the features of a root, a derived passive verb will be [-Pred SR], [-transitive], [+participle].

Attaching the passive suffix to write derives the verb in (12a), which appears in (12b).

- (12) a. [[writt]_V en]_V, 'write' (written) [-Pred SR], [-transitive],
 [+participle]
 b. Elmer's book was written in twenty days.

As the passive affix lacks an argument structure, the derived passive verb inherits the P-A structure of the active root. Since the passive participles of verbs like write are [-transitive], the logical object of the passive participle cannot correspond to its OBJ in s structure -- the passive participle may not have an OBJ in s structure. As English provides no mechanism for making the s structure counterpart of written's logical object an argument of written (see section 2.4.2.4.3. above) and since the passive participle is [-Pred SR], freeing the SUB of the VP written heads from having to correspond to the logical subject of the predicate written produces, the logical object of written can and, by principle (66) of Chapter Two,² must correspond to the SUB of the VP headed by written. Thus the "promotion" of objects to subjects in passivization is just a natural by-product of principle (66) and the features of a passive participle.

Not only does the analysis of English passivization described above yield the correct results, but it is in fact forced by the theory of the dissertation. We assume that the active and passive forms of an English verb are related by a productive affixation process. Since affixation does not change the argument structure or semantic role assigning properties of a verb, the passive and active forms of a verb should share a P-A structure and should assign the same role(s). To allow the logical object of a [+Pred SR] verb which assigns a semantic role to correspond to the SUB of

the VP it heads, affixation must make the verb [-Pred SR]. If the logical object of a verb may not correspond to its OBJ at s structure, the verb must be [-transitive]. Therefore, if an l-s argument of a verb is to correspond to the OBJ of the active verb but the SUB of the VP headed by the passive verb, then the passive affix must carry the features [-Pred SR], [-transitive].³

Although the English passive morpheme -en attaches only to [+Pred SR], [+transitive] verbs, it is not necessary to include this information in the subcategorization feature of -en in (11). If the passive morpheme attached to [-transitive] verbs, sentences like, It was danced, meaning, 'Someone danced,' would be grammatical (see the discussion of impersonal passivization in section 3.1.1.2. below). It is not clear that there are any [-Pred SR], [+transitive] verbs in English. One candidate for [-Pred SR], [+transitive] status is the verb strike in sentences like (13) (see also section 3.1.1.3. below).

- (13) a. It strikes me as being too hot for porcupines outside.
 b. There strikes him as being too many porcupines in this room.

The strike in (13) may not be passivized, as shown in (14).

- (14) *I was struck by Elmer as selling too many porcupines

The information that -en must attach to [+Pred SR], [+transitive] verbs was omitted from the subcategorization frame in (11) because it follows from a general principle that affixes carrying the α value of certain features may only attach to roots carrying the $-\alpha$ values of these features.

- (15) Principle: For a certain class of features F, an $[\alpha F_1]$ affix may only attach to a $[-\alpha F_1]$ root.

Although the proper characterization of the features F in (15) is problematic, the application of (15) to the passive affix is clear. The features subject to

(15) are features unmotivated by the argument structure or semantic role assigning properties of the affix. If, for example, the passive affix had a P-A structure which produced predicates that assign semantic roles, it would be [+Pred SR] by virtue of its inherent properties. The [+Pred SR] feature of the affix would be motivated by its argument structure and thus not governed by (15). Since the passive affix has no argument structure and assigns no semantic role, its [-Pred SR] and [-transitive] features are unmotivated and thereby subject to (15). So principle (15) restricts the English passive morpheme to attach to [+Pred SR], [+transitive] verbs.

Principle (15) might be seen as a principle against "vacuous affixation." Some principle is needed, for example, to prevent the past participle affix from attaching to a past participle. Since the past participle already has the features of the past participle affix, affixation of this affix to a past participle adds nothing but phonological features to the participle -- it is "vacuous" in all but its phonological effects. Principle (15) is intended to be the principle which prevents affixation of "grammatical" affixes like past participle endings to words which already contain these affixes.

3.1.1.1.2. The by phrase. If the semantic role which a predicate assigns is born by no constituent in the passive sentence, as in (16), the bearer of that role is interpreted as being an indefinite someone or something.

(16) The porcupine was sold for twenty dollars.

As made explicit by Fodor and Fodor (1980), the indefinite interpretation of the bearer of the logical subject role in passives exactly parallels the interpretation of the bearer of any inherent semantic role of a verb not

mentioned in the sentence. For example, I have assumed that the source (or "seller") role is inherently associated with the verb, buy. If we do not express the source of buy in a sentence, the bearer of this role is interpreted as someone or someplace unspecified -- see (17).

(17) Elmer bought the porcupine yesterday.

Similarly, the bearer of the inherent agent or "seller" role associated with sell is interpreted as someone indefinite in sentence (16). Fodor and Fodor (1980) present arguments that this indefinite interpretation of unexpressed bearers of inherent semantic roles must be distinguished from the explicit binding of these roles to the quantifiers someone or something (see also Dowty, 1981a).⁴

Although the bearer of the logical subject role in a passive sentence need not be expressed, it may appear in a prepositional phrase headed by by. The simple fact is that the object in a by prepositional phrase within a VP headed by a passive participle bears the semantic role assigned by the predicate that the passive participle produces. Although there may be isolated examples of passive participles which cannot co-occur with by phrases, suggesting that by can only assign certain semantic roles, one can give no semantic characterization of the semantic roles born by the object of by. One finds objects of by bearing the full range of semantic roles carried by logical subjects in English. These roles include agents (Hortense was pushed by Elmer), experiencers (Elmer was seen by everyone who entered), themes (The intersection was approached by five cars at once), recipients or goals (The porcupine crate was received by Elmer), and various roles which seem to fit none of the classes I have seen defined in the literature (The house is surrounded by trees). This point bears repeating since it is often over-

looked: No semantic characterization of the objects of by as "agents" save one which defines agents as those roles assigned by predicates, i.e., as the roles born by logical subjects, can account for the semantic range of the by objects in passive constructions.

So it is a fact about by that its object may bear the semantic roles assigned by predicates. This fact must be captured in an adequate account of the semantics of by. Consider the l-s structure of the passive in (18), given in (19).

(18) Elmer was insulted by Hortense.

(19)

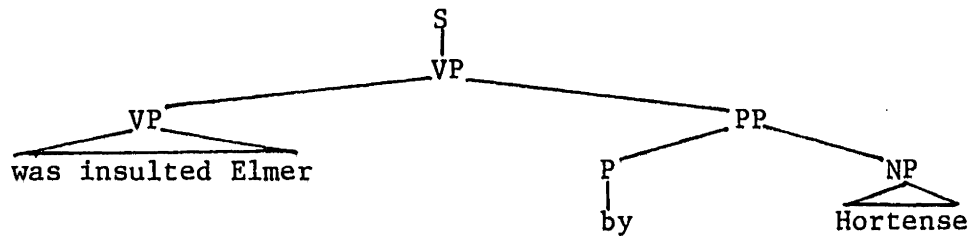

The predicate was insulted Elmer in (19) is a function from arguments to propositions. The preposition by creates a modifier, the PP by Hortense in (19), which is a function from predicates to degenerate predicates, i.e., to predicates which are functions from no arguments to propositions. The predicate was insulted Elmer may be represented as the open sentence (x insulted Elmer). The preposition by performs a special task in English. It assigns to its logical object the semantic role assigned by the predicate which the modifier it produces modifies. So in (19) by assigns to Hortense the role assigned by was insulted Elmer, which the modifier by Hortense modifies. The modifiers by produces modify predicates by applying the predicates to by's logical object, creating a proposition which is identified as a degenerate predicate. In (19) by applies the predicate was insulted Elmer to its logical object, Hortense, effectively substituting Hortense for

the free variable in the predicate, to produce the proposition or degenerate predicate (Hortense insult Elmer). To repeat, by heads a predicate modifier consisting of itself and its logical object. The modifier by heads modifies a predicate P. by assigns to its logical object the semantic role that P assigns then applies the predicate P to its logical object to create a degenerate predicate.⁵

One might ask why by appears only in passive sentences like (20a) and not in active sentences like (20b).

- (20) a. The porcupine was sold by the last porcupine salesman in Boston
 b. *Elmer sold the porcupine by the last porcupine salesman in Boston. (Ungrammatical with the reading that the porcupine salesman sold the porcupine).

Recall that the modifiers produced by by modify predicates to yield degenerate predicates, i.e., predicates which are functions from no arguments to a proposition. Suppose we add a by phrase to a predicate headed by a [+Pred SR] verb, as in (20b). Since it takes no arguments, the (degenerate) predicate the by phrase produces may not be sister to a logical subject. Yet the [+Pred SR] feature on the verb which heads the predicate that the by phrase modifies demands that the verb head a predicate which is sister to a logical subject. Thus we cannot add a by phrase to a predicate headed by a [+Pred SR] verb in the 1-s structure of a well-formed sentence.⁶

3.1.1.1.3. Passivization of raising verbs. When we attach the passive ending to a raising to object verb like believe, whose (raising) lexical entry is shown in (21a), we derive the passive participle in (21b). Compare believed in (21b) with seem, whose lexical entry is displayed in (21c). (The (propositional) logical objects of the verbs in (21) are connected to [[S,VP] ___] to indicate that [S,VP] is provided to assign a syntactic role to the s structure counterparts of these logical objects --

subject -- see Marantz 1981b for details),⁷ and such an analysis was subsequently adopted explicitly by Chomsky (1980b, 1981). It is difficult to argue against other analyses of passivization within alternate theoretical frameworks since these analyses may be the best available within the frameworks and may be made to work. The most popular alternate analysis of passivization, supported by Relational Grammarians among others, insists that passivization involves the explicit promotion of objects to subject. Within the present theory, allowing a rule that explicitly associates a logical object with a grammatical subject, for example, would increase the power of our theoretical mechanisms, forcing us to ask why the grammar employs this stipulated association of l-s and s structure relations and not other conceivable ones. In addition to these theoretical considerations, there are some data which lead us to reject the promotion analysis of passivization within the framework of this dissertation. These same data call into question a promotion analysis in any theoretical framework.

Recall that the logical object of a verb must correspond to the SUB of the VP its passive participle heads in most cases because passive participles must head-Govern the s structure counterparts of their logical objects but are [-transitive] and introduce no syntactic role assigner to make the s structure counterpart of the logical object into a grammatical argument. If some rule of English provided passive participles with such a syntactic role assigner, then their logical objects would not have to "promote" to SUB to satisfy principle (66). In fact, we were led to assume for the analysis of raising constructions that English allows the structural position [S, VP] to assign a syntactic role and provides this syntactic role assigner to any argument-taking item. Since, as we saw in

Chapter Two, the OBJ of a structural position corresponds to a constituent which appears in this position in surface structure, the OBJ of [S, VP] must naturally be an S. Since sentential logical objects of passive participles may correspond to arguments in argument phrases headed by [S, VP], such sentential objects need not promote in passive constructions, as shown in (23c) (this fact was pointed out in the course of similar argument in Williams, 1979).

- (23) a. I believe that Elmer sold his last porcupine.
 b. That Elmer sold his last porcupine was believed by everyone.
 c. It was believed that Elmer sold his last porcupine.

The lexical entry for believed in (23c) is shown in (24), where the [[S, VP] ___] connected to the logical object semantic role indicates that [S, VP] assigns a syntactic role to the s structure counterpart of the logical object.

- (24) [[believe]_v ed]_v, 'believe' (believed), [-Pred SR], [-transitive],
 [+participle] [[S, VP] ___]

When no l-s constituent corresponds to the grammatical subject of an s structure clause, English provides a dummy NP, it, to serve as SUB, as in (23c).

The argument against the promotion analysis of passivization derives from the behavior of verbs which allow only the (23a,c) members of the pattern in (23); that is, the s structure counterpart of their l-s logical objects seems never to promote to SUB.

- (25) a. I feel that Elmer should sell his last porcupine.
 b. ???That Elmer should sell his last porcupine was felt by everyone who saw the condition of his pet shop.
 c. It was felt that Elmer should sell his last porcupine.

- (26) a. I reasoned that Elmer could sell ten porcupines a week.
 b. ???That Elmer could sell ten porcupines a week was reasoned by the accounting firm of Hummer, Hummer, Hummer, and Fred.

- c. It was reasoned that Elmer could sell ten porcupines a week during an economic recovery.
- (27)
- a. I said that Elmer had the best porcupines in the business.
 - b. ???That Elmer had the best porcupines in the business was said around the financial district.
 - c. It was said that Elmer has the best porcupines in the business.

In the present theory, the ungrammaticality of (25-27b), as compared with the grammaticality of (23b),⁸ is explained by the mechanism which accounts for another peculiar property of feel, reason, and say: In their meanings in (25-27), these verbs do not take NP objects.

- (28)
- a. *I reasoned the outcome of that situation.
 - b. *I felt Elmer's obligation to sell his last porcupine.
(Ungrammatical with the meaning, 'I felt Elmer was obliged to sell his last porcupine.)
 - c. *I said the announcement in a loud voice.

I propose to capture the fact that feel, reason, and say take only sentential complements in certain usages in the same manner that one would account for unusually or "quirky" case-marked constituents in Icelandic (see Levin, 1981). I have discussed quirky case marking in Icelandic in a different connection above -- see section 2.5.2. For present purposes, the important aspects of the phenomenon are these: A quirky case-marked object in Icelandic retains its quirky case marking in passivization and raising. That is, the quirky case marking -- say dative -- which appears on the surface structure counterpart of the logical object of a transitive verb shows up on the constituent bearing the logical object semantic role in passive and raising constructions. So, if the OBJ of the active verb is unexpectedly marked dative (the usual object marking is accusative), the SUB of the corresponding passive will be marked dative, as will be the OBJ of a raising to object verb which embeds this passive sentence or the SUB of a raising

to subject verb embedding this sentence. This "case preservation" effect is illustrated in (29a-d) from Levin (1981) (see also (89-92), Chapter Two,

- (29) a. Ég hjálpa honum
I help him-Dative
- b. Honum er hjálpad
He-Dative is helped
- c. Ég tel honum hafa verið hjálpad
I believe him-Dative to-have been helped
- d. Honum er talið hafa verið hjálpad
He-Dative is believed to-have been helped

The case preservation effect and related phenomena demonstrate that the quirky case markings in Icelandic are associated not with grammatical relations but directly with semantic roles (see Levin 1981). No matter what grammatical relation the constituent assigned the "helped" role in (29) bears, it must appear in the dative case. Moreover, the quirky case markings play no role in the sentence other than to mark the constituent which bears the semantic role with which they are associated; in particular, as explained in section 2.5.2., they assign neither semantic nor syntactic roles. Just as the semantic roles of quirky case marked objects in Icelandic seem exceptionally connected with their quirky cases, so the propositional logical object of verbs like feel, reason, and say seem to be exceptionally connected with the structural position [S, VP]. Regardless of the grammatical relation (OBJ or argument) born by the constituent assigned the logical object semantic role, the logical object of these verbs will appear in the surface structure position [S, VP]. Following the notation of Levin (1981), I will connect the "quirky case marking," i.e., the structural position, [S, VP], to the semantic roles assigned by feel, reason, and say with a double line.

- b. It stinks that Elmer should be allowed a tax deduction on porcupine depreciation.
- c. That Elmer arrived late for dinner proved his point about the tardiness of pet dealers
- d. It proved his point about pet dealers that Elmer arrived late for dinner.

In general, sentential complements -- i.e., sentential logical objects corresponding to constituents within the syntactic verb phrase -- but not extraposed subjects -- i.e., postverbal sentences bearing the logical subject role -- may appear without the that complementizer and may permit extraction (wh-movement) from within.

- (32) a. Elmer believed porcupines mate in the spring.
- b. Who did Elmer believe (that) Hortense likes most?
- c. Elmer claimed porcupines mate in the spring.
- d. What did Elmer claim (that) Hortense did with her spare time?
- (33) a. *It stinks Elmer should be allowed a tax break like that.
- b. *Who did it prove his point that Elmer knew?
- c. *What did it stink that Elmer bought?

The postverbal sentential complements of (25-27c) behave like the complements in (32), not like the extraposed subjects in (33).

- (34) a. It was felt Elmer could do a lot better in aardvarks.
- b. It was reasoned Elmer could sell ten porcupines a week in an economic recovery.
- c. It was said Elmer was overstepping his authority.
- d. What was it felt (that) Elmer could afford to buy with his porcupine proceeds?
- e. How many porcupines was it reasoned (that) Elmer could sell in a week?
- f. What was it said (that) Elmer could do with his extra merchandise?

In fact, the postverbal sentential complements of the passive participles of all verbs taking sentential objects behave like the sentential complements in (32) and not like the extraposed subjects in (33), suggesting that these complements need not be promoted to subject then extraposed.

- (35) a. It was believed Elmer could save porcupines from extinction.
- b. It was claimed Elmer sold puce porcupines after hours.

- c. What was it believed (that) Elmer could sell instead of porcupines?
- d. How many porcupines was it claimed (that) Elmer gave to the poor?

Another piece of evidence against the promotion analysis of the passives in (25-27c) can be derived from the generalization in English that [-Pred SR] verbs taking sentential complements are raising verbs. Let us assume that English obeys this generalization because it provides the feature [+R] to any [-Pred SR] verb. Assume further that sentential subject extraposition, whatever its proper analysis, does not involve making a verb [-Pred SR] but rather involves the exceptional expression of a logical subject as an S of VP ([S, VP]). We can now explain why the passive participles of verbs taking sentential objects raise to subject while mere sentential subject extraposers do not raise. The passive participles of the verbs which take sentential complements in (36), being [-Pred SR], receive the feature [+R] in accordance with the generalization about English that [-Pred SR] verbs raise. The sentential subject extraposers in (37), being [+Pred SR], do not receive the feature [+R] and so do not raise.

- (36) a. Elmer was felt to have overstepped his authority in this matter.
- b. Elmer was reasoned to be able to sell ten porcupines a week in an economic recovery.
- c. Elmer was said to sell imported porcupines below cost.
- (37) a. *Elmer proved his point about pet owners to have arrived late.
- b. *Elmer stinks to have said that at the party.

Since the active versions of (36) are ungrammatical -- see (38) -- some special account of why the passive participles of verbs which take sentential complements raise to SUB must be given in any theoretical framework.

- (38) a. *I felt Elmer to have overstepped his authority in this matter.
 b. *I reasoned Elmer to be able to sell ten porcupines a week in an economic recovery.
 c. *They said Elmer to sell imported porcupines below cost.

Whatever mechanism decides that the passive participles of feel, reason, and say will raise to subject, it must be able to distinguish these verbs as a class from the sentential subject extraposers like stink. If these passive participles were analyzed as obligatory sentential subject extraposers, as required on a promotion analysis of passivization, it would be difficult to explain why just these verbs but not sentential subject extraposers in general allow raising to SUB.¹⁰

3.1.1.2. Passivization crosslinguistically. We may define passivization as the addition to a verb of an affix without argument structure or semantic role assigning properties which carries the feature [-Pred SR]. In Marantz (1981b) I argue that the English passive suffix attaches only to [+transitive] verbs and that the restriction on passivization to transitive verbs is not uncommon among the world's languages. We saw above that principle (15) allows us to account for this restriction on passivization in English by giving the English passive morpheme the feature [-transitive]. There are languages in which the passive affix may attach to [-transitive] verbs. Since it prohibits an affix with an "unmotivated" [-transitive] feature from attaching to a [-transitive] verb, principle (15) demands that the passive morpheme in these languages not carry the feature [-transitive]. Suppose we attach a passive affix carrying only the feature [-Pred SR] to a [+Pred SR], [-transitive] verb root. Such affixation would prevent the predicates which the derived passive verb produces from taking a logical subject, thereby freeing the SUB of the VP the verb heads at s structure

from having to correspond to the logical subject. A verb root which is [+Pred SR], [-transitive] will, in the unmarked case, not assign a semantic role, i.e., will not take a logical object. Since only l-s subjects and objects may correspond to s structure SUBs, the grammatical subject of the passive of our [+Pred SR], [-transitive] verb root will correspond to no l-s constituent. The passivization of a [+Pred SR], [-transitive] verb yields what has been called an "impersonal passive" in the literature.

Impersonal passivization in Dutch has been discussed in Perlmutter (1978) and Comrie (1977). We suppose that the passive affix in Dutch carries only the feature [-Pred SR] (and the features of a participle), allowing it to attach to [-transitive] verbs. Affixation of the passive morpheme to the intransitive verb fluiten 'to whistle,' whose lexical entry appears in (39a) yields the passive participle, gefloten, whose lexical entry appears in (39b).

- (39) a. fluiten, V, 'whistle' (\emptyset), [+Pred SR], [-transitive]
 b. gefloten, V, 'whistle' (\emptyset), [-Pred SR], [-transitive],
 [+participle]

Since an l-s structure proposition headed by the passive participle in (39b) will contain neither a logical subject nor a logical object to correspond to the syntactic SUB of the corresponding S in s structure, Dutch employs a dummy SUB, er, where independent rules of grammar demand an overt grammatical subject -- see sentence (40b). Note that the preposition door in Dutch serves the same function that by serves in English (see 3.1.1.1.2. above for discussion of by).

- (40) a. De jongens floten
 'The boys whistled'
 b. Er werd door de jongens gefloten
 it was by the boys whistled-PASS
 'The boys whistled' ('It was whistled by the boys')

Sentence (40b) illustrates the impersonal passive construction. Again, the characteristic feature of this construction is that the SUB is not the s structure counterpart of a constituent bearing an l-s relation.

If we attach the passive morpheme to a [+transitive] verb in Dutch, feature percolation would yield a [-Pred SR], [+transitive] derived passive verb. However, we saw in Chapter Two that [-Pred SR] verbs are [-transitive] in most if not all clear cases. It was suggested that the implication in (41) may be universal (but see sections 3.1.1.3. and 3.3.2. below).

(41) [-Pred SR] → [-transitive]

Suspending a decision on the status of (41) in universal grammar, we may hypothesize that (41) operates as a redundancy rule in the Dutch lexicon, changing the [+transitive] feature of the passive participles of [+transitive] Dutch verbs to [-transitive]. Passivization of verwoesten 'to destroy,' whose lexical entry is shown in (42), yields the passive participle, verwoest, whose lexical entry is shown in (43).

(42) verwoesten, V, 'destroy' (destroyed), [+Pred SR], [+transitive]

(43) verwoest, V, 'destroy' (destroyed), [-Pred SR], [-transitive]
[+participle]

Although the Dutch passive affix does not carry the feature [-transitive], implication (41) provides the verb in (43) with this feature. As the passive participle of verwoesten is [-transitive], its logical object cannot correspond to its OBJ at s structure; instead, the s structure counterpart of its logical object becomes the SUB of the VP headed by the passive verb, as shown in (44b).

- (44) a. De soldaten verwoesteen de huizen
 'The soldiers destroyed the houses'
 b. De huizen werden door de soldaten verwoest.
 the houses were by the soldiers destroyed
 'The houses were destroyed by the soldiers'

If (41) always provides the feature [-transitive] to the passives of [+transitive] verbs, then no language should exhibit impersonal passives of transitive verbs. The issue of whether universal grammar allows impersonal passives of transitive verbs has been debated in a different guise by Perlmutter (1978), Perlmutter and Postal (1980), and Comrie (1977). Perlmutter and Postal take the position that, in our terms, a passive verb will not be [+transitive] and that, therefore, impersonal passivization is restricted to intransitives, while Comrie claims that some languages exhibit [+transitive] passive verbs. The reader is directed to the cited articles for the evidence, arguments, and counterarguments on each side of the issue.

Because, in the present framework, the passive morpheme is merely a carrier of the feature [-Pred SR], we might expect to find the passive morpheme employed in constructions other than canonical passives which involve preventing a predicate from assigning a semantic role or preventing a verb from assigning a syntactic role. It turns out that the passive morpheme in some languages is used in non-passive constructions in which a predicate must be prevented from assigning a semantic role to a logical subject in l-s structure, freeing the grammatical SUB of the s structure counterpart of the predicate from having to correspond to the logical subject. For example, consider the use of the Japanese passive morpheme, -rare, in what has been called the "indirect" or "adversity" passive in the literature (see, e.g., the papers in Shibatani, 1976c). In (45b) we see a straightforward Japanese passive sentence corresponding to the active sentence in (45a). The Japanese passive morpheme, -rare, carries the feature [-Pred SR] and, since Japanese lacks impersonal passives, the feature

[-transitive]. The dative case marking, ni, serves the same function in Japanese passives as by serves in English, assigning the semantic roles of the predicates with which it is associated.

- (45) a. Sensei wa John o sikar-ta.
 teacher TOP John ACC scold-PAST
 'The teacher scolded John.'
 b. John wa sensei ni sikar-are-ta
 John TOP teacher DAT scold-PASS-PAST
 'John was scolded by the teacher.'

The subjects of the verbs suffixed with -rare in (46), unlike the subject (also the topic) in (45b), do not bear the logical object semantic role but rather are interpreted as persons adversely affected by what the rest of the sentence describes.

- (46) a. Taroo ga doroboo ni zitensya o nusumareru.
 Taro NOM thief DAT bike ACC steal-PASS
 'A thief steals his bike, and Taro is adversely affected.'
 b. John ga ame ni hurareta.
 John NOM rain DAT fall-PASS-PAST
 'It rained, and John was adversely affected'
 (or, 'John was rained on')
 c. Hanako wa musuko ni sin-are-ta
 Hanako TOP son DAT die-PASS-PAST
 'Her son died, and Hanako was adversely affected.'

Note that the passives in (46) have no active counterparts. If we place the verbs in (46) in sentences without the passive morpheme, the SUBS of the sentences bear the logical subject role and the OBJ, if the verbs are transitive, bear the logical object role. No constituent bears the role of the person adversely affected by what the sentence describes.

- (47) a. Doroboo ga zitensya o nusum-ru
 Thief NOM bike ACC steal-PRES
 'A thief steals a bike'
 b. *Doroboo ga zitensya o Taroo o/ni nusum-ru
 thief NOM bike ACC taro ACC/DAT steal-PRES
 c. Ame ga hur-ta.
 rain NOM fall-PAST
 'It rained.'

- d. *Ame ga John o hur-ta
rain NOM John ACC fall-PAST
- e. Musuko ga sin-ta.
son NOM die-PAST
'A son died.'
- f. *Musuko ga Hanako o sin-ta.
son NOM Hanako ACC die-PAST.

From sentences (47) we may conclude that it is the passive morpheme in (46) which signals the presence of a constituent bearing a semantic role -- person adversely affected -- in addition to those inherently associated with the verb.

The important thing to note here about sentences (46) is that the syntactic SUB does not bear the semantic role assigned by the 1-s counterpart of the VP; rather, it bears the added adversity role. Recall that if the verbs marked -rare in (46) were [+Pred SR], the logical subjects of the predicates they yield would necessarily correspond to the grammatical SUBs of the s structure counterparts of the predicates.¹¹ Therefore, the verbs in (46) must be [-Pred SR]. That they are [-Pred SR] accounts for the appearance in adversity passive sentences of a ni marked NP bearing the logical subject semantic role. The dative case marking ni, as mentioned above, serves the same function in Japanese as by serves in English. We saw above why a "by phrase" is incompatible with a predicate headed by a [+Pred SR] verb. The present theory would claim that the passive morpheme -rare in (46) carries the feature [-Pred SR] just as it does in the "true" passive sentence (45b). The passive morpheme is used in the adversity passive constructions precisely to indicate that the verbs in these constructions are [-Pred SR].

Since the SUBs in (46) do not bear the semantic role of the logical subject, we must ask what assigns these constituents their adversely af-

affected roles. A full account of the adversity passive would take us far off the track here. It would require exploring adversity and benefactive constructions in other languages and delving deep into the particulars of Japanese syntax (see Marantz 1981a for the beginnings of an account of Japanese grammar within the current framework). In place of a complete analysis of the Japanese adversity passive, let me reiterate that, according to our theory, the verbs marked with -rare in (46) must be [-Pred SR] and that the passive morphology is used in (46) to carry this [-Pred SR] feature.

There is a construction in Chichewa, Bantu language described in Trithart (1977), which resembles the adversity passive of Japanese in many interesting respects. The combination of passive and causative morphology on the Chichewa verb can indicate that an NP bearing the instrument semantic role appears as the syntactic SUB of the verb. In (48b,d) I display some "true" Chichewa passives, containing the passive morpheme, -dw-. Note that the preposition ndí serves the same function in Chichewa that by serves in English.

- (48) a. Jóni a-ná-(zí-)nyamul-a n-thóchí
 John_i he_i-PAST-(them_j)-carry-INDIC bananas_j
 'John carried the bananas.'
- b. N-thóchí zi-ná-(zí-)nyamul-idw-a ndí Joni
 bananas_i they_i-PAST-(them_i-)carry-PASS-INDIC by John
 'The bananas were carried by John.'
- c. Jóni a-ná-(zí-)pats-a n-thóchí kwá á-máí á-hé
 John_i he_i-PAST-(them_j-)give-INDIC bananas_j to mother his
 'John gave the bananas to his mother.'
- d. N-thóchí zi-ná-(zí-)pats-idw-a kwá a-máí á-ké ndí Jóni
 bananas_i they_i-PAST-(them_i-)give-PASS-INDIC to mother his by
 John
 'The bananas were given by John to his mother.'

In (49) we find some causative constructions, to be discussed in 3.4.2. below.

Note the causative morpheme, -ts-.

- (49) a. \acute{M} -phúnzitsi a-ná-(wá-)lemb-ets-a á-ná.
 teacher_i he_i-PAST-(them_j-)write-CAUSE-INDIC children_j
 'The teacher made the children write.'
- b. Cátherine a-ná-(má-)kolol-ets-a mw-áná wá-ké chí-manga.
 Catherine_i she_i-PAST-(him_j-)harvest-CAUSE-INDIC child_j her
 corn
 'Catherine made her child harvest the corn.'

(50) is an example of the instrumental construction under consideration.

The verb in (50) is marked with both the passive affix, -dw-, and the causative affix, -ts-, but the syntactic SUB of the sentence is interpreted as an instrument, not as a 'causer' or as the logical object.

- (50) Khásu lí-ma-(lí-)lím-its-ídw-a chí-manga ndí Jóni
 hoe_i it_i-HABIT-(it_i-)farm-CAUSE-INDIC corn_j by John
 'The hoe is used by John to farm corn with.'

Like the Japanese adversity passives in (46), the "passive" in (50) has no active counterpart. A verb marked with the causative morpheme alone, as in (49), can only be used in a causative construction. It cannot be used to indicate that an NP bearing the instrument role appears somewhere in the sentence -- see (51). The causative reading of (51) is blocked by a restriction in Chichewa that 'causees' be animate.

- (51) *Jóni á-ma(yi-)lemb-éts-a pēni
 John_i he_i-HABIT-(it_j-)write-CAUSE-INDIC pen_j
 'John writes with a pen.'

Sentence (51) is ungrammatical because only the causative and passive morphemes together signal the instrumental construction.

In (50), as in the Japanese adversity passive constructions, the verb must be [-Pred SR] to prevent the syntactic subject from bearing the semantic role of the logical subject of the predicate the verb produces. As in Japanese, the Chichewa passive morpheme carries the feature [-Pred SR] even when it appears in constructions other than simple passives like

(48b,d). The passive morphology in (50) semantically vacates the subject position of a sentence headed by the passive verb, allowing this position to be occupied by a constituent bearing some semantic role other than that of the logical subject. A more complete analysis of the Chichewa instrumental construction illustrated in (50) will be given in section 3.4.1.2. below.

3.1.1.3. The 1 Advancement Exclusiveness Law. One of the most interesting findings of Relational Grammar has been the set of restrictions on passivization and impersonal passivization accounted for within the theory by the "1 Advancement Exclusiveness Law" (or LAEX; a "1" is a subject in Relational Grammar). In Relational Grammar, all passivization processes promote ("advance") an object to subject. Impersonal passivization is analyzed as the promotion of a dummy object to subject. The LAEX (see Perlmutter 1978, Perlmutter and Postal 1978a, 1980) states, in effect, that there may only be one advancement to subject per clause (the reader should consult the cited sources for an exact formulation of the law). Perlmutter (1978) shows how the LAEX and the "unaccusative hypothesis" -- basically the hypothesis that languages include unaccusative argument-taking items, which were discussed in 2.2. above -- explains the ungrammaticality of certain impersonal passives in Dutch and Turkish. Perlmutter and Postal (1978a) discuss several other applications of the LAEX, in particular, the role of the LAEX in explaining the crosslinguistic ungrammaticality of double passivization within the same clause and the apparent impossibility of passivizing certain subclasses of English verbs in some constructions (see below). In this section I demonstrate that some of the predictions of the LAEX follow directly from the present theory without further statement.

The remaining data accounted for by the LAEX within Relational Grammar are handled by the theory given what seems to be a general principle governing morphological processes. The data associated with the LAEX provide strong support for the present theory. What requires a special rule or stipulation in Relational Grammar falls out of general principles in the framework of this dissertation.¹²

Consider first cases of what Perlmutter and Postal (1978a) call "sporadic advancements to 1" (=subject). Within Relational Grammar, sentences like (52) are associated with a relational network in which a constituent which bears an initial "impure" grammatical relation, something like "means" in (52a) and "time" in (52b), advances to become the final subject of the sentence. These are called "sporadic advancements" because no general rule in English sanctions the advancement to subject of such impure relations. Compare sentences (52) with those in (53). In (53), the constituents which advance to subject in (52) still bear the initial impure grammatical relations assigned to them by an assumed universal initial assignment of grammatical to semantic relations.

- (52) a. Ten dollars buys this porcupine.
 b. 1979 found the country at the brink of economic disaster.

- (53) a. A kind-hearted person may buy this porcupine for ten dollars.
 b. We found the country at the brink of economic disaster in 1979.

In Relational Grammar every constituent bearing a given semantic role will be assigned the same initial grammatical relation. Because of this assumed universal connection between semantic and grammatical relations, if one knows the semantic relations associated with a verb, the initial grammatical relations born by its grammatical dependents are fixed. Since ten dollars in (52,53a) and 1979 in (52,53b) are assumed to bear the same semantic relation in both sentences in which they appear, they must bear the same

initial grammatical relation in both sentences, i.e., the impure means and time relations respectively. Because the subjects in the relational networks associated with sentences (52) have advanced to subject, i.e., are not initial subjects, the LAEX prevents the objects in these networks from advancing to subject in turn, explaining the ungrammaticality of sentences like (54).

- (54) a. *This porcupine {is bought, may be bought} by ten dollars.
 b. *The country was found on the brink of economic disaster by 1979.

On the other hand, the LAEX permits the promotion of the object to subject in the relational networks associated with (53), in which the subjects are initial subjects -- see sentences (55).

- (55) a. This porcupine may be bought by a kind-hearted person for ten dollars.
 b. The country was found by us in 1979 at the brink of economic disaster.

The present theory explains the ungrammaticality of (54) if we make some reasonable assumptions about the predicate-argument structures of the verbs these sentences contain. Suppose we assume that the P-A structures of buy in (52,53a) and of find in (52,53b) are identical or closely related. In particular, the predicates produced by buy in (52,53a) and by find in (52,53b) will be assumed to assign the same semantic role. Since we know English generally has predicates assign agent roles -- see section 2.2. above -- the predicates in (52,53a) should assign the "buyer" role (more properly, the "buyer of this porcupine for ten dollars" role), those in (52,53b) the "finder" role. However, the subject in (52a) is not the "buyer" and that in (52b) is not the "finder." Therefore, the verbs in (52) must be [-Pred SR]; otherwise, the SUBs in these sentences would bear the semantic roles assigned by the predicates. If the subjects in (52),

- (58) a. bought, V, 'buy' (bought, means) [-Pred SR], [-transitive],
[+participle]
b. found, V, 'find' (found, time), [-Pred SR], [-transitive],
[+participle]

It should be clear that the verbs in (58) could not be the passive participles in (54). First, by assigns the roles assigned by the predicates with which it is associated. The predicates produced by the verbs in (58) assign the "buyer" and "finder" roles, not the means and time roles as required for (54). Even if we delete the by phrases in (54), the resulting sentences, given in (59) below, could not contain the passive participles in (58).

- (59) a. This porcupine may be bought.
b. The country was found on the brink of economic disaster.

The passive verbs in (58) will have two logical objects at l-s structure. One may satisfy principle (66), Chapter Two, by corresponding to the SUB of the VP the passive verb heads at s structure. Since the passive verb is [-transitive] -- takes no OBJs -- the other logical object of the passive verbs in (58) must violate principle (66). Sentences (59) are grammatical, but they contain the passive participles of the verbs in (53), not the passive participles of the verbs in (52).

So even if we could construct passive participles from the verbs in (52), they could not occur in grammatical sentences. But, since the verbs in (52) are [-Pred SR] -- see (56) -- principle (15) prevents us from attaching the [-Pred SR] passive affix to them. Thus, not only are the passives of the verbs in (52) prohibited from appearing in a grammatical sentence, the passive participles of these verbs, given in (58), are themselves ill-formed.

The reader should verify that, as long as we assume that the predi-

cates in (52a,b) do not assign the "means" and "time" roles respectively, i.e., that the SUBs in (52) do not correspond to logical subjects, the present theory will predict the ungrammaticality of sentences (54). These cases of "sporadic advancement" deserve more attention and a fuller analysis than has been provided here, but even a superficial account of sentences (52) explains the ungrammaticality of the passives in (54) without recourse to special rules.

Perlmutter (1978) explains how the LAEX predicts the ungrammaticality of impersonal passives of unaccusative verbs and confirms this prediction with data from Dutch and Turkish. Recall that unaccusative verbs are analyzed within Relational Grammar as verbs which take initial objects but no initial subject. The class of unaccusative verbs is identifiable in Relational Grammar through the assumed universal initial assignment of grammatical to semantic relations. If a verb is associated with the sort of semantic relation which is assigned the grammatical object relation but not with the sort assigned the grammatical subject relation, the verb will have an initial object but no initial subject and will thereby qualify as unaccusative. Impersonal passivization involves inserting a dummy as the object of a clause and advancing the dummy to subject. Since the objects of unaccusative verbs advance to subject, the LAEX prohibits the additional advancement of a dummy to subject of an unaccusative verb, preventing impersonal passivization of unaccusative verbs (I am leaving out some assumptions of Relational Grammar which help make this analysis go through; see Perlmutter 1978 for details). Employing semantic criteria to identify unaccusative verbs in Dutch, Perlmutter (1978) demonstrates the impossibility of impersonal passivization with Dutch unaccusative verbs. In (60), from Perlmutter (1978), we see ungrammatical impersonal passives of verbs

Perlmutter has identified as unaccusative.

- (60) a. In dit weeshuis groeien de kinderen erg snel
'In this orphanage the children grow very fast.'
- b. *In dit weeshuis wordt er door de kinderen erg snel gegroeid.
in this orphanage is it by the children very fast grown
'It is grown very fast by the children in this orphanage.'
- c. De bloemen waren binnen een paar dagen verflenst.
'The flowers had wilted in a few days.'
- d. *Er werd door de bloemen binnen een paar dagen verflenst.¹³
it was by the flowers in a few days wilted

Compare (60) with the grammatical impersonal passives of "unergative" verbs in (61).

- (61) a. Er wordt hier door de jonge lui veel gedanst.
'It was danced here a lot by the young people.'
- b. Hier wordt (er) veel gewert.
'It is worked here a lot'

Within the current theory, unaccusative verbs are those whose P-A structure produce predicates which assign no semantic roles, i.e., verbs which are inherently [-Pred SR]. Unlike Perlmutter and Postal, I assume no universal rules for arranging the semantic roles of a verb into P-A structures, rules which would be the equivalent in the present framework to Relational Grammar's universal initial assignment of grammatical to semantic relations. I shall provide extensive evidence against any such universal arrangement of P-A structures below (see section 3.3. on ergativity). Although the organization of semantic roles into P-A structures not universally fixed, as mentioned in section 2.2. above, each language will contain generalizations about which roles its predicates will assign, which roles its verbs will assign, etc. Assuming that Dutch incorporates generalizations similar to those described above for English, having its predicates assign agent roles and its verbs assign theme and patient roles, we would analyze the verbs Perlmutter identifies as unaccusative as in-

herently [-Pred SR]. So a verb like groeien 'grow' in (60a) would have the lexical entry shown in (62).

(62) groeien, V, 'grow' (grower) [-Pred SR], [-transitive]

If we attached the Dutch passive morpheme, assumed to carry the features [-Pred SR], [+participle] (see the discussion of impersonal passivization above), to groeien, we would derive a verb with the lexical entry in (63):

(63) gegroeid, V, 'grow' (grower) [-Pred SR], [-transitive], [+participle]

The verbs in (62) and (63) differ only in that (63) is a participle. We would not expect the passive participle (63) to appear in sentences like (60b) since door, like by, assigns the semantic role of a predicate and, since unaccusative verbs are [-Pred SR], the predicate in (60b) (and (60d)) does not assign a semantic role. Rather, we would expect the passives of unaccusative verbs like groeien to appear in sentences like (64), differing from the active sentences (60a,c) only in containing a passive participle.¹⁴

- (64) a. *In dit weeshuis werden de kinderen erg snel gegroeid.
 b. *De bloemen werden binnen een paar dagen verflenst.

In the present framework then, the impossibility of creating impersonal passives with unaccusative verbs is evidenced by sentences like (64), not by sentences like (60b,d), and it is the ungrammaticality of (64) which needs explaining.

Principle (15), introduced above to account for the restriction on English passivization to transitive verbs, automatically prevents the formation of the passive participle in (63). The passive affix in Dutch, carrying the "unmotivated" feature [-Pred SR], may not attach to the [-Pred SR] unaccusative verbs. In preventing the passivization of unaccusative verbs, principle (15) clearly exhibits its nature as a constraint against vacuous affixation. As one can see by comparing (62) a (63), the only

difference between an unaccusative verb and its (ill-formed) passive participle is that the passive participle is a participle.

It should be noted here that if we viewed passivization as a process changing a [+Pred SR] verb into a [-Pred SR] verb and if we viewed passive morphology as a flag or marker of this process, the impossibility of passivizing unaccusative verbs would follow immediately: One would not find passive morphology on inherently [-Pred SR] verbs because it is impossible for such verbs to undergo the process of changing from [+Pred SR] to [-Pred SR]. However, the only "processes" associated with passivization in the present framework are the mechanisms of word formation described above. Thus I am committed to explaining the ungrammaticality of passives of unaccusative verbs with a condition on word formation. If the proposed constraint (15) against "vacuous" affixation proves untenable, the process view of passivization would gain support.

In summary, the 1 Advancement Exclusiveness Law of Relational Grammar reduces within the current theory to a constraint that an affix carrying an unmotivated [-Pred SR] feature cannot attach to a [-Pred SR] root. I argued that this constraint is a reflection of a broader principle governing affixation, principle (15).

3.1.2. Antipassivization. An affix carrying the feature [-transitive] but not the feature [-Pred SR] will attach to a [+Pred SR], [+transitive] verb to create a [+Pred SR], [-transitive] derived verb. The logical object of this derived verb may not correspond to its OBJ at s structure because the derived verb, being [-transitive], may not take an OBJ. Since the derived verb is [+Pred SR], the predicate it produces will be sister to a logical subject, which must correspond to the SUB of the VP the verb heads at s structure. So the verb's logical object is prevented from cor-

responding to a SUB. To satisfy principle (66), Chapter Two, then, the logical object of the [+Pred SR], [-transitive] derived verb must correspond to a grammatical argument of the verb at s structure, more properly to an OBJ in an argument phrase which bears the argument relation with respect to the verb at s structure (see section 2.4.2.4.3. above). As remarked in Chapter Two, for a logical object of a verb to correspond to an argument in an argument phrase, a syntactic role assigner without an argument structure must be provided at s structure to head this argument phrase and assign the OBJ its syntactic role. "Antipassivization" is the affixation to a verb of a [-transitive] morpheme unmarked for [+Pred SR] which has no argument structure or semantic role assigning properties and which carries a syntactic role assigner without argument structure to assign a syntactic role to the s structure counterpart of the logical object of the verb to which it attaches.

Note that antipassivization creates verbs which are "marked" in two respects. First, it was pointed out in Chapter Two that a [+Pred SR] verb which assigns a semantic role is [+transitive] in the unmarked case. Antipassivization produces [+Pred SR] verbs assigning semantic roles which are [-transitive]. Second, the explicit stipulation of the correspondence between l-s and s structure relations is quite literally marked -- it must be exceptionally noted in a lexical entry of an argument-taking item. In the unmarked case no mention of the s structure counterparts of a verb's l-s dependents need appear in the verb's lexical entry. Antipassivization produces verbs which explicitly link a logical object to the OBJ in an argument phrase whose head is also stipulated in the verbs' lexical entries. Since antipassivization is marked within the current theory, the theory leads us to expect to find antipassivization in fewer languages than passi-

vization, which produces completely unmarked verbs. In fact, antipassivization as defined above is extremely rare among the world's languages.¹⁵

The one clear example of antipassivization in the literature is found in Greenlandic Eskimo (see, e.g., Woodbury, 1977a). I will argue in section 3.3.3. below that Greenlandic is a nominative-accusative language with ergative ("type B") case marking. Basically, this classification means that Greenlandic shares generalizations (42) of 2.2, with English -- its verbs canonically assign theme and patient roles; its predicates canonically assign agent roles -- but SUBs of [-transitive] verbs and OBJs of [+transitive] verbs are case marked the same, in contrast to the case marking on SUBs of [+transitive] verbs (see section 3.2. below for further explanation of what it means to be a nominative-accusative language with type B case marking).

A transitive Greenlandic verb (in a main clause) agrees with both the grammatical subject and the grammatical object. The subject of such a matrix verb appears in the ergative (also called the genitive) case, while the OBJ appears in the absolutive (unmarked) case. A simple transitive Greenlandic sentence is found in (65) (the orthography is that of Woodbury 1977a).

- (65) Aᅇut-ip arnaq-∅ taku-vaa.
 man-ERG woman-ABS see-IND3sg3sg
 'The man saw the woman'

An intransitive Greenlandic verb agrees with one constituent, the subject, which appears in the absolutive case.

- (66) Aᅇut-∅ autlar-puq.
 man-ABS go away-IND3sg.
 'The man went away'

The Greenlandic passive suffix -tau- carries the features [-Pred SR],

[-transitive]. A range of case endings plays the role by plays in English passives, marking the "displaced subject" of a Greenlandic passive. One such case is the ablative, whose use is illustrated in (67). Compare the passive in (67) with its active counterpart in (65).

- (67) Arnaq-∅ aquti-mit taku-tau-puq.
 woman-ABS man-ABL see-PASS-IND3sg.
 'The woman was seen by the man'

Passivization makes taku- 'see' [-transitive]. The logical object of taku-, arnaq- 'woman,' corresponds to the SUB of the VP taku-tau- 'see-PASS' heads at s structure and thus appears in the absolutive case and triggers verb agreement. The "displaced subject" of the predicate, taku-tau-puq arnaq 'see-PASS woman' appears in the ablative case in (67).

The antipassive construction is illustrated in (68b).

- (68) a. Aqut-ip miirqa-t paar-ai
 man-ERG child-PL(ABS) take care of-IND3sg3pl
 'The man takes care of the children.'
 b. Aqut-∅ miirqu-nik paar-ṣ̌i-vuq.
 man-ABS children-INST take care of-ANTIPASS-IND3sg
 'The man takes care of children'

The lexical entry of the active verb in (68a) is given in (69).

- (69) paar-, V, 'take care of' (patient), [+Pred SR], [+transitive]

The antipassive morpheme in Greenlandic is -ṣ̌i-. Antipassivization of (69) yields (70).

- (70) paar-ṣ̌i-, V, 'take care of' (patient) [+Pred SR], [-transitive]
 [INST]

Since the antipassive verb in (70) is [+Pred SR], the logical subject of the predicate paar-ṣ̌i- heads, aqut- 'man,' in (68b), will correspond to the SUB of the VP it heads at s structure and thus will appear in the absolutive case and trigger verb agreement on the derived intransitive verb -- see (68b). The antipassive suffix -ṣ̌i-, in addition to the [-transitive] feature, must

provide a syntactic role assigner for the s structure counterpart of the antipassive verb's logical object. The suffix -ši- provides the instrumental case as a syntactic role assigner -- see (70). In accordance with the specification in (70), the logical object of paar-ši- 'take care of-ANTIPASS' satisfies principle (66), Chapter Two, by corresponding to the OBJ of instrumenta' case in an argument phrase serving as argument to paar-ši- at s structure. The l-s and s structures for the antipassive in (68b) are displayed in (71a) and (71b) respectively.

(71) a.

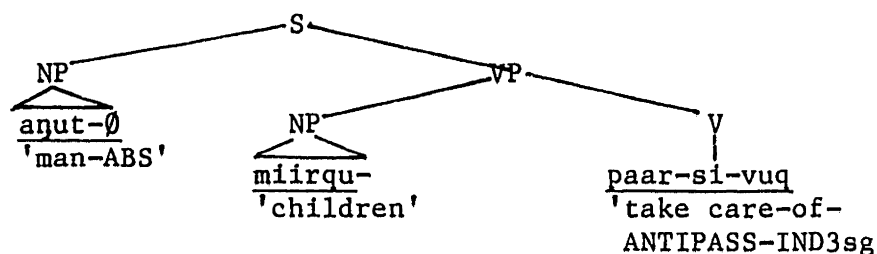

b.

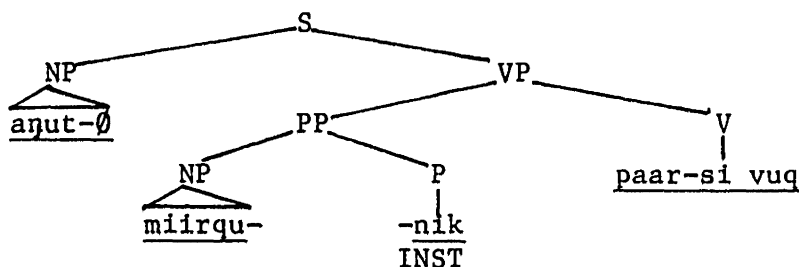

3.1.3. Lexical Reflexivization. Many languages have special intransitive verb forms with reflexive meaning. For example, Albanian transitive verbs have intransitive counterparts, with their own inflectional paradigm, which are interpreted as reflexive (Hubbard 1979). Compare the Albanian transitive verb laj 'wash' in (72a) with the corresponding intransitive verb lahem 'wash' in (72b) (the citation form of an Albanian verb is the 1st person singular present indicative).

(72) a. Agimi lan veten.
 Agim wash-3sg self
 'Agim washed himself'

- b. Agimi lahet.
 Agim wash-3sg
 'Agim washes himself'

The subject of the reflexive verb form, Agimi in (72b), is interpreted as bearing the semantic roles born by both the subject and object of its transitive counterpart. While Agimi is the washer and veten 'self' the washed argument in (72a), Agimi is interpreted as both the washer and washed in (72b).

Languages employ a variety of morphological devices to create reflexive verb forms. In Albanian there is no consistent morphological relationship between the reflexive and non-reflexive forms of a verb which spans the entire inflectional paradigm. Some languages simply employ a general intransitive version of a verb as the reflexive. Recall that Greenlandic Eskimo transitive verbs agree with both subject and object while intransitive verbs agree with the subject alone (see section 3.1.2. above; Greenlandic reflexives will be discussed in section 3.3.3. below). Attaching intransitive agreement suffixes to a logically transitive verb usually yields a reflexive verb in Greenlandic, as shown in (73) from Sadock (1980).

- (73) Piniartoq toquppoq.
 hunter-ABS kill-IND3sg
 'The hunter killed himself'

Dyirbal, an Australian Aboriginal language whose lexical reflexive forms will be discussed in section 3.3.3. below, uses a morpheme with the properties of a standard derivational affix to form reflexive from non-reflexive verb roots.

Many languages add a clitic to a verb to derive the reflexive form. Examples of clitic-formed lexical reflexives from French and Russian are found in (74) and (75).

(74) French: Les enfants se lavent maintenant.
 'The children are washing themselves now'

(75) Russian: Deti mojuts'a teper'.
 'The children are washing themselves now.'

The French reflexive verb is formed with a preverbal reflexive clitic, se in our example. The Russian reflexive is derived with the postverbal clitic -s'a. I am using morphological criteria to identify the French and Russian reflexive morphemes as clitics; they appear outside derivational and inflectional morphology.

Regardless of the particular morphological means a language uses to relate the reflexive and non-reflexive forms of a verb, if we assume that the relationship is mediated by affixation, the present theory permits only two analyses of lexical reflexive verbs like those in (72b) and (73-75). On one analysis the reflexive affix is an s structure OBJ of the root verb. This first analysis amounts to treating the reflexive affix as one would treat pronominal object clitics in a language like French, and may therefore be dubbed the "clitic analysis." The second or "non-clitic analysis" of reflexives requires that the reflexive verb be [-transitive]. Although the theory allows these two analyses, in languages in which one can argue for one or the other, the non-clitic analysis always proves correct. Even French, which employs pronominal object clitics which look just like the reflexive morpheme, shows clear evidence that the non-clitic analysis is appropriate for its reflexive verb forms. Below I shall review an argument of Grimshaw (1981) that, while verbs with preverbal object clitics are [+transitive], verbs with the reflexive clitics are [-transitive]. The theory of this dissertation demands the non-clitic analysis for [-transitive] reflexive verbs. After presenting the two analyses of lexical reflexive verbs using the Albanian reflexive as an example, I will return

to the problem of why languages seem invariably to choose the non-clitic analysis.

If non-reflexive and reflexive verbs like Albanian laj, lahem 'wash' in (72) are to be related by affixation, they must share a P-A structure, presumably that in (76).

(76) laj, lahem 'wash' (patient)

Note that Agimi in (72b) is interpreted as bearing both the agent (washer) and patient (washed) roles. However, principle (32) of Chapter Two, which prevents an l-s constituent from receiving two semantic roles, prohibits Agimi from serving as both the logical subject and logical object in the l-s structure of (72b). There are two possibilities to consider then: Either Agimi is the logical object of lahem 'wash' in (72b) or Agimi is the logical subject of the predicate lahem produces. As we shall see, if Agimi is the logical object, the theory demands the non-clitic analysis of the lexical reflexive verb; if Agimi is the logical subject, the theory demands the clitic analysis.

Consider first the case in which Agimi serves as logical object to lahem in (72b). Since Agimi is the SUB of (72b) and the logical object of a verb only corresponds to the SUB of the VP it heads if the verb is [-Pred SR], the lexical reflexive lahem must be [-Pred SR]. Since in Albanian the logical object of the reflexive verb may not correspond to its OBJ, lahem must also be [-transitive]. We may conclude that the lexical reflexive verb, like the passive, is [-Pred SR], [-transitive]. Since reflexive verbs are derived from [+Pred SR], [+transitive] verbs, like laj 'wash' in (72a), via affixation, the reflexive affix, "REFL," must carry the features [-Pred SR], [-transitive].¹⁶

By identifying Agimi as the logical object of lahem 'wash' in (72b), we have accounted for the interpretation of the subject of the reflexive verb as the patient. What remains to be explained is how Agimi is also interpreted as the agent of the reflexive verb. Since the agent role may not be assigned to Agimi directly at l-s structure without violating the principle that a given l-s constituent receive only one semantic role, the agent role must be assigned to some constituent which is interpreted as coreferent with Agimi, i.e., to some reflexive element which picks up Agimi as its antecedent. But where is the reflexive element in (72b)? We are assuming that the reflexive verb form is derived from an active transitive verb via affixation. We determined above that the reflexive affix "REFL" must carry the features [-Pred SR], [-transitive]. Although it is impossible to point out any piece of the reflexive Albanian verb as REFL throughout most of the inflectional paradigm (but see (89b) below), our assumptions force us to postulate the existence of such a morpheme. It is the affix carrying the features [-Pred SR], [-transitive] on the reflexive verb which is assigned the logical subject semantic role in a reflexive sentence like (72b). More properly, REFL must carry the features of a reflexive pronoun, and these features are assigned the logical subject role.

In addition to carrying the features [-Pred SR], [-transitive] and the features of a reflexive pronoun, the reflexive affix REFL must, on this non-clitic analysis, insure that its reflexive pronoun features are assigned the semantic role of the logical subject of the sentences headed by the reflexive verb. REFL may accomplish this by carrying the semantic role assigning features and modifier-argument structure of English by. Features of REFL, as a modifier creator, will form a modifier M with REFL's

reflexive pronoun features as shown in (77) below. REFL's modifier-producing features, like the preposition by, assign to the reflexive pronoun features the role assigned by the predicate the modifier M modifies -- VP₂ in our example. The modifier-producing features then apply the predicate (VP₂) to the reflexive pronoun to derive a degenerate predicate, VP₁ in (77). The proposed l-s structure for (72b) on the non-clitic analysis of reflexives is shown in (77).

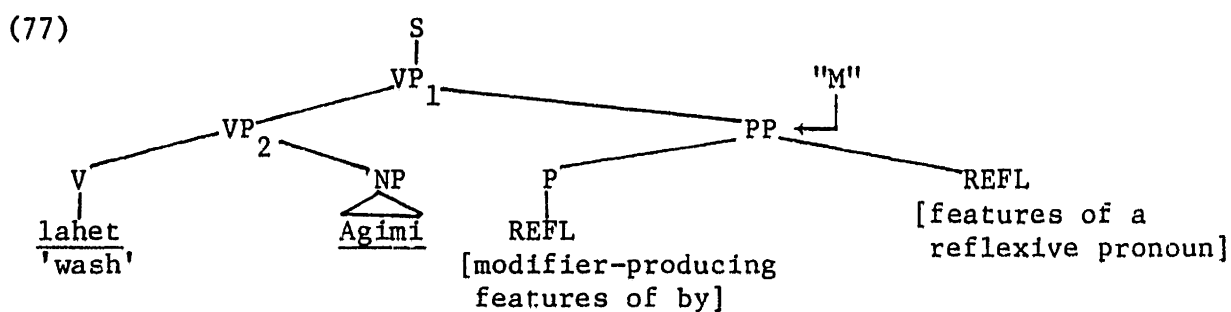

The model of grammar I have been assuming in this dissertation states that antecedent-anaphor relations are established (or checked) at s structure, i.e., that the "binding theory" discussed in Chapter Two section 2.6.1. applies at s structure. For the reasons given in the introduction to this chapter, an affix and root verb must appear as a single constituent in surface structure. So the reflexive affix REFL, being an affix, must appear in the reflexive verb in the surface structure of (72b) and therefore must merge with the root verb between l-s and surface structure. As remarked in the introduction to this chapter, merger of independent l-s constituents may take place either between l-s and s structure or between s and surface structure. So lahet and REFL in (77) may in principle form a single s structure constituent, or two s structure constituents but a single surface structure constituent. However, if REFL merges with the root verb at s structure, its reflexive pronoun features could not conform to the binding theory (102) of 2.6.1. and the antecedent-anaphor relation between REFL's

reflexive pronoun features and the SUB of the reflexive verb could not be properly established. Therefore, lahet and REFL must remain distinct at s structure and the s structure corresponding to (77) should look something like (78).

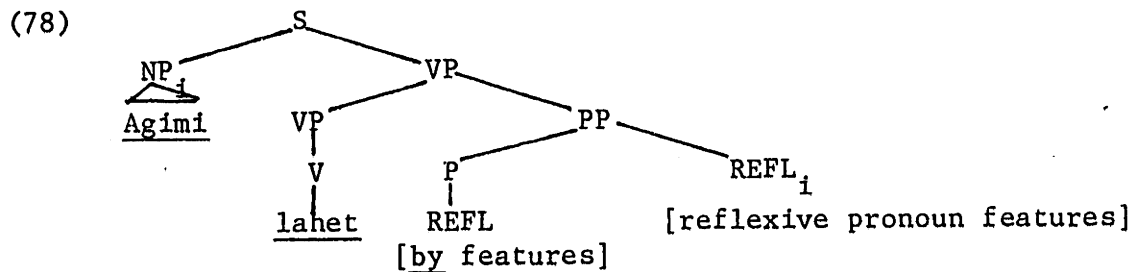

The REFL affix and root verb merge at surface structure, expressing the modifier-modifiee relation between the PP and lower VP in (78), to yield the surface structure in (79).

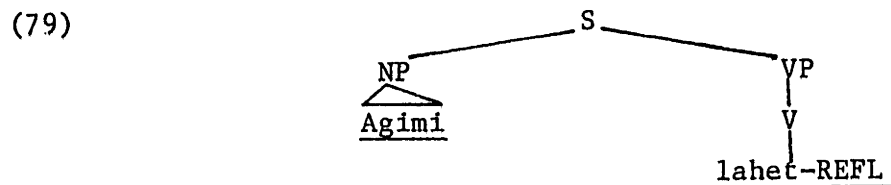

To review the non-clitic analysis of lexical reflexives: The reflexive affix REFL carries the features [-Pred SR], [-transitive] plus the modifier-producing features of English by and the features of a reflexive pronoun. The by features of REFL assign to the reflexive pronoun features the logical subject semantic role. The SUB of the reflexive verb serves as antecedent for REFL's reflexive pronoun features at s structure, and the root verb and REFL merge at surface structure.

To implement the non-clitic analysis of lexical reflexives, we must give the reflexive affix REFL a lexical entry something like (80).

- (80) REFL, []_v __, V, [-Pred SR], [-transitive]; 'by' (reflexive-pronoun-features), [+transitive].

Aside from its morphological subcategorization and category specifications,

the REFL affix carries two bundles of features. The first bundle consists of the features [-Pred SR], [-transitive]. We must assume that these features are not associated with the argument structure or semantic role assigning properties of REFL and that therefore the first bundle of features merges with the root verb at l-s structure, just like the [-Pred SR], [-transitive] features of the passive affix. The second feature bundle contains the by and reflexive pronoun features of REFL. Associated with the argument structure of by in (80) is the feature [+transitive]. REFL may carry both the feature [-transitive] and the feature [+transitive] since the first feature belongs to a bundle which merges with the root verb at l-s structure while the second belongs to a feature bundle which remains distinct from the root verb until surface structure, i.e., until after s structure, at which level the [+transitive] feature is relevant. I have indicated in (80) that REFL has the argument structure and semantic role assigning properties of English by and that REFL's reflexive pronoun features serve as logical object and argument of REFL's by features. Since the by features of REFL carry the [+transitive] feature, the reflexive pronoun features may serve as the by features' OBJ at s structure -- see (78) above. On the non-clitic analysis of lexical reflexivization, then, REFL is a discontinuous morpheme at l-s structure. One piece of REFL is identical to the passive morpheme and merges with the root verb at l-s structure; the second piece forms a predicate modifier consisting of an element with the features of English by and its logical object, which has the features of a reflexive pronoun. This second piece of REFL does not merge with the root verb until surface structure.

The theory demands the non-clitic analysis of lexical reflexives on the assumption that the SUB of the VP that the lexical reflexive verb heads

corresponds to its logical object. Suppose now that the verb's SUB corresponds to the logical subject of the predicate it produces; i.e., that Agimi in (72b) is the logical subject of the sentence at l-s structure. Since Agimi is interpreted as the patient of washing as well as the agent but cannot be assigned both roles at l-s structure, the verb in (72b) must assign the patient role to some constituent which is interpreted as coreferent with Agimi. Since the only constituent available to serve this function in (72b) is the reflexive affix REFL, REFL must bear the features of a reflexive pronoun and serve as logical object to the lexical reflexive verb, as shown in the l-s structure for (72b) given in (81).

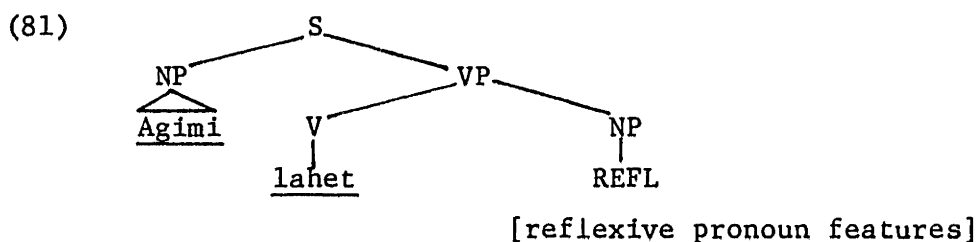

Recall that the binding theory, which establishes antecedent-anaphor relations, applies at s structure. In order for Agimi to bind the reflexive pronoun features of REFL in (72b), REFL and lahet must remain separate s structure constituents. If REFL is a distinct constituent at s structure, it must be head-Governed by lahet to satisfy principle (66), Chapter Two. Since lahet is [+Pred SR], REFL must be the OBJ of lahet at s structure and lahet must be [+transitive]. The s structure corresponding to (81) is given in (82).

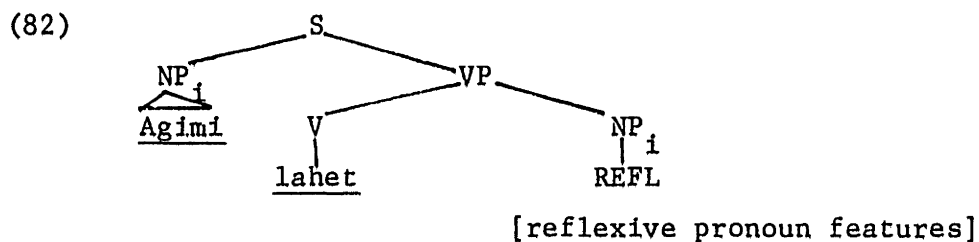

The surface structure of (72b) on the clitic analysis of lexical reflexives is identical to the surface structure on the non-clitic analysis, that shown in (79) above. On the clitic analysis, the merger of the root verb and REFL at surface structure expresses the OBJ relation between these constituents.

Although the theory in principle allows two analyses of reflexive verbs, the clitic and non-clitic analyses, all the languages I have examined show evidence that they employ the non-clitic analysis. Recall that one major difference between the two analyses is whether or not the reflexive verb is [+transitive]; the reflexive is [-transitive] on the non-clitic analysis but [+transitive] on the clitic analysis. Grimshaw (1981) presents data from French to show that the French reflexive verb is [-transitive]. Evidence for the non-clitic analysis of French, Russian, Albanian, and Icelandic reflexives will be presented below. The question remains why languages do not choose the clitic analysis of reflexive verbs left open by the theory of grammar.

One answer to this question which we may reject is that the theory should rule out the clitic analysis of reflexives in principle. An analysis parallel to the clitic analysis of reflexives is required for non-reflexive pronominal object clitics in languages like French. As Grimshaw (1981) shows, French verbs with non-reflexive object clitics, unlike reflexive verbs, behave like [+transitive] verbs. One of Grimshaw's arguments derives from the behaviour of French verbs embedded under the causative verb faire. In (83a) we see a French verb preceded by a pronominal object clitic; (83b) contains a parallel reflexive verb form.

- (83) a, Jean l'a tué.
 John OBJ-clitic 'PAST kill
 'John killed him.'

- b. Jean s'est tué.
 John REFL'PAST kill
 'John killed himself'

When clauses are embedded under the French causative faire 'make,' the logical subject of the embedded clause generally appears either as a bare NP complement to the embedded verb, as in (84a), or in a prepositional phrase headed by à, as in (84b) (examples from Grimshaw 1981; see the references in her bibliography for a more complete description of French causative constructions). Although there are complications unrelated to the present argument, the generalization governing the choice of expression for the lower subject in French causative constructions with faire is that the embedded subject appears as an unmarked complement when the head of the embedded clause is [-transitive] but is preceded by à when the head verb is [+transitive].

- (84) a. J'ai fait partir {Jean, *à Jean} .
 I'PAST make leave {John, at John}
 'I made John leave.'
 b. Il fera boire un peu de vin {à son enfant, *son enfant}.
 He make-FUT drink a little of wine {at his child, his child}
 'He will make his child drink a little wine'

Although a verb with a pronominal object clitic behaves like a transitive verb in the causative construction -- compare (85a) with (84), a reflexive verb behaves like an intransitive when embedded under faire -- see (85b).

- (85) a. La crainte du scandale l'a fait tuer {au juge, *le juge}.
 'Fear of scandal made the judge kill him.'
 b. La crainte du scandale a fait se tuer {le frère du juge,
 *au frère du juge}.
 'Fear of scandal made the brother of the judge kill himself.'

The behaviour of non-reflexive preverbal object clitics in French indicates that they should be treated as OBJs of transitive verbs, i.e., that verbs with object clitics must be analyzed essentially as we analyzed reflexive verbs on the clitic analysis.

Although the theory must allow the clitic analysis of lexical reflexives in principle, apparently there is some principle which leads speakers to hypothesize the non-clitic analysis of reflexive verbs first, choosing the clitic analysis only in the face of data inconsistent with the non-clitic analysis. The tendency to hypothesize the non-clitic analysis is strong enough to cause French speakers to employ this analysis even when reflexive verbs look identical to verbs with preverbal object clitics, where these latter verbs require a "clitic analysis." Reflexive verb forms in many languages, including Russian and Icelandic (to be discussed below), derive historically from combinations of verb plus an independent reflexive pronominal element. Some principle causes these combinations to be reanalyzed as combinations of verb plus a [-Pred SR], [-transitive], i.e., non-clitic REFL affix. Although I could speculate on what this principle might be, I have no evidence for any of my speculations and will leave the problem of the preference for the non-clitic analysis of reflexives as a topic for future research.

The present non-clitic analysis of lexical reflexive verbs should be contrasted with the non-clitic analysis usually found in the literature. Since the subject of intransitive lahem 'wash' in (72b), repeated here as (86), bears the patient role, the usual approach to a lexical reflexive like lahem has been to assume that the patient role of its transitive counterpart is somehow absorbed into the semantics of the reflexive verb.

(86) Agimi lahet.
'Agim washes himself.'

So instead of assigning the "washer" (or "washer of patient-NP") role to its subject, as does the predicate produced by transitive laj 'wash,' the predicate produced by intransitive lahem would assign the "self-washer"

role. This analysis of lexical reflexives could be implemented within the present theory by postulating some lexical rule of reflexive verb formation which takes the P-A structure of laj in (87a) and yields that shown for lahem in (87b).

(87) a. laj 'wash' (patient) → b. lahem 'self-wash' (∅)

The predicate produced by the P-A structure in (87b) would assign the "self-washer" role to subject. Since it changes the P-A structure and semantic role assigning properties of a verb, the operation schematized in (87) could not be mediated by affixation in the present theory, which does not even contain the machinery necessary to state the operation in (87) as a rule. The non-clitic analysis of reflexive verbs forced by the present theory is the mirror-image of the usual analyses schematized in (87). Instead of absorbing the semantic role of the logical object into the verb, we are, in essence, absorbing the semantic role of the logical subject -- the reflexive affix bears this role and attaches to the verb.

Since the non-clitic analysis of reflexives is forced by the present theory, evidence in favor of the analysis should be considered support for the theory over theories which allow any but the clitic and non-clitic analyses described in detail above. I will present here two pieces of striking evidence which confirm the non-clitic analysis of reflexives, particularly in contrast with the non-clitic analysis schematized in (87) above; see section 3.3. on ergativity for further support. The first piece of evidence for the analysis of reflexive verbs just given comes from the well-known fact that, in many languages, the lexical reflexive verb form is homophonous with the passive verb form. For example, the Albanian reflexive sentence (72b), repeated here as (88), has a passive as well as a reflexive interpretation. Consider also the sentences in (89),

which are ambiguous between reflexive and passive readings.

- (88) Agimi lahet.
 Agim wash-REFL-3sg
 'Agim washes himself' or 'Agim is washed'
- (89) a. I burgosuri lahet dy herë në javë.
 the prisoner wash-REFL-3sg two times in week
 'The prisoner washes himself twice a week.'
 'The prisoner is washed twice a week.'
- b. Prostitutat u veshen përpara darkës.
 the prostitutes REFL dress before dinner-the
 'The prostitutes were dressed before dinner'
 'The prostitutes dressed themselves before dinner'

In (89b), the REFL affix shows up as the preverbal clitic, u. The form veshen means 'they dressed (transitive)' while u veshen means 'they were dressed' or 'they dressed themselves.'¹⁷

The present theory leads us to expect a homophony between reflexive and passive verb forms because the reflexive affix carries the same features carried by the passive affix, i.e., [-Pred SR], [-transitive]. Of course, the reflexive morpheme also carries features which dictate the assignment of the logical subject semantic role. A single morpheme may serve for both the reflexive and passive affixes in a language like Albanian if the features dealing with the assignment of the logical subject role are made optional in the lexical entry of the reflexive/passive affix, as shown in (90).

- (90) reflexive/passive morpheme: [-Pred SR], [-transitive];
 ('by' (reflexive-pronoun-features), [+transitive])

The homophony between lexical reflexive and passive verb forms illustrated in Albanian above is widespread crosslinguistically, appearing in French (see, e.g., Grimshaw 1980),¹⁸ Eskimo (see section 3.3.3. below), Dyirbal (see Dixon 1972 and 3.3.3. below), and Lardil (Klokeid 1976), among other languages. Note that the non-clitic analysis of lexical reflexive formation

as the absorption into the semantics of a verb of the logical object semantic role offers no immediate explanation for the widespread homophony between lexical reflexive and passive verb forms. This homophony is also a mystery on any clitic analysis of reflexives.

Icelandic reflexive verbs provide further support for the present non-clitic analysis of lexical reflexivization, particularly over the hypothesis that reflexivization involves the absorption of the logical object semantic role into the reflexive verb. Consider a raising to object verb in Icelandic such as telja 'believe.' A plausible lexical entry for telja 'believe' in its raising use is shown in (91), which would be the entry for the main verb in (92). Recall that a [+R] verb exceptionally governs-*bt* into its complement clause at *s* structure (see section 2.6.2.1.).

(91) *telja*, V: 'believe' (believed) [+R], [+Pred SR], [+transitive]
 [[S, VP] ___]

(92) þeir telja Maríu hafa skrifað ritgerðina.
 they believe Mary-ACC to-have written thesis
 'They believe Mary to have written her thesis.'

Now Icelandic includes a verb form, called the "middle" in the literature, which is generally ambiguous between passive and reflexive interpretations. Verbs in the middle end in the clitic -st, which is the descendent of a reflexive pronoun in Old Icelandic (sentences (93) are from Valfells 1970).

(93) a. Hann klæddist.
 dressed-REFL
 'He dressed himself'
 b. Keisarinn klæddist nýjum fötum
 dressed-REFL
 'The Emperor was dressed in new clothes.'

On our account, the reflexive morpheme -st must carry the features [-Pred SR], [-transitive] plus the features which assign it, as a reflexive pronoun the semantic role of the logical subject. Recall that addi: the features

contrast to an approach which implicates the logical object semantic role, the analysis of lexical reflexivization which follows from the theory of this dissertation makes exactly the right prediction about the reflexive form of a raising to object verb, as was demonstrated in (94-95) above.

An alternate account of the Icelandic middle will account for sentence (95) in its reflexive reading but must be rejected on independent grounds. If we supposed that -st were a reflexive pronoun object clitic, we would provide a superficially correct analysis for sentences like (95) repeated as (96b) below. On the clitic analysis of -st, (96b) would be syntactically parallel to (96a) but with the pronominal object cliticized to the matrix verb.

- (96) a. hann telur sig vera sterkan/*sterkur.
 he-NOM believes himself-ACC to-be strong-ACC/*strong-NOM
 'He believes himself to be strong.'
- b. hann telst vera sterkur/*sterkan.
 he-NOM believe-REFL to-be strong-NOM/*strong-ACC
 'He believes himself to be strong.'

Since the objects of raising to object verbs are the subjects of their complements clauses, -st considered as a reflexive object clitic would bear the semantic role of the lower clause subject in (96b), as required. Since the subject of the higher verb in (96b) would serve as antecedent for -st as a reflexive object clitic, it would be properly interpreted as both the "believer" and the one who is strong.

Andrews (1981) provides conclusive evidence against a clitic analysis of Icelandic middle verbs. This evidence works against any clitic analysis of reflexive verbs in Icelandic, including the clitic analysis allowed by the present theory. In raising to object constructions with transitive verbs like telja 'believe,' a predicate adjective in the embedded clause agrees in case with its subject, which is the object of the raising verb.

In (96a), the predicate adjective sterkan 'strong-ACC' must appear in the accusative in agreement with its subject, vera 'himself-ACC.' If -st were simply a reflexive object clitic, we would expect the predicate adjective embedded under the middle teljast 'believe-REFL' to bear accusative case in agreement with the pronominal object clitic -st which serves as its subject. Under the clitic analysis of -st, (96a) and (96b) have essentially the same syntactic structure. However, as shown in (96b), the adjective embedded under the middle teljast must appear in the nominative, agreeing with the subject of teljast. Andrews demonstrates that this adjective agrees in case with the subject of teljast regardless of the case of the subject. Agreement with the subject of teljast is what we would expect if, as indicated in (94) above, teljast were a raising to subject verb. Since it cannot distinguish (96a) and (96b) properly, the clitic analysis of (96b) must be rejected (see Andrews 1981 for a more thorough version of this argument against the clitic analysis).

3.2 Alternations in the expression of a verb's semantic dependents not mediated by affixation. In the first major section of this chapter I discussed alternations in the expression of a verb's semantic dependents that share three crucial properties. First, the alternations do not involve alternations in the argument structures or semantic role assigning features of the verbs exhibiting them.¹⁹ Second, the alternations are mediated by affixation. That is, attributing a set of features to an affix completely accounts for the expression of a verb's semantic dependents when the verb occurs with the affix as opposed to their expression when the verb occurs without the affix. Third, the alternations are highly productive, involving virtually all verbs compatible with the features of the affixes which mediate the alternations.

This section will treat alternations in the expression of a verb's semantic dependents which share none of the properties described above. First, they arguably involve alternations in the argument structure or semantic role assigning features of the verbs exhibiting them. Second, the alternations are not mediated by affixation in the sense that no affix may be considered to carry the features necessary to explain the observed properties of the alternations. And third, they are restricted to a limited set of verbs in the language, a set with an identifiable semantic coherence. As we shall see below, the theory of this dissertation explains the connection among the properties of the alternations to be discussed in this section. In particular, the theory prohibits an alternation which involves an alternation in argument structure or semantic role assigning properties from being mediated by affixation. The mechanisms left open by the theory to account for such alternations suggest a reason for their limited productivity.

The first subsection (3.2.1) below deals with the so-called "dative shift" constructions in English and other languages. The second (3.2.2) discusses the "anticausative" and "indefinite object deletion" alternations described briefly in Chapter One.

3.2.1. Dative Shift: Alternations in semantic role assigning properties. Much attention has been given in the transformational literature to the relationship between sentences like (97a&b) and to that between sentences like (98a&b).

(97) a. Elmer gave a porcupine to Hortense.

b. Elmer gave Hortense a porcupine.

(98) a. Elmer baked a cake for Hortense.

b. Elmer baked Hortense a cake.

Some languages exhibit alternations in the expression of a verb's arguments superficially similar to those illustrated in (97-98) in which the second member of each pair contains a verb marked with an affix absent from the verb in the first member. For example, consider these Chichewa sentences from Trithart (1977, p. 37).

(99)a. Cátherine a-ná-(yí-)phík-a n-síma.
Catherine_i she_i-PAST-(it_j-)cook-INDIC nsima_j
'Catherine cooked nsima.'

b. Cátherine a-ná-(wá-)phík-ir-a á-ná n-síma.
Catherine_i she_i-PAST-(them_j-)cook-APPLIED-INDIC children_j
nsima.
'Catherine cooked the children nsima.'

The "applied" affix on the verb in (99b) signals the presence in the sentence of an NP unmarked by case or preposition, á-ná 'children' in (99b), which bears the benefactive role. In section 3.4.1.1 below I will provide an analysis of constructions like (99b); below I explain how they differ crucially from structures like (97b) or (98b). In this section we examine

the expression of goals (see (97b)) and benefactives (see (98b)) as direct objects of morphologically simple verbs, such as English give and bake.

3.2.1.1 Dative shift with goal arguments. We have assumed that the P-A structure of give is as shown in (100).

(100) 'give' (theme, goal)

As discussed above, the lexical entry for give in (97a) will include the information displayed in (101). Since give in (101) assigns the theme role and English verbs have been assumed to assign only one role, the goal role in (97a) must be assigned by something other than the verb. In English, the preposition to assigns the goal role associated with give.

(101) give, V, 'give' (theme, goal), [+Pred SR], [+transitive]

In the present theory, we account for alternations in the expression of a verb's arguments like that illustrated in (97) by postulating an alternation in what role a verb like give assigns. On this account, the difference between give in (97a) and give in (97b) is that the former assigns the theme role while the latter assigns the goal role. The lexical entry for give in (97b) would include the information displayed in (102).

(102) give, V, 'give' (theme, goal), [+Pred SR], [+transitive]

The fact that the propositional contents of (97a) and (97b) are identical is explained by the fact that (101) and (102) include the same P-A structure, that shown in (100); that is, give names the same function from arguments to predicates in (97a&b). If give assigns the goal role, as in (102), since English allows verbs to assign only one role (in the unmarked case), some semantic role assigner must assign the theme role. Although English lacks a preposition to assign the theme role, I claim that the structural position [NP, VP] may assign this role.

In (6) of Chapter Two I listed structural positions and case markings along with predicates and lexical items among the semantic role assigners. A consideration of language acquisition helps explain why [NP, VP] is a likely assigner of the theme role in dative shift constructions. As argued in Marantz (1980a), children's first knowledge of language connects semantic roles directly to their expressions in a sentence. In that paper I describe the results of two experiments I conducted with young children which indicate that children acquiring English link semantic roles directly to structural positions until around the age of five, agents being linked to preverbal positions, patients and themes to postverbal positions (see the discussion of Marantz 1980a in Chapter Two, section 2.2 for a more detailed description of the experiments). By virtue of the acquisition process, then, the usual expression of direct objects, the structural position [NP, VP], is connected in the child's linguistic knowledge with the semantic roles canonically born by direct objects, i.e., patients and themes. The ability of the structural position [NP, VP] to assign the theme role to an argument in dative shift constructions could be a vestige of an earlier stage of language acquisition. Recall that principle (94) of Chapter Two insures that the assignment of the theme role by [NP, VP] establishes a direct link between the theme role and its surface structure expression, for a constituent assigned a semantic role by [NP, VP] must correspond to a constituent in the structural position [NP, VP] at surface structure. The direct connection between the theme role and its surface expression in dative shift constructions is characteristic of a young child's grammar. Of course, the

canonical appearance of themes in the [NP, VP] position in English would be motivation enough within the adult grammar to allow [NP, VP] to assign the theme role in dative shift constructions. No appeal to language acquisition is necessary to explain this property of [NP, VP], but the acquisition data are suggestive.

So the dative shift alternation exhibited in (97) results from an alternation in which of two roles verbs like give assign. If the verb assigns the theme role, the goal role will be assigned by the usual assigner of this role, the preposition to in English. If, on the other hand, the verb itself assigns the goal role, the theme role will be assigned by the usual expression of direct objects, in English, the structural position [NP, VP]. In the surface structure of an English sentence, the [NP, VP] which is the OBJ of the head verb of the VP precedes an [NP, VP] which is not an OBJ of the verb, so the goal precedes the theme in (97b).

Given the assumption that the verbs in the shifted (97b) and the unshifted (97a) have the same P-A structure and the assumption that English allows verbs to assign only one role in the unmarked case, the theory of this dissertation taken with well-established facts about English actually demands the above analysis of dative shift. Since, by assumption, verbs in English assign only one semantic role, the verb in (97b) may assign only one role. If it assigned the theme role, it could not also assign the goal role. But there is nothing in sentence (97b) which could be seen as assigning the goal role except the verb. In particular, there is no affix on the verb in (97b) which could assign

the goal role. Also, since the goal argument in (97b) does not appear in a usual expression of goals in English, the structural position of the goal argument may not assign the goal role to this argument. Therefore, the verb in (97b) must assign the goal role to Hortense. Since the canonical expression of direct objects, [NP, VP], is associated with the semantic roles canonically born by objects, themes and patients, [NP, VP] may assign the theme role to a porcupine in (97b).

We may extend the line of reasoning which leads to an analysis of (97b) to "double object" constructions crosslinguistically, and make a significant prediction about such constructions. A double object construction is a sentence, like (97b) or (98b), in which two arguments of a verb are expressed as direct objects are usually expressed in the language. Suppose one of these arguments bears the theme or patient role. Given three facts about the language, those listed in (103), we predict that, in double object constructions, the argument expressed as objects usually are which does not bear the theme or patient role will be the OBJ of the main verb while the theme or patient argument will not be an OBJ of the verb.

- (103) a. The language allows a verb to assign only one semantic role in the unmarked case.
 b. The main verb of the double object construction is underived.
 c. There is no independent reason to believe that the usual expression of direct objects in the language may assign the semantic role born by the argument which is not the theme or patient.

We have assumed that it is the unmarked case for a language to allow its underived verbs to assign only one semantic role. If the language is

marked, allowing verbs to assign two roles, but facts (103b&c) hold, we still predict that the non-theme/patient argument will be an OBJ of the verb, although the theme/patient argument may also be an OBJ -- see section 3.4.1.1.2 below for a discussion of such marked languages. In section 3.4.1 I will also discuss double object constructions with derived verbs. If the main verb in a double object construction were morphologically complex, the affix on the verb could assign the non-theme/patient role while the verb assigns the theme/patient role. As for (103c), if the usual expression of direct objects in a language were known to assign the non-theme/patient role of a double object construction independent of such constructions, the theme/patient role in the double object constructions of this language could be assigned by the verb while the usual expression of objects assigns the non-theme/patient role. For example, if the goal role were assigned by [NP, VP] in English with verbs of motion, the analysis of (97b) given above would not be forced by the theory. That is, if we said Elmer went the store for Elmer went to the store, the position [NP, VP] could be analyzed as assigning the goal role in (97b).

In a double object construction of a language for which (103) holds, the main verb must assign the semantic role to the argument which does not bear the theme/patient role and not to the theme/patient argument. If the verb assigned the theme/patient role to an argument, the other argument would not receive its semantic role. It could not receive its role from the verb, since, by (103a), the verb only assigns one role. It could not receive its role from an affix on the verb since, by (103b),

the verb is underived. And it could not receive its role from its surface structure expression because it is expressed as objects usually are and, by (103c), the usual expression of objects does not assign the role it bears. So the verb must assign a role to the argument which does not bear the theme/patient role. If the verb assigns this role, from (103a) it follows that it cannot also assign the theme/patient role. So the usual surface structure expression of objects in the language must assign the theme/patient role. Thus our theory predicts a lexical entry like (104) for the main verb of a double object construction in a language meeting the stated conditions.

(104) 'verb' (theme/patient, semantic role)

If the verb in (104) is active, i.e., [+Pred SR], [+transitive], the underlined semantic role in (104) will, by the usual reasoning from principle (66), Chapter 2, be born by the s structure OBJ. If the verb is passive, i.e., [-Pred SR] and [-transitive], the underlined semantic role will be born by the SUB. Since the theme/patient role is not assigned by the verb in (104), it cannot be born by the OBJ or SUB of the verb, and thus the constituent bearing the theme/patient role should never exhibit direct object or subject properties.

The prediction the present theory makes about double object constructions is confirmed in a variety of languages. I will illustrate how the prediction is born out with two clear examples, one from Chi-Mwi:ni (Kis-siberth and Abasheikh 1977) and one from Yindjibarndi (Wordick 1979).²¹

Chi-Mwi:ni, sometimes considered a dialect of Swahili, is a Bantu language spoken in the city of Brava in Somalia. The basic sentence

structure of Chi-Mwi:ni may be represented as in (105), where the first NP is the subject of the sentence.

(105) $S[(NP) VP[V (NP) (NP) (PP*)]]$

The NPs in (105) appear entirely without overt case marking. The verb contains an obligatory subject prefix (SP) indicating the noun class of the subject NP (noun classes--"multiple genders"--are a characteristic feature of Bantu languages). An object prefix (OP) indicating the noun class of one of the postverbal NPs optionally follows the SP within the verb. We will return immediately to the question of which postverbal NP "controls" the OP in the verb. A partial representation of the internal structure of the Chi-Mwi:ni verb is given in (106).

(106) $v[SP-(OP)-V_{ROOT}\dots]$

Sentence (107) is a typical Chi-Mwi:ni double object sentence headed by an underived verb. The OP in (107) agrees with the goal, chiga:ri 'cart.'

(107) Ali \emptyset -(sh)-pashi \acute{e} chiga:ri o:liyo.
 Ali SP-(OP)-applied cart oil
 'Ali applied oil to the cart.'

As explained above, our theory predicts that, in a sentence like (107), only the non-theme, chiga:ri 'cart', and not the theme, o:liyo 'oil', can be the object of the verb. As expected, if we passivize the verb in (107), only the goal may serve as the subject of the passive verb.

(108) a. Chiga:ri sh-pashila o:liyo.
 cart SP-applyPASS oil
 'The cart was oiled.'

b. *O:liyo i-pashila chiga:ri.
 oil SP-applyPASS cart
 'Oil was applied to the cart.'

There is every reason to believe that the OP agrees with the OBJ of a transitive verb in Chi-Mwi:ni. In general, an argument which controls the OP on an active verb and only such an argument may be the subject of the verb's passive counterpart. As expected, only the goal, chiga:ri 'cart', in sentence (109) may control the OP on the verb.

The most interesting feature of Chi-Mwi:ni double object sentences like that displayed in (107) is that the order of the postverbal NPs is not fixed. In double object sentences headed by an underived verb, if one postverbal argument is animate and the other inanimate, the animate argument usually precedes the inanimate. When both are inanimate, however, the order of arguments after the verb is free. Thus sentence (109) is synonymous with (107).

- (109) Ali \emptyset -(sh)-pashiḱe o:liyo chiga:ri.
 Ali SP-(OP)-applied oil cart
 'Ali applied oil to the cart.'

The OP on the verb in (109), like that in (107), must agree with the goal, not the theme. And, of course, only (108a), not (108b), is grammatical as a "passive version" of (109). Neither (107) nor (109) is marked in any way, according to Kisseberth and Abasheikh; both sentences receive normal intonation and neither has a "topicalized" reading.

The fact is that only one of the postverbal NPs in a Chi-Mwi:ni double object construction headed by an underived verb exhibits "object behavior"; moreover, word order in general does not indicate which NP it will be. The only way to tell the postverbal NPs in sentences like (107) and (109) apart is on the basis of the semantic roles they bear, and the theory outlined above correctly predicts which NP is the OBJ

on this basis.²²

Unlike most of its neighbors in Australia, Yindjibarndi, an Australian Aboriginal language described in Wordick (1979), is transparently nominative-accusative. The subjects of transitive and intransitive verbs fall into the nominative case (i.e., are unmarked for case) while the object of a transitive verb falls into the objective (accusative) case. Yindjibarndi word order is as free as that in Warlpiri (see Nash 1980), with any ordering of at least the major constituents of a simple sentence being equally acceptable and unmarked.

According to Wordick (1979),

To derive a passive in Yindjibarndi, one takes the subject of the sentence, which is in the nominative case, and puts it into the instrumental case. The object of the verb, which is usually in the objective case, goes into the nominative case. Finally, a special intransitive verbalizer -nguli- is attached to the stem of the transitive verb, which is then reinflected.

- (110) a. Ngaarta thuwayina pattyarriu.
 man spear-PAST euro-OBJ
 'The man speared the euro.'
- b. Ngaartalu thuwayingulinha pattyarri.
 man-INST spear-PASS-PAST euro
 'The euro got speared by the man.'

Passivization, Wordick makes clear, applies to any "transitive" verb, by which he means a verb taking an argument in the objective case, regardless of the semantic role born by the verb's object. For example, the verb meaning 'to go up' in Yindjibarndi puts its locative argument in the objective case and thus will passivize.

- (111) a. Ngayi karpayi purpaau.
 I go up rise-OBJ
 'I will go up the rise.'

- b. Ngayhulu kapangulii purpaa.
 me-INST go up-PASS rise
 'The rise will be gone up by me.'

Although apparently any transitive verb--any verb which takes an objective argument--will passivize in Yindjibarndi, "intransitive verbs will definitely not undergo the passive transformation" (Wordick 1979). From the data Wordick provides, we may conclude that the Yindjibarndi passive morpheme, -nguli-, has the same features as the English passive morpheme, -en-[Pred SR], [-transitive]. As explained above, the [-transitive] feature carried by a passive affix prevents it from attaching to [-transitive] roots.

The Yindjibarndi verb meaning 'give' appears in double object sentences, with both its goal and theme arguments in the objective case.

- (112) Ngaarta yungkunha ngayu murlayi.
 man give-PAST me-OBJ meat-OBJ
 'The man gave me the meat.'

Of course the ordering of the agent, theme, and goal in a sentence like (112) is completely free. But,

when a verb has two objects, a direct [theme] and an indirect one [goal], . . . only the indirect object can be shifted into the nominative case [in passives]. The direct object must remain in the objective case [Wordick (1979)].

- (113) a. Ngayi yungkungulinha murlayi ngaartalu.
 I give-PASS-PAST meat-OBJ man-INST
 'I was given the meat by the man.'
- b. *Murla yungkungulinha ngayu ngaartalu.
 meat give-PASS-PAST me-OBJ man-INST
 'The meat was given me by the man.'

Since it is the OBJ of an active, transitive verb which corresponds to the SUB of its passive, intransitive form, sentences (113) in-

dicade that only the goal argument in Yindjibarndi double object constructions is an OBJ, as predicted by our theory. Again, word order and case marking cannot determine which NP in sentences like (112) is the OBJ; the theme and goal arguments in such sentences are indistinguishable by any criterion except that of which semantic roles they bear. And our theory tells us which argument must be the OBJ on the basis of their semantic roles.²³

3.2.1.2. Dative shift with benefactives. Consider now the alternation illustrated in (98), repeated here, which involves a benefactive NP.

- (98) a. Elmer baked a cake for Hortense.
b. Elmer baked Hortense a cake.

Within the present theory, the required analysis of the benefactive alternation in (98) is essentially the same as that described for the dative shift alternation in (97). The main difference between the alternations lies in the fact that, although give and related verbs (hand, throw, etc.) may be argued to include a slot for a goal argument in their P-A structures, there is little reason to believe that a benefactive slot appears in the P-A structure of verbs like bake. The activity of baking does not seem to imply a benefactive any more than any other creative activity does. If the bake in (98) does not include the benefactive within its P-A structure, its lexical entry will contain the information in (114).

- (114) bake, V, 'bake' (patient), [+Pred SR], [+transitive]

Since the structural position [NP, VP] cannot be expected to assign the benefactive role in (98b) and no affix appears on bake in this sentence to assign the benefactive role, bake itself must assign the benefactive role to Hortense in (98b). Because English verbs assign only one role in the unmarked case and bake assigns the benefactive role in (98b), the verb cannot also assign the patient role in this sentence. The structural position [NP, VP], the canonical expression of patients in English, may assign the patient role to cake in the double object construction (98b).

Although sentences (98) share propositional content, (98a) contains an argument-taking constituent not found in (98b), the preposition for. There is no reason to believe that the bake in (98a) has a different P-A structure from the bake in (98b), yet (98b) includes a benefactive argument without a benefactive argument-taking item. To account for the shared propositional content between (98a) and (98b), we may embed the modifier-argument structure of the preposition for within the lexical entry of the bake in (98b), creating lexical entry (115).

(115) bake, V, ('bake' (patient) 'for' (benefactive))

The parentheses around the P-A structure 'bake' and the modifier-argument structure 'for' in (115) are meant to indicate that bake applies the modifiers the 'for' function produces to the predicates the 'bake' function produces to yield new predicates. Note that (115) embeds the P-A structure in (114), thereby satisfying the natural principle that related verbs will share P-A structures, all other things being equal.

Just as was the case with the dative shift alternation (97), the benefactive alternation (98) results from an alternation in which of two

semantic roles a verb assigns. When the verb assigns the patient role, as in (98a), the preposition for must be used to assign the benefactive role. When the verb assigns the benefactive role, as in (98b), the structural position [NP, VP] assigns the patient role. So the benefactive, Hortense, in (98b) must be the OBJ of bake while the patient NP, a cake, is merely an argument of the verb.

3.2.1.3. The status of the dative shift alternations. I have claimed that verbs like give and bake have two related lexical entries which differ essentially in which semantic role the verb assigns.²⁴ The question arises of what, if anything, connects lexical entry (101) with lexical entry (102), or lexical entry (114) with lexical entry (115), other than the fact that the entries share P-A structures and all phonological features. Recall that our principles prevent affixation from changing a verb's semantic role assigning properties. If an item assigns a semantic role it will be an independent semantic role assigning constituent at i-s structure regardless of the affixes which might be attached to it. Therefore, the dative shift alternations in (97) and (98) cannot be mediated by a "lexical rule" in the narrow sense of an affixation process. In fact, no overt morphological affix mediates the dative shift alternations in English. Although the theory prohibits relating (101) to (102) or (114) to (115) via affixation, clearly the relationships between these entries generalize to more than one or two verbs. Speakers know some relationship exists between (101) and (102) and between (114) and (115) and are able to extend these relationships

to other verbs. We may suppose that speakers generalize the relationships indicated in (116) by analogy to verbs similar to give and bake.

- (116) a. give: 'give' (theme, goal) ~ 'give' (theme, goal)
 b. bake: 'bake' (patient) ~ ('bake' (patient) 'for' (bene-factive))

One might argue that I am begging the question as to the nature of the dative shift alternations by making a vague reference to generalization by analogy. However, I think the evidence strongly suggests that the alternations in (116) are extended to new verbs in a manner best described as analogical extension. In the analogical extension of the relationship $A : B$, one takes a C similar to A or B in features relevant to the relationship and solves for X in $A : B$ as $C : X$, or $A : B$ as $X : C$. We may suppose that speakers are extremely conservative in their generalizations by analogy (see Baker 1979), requiring their C 's to share most syntactic and semantic features with A or B . The closer the semantics of a verb are to the canonical verbs exhibiting an alternation like those in (116), the more likely it is that a speaker will extend the alternation to that verb. Although there are notorious examples of verbs taking theme and goal arguments which, for most speakers, do not allow dative shift (donate is the most widely quoted example), any verb which, like hand, means to direct something with a body part will exhibit the dative shift alternation. A speaker might find the sentence, Elmer donated the library several books on porcupines, ungrammatical, but as soon as he accepts the verb to shin, meaning 'to kick with the shin,' he will allow Elmer shinned me the ball during soccer practice. Similarly, any verb meaning 'to create a food item in some specific manner' will

exhibit the alternation in (116b). If a speaker will accept, He micro-waved a potato for me, he will allow, He microwaved me a potato in two seconds flat.

Although our theory has nothing to say about the possibility of generalizing by analogy an alternation like those shown in (116) once it is recognized as an alternation by a speaker, the theory does set severe limits on the generalization of the particular alternations in (116). Recall that the theme role in (97b) and the patient role in (98b) are assigned by the structural position [NP, VP]. Recall also that "theme" and "patient" are really names for classes of semantic roles and that items assign specific semantic roles, not classes of roles. If the structural position [NP, VP] assigns the theme role which give may assign, this is a particular theme role, one which may only be associated with a small set of verbs, perhaps those which describe a transference of possession. Similarly, the patient role assigned by [NP, VP] is that associated with bake and is probably limited to verbs of creation. An English verb may only appear in a dative shifted construction like (97b) or (98b) if the role it assigns in constructions like (97a) and (98a) may be assigned by [NP, VP]. Since morphologically unmarked alternations like those in (116) do not involve the addition of a semantic role assigner to the verb, the class of verbs to which the alternations may extend is limited by the range of roles the structural position [NP, VP] assigns.

On the other hand, alternations in other languages superficially similar to (97) and (98) which do involve the addition of a morpheme to

a verb should extend to most verbs in the languages. Consider the Chichewa benefactive illustrated in (99b) at the beginning of this section and repeated here.

- (99) a. Cátherine a-ná-(yi-)phik-a n-síma.
 Catherine_i she_i -PAST-(it_i -)cook-INDIC nsima_j.
 'Catherine_i cooked_i nsima_j.'
- b. Cátherine a-ná-(wá-)phik-ir-a ǎ-ná n-síma.
 Catherine_i she_i -PAST-(them_j -)cook-APPLIED-INDIC children_j
 nsima.
 'Catherine_i cooked_i the children_j nsima.'

As will be explained in 3.4.1 below, the "applied" affix, -ir-, in (99b) assigns the benefactive role and carries the argument structure of English for. Since the affix assigns the benefactive role and carries the modifier-argument structure of for in (99b), the verb in (99b) is free to assign the same role it assigns in (99a) and may be given precisely the same P-A structure as the verb in (99a). As shown in 3.4.1, we may attribute to the "applied" affix -ir- all the features necessary to account for the syntax of the derived verb in (99b) assuming that the affix merely attaches to the verb which appears in (99a). Since it does not rely on a structural position or on case marking to assign a role usually assigned by a verb, the Chichewa benefactive construction in (99b), unlike the English benefactive construction in (98b), should be extended to verbs regardless of the roles they assign in their underived form. Affixation alone accounts for the Chichewa benefactive construction; no generalization by analogy is required to extend it to a new verb. In fact, benefactive alternations like the Chichewa which are mediated by affixation extend to a great many more verbs than benefactive alternations

like the English which involve no addition of morphemes.

3.2.2. Alternations in argument structures. In the last section I analyzed alternations in the expression of a verb's semantic dependents which involve alternations in a verb's semantic role assigning features. In this section I turn to alternations in the expression of a verb's dependents which seem to implicate changes in the verb's argument structure. Examples of the sort of alternations to be considered are found in (117-119).

- (117) a. Elmer broke the porcupine cage.
b. The porcupine cage broke.
- (118) a. Elmer hung the porcupine cage in the window.
b. The porcupine cage hung in the window.
- (119) a. Elmer ate mock porcupine pie late last night.
b. Elmer ate late last night.

Sentences (117b) and (118b) display two sorts of "anticausatives"--the "inchoative" in (117b) and the "stative" in (118b). Sentence (119b) exemplifies what is sometimes called "indefinite object deletion." I will treat anticausatives and indefinite object deletion constructions separately, the former in 3.2.2.1, the latter 3.2.2.2.

3.2.2.1. Anticausatives. Consider sentences (117-118) above. In the a. sentences of (117-118), Elmer is a sort of causer; in (117) he causes the porcupine cage to break, and in (118a) he causes the cage to hang in the window. Unlike the a. sentences, the b. sentences in (117-118) hold no causative implications. (117b) does not imply that someone broke the porcupine cage, nor does (118b) imply that someone

hung the cage in the window. Compare sentences (117b & 118b) with the passives in (120), where the passive participles are intended to have their verbal, rather than their adjectival, interpretation.

- (120) a. The porcupine cage was broken.
 b. The porcupine cage was hung in the window.

In contrast to (117b) and (118b), sentence (120a) does imply that someone or something broke the cage, sentence (120b) that someone or something hung the cage in the window. The predicates that break and hang produce in (117a), (118a), and (120) must assign causer roles. Because no causers or causation are implied by (117b) and (118b), break and hang must not yield causer assigning predicates in these sentences.

We may suppose that the lexical entries for break and hang in (117a) and (118a) contain the information in (121a) and (121b) respectively.

- (121) a. 'break₁' (patient), [+Pred SR], [+transitive]
 b. 'hang₁' (theme), [+Pred SR], [+transitive]

Since English generally has verbs assign theme/patient roles, it is reasonable to assume that the lexical entries of break and hang in (117b) and (118b) contain information in (122).²⁵

- (122) a. 'break₂' (patient) [-Pred SR], [-transitive]
 b. 'hang₂' (theme) [-Pred SR], [-transitive]

The argument structures in (121) and (122) differ crucially in that the predicates produced by the P-A structures in (121) assign causer roles while the predicates produced by the P-A structures in (122) assign no roles at all. Since affixes do not affect argument structures of roots to which they attach, no affixation process could relate the verb in (117a) to that in (117b) or the verb in (118a) with the verb in (118b).

However, the break in (117a) is clearly related to the break in (117b), the hang in (118a) to the hang in (118b). How should these relationships be expressed in the lexicon?

In the lexical entry of each verb exhibiting the anticausative alternation I will assume that there are two sub-entries, one for the transitive alternate, one for the anticausative alternate. An example entry is shown in (123).

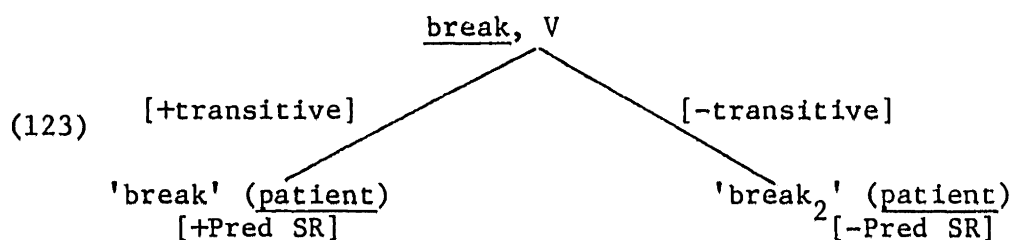

The semantic relationship between the transitive--'V₁'--and anticausative--'V₂'--P-A structures within the lexical entry of a verb exhibiting the anticausative alternation is informally stated in (124). The biconditional in (124) is inadequate as a characterization of the semantics of the transitive verb because it does not capture the direct causative implications of the transitive alternate in an anticausative alternation (see Shibatani 1976b for a discussion of types of causation). The pariphrastic "cause to V" incorrectly implies indirect causation.

(124) anticausative alternation; V₁ = transitive alternate,
 V₂ = anticausative: if X V₁ Y, then X cause Y to V₂

If V₂ is a stative verb, like hang, V₂ is known as the "stative" of V. If V₂ is a punctual verb, like break, V₂ is known as the "inchoative" of V (see Bresnan 1980). In some manner speakers of English extend the branching lexical entry of verbs like break and hang to verbs which they

consider similar in semantics to these verbs. As with the dative shift alternation discussed above, analogical generalization, although imprecisely characterized here, seems a reasonable mechanism for the extension of the anticausative alternations.

Since the present theory prohibits affixation alone from mediating the anticausative alternation, we expect differences between the anticausative alternation and alternations associated with productive affixation processes. Unlike passivization, for example, the anticausative alternation is limited crosslinguistically to a restricted class of verbs with some semantic coherence. Furthermore, the "core" members of this class are synonomous from language to language. That is, the verbs meaning 'break,' 'hang,' 'open,' and 'close,' for example, are more likely than not to exhibit the alternation in any given language. If the anticausative alternation is generalized by analogy from a few core examples, as hypothesized, and not created by a productive lexical rule, as prohibited by the theory, we would expect the alternation to be restricted to a semantically coherent class of verbs.

Consistent with the present theory is the fact that the anticausative alternation is never mediated by an anticausative morpheme. That is not to say that an affix does not appear on either the transitive or anticausative alternate in any language; as we shall see immediately, many languages (e.g., French, Russian, Dyirbal) take the transitive alternate as morphologically simple and place an affix on the anticausative alternate, while a few languages (e.g., Japanese, Navajo) take the anticausative as morphologically simple and place an affix on

the transitive alternate. However, the affix which appears on one or the other alternate of the verbs participating in the anticausative alternation is not limited to the anticausative alternation in a language and therefore should not be considered an "anticausative affix." Rather, the affix may be seen as carrying the features [-Pred SR] or [-transitive] or both when it appears on the anticausative alternate, or the feature [+transitive] when it appears on the transitive alternate, because the affix carries these features in unrelated constructions in the language.

If anticausativization were an affixation process similar, say, to passivization, we would expect most verbs with causative meaning in a language to exhibit the anticausative alternation, and we would expect at least some languages to employ a special affix specific to the alternation. Since anticausativization is never productive and never mediated by an alternation specific affix, a theory of grammar should not treat anticausativization as an affixation process. A theory, like the theory of this dissertation, which rules out an analysis of anticausativization as an affixation process derives support from the behavior of anticausative alternations crosslinguistically.

Although no language I have examined employs an anticausative morpheme to mediate the anticausative alternation, languages do exploit a variety of devices, including affixation, to distinguish the [+transitive] alternate from the [-transitive] alternate in a lexical entry like (123) above. Some languages simply use the unmarked transitive form of a verb for the transitive alternate and the unmarked intransi-

tive form for the anticausative alternate. English is an example of such a language in which the unmarked transitive and intransitive forms of a verb are homophonous.

- (125) a. inchoative: break
 Elmer broke the porcupine cage.
 The porcupine cage broke.
- b. stative: hang
 Elmer hung the porcupine cage in the window.
 The porcupine cage hung in the window.

In Eskimo dialects a canonical transitive verb will agree with both the subject and object of a sentence while a canonical intransitive verb agrees with the subject alone (see 3.1.2 above). The transitive conjugation of verbs like 'break' and 'lose' is used for the transitive member of the anticausative alternation, the intransitive conjugation for the anticausative alternate. The data in (126) are from Alaskan Yup'ik (see Reed et al. 1977).

- (126) a. inchoative: kuve- 'spill'
 Kuv'uq. 'It spills.'
 spill-3sg
 Kuvaa. 'He spills it.'
 spill-3sg3sg
- b. stative: tamar- 'lose'
 Tamartuq. 'It is lost.'
 lose-3sg
 Tamaraa. 'He loses it.'
 lose-3sg3sg

The unmarked intransitive form of verbs exhibiting the anticausative alternation is used for the anticausative alternate even in the Eskimo dialects, like Alaskan Yup'ik, in which the intransitive form of a transitive verb usually agrees with the agent argument, not the patient or theme as in (126) above. A paradigm transitive-intransitive pair from Yup'ik is illustrated in (127).

- (127) amar- 'backpack'
 Amartuq. 'He backpacks (something).'
 backpack-3sg
 Amaraa. 'He backpacks it.'
 backpack-3sg3sg

Note that the intransitive verb in (127) agrees with the agent while the intransitives in (126) agree with the patient or theme. It seems that, if a language has some general means to mark the intransitive counterpart of a transitive verb, the anticausative alternate will be marked by these means. The notation in (123) attempts to capture this generalization by making the transitive and anticausative alternates in an anticausative alternation the transitive and intransitive "versions" of a single verb. Intransitive morphology leads to the [-transitive] branch of lexical entries like (123), transitive morphology to the [+transitive] branch.

In many languages, a marked intransitive form of the verb, usually the passive and/or reflexive form, is used for the anticausative alternate in an anticausative alternation. Examples from Russian, French, and Albanian are found in (128-130). In all these languages, reflexive morphology marks the anticausative. As described in section 3.1.3, the Albanian reflexive and passive forms are synonymous. Many Russian and French reflexive forms also have passive interpretations.

- (128) Russian: a. inchoative: otkryt' 'open'
 Boris otkryl dver'.
 opened door
 'Boris opened the door.'
 Dver' otkryls'a.
 door opened-REFL
 'The door opened.'

- b. stative: naxodit 'find'
 Oni nashol shkolu v gorode.
 they found school in city
 'They found the school in the city.'
 Shkola naxodits'a v gorode.
 school found-REFL in city
 'The school is located in the city.'
- (129) French: a. inchoative ; casser 'break'
 Jean a cassé le verre.
 'John broke the glass.'
 Le verre s'est cassé.
 'The glass broke.'
- b. stative: trouver 'find'
 Jean a trouvé l'école dans la cité.
 'John found the school in the city.'
 L'école se trouve dans la cité.
 'The school is located in the city.'
- (130) Albanian: a. inchoative
 Dega u thye gjatë stuhisë.
 branch the breakREFL-3sg during storm-the
 'The branch broke during the storm.'
- b. stative
 Mollat varen në pemët.
 apple-the hangREFL-3sg on trees-the
 'The apples hang on the trees.'

The reflexive and/or passive morphology on the anticausative verbs in French, Russian, Albanian, and other languages may be seen as carrying the features [-Pred SR], [-transitive]--features the morphology carries in its reflexive and/or passive use.

Like Albanian (see section 3.1.3 above), Dyirbal, an Australian Aboriginal language described in Dixon (1972), uses the reflexive verb as a sort of "passive" (see section 3.3.3 for a detailed analysis of this "false reflexive" construction). Unlike Albanian, the subject of the Dyirbal reflexive verb in its "passive" use is the agent of the transitive root, not the patient or theme.

- (131) a. bala yugu bangul yaṛaṅgu buyban.
 stick-ABS man-ERG hides
 'man hides stick.'
 b. bayi yaṛa buybayiripu.
 man-ABS hides-REFL
 'man hides himself' or 'man hides (something).'

There is a dialect of Dyirbal called Dyalṅuy or the "mother-in-law language" which is spoken in the presence of certain taboo relatives. This mother-in-law dialect has a much smaller vocabulary than the everyday language. In particular, where the everyday language contains morphologically unrelated verbs for members of certain transitive-anti-causative pairs, the mother-in-law language takes the transitive verb as morphologically simple and forms the anticausative through affixation of the reflexive morpheme on the transitive root. Transitive-anticausative pairs from the mother-in-law language are illustrated in (132).

- (132) dindan 'stand up' a. balan bangul dindan.
 she-ABS he-ERG stands up
 'he stands her up.'
 b. balan dindaripu.
 she-ABS stand-up-REFL
 'she rises.'
yilwun 'take out' a. balan bangul yilwun.
 she-ABS he-ERG takes-out
 'he takes her out.'
 b. balan yilwuripu.
 she-ABS come-out-REFL
 'she comes out.'

Compare the use of the reflexive forms for anticausatives in (132) with the productive use of the reflexive to allow suppression of the theme/patient argument of a verb, as illustrated in sentences (133), also from the mother-in-law language.

- (133) wuyuban 'talk' a. balan bangul wuyuban.
 she-ABS he-ERG tells
 'he tells her.'

- b. bayi wuyubaripu.
 he-ABS talks-REFL
 'he talks.'
- gandaman'follow' a. balan bangul gandaman.
 she-ABS he-ERG follows
 'he follows her.'
- b. bayi gandamaripu.
 he-ABS follows-REFL
 'he follows.'

What is striking about the use of the reflexive morpheme in the Dyirbal mother-in-law language to mark the anticausative is that the reflexive form, when not a true reflexive, is regularly employed when the agent of a transitive verb is the subject of the derived intransitive verb--see (133). In the anticausative, it is the theme/patient which is the subject of the morphologically derived intransitive--see (132).

The widespread use of some [-transitive] or [-Pred SR], [-transitive] bearing affix to mark the anticausative member of an anticausative alternation suggests a principle to the effect that, given a branching lexical entry like (123) with [α F] and [- α F] branches, attaching an [α F] affix to the alternate on the [- α F] branch yields the alternate on the [α F] branch and not the form expected from the productive use of the affix. For example, adding the reflexive -s'a affix to a Russian verb like otkryt' 'open' produces not a reflexive verb (see (75) above) but rather the anticausative, i.e., [-transitive], alternate in a branching lexical entry like (134)--see (128a) above.

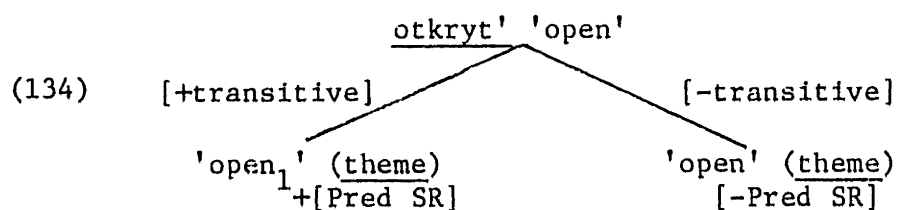

As we saw in section 3.1.3, the reflexive affix carries the features [-transitive], [-Pred SR] and so leads down the right branch in entry (134).

If the anticausative alternation is truly best represented by branching lexical entries like (134), with affixation in such alternations, when present, merely choosing one branch in the lexical entry over the other, then we might expect some languages to take the [-transitive] or anticausative alternate as morphologically basic and add a [+transitive] affix to this form to yield the verb on the [+transitive] branch of an entry like (134). Since both transitive and anticausative alternates are basic--i.e., underived--verbs, it should be arbitrary which is chosen as morphologically basic. Although most of the languages I have examined take the transitive form in an anticausative alternation as morphologically basic, according to Miyagawa (1980) Japanese and Navajo take the other option, marking the transitive alternate with a [+transitive] morpheme. The reader is referred to Miyagawa (1980) for an extensive discussion of languages in which a [+transitive] morpheme is used to signal the [+transitive] member of an anticausative alternation. Here I will quickly review some of the relevant facts from Japanese.

Japanese includes a causative affix -sas, which Miyagawa argues must be distinguished from the causative -sase to be discussed in section 3.4.2.2. When -sas attaches to certain intransitive verbs, such as odorok 'be surprised,' the result is not a causative verb one could paraphrase as, 'cause to V,' e.g., 'cause to be surprised,' but rather the transitive member of an anticausative alternation, e.g., the

"direct causative" 'surprise' shown in (135a).

- (135) a. Eigo kantoku ga zyoyuu o odorok-asi-ta.
 director NOM actress ACC surprise-CAUSE-PAST
 'The movie director surprised the actress.'
 b. Eigo kantoku ga zyoyuu o odorok-ase-ta.
 director NOM actress ACC surprise-CAUSE-PAST
 'The movie director made the actress be surprised
 (at something).'

Compare the verb odorok-as 'surprise-CAUSE' in (135a), formed with the causative -sas, to the derived causative odorok-ase in (135b), formed with -sase. Only the latter has the predictable semantics of a derived causative in Japanese.

When the probable transitive counterpart of an intransitive anticausative verb exists as a morphologically unrelated morpheme in Japanese, the addition of -sas to this verb produces a normal derived causative with predictable semantics. For example, intransitive agar 'rise' corresponds to morphologically unrelated age 'raise.' Adding -sas to agar 'rise' produces the derived causative agar-as 'cause to rise' in (136). Since the transitive age 'raise' exists independently in the language, agar-as will not mean 'raise.'

- (136) Taroo ga Hanako o butai agar-asi-ta.
 'Taro made Hanako rise (get) on the stage.'

As will be explained in section 3.4.2 below, the causative affix is [+transitive] crosslinguistically. In (136), for example, -sas creates a transitive verb, agar-as 'cause to rise' from intransitive agar 'rise.' I have given the lexical entry for the anticausative pair, odorok, odorok-as 'surprise' in (137).

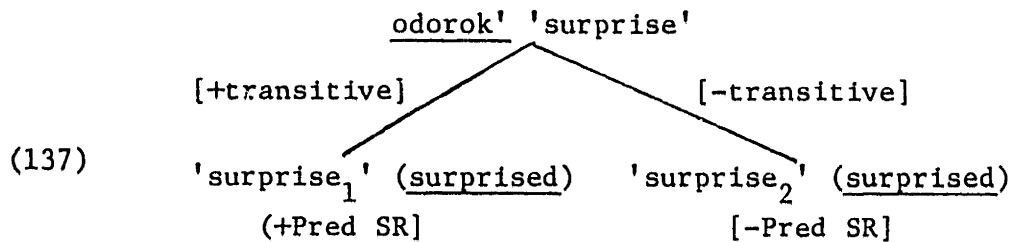

The affixation of the [+transitive] -sas to [-transitive] odorok yields the verb on the [+transitive] branch inside the branching entry (137) rather than the derived causative, 'cause to be surprised.' This behavior of -sas accords with the principle described informally above which might govern the effects of adding a [α F] morpheme to a verb whose lexical entry contains [α F] and [- α F] branches.

Since the theory prohibits deriving either verb in an anticausative alternation from the other, the present analysis of the anticausative alternation demands that both the transitive and anticausative alternates be basic verbs with basic P-A structures. Whatever requirements a language places on the construction of the P-A structures of basic verbs should thus apply to the P-A structures of both alternates. For example, if a language includes a generalization to the effect that patient and theme arguments serve as input to P-A structures, then the anticausative verbs should have "unaccusative" P-A structures (see sections 2.2 and 3.1.1.3 above), such that the patient/theme arguments appear within the P-A structure and the predicates produced by the P-A structure assign no semantic roles--see (138).

- (138) anticausative break: 'break' (patient) [-Pred SR], [-transitive]

We saw in section 3.1.1.3 that impersonal passivization will not apply to unaccusative verbs. The passive affix carries the feature [-Pred SR], as does an unaccusative verb. Principle (15) above prevents an affix like the passive morpheme with a [-Pred SR] feature from attaching to a [-Pred SR] root, thereby ruling out the (impersonal) passivization of unaccusative verbs. In languages like Dutch (see Perlmutter 1978), anticausative verbs do not undergo impersonal passivization. Confirming the hypothesis that they have P-A structures similar to that given for break in (138), i.e., unaccusative P-A structures.

Suppose a language has no basic unaccusative verbs; i.e., suppose the language demands that the predicates which a basic P-A structure produces assign a semantic role, if possible, in the unmarked case. Since anticausatives must be underived verbs in the present theory, we predict that anticausatives will not be unaccusative in such a language, and thus should undergo impersonal passivization. Arguing against the 1 Advancement Exclusiveness Law of Relational Grammar, Ostler (1979) demonstrates that most Sanskrit intransitive verbs, including anticausatives, can undergo impersonal passivization. Ostler's evidence suggests that there are no basic unaccusative verbs in Sanskrit. If most intransitive verbs are [+Pred SR] in Sanskrit, the passive morpheme will be able to attach to them (see 3.1.1 above). The hypothesis that Sanskrit demands basic verbs to be [+Pred SR], if possible, taken with the consequence of the present theory that anticausative verbs must be underived, makes the correct prediction about an interesting set of Sanskrit facts reported by Ostler (1979):

The displaced subject of a Sanskrit passive, be it personal (139b) or impersonal (139d), appears in the instrumental case.

- (139) a. caitrah kusūlam abhinat.
Chaitra-NOM grain-holder-ACC broke-3sg
'Chaitra broke the grain holder.'
- b. caitrena kusūlo 'bhidyata.
Chaitra-INST grain-holder-NOM break-PASS-PAST
'The grain holder was broken by Chaitra.'
- c. aham āse.
I-NOM sit-1sg
'I sit.'
- d. mayā āsyate.
I-INST sit-PASS
'It is sat by me.'

Sanskrit uses passive morphology to mark the anticausative member of an anticausative alternation, as in (140), which should be compared to (139b).

- (140) (svayameva) kusūlo 'bhidyata.
(of-itself) grain-holder-NOM break-PASS-PAST
'The grain holder broke (of its own accord).'

In this anticausative use, a bhidyata 'break-PASS-PAST' is incompatible with an instrumental "agent phrase." Since, ex hypothesis, underived Sanskrit verbs are [+Pred SR], and since the anticausative must be underived in our theory, the anticausative in (140) should be the [-transitive] branch of a lexical entry something like (141).

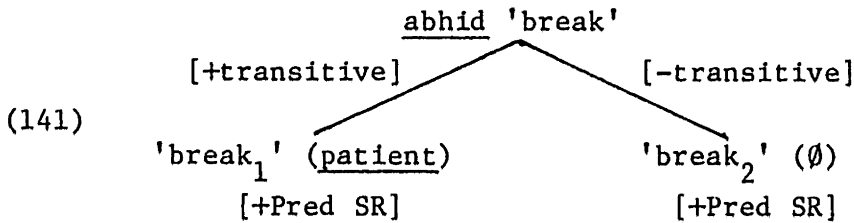

Since it is [+Pred SR], nothing would prevent anticausative 'break', the right branch in (141), from undergoing impersonal passivization in Sanskrit. In fact, there is every indication that it does.

- (142) (svayameva) kusūler.a abhidyata.
 (of-itself) grain-holder-INST break-PASS-PAST
 'The grain holder broke of its own accord.'

Although only a single passive morpheme appears on the verb in (142), the instrumental case on 'grain-holder' indicates that the verb is the (impersonal) passive version of the anticausative verb in (140); compare (142) with (139d). It is not uncommon for a language to use a single instance of a morpheme in situations where the syntax calls for two. For example, Ostler (1979) notes that the causative form of a derived causative verb in Sanskrit contains a single causative morpheme and is thus homophonous with the simple derived causative verb, although the causative of a causative should contain two causative morphemes. As the passive of the verb in (140), abhidyata in (142) should bear two passive morphemes, the second morpheme carrying the feature [-Pred SR]. The absence of a second passive morpheme, however, is not good evidence that the verb in (142) is not the passive of the verb in (140).

Now (140), without the material in parentheses, is ambiguous between the anticausative and the personal passive; it could also mean, 'The grain holder was broken (by someone).' A derived personal passive is not, of course, a basic verb. The lexical entry of passive 'break' is shown in (143).

(143) abhidyata, 'break₁' (patient), [-Pred SR], [-transitive]
 Compare (143) with the [-transitive] (anticausative) branch of entry (141). Unlike anticausative 'break,' passive 'break,' being [-Pred SR], should not undergo impersonal passivization. Thus, although (140) is ambiguous between the passive of transitive 'break' and the anticausa-

tive, (142) should have only the reading of the impersonal passive of the anticausative, not that of the impersonal passive of the passive. This is precisely what Ostler reports: (142) is incompatible with an "agent phrase" and implies no "breaker." So the break in (142) must have the anticausative P-A structure 'break₂' in (141), not the transitive P-A structure 'break₁'. The Sanskrit data provide a clear contrast between alternations mediated by productive affixation processes, like the passive alternation, and alternations between basic verbs, like the anticausative alternation.

3.2.2.2. Indefinite object deletion. Consider now the alternation illustrated in (119), which is repeated here as (144).

- (144) a. Elmer ate mock porcupine pie late last night.
b. Elmer ate late last night.

Some transitive verbs, like eat, appear freely without an object in English while others, like lock, do not.

- (145) a. Elmer locked the porcupine cage late last night.
b. *Elmer locked late last night.

It is an interesting and important problem to characterize the transitive verbs which permit "indefinite object deletion," i.e., which may appear without an overt object, as in (144b) (see Saksena 1980 for a possible solution to this problem). However, an investigation of the problem would take us beyond the central topics of this dissertation. What is important to emphasize here about alternations like (144) is that the present theory prohibits a language from deriving the eat in (144b) from that in (144a), or the eat in (144a) from that in (144b),

by simple affixation. Suppose we give verbs like eat branching lexical entries like that in (146).

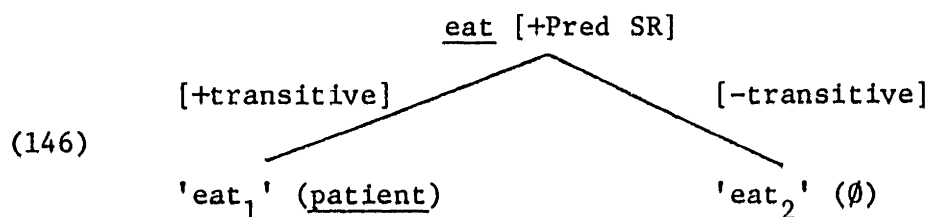

The relationship between 'eat₁' and 'eat₂' is informally stated in (147).

- (147) the indefinite object deletion alternation;
 $V_1 = \text{transitive}, V_2 = \text{intransitive}:$
 $X^1 V_2 \text{ iff } X V_1 \text{ something unspecified}$

Since the relationship between the verbs on the two branches in (146) involves a change in P-A structure and in semantic role assigning features, the relationship could not be mediated by affixation in the present theory.²⁶

As was the case with the anticausative alternation discussed above, the indefinite object deletion (or iod) alternation illustrated in (144) clearly differs from alternations like the passive which are mediated by a productive affixation process. The iod alternation is limited to a restricted set of verbs crosslinguistically and the iod set in a given language seems to have some semantic coherence. The translations of the verbs in the iod set from one language are quite likely to fall into the iod set for another. The "core" verbs which exhibit the iod alternation in language after language are the so-called "ingestives," e.g., 'eat,' 'drink,' and 'learn.' The restriction of the iod alternation to a limited set of verbs with semantic coherence is what we expect if, as demanded by the present theory, the alternation is created not by a productive

lexical rule but by generalization by analogy with certain core verbs exhibiting the alternation.

In harmony with the impossibility of mediating the iod alternation with affixation alone in the present theory, no language I have encountered contains an indefinite object deleting suffix.²⁷ Many languages resemble English in employing the unmarked intransitive form of a verb for the indefinite object deleting alternate. In English, intransitive and transitive forms of a verb are homophonous. We saw above that Eskimo transitive verbs agree with both subject and object while Eskimo intransitives agree with a single constituent. Eskimo dialects use the unmarked intransitive form of a transitive verb for the indefinite object deleting alternate in an iod alternation. This generalization holds even in dialects like Greenlandic Eskimo in which the unmarked intransitive form of a transitive verb regularly agrees with the theme or patient of its transitive counterpart, not the agent (Sadock 1980, pp. 304-305):

Many basically transitive verbs [in Greenlandic], but by no means all, can be used directly as formal intransitives just by affixing intransitive agreement morphemes. In many cases where the English counterpart is an object-deleting verb, the Greenlandic intransitive thus formed has roughly the meaning of the corresponding English intransitive. The agent in such an intransitive construction is in the absolutive case, and the verb is marked for agreement with it. The patient, if it is expressed, is in the instrumental case, and is not cross-referenced on the verb:

- (148) Neqi nerivara.
 meat-ABS eat-INDIC-1sg3sg
 'I ate the meat.'
- (149) Neqimik nerivunga.
 meat-INST eat-INDIC-1sg
 'I ate meat.'

....At least in the older language, other inherently transitive verbs acquired a passive sense when used with intransi-

tive verb endings. The verb in such usages agrees only with the patient:

(150) Piniartoq toquppa.
 hunter-ABS kill-INDIC-3sg3sg
 'He killed the hunter.'

(151) Piniartoq toquppoq.
 hunter-ABS kill-INDIC-3sg
 'The hunter was killed.'

As Sadock points out, the intransitive form of a Greenlandic transitive verb is usually the passive, i.e., it carries the feature [-Pred SR] as well as the feature [-transitive]. However, in the case of transitive verbs like 'eat,' the intransitive version is simply [-transitive], not [-Pred SR]. If a verb has a branching lexical entry like (146), then, it seems that the intransitive form of the verb will be simply the [-transitive] branch regardless of what usually occurs when the feature [-transitive] is added to a transitive verb in the language. This follows from the principle suggested above to the effect that, given a branching lexical entry like (146) with [α F] and [- α F] branches, attaching on [α F] affix to the alternate on the [- α F] branch yields the alternate on the [α F] branch and not the form expected from the productive use of the affix.

3.3 Ergativity. In section 2.2 above I noted that, within the present theory, it is an arbitrary fact about English that verbs usually assign theme and patient roles while predicates assign agent roles. Although, I claimed, languages must include generalizations over classes of semantic roles as to which are assigned to P-A structure internal arguments and which are assigned to logical subjects, a language may choose between the generalizations in (152) and those in (153) for verbs which are associated both with an agent and with a theme or patient.

(152) agent roles -- assigned by predicates
 theme and patient roles -- assigned by verbs

(153) agent roles -- assigned by verbs
 theme and patient roles -- assigned by predicates

Languages choosing generalizations (152) we call "nominative-accusative" languages; languages choosing generalizations (153) we call "ergative."²⁸ At this point in the exposition of the theory, it is possible to show that ergative languages, as defined above, exist. The theory of this dissertation predicts several crucial differences between nominative-accusative and ergative languages. On the basis of these predictions, we may conclude that Dyirbal, an Australian Aboriginal language discussed in Dixon (1972), and Central Arctic Eskimo (Johnson 1980) are truly ergative.

Before we turn to Dyirbal and Eskimo, some terminological confusions surrounding ergative languages should be cleared up. On the definition given above, many of the languages called "ergative" in the literature turn out to be nominative-accusative. These languages distribute case marking in such a way that, for the most part, the correspondence between semantic roles and case marking matches that for a true ergative language. To avoid

confusion, I have provided tables in (154) which indicate the correspondence among semantic roles, grammatical relations, and case marking for the various sorts of languages under discussion.

(154)	<u>Nominative-Accusative</u>		<u>Ergative</u>
agent	SUB of [+transitive], [+Pred SR]	V	OBJ of [+transitive], [+Pred SR] V
patient/theme	OBJ of [+transitive], [+Pred SR]	V	SUB of [+transitive], [+Pred SR] V

	<u>Case Marking</u>			
	<u>Nominative-Accusative Languages</u>		<u>Ergative Languages</u>	
	<u>A</u>	<u>B</u>	<u>A</u>	<u>B</u>
SUB of [-transitive] V	Nom	Nom (Abs)	Nom (Abs)	Nom
SUB of [+transitive] V	Nom	Acc (Erg)	Nom (Abs)	Acc
OBJ of [+transitive] V	Acc	Nom (Abs)	Acc (Erg)	Nom

In (154) I have called "Nom" (nominative) the case of the subject of an intransitive (tensed, matrix) verb. "Acc" (accusative) is the case of either the SUB or OBJ of a transitive verb--whichever case is not identical to the nominative case in the language. Nominative case is generally unmarked, i.e., phonologically null. Nominative case in an ergative language exhibiting type A case marking or in a nominative-accusative language exhibiting type B case marking is generally called "absolutive" (Abs) in the literature. Accusative case in these languages is called "ergative" (Erg). It is the nominative-accusative type B case marking languages which are usually identified as ergative. In fact, Mel'čuk (1979) explicitly defines ergative languages as those we have identified as nominative-accusative with type B case marking. Many languages employ both the A and B case marking paradigms, with the choice between the two conditioned by context or by the character of the NP to be case-marked. For example, a language may exhibit type A case marking in main clauses but type B in certain sorts

of subordinate clauses. Or non-pronominal noun phrases might show type A case marking while personal pronouns show type B case marking (as seems to be the case in Dyirbal, an ergative language). Languages which use both types of case marking displayed in (154) are said to have "split ergative" case marking (see Silverstein 1976 and DeLancey 1980 on split ergativity). The reader is asked to spend some time studying the tables in (154), for without a thorough understanding of these tables, the rest of this section is extremely difficult to follow.

Previous investigators (see, in particular, Dixon 1972 and Mel'čuk 1979) have attempted to show that Dyirbal, among other languages, is truly ergative as defined above, i.e., that the sole syntactic dependent of an intransitive verb and the theme or patient of a transitive verb are syntactic subjects in these languages. The methodology employed by these linguists is to demonstrate that the sole argument of the intransitive verb and the theme/patient of the transitive both exhibit "subject properties." Readers of previous proofs of ergativity were, therefore, persuaded that ergative languages exist to the extent that they believed the properties identified as "subject properties" must necessarily single out subjects. Consider the phenomenon of "topic-chaining" in Dyirbal (see Dixon 1972), which has sometimes been considered evidence for Dyirbal's ergativity. For purposes of discussion, let us call the class including subjects of intransitive verbs and the theme/patient arguments of transitive verbs the "absolute NPs" in Dyirbal (due to the split ergative case marking of Dyirbal, the members of this class will not always be case-marked in the absolute). A series of Dyirbal sentences may be conjoined in a "topic chain" if, roughly, the absolute NPs in the sentences are all coreferent. Only the absolute NP in the first sentence of a topic chain actually shows

up in surface structure; the remaining topics are phonologically null. Since topic chains resemble "control constructions" in English (see Section 2.6) and English subjects are controlled, one might argue that the conditions on the Dyirbal topic-chain construction indicate that Dyirbal absolutive NPs are subjects and that therefore Dyirbal is ergative. However, we do not have a theory which demands that the coreferent NPs in constructions like the Dyirbal topic chain be restricted to subjects. In fact, Dixon (1977) reports that Yidin, a language closely related to Dyirbal, exhibits a similar topic (coordination) construction in which the condition on coreference must be stated in terms of case marking, not grammatical relations.²⁹ The "topics" in the Yidin topic chain are the morphologically unmarked NPs. Due to split ergative case marking in Yidin, the morphologically unmarked NPs do not form a grammatical relationally homogeneous class. Since a rule creating the topic-chain construction need not pick out subjects, as evidenced in Yidin, that Dyirbal topic chains implicate absolutive NPs cannot serve as conclusive evidence that Dyirbal is ergative.

The theory presented in this dissertation makes specific predictions about ergative languages and about differences we should observe between ergative and nominative-accusative languages. For example, since the theory requires that an s structure SUB be the PRO in control constructions such as English, Elmer persuaded Hortense [PRO to buy a green procupine], it predicts that the theme/patient argument of a [+Pred SR],[+transitive] verb associated with an agent and theme or patient should be the PRO in such Equi constructions in ergative languages. In contrast, it is the agent argument of transitive verbs in nominative-accusative languages which is the PRO in Equi constructions. Unfortunately, the good candidates for ergative languages for which I have data do not exhibit clear cases of

"control" constructions in which this prediction might be tested out. There are data relevant to other predictions of the theory concerning ergative languages, however. Below I shall exploit these data to demonstrate that Dyirbal and Central Arctic Eskimo are truly ergative.

3.3.1. Passive in ergative languages. The passive verb form in a true ergative language has often been called the "antipassive." We defined "passivization" as the addition to a verb of a [-Pred SR] affix and "antipassivization" as the addition of a [-transitive] affix. As shown in (155) and (156) below, passivization in a true ergative language with type A case marking looks like antipassivization in a nominative-accusative type B case marking language as far as its effects on the correspondence between semantic roles and case marking are concerned. In both ergative type A passivization and nominative-accusative type B antipassivization, the ergative marked NP of the transitive verb form, usually the agent, corresponds to the absolutive marked NP of the derived, intransitive while the absolutive NP of the transitive, usually a theme or patient, corresponds to an oblique NP argument of the intransitive. In (155) I provide a schematic diagram of the effects of antipassivization on the association of semantic roles and surface cases in a nominative-accusative type B case marking language. See section 3.1.3 above for a more complete description of antipassivization in such a language--Greenlandic Eskimo.

(155) antipassivization in a nominative-accusative type B case marking language

a. active([+Pred SR], [+transitive]) verb

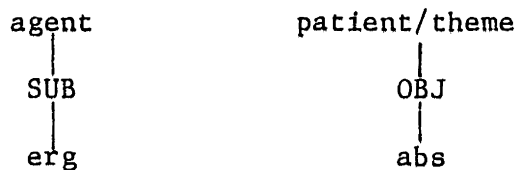

b. antipassive ([+Pred SR], [-transitive]) verb

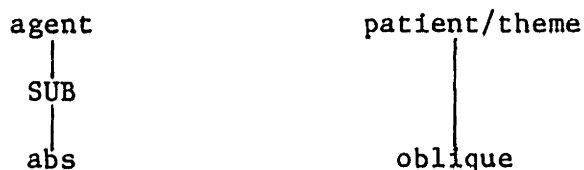

In (156) is a schematic diagram of the effects of passivization on the association of semantic roles and surface cases in an ergative type A case marking language. See below for a discussion of passivization in such a language.

(156) passivization in an ergative type A case marking language

a. active ([+Pred SR], [+transitive]) verb

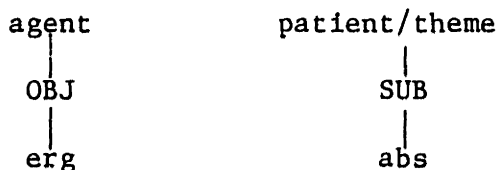

b. passive ([-Pred SR], [-transitive]) verb

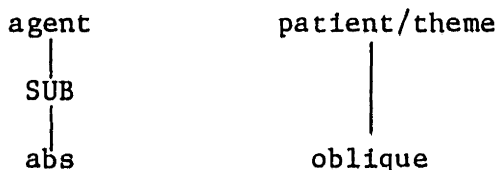

From the correspondences in (155) and (156) it should be clear that the fact that a verb form in a given language can be analyzed as a passive under the assumption that the language is ergative does not provide evidence that the language is in fact ergative. The verb form could be an antipassive and the language in question a nominative-accusative language with type B case marking. Although the discussion provides no evidence for the existence of ergative languages, I will run through an analysis of passivization in Dyirbal and Central Arctic Eskimo on the assumption that these languages are ergative. The exercise will give the reader some concrete examples of what it means to be ergative and present

some constructions crucial to later sections.

Consider the Central Arctic Eskimo (hereafter, Arctic) verb kapi- 'stab' and the Dyirbal verb durgay 'spear.' On the assumption that Arctic and Dyirbal are ergative, these verbs should have the P-A structures shown in (157).

- (157) a. kapi- 'stab' (agent) Arctic
 b. durgay 'spear' (agent) Dyirbal

The predicates produced by the P-A structures in (157) assign patient roles. The active, transitive forms of the verbs in (157) appear in sentences (158). Note that the transitive Arctic verb agrees with both its subject and object in person and number.

- (158) a. Piruutisi-up Siisa-∅ kapi-vaa. Arctic
 Brutus-ERG Caesar-ABS stab-IND3sg3sg
 'Brutus stabbed Caesar.'
 b. bayi bargan bangul yaṛangu ḍurganu. Dyirbal
 wallaby-ABS man-ERG spear
 'man is spearing wallaby.'

Since the verbs in (158) are [+Pred SR], [+transitive], their logical objects, which are assigned agent roles, will correspond to grammatical OBJs. The OBJs are marked ergative (accusative) in (158). The subjects in (158) bear patient roles and are marked absolutive (nominative).

If we passivize the verbs in (158), adding -si- in Arctic and -ṇay- in Dyirbal, the logical objects--agents--should correspond to grammatical SUBs and show up in the absolutive case. Both Arctic and Dyirbal have case markings which serve the same function in these languages as by serves in English. In Arctic this is the comitative case, in Dyirbal the instrumental or the dative (see Dixon 1972 (p.66) for a discussion of the differences between these two case markings in the -ṇay- construction). Passive sentences corresponding to the actives in (158) are found in (159). Note that the agents appear in the absolutive case, the patients in the

comitative (Arctic) or dative or instrumental (Dyirbal). Note also that the passive form of the Arctic verb, being intransitive, agrees only with its subject, which appears in the absolutive.

- (159) a. Piruutisi-∅ Siisa-mik kapi-si vuq. Arctic
 Brutus-ABS Caesar-COM stab-PASS-IND3sg
 'Brutus stabbed Caesar.'
- b. bari yaça {bagul bargangu, baḡgul bargandu} duḡḡanapu.
 Dyirbal
 man-ABS {wallaby-DAT, wallaby-INST} spear-PASS
 'man is spearing wallaby.'

3.3.2. Dative shift in ergative languages. The present theory makes an interesting prediction about the dative shift alternation in ergative languages. We may characterize a dative shifted construction as one containing a theme or patient argument and another argument not bearing a theme or patient role which appears in the usual expression of themes or patients in the language. In nominative-accusative languages, whose theme and patient roles are canonically assigned to direct objects, dative shifted constructions contain non-theme or patient arguments expressed as direct objects are usually expressed. I argued above that, given certain assumptions, these non-theme/patient arguments must, in fact, be OBJs. On the other hand, since themes and patients are canonically assigned to subjects in ergative languages, expressing, say, a goal as themes and patients usually are expressed in these languages involves putting the goal in the case of subjects.

Consider the dative shift alternations in Arctic and Dyirbal illustrated in (160-161).

- (160) a. anguti-up titiraut nutarar-mut tuni-vaa. Arctic
 man-ERG pencil-ABS child-ALL give-IND3sg3sg
 'The man gave a pencil to the child.'
- b. anguti-up titirauti-mik nutaraq tuni-vaa.
 man-ERG pencil-COM child-ABS give-IND3sg3sg
 'The man gave the child a pencil.'

- (161) a. balam bangun wugan bagul. Dyirbal
 it(food)-ABS she-ERG give he-DAT
 'She gives food to him.'
- b. bayi bangun bangum wugan.
 him-APS she-ERG it-INST give
 'She gives him food.'

In the a. sentences of (160-161) the theme argument is in the absolutive and the goal argument is in the allative or dative. We may assume that the dative and allative cases assign the goal role in these sentences. The presumed P-A structures for the verbs in (160a) and (161a) are given in (162), with the semantic roles of the logical objects underlined.

- (162) a. tuni- 'give' (agent, goal)
 b. wugal 'give' (agent, goal)

Since the a. and b. sentences in (160) and (161) have the same propositional content, there is no reason to believe that tuni- and wugal in (160b) and (161b) do not have the same P-A structures as the homophonous verbs in (160a-161a). Since the absolutive case cannot be argued to assign the goal role to the goal arguments in the b. sentences of (160-161), either the verb or the predicate in these sentences must assign that role. If the verbs in (160b-161b) are to have the same P-A structures as the verbs in (160a-161a), however, the predicates in (160b-161b) cannot assign the goal role--the predicates produced by the P-A structures in (162) assign the theme role. Therefore, the verbs in (160b-161b) must assign the goal role; the goal arguments in (160b-161b) are logical objects. Although the verbs in (160b-161b) assign the goal roles, the goal arguments appear in absolutive case, the case of subjects. If the goal arguments—logical objects in (160b-161b) are to be the syntactic SUBs of these sentences, the verbs in (160b-161b) must be [-Pred SR], for if they were [+Pred SR], the theme arguments, i.e., the logical subjects, would be SUBs. In summary, our theory forces us to propose lexical entries for the verbs in (160b-161b)

A dative shift construction involves the expression of a non-theme/patient argument as themes and patients are usually expressed. Because themes and patients are assigned by predicates in ergative languages, expressing the goal argument of a verb like 'give' as themes and patients are usually expressed involves making the goal argument a subject. The only way to make the goal argument a subject while satisfying the principle that, all other things being equal, related verbs share P-A structures is to have the verbs in a dative shifted construction assign the goal role and to make the verbs [-Pred SR], as shown in (163). This analysis of the dative shift alternation in ergative languages makes two related predictions. First, since the verb in a dative shifted sentence like (160b) or (161b) is [-Pred SR], if a constituent is to bear the theme role, i.e., the role of the logical subject, in such a sentence, the theme role must be assigned by the semantic role assigner serving the function of English by in the language in question. That is, the theme argument should be expressed as are the "displaced subjects" in passive constructions. Recall that the displaced subject in an Arctic passive falls in the comitative case (see (159a) above), the displaced subject of the Dyirbal passive in the instrumental or dative (see (159b) above). When the goal argument of the verb meaning 'give' is in the absolutive in these languages, indicating it is the subject, we find the theme in the comitative (Arctic) or instrumental (Dyirbal), as expected--see (160b-161b).

If Eskimo and Dyirbal were nominative-accusative languages with type B case marking, we would probably expect double absolutive constructions with the verbs meaning 'give,' just as we find double object constructions in English and Chi-Mwi:ni and double accusative constructions in Yindjibarndi—see 3.2.1.1 above. The verbs in the a.sentences of (160-161) above would include (166) in their lexical entries on the nominative-accusative analysis of

Arctic and Dyirbal.

- (166) a. tuni- 'give' (theme, goal) Arctic
 b. wugal 'give' (theme, goal) Dyirbal

If the verbs tuni- and wugal in (160b-161b) assigned goal roles instead of theme roles, the usual expression of themes, absolutive case, would be expected to assign the theme roles. The verbs in the b. sentences of (160-161), then, would be expected to include (16⁷~~9~~) in their lexical entries.

- (167) a. tuni- 'give' (theme, goal) Arctic
 b. wugal 'give' (theme, goal) Dyirbal

If (167a&b) were included in the lexical entries for the verbs in (160b-161b), as required on the hypothesis that Arctic and Dyirbal are nominative-accusative, we would wrongly expect both the theme and goal arguments in (160b-161b) to appear in the absolutive--the theme arguments because they would be assigned their semantic roles by absolutive case, the goal arguments because they would be OBJs. On the other hand, the hypothesis that Arctic and Dyirbal are ergative correctly predicts the case marking on the themes in (160b-161b), as demonstrated above. In general, the theory predicts that true ergative languages should not exhibit double absolutive constructions with verbs like 'give.'

As explained above, a nominative-accusative language with type B case marking would be expected to show double absolutive constructions with 'give.' The existence of a nominative-accusative type B case marking language with double absolutive constructions would demonstrate that the failure of Arctic and Dyirbal to exhibit such constructions is unrelated to "ergative case marking," i.e., the marking of themes and patients of transitive verbs in the same manner as subjects of intransitive verbs. Donaldson (1980) provides conclusive evidence that Ngiyambaa, an Australian Aboriginal language, is, in our terms, nominative-accusative with type B case marking. It is the agent NP of a transitive clause, marked ergative in main clauses

(if non-pronominal), and the absolutive NP of an intransitive clause that become PRO in a variety of control constructions in Ngiyambaa (see Donaldson 1980, pp. 280-281), indicating that the agent in a transitive clause and the absolutive in an intransitive are SUBs in the technical sense (see section 2.6). Since the agent of a transitive Ngiyambaa sentence appears in the ergative case, the theme or patient in the absolutive, it should be clear from the tables in (154) that these facts about control constructions in Ngiyambaa show that it is indeed a nominative-accusative language with type B case marking. And, as expected, both the theme and the goal arguments of the verb meaning 'give' appear in the absolutive in a dative shifted construction.

(168) *guya=ndu bura:y nu-nhi. Ngiyambaa*
fish-ABS you-NOM child-ABS give-PAST
 'You gave a child fish.'

(The agent (SUB) in (168) appears in the "nominative" case because Ngiyambaa actually has a split case marking system. 2nd person pronouns display the type A pattern in Table (154), while non-pronominal NPs use type B. Pronouns may appear as clitics, as shown in (168).

In addition to predicting the case marking on the theme in a dative shifted construction, the above analysis of dative shift in the ergative languages predicts that the verbs which head the dative shifted sentences, those in (160b-161b), should not passivize. Recall that a morphological principle, (15) above, prevents the passive morpheme from attaching to a [-Pred SR] verb. Since our theory forces us to analyze the verbs in (160b-161b) as [-Pred SR] (see (163) above), it predicts that these verbs should have no passive versions. It is difficult to demonstrate that this prediction is correct because, in the present theory, even if the passive morpheme could attach to the verbs in (160b-161b), the derived verbs could not head a grammatical sentence. Consider the results of

adding the passive morpheme to the verbs in (163):

(169) tuni-si, wugal-nay 'give' (agent, goal) [-Pred SR], [-transitive]

Since the verbs in (169) are [-transitive], the two logical objects in an l-s structure containing the verbs would compete for SUB status in the corresponding s structure. The loser would violate principle (66), Chapter 2, as its s structure counterpart would not be head-Governed by the passive verb. As a result, there is no ungrammatical sentence I can point to to confirm the prediction that the verbs in (160b-161b) have no passives. Arctic tuni- 'give' and Dyirbal wugal 'give' do have passive forms, which are shown in sentences (170). But the verbs in (170) are arguably passives of (162), the verbs in the a. sentences of (160-161).

- (170) a. angut titirauti-mik nutarar-mut tuni-si-vuq. Arctic
 man-ABS pencil-COM child-ALL give-PASS-IND3sg
 'The man gave a pencil to the child.'
- b. ...yuɽingu ɽulguŋgu wugalnaygu bagul nalŋgagu. Dyirbal
 kangaroo-INST heart-INST give-PASS-PURP there-DAT child-DAT
 ...in order that he [not specified in sentence] might give
 a kangaroo's heart to the child.'

Although it is impossible to provide ungrammatical sentences to confirm the prediction that (160b-161b) have no passive counterparts, the prediction may be used to support the hypothesis that Arctic and Dyirbal are ergative over the alternate hypothesis that they are nominative-accusative with type B case marking. The hypothesis that Arctic and Dyirbal are nominative-accusative would predict that the tuni- 'give' in (160b) should have a -si- form and the wugal 'give' in (161b) a -nay- form. In the case of Arctic, at least, the sentences this alternate hypothesis predicts should be grammatical are known to be ungrammatical. The crucial data are not yet available from Dyirbal (Dixon, personal communication).

Consider again a nominative-accusative analysis of Arctic. What we have called "passivization" in Arctic on the ergative analysis would be

considered antipassivization on the nominative-accusative analysis, i.e., the morpheme -si- would carry only the feature [-transitive] and would provide a syntactic role assigner, the comitative case, for the logical objects of the verbs to which it attaches.

- (171) a. Piruutisi-up Siisa kapi-vaa.
 Brutus-ERG Caesar-Abs stab-IND3sg3sg
 'Brutus stabbed Caesar.'
- b. Piruutisi Siisa-mik kapi-si-vuq.
 Brutus-Abs Caesar-COM stab-ANTIPASS-IND3sg
 'Brutus stabbed Caesar.'

On a nonimative-accusative analysis, Piruutusi 'Brutus' is the subject of (171a) and Siisa 'Caesar' the object. Antipassivization leaves Piruutisi 'Brutus' as the subject of the derived intransitive verb in (171b), but Siisa 'Caesar' becomes an oblique argument of the verb. Piruutisi 'Brutus' bears the ergative case in (171a) as the subject of a transitive verb, the absolutive in (171b) as the subject of an intransitive.

As explained above, the lexical entry for tuni- 'give' in (160a) would include the information in (172a) on a nominative-accusative analysis, and the entry for tuni- 'give' in the dative shifted (160b) would include the information in (172b).

- (172) a. tuni- 'give' (theme, goal) [+Pred SR], [+transitive]
 b. tuni- 'give' (theme, goal) [+Pred SR], [+transitive]

Now there is absolutely no reason why -si-, analyzed as an antipassive affix, should not attach to the verb in (172b), yielding (173), which would be a partial entry for the verb in sentence (174).³⁰

- (173) tuni-si- 'give' (theme, goal) [+Pred SR], [-transitive]
 [COM—]
- (174) *angut titirauti-mik nutarar-mik tuni-si-vuq.
 man-Abs pencil-COM child-COM give-ANTIPASS-IND3sg
 'The man gave a pencil to the child.'

But (174) is ungrammatical. In short, the ergative analysis of Arctic predicts that -si- should not attach to the verb in (160b). On the other hand, the nominative-accusative analysis predicts that -si- will attach to the verb in (160b), yielding the verb in (174). The ungrammaticality of (174) thus supports the ergative over the nominative-accusative analysis of Arctic.³¹

3.3.3. Lexical reflexives in ergative languages. Perhaps the most convincing demonstration of the existence of ergative languages derives from a prediction our theory makes about lexical reflexive forms in these languages. Recall that the theory predicts a homophony between the reflexive and passive forms of a verb. Since the patient or theme of a transitive verb is the subject of the passive of this verb in a nominative-accusative language, this prediction leads us to expect a sentence meaning, 'He washes himself' to mean also, 'He is washed' (see the Albanian sentence (88)). In contrast, since it is the agent of a transitive verb which is the subject of the passive form of the verb in an ergative language, (see the passives in (159)) we expect a sentence meaning, 'He is washed' to mean also, 'He washes (something unspecified)' in such a language. The prediction of our theory about reflexive forms in ergative languages is confirmed directly in Dyirbal, indirectly in Arctic.

The Dyirbal affix -riy- (which has various allomorphs), is used to form the reflexive of a transitive verb. In (175a) we find a simple transitive Dyirbal sentence containing buybal 'hide.' The reflexive form of buybal 'hide' is the verb in (175b).

- (175) a. bala yugu baṅgul yaṅaṅgu buyba.ɪ.
 stick-ABS man-ERG hides
 'man hides stick'

- b. bayi yağa buybayiriyu.
 man-ABS hides-REFL
 'man hides himself' or 'man hides (something).'

According to the (non-clitic) analysis of lexical reflexives supported above, the verb in (175a) should have a lexical entry like (176a), the verb in (175b), an entry like (176b).

- (176) a. buybal, V, 'hide' (agent), [+Pred SR], [+transitive]
 b. buybayiriy (=buybal + REFL), V, 'hide' (agent), [-Pred SR], [-transitive]; ('by' (reflexive-pronoun-features), [+transitive])

Suppose we insert the verb in (176b) into sentence (175b) and choose to take the features in parentheses. The by features of the REFL affix in (176b) will assign the role of the logical subject--the "hid" role--to its reflexive pronoun features. Since the verb in (176b) is [-Pred SR], [-transitive], the logical object, which is assigned the agent role, will correspond to the syntactic SUB and serve as antecedent for the reflexive pronoun features of REFL, which are assigned the "hid" role. The SUB will thus be interpreted as both the "hider" and the "hid," yielding the reflexive interpretation of (175b), 'The man hides himself.' As noted in (175b), the Dyirbal reflexive verb form also has a passive reading. This results when we insert the verb in (176b) into sentence (176b) without choosing the features in parentheses. Since the derived verb in (175b) is [-Pred SR], [-transitive] in this case as well, the logical object, the agent argument, corresponds to the SUB of the sentence. Without the features in parentheses in (176b), the logical subject or "hid" role is not assigned to reflexive pronoun features by an affix on the verb. Thus the subject of sentence (175b) is interpreted as the agent only and the sentence means, 'The man hides (something unspecified).' As predicted by the hypothesis that Dyirbal is truly ergative then, a reflexive sentence like (175b), in addition to its reflexive reading, has the interpretation, 'The man hides

something,' and not, 'The man is hid.'

Dixon (1972) calls the non-reflexive use of the reflexive verb form the "false reflexive." As Dixon is careful to point out (p. 91), the false reflexive has the same syntax as the -nay- verb form, which we have identified as the passive. Compare the active-false reflexive pair in (177) with the active-passive pair (178).

- (177) a. balam wuđu baᅅgul yaᅅaᅅgu ᅅaᅅgaᅅu.
 fruit-ABS man-ERG eat
 'The man is eating fruit.'
- b. bayi yaᅅa ᅅaᅅgaymaripu (baᅅum wuđuᅅu).
 man-ABS eat-REFL (fruit-DAT)
 'The man is eating (fruit).'
- (178) a. bayi bargan baᅅgul yaᅅaᅅgu ᅅurᅅaᅅu.
 wallaby-ABS man-ERG spear
 'man is spearing wallaby.'
- b. bayi yaᅅa baᅅul bargangu ᅅurᅅanaᅅu.
 man-ABS wallaby-DAT spear-PASS
 'man is spearing wallaby.'

Note that the subjects in the active sentences of (177-178), marked absolutive, correspond to a dative marked noun phrase in the b. sentences.

Dixon notes that the instrumental may also be used to mark the "displaced subject" of a false reflexive, just as it may in a -nay- construction.

The objects, marked ergative, in the a. sentences of (177-178) correspond to the subjects, marked absolutive, of the b. sentences. If the dative noun phrase is left out of the false reflexive in (177b), it may be interpreted as a true reflexive, meaning, 'The man is eating himself,' say, chewing on a finger.

In Central Arctic Eskimo, the reflexive pronouns have neither ergative nor absolutive forms. Therefore, one cannot say, 'I saw myself,' with 'I' in the absolutive and 'self' in the ergative, or with 'self' in the absolutive and 'I' in the ergative. To form the reflexive of a transitive sentence, one uses the unmarked intransitive form of the transitive verb; i.e., one

conjugates the verb with endings which agree with one NP only. In addition, one uses a reflexive pronoun in the comitative. The examples in (179) are adapted from Johnson (personal communication).

- (179) a. uvammik taku-vunga.
 myself-COM see-IND1sg
 'I see myself.'
 b. angut ingminik kapi-vuq.
 man-ABS himself-COM stab-IND3sg
 'The man stabbed himself.'

Now the unmarked intransitive form of a verb in Arctic, if one is possible outside the reflexive construction, is generally used for the passive (but see section 3.3.4 below). An example of an unmarked intransitive used for a passive is given in (180a); a reflexive is shown in (180b) for comparison.

- (180) a. angut arnar-mik taku-vuq.
 man-ABS woman-COM see-IND3sg
 'The man sees the woman.'
 b. angut ingminik taku-vuq.
 man-ABS himself-COM see-IND3sg
 'The man sees himself.'

It should be clear from an examination of (180) that, just as in Dyirbal, the passive and reflexive constructions have the same syntax in Arctic. As in Dyirbal, the subject of the reflexive verb form, in the absolutive, corresponds to the agent of the passive construction, not the patient or theme as we would expect in a nominative-accusative language. Lexical reflexivization in Arctic, as in all languages which use the non-clitic analysis, involves the attachment of the features [-Pred SR], [-transitive] to a transitive verb and the assignment of the semantic role of the predicate produced by the verb to a reflexive element. In Arctic, unlike the other languages we have examined, the reflexive element is phonologically realized distinct from the reflexive affix--as a reflexive pronoun in the comitative case, the case which, we have seen, assigns the semantic roles of predicates in Arctic passive sentences (see, e.g., (159a)).

The remarkable support the Arctic reflexive construction offers our analysis of lexical reflexives and ergative languages becomes clearer when we compare Central Arctic Eskimo with Greenlandic Eskimo, a related language discussed in Sadock (1980), Woodbury (1977 a & b), and Swadesh (1944) (see also the discussion of Greenlandic in 3.1.2 above). Greenlandic resembles Arctic very closely. Like Arctic, it marks the agents of transitive verbs ergative and the patients or themes absolutive; therefore, it is either a true ergative language or a nominative-accusative language with type B case marking. However, according to Sadock (1980) and the other sources cited, the absolutive NP of the unmarked intransitive form of a Greenlandic verb usually corresponds to the absolutive NP of its transitive counterpart, not the ergative NP as in Arctic (but see section 3.3.4 below).³²

- (181) Greenlandic Eskimo from Sadock (1980)
- a. Piniartoq toquppaa.
hunter-ABS kill-IND3sg3sg
'He killed the hunter.'
 - b. Piniartoq toquppoq.
hunter-ABS kill-IND3sg
'The hunter was killed.'

The difference between Arctic and Greenlandic unmarked intransitives is clearly displayed in (182). The subject of the unmarked intransitive form of taku- 'see' is the 'seer' in Arctic but the 'seen' in Greenlandic.

- (182) a. angut taku-vuq. Arctic
man-ABS see-IND3sg
'The man sees (something).'
- b. Tigianaq taku-vuq. Greenlandic (Woodbury 1977a, ex. (45))
fox-ABS see-IND3sg
'The fox was seen.'

The unmarked intransitive form of a verb in Greenlandic may be used for the reflexive. Unlike Arctic, Greenlandic does not require a reflexive pronoun in reflexive constructions with the unmarked intransitive verb.

- (183) Piniartog toquppoq.
 hunter-ABS kill-IND3sg
 'The hunter was killed.' or
 'The hunter killed himself.'

Since the sentence, (183), meaning, 'The hunter killed himself,' may also mean, 'The hunter was killed,' in Greenlandic, this dialect of Eskimo proves to be a nominative-accusative language with type B case marking according to the criterion established above. Our theory predicts that the reflexive will be synonymous with the passive in a language. If (183) is a passive, then its subject--the patient argument--must be the logical object of the verb. But if the patient arguments of verbs like toqupp- 'kill' are logical objects in Greenlandic, the language is nominative-accusative (see (152) above).

Although a reflexive pronoun is not obligatory in Greenlandic reflexive constructions, a reflexive pronoun in the allative may co-occur with reflexive verbs.

- (184) Piniartog imminut toquppoq.
 hunter-ABS self-ALL kill-IND3sg
 'The hunter killed himself.'

If our analysis of lexical reflexivization is correct, the allative should be the case which serves the by function in Greenlandic, i.e., marks the "displaced subjects" in passive constructions. The reflexive verb in (184) itself should be [-Pred SR], so the predicate it heads will not assign the logical subject role and an item with the properties of English by is required in (184) to assign this role to the reflexive pronoun. In fact, as Woodbury (1977a) reports, the allative is one of the cases in which the displaced subject of a passive may appear.

- (185) Greenlandic from Woodbury (1977a, p. 324)
 a. Aput-ip arnaq taku-vaa
 man-ERG woman-ABS see-IND3sg3sg
 'The man saw the woman.'

- b. Arnaq aṅuti-mut taku-tau-puq.
 woman-ABS man-ALL see-PASS-IND3sg
 'The woman was seen by the man.'

Note the Greenlandic passive morpheme, -tau-, in (185b) (see section 3.1.2 for a discussion of Greenlandic passivization).

The predicted differences between reflexive constructions in nominative-accusative and ergative languages are clearly illustrated in (186-187), which contain passives (186) and reflexives (187) from Arctic and Greenlandic.

- (186) a. Central Arctic passive
 angut arnar-mik taku-vuq.
 man-ABS woman-COM see-IND3sg
 'The man sees the woman.'
- b. Greenlandic passive
 Arnaq aṅuti-mut taku-tau-puq.
 woman-ABS man-ALL see-PASS-IND3sg
 'The woman was seen by the man.'
- (187) a. Central Arctic reflexive
 angut ingminik taku-vuq.
 man-ABS self-COM see-IND3sg
 'The man sees himself.'
- b. Greenlandic reflexive
 Aṅut inmi-nut taku-vuq.
 man-ABS self-ALL see-IND3sg
 'The man saw himself.'

It should be clear from a comparison of the passives and reflexives in (186) and (187) that the subject of an Arctic reflexive bears the agent role while the subject of a Greenlandic reflexive bears the patient or theme role (for verbs which are associated with an agent and a theme or patient). Since our analysis of lexical reflexives makes the logical object the grammatical subject of a reflexive verb form, we may conclude that the 'seer' is the logical object of Arctic taku- 'see' while the 'seen' is the logical object of Greenlandic taku- 'see,' i.e., that Arctic is ergative, Greenlandic nominative-accusative.

3.3.4. Appendix to 3.3: Unmarked intransitive forms of Eskimo transitive verbs. I must qualify here the generalization referred to above that the unmarked intransitive forms of Arctic and Greenlandic transitive verbs are the passive, i.e. [-Pred SR], [-transitive], counterparts of their transitive forms. Eskimo transitive verbs may be divided into at least five different classes on the basis of the relationship between their transitive and unmarked intransitive forms (see Woodbury 1977b); the generalization concerning intransitives and passives holds for only one of these classes. As far as I have been able to discover, cognate verbs in the various Eskimo dialects generally fall into the same classes regardless of whether the dialects would be considered nominative-accusative or ergative in the present theory. First, some transitive verbs have no unmarked intransitive forms--outside the reflexive construction at least. (Johnson (personal communication) reports that the intransitive conjugation of the Arctic verbs in this class appear in the reflexive construction discussed above). Second, the intransitive forms of some transitive verbs have an "inchoative" or a "stative" reading. Inchoatives and statives were discussed in section 3.2.2.1 above. An inchoative of a basic transitive verb like English break is an intransitive verb which lacks the causative implications of its transitive counterpart. Compare transitive break in, Elmer broke the glass with intransitive, inchoative break in The glass broke. The stative of a verb like English hang is an intransitive verb that lacks the causative and punctual implications of its intransitive counterpart. Compare transitive hang in, Elmer hung the clothes out to dry, with intransitive, stative hang in, The clothes are hanging out to dry. The English glosses of the Eskimo verbs in this class often show inchoatives and statives as their unmarked intransitive counterparts.

The examples of this class in (188) are from Alaskan Yup'ik (Reed et al. 1977), which is closely related to Arctic.

(188)	Transitive	Intransitive
a.	Tamaraa. 'He (ERG) loses it (ABS).'	a. Tamaruq. 'It (ABS) is lost.' stative
b.	Kuvaa. 'He (ERG) spills it (ABS).'	b. Kuv'uq. 'It (ABS) spills.' inchoative

In section 3.2.2.1 above I explained why the unmarked intransitive form of transitive verbs like 'lose,' 'hang,' 'spill,' 'break,' 'open,' etc. in a language should be expected to serve as their stative or inchoative counterparts regardless of whether the language is nominative-accusative or ergative.

The third class of Eskimo transitive verbs corresponds to the "indefinite object deleting" verbs of English, e.g., eat. As Sadock remarks about Greenlandic (1980, pp. 304-305),

In many instances where the English counterpart is an object-deleting verb, the Greenlandic intransitive formed [by changing from transitive to intransitive agreement suffixes] has roughly the meaning of the corresponding English intransitive.

(189)	a.	Neqi nerivara. mean-ABS eat-IND1sg3sg 'I ate the meat.'
	b.	Nerivunga. eat-IND1sg 'I ate (something).'

Indefinite object deletion was discussed in section 3.2.2.2 above, where I explained why the unmarked intransitive form of verbs like 'eat' in a language might have the 'eater' as subject regardless of whether the language is nominative-accusative or ergative. A fourth class of Eskimo transitive verbs, described in Woodbury (1977b), should be analyzed as derived from their unmarked intransitive counterparts. Some Greenlandic examples are given in (190) (I have no evidence that this class exists in

any of the other Eskimo dialects).

- | | | |
|-------|--|---------------------------------------|
| (190) | Transitive | Intransitive |
| a. | Tikipaa. 'He (ERG) has come to it (ABS).' | b. Tikippuq. 'He (ABS) has come.' |
| a. | Analavaa. 'He (ERG) walks through it (ABS).' | b. Aṅalavuq. 'He (ABS) walks around.' |

For many verbs of this class, the unmarked intransitive verb is a verb of motion; the extra argument of the transitive verb indicates a direction.³³

Again, cognate transitive verbs in the various Eskimo dialects more or less fall into the same classes regardless of whether we would identify them as nominative-accusative or ergative on independent grounds. For example, the subject of intransitive 'eat' in all dialects will be the eater, the subject of intransitive 'lost' the thing lost. Removing the four classes of basic transitive verbs described above from the transitive verb of an Eskimo dialect leaves a fifth class. It is this fifth class for which the generalization that the unmarked intransitive form of a transitive verb serves as the passive is supposed to hold. Cognate unmarked intransitive verbs from this class should therefore exhibit the distinction between passivization in a nominative-accusative Eskimo dialect like Greenlandic and passivization in an ergative dialect like Arctic as to which semantic role is born by the subject of the passive verb. This distinction was illustrated in (182), repeated here.

- | | | |
|-------|----|--------------------------------|
| (182) | a. | angut taku-vuq. Arctic |
| | | man-ABS see-IND3sg |
| | | 'The man sees (something).' |
| | b. | Tigianaq taku-vuq. Greenlandic |
| | | fox-ABS see-IND3sg |
| | | 'The fox was seen.' |

3.4. Alternations in the expression of a verb's semantic dependents

mediated by affixation of morphemes with independent argument structures. I have assumed a general principle governing morphemes with semantic role assigning features or argument structures, repeated here as (191)

(191) Principle: If a lexical item assigns a semantic role or has an argument structure, it is an independent constituent at l-s structure.

Since they carry argument structures, by principle (191) the affixes to be discussed in this section must appear as independent items in l-s structure. However, as affixes are attached to roots in the lexicon, derived words are inserted whole into deep structure and appear whole in surface structure. Therefore, affixes carrying their own argument structures must "merge" with the roots to which they attach somewhere between l-s structure and surface structure. The merger of l-s constituents between l-s and s structure affects the correspondence between l-s and s structure constituents, rendering inoperable the definitions of the s structure counterpart of an l-s constituent provided in Chapter Two. Before turning to actual examples of merger, I will present the new principles which determine the s structure counterparts of l-s constituents after merger.

Recall the schematic example of merger discussed in the introduction to this chapter. An affix, -AF, with the modifier-argument structure shown in (192) names a function from arguments to modifiers of predicates.

(192) 'AF' (.....)

The root verb, V, to which the affix -AF will attach, has the predicate-argument structure shown in (193).

(193) 'V' (.....)

I claimed in the introduction to this chapter that the merger of two argument-taking items between l-s and s structure expresses the l-s relation between l-s constituents the items head. Now -AF will head a predicate modifier in l-s structure; V will head a predicate. If the merger of V and -AF is to express an l-s

relation between l-s constituents which these items head, the modifier -AF heads should modify the predicate V heads at l-s structure. An l-s structure containing the items V and -AF is shown in (194). The internal structure of the combination of V and -AF is given in (195).

(194)

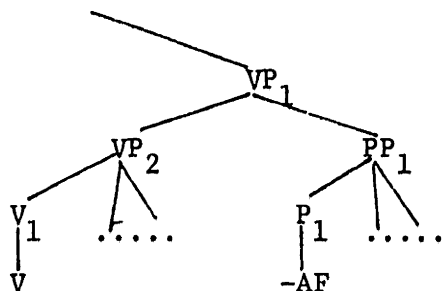

(195)

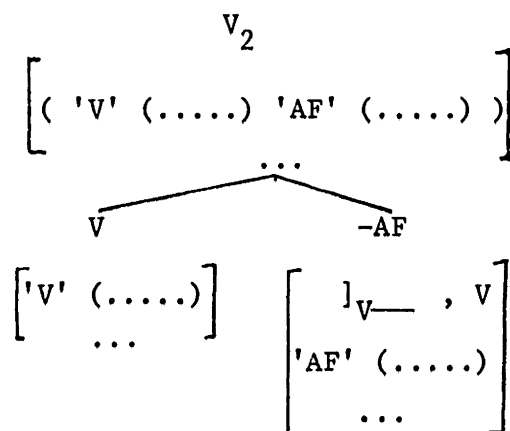

The modifier-modifiee relation between PP_1 and VP_2 in (194) is expressed by the merger of V_1 and P_1 into the single complex verb, V_2 , at s structure. Let us introduce a new grammatical relation, the relation between merged constituents at s structure. When distinct l-s lexical items X and Y form a single s structure constituent, we say that X and Y stand in the "merger" relation with respect to one another at s structure, or $MER(X, Y)$. In our example, -AF or P_1 stands in the merger relation with respect to V or V_1 , i.e., $MER(P_1, V_1)$. Now if $MER(P_1, V_1)$ expresses $mod(PP_1, VP_2)$, we must arrange things such that the correspondence between $mod(PP_1, VP_2)$ and $MER(P_1, V_1)$ satisfies principle (66) in Chapter Two. This correspondence would satisfy principle (66) if the s structure counterparts of PP_1 and VP_2 were P_1 and V_1 respectively. Since P_1 and V_1 stand in a grammatical relation with respect to one another--the merger relation-- P_1 governs V_1 . So

if the s structure counterparts of PP_1 and VP_1 are P_1 and V_1 respectively, the s structure counterpart of PP_1 will head-Govern the s structure counterpart of VP_2 .

More generally, consider two l-s constituents XP and YP with lexical heads X and Y (if XP or YP is a lexical item, it will serve as its own lexical head). If the merger of X and Y at s structure expresses the l-s relation between XP and YP, $r(XP, YP)$, then the s structure counterpart of XP is X and the s structure counterpart of YP is Y. Principle (66) will have $r(XP, YP)$ correspond to $MER(X, Y)$.

The merger of l-s constituents reduces the number of constituents in the mapping from l-s to s structure. For example, the merger of P_1 and V_1 in (194) maps both PP_1 and P_1 onto the single s structure constituent, P_1 . It should be clear that merger affects the definition of the s structure counterpart of an l-s phrase given in (67) of Chapter Two and repeated here.

(196) The s structure counterpart of an l-s phrase X with immediate head Y is the s structure constituent whose immediate head is the s structure counterpart of Y.

Suppose we apply (196) to VP_2 in (194). The immediate head of VP_2 is V_1 and the s structure counterpart of V_1 , a lexical item, should be V_1 itself. But V_1 merges with P_1 at s structure into a derived verb, V_2 . Since V_1 by itself does not head anything in s structure, the notion "s structure counterpart of an l-s phrase" in (196) is ill-defined when applied to VP_2 . Of course, we have handled this case in our formulation of merger; since the merger of V_1 and P_1 expresses $\text{mod}(PP_1, VP_1)$, the s structure counterpart of VP_2 is V_1 .

Consider now VP_1 in (194). The immediate head of VP_1 is VP_2 and the s structure counterpart of VP_2 is V_1 . But V_1 , as we have seen, does not head a constituent at s structure--it is part of the derived verb V_2 . So again definition (196) breaks down. The predicate VP_1 in (194) results from applying the modifier produced by P_1 and its arguments to the predicate produced by V_1 and its arguments. Look at the internal structure of V_2 in (195). Given arguments, the complex P-A

structure of V_2 produces predicates by applying the modifiers produced by the P_1 ('AF') function to the predicates produced by the V_1 ('V') function. Clearly, given the same arguments as V_1 and P_1 receive in (194), V_2 will produce the predicate VP_1 . Since V_2 plus its arguments produce VP_1 , the s structure counterpart of VP_1 should be the s structure phrase immediately headed by V_2 .

More generally, consider an l-s phrase X, with daughters Y and Z, Y the head of X. If the l-s relation between Y and Z corresponds to a merger relation between the lexical heads of Y and Z, then the s structure counterpart of X is the s structure phrase immediately headed by the derived word which is the combination of the lexical heads of Y and X.

Although we stated in Chapter Two that the s structure counterpart of a lexical item at l-s structure is the item itself, there is a problem with identifying the s structure counterparts of lexical items in merger constructions when applying principle (66). Consider again our example of the affix -AF, which has a modifier-argument structure, merging with verb V, which has a P-A structure. Suppose both -AF and V are semantic role assigners, as shown in (197).

(197) a. 'AF' (SR₁)

b. 'V' (SR₂)

Consider the l-s structure in (198), where NP_1 is the logical object of V and NP_2 the logical object of -AF.

(198)

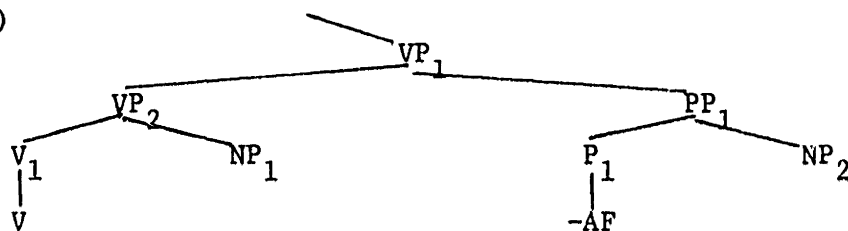

The verb V and -AF merge at s structure to form the derived verb V_2 with the internal structure given in (199).

(199)

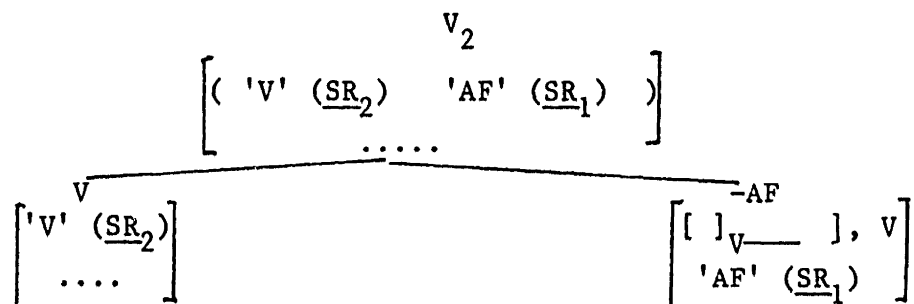

Percolation of the semantic role assigning features of -AF should identify V_2 as the assigner of the SR_1 semantic role. If the language under consideration allows verbs to assign only one role in the unmarked case, percolation of the semantic role assigning properties of the affix -AF will prevent percolation of the semantic role assigning properties of the root, V.

Since V_2 may be seen as assigning SR_1 , in some sense V_2 is the s structure counterpart of -AF with respect to the logical object relation between -AF and NP_2 in l-s structure (198). It turns out that the correct predictions for the syntax of merger constructions follow from our principles only if we adopt this relativized notion of the s structure counterpart of an l-s constituent when applying principle (66). If $r(X, Y)$ and $MER(X, Z)$, the s structure counterpart of X relative to $r(X, Y)$ must be determined by examining the internal structure of the derived word consisting of X and Z. The s structure counterpart of X relative to $r(X, Y)$ will be either or this derived word, depending on feature percolation. However, for purposes of applying definition (196) to find the s structure counterpart of a phrase headed by lexical item X at l-s structure, the s structure counterpart of X will always be X. To repeat, the s structure counterpart of -AF with respect to $obj(-AF, NP_2)$ in (198) for purposes of applying principle (66) is V_2 . Numerous examples of the relativized notion of s structure counterpart of an l-s lexical item will be encountered below.

Note that, since the number of arguments a verb can take is not limited to one in the unmarked case, the argument-taking properties of both V and -AF may

percolate to become properties of the derived verb V_2 in (199). Thus, relative to the $\text{arg}(V, NP_1)$ and $\text{arg}(-AF, NP_2)$ relations, V_2 is the s structure counterpart of both V and $-AF$.

One final case must be considered. Suppose that definition (196) breaks down when applied to an l-s phrase X again because the s structure counterpart of the immediate head of X stands in the merger relation at s structure and thus does not head an s structure phrase. Suppose, however, it is neither the case that the merger of the immediate head of X expresses the l-s relation between X and some other constituent nor the case that the merger expresses an l-s relation between daughters of X , the two cases considered above. As an example of this situation, consider l-s structure (200).

(200)

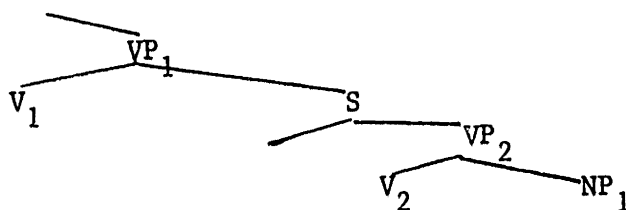

Suppose the object relation between V_1 and S is expressed through the merger of V_1 and V_2 , i.e., $\text{obj}(V_1, S)$ corresponds to $\text{MER}(V_1, V_2)$. The verbs V_1 and V_2 make up a complex verb, V_3 , at s structure. Now the problem is to determine the s structure counterpart of VP_2 . The immediate head of VP_2 , V_2 , is a part of V_3 in s structure and thus does not head a phrase. Yet neither of the principles discussed above apply to VP_2 : the merger of V_1 and V_2 does not express the l-s relation between VP_2 and some other constituent nor does this merger express the l-s relation between daughters of VP_2 . One more principle is necessary for constituents like VP_2 in (200): Consider an l-s phrase X with immediate head Y such that Y' is the s structure counterpart of Y . If definition (196) does not apply to X because Y' stands in the merger relation with respect to W at s structure, and the merger of Y' and W expresses neither an l-s relation between X and

some other constituent nor an l-s relation between daughters of X, then the s structure counterpart of X is Y' or some derived word containing Y', with the choice determined by feature percolation within this derived word as explained in the sections below. Following this principle, we see that the s structure counterpart of VP₂ in (200) will be either V₂--the s structure counterpart of its immediate head--or V₃-- a derived word containing V₂--depending on feature percolation within V₃. Although it is not immediately obvious why we should adopt this particular principle when (196) breaks down in cases like that illustrated in (200) above, the principle will be supported with data from merger constructions below. When definition (196) does not determine the s structure counterpart of an l-s constituent, some additional principle is required. The principle suggested above yields the correct result in the cases I have examined.

The analysis of (200) above in which V₁ and V₂ merge at s structure necessitates a final clarification of the effects of merger. Suppose V₁ is an affix in (200) and V₁ and V₂ have the P-A structures given in (201). The internal structure of V₃, the s structure verb consisting of V₁ affixed to V₂, is shown in (202).

(201) a. -V₁, 'V₁' (SR₁) b. V₂, 'V₂' (SR₂)

(202)

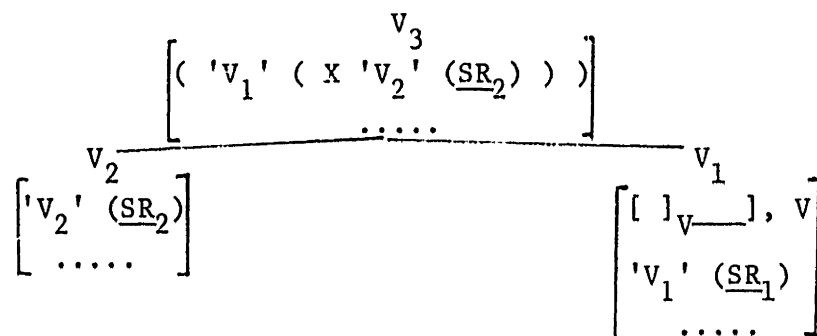

The complex P-A structure of V₃ indicates that the predicate the 'V₂' function produces is to be applied to some constituent, X, to yield a proposition, which in turn is to be the input to the 'V₁' function, which yields a predicate. Now

the merger of V_1 and V_2 in (200) expresses the object and argument relations between V_1 and S , which V_2 heads. In an important sense, the semantic role assigning and argument-taking properties of V_1 are absorbed by the merger process; they are frozen in the complex P-A structure of V_3 . Formally, we must say that the merger of V_2 and V_1 in (200) prevents the semantic role assigning and argument-taking properties of V_1 from percolating to become properties of V_3 , allowing the semantic role assigning properties of V_2 to percolate. More generally, if $r(X, Y)$ for some l-s constituents X and Y is expressed by $MER(W, Z)$, W and Z the lexical heads of X and Y , then the "operator" features of X that allow it to serve as operator in $r(X, Y)$ are absorbed by the merger of W and Z and may not percolate in a derived word.

In (203-206) I list the principles of merger introduced above.

Principles of merger:

- (203) Consider l-s constituents XP and YP such that X and Y are the lexical heads of XP and YP respectively. If $r(XP, YP)$ is expressed by the merger of X and Y at s structure, then the s structure counterparts of XP and YP are X and Y and the operator properties of XP that allow it to serve as operator in $r(XP, YP)$ are absorbed by the merger of X and Y and may not percolate in a derived word.
- (204) Consider an l-s phrase X with daughters Y and Z , such that Y heads X . If an l-s relation between Y and Z corresponds to a merger relation between the lexical heads of Y and Z , the s structure counterpart of X is the phrase immediately headed by the derived word consisting of the lexical heads of Y and Z .
- (205) If $r(X, Y)$ and $MER(X, Z)$, the s structure counterpart of X relative to $r(X, Y)$ must be determined by examining the internal structure of the derived word consisting of X and Z .
- (206) Consider l-s phrase X with immediate head Y such that Y' is the s structure counterpart of Y . If definition (196) does not apply to X because $MER(Y', W)$, and $MER(Y', W)$ expresses neither an l-s relation between X and some other constituent nor an l-s relation between daughters of X , then the s structure counterpart of X is Y' or some derived word containing Y' , depending on feature percolation within the derived word.

Principle (203) is a formalization of the basic assumption that the merger of lexical items at s structure expresses l-s relations between phrases headed by the lexical items. Above we saw how principles (204-205) represent natural

solutions to the breakdown in merger constructions of our initial definition of the s structure counterpart of an l-s constituent, (196). Principle (206) covers an additional situation in which (196) leaves the notion "s structure counterpart to an l-s constituent" ill-defined, but it derives no natural justification from an examination of merger. However, (206) will be empirically supported below.

The merger principles (203-206), when added to the theory of this dissertation, correctly predict the syntax of a variety of constructions in the world's languages. In section 3.4.1 I will apply the principles to constructions headed by "applied verbs." These are verbs derived through affixation of a morpheme with a modifier-argument structure which produces predicate modifiers, much like the -AF of our schematic examples above. Section 3.4.2 contains an analysis of derived causative verbs.

3.4.1. Applied verbs. In section 3.2.1 above I presented an analysis of dative shift alternations like those in English which are not mediated by morphology on a verb. This section will explore superficially similar alternations which are mediated by morphology. Consider the "applied verb" construction of Chi-Mwi:ni (Kisseberth and Abasheikh 1977) illustrated in (207b).

- (207) a. Hamadi \emptyset -sh-pishiže cha:kuja.
 Hamadi SP-OP-cooked food
 'Hamadi cooked the food.'
- b. Hamadi \emptyset -wa-pik-il-ile wa:na cha:kuja.
 Hamadi SP-OP-cook-APPL-T/A children food
 'Hamadi cooked food for the children.'
 (T/A = tense/aspect)

The "applied" affix, -il-, in (207b) signals the presence in the sentence of an NP not contained within the argument structure of the verb to which it attaches. In (207b), this additional argument is interpreted as the benefactive. The Chi-Mwi:ni applied affix may also be used to indicate the presence of a goal NP, an instrumental NP, or an NP adversely affected by what the sentence describes (a "malefactive"). The analysis of applied affixes provided in this section is meant

to cover affixes crosslinguistically which function like the Chi-Mwi:ni applied affix and are associated with the semantic roles listed in (208).

(208) goals, benefactives, sources, malefactive, instrumentals

Instrumental applied affixes will be discussed in section 3.4.1.2 below. In 3.4.1.1 I treat applied affixes associated with the remaining roles in (208). Applied affixes are also used with place locatives (see, e.g., Trithart 1977). I will have nothing to say about place locative applied verb forms in this dissertation.

3.4.1.1. Applied verbs with goals, benefactives, sources, and malefactive.

3.4.1.1.1. Languages which allow one object/verb in the unmarked case. It seems reasonable to assume that the Chi-Mwi:ni sentence (207b) has an 1-s structure isomorphic to that of its English gloss, something like that displayed in (209).

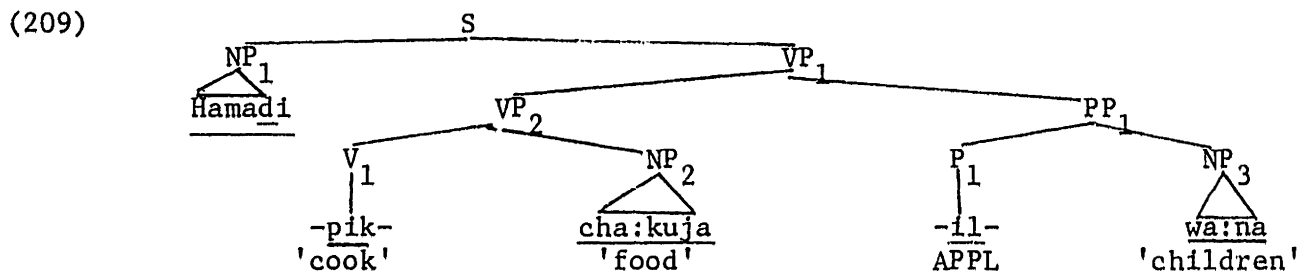

A possible partial lexical entry for the APPL affix in its benefactive use is displayed in (210a). Compare this entry with the entry for English for, given in (210b)

- (210) a. -il-, []_V__, V, 'for' (benefactive), [+transitive]
 b. for, P, 'for' (benefactive), [+transitive]

The essential difference between the entries in (210) is that -il- has the morphological subcategorization feature of an affix while for is identified as a preposition.

Since the applied affix is an affix, it will appear on the verbs to which it attaches at surface structure. As a morpheme with its own argument structure,

the applied affix will be an independent constituent at l-s structure--see (191). So the applied affix must merge with the verbs to which it attaches between l-s and s structure or between s and surface structure. The applied affixes to be discussed in this sub-section all seem to undergo merger between l-s and s structure; see sections 3.4.1.2 and 3.4.2 below for clear examples of merger between s and surface structure.

Suppose the Chi-Mwi:ni applied affix -il- in (210b) attaches to -pik- 'cook' to yield a single s structure verb for sentence (207b). Our principles should predict the s structure of sentence (207b) from the features of the derived benefactive verb -pik-il-, whose internal structure is displayed in (211).

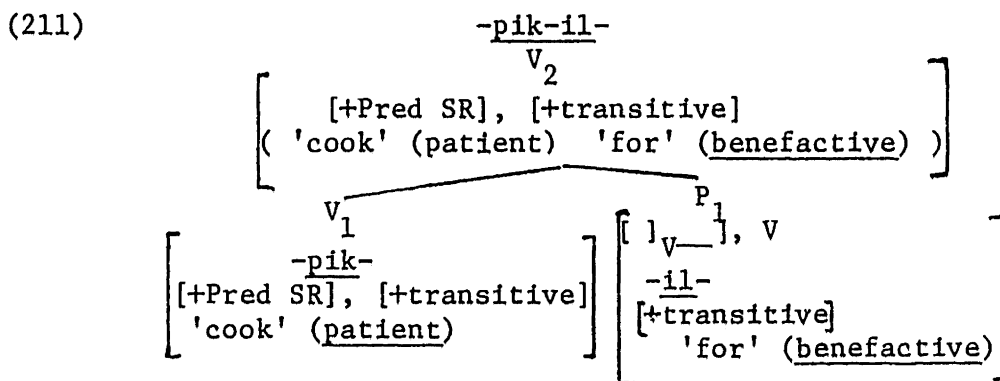

The merger of P_1 and V_1 in (209) into the derived verb V_2 shown in (211) expresses the modifier-modifiee relation between PP_1 and VP_2 , which P_1 and V_1 head. Therefore, the argument structure of the derived verb V_2 will be a combination of the P-A structure of V_1 and the modifier-argument structure of P_1 , as shown in (211). V_2 applies the modifiers that the modifier-argument structure of P_1 produces to the predicates that the P-A structure of V_1 produces to yield predicates. Since the features of an affix take precedence over the features of a root in feature percolation, V_2 inherits the semantic role assigning properties of P_1 over those of V_1 and may be seen as assigning the benefactive role. I indicate that V_2 assigns the benefactive role by underlining this role in its complex P-A structure in (211). Let us assume for the moment that Chi-Mwi:ni verbs assign only a single

semantic role in the unmarked case; we will return to this point below (see also the discussion of Chi-Mwi:ni in section 3.2.1.1 on dative shift). If V_2 assigns the benefactive role, then, it cannot also assign the patient role, and the semantic role assigning properties of V_1 may not percolate in (211). Although a Chi-Mwi:ni verb may assign only one role in the unmarked case, it may take more than one argument. Therefore, the argument-taking properties of both P_1 and V_1 may be inherited by V_2 , as indicated in the complex P-A structure given V_2 in (211).

With the features of the derived verb V_2 determined, we are ready to compute the s structure corresponding to the l-s structure in (209). To aid the discussion, I list in (212) all the l-s relations encoded in (209).

- (212) a. $\text{sub}(VP_1, NP_1)$ b. $\text{mod}(PP_1, VP_2)$ c. $\text{arg}(V_1, NP_2)$
 d. $\text{obj}(V_1, NP_2)$ e. $\text{arg}(P_1, NP_3)$ f. $\text{obj}(P_1, NP_3)$

Consider first the $\text{sub}(VP_1, NP_1)$ relation. According to the table in (69) of Chapter Two, the s structure counterpart of NP_1, NP_1' , must bear the SUB relation with respect to the s structure counterpart of VP_1, VP_1' .³⁴ So $\text{sub}(VP_1, NP_1)$ corresponds to $\text{SUB}(VP_1', NP_1')$. What will the s structure counterpart of VP_1 be? The l-s relation between two daughters of VP_1, PP_1 and VP_2 , is expressed by the merger of their lexical heads. According to principle (204), the s structure counterpart of VP_1 should be the VP headed by the constituent which is the combination of the heads of PP_1 and VP_2 , i.e., the VP headed by V_2 . Principle (203) tells us that the s structure counterparts of PP_1 and VP_2 are P_1 and V_2 respectively. To satisfy principle (66), Chapter Two, $\text{mod}(PP_1, VP_2)$ must correspond to $\text{MER}(P_1, V_1)$. Since V_2 inherits the semantic role assigning properties of its affix, P_1 , the s structure counterpart of P_1 relative to the $\text{obj}(P_1, NP_3)$ relation is V_2 . Since P_1 percolates its [+transitive] feature to V_2 , the s structure counterpart of NP_3, NP_3' , may be the OBJ of V_2 at s structure and $\text{obj}(P_1, NP_3)$

will correspond to $\text{OBJ}(V_2, \text{NP}'_3)$. V_2 inherits the argument-taking properties of P_1 along with its semantic role assigning properties. Thus V_2 is also the s structure counterpart of P_1 with respect to the $\text{arg}(P_1, \text{NP}'_3)$ relation, and $\text{arg}(P_1, \text{NP}'_3)$ will correspond to $\text{ARG}(V_2, \text{NP}'_3)$.

As explained above, V_2 inherits V_1 's argument-taking properties, making V_2 the s structure counterpart of V_1 with respect to $\text{arg}(V_1, \text{NP}'_2)$. Therefore, V_2 must head-Govern the s structure counterpart of NP'_2 , NP'_2 . However, the percolation of P_1 's semantic role assigning properties blocks V_2 from inheriting V_1 's semantic role assigning properties. With respect to the $\text{obj}(V_1, \text{NP}'_1)$ relation, then, the s structure counterpart of V_1 is V_1 , not V_2 . So V_1 must head-Govern NP'_2 as well. There is only one situation left open by the theory in which two constituents may head-Govern the same item but in which neither constituent heads the other. Recall that an OBJ in an argument phrase was considered to be Governed by the constituent with respect to which the argument phrase bears the argument relation, as well as by the head of the argument phrase (see section 2.4.2.4.3). Therefore, since V_1 does not head V_2 , for both V_2 and V_1 to head-Govern NP'_2 , V_1 must head an argument phrase at s structure consisting of V_1 and NP'_2 which serves as argument to V_2 (see (213)). That is, $\text{arg}(V_1, \text{NP}'_2)$ corresponds to $\text{ARG}(V_2, \text{PP})$, where the argument phrase PP consists of V_1 and NP'_2 , and $\text{obj}(V_1, \text{NP}'_2)$ corresponds to $\text{OBJ}(V_1, \text{NP}'_2)$. Since V_1 percolates its argument-taking properties but not its semantic role assigning properties, it resembles a semantic role assigner without argument structure, i.e., the head of an argument phrase. Thus it is quite reasonable that V_1 head a syntactic argument phrase at s structure. Similarly, since V_2 may be seen as taking an l-s argument to which it does not assign a semantic role-- NP'_2 , it makes sense that V_2 takes a syntactic argument to which it does not assign a syntactic role-- NP'_2 . The s

structure corresponding to the 1-s structure in (209) is shown in (213).

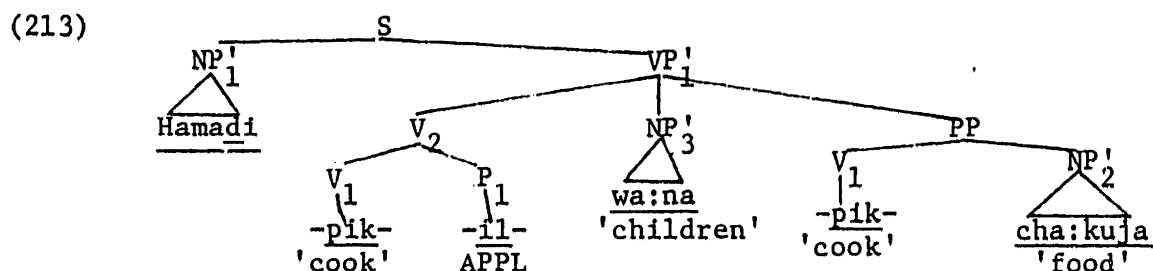

The appearance of V_1 in two places in (213) is somewhat misleading; there is a single s structure constituent V_1 , which is part of V_2 . Our structural representation of s structure forces us to place a copy of V_2 in a position to indicate that it assigns a syntactic role to NP'_2 .

Our analysis of (207b), repeated here as (214), automatically accounts for many features of the applied verb construction in Chi-Mwi:ni.

- (214) Hamadi \emptyset -wa-pik-il-ile wa:na cha:kuja.
 Hamadi SP-OP-cook-APPL-T/A children food
 'Hamadi cooked food for the children.'

On our analysis, only the benefactive NP in (214) is an OBJ of the derived verb. Kisseberth and Abasheikh (1977) demonstrate that only the NP which depends on the applied affix, the benefactive NP in (214), displays direct object behaviour in Chi-Mwi:ni.³⁵ In particular, only the benefactive NP wa:na 'children' in (214) may control the object prefix (OP) in (214), and only the benefactive NP may passivize.

- (215) *Hamadi \emptyset -sh-pik-il-ile wa:na cha:kuja.
 Hamadi SP-OP₁-cook-APPL-T/A children food₁
 'Hamadi cooked food for the children.'

- (216) a. Wa:na wa-pik-il-ila cha:kuja na Hamadi.
 children SP-cookPASS-APPL-T/A food by Hamadi
 'The children had food cooked for them by Hamadi.'
 b. *Cha:kuja sh-pik-il-ila wa:na na Hamadi.
 'Food was cooked for the children by Hamadi.'

Sentence (215) is ungrammatical because the OP agrees with cha:kuja 'food' and not the benefactive NP, as it does in (214). Only the benefactive NP in (215) is the OBJ of the derived verb, and the OP on a verb must agree with its OBJ.

Sentence (216b) is ungrammatical because the logical object of the root verb appears as the SUB of the VP headed by the derived applied verb. We saw above that the s structure counterpart of the logical object of the root verb in a Chi-Mwi:ni applied verb construction must be head-Governed by both the root verb and the derived verb and thus must be the OBJ of the root verb in an argument phrase serving as argument to the derived verb.'

In addition to predicting which of the postverbal NPs in (214) will exhibit object behaviour, our analysis also accounts for the expression of the logical object of -pik- 'cook' in (214) as an [NP, VP]. Chi-Mwi:ni expresses OBJs of verbs as [NP, VP]'s and allows more than one [NP, VP] per VP. Since the logical object of -pik- 'cook' in (214), cha:kuja 'food', is also its grammatical OBJ at s structure in our analysis (see (213)), we correctly expect it to appear as an [NP, VP]. The surface structure of (214) is displayed in (217).

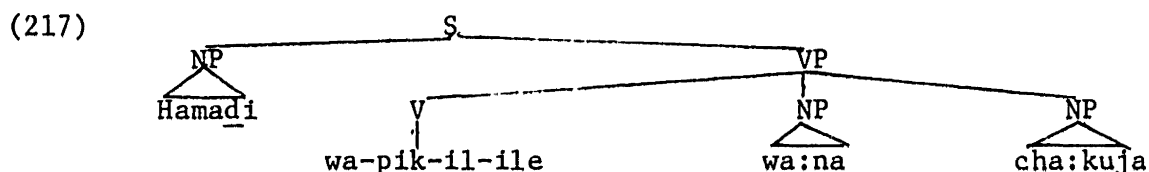

Although only wa:na 'children' is the OBJ of the verb -pik-il- 'cook-APPL' in (217), both wa:na and cha:kuja 'food' are structurally indistinguishable [NP, VP]'s in surface structure.

In Chi-Mwi:ni, the applied affix may attach to intransitive as well as transitive verbs. Abasheikh (1979) provides an example of this, (218), in which the applied affix assigns the directional goal semantic role.

- (218) Muti u-m-tuɬuk-il-ile mwa:limu.
 tree SP-OP-fall-APPL-T/A teacher
 'The tree fell on the teacher.'

The internal structure of the verb in (218) is displayed in (219).

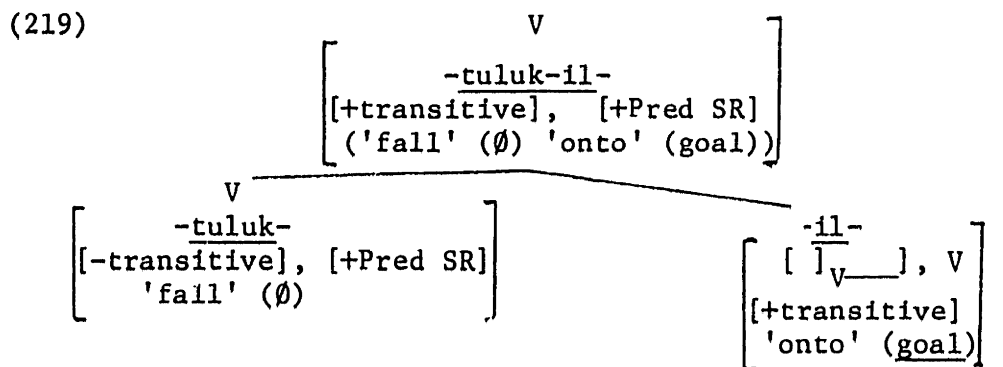

Since the features of an affix take precedence over the features of a root in percolation, the derived verb in (219) will be [+transitive] and may be seen as assigning the goal role. The reader should be able to complete the analysis of sentence (218) following that given for (214). The goal NP in (218) is identified as the OBJ of the derived verb and, in fact, exhibits OBJ behavior, as Abasheikh (1979) notes.³⁶

Since it transitivizes an otherwise intransitive verb in (218), the Chi-Mwi:ni applied affix is clearly [+transitive]. Suppose there were a language whose applied affix differed crucially from Chi-Mwi:ni's in being unmarked for transitivity. The behavior our theory predicts for the resulting applied verb construction is exemplified in Bahasa Indonesia, a Western Austronesian language described in Chung (1976). The superficial syntax of Bahasa Indonesia is virtually the same as that found in Chi-Mwi:ni. Bahasa Indonesia is an SVO language whose subjects and objects are unmarked by case or adposition. The applied affix, -kan-, assigns the goal and benefactive roles. Some applied verb constructions are illustrated in (220b) and (221b).

- (220) a. Saja mem-bawa surat itu kepada Ali.
 I TRANS-bring letter the to Ali
 'I brought the letter to Ali.'
- b. Saja mem-bawa-kan Ali surat itu.
 I TRANS-bring-APPL Ali letter the
 'I brought Ali the letter.'

- (221) a. Mereka men-dapat suatu pekerdjaan untuk anak-ku.
 they TRANS-find a job for child-my
 'They found a job for my daughter.'
- b. Mereka ven-dapat-kan anak-ku suatu pekerdjaan.
 they TRANS-find-APPL child-my a job
 'They found my daughter a job.'

(TRANS = a transitivity marker)

On the hypothesis that -kan- is unmarked for transitivity, the internal structure of the applied verb in (221b) would look something like (22)

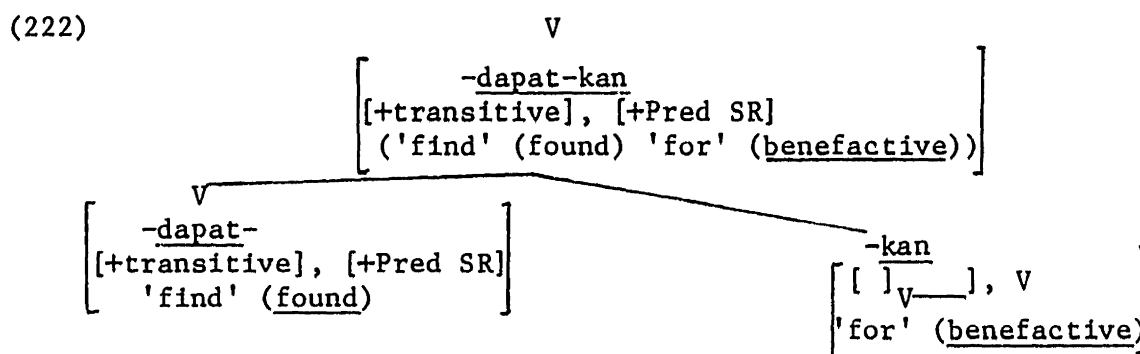

Since the suffix is unmarked for transitivity, the percolation conventions demand that the transitivity feature of the root, [+transitive], percolate to become the transitivity feature of the derived verb in (222). The analysis of (221b) exactly parallels the analysis of the Chi-Mwi:ni sentence (214) (compare the derived verbs in (211) and (222)). As in the Chi-Mwi:ni sentence, we predict that only the benefactive NP in (221b) may be the OBJ of the derived verb. Chung (1976) demonstrates that only the benefactive NP in a benefactive applied verb construction may passivize.

- (223) a. Orang itu me-masak-kan perempuan itu ikan.
 man the TRANS-cook-APPL woman the fish
 'The man cooked the woman fish.'
- b. Perempuan itu di-masak-kan ikan oleh orang itu.
 woman the PASS-cook-APPL fish by man the
 'The woman was cooked fish by the man.'
- c. *Ikan di-masak-kan perempuan itu oleh orang itu.
 fish PASS-cook-APPL woman the by man the
 'A fish was cooked for the woman by the man.'

As explained in connection with the Chi-Mwi:ni sentences (216) above, our analysis of applied verb constructions explains the data in (223). The struc-

ture counterpart of the benefactive NP must be head-Governed by the applied verb and thus may appear as the subject of the VP headed by the passive of the applied verb--see (223b). The s structure counterpart of the logical object of the root verb, on the other hand, must be head-Governed by both the applied and the root verb and thus must appear in an argument phrase headed by the root verb and serving as argument to the applied verb. Because the s structure counterpart of the logical object of the root verb does not meet these requirements in (223c), the sentence is ungrammatical.

Just like Chi-Mwiini, Basana Indonesia expresses OBJs of Vs as [NP, VP]'s and allows more than one [NP, VP] per VP. As expected on our analysis, since it is the OBJ of the root verb in (221b), the logical object of -dapat- 'find', i.e., suatu pekerdjaan 'a job', appears as [NP, VP].

Suppose we attach -kan to an intransitive verb, as shown schematically in (224).

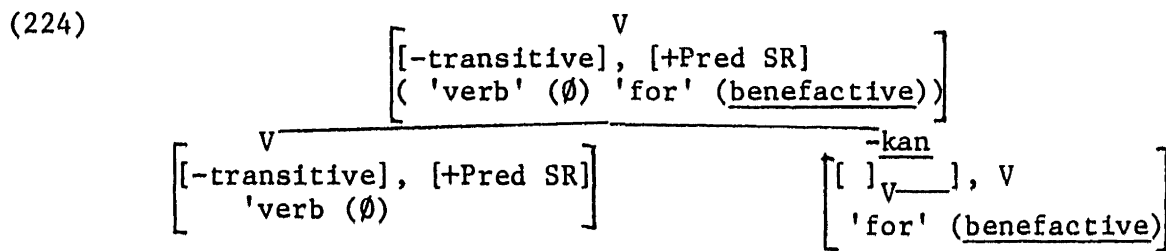

Since the derived verb in (224) inherits the semantic role assigning properties of the affix -kan, it is the s structure counterpart of the affix with respect to the object relation between -kan and its logical object. By principle (66), the logical object of -kan must bear some grammatical relation with respect to the derived verb or a phrase it heads in s structure. But, because the affix -kan is unmarked for transitivity, the derived verb in (224) receives the [-transitive] feature from the root verb and may not take an object at s structure. Unless Bahasa Indonesia provides some s structure constituent to intransitive verbs to assign a syntactic role to the s structure counterpart of a

logical object, the s structure counterpart of the logical object of -kan will violate principle (66), Chapter Two, when -kan attaches to intransitive Indonesian verbs. In fact, as Chung (1976) points out, -kan may not attach to intransitive verb in Bahasa Indonesia, confirming the hypothesis that the applied affix -kan is unmarked for transitivity.

3.4.1.1.2. Languages which allow more than one object/verb in the unmarked case. Our theory provides an analysis for derived verb constructions in Chi-Mwi:ni and Bahasa Indonesia under the assumption that these languages allow a verb to assign only one semantic role, in the unmarked case, and only one syntactic role. It was assumed that the limit of one logical object and one grammatical OBJ per verb represents the unmarked case crosslinguistically. If a linguist or a child is to hypothesize that a language allows verbs more than one object, then he must have strong positive evidence that sentences in the language contain two or more objects in a single clause. As Kisseberth and Abasheikh (1977) demonstrate (see the discussion in 3.2.1.1 above), only one NP in a Chi-Mwi:ni sentence will display object properties, even in "double object" constructions like that in (107) above. Only one NP per Chi-Mwi:ni verb will passivize and/or control the object prefix. Similar evidence is presented for Bahasa Indonesia in Chung (1976). Since there is no reason to believe that a verb in Chi-Mwi:ni or Bahasa Indonesia may take more than one object, the theory tells us that these languages restrict verbs to one object each.

There are Bantu languages superficially similar to Chi-Mwi:ni, however, which provide direct evidence that they allow more than one logical and grammatical object per verb. Kimenyi (1980) demonstrates that both arguments in a Kinyarwanda double object construction with -haa- 'give', like that in (225a),

exhibit object properties. For example, either the theme or goal of -haa- may be the SUB of -haa-'s passive form, -haa-w-, as shown in (225b&c).

- (225) a. Umugabo y-a-haa-ye umugóre igitabo.
 man SP-PAST-give-ASP woman book
 'The man gave the woman the book.'
- b. Igitabo cy-a-haa-w-e umugóre n'Umugabo.
 book SP-PAST-give-PASS-ASP woman by-man
 'The book was given to the woman by the man.'
- c. Umugóre y-a-haa-w-e igitabo n'Umugabo.
 woman SP-PAST-give-PASS-ASP book by-man
 'The woman was given the book by the man.'

Compare the sentences in (225) to the Chi-Mwi:ni sentences (226).

- (226) a. Ni-m-peŕe Ja:ma kuja.
 SP(='I')-OP-gave Jama food
 'I gave Jama food.'
- b. *Kuja i-pela Ja:ma na: mi.
 food SP-gavePASS food by me
 'Food was given to Jama by me.'
- c. Ja:ma Ø-pela: kuja na: mi.
 Jama SP-gavePASS food by me
 'Jama was given food by me.'

In contrast to the situation in Kinyarwanda, only the goal argument in a Chi-Mwi:ni double object construction with 'give' may passivize and, Kisseberth and Abasheikh (1977) claim, display other object properties.

Kimenyi (1980) provides evidence that a Kinyarwanda verb may actually have more than two objects. Let us suppose that in languages which allow a verb more than one OBJ, transitivity is a multi-valued feature. Intransitive verbs will be [0 transitive], verbs taking one OBJ, [+1 transitive], verbs taking two OBJs, [+2 transitive], etc. The passive morpheme in such a language will carry the features [-Pred SR], [-1 transitive]. The values of the [n transitive] features of the component parts of a derived word will add in feature percolation to yield a single transitivity value for the derived verb. For example, attaching the passive morpheme to a [+2 transitive] verb like -haa-

in (225a) will yield a [+1 transitive] passive verb, the verb in (225b&c). As Kimenyi (1980) provides evidence that the postverbal NPs in the passives of [+2 transitive] verbs, e.g., umugóre 'woman' in (225b) and igitabo 'book' in (225c), exhibit the same object properties they exhibit in the active counterparts of these sentences, it seems correct to say that the passive verbs in (225b&c) are [+1 transitive], i.e., take OBJs.

The available evidence points to a partial lexical entry for Kinyarwanda -haa- 'give' like that in (227).

(227) -haa-, V, 'give' (theme, goal), [+2 transitive], [+Pred SR]

In order for both the theme and goal arguments of -haa- to be OBJs of the verb, the verb must assign both the theme and goal roles (recall that an l-s argument of a verb which is not also a logical object of the verb will not correspond to the s structure OBJ of the verb or the s structure SUB of the VP the verb heads). A partial lexical entry for the passive of -haa- 'give', the verb in (227b&c), is shown in (228).

(228) -haa-w-, V, 'give' (theme, goal) [+1 transitive], [-Pred SR]

Since the verb in (228) assigns only one syntactic role, only one of its logical objects may correspond to a grammatical OBJ; the other will correspond to the SUB of the VP the verb heads. Which logical object becomes the OBJ and which the SUB is not specified within the lexical entry in (228), and, as shown in (225b&c), both possibilities are realized.

Given that Kinyarwanda allows a verb to assign more than one semantic role in the unmarked case, our theory makes the correct predictions about the grammatical relations born by arguments in Kinyarwanda applied verb constructions. Consider the benefactive applied affix -ir- in Kinyarwanda. The lexical entry for -ir- in its benefactive use is shown in (229). Some benefactive applied verbs appear in (230).

(229) -ir-, []_V, 'for' (benefactive), [+1 transitive]

- (230) a. Umugóre a-rá-kor-er-a umugabo.
 woman SP-PRES-work-APPL-ASP man
 'The woman is working for the man.'
- b. Umukoôhwa a-ra-som-er-a umuhuúngu igitabo.
 girl SP-PRES-read-APPL-ASP boy book
 'The girl is reading a book for the boy.'

The internal structure of the verb in (230b) is shown in (231).

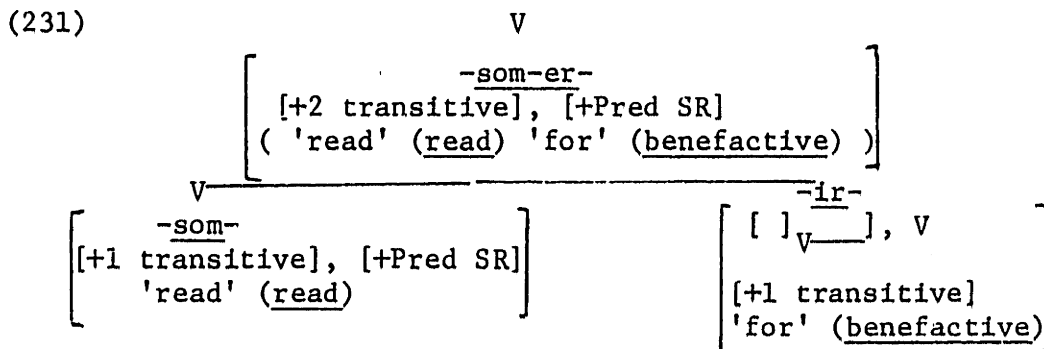

Since a Kinyarwanda verb may assign more than one semantic role, the derived verb in (231) may inherit the semantic role assigning properties of both affix and root. Therefore, the derived verb will function as the s structure counterpart of both affix and root in determining the s structure expression of the logical object relations between the root and the 'read' argument and the affix and the benefactive argument. The values of the transitive feature of both root, [+1 transitive], and affix, [+1 transitive], add to yield the value for the derived verb--[+2 transitive]. Since the derived verb -som-er- is the s structure counterpart of -som- and -er- with respect to the logical object relations and since it may assign two syntactic roles, the s structure counterparts of both the 'read' and benefactive arguments should be OBJs of -som-er-. Kimenyi demonstrates that both the logical object of the root verb and the benefactive NP in a benefactive applied verb construction display all the OBJ properties in Kinyarwanda. For example, both will passivize, as illustrated in (232).

- (232) a. Umuhuúnga a-ra-andik-ir-a umukoðbwa íbárúwa.
 boy SP-PRES-write-APPL-ASP girl letter
 'The boy is writing the letter for the girl.'
- b. Íbárúwa i-ra-andik-ir-w-a umukoðbwa n'úmuhuúngu.
 letter SP-PRES-write-APPL-PASS-ASP girl by-boy
 'The letter is written for the girl by the boy.'
- c. Umukoðbwa a-ra-andik-ir-w-a íbárúwa n'úmuhuúngu.
 girl SP-PRES-write-APPL-PASS-ASP letter by-boy
 'The girl is having the letter written for her by the boy.'

The sentences in (232) should be compared with sentences (214) and (216) from Chi-Mwi:ni and sentences (223) from Bahasa Indonesia, languages I have claimed restrict verbs to one OBJ each.

That the Kinyarwanda benefactive affix attaches to [0 transitive] stems like -kor- 'work' in (230a) is further evidence that it is indeed [+1 transitive] and not unmarked for transitivity. Recall that an applied affix unmarked for transitivity, like -kan in Bahasa Indonesia, cannot attach to intransitive stems without causing a violation of principle (66), Chapter Two, in sentences containing the derived verb.

The simple hypothesis that Chi-Mwi:ni restricts verbs to one logical and grammatical object while Kinyarwanda allows more than one object per verb accounts for differences between these languages in the behavior of applied verb constructions. Below, in section 3.4.2.3 on causatives, it will be shown that the hypothesis that Kinyarwanda allows a verb to be multiply transitive makes correct predictions for another sort of construction as well. The above arguments for multiple transitivity could be repeated with data from Kimeru (Hodges 1977) and Chichewa (Trithart 1977), among other Bantu languages. I will argue below that Japanese also allows more than one OBJ per verb.

3.4.1.2. Instrumental applied verbs. Since it is forced by the theory, the analysis provided above for applied verb constructions should extend to all such constructions crosslinguistically. In many languages, however, applied verb constructions which involve instrumentals behave differently

from other applied verb sentences. Fula, a Niger-Congo language described in Sylla (1979) is one such language. The Fula benefactive applied verbs behave just like their counterparts in Chi-Mwi:ni. When a benefactive applied affix is attached to a transitive root, for example, the benefactive NP but not the logical object of the root verb is the OBJ of the derived verb, as evidenced by the fact that only the benefactive may passivize.

- (233) a. Takko def-an-ii sukaabe be gertogal.
 Takko cook-APPL-PAST children Det chicken
 'Takko cooked chicken for the children.'
- b. Sukaabe be ndef-an-aama gertogal.
 children Det cook-APPL-PAST/PASS chicken
 'The children had a chicken cooked for them.'
- c. *Gertogal def-an-aama sukaabe be.
 chicken cook-APPL-PAST/PASS children Det
 'Chicken was cooked for the children.'

Compare sentences (233) with (214) and (216) from Chi-Mwi:ni. When the Fula instrumental applied affix, -r-, is attached to an intransitive verb, the instrumental NP takes on OBJ properties. It passivizes, for example.

- (234) a. Mi am-ii.
 I dance-PAST
 'I danced'
- b. Mi am-r-ii pade.
 I dance-INST-PAST shoes
 'I danced with shoes.'
- c. Pade ngam-r-aama.
 shoes dance-INST-PAST/PASS
 'Shoes were danced with.'

When the instrumental applied affix attaches to a transitive verb, on the other hand, the logical object of the root verb, not the instrumental, exhibits OBJ behavior.

- (235) a. Aali tay-ii lekki.
 Aali cut-PAST tree
 'Aali cut a tree.'
- b. Aali tay-r-ii lekki jammber.
 Aali cut-INST-PAST tree axe
 'Aali cut a tree with an axe.'

- c. Lekki tay-r-aama jammberé.
tree cut-INST-PAST/PASS axe
'A tree was cut with an axe.'
- d. *Jammberé tay-r-aama lekki.
axe cut-INST-PAST/PASS tree
'An axe was used to cut a tree.'

Compare sentences (235b-d) with sentences (233) above. In the Fula benefactive applied verb construction with a transitive root verb, it is the logical object of the applied affix, the benefactive argument, which is the OBJ of the derived verb.

Chichewa (Trithart 1977) also displays an instrumental applied verb with unusual properties. A combination of the causative affix, -ts-, and the passive affix, -dw-, indicates that an instrumental NP is the subject of the sentence headed by the verb to which the affixes attach. These two morphemes may attach to an intransitive or transitive verb as in (236a) and (236b) respectively.

- (236) a. Khásu lí-ma-(lí-)lim-its-ídw-a (ndí Jóni).
hoe_i it_i -HABIT-(it_i-)farm-CAUSE-PASS-INDIC (by John)
'The hoe is farméd with (by John).'
- b. Khásu lí-ma-(lí-)lim-its-ídw-a chí-manga (ndí Jóni).
hoe_i it_i -HABIT-(it_i-)farm-CAUSE-PASS-INDIC corn (by John)
'The hoe is used to farm corn with (by John).'

The unusual property of this instrumental applied verb construction in Chichewa is that the causative affix alone may not indicate that an instrumental NP is a post-verbal NP or object. Without the passive affix, -dw-, the causative affix has no instrumental implications, as shown in (237). Sentences (237) are also ungrammatical with a straight causative reading since the Chichewa causative construction requires an animate "causee" (logical subject of the root verb). If possible with a causative reading, (237a) would mean, 'John caused the pen to write.'

- (237) a. *Jóni á-ma-(yí-)lemb-éts-a pèni.
John_i he_i -HABIT-(it_j-)write-CAUSE-INDIC pen
'John writes with a pen.'

- b. *Jóni a-má-(yí-)lemb-ets-a pêni dz-íná lá-ké.
 John_i he_i -PAST-(it_i -)write-CAUSE-INDIC pen_j name his
 'John wrote his name with a pen.'

The Bantu language Mashi (Gary 1977) has an instrumental applied verb construction with the same characteristics as the Chichewa construction just described. The instrumental affix is not homophonous with the causative in Mashi, however.

One simple assumption about the manner in which the instrumental role is assigned will predict both the Fula and Chichewa instrumental constructions described above and explain why they differ from the applied verb constructions discussed in 3.4.1.1. This assumption is independently motivated -- in fact, it was proposed by Dick Carter (personal communication) on independent grounds. Translated into the terms of this dissertation, Carter claims that it is wrong to look at the preposition with in (238) as assigning some instrumental role inherently associated with the preposition.

(238) Elmer unlocked the porcupine cage with a key.

Rather, it is a predicate produced by unlock in (238) which assigns an instrumental role to a key. The idea is that the class of roles we call "instrumental" includes widely varying roles. Which member of this class a given instrumental NP will bear depends on the verb producing the predicate with which the instrumental is associated. We may say that verbs compatible with instrumentals name two functions from arguments to predicates, one producing predicates which assign agent and related roles, the other producing predicates which assign instrumental roles. On this view, the preposition with in English serves much the same function by does. With names a function from an argument bearing an instrumental role to modifiers of predicates. The modifier-argument structure of with is shown in (239).

(239) 'with' (instrumental)

With and its argument will form a modifier which will modify a predicate, call it "P." With must indicate that its argument receives an instrumental semantic

role assigned by a predicate produced by the head of P. Similarly, by and its argument form a modifier which will modify a predicate P. By assigns to its argument the role assigned by P (see section 3.1.1.1.2 above).

A number of considerations support this conception of the semantics of instrumentals. First note that the semantic role of an instrumental does vary widely, crucially depending on the verb with which the instrumental appears. Compare the roles of the instrumental NPs in (240).

- (240) a. Elmer unlocked the porcupine cage with a key.
 b. Elmer examined the inscription with the magnifying glass.

In (240a) a key is an intermediary agent in the act of unlocking the porcupine cage. Elmer does something to the key, the key does something to the cage, and the cage unlocks. In (240b) the magnifying glass is an indispensable tool in Elmer's examination of the inscription, but it is not an intermediary agent in the examination. This difference between the roles of the instruments in (240a) and (240b) is reflected syntactically in English in the contrast between (241a) and (241b), in which the subjects are intended to be interpreted as instrumentals, not (simply) agents.

- (241) a. A key unlocked the porcupine cage.
 b.*The magnifying glass examined the inscription.

Intermediary agent instrumentals can generally serve as subjects of the verb with which they are associated in English, as in (241a). On the other hand, facilitating instrumentals like the magnifying glass in (240b) cannot generally serve as subjects -- see (241b).

A second consideration which supports the view that instrumental roles are assigned by predicates, not instrumental prepositions or case, is the widespread homophony between instrumental and comitative prepositions and case

marking. English with, for example, has a comitative use illustrated in (242).

(242) Elmer ate dinner with Hortense.

It is clear that Hortense in (242) is an eater of dinner; that is, Hortense bears the role assigned by the predicate the 'eat' function produces. Since instrumental prepositions and case markings in their comitative use mark a constituent to receive a semantic role assigned by a predicate, it is reasonable to assume that the instrumental prepositions and case marking perform the same duty in their instrumental use.

Finally, instrumental case marking and prepositions are the most common markers of the logical subject in passive constructions crosslinguistically; i.e., they are the items most commonly used to perform the function by performs in English. Since the constituent performing the by function marks phrases to receive the semantic role assigned by a predicate, the crosslinguistic use of the instrumental case marking and prepositions for the by function strongly suggests that they mark phrases to receive the semantic role assigned by a predicate in their instrumental use as well. One might suppose that the instrumental is used for the displaced subject in passives in many languages simply because of some close semantic correspondence between instrumentals and agents. But note that the instrumental case (called "comitative" in Central Arctic Eskimo) is used for the displaced subjects in the passives of the ergative languages discussed in section 3.3.1 above, even though the displaced subject in these languages is canonically a theme or patient rather than an agent.

Let us suppose that Carter's suggestion is correct and the instrumental case or preposition in a language operates in much the same manner as English by: it insures that its argument receives a semantic role assigned by a predicate. Given Carter's suggestion, it is possible to interpret the semantic role assigning properties of instrumental prepositions and cases in two ways. First,

one may view the preposition or case as itself assigning the instrumental role assigned by the instrumental predicate with which it is associated. On this view, the 1-s structure for (238) above would look like (243).

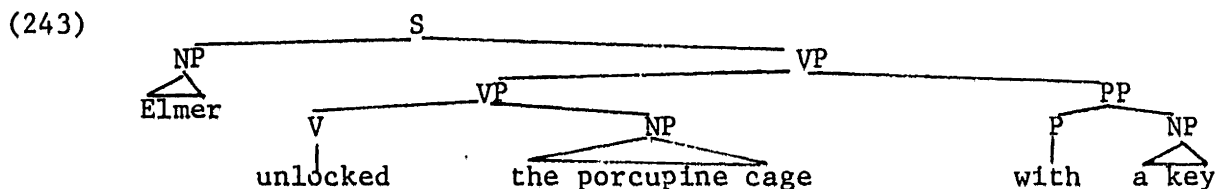

The verb unlock in (243) names two functions from arguments to predicates; one function produces predicates which assign agent roles, the other produces predicates which assign instrumental roles. The preposition with in (243) assigns to a key the role assigned by the instrumental assigning predicate produced by unlock. Compare (243) with the 1-s structure for the passive sentence (244a) shown in (244b).

(244) a. The porcupine cage was unlocked by Elmer.

b.

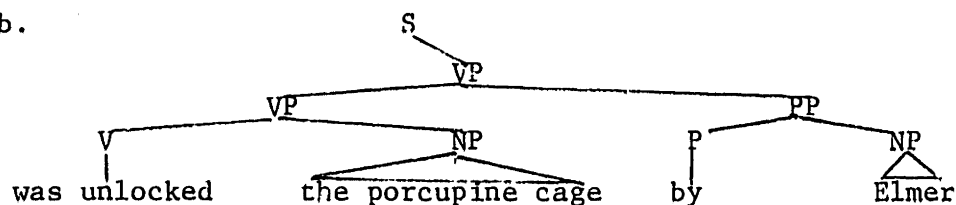

The preposition by in (244) assigns to Elmer the role assigned by the agent assigning predicate produced by unlock.

If we view the instrumental applied affix as assigning an instrumental role as with does in (243), we would not expect the instrumental applied verb to behave any differently from, say, a benefactive applied verb, whose applied affix assigns the benefactive role. In some languages instrumental applied verbs do behave like other applied verbs, indicating that these languages view the instrumental affix itself as assigning the instrumental role. Unlike the situation in sentences containing the Fula instrumental applied verbs described above, it is always the instrumental NP which is the OBJ of the Chi-Mwi:ni

instrumental applied verb, regardless of whether the instrumental affix is added to intransitive or transitive verb roots. There are some complications surrounding the instrumental constructions in Chi-Mwi:ni, discussed at length in Kisseberth and Abasheikh (1977), for which I have no explanation. For the most part, however, instrumental applied verbs in Chi-Mwi:ni exhibit the same behavior as the benefactive applied verbs analyzed above, with an instrumental NP replacing the benefactive NP. Therefore, Chi-Mwi:ni must take the first view of the semantic role assigning properties of the instrumental affix -- that the affix itself assigns the instrumental role.

On the second interpretation of the assignment of the instrumental, the instrumental preposition, case, or affix does not itself assign a role. Rather, it marks a constituent to receive the instrumental role, which is actually assigned directly by an instrumental predicate. The 1-s structure of sentence (238) would look like (245) on this interpretation of the semantics of instrumentals.

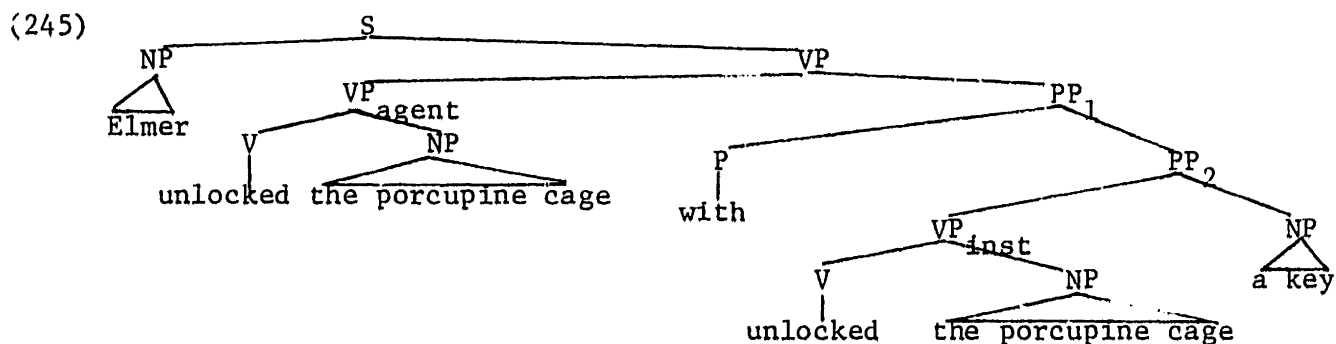

Again, the verb unlock names two functions from arguments to predicates. One function produces predicates which assign agent roles, like VP_{agent} in (245). The other function produces predicates which assign instrumental roles, like VP_{inst} in (245). There is only one verb unlock and one NP the porcupine cage in (245), but two different predicates produced by the combination of these two constituents. The peculiar appearance of PP_1 in (245) results from decisions

made in Chapter Two about the representation of arguments in constituent structure. An l-s argument is technically a constituent bearing a semantic role. The argument of with in PP_1 is really a key bearing the instrumental role, not the combination of V_{inst} and a key. We represent arguments of argument-taking items which are not also logical objects of these items as argument phrases consisting of a semantic role assigner, in (245) VP_{inst} , and its logical object, in (245) a key. Although the argument phrase PP_2 in (245) has the internal structure of a proposition, the instrumental predicate, VP_{inst} , is used in (245) merely to assign a semantic role, not to form a proposition.

If we assume that the Fula and Chichewa instrumental applied affixes effect the assignment of the instrumental role in the manner illustrated in (245) above, we correctly predict the syntax of the instrumental applied verb constructions in these languages. The differences between the instrumental constructions in the two languages follow from the assumption that the instrumental applied affix merges with root verbs between l-s and s structure in Fula but between s and surface structure in Chichewa.

Consider first the Fula sentence, (235b), repeated here as (246), and its l-s structure (247), parallel to that in (245).

(246) Aali tay-r-ii lekki jammere.
 Aali cut-INST-PAST tree axe
 'Aali cut a tree with an axe.'

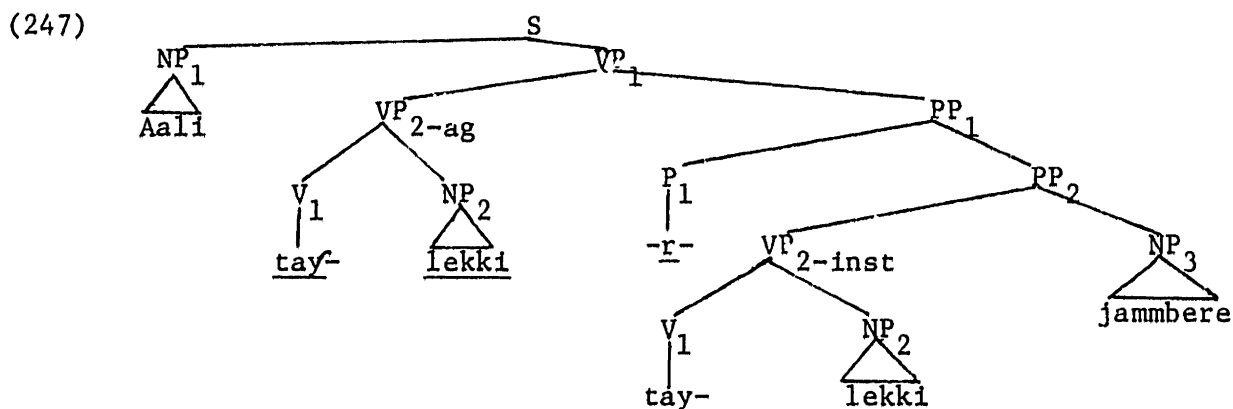

To determine the s structure expression of the $\text{obj}(\text{VP}_{2\text{-inst}}, \text{NP}_3)$ relation, we must know the s structure counterpart of $\text{VP}_{2\text{-inst}}$. The head of $\text{VP}_{2\text{-inst}}$ is V_1 , which merges with P_1 in s structure. According to definition (206) above, if the s structure counterpart of the head of an l-s phrase stands in the merger relation and this merger relation does not express the l-s relation between the phrase and another constituent or between two daughters of the l-s phrase, then the s structure counterpart of the l-s phrase is the s structure counterpart of its head. So the s structure counterpart of $\text{VP}_{2\text{-inst}}$ is the s structure counterpart of its head, V_1 , which is V_1 itself. Since V_1 is transitive, $\text{obj}(\text{VP}_{2\text{-inst}}, \text{NP}_3)$ may correspond to $\text{OBJ}(V_1, \text{NP}'_3)$. This is a nice result since NP'_3 , jammber 'axe', is expressed in (246) as OBJs of verbs are usually expressed in Fula, i.e., as an [NP, VP]. The s structure corresponding to l-s structure (247) is displayed in (250).³⁷

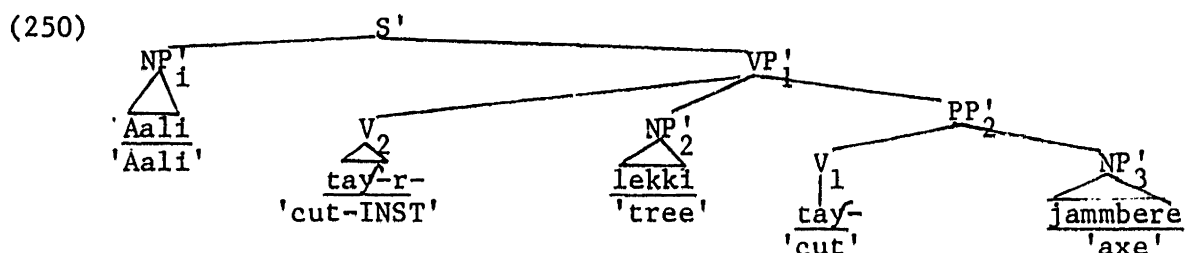

The s structure in (250) should be compared to the s structure for a Chi-Mwini benefactive applied verb construction shown in (213) above. Note that the trees are isomorphic with the exception that the NP associated with the applied affix in (213), the benefactive NP wa:na 'children', is the OBJ of the applied verb in (213), while the logical object of the root verb, lekki 'tree' in (250), is the OBJ of the applied verb. We saw in (235) above that it is the logical object of the root verb which displays OBJ properties in a Fula instrumental applied verb construction as predicted by the s structure in (250).

I glossed over one difficulty in the analysis of sentence (246). If the

s structure counterpart of VP_{2-inst} is V_1 , then V_1 may be seen as holding the semantic role assigning properties of VP_{2-inst} within the derived verb V_2 in (248). Since a Fula verb may only assign one role in the unmarked case, V_1 may percolate either its own semantic role assigning features -- it assigns the patient role in (248) -- or the semantic role assigning features it inherits by virtue of serving as the s structure counterpart of VP_{2-inst} , but not both. If V_1 percolated the semantic role assigning features of VP_{2-inst} in (248), the s structure counterpart of VP_{2-inst} with respect to $obj(VP_{2-inst}, NP_3)$ would be V_2 ; this is the situation referred to in principle (206) in the part which reads, "then the s structure counterpart of X is Y' or some derived word containing Y', depending on feature percolation within the derived word." It seems natural to assume that V_1 would percolate the semantic role assigning features of a verb, i.e., its inherent semantic role assigning features, over the semantic role assigning features of a predicate, i.e., the semantic role assigning features V_1 inherits from VP_{2-inst} , but the theory as developed so far does not demand this. One more principle will be assumed:

(251) Principle: A constituent in a morpheme structure tree will percolate inherent over inherited features.

Principle (251), which has the proper consequences for the Fula instrumental applied verb construction, receives independent support in the analysis of derived causative verbs found in 3.4.2 below.

The analysis of a Fula instrumental applied verb derived from an intransitive verb like that in (234b) is straightforward. The l-s structure for sentence (234b), repeated here as (252a), is shown in (252b). The internal structure of the instrumental applied verb, am-r- 'dance-INST', is displayed in (253).

- (252) a. Mi am-r-ii pade.
 I dance-INST-PAST shoes
 'I danced with shoes.'

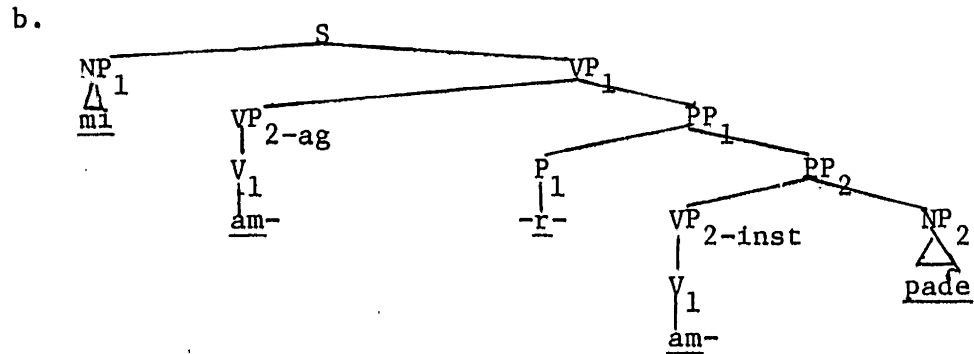

(253)

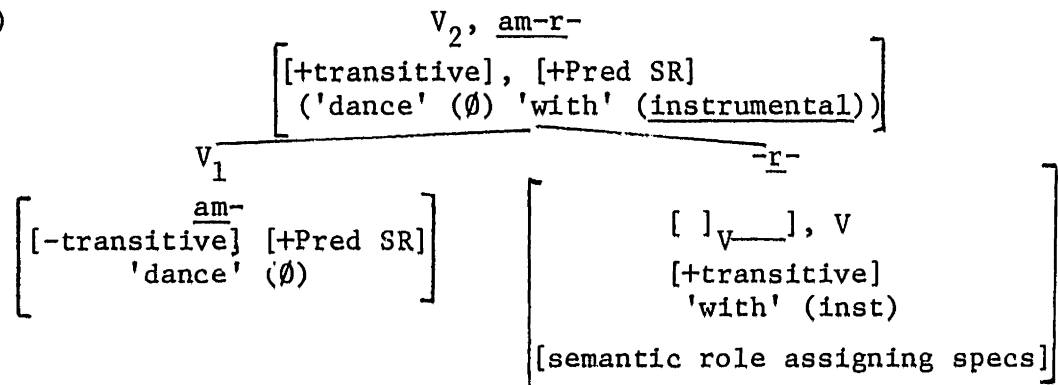

According to principle (206) above, the merger of V_1 , the head of VP_{2-inst} , with P_1 at s structure to express the $\text{mod}(PP_1, VP_{2-ag})$ relation will make either V_1 or V_2 the s structure counterpart of VP_{2-inst} , depending on feature percolation within V_2 . Since neither V_1 nor P_1 has inherent semantic role assigning properties, the semantic role assigning properties V_1 would inherit by virtue of being the s structure counterpart of VP_{2-inst} would percolate up to become the semantic role assigning properties of the derived verb V_2 in (253). So V_2 may be seen as assigning the instrumental role to the argument of the applied affix, $-r-$, i.e., V_2 is the s structure counterpart of VP_{2-inst} with respect to $\text{obj}(VP_{2-inst}, NP_2)$. Since the derived verb V_2 inherits the [+transitive] feature of the affix, $\text{obj}(VP_{2-inst}, NP_2)$ may correspond to $\text{OBJ}(V_2, NP'_2)$. In fact, NP'_2 , pade 'shoes' in (252a) displays the properties of a direct object of the derived verb, am-r- 'dance-INST.' For example,

pade 'shoes' passivizes, as was demonstrated in (234c) above. The remainder of the analysis of (252a) parallels that given above for (246). The s structure corresponding to l-s structure (252b) is displayed in (254) (each constituent X' in (254) is the s structure counterpart of l-s constituent X in (252b)).

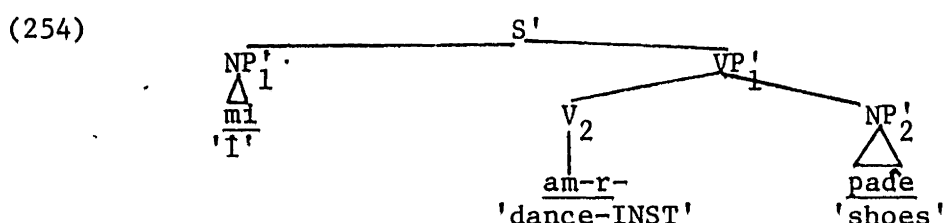

The careful reader might ask what happened to the s structure counterpart of PP_2 , PP'_2 , in (254). Following definition (196) above, we determine that the s structure counterpart of PP_2 in (252b) should be the phrase headed by the s structure counterpart of its immediate head, VP_{2-inst} . The s structure counterpart of $V_{-2-inst}$ was determined above to be V_2 , at least with respect to the $obj(VP_{2-inst}, NP_2)$ relation within PP_2 . V_2 assigns NP'_2 its syntactic role and NP'_2 bearing a syntactic role serves as argument to V_2 . So following our principles, we derive (255) as the s structure corresponding to (252b).

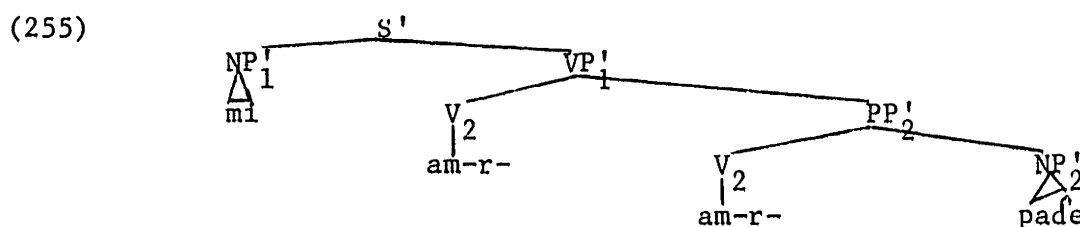

But (255) is equivalent to (254); it encodes the same grammatical relations. Again, confusions arise because of the difficulty in giving a structural representation to both the argument and the object relations. An argument is a constituent bearing a semantic/syntactic role. The argument of V_2 in both (254) and (255) is NP'_2 bearing the syntactic role assigned to it by V_2 ; NP'_2 is the OBJ of V_2 in both structures.

If we assume that the Chichewa instrumental affix, like the Fula, triggers

the assignment of the instrumental role as shown in (245), but that the Chichewa affix, unlike the Fula, remains separate at s structure from the root verb to which it attaches, the theory of this dissertation explains the peculiar aspects of the Chichewa instrumental applied verb construction described above: The instrumental argument appears as the subject of sentences containing the Chichewa instrumental applied verb and the passive morpheme is obligatory with the Chichewa instrumental applied affix. Consider Chichewa sentence (236b), repeated here as (256a). On the assumption that the Chichewa instrumental suffix -ts- effects the assignment of the instrumental role as does the Fula affix -r-, the l-s structure of (256a) should look like (256b) in all relevant details.

- (256) a. Khásu lí-ma-(lí-)lim-its-ídw-a chí-manga.
 hoe_i it_i -HABIT-(it_i -)farm-CAUSE-PASS-INDIC corn
 'The hoe is used to farm corn with.'

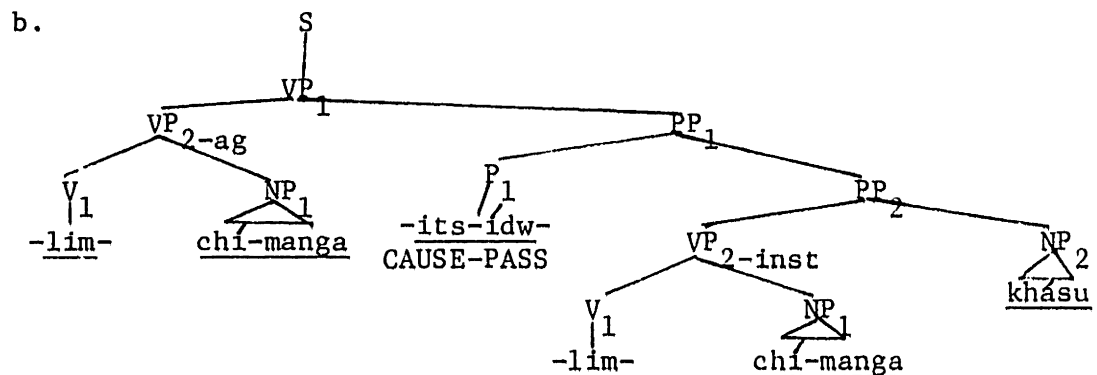

Note that I have attached the passive morpheme, -dw-, to the instrumental applied affix -ts- in (256b), respecting the order of constituents inside the Chichewa verb. The passive morpheme -dw- should carry the feature [-Pred SR] in (256b) as it does in canonical passives like (257b).

- (257) a. Jóni a-ná-(zí-)nyamul-a n-thóchí.
 John_i he_i -PAST-(them_i -)carry-INDIC bananas_j
 'John carried the bananas.'
- b. N-thóchí zí-ná-(zí-)nyamul-idw-a.
 bananas_i they_i -PAST-(they_i -)carry-PASS-INDIC
 'The bananas were carried.'

Whether -dw- also carries the [-transitive] feature in (256a) is unimportant, as we shall see shortly. The internal structure of the combination of the instrumental applied affix (CAUSE) -ts- and the passive morpheme -dw- is shown in (258).

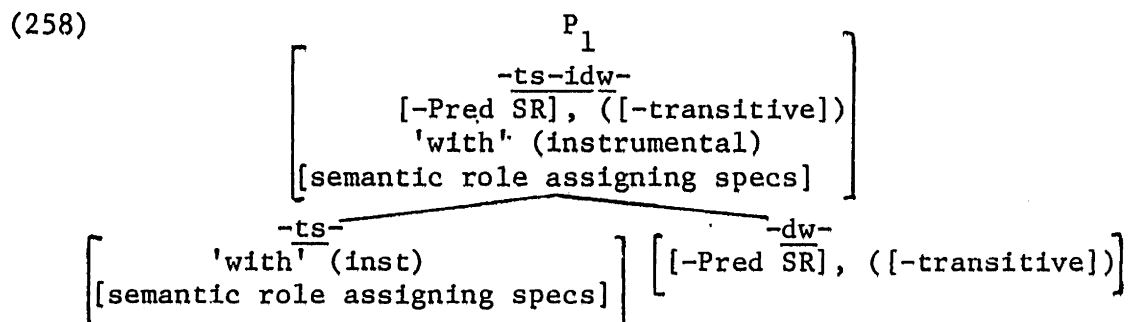

Since the modifiers produced by the modifier-argument structure of -ts-idw- in (258) modify predicates to yield predicates, the [-Pred SR] feature on the derived affix P_1 , -ts-idw-, in (258) must be interpreted to mean that the predicate resulting from the combination of the modifier that -ts-idw- produces and a predicate is not a sister to a logical subject at l-s structure. In (256b) the relevant predicate is VP_1 , and, as demanded by the [-Pred SR] feature on P_1 , VP_1 has no logical subject.

The l-s relations encoded in the l-s structure (256b) are listed in (259).

- (259) a. mod(pp_1 , VP_{2-ag}) b. obj(V_1 , NP_1) c. arg(V_1 , NP_1)
 d. arg(P_1 , PP_2) e. obj(VP_{2-inst} , NP_2)

We have assumed that the instrumental applied affix P_1 and the verb V_1 remain distinct constituents at s structure in Chichewa. To determine the s structure counterparts of the l-s relations in (259), it is essential to determine the s structure counterparts of the l-s constituents mentioned in the relations (I will again use X' as an abbreviation of "the s structure counterpart of X"). Of particular interest are the s structure counterparts of VP_{2-ag} and VP_{2-inst} . Recall that the s structure counterpart of an l-s phrase is defined

in terms of the s structure counterpart of its head. The head of both VP_{2-ag} and VP_{2-inst} is V_1 , and, since there is no merger of l-s constituents at s structure, the s structure counterpart of V_1 , V_1' , will be V_1 itself. Therefore, according to (196) above, the s structure counterparts of both VP_{2-ag} and VP_{2-inst} will be the phrase headed by V_1' at s structure, a phrase we shall call VP_2' . It is clear that $\text{mod}(PP_1, VP_{2-ag})$ will correspond to $\text{MOD}(PP_1', VP_2')$, $\text{obj}(V_1, NP_1)$ will correspond to $\text{OBJ}(V_1', NP_1')$, $\text{arg}(V_1, NP_2)$ to $\text{ARG}(V_1', NP_2')$, and $\text{arg}(P_1, PP_2)$ to $\text{ARG}(P_1', PP_2')$ (see the table in (69) of Chapter Two). To satisfy principle (66) as applied to the $\text{obj}(VP_{2-inst}, NP_2)$ relation, the s structure counterpart of NP_2 , NP_2' must be head-Governed by the s structure counterpart of VP_{2-inst} , VP_2' . Since VP_2' is modified by PP_1' , it will head a VP, VP_1' , consisting of VP_2' and PP_1' . Principle (66) will be satisfied, then, if $\text{obj}(VP_{2-inst}, NP_2)$ corresponds to $\text{SUB}(VP_1', NP_2')$. The s structure corresponding to l-s structure (256b) is shown in (260).

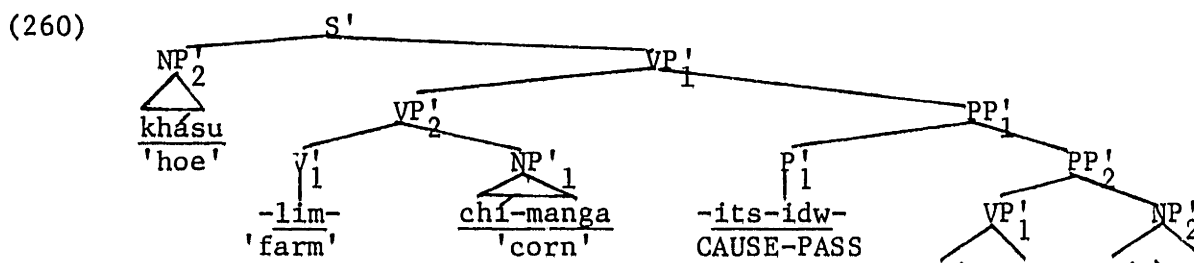

The tree in (260) contains some peculiarities which are a direct result of the decisions made on the representation of arguments in constituent structure. Recall that an s structure argument is technically a constituent bearing a syntactic rôle. The argument of P_1' in (260) is really NP_2' bearing the role assigned by VP_1' , not the combination of VP_1' and NP_2' , which is, strictly speaking, an S. VP_1' does assign NP_2' a syntactic rôle in (260) and together they do form an S, S' . However, NP_2' bearing its rôle and not S' is the argument of P_1' .

The surface structure of (256a) follows from the s structure in (260)

if we make reasonable assumptions about the expression of grammatical relations in Chichewa surface structures. NP_2' will not appear in surface structure by virtue of bearing the SUB relation with respect to VP_1' (see section 2.6.1). However, NP_2' will be the OBJ of tense/agreement in (256a) and will appear by virtue of bearing this relation (I left tense/aspect out of the 1-s and s structures for (256a) to facilitate the discussion above). The $MOD(PP_1', VP_2')$ relation is expressed through the merger of the lexical heads of PP_1' and VP_2' , P_1' and V_1' . Note that the lexical head of PP_2' is also V_1' . Therefore, the $ARG(P_1', PP_2')$ relation is also expressed by the merger of P_1' and V_1' . The $OBJ(V_1' NP_1')$ relation in (260) is expressed by the [NP, VP] structural relation, where the surface structure counterpart of NP_1' is the NP and V_1' heads the VP.

We have just seen why the instrumental NP in Chichewa becomes the SUB of a sentence containing an instrumental applied verb. It should also be clear why the passive morpheme is obligatorily used with the Chichewa instrumental applied affix, -ts-. If the passive morpheme were absent from (256b), P_1 would not be [-Pred SR] and thus the predicate VP_1 would be sister to a logical subject. The resulting 1-s structure would look something like (261), with some NP_3 serving as logical subject to VP_1 .

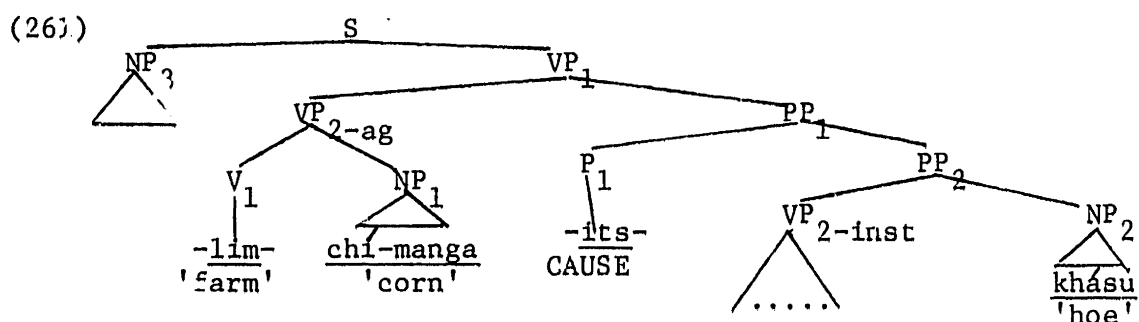

The s structure counterpart of VP_1 in (261), VP_1' , can only take one SUB in s structure. Recall that the s structure counterparts of both VP_{2-ag} and VP_{2-inst} will be a single constituent headed by V_1 , -lim- 'farm,' a constituent we called VP_2' above. The s structure counterpart of NP_2 , NP_2' , must

be head-Governed by the s structure counterpart of VP_{2-inst} , VP'_2 , while the s structure counterpart of NP_3 , NP'_3 , must be head-Governed by the s structure counterpart of VP_1 , VP'_1 . VP'_1 consists of the s structure counterpart of PP_1 , PP'_1 , which is a modifier, and of VP'_2 , which is the modifiee of PP'_1 . Since VP'_2 heads VP'_1 , to be head-Governed by VP'_2 , NP'_2 must be the SUB of VP'_1 . But the s structure counterpart of NP_3 , the logical subject of VP_1 , must also be the SUB of VP'_1 at s structure. As VP'_1 can only take one SUB and as both NP'_2 and NP'_3 must be SUBs of VP'_1 to satisfy principle (66), Chapter Two, no well-formed s structure corresponds to the l-s structure in (261); that is, (261) is the l-s structure of no grammatical sentence.

From the example examined in the last paragraph, it should be evident that if an instrumental applied affix with the semantic role assigning specifications of the Chichewa (and Fula) affix does not become a single s structure verb with the verb roots to which it attaches, then either the applied affix or the verb roots must carry the feature [-Pred SR]. This restriction, which follows directly from the theory, surfaces in Chichewa as the requirement that the passive morpheme, which carries the feature [-Pred SR], co-occur with the instrumental applied affix -ts-. That is, the theory explains the obligatory presence of the passive morpheme in the Chichewa instrumental applied verb construction with -ts-.

3.4.2. Causative constructions. Causative constructions containing morphologically derived causative verbs have received a great deal of attention in recent years (see, e.g., Aissen 1974 and the papers in Shibatani, ed., 1976a). Some examples of these constructions from Turkish (Comrie 1976) are given in (262).

- (262) a. Ali Hasan-ı öl-dür-dü.
 Ali Hasan-ACC die-CAUSE-PAST
 'Ali caused Hasan to die.'

- b. Dişçi mektub-u müdür-e imzala-t-tı.
 dentist letter-ACC director-DAT sign-CAUSE-PAST
 'The dentist made the director sign the letter.'

Since the term "causative construction" has been used in different ways in the literature, I should make precise the class of constructions under consideration in this section. First, the head verbs in these constructions are morphologically derived causative forms. In (262), for example, the causative morphemes -dür- and -t- attach to the root verbs öl- and imzala- to derive causative verbs. Second, the causative verb formation process which produces the derived causative verbs is productive. Most verbs in the languages containing the causative constructions under consideration will have derived causative forms. Third, although they contain two "logical" clauses, the causative constructions under discussion constitute a single surface sentence. For example, although their English glosses are bi-clausal, the surface structures of (262a) and (262b) contain a single S (as argued in Aissen 1974). Finally, the semantics of the derived causative constructions is predictable, conveying the basic meaning, 'causer cause that S.' For example, (262a) means, 'Ali caused that Hasan died,' and (262b) means, 'The dentist caused that the director signed the letter.'

Comrie (1976) has proposed a universal analysis for the sort of causative construction described in the above paragraph. To explain Comrie's analysis, it will be useful to refer to a canonical causative sentence, that shown in (263).

(263) Elmer made Hortense lock the porcupine cage.

I have provided an l-s structure for (263) in (264) and have labelled the constituents of (264) to facilitate the discussion below.

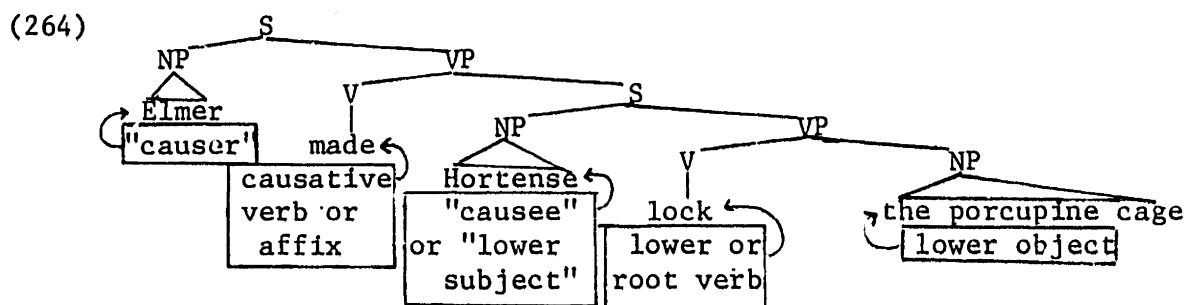

I will claim that, when we abstract away from the differences among the lexical items of particular languages, the 1-s structures of derived causative constructions are essentially identical to (264).

For his analysis of derived causative constructions, Comrie (1976) introduces the relational hierarchy shown in (265).

(265) subject-direct object-indirect object-other oblique position

Comrie also assumes that a derived causative construction has an "underlying structure" similar to (264). He claims that the embedded subject or causee in a causative construction is knocked out of the subject "slot" in the relational hierarchy (265) by the "causer." The causee then moves down the hierarchy, occupying the first empty slot. Thus in the causative of an intransitive verb like Turkish öl- 'die' in (262a), the causee will become the direct object, since no argument of the root verb occupies that slot. In the causative of a transitive verb like imzala- 'sign-' in (262b), on the other hand, the causee must travel to the indirect object position in (265) to find an empty slot. From his assumptions about the formation of derived causative constructions and from the hierarchy (265), Comrie computes the following "paradigm case" syntax for derived causatives crosslinguistically. The paradigm case generalizations in (266) are supposed to hold when the derived causative verb is active.

- (266) a. causative of intransitive verb:
 causer--subject of derived causative verb
 causee--direct object of derived causative

- b. causative of transitive verb:
 - causer--subject of derived causative verb
 - lower object--direct object of derived causative
 - causee--indirect object of derived causative

The "paradigm case" is illustrated by the Turkish examples in (262), where "ACC" is the marking of direct objects, "DAT" of indirect objects.

While he provides examples of languages which seem to exemplify the paradigm case of causative constructions, Comrie (1976) also notes many languages which do not conform to (266). Of particular importance to the analysis to be presented below, the generalization that the causee in the causative of a transitive verb becomes the indirect object finds little crosslinguistic support. While it is possible in many languages to express the causee of a causative built on a transitive root in the same case and/or with the same adposition used to express the goal argument of verbs like 'give,' a number of considerations lead one to conclude that this fact provides little evidence that the causee becomes an "indirect object" in the paradigm case (266b). First, some languages never express the causee as goals are expressed (cf. the discussion of Malayalam below). I know of no statistical study demonstrating that the causee with causatives built on transitive verbs is significantly more likely to be expressed as goals are expressed than to be expressed as are, say, instrumentals. Second, in languages which allow a causee to be expressed as are goals, this expression is often not obligatory (see Comrie 1976). Third, Comrie (1976) cites numerous cases of what he calls "doubling on indirect object," i.e., cases of the causee being expressed as goals are expressed in the language in the same clause as a goal, yielding two "indirect objects" in a single sentence. If the causee were truly occupying the "indirect object" slot in the hierarchy (265) in the paradigm case, where "indirect object" has the same theoretical status as "direct object," one would not expect the causee to become an indirect object in sentences containing

an indirect object, just as the causee does not (normally) become a direct object in sentences containing direct objects. A careful reading of Comrie's (1976) crosslinguistic survey of causative constructions, then, makes it clear that there is no evidence for a "paradigm case" in which the causee in causatives built on transitive verbs becomes an indirect object. Rather, the evidence indicates that many languages allow the causee of a transitive verb to be expressed as the goals of verbs like 'give' are expressed, while other languages allow this causee to be expressed as are instrumentals and still others provide different options.

Given a set of reasonable assumptions, the theory of this dissertation explains not only the main aspects of Comrie's "paradigm case" causative constructions but also the existence of a major, unrecognized class of exceptions to the paradigm case, as well as phenomena Comrie does not discuss. I will assume that the causative affix or morphology in derived causative constructions has basically the same lexical entry as the English causative verb make, that displayed in (267).

(267) 'cause' (caused), [+R], [+Pred SR], [+transitive]

Recall that [+R] is the feature which distinguishes raising from non-raising lexical items (see section 2.6.2.1 above). On the assumption that every morpheme with its own argument structure or semantic role assigning features functions as an independent l-s constituent, the l-s structures of derived causative constructions crosslinguistically will look just like the l-s structure of the English causative in (264), with the causative affix replacing make.

Since the causative affix appears on the root verb in the surface structure of a derived causative construction, the causative affix must merge with the root verb between l-s and s structure or between s and surface structure.

The theory predicts that languages in which the merger takes place between l-s and s structure will exhibit causative constructions with the basic syntax of Comrie's paradigm case. However, there are languages in which the merger of causative affix and root verb takes place between s and surface structures. The syntax of causative constructions in these languages differs markedly from the syntax of "paradigm case" causative constructions in a manner predicted by the theory.

Within the present theory, then, we expect three sorts of causative constructions crosslinguistically: the English-type causative in which the causative morpheme remains a separate constituent at every level of analysis, the paradigm case derived causative constructions in which the causative morpheme and root verb merge at s structure, and derived causative constructions in which the causative morpheme and root verb merge at surface structure. I list in (268) the main syntactic characteristics predicted by the theory for the two sorts of derived causative constructions. These predictions hold when the derived causative verb contains no passive morphemes or other morphemes which affect the correspondence between l-s and s structure relations.

- (268) a. merger between l-s and s structure:
- i. intransitive lower verb:
 - causer--SUB of derived verb
 - causee--OBJ of derived verb
 - ii. transitive lower verb:
 - causer--SUB of derived verb
 - lower object--OBJ of derived verb
- b. merger between s and surface structure:
- causer--SUB of derived verb
 - causee--OBJ of derived verb
 - lower object--never OBJ of the derived verb

The causee in (268.a.ii) will be an OBJ of the derived verb if the language allows a verb to assign two semantic and syntactic roles in the unmarked case; otherwise, it will be a syntactic argument, but not an OBJ, of the derived verb. In (268b), the lower object will be the OBJ of the lower verb at s

structure. Since the causee in constructions of type (268b) occupies the direct object slot in the hierarchy (265) regardless of whether this slot is occupied by the lower object, the causative constructions of type (268b) violate Comrie's theory of derived causatives. In the sections below, I examine in turn each sort of causative construction predicted by the theory of this dissertation, beginning with constructions in which no merger of causative morphemes and root verbs takes place and ending with constructions in which merger takes place between l-s and s structure.

3.4.2.1. Causative constructions without merger. We will consider first the English causative construction with make, in which no merger takes place between the causative morpheme and the lower verb. On the assumption that make is a raising verb, the s structure for sentence (263) above should be as shown in (269).

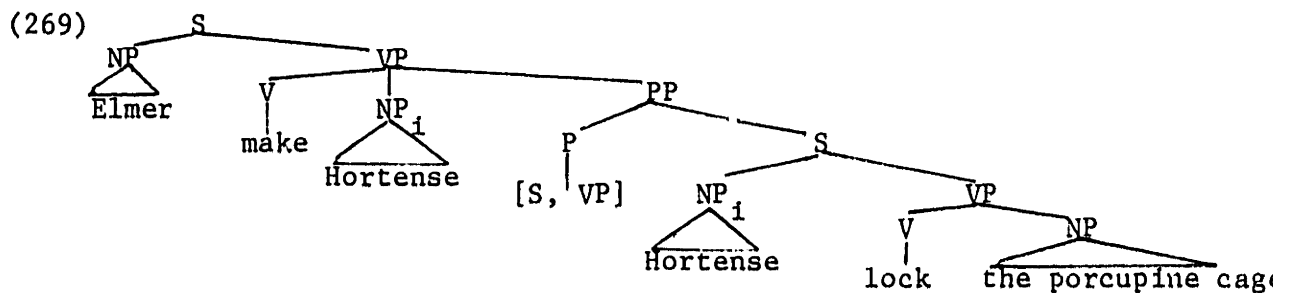

Recall that English provides verbs with the structural position [S, VP] to assign a syntactic role to the s structure counterparts of their propositional logical objects.

Certain aspects of the syntax of English causative constructions are easily inferred from (269) and the lexical entry of make in (267). First, adding the passive affix to the causative make, a raising to the object ([+R]) morpheme, will create a raising to subject morpheme (see section 3.1.1.1.3 above). Thus the causee will be the subject of the passive form of make, as in (270a). The lower object may not become the subject of the passive version

of the causative verb, of course (see (270b)).

- (270) a. Hortense was made to lock the porcupine cage.
 b. *The porcupine cage was made Hortense to lock.

However, the passive affix might be attached to the lower verb, making the lower object correspond to the SUB of the embedded clause and thus to the OBJ of the causative verb.

- (271) Elmer made the porcupine cage be locked by Hortense.

The possible antecedent-anaphor connections in English are governed by the binding theory sketched in Chapter Two, section 2.6.1. Recall that the binding theory applies at s structure. Since the causee is governed-bt (governed with respect to the binding theory) by the causative verb in the s structure of an English causative, but not governed-bt in the lower clause, the causee will have the upper clause as its governing-bt category. So a reflexive anaphor causee may have the causer as its antecedent -- see (272a). The lower object in an English causative construction is governed-bt by the lower verb and thus has the lower clause as its governing-bt category. Therefore, a lower object reflexive anaphor might have the causee as its antecedent -- see (272b), but the causer, falling outside the lower clause in a causative construction, may not serve as antecedent for a lower object reflexive -- see (272c).

- (272) a. Elmer made himself lock the porcupine cage.
 b. Elmer made Hortense help herself to the pâté.
 c. *Elmer made Hortense help himself to the pâté.

3.4.2.2. Merger between s and surface structure. Consider next Chi-Mwi:ni, a language in which the causative morpheme and lower verb merge between s and surface structure (data from Abasheikh 1979). A typical Chi-Mwi:ni causative sentence is found in (273).

- (273) Mwa:limu \emptyset -wa-'andik-ish-iz-e wa:na xaçi.
 teacher SP-OP-write-CAUSE-T/A children letter
 'The teacher made the children write a letter.'

If the Chi-Mwi:ni causative affix -ish- has basically the same lexical entry as English make, containing the information displayed in (267) above, and if merger of the affix and verb roots does not take place until surface structure, the s structure of a Chi-Mwi:ni causative like (273), shown in (274), should look just like the s structure of an English causative like (263), shown in (269).

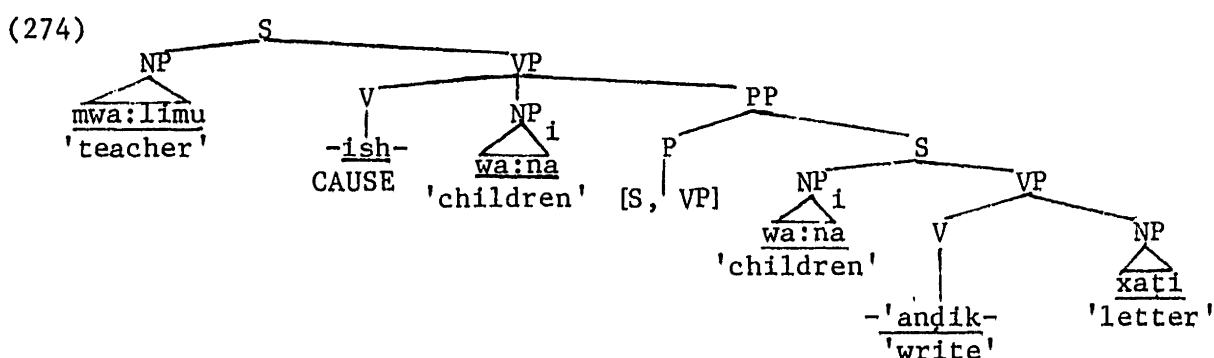

As was the case with the English causative construction discussed in the last section, placing the passive morpheme on the Chi-Mwi:ni causative morpheme -ish-, a raising to object morpheme, should create a raising to subject morpheme. So the causee, the SUB of the lower clause, should be the subject of the derived causative construction when the passive affix is attached to the derived causative verb, as in (275a). Of course, the lower object may not passivize when the passive morpheme is attached to the causative affix -- see (275b).

- (275) a. Wa:na wa-'andik-ish-iz-a: xaçi na mwa:limu.
 children SP-write-CAUSE-PASS-T/A letter by teacher
 'The children were made to write a letter by the teacher.'
- b. *Xaçi z-andik-ish-iz-a wa:na na mwa:limu.
 'The letter was made to be written by the children to the teacher.'

Due to constraints on the order of morphemes in a Chi-Mwi:ni verb, there is no way to passivize the lower verb in a Chi-Mwi:ni causative. The passive

morpheme is always interpreted as attaching to the causative affix.

Abasheikh (1979) demonstrates that there are severe restrictions on the distribution of and possible antecedents for the Chi-Mwi:ni reflexive pronoun ru:hu- 'self.' In particular, ru:hu- may only appear as an OBJ of a verb, as in (276).

- (276) Chi-~~lum~~-i~~z~~-e ruhu-z-i:tu.
 SP-bit-T/A ourselves
 'We bit ourselves.'

More precisely stated, the restriction on ru:hu- is that it appears as the OBJ and syntactic argument of the same verb. Abasheikh provides convincing evidence that the restriction on the distribution of ru:hu- refers to the grammatical relation OBJ and not to the structural position [NP, VP] or some similar "surfacy" characteristic of the anaphor. For example, in sentence (277) it is the benefactive 'you,' expressed as the object prefix (OP) alone, which is both the OBJ and argument of the derived applied verb -- the postverbal NPs are arguments but not OBJs of the derived verb (see section 3.4.1.1 above on applied verb constructions).

- (277) Ni-xu-som-esh-e~~z~~ez-e mwa:na chingere:nzá.
 I(SP)-you(OP)-learn-CAUSE-APPL-T/A child English
 'I taught the child English for you.'

Since mwa:na 'child' in (277), although an [NP, VP], is not the OBJ of the verb with respect to which it bears the argument relation, i.e., the derived applied verb, it may not be replaced by the reflexive ru:hu-, as shown in (278).

- (278) *Ni-xu-som-esh-e~~z~~ez-e ru:hu-y-a chingere:nzá.
 myself
 'I taught myself English for you.'

In addition to being restricted to OBJs, the reflexive ru:hu- must have a SUB as its antecedent, and this SUB must occur in the same s structure clause as ru:hu- (the latter condition is predicted by the binding theory presented in (102), Chapter Two). I will not repeat Abasheikh's evidence for these

restrictions; the reader is referred to Abasheikh (1979) for details.

Given the independently established characteristics of the Chi-Mwi:ni reflexive ru:hu-, our analysis of Chi-Mwi:ni causative constructions predicts that the causer, as SUB of the causative affix at s structure, can serve as antecedent for the causee, the OBJ of the causative affix, as a reflexive. The causee, as s structure SUB of the sentential complement of the causative affix, can serve as antecedent for the lower object, the OBJ of the embedded verb, as a reflexive. But the causer may not serve as antecedent for the lower object as a reflexive because the causer, although a SUB, does not appear in the same s structure clause as the lower object -- see (274) above. Abasheikh reports just the predicted range of data:

- (279) a. Mi m-p^h ik-ish-iz-e ru:hu-y-a cha:kuja.
 I SP-cook-CAUSE-T/A myself food
 'I made myself cook food.'
- b. Mi ni-m-big-ish-iz-e mwa:na ru:hu-y-é.
 I SP-OP-hit-CAUSE-T/A child himself
 'I made the child hit himself.'
- c. *Mi ni-m-big-ish-iz-e A*M*i ru:hu-y-á
 I SP-OP-hit-CAUSE-T/A Ali myself
 'I made Ali hit myself.'

Compare (279) with the English sentences (272). As expected, the evidence indicates that the Chi-Mwi:ni and the English causative constructions have structurally identical bi-clausal s structures.

We have seen that Chi-Mwi:ni provides striking support for the bi-clausal analysis of certain causative constructions at s structure. The surface structure of a Chi-Mwi:ni causative, schematized in (280), is identical to the surface structure of sentences headed by simple verbs and morphologically derived verbs such as the applied verbs discussed in section 3.4.1 above.

(280) NP V NP (NP)

Recall that only one of the postverbal NPs in a Chi-Mwi:ni sentence may be the OBJ of the main verb. Outside causative constructions, in no situation may ru:hu- 'self' appear as a postverbal [NP, VP] which is not the OBJ of the main verb in a surface structure like (280). It is just in the case where the theory leads us to believe that two s structure clauses underly a single surface structure clause, i.e., it is just in causative constructions, that this generalization concerning the distribution of ru:hu- is violated -- see (279b).

Like Chi-Mwi:ni, many other Bantu languages provide evidence that their derived causative constructions involve merger between s and surface structure. Outside the Niger-Congo family, however, Japanese is the only language I have found which also clearly exhibits this sort of causative construction. Some examples of Japanese derived causatives are given in (281).

- (281) a. Taroo ga Hanako o hatarak-ase-ta.
 Taro NOM Hanako ACC work-CAUSE-PAST
 'Taro made Hanako work.'
- b. Taroo ga Hanako ni hatarak-ase-ta.
 DAT
 'Taro let Hanako work.'
- c. Taroo ga Hanako ni okasi o tabe-sase-ta.
 Taro NOM Hanako DAT cake ACC eat-CAUSE-PAST
 'Taro let/made Hanako eat the cake.'

The Japanese causative affix is -sase. In the causative of an intransitive verb, e.g., (281a&b), the causee may be marked with either o or ni, the accusative and dative particles respectively. If the accusative o is used, the causative has a coercive reading, as indicated in (281a); if the dative ni is used, the causative is interpreted with a permissive reading, as in (281b).

If the Japanese causative construction, like the Chi-Mwi:ni, keeps the causative morpheme -sase separate from the root verb at s structure, the s structure of sentence (281c) should look like (282), isomorphic to (274) and

(269) above.

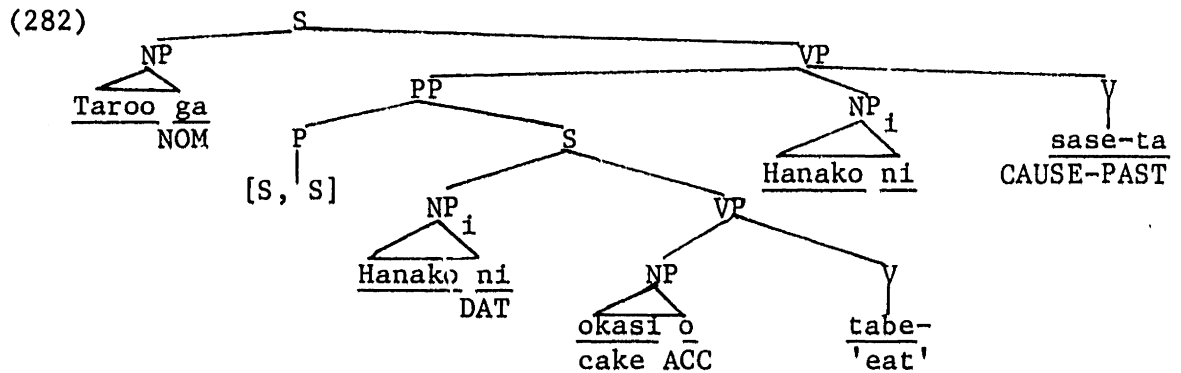

As with the Chi-Mwi:ni causative construction, we expect that only the causee, not the lower object, may passivize when the passive affix, -rare, is attached to the causative verb. (The particle ni serves the same function in Japanese passives as by serves in English passives.)

- (283) Farmer (1980, p. 105)
- a. Taroo wa Hanako ni sashimi o tabe-sase-ta.
 TCP DAT sashimi ACC eat-CAUSE-PAST
 'Taro made Hanako eat sashimi.'
 - b. Hanako wa Taroo ni sashimi o tabe-sase-rare-ta.
 DAT eat-CAUSE-PASS-PAST
 'Hanako was made to eat sashimi by Taro.'
 - c. *Sashimi wa Taroo ni Hanako ni tabe-sase-rare-ta.
 'Sashimi was made to be eaten by Hanako by Taro.'

Some speakers of Japanese permit the passive affix -rare to appear between the causative -sase and the root in a derived causative verb -- see (284). As expected by the present analysis, the addition of the causative affix to a derived passive root yields the causative of the passive, as shown in (284). The s structure of (284) is given in (285).

- (284) Mary wa Taroo o Ziroo ni home-rare-sase-ta.
 praise-PASS-CAUSE-PAST
 'Mary made Taro be praised by Ziro.'

marking for OBJs in Japanese. As was shown in (281a&b) above, if the lower verb is intransitive, the use of ni on the causee in causative constructions indicates a "permissive" or "let" causative while the use of o indicates a "coercive" or "make" causative. As illustrated in (281c) above, when the lower verb takes an object in o, the causee must be marked ni and the resulting causative is ambiguous between the permissive and coercive readings.

Within the theory of this dissertation, we must say that Japanese marks some OBJs with ni independent of the causative construction, As Kuno and others point out, some verbs require ni marking on their OBJs. One such verb is soodan suru 'consult,' which appears in (287).

- (287) From Kuno (1973, p. 347)
- a. John ga Mary ni soodansita.
'John consulted Mary.'
 - b. Mary ga John ni soodans-(r)are-ta.
'Mary was consulted by John.'

The passivizability of the "consulted" argument of soodan suru, illustrated in (287b), is, ceteris paribus, sufficient evidence that it is an OBJ in (287a) in the present theory. Martin (1975) also points out that the object of soodan suru may trigger object honorification. The goal argument of verbs like ataeru 'give' is marked with ni in Japanese. Since either the goal or theme of ataeru may passivize, both should be considered OBJs in sentences with active ataeru.

- (288) From Kuno (1980, p. 103)
- a. Yoshida-syusuoo ga Tanaka-tuusandaizin ni kunsyoo o ataeta.
prime minister Toshida NOM minister Tanaka DAT medal ACC give-PAST
'Prime minister Yoshida awarded minister Tanaka a medal.'
 - b. Tanaka-tuusandaizin ga Yoshida-syusuoo ni kunsyoo o ataerareta.
give-PASS-PAST
'Minister Tanaka was awarded a medal by Prime minister Yoshida.'
- From Ostler (1980, p. 78)
- c. Sono dorei wa Taroo ni Hanako ni ataerareta.
the slave TOP Taro DAT Hanako DAT give-PASS-PAST
'The slave was given to Hanako by Taro.'

The data indicate, then, that Japanese OBJs may be marked with ni.

Although the data indicate that Japanese OBJs may be marked ni, the question remains why the causee as OBJ must be marked ni in case the lower verb is transitive. This question divides into two parts. First, we may ask why the lower object and the causee cannot both be marked o. As has been discussed at length in the literature, Japanese includes a constraint which prohibits two o marked OBJs from appearing in the same surface clause (see Poser 1981 for a precise formulation of this constraint). If both the causee and the lower object were marked with o, as in (289), this "double o" constraint would be violated.

(289) *Taroo ga Hanako o okasi o tabe-sase-ta.
'Taro made Hanako eat the cake.'

However, if the lower object must be marked ni for some reason -- say it is the OBJ of soodan suru, which, we saw in (287a), requires ni marking on its OBJ -- then the causee may be marked with o.

(290) Bill wa John o Mary ni soodansasetta.
consult-CAUSE-PAST
'Bill made John consult with Mary.'

Given some constraint against two o marked OBJs in a surface clause, we still must explain why the lower object rather than the causer receives the o marking in causative constructions. I have no principled account of this phenomenon and leave the problem open for further investigation.³⁹

3.4.2.3. Merger between l-s and s structure. The final type of causative construction to be discussed here corresponds to Comrie's "paradigm case." In the present theory, the paradigm case results from the merger of the causative affix with the root verb at s structure. Consider the Malayalam causatives in (291b) and (291d) (data from Mohanan 1981a, 1981b).

(291) a. kuṭṭi kafaññu.
child-NOM cried
'The child cried.'

- b. *acchan kuṭṭiye kaṛayiccu.*
 father-NOM child-ACC cry-CAUSE-PAST
 'Father made the child cry.'
- c. *kuṭṭi aanaye nuḷḷi.*
 child-NOM elephant-ACC pinched
 'The child pinched an elephant.'
- d. *amma kuṭṭiyekkontə aanaye nuḷḷiccu.*
 mother child-INST elephant-ACC pinch-CAUSE-PAST
 'Mother made the child pinch the elephant.'

In the causative of an intransitive Malayalam verb like *kaṛa* 'cry' in (291b), the causee normally appears in the case of direct objects, the accusative in (291b). When the causative affix is attached to a transitive verb as in (291d), however, the lower object is marked as are direct objects while the causee appears with an instrumental postposition *-kontə*. The basic syntax of the Malayalam causative construction follows, I will claim, from the assumption that the causative affix merges with the root verb between l-s and s structure.

On the assumption that the Malayalam causative affix *-ik'k'-* has basically the same lexical entry as the English causative *make*, that in (267) above, except that *-ik'k'-* has the morphological subcategorization features of an affix, the l-s structure of (291b) should be as in (292).

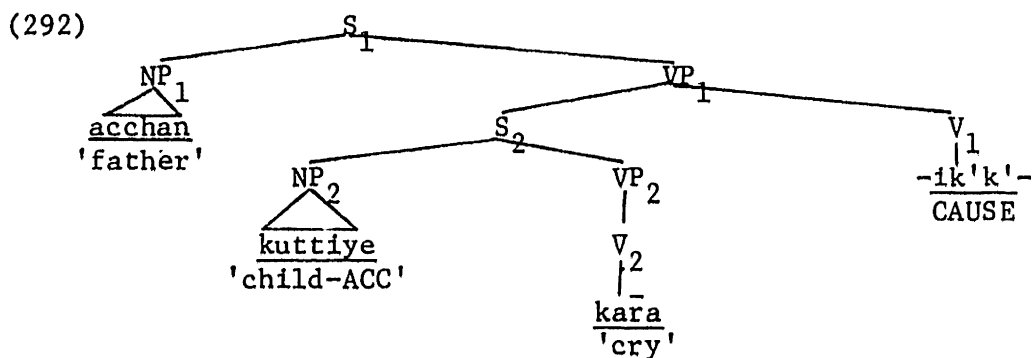

The l-s relations encoded in (292) are listed in (293).

- (293) a. $\text{sub}(\text{VP}_1, \text{NP}_1)$ b. $\text{obj}(\text{V}_1, \text{S}_2)$ c. $\text{arg}(\text{V}_1, \text{S}_2)$
 d. $\text{sub}(\text{VP}_2, \text{NP}_2)$

To determine the s structure counterparts of the relations in (293) we must examine the internal structure of the derived causative verb *kaṛa-ik'k'-*

'cry - CAUSE.'

(294)

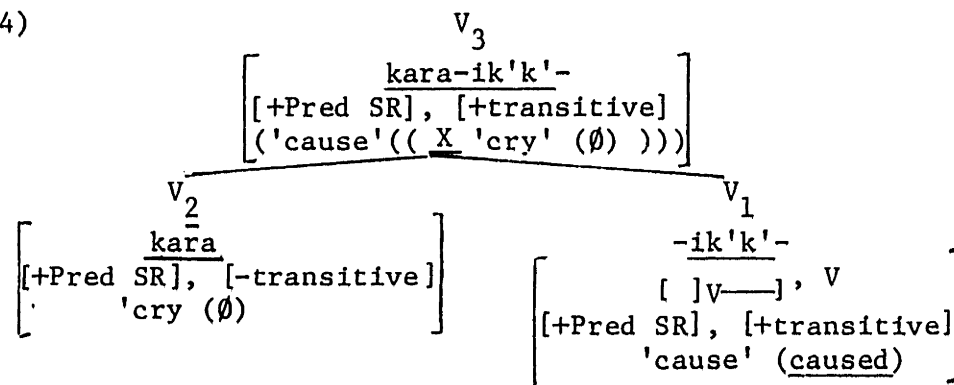

The merger of V_1 and V_2 at s structure expresses the logical object and argument relations between V_1 and S_2 . According to principle (203), the s structure counterpart of V_1 will be V_1 and that of S_2 will be V_2 . Principle (66) of Chapter Two will demand that $\text{obj}(V_1, S_2)$ and $\text{arg}(V_1, S_2)$ correspond to $\text{MER}(V_1, V_2)$. Principle (203) also implies that the semantic role assigning properties of V_1 that allow it to serve as operator in the $\text{obj}(V_1, S_2)$ relation are absorbed by the merger of V_1 and V_2 such that they will not percolate in the derived verb V_3 .

If the merger of V_1 and V_2 absorbs the semantic role assigning features of V_1 in (292), then V_1 will have no semantic role assigning features to percolate in (294). The root verb V_2 , being logically intransitive, has no inherent semantic role assigning properties either. However, by principle (206) above, either V_2 or V_3 will be the s structure counterpart of VP_2 and inherit the semantic role assigning properties of this predicate. Principle (206) applies to VP_2 because the merger of V_1 and V_2 , the immediate head of VP_2 , expresses neither an l-s relation between VP_2 and some other constituent nor an l-s relation between daughters of VP_2 . Since the affix, V_1 in (294), does not percolate semantic role assigning features, the root, V_2 , would percolate up to V_3 the features it would inherit if it served as s structure counterpart to VP_2 . So V_3 , the derived causative verb, must be seen as assigning the role

assigned by the predicate VP_2 at l-s structure and V_3 is the s structure counterpart of VP_2 with respect to the $sub(VP_2, NP_2)$ relation. I have indicated the semantic role assigning features of V_3 by underlying "X" within the complex P-A structure of the derived verb kaṛa-ik'k'- 'cry - CAUSE.' Since the merger of V_1 and V_2 within V_3 expresses the logical object and argument relations between V_1 and S_2 , the predicates produced by V_3 in (294) result from inserting a proposition bearing the "caused" role into the P-A structure of -ik'k' CAUSE. The proposition itself is produced by combining a predicate produced by kaṛa 'cry' and a logical subject of this predicate, "X" in (294). I have schematized the compositional semantics of the derived verb kara-ik'k'- 'cry - CAUSE' within the complex P-A structure under V_3 in (294).

Since V_3 is the s structure counterpart of VP_2 with respect to the $sub(VP_2, NP_2)$ relation, the s structure counterpart of $sub(VP_2, NP_2)$ may be $OBJ(V_3, NP'_2)$ (as above, I will use X' as an abbreviation for "the s structure counterpart of X"). The derived verb V_3 inherits the [+transitive] feature of the affix in (294), allowing it to take an OBJ at s structure. From the above discussion, we may conclude that the s structure for (292) should look like (295).

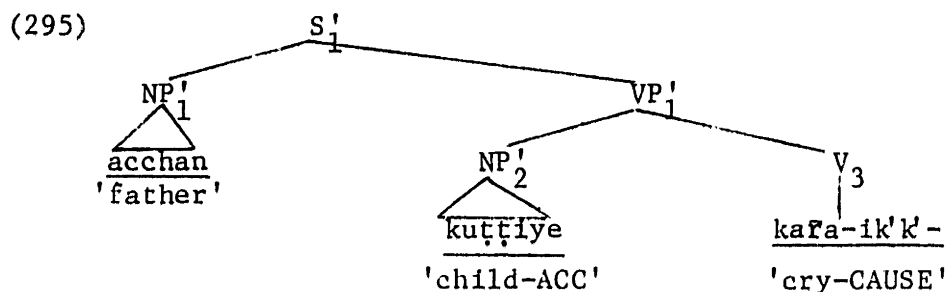

Unlike the causee in Chi-Mwi:ni, Japanese, or English, NP'_2 is not a SUB at s structure. Malayalam restricts the antecedent of the reflexive swa- 'self' to subjects (see Mohanan 1981a&b). As predicted, the causee may not serve as antecedent for a reflexive in Malayalam.

- (296) acchan kuṭṭiye swaṅṭam wiṭṭil weccə kaṛayiccu.
 father-NOM child-ACC self's house at cry-CAUSE-PAST
 'Father made the child cry at father's/*child's house.'

Recall that the antecedent of the Chi-Mwi:ni reflexive ru:hu- 'self' is also restricted to SUBs. In Chi-Mwi:ni the causee may serve as antecedent for ru:hu-, as shown in (279b) above. The contrast displayed in (279b) and (296) is a direct consequence of the difference between Chi-Mwi:ni and Malayalam in the locus of merger between the causative affix and root verb.

The analysis of a Malayalam causative containing a transitive root verb is only slightly more complicated than the analysis of (291b). In (297b) I display the 1-s structure of (291d), repeated here as (297a).

- (297) a. amma kuṭṭiyekkoṅṭə aanaye ṅuḷliccu.
 mother-NOM child-INST elephant-ACC pinch-CAUSE-PAST
 'Mother made the child pinch the elephant.'

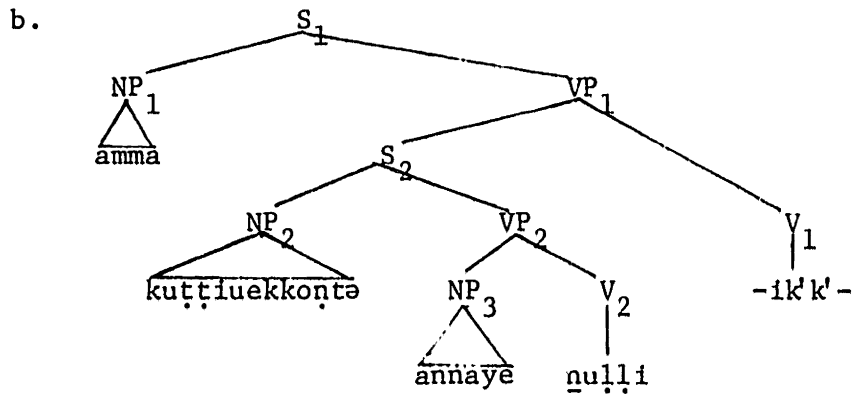

The 1-s relations encoded in (297b) are listed in (298).

- (298) a. sub(VP₁, NP₁) b. obj(V₁, S₂) c. arg(V₁, S₂)
 d. sub(VP₂, NP₂) e. obj(V₂, NP₃) f. arg(V₂, NP₃)

The internal structure of the derived causative verb ṅuḷlik'k'- 'pinch-CAUSE' is shown in (299).

(299)

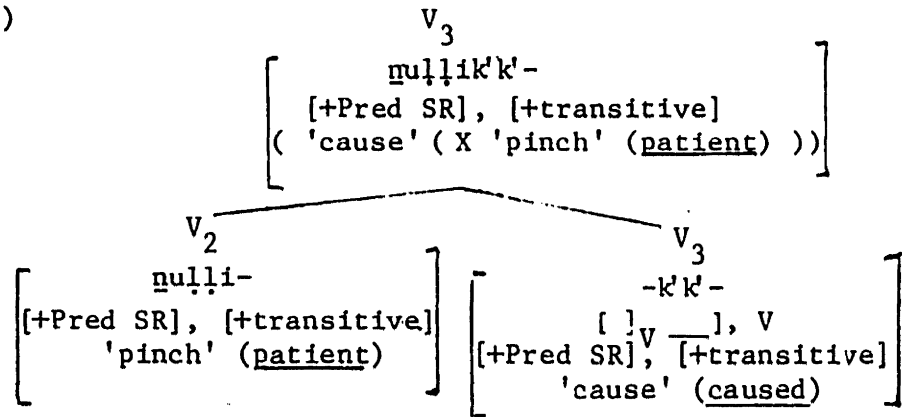

As the merger of V_1 and V_2 at s structure expresses the logical object and argument relations between V_1 and S_2 , $\text{obj}(V_1, S_2)$ and $\text{arg}(V_1, S_2)$ correspond to $\text{MER}(V_1, V_2)$. As explained above, the merger of V_1 and V_2 , in expressing the $\text{obj}(V_1, S_2)$ relation, will be seen as absorbing the semantic role assigning properties of V_1 . Therefore, the causative affix V_1 in (299) will have no semantic role assigning features, and the semantic role assigning features of the root V_2 will be free to percolate. Since the merger of V_1 and V_2 expresses neither the l-s relation between VP_2 and some other constituent nor an l-s relation between daughters of VP_2 , by principle (206) the s structure counterpart of VP_2 will be V_2 or V_3 depending on feature percolation. So V_2 may have both inherent semantic role assigning features -- it assigns a patient role -- and the semantic role assigning features of VP_2 . However, according to principle (251), a principle which proved necessary in the analysis of instrumental applied verbs, a morpheme will percolate inherent features over derived features. Thus V_2 will percolate to V_3 the patient assigning feature and not the semantic role assigning features of VP_2 and V_2 itself will be the s structure counterpart of VP_2 with respect to $\text{sub}(\text{VP}_2, \text{NP}_2)$. Since V_3 is transitive, the $\text{obj}(V_2, \text{NP}_3)$ and $\text{arg}(V_2, \text{NP}_3)$ relations will correspond to the $\text{OBJ}(V_3, \text{NP}'_3)$ and $\text{ARG}(V_3, \text{NP}'_3)$ relations.

The remaining difficulty in the analysis of (297a) is determining the

s structure counterpart of the $\text{sub}(\text{VP}_2, \text{NP}_2)$ relation. As stated above, the s structure counterpart of VP_2 with respect to $\text{sub}(\text{VP}_2, \text{NP}_2)$ is V_2 . Therefore, to satisfy principle (66) of Chapter Two, the s structure counterpart of $\text{NP}_2, \text{NP}'_2$, must be head-Governed by V_2 at s structure. V_2 will not head an argument-taking phrase at s structure, but it is [+transitive], so the $\text{sub}(\text{VP}_2, \text{NP}_2)$ relation may correspond to $\text{OBJ}(V_2, \text{NP}'_2)$. The s structure corresponding to (297b) is given in (300).⁴⁰

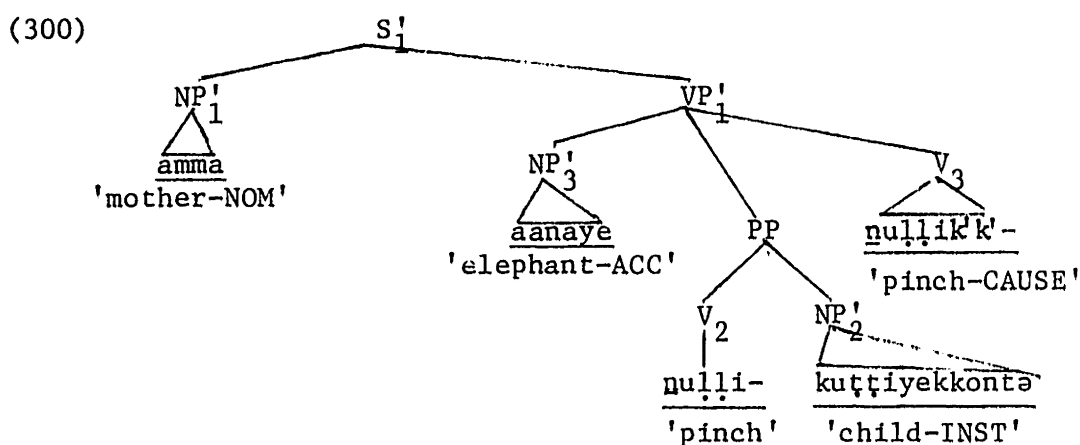

The s structure in (300) is structurally similar to the s structures of the applied verb constructions analyzed in section 3.4.1. In particular, compare (300) to the s structure of the Fula instrumental applied verb construction in (250) above. As in (250), it is the logical object of the root verb which corresponds to the OBJ of the derived verb in (300). Since NP'_2 is the OBJ of a verb in (300), although not the main verb of VP'_1 we would expect it to be expressed as OBJs of verbs are usually expressed in Malayalam, just as jambere 'axe' in the Fula sentence (250) is expressed as an [NP, VP] although it is not the OBJ of the main verb. However, unlike Fula, Malayalam does not exhibit "double object" constructions in surface structure; it does not allow two OBJs to be expressed the same way in a single surface structure clause. Malayalam chooses to express the causee in structures like (300) as the object of the instrumental postposition -kontə. Tamil is a Dravidian

language very closely related to Malayalam. As far as I have been able to determine, the syntax of Tamil and Malayalam causatives is identical with the following exception: where Malayalam expresses the causee of a causative construction with transitive root verb in a postpositional phrase containing the instrumental postposition -kontə, Tamil puts the causee in such constructions in the accusative case. That is, Tamil exhibits the double object constructions with derived causatives containing transitive root verbs expected from the s structure in (300). Other languages which merge the causative affix and root verb at s structure express the causee of s structures like (300) in the manner of goals (as "indirect objects") while still others express the causee of such s structures however the displaced subject in a passive is expressed (see Comrie 1976 for examples of the various sorts of languages.)⁴¹

As predicted by the s structure in (300), it is the lower object, not the causee, which becomes the subject of the passive of a Malayalam causative built on a transitive verb. Sentence (301) contains the passive of the verb in (300).

- (301) ammayaal aana nullikk'k'appettu.
 mother-INST elephant-NOM pinch-CAUSE-PASS-PAST
 'The elephant was caused by mother to be pinched.'

Compare the passive in (301) with the ungrammatical (275b) from Chi-Mwi:ni and (283c) from Japanese. It is only when merger of causative affix and root verb takes place between l-s and s structure that the lower object of a derived causative may passivize. Recall that the Malayalam reflexive swa- 'self' requires an s structure subject for its antecedent. Because it is not a SUB at s structure, the causee of the Malayalam causative, unlike the causee of the Chi-Mwi:ni and Japanese causatives discussed above, may not serve

kendi- 'self' and its antecedent is clause bound, at least with a first person antecedent. Sentence (304) is ungrammatical with the indicated interpretation because the first person antecedent, ben 'I,' does not fall into the same s structure sentence as the reflexive kendi- 'self.'

- (304) *Ben Hasan-ın kendim-i yıka-masına sevindim.
 -GEN self-ACC wash-PART was-pleased
 'I was pleased that Hasan washed me.'

When merger of the causative affix and root verb takes place between l-s and s structure, the causative construction has a monoclausal s structure and the causer and lower object fall into the same s structure sentence. Thus a first person causer should be able to serve as antecedent for kendi- 'self' as lower object in a Turkish causative construction. As Aissen shows, this is precisely the case.

- (305) Hasan-a kendim-i yıka-t-tım.
 -DAT self-ACC wash-CAUSE-PAST.1sg
 'I made Hasan wash me.'

Compare (305) with the ungrammatical Chi-Mwi:ni sentence (279c). When merger takes place between s and surface structure, as in Chi-Mwi:ni, and the antecedent-anaphor relation is clause bound, the causer may not serve as antecedent for a lower object reflexive.

The causee is not an OBJ of the derived Malayalam or Turkish causative verb formed from a transitive root because these languages allow a verb to assign only one semantic role in the unmarked case. Percolation of the inherent semantic role assigning features of the transitive root verb to the derived causative verb prevents the percolation of semantic role assigning properties it might inherit from the embedded predicate in a causative construction. Therefore, the derived causative verb does not serve as the s structure counterpart of the lower predicate with respect to the logical subject relation

between the causee and the lower predicate, and, one may determine, the causee must be the OBJ of the constituent which does serve as the s structure counterpart of the lower predicate with respect to the logical subject relation.

In a language which allows a verb to assign more than one semantic role in the unmarked case, we would expect both the inherent semantic role assigning properties of a transitive root verb and the semantic role assigning properties the root verb might inherit from the lower predicate to percolate to become features of the derived causative verb. In such a language, the derived causative verb would serve as the s structure counterpart to the lower predicate with respect to the logical subject relation between the lower predicate and the causee and as the s structure counterpart to the root verb with respect to the object relation between this verb and the lower object. Thus both the causee and the lower object could be OBJs of the derived causative verb.

In section 3.4.1.1.2 above I presented evidence that Kinyarwanda (see Kimenyi 1980) allows a verb to assign two semantic roles in the unmarked case. Kinyarwanda also seems to merge its causative affix and root verbs between l-s and s structure. I provide an example of a Kinyarwanda causative built on a transitive verb stem in (306) below.

- (306) Umugabo á-r-úbak-iish-a abákozi inzu.
 man SP-PRES-build-CAUSE-ASP workers house
 'The man is making the workers build the house.'

If our analysis is correct, both the causee abakozi 'workers' and the lower object inzu 'houses' should be OBJs of the derived verb -uubak-iish- 'build-CAUSE' in (306). In fact, Kimenyi (1980) demonstrates that both have the Kinyarwanda OBJ properties. In particular, both will passivize.

- (307) a. Abákozi bá-r-úubak-iish-w-a inzu n'úmugabo.
 workers SP-PRES-build-CAUSE-PASS-ASP house by-man
 'The workers are made to build the house by the man.'
- b. Inzu í-r-úubak-iish-w-a abákozi n'úmugabo.
 house SP-PRES-build-CAUSE-PASS-ASP workers by-man
 'The house is being made to be built by the workers by the man.'

Compare sentences (307) with sentences (283b&c) from Japanese and sentences (275) from Chi-Mwi:ni. Recall that since either the goal or the theme argument of Japanese ataeru 'give' may passivize (see (288) above), Japanese, like Kinyarwanda, must be seen as allowing verbs to assign two syntactic roles -- to take two OBJs. Yet only the causee, not the lower object, may passivize when the passive affix is attached to a Japanese derived causative -- compare sentences (288) to sentences (283). In contrast, either the causee or the lower object of a Kinyarwanda derived causative may passivize, as shown in (307) above. As we have seen in the above paragraphs, this difference between Japanese and Kinyarwanda is predicted under the assumption that the causative affix and root verb merge between l-s and s structure in Kinyarwanda, but between s and surface structure in Japanese.

FOOTNOTES

1. For present purposes we will consider "affixes" those morphemes with word tree subcategorization features. See Lieber (1980) for a definition of "affix."
2. Throughout the rest of the dissertation I will sometimes write "principle (66)" for "principle (66), Chapter Two."
3. The [-transitive] feature of passive participles might be provided to them by the markedness principle that [-Pred SR] verbs are [-transitive] in the unmarked case -- see section 3.1.1.2 below. That is, the passive affix need not carry the feature [-transitive] to insure that passive participles are [-transitive]. However, as will be explained below, the English passive affix -en must carry the feature [-transitive] because it attaches only to [+transitive] roots.
4. A predicate is a function from arguments bearing semantic roles to propositions. One possible representation of a predicate is as an open sentence with a free variable. We may say that the value of each of these predicates/functions given the null argument, i.e., no argument, as in agentless passives, is determined by substituting "someone" or "something" for the free variable in the open sentence. The predicate returned by sell in the agentless passive (16) is a function from arguments bearing the "seller" role to propositions and may be represented as the open sentence, (x sell the porcupine for twenty dollars). When given the null argument, as in (16), this function returns the proposition, (someone sell the porcupine for twenty dollars).
5. Since the logical object of by is assigned its semantic role (in-

directly) by a predicate and serves as an argument to a predicate, it is, in an important sense, a logical subject. If some rule or generalization in a language referred to logical subjects as a class, it should apply to the object of by.

6. It is quite simple to collapse the account of the by phrase used with passive participles with that of the by phrase in nominalizations like the city's destruction by Elmer. However, there are a number of interesting phenomena associated with derived nominals which indicate that the connection between, e.g., the city's destruction by Elmer and The city was destroyed by Elmer is not straightforward (see, e.g., Kayne 1981, Rappaport 1980, Williams 1980b, and the references cited in these sources). For the moment, suppose that certain nouns are associated with nominal-argument structures like those described in Chapter Two, but instead of nominals, nominal-argument structures like (1) produce functions from argument to nominals.

(1) 'destruction' (destroyed)

The nominal-argument structure named by destruction -- (1) -- takes in arguments bearing the "destroyed" role and yields an object, which we may call "nominal-producer," that assigns a semantic role to a constituent and takes in a constituent bearing this role to yield a nominal. A derived nominal like destruction creates nominal-producers which assign the same semantic role as the predicates created by the P-A structure of the related verb destroy.

In addition to heading predicate modifiers, the preposition by may head a modifier of nominal-producers. Within NPs, by would assign to its logical subject the semantic role assigned by the nominal-producer

which is sister to the modifier by heads at l-s structure. Then by would apply the modifier-producer to its logical object to yield a nominal. That is, by functions in nominals precisely as it functions in sentences.

. This account of the function of by in nominals allows us to generalize the use of by in passives to its use with nouns like portrait in (ii) which have no obvious verbal counterparts.

- (ii) The portrait of Elmer by the famous post-dadaist hangs in the public zoo.

Although portrait is not directly related (i.e., related by a productive morphological process) to a verb with a P-A structure, it names a nominal-argument structure, which takes in Elmer as an argument in (ii) and yields the nominal-producer 'portrait of Elmer.' The nominal-producers that portrait's nominal-argument structure yields take in an argument bearing the semantic role, "painter of the portrait of the logical object of portrait," a role which by may assign in nominals.

The possessive marker, 's, is available to every noun phrase and serves a variety of functions. Like of (see section 2.4.2.4.3), 's may be provided to any noun to assign a syntactic role to the s structure counterpart of the noun's logical object, creating an argument phrase to bear the argument relation with respect to the noun at s structure.

- (iii) the city's destruction

In (iii) destruction's logical object, the city, corresponds to an OBJ in an argument phrase headed by 's which serves as argument to destruction at s structure. In addition to serving as a syntactic role assigner with no l-s counterpart, as in (iii), the possessive 's may play the role of by in nominals, as in (iv).

(iv) Elmer's destruction of the city

The possessive ending in (iv) serves the same function as by in (v).

(v) the destruction of the city by Elmer

The resemblance between derived nominals and passive constructions in the present theory is accounted for by the similarity between the nominalizations and passive participle formation processes. Since nouns are by nature [-transitive], nominalization like passivization detransitivizes a verb. And since neither nominals nor nominal-producers are predicates, nominalization in effect makes an argument-taking verb [-Pred SR]. Unlike the logical subject semantic role of a predicate, which the predicate in certain situations (i.e., when the item which produces the predicate is [+Pred SR]) must assign, the semantic role assigned by a nominal-producer is never obligatorily assigned.

7. It has been suggested in the Extended Standard Theory literature that the [-Pred SR] and [-transitive] features of English passive participles need not be explicitly associated with passive morphology. In Marantz (1981b) I demonstrate why the [-Pred SR] feature of passive participles can not follow from the use of the copula in passive sentences and why their [-transitive] feature can not follow from their "adjectival" nature.

8. Not everyone considers (25-27b) ungrammatical, but there is general agreement that (23b) is much better than these sentences.

9. Williams (1979) makes a similar argument against a promotion analysis of passivization and his article was the inspiration for the present argument. However, Williams' argument depends on allowing passivization to apply to intransitive verbs in English. As Williams points out, although

he can account for the facts surrounding the sentential complements of feel, reason, etc., he can not account for the ungrammaticality of sentences like *It was died. Also, Williams fails to provide evidence against the obligatory sentential subject extraposition analysis of sentences like (25-27c).

10. A promotion analysis of passivization could account for the behavior of the sentential complements to passive participles if it postulated a special rule of impersonal passivization in English which applies only to verbs taking sentential complements. This impersonal passive rule would "demote" from subject status the logical subject of verbs taking sentential complements but would not promote to subject the sentential complements of these verbs. A dummy it would take over the subject position in such impersonal passives. Since, on an impersonal passive analysis, the sentential complements in (34a&b) and (35a&b) would be subjects at no stage in the derivation of these sentences, such an analysis would make the proper distinction between these sentential complements and extraposed subjects. Although someone could make a promotion analysis of passivization consistent with the data presented in this section if he assumed that a rule of impersonal passivization applies to a limited set of verb in English and attributed special features to verbs like feel, he would make the promotion analysis consistent with the data at great cost in ad hoc stipulations.

11. Actually, in Chapter Two I only proved that logical subjects must correspond to grammatical subjects when certain types of mergers of 1-s constituents at s structure do not occur. I will not argue here that adversity passives do not involve the sorts of merger which render the

proofs of Chapter Two invalid but will assume this without further comment.

12. In Chapter Four I will review Ostler's (1979) demonstration that Sanskrit data falsify the LAEX within Relational Grammar. Although Ostler's data do necessitate major changes in Relational Grammar, given one simple assumption about Sanskrit, they are consistent with the principles of the present theory which account for the data associated with the LAEX. That is, Ostler's argument works only against the LAEX within Relational Grammar and not against any conceivable explanation of the data the LAEX predicts.

13. It is not the door ('by') phrase in (60b&d) which renders the sentences ungrammatical. Impersonal passives of unaccusative verbs are ungrammatical without door phrases.

14. Some sentences containing the passive participles of unaccusative verbs might look grammatical because such passive participles are often homophonous with passive participles of related transitive verbs. The grammatical readings of such sentences would implicate the passive participles of the transitive verbs, not of the homophonous unaccusatives. In English we have transitive wilt in, The sun wilted the flowers, and unaccusative wilt in, The flowers wilted. The passive participle, wilted, in, The flowers were wilted, is formed from the transitive root. We know that the passive sentence contains the logically transitive verb because it implies an agent -- someone or something wilted the flowers. The unaccusative verb has no agentive implications (see section 3.2.2.1 below).

15. Postal (1977) reports examples of what he calls "antipassivization" in a variety of languages. However, most of the constructions Postal discusses turn out to be examples of what I call "indefinite object deletion"

in 3.2.2.2 below. See the introduction to section 3.2 below for a discussion of the differences between the class of constructions containing what I call antipassives and the class of constructions containing what I call "indefinite object deletions." Most of the constructions Postal describes in his paper share the characteristic features of constructions in the latter class.

16. Like the passive affix in a language which exhibits impersonal passives (see 3.1.1.2 above), the reflexive affix could just carry the feature [-Pred SR]. The implication in (41) above would provide the [-Pred SR] reflexive verb with the feature [-transitive]. I do not know of any evidence which indicates whether or not the reflexive affix should carry the [-transitive] feature.

17. When its subject is plural, the Albanian reflexive verb may have a reciprocal interpretation. This reciprocal reading is possible for the reflexive verbs in many languages.

18. In addition to the fact that the reflexive verb form in the Romance languages often has a passive reading, the syntax of reflexive constructions shares many features with the syntax of passive constructions containing passive verb forms not homophonous with the reflexive -- see, e.g., Burzio (1981).

19. Lexical reflexivization, however, does involve adding to a verb's lexical entry a quasi-independent feature bundle containing the argument structure and semantic role assigning properties of English by.

20. This prediction holds only for nominative-accusative languages; see section 3.3.2 below for a discussion of dative shift in ergative

languages.

21. Dutch (Zaenan, personal communication) and Korean (Shibatani 1977) present potential counterexamples to the predictions of the theory concerning double object constructions. Dutch speakers disagree about the crucial data, however, and I have been unable to track down enough Korean data to say anything about that language. Shibatani (1977) provides just enough Korean examples in a discussion of Japanese to make it clear that a potential problem exists for the present theory.

22. Double object constructions in Swahili proper exhibit the same behavior as that described above for Chi-Mwiini double object constructions (see, e.g., Ashton 1944).

23. Jane Simpson informs me that double object constructions in the closest neighboring languages to Yindjibarndi also exhibit the behavior described above for double object constructions in Yindjibarndi.

24. Alternatively, (101) and (102) may be seen as two "branches" in a single lexical entry for give, (114) and (115) as two branches in a single lexical entry for bake. See section 3.2.2 below for a description of "branching" lexical entries.

25. Burzio (1981) argues explicitly that English anticausatives are "unaccusative" in the sense of section 2.2 above.

26. Other analyses of the indefinite object deletion alternation illustrated in (144) are conceivable. However, if it is to account for the connection between the eat's in (144a) and (144b), the grammar must prevent the eat in (144b) from assigning the patient role that eat assigns in (144a), allow eat not to assign the patient role in (144b), or "bind"

eat's patient argument in (144b) to some non-overt indefinite NP. Regardless of which of these analyses one chooses to pursue, no percolation of features from an affix attached to the eat in (144a) could create a derived verb with the properties necessary to serve as the eat in (144b).

27. Of course, the antipassive affixes discussed in 3.1.2 above may have the effect of allowing logically transitive verbs to appear without overt logical objects. However, in all cases of true antipassivization, the logical object of a verb may appear overtly with the verb's antipassive form -- the antipassive affix does not indicate the absence of the logical object from the sentence.

28. On "ergativity" see Dixon (1979b), Comrie (1973), and the papers and references in Plank (1979). For a discussion of Dyirbal's ergativity, see Dixon (1979a), Heath (1979), Mel'čuk (1979), Schmerling (1979), and the references cited in these sources.

29. As Dixon (1977, pp. 388-392) explains, the Yidin coordination constructions referred to here differ in many respects from the Dyirbal topic chain constructions. However, the differences are not sufficiently deep to weaken the point to be made below.

30. We must assume that comitative (COM) case assigns the theme role in (174). There is no reason to believe that the comitative case should be able to assign the theme role in Arctic, but we already argued above that it was a failing of the nominative-accusative analysis of Arctic dative shift constructions that it could not predict the case marking on the theme argument.

31. Relational Grammar would have no natural way of ruling out (174) on a nominative-accusative analysis of Arctic. Dative shift in Relational Grammar is analyzed as indirect to direct object advancement. Antipassivization (see Postal 1977) is the demotion of a subject to object, which puts the current object "en chômage," then the subsequent advancement of the demoted subject back to subject. Since data from the Bantu languages precludes the postulation of a "2 Advancement Exclusiveness Law" which would block a rule which puts a derived object "en chômage" (see Perlmutter and Postal 1978a), no current laws of Relational Grammar prevent dative shift and antipassivization in the same clause. Therefore, the laws of Relational Grammar do not block (174) if Arctic is considered nominative-accusative.

32. The various sources on Greenlandic employ different orthographies. Each example sentence is reproduced in the orthography of its source.

33. The theory of this dissertation provides a straightforward analysis of alternations like those illustrated in (190). Basically, they should be treated as we treated the English benefactive alternation in 3.2.1.2 above. The lexical entries of the transitive verbs in the alternations should embed the P-A structures of their intransitive counterparts and the transitive verbs should assign a directional role. For example, the P-A structure of transitive Tikippaá 'he has come to it' in (190a) should look like (ia); the P-A structure of its intransitive counterpart Tikippuq 'he has come' in (190b) should look like (ib).

(i) a. ('come' (\emptyset) 'to' (direction)) b. 'come' (\emptyset)

34. I only proved that the correspondences listed in Table (69) of Chapter Two hold in the absence of certain types of merger of constituents

between l-s and s structure. By following the line of reasoning used in the proofs of section 2.4.2, the reader may verify that the correspondences of Table (69) hold in the context of most sorts of merger as well.

35. Except in certain cases when the NP which depends on the applied affix bears the instrumental role.

36. The applied verb constructions in Fula, a Niger-Congo language described in Sylla (1979) behave essentially as do the Chi-Mwi:ni applied verb constructions just discussed. An exception is the Fula instrumental applied verb, to be discussed in 3.4.1.2 below.

37. Note that VP'_1 and PP'_2 in (250) are the proper s structure counterparts of VP_1 and PP_1 in (247) according to our principles. Since the merger of V_1 and P_1 expresses the l-s relation between daughters of VP_1 in (247), principle (204) tells us that VP'_1 should be a phrase immediately headed by the combination of P_1 and V_1 , i.e., V_2 . The s structure counterpart of the immediate head of PP_2 in (247) is the s structure counterpart of VP_{2-inst} , which we determined to be V_1 . So definition (196) says that PP'_2 should be a phrase immediately headed by V_1 .

38. The passivization data in (288) provide additional support for the proposed bi-clausal s structure of Japanese causatives. The surface structures of (288a) and (283a), a causative containing a transitive lower verb, are structurally identical; each contains a verb, a subject, an o marked argument, and a ni marked argument. Yet only the o marked argument of (288a), not that of (283a), may passivize. The bi-clausal analysis of (283a) yields a straightforward explanation of the facts.

39. A further difficulty for the present analysis of Japanese causatives is the fact that although the active causative verb has both coercive and permissive readings, as shown in (281), the passive of a causative has only the coercive reading. I discuss this problem at some length in Marantz (1981a) and will not repeat the proposed solution here.

40. The reader might wonder why NP_2' bearing the syntactic role assigned to it by V_2 in (300) serves as argument to V_3 . NP_2 is the logical subject of VP_2 in (297b). Recall that the logical subject relation is not a basic 1-s relation. Rather, the logical subject of predicate P was defined as the constituent which is assigned its semantic role by P and which serves as "argument" to P in the broad sense of argument. Given that Malayalam allows verbs to assign only one role in the unmarked case, we stated that V_2 in (299) was prohibited from percolating to V_3 any semantic role assigning features it might inherit from VP_2 by the principle that morphemes percolate inherent over inherited features. However, because V_3 is not limited to one argument, V_2 would percolate to V_3 argument-taking features it inherited from VP_2 . We must split the $\text{sub}(VP_2, NP_2)$ relation into its basic parts, the semantic role assigner-semantic role assignee basic relation and the argument-taking item-argument basic relation. With respect to the former relation, V_2 is the s structure counterpart of VP_2 , as explained in the text. With respect to the latter, since V_2 would percolate to V_3 any argument-taking properties it inherited from VP_2 , V_3 is the s structure counterpart of VP_2 . So both V_2 and V_3 must head-Govern the s structure counterpart of NP_2 , NP_2' . We saw above that this requirement could be met only if NP_2' was an OBJ in an argument phrase headed by V_2 and serving as argument to V_3 . The required argument phrase is the PP in (300).

41. Malayalam passives use the instrumental case as by is used in English passives, but this instrumental case is distinct from the instrumental postposition which marks the causee in a causative construction with a transitive root verb.

CHAPTER FOUR: THEORIES OF GRAMMATICAL RELATIONS

4.0. Introduction. In the first three chapters of this dissertation I presented and explored a theory of grammatical relations, i.e., a theory of the mapping between semantic interdependencies among sentential constituents and the expression of these interdependencies in surface structure. I avoided above explicit comparison of the present theory with other theories of grammatical relations; rather, I concentrated on demonstrating how the present theory makes a wide range of interesting and correct predictions about a variety of constructions in the world's languages. In this chapter I examine the present work in the context of previous investigations of grammatical relations.

The chapter is divided into two parts. In the first I discuss some similarities and differences between the present theory and the theories to which it is most closely allied -- the Government-Binding (GB) theory of Chomsky (1981) and the Lexical-Functional (L-F) theory of Bresnan (1981a). Since a theory of grammatical relations is only a chunk of a theory of grammar, the present theory must be incorporated into a broader grammatical framework. The comparison of the present theory to the GB and L-F frameworks should facilitate the assimilation of my work into one of these farther ranging theories of grammar. In the second part of the chapter I contrast the general approach to grammatical relations taken in this dissertation with other approaches exemplified in the literature. In particular, I characterize approaches to grammatical relations according to the source they propose for grammatical relations and according to the

manner in which they account for generalizations that seem true of grammatical relations. The present theory locates the source of grammatical relations in logico-semantic interdependencies. Its approach to phenomena which implicate grammatical relations may be characterized as "explanatory" in that generalizations true of grammatical relations are shown to follow from fundamental principles of grammar and from inherent properties of grammatical relations. Most current theories of grammatical relations locate their source in semantic roles, not semantic interdependencies (relations) and are "non-explanatory" in that they account for generalizations true of grammatical relations by reference to laws or rules which are independent of fundamental grammatical principles and of inherent properties of grammatical relations. In discussing alternative theories of grammatical relations, I devote special attention to Relational Grammar.

4.1. The present theory of grammatical relations and broader theoretical frameworks. 4.1.1. The Government-Binding framework. Rather than a replacement for Government-Binding theory (Chomsky 1981), the theory of this dissertation may be seen as a development of the GB framework, taking off from suggestions found in Chomsky (1980b). There is nothing fundamentally incompatible between the present work and Chomsky (1981); there are, however, significant differences. These differences fall into three categories. First, I have developed areas of syntactic theory that Chomsky (1981) does not discuss at great length. For example, the account of lexical entries and argument structures developed here fills in details left open by GB theory. Second, I chose to develop one line of research in certain cases where the GB line is consistent with the data and mainly consistent with the rest of the present theory. For example, although

I sketch a treatment of PRO in section 2.6.1 different from the GB account, the treatment is not forced by fundamental assumptions of the theory, and I could adopt the GB treatment of PRO without changing, e.g., my analyses of the constructions discussed in Chapter Three. Third and most important, there are differences between the theory of this dissertation and GB theory which implicate fundamental principles of the two theories. Adopting the GB position to reconcile differences of this last sort would completely alter the present theory. These differences include the choice of principle (66) of Chapter Two and the principles of merger in 3.4 over Chomsky's (1981) "projection principle." Below, I will only discuss differences of this third, fundamental sort.

For purposes of comparing the present theory to GB theory, I will quickly sketch some basic features of the GB framework. What follows is not an introduction to GB theory; to fully comprehend the discussion in this section, the reader must consult Chomsky (1981). Consider the model of grammar in (1), suggested in Chomsky (1980b).

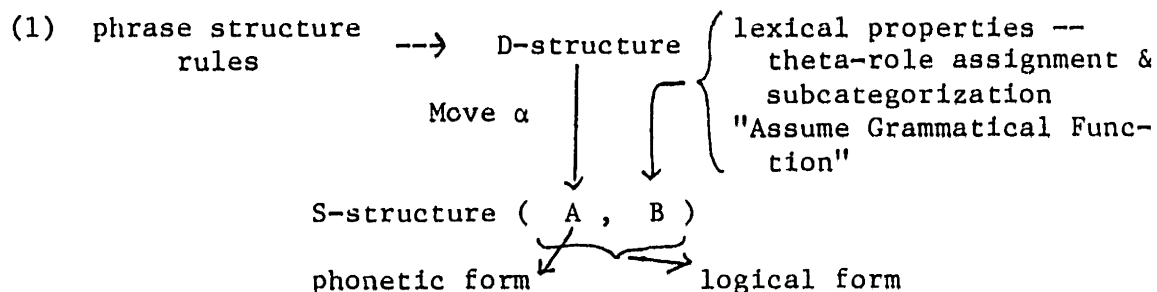

In (1) the phrase structure rules of a grammar generate D-structures into which lexical items are inserted. A general trace-leaving movement rule, Move α , generates the structure labeled "A" in (1) from D-structure. Move α in (1) may either move a constituent and (Chomsky-)adjoin it to a node or move a constituent and substitute it for a node (in "structure

preserving" movement transformations). The lexical properties of theta-role (thematic role) assignment and subcategorization determine the structure labeled "B" in (1). "Thematic" or "theta-roles" are roughly equivalent to the semantic roles of the present theory;¹ theta-role assignment is similar to semantic role assignment. A lexical item "subcategorizes" its arguments. The property of an item that it assigns a theta-role or subcategorizes a certain argument establishes a structural relation at structure B between the item and the constituent to which it assigns a role or which it subcategorizes. For example, for X to assign a role to or subcategorize Y, both X and Y must be immediately dominated by the same node Z. The "projection principle" of Chomsky (1981) states roughly that theta-role assignment and subcategorization are preserved at every syntactic level of analysis -- in our diagram the relevant levels are B and logical form. That is, the structural relations established by theta-role assignment and subcategorization are preserved in the course of a derivation. The pair consisting of structures A and B in (1) constitute "S-structure." Rules of the logical form component derive a logical form from S-structure, while rules of phonology map structure A onto a phonetic form.

Grammatical relations or "functions" are defined in GB theory in terms of structural relations at structure B. The rule "Assume Grammatical Function" in (1) allows a constituent to freely bear (assume) a structural relation (grammatical function) in structure B not dictated by theta-role assignment or subcategorization. To clarify further "Assume Grammatical Function" and to facilitate a comparison of (1) with (4) of Chapter One, we may redraw (1) as in (2).

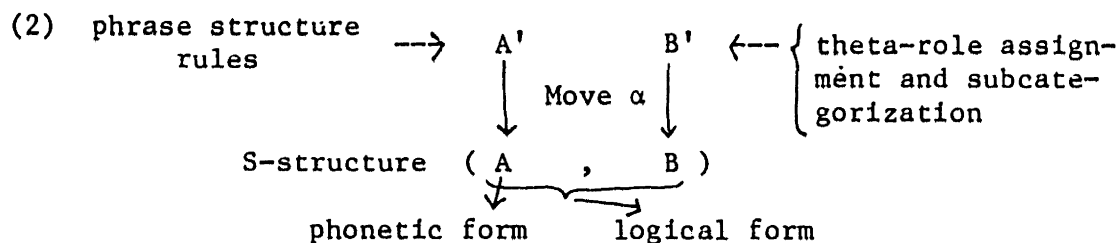

"Assume Grammatical Function" of (1) reduces to substitution Move α between B' and B in (2); that is, a constituent assumes a grammatical function by moving to occupy a new structural position. Chomsky divides language into two classes, the "configurational" and "nonconfigurational" languages.² Configurational languages are those for which the relationship between structures A and B in (2) is identity. In nonconfigurational languages, there is some more complicated relationship between structures A and B .

When Chomsky's (1980b) model of grammar is diagrammed as in (2), it becomes clear that the present theory, associated with the model of grammar in (4) of Chapter One, conforms to the general lines of GB theory. Structure A' of (1) corresponds to deep structure in (4) of Chapter One, structure A corresponds to surface structure, structure B' to l-s structure, and structure B to s structure. As B' is a projection of theta-role assignment and subcategorization, so l-s structure is a construction from the basic semantic relations, semantic role assigner - semantic role assignee and argument-taking item - argument. Chomsky defines grammatical relations as structural relations at structure B ; I encode grammatical relations in structural relations at s structure.

Despite these strong correspondences between the GB framework and the present theory, certain differences in fundamental assumptions clearly distinguish the two. First, Chomsky assumes that Move α is crucially involved in raising to subject and in the "promotion" of objects to subject

in passivization. That is, GB theory claims that there is a relationship between a (moved) constituent and a structural position (the source of the moved constituent) in passive and raising constructions which shares some feature(s) with the relationship between a constituent and structural position in, e.g., wh- questions and relative clauses. The assumed similarity between these two sorts of constructions is captured by having the relationship between constituent and structural position in both cases established by Move α . In the present theory, no direct connection is claimed to exist between passive and raising constructions on the one hand and constructions, like wh- questions, generated by adjunction Move α within the theory. The specification of "head-Government" in place of "Government" in principle (66) of Chapter Two allows for the "promotion" of logical objects to subject in passivization, while raising involves a special sort of anaphor, the β -trace (see section 2.6).³

Although passive and raising constructions are generated with the "same" Move α rule used to generate wh- questions and relative clauses in the GB framework, Move α in passivization and raising is a substitution rule while other examples of Move α , e.g., Move α in constituent questions, adjoins the moved constituent to a node. Furthermore, substitution Move α leaves a trace which is identified as an anaphor with respect to the binding theory (see section 2.6.1 above). In contrast, adjunction Move α generally leaves a trace which is subject to the same clause of the binding theory as non-pronominal lexically filled NPs, clause iii of (102), Chapter Two; i.e., traces of adjunction Move α must be "free." In short, although the GB framework establishes a similarity between passive and raising constructions and constructions like wh- questions, it also allows these constructions to differ

in many important features. One feature the constructions must share by virtue of being generated through Move α is that the connection between the moved constituent and its trace, that are assumed present in the constructions, must obey the "subjacency" condition on Move α . The subjacency condition insures a specific structural proximity between moved constituent and trace, keeping them "close" in a well-defined sense. As demonstrated in Marantz (1981b), however, the subjacency condition never plays a demonstrable role in constraining the relationship between a moved constituent and a trace in passive and raising constructions because this relationship is more highly constrained by the binding theory.⁴

In terms of mechanical details, the GB treatment of raising and of promotion in passivization differs markedly from the treatment of this dissertation. However, it is not clear that there are serious discrepancies between the treatments at a deep level.

A second major difference between GB and the present theory involves the GB "case filter" (see Chomsky 1980a, 1981). Basically, the case filter demands that an NP with phonological content bear "case" if it appears in surface structure. In general, an NP may be assigned case if it is "governed" (in a structural sense which Chomsky makes clear) by a lexical category -- either a V, a P, or an agreement element. Much of the work of the GB case filter is accomplished in the present theory by principle (98) of Chapter Two, which states roughly that a constituent which is not an operator or the head of a phrase will appear in surface structure only if it is Governed by a lexical item (or a structural position). Both the GB case filter and principle (98) insure that an NP with phonological content will bear a grammatical relation with respect to a lexical item in many situations. But

the case filter and principle (98) are clearly not equivalent, and they play distinct roles in their respective theories. For example, the GB case filter is instrumental in forcing the "promotion" of NP logical objects to subject in English passive constructions, while principle (98) was exploited in the present theory to account for the distribution of PRO.

Another important discrepancy between the GB framework and the present theory lies in the connection the theories assume to exist between relational structure (structure B in (2) and s structure in (4) of Chapter One) and surface constituent structure (structure A in (2) and surface structure in (4) of Chapter One). Chomsky assumes that the relationship between the structures A and B in (2) is identity in "configurational" languages like English. To my knowledge, the GB framework says nothing explicit about the relationship between structures A and B in nonconfigurational languages. In the present theory, because s and surface structures are fundamentally different sorts of representation, it makes no sense to claim that s structure is identical to surface structure in any situation. An s structure is a representation of the grammatical inter-relationships among constituents, while the surface constituent structure encodes linear order and constituent structure dominance relations directly relevant to phonological interpretation. The principles described in sections 2.5 and 2.6 which govern the connection between s and surface structure, e.g., (81) and (98), are intended to apply to all languages whether configurational or nonconfigurational in Chomsky's terms. It was suggested in 2.5.1 that configurational languages express Government, as defined in (64) of Chapter Two, directly in "structural government" at surface structure, as defined in (85) of Chapter Two (see (86), section 2.5.1).

Although the differences between the GB framework and the present theory discussed in the above paragraphs do implicate fundamental principles of the theories and may have empirical consequences, I am unaware of any data which strongly support either position on these issues. The last difference to be discussed here does point to a failing in the GB framework, however. Recall that the connection between structures B' and B in (2) is constrained by the projection principle, which insists that the structural relations established by thematic role assignment and subcategorization at B' are preserved at B. In contrast, I assume that the connection between l-s and s structures, which correspond roughly to B' and B respectively, is governed by principle (66) of Chapter Two and by the principles of merger given in 3.4. As a consequence, the present theory is able to predict the syntax of applied verb constructions (3.4.1) and derived causative constructions (3.4.2) calling upon the same general principles which govern the derivation of any sentence. For the GB framework, constructions I would analyze as involving merger of independent l-s constituents between l-s and s structure present a major problem. If the principles of the GB framework are interpreted in a straightforward manner, these constructions violate the projection principle. If the constructions are analyzed in such a manner as to preserve the projection principle, the GB framework offers no explanation of the syntax of these constructions comparable to the explanation provided by the present theory.

As an example of the problems merger constructions present for the GB framework, consider the Malayalam causative construction discussed in 3.4.2.3 above. Examining the semantic role assigning properties of the morphemes in the Malayalam sentence (3), I proposed the l-s structure for (3) shown in (4).

- (3) acchan kuṭṭiye kārāyiccu.
 father-NOM child-ACC cry-CAUSE-PAST
 'Father made the child cry.'

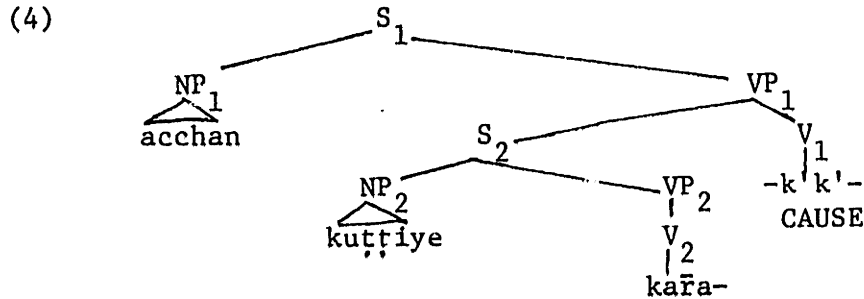

Since B' in (2) is a projection of thematic role assignment and subcategorization, which correspond to semantic role assignment and argument structures, the GB structure B' for (3) should look like (4) too. I argued in 3.4.2.3 that the correct s structure for (3) is (5), where X' stands for the s structure counterpart of X.

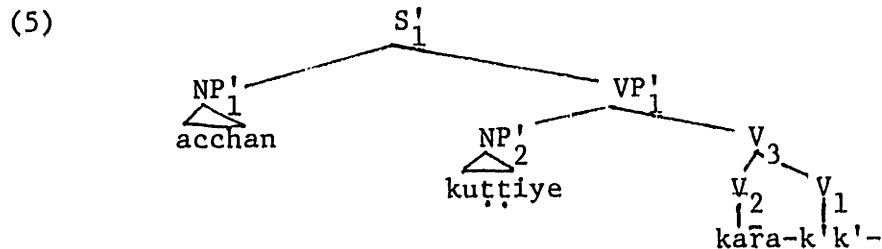

Using the same data presented in 3.4.2.3, one could argue that (5) is the proper GB structure B (see (2)) for (3) as well. However, the relationship between (4) and (5) violates the projection principle. Technically, the structural relation between NP₂ and VP₂ in (4), which is established because VP₂ assigns a theta role to NP₂, is not preserved in (5). Also, while NP₂ is not subcategorized in (4) in the technical sense, it is subcategorized by V₃ in (5).

To preserve the projection principle in merger constructions, one could claim that the l-s structures postulated in Chapter Three for such constructions are not appropriate GB B' structures. Rather, the B' structure for

a sentence like (3) should look like (5). If the correct structure B' for (3) is structurally isomorphic to (5), the analysis of (3) would not violate the projection principle. However, if GB theory proposed (5) as the B' structure for (3), some additional account would need to be given for how V_3 acquires the thematic role assigning and subcategorization properties reflected in (5). Also, postulating (5) as the B' structure for (3) would seriously endanger the explanatory force of the projection principle. The projection principle says that the lexical properties of theta-role assignment and subcategorization are structurally encoded in a specified manner at every syntactic level of analysis. However, if (5) were a syntactic structure for (3), the lexical properties of the Malayalam causative affix -k'k'-, i.e., that it takes a sentential argument and assigns a theta-role to this argument, would not be structurally represented at some syntactic level. If lexical properties of some items are not subject to the projection principle, how do we determine to which properties the principle applies?

Of course, another approach to merger constructions like (3) within the GB framework would be to modify the projection principle to accord with principle (66), Chapter Two, and the principles of merger found in the present theory. These principles of the present theory share the basic insight of the projection principle, but capture this insight in a formally different manner.

4.1.2. The Lexical-Functional framework. The theory of this dissertation differs too greatly from Bresnan's (1981a) Lexical-Functional grammar to invite close comparison of details. In this section I will lay out some of the major correspondences and differences between general features of the L-F framework and of the present theory. The following discussion should

aid anyone trying to incorporate the advances of this dissertation into the L-F framework. As with the discussion of the GB framework, what is provided here can not serve as an introduction to the L-F system. An understanding of the L-F framework is a prerequisite to the discussion.

Consider the model of grammar proposed by L-F theory, which is diagrammed in (6).

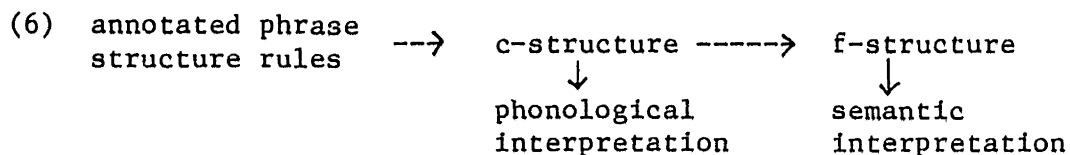

The annotated phrase structure rules of a grammar produce constituent structure trees called "c-structures." The annotations on the phrase structure rules plus information contained in the lexical entries of items inserted into c-structures determine the mapping between c-structure and "f-structure" ("functional structure"). The f-structure serves basically the same function in L-F theory as s structure serves in the theory of this dissertation. Although Bresnan does not represent f-structures as constituent structure trees, there is no principled reason why she could not do so.

Because the phrase structure rule of L-F theory generate in place what I have been considering "traces" of adjunction Move α and constituents moved by Move α , the c-structure of (6) collapses the deep and surface structures of the present theory. There is no level of analysis in the L-F framework even roughly equivalent to the l-s structure of the present theory. One may read from f-structure which constituents serve as arguments for which argument-taking items, however. Much of the machinery of the L-F theory is devoted to handling the mapping between c- and f-structure, i.e., the mapping between constituent structure and relational structure.

As pointed out above, this is an area of syntax left largely unexplored in the GB framework, at least for "nonconfigurational languages."

Perhaps the most important difference between the present theory and the L-F framework lies in the treatment of alternations in the expression of a verb's semantic dependents (see Chapter Three). In the L-F framework, the connection between argument positions in predicates and grammatical relations is stipulated within the lexical entry of each argument-taking word. For example, (7) displays the "predicate-argument structure" for give in the L-F theory (where "TO OBJ" stands for the OBJ in a PP headed by to).

(7) 'give' ((SUB), (OBJ), (TO OBJ))
 agent theme goal

Alternations in the expression of a verb's semantic dependents are accounted for by lexical rules, which apply to lexical entries of verbs and change the stipulated correspondences between argument positions and grammatical relations. Applying the "passive" lexical rule to (7), for example, would yield the entry in (8).

(8) 'give' ((BY OBJ), (SUB), (TO OBJ))
 agent theme goal

In the present theory, we account for most alternations in the expression of a verb's semantic dependents through the interaction of principles of morphology and the general principles governing the mapping between l-s and surface structures (see Chapter Three).

To incorporate the present theory into the L-F framework would require some major modifications in L-F theory. For example, the connection between semantic roles and grammatical relations stipulated in the L-F lexical entries would have to be mediated by something corresponding to the l-s structures of the present theory. Also, L-F theory would have to encode the asymmetry

between the logical subject and a verb's arguments in argument structures like that in (7) and represent the asymmetry between the SUB and the syntactic arguments of a verb in f-structure.

I should warn that the differences between the present theory and the L-F framework block easy comparisons of apparently similar features in the two theories. For example, it might seem that my contention that a verb may take two OBJs contradicts the L-F "functional uniqueness principle," which limits clauses to one example of each grammatical relation (function). However, because "OBJ" does not mean the same thing in the two theories, it is not clear that there is any real contradiction here. Only after an attempt is made to integrate the present theory into the L-F framework will significant incompatibilities of any but a general sort become evident.

4.2. Alternative theories of grammatical relations. In comparing theories of grammatical relations, I will characterize them according to the source they attribute to grammatical relations and according to the approach they take toward accounting for syntactic phenomena which seem to implicate grammatical relations. The theory of this dissertation locates the source of grammatical relations in logico-semantic relations, as explained in Chapters One and Two. The theory is "explanatory" in that it attempts to explain generalizations true of grammatical relations by appealing to fundamental syntactic principles and to the inherent properties of grammatical relations. For example, the fact that grammatical subjects but not objects are "controlled" in control constructions like those described in section 2.6 follows in the present theory from the interaction of principle (98) of that section with inherent properties of subjects and objects. Principle (98) implies that a constituent bearing a grammatical

relation with respect to a phrase will not appear in surface structure by virtue of bearing this relation. By the definition of these grammatical relations, subjects bear a grammatical relation with respect to a phrase while objects bear a grammatical relation with respect to a lexical item (or structural position). In section 2.6.1 I demonstrated how principle (98) and these properties of subjects and objects allow PRO to occur as a subject but not as an object. Since PRO is what is controlled in control constructions, it follows that subjects but not objects may be controlled. I will classify as "non-explanatory" theories which, in order to account for generalizations true of grammatical relations, rely on rules or laws that are independent of fundamental principles in the theories and which refer to specific grammatical relations. For example, a theory which accounts for the generalization that only subjects are controlled with a law which states that only subjects may be controlled would be classified as non-explanatory on this criterion.

I will review some theories of grammatical relations in the following pages, organizing the theories according to the source they posit for grammatical relations and classifying them as "explanatory" or "non-explanatory" according to the definitions provided above. In violation of this organizational scheme, I will reserve a few words about Relational Grammar for a special sub-section at the end of this section.

4.2.1. Grammatical relations from structural relations. Some theories define grammatical relations in terms of dominance relations in phrase structure trees. This approach to grammatical relations is usually associated with Chomsky's Aspects of the Theory of Syntax (Chomsky 1965; see pp. 70-71). Since the appearance of Aspects, a great deal of literature, particularly

in the Relational Grammar framework, has been devoted to demonstrating that there exist crosslinguistic generalizations referring to a set of grammatical relations which cannot be defined in terms of phrase structure configurations (see also Marantz 1981b). It has become clear that no universal definition of grammatical relations in terms of surface constituent structure would be adequate to capture these generalizations, where we understand surface structure to refer to the surface structure of the present theory or structure A of (2) above.

Although inadequate as construed in versions of Extended Standard Theory up to Chomsky (1980b), Chomsky's attempt to define grammatical relations structurally was generally explanatory in the sense described above. Fundamental principles of the theory were structurally based and generalizations true of grammatical relations were shown to follow from these fundamental principles. For example, the fact that subjects but not objects are controlled in control constructions was shown by Chomsky (1979) to follow from the "binding theory" (see 2.6.1 above). The binding theory defines the structural domains in which anaphors must find their antecedents and in which non-anaphors must be "free." Objects, by their definition as [NP, VP]'s, are "governed-bt" (governed with respect to the binding theory, see section 2.6.1) while subject, by their definition as [NP, S]'s, are not. Since, as Chomsky demonstrates, the binding theory implies that PRO must be un-governed-bt, and since it is PRO which is controlled in control constructions, subjects but not objects are controlled.

4.2.2. Grammatical relations from semantic roles. Semantic roles are implicitly or explicitly assumed to be the source of grammatical relations in most linguistic theories. Pedagogical grammars consistently define

grammatical relations in terms of semantic roles. Although simple semantic definitions of grammatical relations have been generally recognized as inadequate for capturing generalizations in the mapping of semantic roles onto their expressions in sentences, more sophisticated attempts have been made to formalize the intuition that there is an inherent connection between certain semantic roles and certain grammatical relations. For example, Starosta's (1978) "Lexicase" grammar in effect views grammatical relations (he calls them "semantic relations") as grammaticalizations of semantic roles. Although it is not possible to determine the grammatical relation of a particular constituent on purely semantic grounds in Starosta's system, each grammatical relational class has a semantic core. Membership in a given class may be determined on grammatical as well as semantic criteria; if a constituent behaves syntactically like a core member of a class, it may be placed in the class regardless of its semantic features. Some linguists take the position that many of the phenomena thought to implicate grammatical relations actually involve rules which refer directly to semantic roles. We may place Ostler (1979) and Carter (1976) in this category, along with the Fillmore of "The Case for Case" (1968).

Two currently popular theoretical frameworks which claim to incorporate "primitive" grammatical relations are also associated with the view that semantic roles are the "source" of grammatical relations in some sense. Pinker (1981) has suggested that children learn language with the initial assumption that agents will be subjects and patients objects. Grammatical relations are "flagged" with semantic roles in the child's innate knowledge of language. Thus semantic roles serve as the developmental source of grammatical relations in the Lexical-Functional framework. In assuming that

constituents are assigned their initial grammatical relations on the basis of a universal initial assignment of grammatical relations to semantic roles, Relational Grammar places semantic roles as the source of grammatical relations in the analysis of every sentence. Relational Grammar's many to one mapping of semantic roles onto initial grammatical relations constitutes an extremely strong connection between semantic roles and grammatical relations, a connection which, I argued in Chapter One, may be considered a definition of grammatical relations in semantic terms.

I am unaware of any serious attempts to provide an explanatory link between the semantic role source of grammatical relations and generalizations true of grammatical relations. Moreover, it is unlikely that any such link may be forged. If the agent role is somehow intimately associated with the subject relation, for example, this feature of subjects seems unlikely to enter into an explanation of why subjects but not objects are controlled in control constructions. Since semantic roles seem unconnected with syntactic properties of grammatical relations, theories which posit semantic role sources for grammatical relations are non-explanatory as defined above.

4.2.3. Grammatical relations from compositional semantics. An interesting characterization of grammatical relations within a Montague Grammar framework has been provided by Dowty (1981b). Dowty defines grammatical relations in terms of the composition of sentences and sub-sentential constituents. Roughly, a subject is what one puts together with a verb phrase ("intransitive verb" or IV in the Montague terminology) to produce a sentence. An object is what one puts together with a transitive verb to produce a verb phrase. Although Dowty's definitions of grammatical relations in one sort of compositional semantics are superficially similar to the

definitions of grammatical relations provided in the present theory, his grammatical relations are not really rooted in what I have called "logico-semantic" as are the grammatical relations of this dissertation. For example, the structural asymmetry between subject and object in Dowty's system does not mirror an asymmetry at a deeper semantic level; he assumes that transitive verbs name simple two place predicates and that the argument positions for subjects and objects in the predicates are essentially equivalent. Contrast Dowty's approach to verb semantics with the present approach in which the asymmetry between subject and object is projected from an asymmetry inherent to the predicate-argument structures of verbs.

Dowty does not attempt to explain phenomena implicating grammatical relations by reference to fundamental principles of his theory and to his definitions of grammatical relations. However, Dowty's approach seems to have explanatory potential and its implications need to be worked out.

4.2.4. Grammatical relations from clusters of properties. Keenan (1976) defines "subject" in terms of a cluster of properties subjects share crosslinguistically. It is not clear to me whether Keenan is defining a theoretical term which might appear in principles or rules of grammar or a "concept" he believes speakers of languages acquire. His methodology seems geared to the latter task. As he writes (p. 312), "on this type of definition 'subject' does not represent a single dimension of linguistic reality. It is rather a cluster concept, or as we shall say, a multifactor concept." Keenan assumes we have pretheoretical intuitions about grammatical relations (p. 306): "we are not free to define a notion like 'subject' in any way that suits our purposes. There is a large body of lore concerning the notion, and any proposed definition must at least largely

agree with the traditional, and to some extent, pretheoretical usage of the term." In defining "subject" in terms of a cluster of properties, Keenan's task is to capture the concept linguists have when they refer to "subjects."

Keenan seems to be making a fundamental error here. As Wittgenstein (1958) explains at length, just because we use some words to refer to objects, there need not be an object behind every word. That we use the word "subject" in a variety of situations does not imply that there is a definable concept "subject," even a "cluster concept," which stands behind our use of the word in each of the situations. What Keenan (1976) does in his article is recount various ways in which linguists have used the term "subject" -- an interesting exercise but of questionable importance to linguistic theory. There is a body of linguistic work which makes use of grammatical relational terms. We are free to define grammatical relations in any way that contributes to an explanatory theory of grammar, ignoring intuitions about the appropriate use of grammatical relational terms and precedents for the use of the terms in the literature. We are not free to ignore any insights or generalizations in the literature that refer to grammatical relations.

Defining grammatical relations in terms of the cluster of properties that constituents bearing them seem to share is an inherently non-explanatory approach to grammatical relations. If, in fact, a set of constituents shares a cluster of properties, the explanatory task is to account for why these properties cluster together.

4.2.5. Grammatical relations as primitives. Proponents of Relational Grammar and Lexical-Functional grammar have claimed that the grammatical relations in their theories are primitive.⁵ I made some general comments about this approach to grammatical relations in Chapter One. Here I wish

to emphasize that, like the cluster of properties view of grammatical relations discussed in the last section, the grammatical relations as primitives position is inherently non-explanatory. Nothing can follow from the nature of grammatical relations on such a position because grammatical relations lack a nature. Relational Grammar and L-F theory resort to stipulated laws referring to particular grammatical relations to account for generalizations true of their grammatical relations. For example, consider the "1 Advancement Exclusiveness Law" of Relational Grammar, which states that there may be no more than one advancement to subject ("1") within a given clause (see section 3.1.1.3). Because subjects and objects have no inherent properties in Relational Grammar, there is no way to explain the existence of a "1 Advancement Exclusiveness Law" but no "2 (Object) Advancement Exclusiveness Law" by appealing to the inherent properties of these grammatical relations. Within Relational Grammar, this asymmetry is taken as an arbitrary fact about universal grammar. To take a similar example from the L-F framework, consider how this framework accounts for the generalization that only subjects are controlled in control constructions. The machinery of L-F theory which handles control constructions (the "control equations") has only SUB, not OBJ or some other grammatical relation, in the crucial position to indicate the grammatical relation of the controller. Because SUBs and OBJs have no inherent properties in the L-F system, the theory cannot explain why OBJ does not occur in the place of SUB in the control machinery by referring to inherent properties of grammatical relations.

4.2.6. Relational Grammar. Since Relational Grammar (see the sources cited in f.n. 10 of Chapter Two) is the only theoretical framework outside the present work to treat the full range of constructions examined in

Chapter Three in a systematic manner, it deserves special comment here. Perhaps the most fundamental principle of Relational Grammar is the assumed universal initial assignment of grammatical relations to semantic roles (or "relations"), which was discussed in Chapter One and elsewhere in the dissertation (see, e.g., section 3.1.1.3). This principle allows one to identify the initial grammatical relation that a sentential constituent will bear on the basis of its semantic role in the sentence. Without this principle, it would be extremely difficult for Relational Grammar to derive predictions about particular constructions in particular languages because the theory would leave open too many possible analyses of any given construction.

We have encountered data in this dissertation which call into question the universal initial assignment of grammatical relations to semantic roles within Relational Grammar (the universal initial assignment hypothesis or "UIAH"). Recall the discussion of Sanskrit impersonal passivization in section 3.2.2.1 above. We saw in section 3.1.1.3 that the combination of the 1 Advancement Exclusiveness Law (1AEX) and the UIAH, taken with the Relational Grammar analysis of impersonal passivization, predicts that intransitive verbs whose sole argument bears a theme or patient role ("unaccusative verbs") may not undergo impersonal passivization. By the UIAH, the sole argument of such intransitive verbs is an initial object, which is promoted to subject. Since impersonal passivization of such verbs would involve the subsequent promotion of a dummy object to subject on the Relational Grammar analysis, resulting in two advancements to subject in a single clause, the 1AEX rules out impersonal passivization with unaccusative verbs. However, Ostler (1979) showed that unaccusative verbs in Sanskrit do undergo impersonal passivization

(see section 3.1.1.3 above). Therefore, it seems that either the LAEX or the UIAH is wrong as currently stated in Relational Grammar. But, as Ostler also demonstrates (see section 3.1.1.3), passive clauses in Sanskrit do not undergo impersonal passivization. Since Relational Grammar relies on the LAEX to prevent the impersonal passivization of passives, the Sanskrit data indicate that the LAEX must be maintained in Relational Grammar. Because Ostler's Sanskrit evidence not only demonstrates that the LAEX and the UIAH cannot both be maintained, but also provides support for the LAEX, we are led to conclude that Relational Grammar should drop the UIAH. That is, the sole semantic dependent of a Sanskrit verb which bears the theme or patient role should be allowed to bear the initial subject relation in violation of the UIAH, which would assign the initial object relation to such an argument.

The data in section 3.3 on ergativity also present a serious challenge to the UIAH. The initial grammatical relations of Relational Grammar correspond roughly to the l-s relations of the present theory -- at least the initial subject and object relations correspond to the logical subject and object (of a verb) relations. It was only on the assumption that agent and theme or patient arguments canonically bear different l-s relations in nominative-accusative languages from those they bear in ergative languages that the present theory was able to explain the differences between nominative-accusative and ergative languages described in section 3.3. It is unclear how Relational Grammar could characterize the demonstrable differences between nominative-accusative and ergative languages without allowing the ergative languages to violate the UIAH. If the conclusions of section 3.3 are correct, the association of semantic roles and initial grammatical relations should be allowed to differ from language to language.

Without the UIAH, Relational Grammar consists mainly of a series of universal laws concerning grammatical relations, none of which seem fundamental to the theory. The laws amount to generalizations over the behavior of various constructions in some number of languages. For example, Relational Grammar accounts for the syntax of the derived causative constructions discussed in 3.4.2 above by stipulating what happens to the grammatical dependents of the causative affix and root verb under "clause union," i.e., the union into a single sentence of the clause headed by the causative morpheme and the clause headed by the lower verb (see 3.4.2 for an explanation of the vocabulary used in discussing derived causative constructions). The Relational Grammar laws of clause union "predict" the syntax of Comrie's paradigm case causative constructions by, in effect, stipulating the correspondences listed in (266) of Chapter Three. As shown in 3.4.2.2 above, there is a type of derived causative which does not conform to Comrie's paradigm case, namely causative constructions in which the causative affix and root verb remain separate at s structure. Because the stated effects of clause union in Relational Grammar, like most universals in the theory, are independent of fundamental principles, the existence of these derived causative constructions does not undermine the theory of Relational Grammar. To account for this alternate type of derived causative construction, Relational Grammar could simply add another option to the clause union laws. Languages like Turkish would choose one option in these laws while languages like Japanese would choose the other (see section 3.4.2). Or Relational Grammar might claim that no clause union takes place in the second, Japanese sort of derived causative. Because Relational Grammar included no general principles determining the interaction of morphology and syntax, the fact

that the causative verb appears as an affix on the lower verb of a causative construction holds no particular importance for the analysis of causative constructions in Relational Grammar. That is, the affix status of the causative verb need not imply clause union in the theory.

In contrast to the Relational Grammar analysis of derived causative constructions, the present theory predicts the syntax of these constructions from fundamental principles of the grammar. That a causative affix appears on the lower verb as an affix in a causative construction implies that it must merge with the lower verb between l-s and surface structure, either between l-s and s structure or between s and surface structure. General principles, like principle (66) of Chapter Two, determine the consequences of merger at each location for the syntax of the causative constructions. Empirical discoveries could force changes in principles like principle (66), but, because it applies in the analysis of every sentence, any change in this principle would have far-reaching consequences throughout the grammar. The principles of the present theory have a tight interdependency and wide range of application not characteristic of the laws and rules of Relational Grammar.

FOOTNOTES

1. Within the GB framework, there is assumed to be some small set of thematic roles which constituents may assign. If an item assigns a theta-role, the role must belong to this set. Moreover, if two items assign, say, the theme role, they assign the same theme role. In contrast, it is assumed in the present theory that the set of semantic roles may be quite large (see section 2.2). There are linguistically significant classes of semantic roles which correspond roughly to the thematic roles of the GB theory. However, an item may assign a semantic role which belongs to none of these linguistically significant classes. Also, if two items assign a "theme" role, where "theme" names a semantic role class, the items may be assigning different theme roles. See section 2.2 for a discussion of semantic roles within the present theory.
2. These should not be considered mutually exclusive categories. Languages are configurational to the extent that their A structures are isomorphic to the corresponding B structures.
3. Since I have assumed that the β -trace, like the " α -trace" left by adjunction Move α , is subject to Chomsky's "Empty Category Principle," I have in fact postulated a connection between raising constructions and constructions generated by adjunction Move α .
4. There is only one feature one can demonstrate that passive and raising constructions share with constructions like wh- questions within the GB theory that is captured by assuming Move α is involved in the derivation of both sorts of constructions: The traces in all the constructions

must be "properly governed" as demanded by Chomsky's (1981) "Empty Category Principle" (ECP). See Chomsky (1981) for evidence that raising and adjunction Move α constructions are governed by the ECP. As explained in f.n. 3 above, the present theory also assumes that the trace of raising constructions (the β -trace), like the trace of adjunction Move α (the α -trace), is subject to the ECP.'

5. In Chapter One, I questioned whether the grammatical relations of Relational Grammar are actually primitives within that theory.

BIBLIOGRAPHY

- Abasheikh, M.I. 1979. The Grammar of Chimwi:ni Causatives. University of Illinois PhD diss., 1978. Available from University Microfilms, 1979.
- Abraham, W., ed. 1978. Valence, Semantic Case and Grammatical Relations. Amsterdam: John Benjamins B.V.
- Aissen, J. 1974. "Verb Raising." Linguistic Inquiry, 3.325-366.
- Andrews, A. 1981. "The Representation of Case in Modern Icelandic." In Bresnan (1981a).
- Aronoff, M. 1976. Word Formation in Generative Grammar. Linguistic Inquiry Monograph Series No. 1, Cambridge: MIT Press.
- Ashton, E.O. 1944. Swahili Grammar. London.
- Baker, C.L. 1979. "Syntactic Theory and the Projection Problem." Linguistic Inquiry, 10.533-581.
- Borer, H. 1980. "Empty Subjects in Modern Hebrew and Constraints on Thematic Relations." In Jensen (1980), pp. 25-37.
- Bresnan, J. 1980. "Polyadicity." In T. Hoekstra et al., eds., Lexical Grammar, Dordrecht: Foris Publications.
- _____, ed. 1981a. The Mental Representation of Grammatical Relations. Cambridge: MIT Press.
- _____. 1981b. "The Passive in Lexical Theory." In Bresnan (1981a). Also, MIT Center for Cognitive Science Occasional Paper #7.
- Burzio, L. 1981. Intransitive Verbs and Italian Auxiliaries. Unpublished MIT PhD diss.
- Carter, R. 1976. "Some Linking Regularities." Unpublished ms.
- Chomsky, N. 1965. Aspects of the Theory of Syntax. Cambridge: MIT Press.
- _____, 1979. "On Markedness and Core Grammar." Paper presented at the 1979 GLOW Colloquium, Scuola Normale Superiore, Pisa, Italy.
- _____. 1980a. "On Binding." Linguistic Inquiry, 11.1-46.
- _____. 1980b. "On the Representation of Form and Function." Paper presented at CNRS Conference, Royaumont, France, June 1980. To appear in Linguistic Review.

- Chomsky, N. 1981. Lectures on Government and Binding. Dordrecht: Foris Publications.
- Chung, S. 1976. "An Object-Creating Rule in Bahasa Indonesia." Linguistic Inquiry, 7.1-37.
- Cole, P. and Hermon, G. 1981. "Subjecthood and Islandhood: Evidence from Quechua." Linguistic Inquiry, 12.1-30.
- Cole, P. and Sadock, J.M., eds. 1977. Syntax and Semantics Volume 8: Grammatical Relations. New York: Academic Press.
- Comrie, B. 1973. "The Ergative: Variations on a Theme." Lingua, 32. 239-253.
- _____. 1976. "The Syntax of Causative Constructions: Cross-Language Similarities and Divergences." In Shibatani (1976a), pp. 261-312.
- _____. 1977. "In Defense of Spontaneous Demotion: The Impersonal Passive." In Cole and Sadock (1977), pp. 47-58.
- Cook, W.A. 1979. Case Grammar: Development of the Matrix Model (1970-1978). Washington D.C.: Georgetown University Press.
- DeLancey, S. 1980. "An Interpretation of Split Ergativity and Related Patterns." Available from IULC.
- Dixon, R.M.W. 1972. The Dyirbal Language of North Queensland. Cambridge: Cambridge University Press.
- _____. 1977. A Grammar of Yidin. Cambridge: Cambridge University Press.
- _____. 1979a. "Corrections and Comments Concerning Heath's 'Is Dyirbal Ergative?'" Linguistics, 17.1003-1015.
- _____. 1979b. "Ergativity." Language, 55.59-138.
- Donaldson, T. 1980. Ngiyambaa. Cambridge: Cambridge University Press.
- Dowty, D. 1981a. "Quantification and the Lexicon: A Reply to Fodor and Fodor (1980)." In T. Hoekstra et al., eds., The Scope of Lexical Rules, Dordrecht: Foris Publications.
- _____. 1981b. "Grammatical Relations and Montague Grammar." In Jacobson and Pullum (1981).
- Farmer, A. 1980. On the Interaction of Morphology and Syntax. Unpublished MIT PhD diss.

- Fillmore, C.J. 1968. "The Case for Case." In E. Bach and R. Harms, eds., Universals in Linguistic Theory, New York: Holt, Rinehart and Winston.
- _____. 1977. "The Case for Case Reopened." In Cole and Sadock (1977), pp. 59-81.
- Fodor, J.A. and Fodor, J.D. 1980. "Functional Structure, Quantifiers, and Meaning Postulates." Linguistic Inquiry, 11.759-770.
- Fodor, J.A., Fodor, J.D., and Garrett, M.F. 1975. "The Psychological Unreality of Semantic Representations." Linguistic Inquiry, 6.515-531.
- Fodor, J., Garrett, M., Walker, E., and Parker, C. 1980. "Against Definitions." Cognition, 8.263-367.
- Gary, J.O. 1977. "Implications for Universal Grammar of Object-Creating Rules in Luyia and Mashi." Studies in African Linguistics, Supplement 7, pp. 85-95.
- Grimshaw, J. 1981. "On the Lexical Representation of Romance Reflexive Clitics." In Bresnan (1981a). Also MIT Center for Cognitive Science Occasional Paper #5.
- Gruber, J. 1976. Lexical Structures in Syntax and Semantics. Linguistic Series no. 25, Amsterdam: North-Holland.
- Hale, K. 1980. "On the Position of Warlpiri in a Typology of the Base." Available from IULC.
- Heath, J. 1979. "Is Dyirbal Ergative?" Linguistics, 17.401-463.
- Hodges, K.S. 1977. "Causatives, Transitivity and Objecthood in Kimeru." Studies in African Linguistics, Supplement 7, pp. 113-125.
- Hubbard, P.L. 1979. "Albanian Neapolitan Morphology." In P.L. Hubbard and P.M. Tiersma, eds., Linguistic Notes from La Jolla, No. 6, UCSD, pp. 55-86.
- Jacobson, P. and Pullum, G., eds. 1981. On the Nature of Syntactic Representation. D. Reidel.
- Jackendoff, R. 1972. Semantic Interpretation in Generative Grammar. Cambridge: MIT Press.
- _____. 1976. "Toward an Explanatory Semantic Representation." Linguistic Inquiry, 7.89-150.
- _____. 1977. \bar{X} Syntax: A Study of Phrase Structure. Linguistic Inquiry Monograph Series No. 2., Cambridge: MIT Press.
- Jaeggli, O. 1980. "Remarks on To Contraction." Linguistic Inquiry, 11.239-245.

- Jensen, J.T., ed. 1980. Cahiers Linguistiques d'Ottawa, Vol. 9, April 1980. (Proceedings of NELS X.) University of Ottawa.
- Johnson, M.R. 1980. "Ergativity in Inuktitut (Eskimo), In Montague Grammar and in Relational Grammar." Available from IULC.
- Kayne, R. 1981. "Unambiguous Paths." In R. May and J. Koster, eds., Levels of Syntactic Representation, Dordrecht: Foris Publications.
- Keenan, E.L. 1976. "Toward a Universal Definition of 'Subject'." In C. Li, ed., Subject and Topic, New York: Academic Press.
- Kimenyi, A. 1980. A Relational Grammar of Kinyarwanda. Berkeley: University of California Press.
- Kiparsky, P. 1981. "Case, Control, and Ellipsis in Pāṇini's Grammar." Unpublished MIT ms.
- Kiparsky, P. and Staal, J.F. 1969. "Syntactic and Semantic Relations in Pāṇini." Foundations of Language, 5.83-117.
- Kisseberth, C.W. and Abasheikh, M.I. 1977. "The Object Relationship in Chi-Mwi:ni, A Bantu Language." In Cole and Sadock (1977), pp. 179-218.
- Klokeid, T. 1976. Topics in Lardil Grammar. Unpublished MIT PhD diss.
- Kuno, S. 1973. The Structure of the Japanese Language. Cambridge: MIT Press.
- _____. 1980. "A Note on Ostler's Nontransformational Analysis of Japanese Case-Marking." In Otsu and Farmer (1980), pp. 93-113.
- Levin, L. and Simpson, J. 1981. "Quirky Case and Lexical Representations." Paper presented at the Chicago Linguistics Society annual meeting, April 30, 1981.
- Lieber, R. 1980. On the Organization of the Lexicon. MIT PhD diss. available from IULC.
- _____. 1981. "Argument Linking in Compounds in English." Unpublished University of New Hampshire ms.
- Marantz, A. 1978. "Embedded Sentences Are Not Noun Phrases." In M.J. Stein, ed., Proceedings of the Eighth Annual Meeting of the North Eastern Linguistics Society, Amherst, Mass., pp. 112-122.
- _____. 1980a. "On the Acquisition of Grammatical Relations." Unpublished MIT ms.

- Marantz, A. 1980b. "English S is the Maximal Projection of V." In Jensen (1980), pp. 303-314.
- _____. 1981a. "Grammatical Relations, Lexical Rules, and Japanese Syntax." Paper presented at the Arizona Conference on Japanese Linguistics, University of Arizona, Tucson, January 1981. To appear in Coyote Papers, Vol. 2, University of Arizona.
- _____. 1981b. "Whither Move NP?" In A. Marantz and T. Stowell, eds., MIT Working Papers in Linguistics, Vol. 4.
- Martin, S.E. 1975. A Reference Grammar of Japanese. New Haven: Yale University Press.
- Mel'čuk, I.A. 1979. "The Predicate Construction in Dyirbal." In P.T. Roberge, ed., Studies in Dependency Syntax, Ann Arbor: Karoma Publishers, Inc.
- Miyagawa, S. 1980. Complex Verbs and the Lexicon. Coyote Papers, Vol. 1, Department of Linguistics, University of Arizona, Tucson.
- Mohanan, K.P. 1981a. "Assume GF and the Projection Principle." Unpublished MIT ms.
- _____. 1981b. "Grammatical Relations and Clause Structure in Malayalam." In Bresnan (1981a).
- _____. 1981c. "GB and Anaphor in Malayalam." Unpublished MIT ms.
- Nash, D. 1980. Topics in Warlpiri Grammar. Unpublished MIT PhD diss.
- Ostler, N.D.M. 1979. Case-Linking: A Theory of Case and Verb Diathesis Applied to Classical Sanskrit. MIT PhD diss. available from IULC.
- _____. 1980. "A Non-Transformational Analysis of Japanese Case-Marking and Inflexion." In Otsu and Farmer (1980), pp. 63-91.
- Otsu, Y. and Farmer, A., eds. 1980. Theoretical Issues in Japanese Linguistics, MIT Working Papers in Linguistics, Vol. 2.
- Perlmutter, D.M. 1978. "Impersonal Passives and the Unaccusative Hypothesis." In J. Jaeger et al., eds., BLS 4, pp. 157-189.
- _____. 1979. "Empirical Evidence Distinguishing Some Current Approaches to Syntax." Paper presented at the LSA annual meeting, December 1979, Boston.
- _____. 1980a. "Relational Grammar." In E.A. Moravcsik and J.R. Wirth, eds., Syntax and Semantics Vol. 13: Current Approaches to Syntax, New York: Academic Press.

- Perlmutter, D.M. 1980b. "Syntactic Representation, Syntactic Levels, and the Notion of Subject." In Jacobson and Pullum (1981).
- Perlmutter, D.M., and Postal, P.M. 1978a. "The l-Advancement Exclusiveness Law." To appear in D.M. Perlmutter, ed., Studies in Relational Grammar 2.
- _____. 1978b. "Some Proposed Laws of Basic Clause Structure." To appear in D.M. Perlmutter, ed., Studies in Relational Grammar 1.
- _____. 1980. "Impersonal Passives and Some Relational Laws." Unpublished ms.
- Pinker, S. 1981. "A Theory of the Acquisition of Lexical-Interpretive Grammars." In Bresnan (1981a). Also MIT Center for Cognitive Science Occasional Paper #6,
- Plank, F., ed. 1971. Ergativity: Towards a Theory of Grammatical Relations. New York: Academic Press.
- Poser, W. 1981. "The 'Double-O Constraint' in Japanese." Unpublished MIT ms.
- Postal, P. 1977. "Antipassive in French." Linguisticae Investigationes, I.333-374.
- Rappaport, M. 1980. "On the Derivation of Derived Nominals." Unpublished MIT ms.
- Reed, I., Miyaoka, O., et al. 1977. Yup'ik Eskimo Grammar. University of Alaska: Alaska Native Language Center and Yup'ik Language Workshop.
- Sadock, J.M. 1980. "Noun Incorporation in Greenlandic." Language, 56.300-319.
- Saksena, A. 1980. "The Affected Agent." Language, 56.812-826.
- Schmerling, S.F. 1979. "A Categorical Analysis of Dyirbal Ergativity." In C.S. Smith and S.F. Schmerling, eds., Texas Linguistic Forum, Department of Linguistics, University of Texas at Austin, Vol. 13, pp. 96-112.
- Shibatani, M., ed. 1976a. The Grammar of Causative Constructions. Syntax and Semantics Vol. 6, New York: Academic Press.
- _____. 1976b. "The Grammar of Causative Constructions: A Conspectus." In Shibatani (1976a), pp. 1-40.
- _____. ed. 1976c. Japanese Generative Grammar. Syntax and Semantics Vol. 5., New York: Academic Press.

- Shibatani, M. 1977. "Grammatical Relations and Surface Cases." Language, 53.789-809.
- Silverstein, M. 1976. "Hierarchy of Features and Ergativity." In R.M.W. Dixon, ed., Grammatical Categories in Australian Languages, Canberra: Australian Institute of Aboriginal Studies, pp. 112-172.
- Starosta, S. 1978. "The One Per Sent Solution." In Abraham (1978), pp. 459-576.
- Steele, S. 1981. "The Luiseño Absolutive, and the Other Syntactic Operators." Unpublished University of Arizona ms.
- Steele, S., Akmajian, A., et al. 1981. An Encyclopedia of Aux: A Study in Cross-Linguistic Equivalence. Cambridge: MIT Press.
- Swadesh, M. 1944. "South Greenlandic (Eskimo)." In H. Hoijer, ed., Linguistic Structures of Native America, New York: Viking Fund Publications in Anthropology, pp. 30-54.
- Sylla, Y. 1979. Grammatical Relations and Fula Syntax. UCLA PhD diss. available from University Microfilms.
- Thráinsson, H. 1980. On Complementation in Icelandic. Harvard University PhD diss., 1979. Published by Garland Press, New York, 1980.
- Trithart, M.L. 1977. Relational Grammar and Chichewa Subjectivization. Available from IULC.
- Valfells, S. 1970. "Middle Voice in Icelandic." In H. Benediktsson, ed., The Nordic Languages and Modern Linguistics, Reykjavík: Vísindafélag Íslendinga, pp. 551-571.
- Williams, E. 1979. "Passive." Unpublished University of Mass. ms.
- _____. 1980a. "Argument Structure and the Lexicon." To appear in The Linguistic Review.
- _____. 1980b. "The NP Cycle." Unpublished University of Mass. ms.
- Wittgenstein, L. 1958. Philosophical Investigations, Third Ed. New York: Macmillian Publishing Co., Inc.
- Woodbury, A.C. 1977a. "Greenlandic Eskimo, Ergativity, and Relational Grammar." In Cole and Sadock (1977), pp. 307-336.
- _____. 1977b. "The Greenlandic Verbal Suffix -ut-: Interactions of Linguistic Form and Grammatical Function." In K. Whistler et al., eds., BLS 3, Berkeley, California, pp. 251-269.

Wordick, F.J.F. .1979. The Yindjibarndi Language. Unpublished ms.,
Australian Institute of Aboriginal Studies.

Young, R.W. and Morgan, W. 1980. The Navajo Language. Albuquerque: The
University of New Mexico Press.

BIOGRAPHICAL NOTE

The author was born January 31, 1959, in Glen Cove, New York. He attended the University of Chicago Laboratory Schools and Upper Arlington High School in Columbus, Ohio, from which he graduated valedictorian in June, 1975. The author went to Oberlin College, supported in part by a National Merit Scholarship, graduating with Highest Honors in Psychology in May, 1978, as a member of Phi Beta Kappa and Sigma Xi. His graduate studies at MIT were supported by an NSF Graduate Study Fellowship. While completing his linguistic education at MIT, the author conducted psycholinguistic experiments, including a series financed by a grant in aid of research from Sigma Xi. In July of 1981 he began three years as a Junior Fellow in the Harvard University Society of Fellows.

The author's publications include:

"Embedded Sentences Are Not Noun Phrases." In M.J. Stein, ed., Proceedings of the Eighth Annual Meeting of the North Eastern Linguistics Society, Amherst, Mass., pp. 112-122.

"English S is the Maximal Projection of V." In J.T. Jensen, ed., Cahiers Linguistiques d'Ottawa, Vol. 9, 1980, pp. 303-314 (paper read at NELS X, University of Ottawa).

"Whither Move NP?" In A. Marantz and T. Stowell, eds., MIT Working Papers in Linguistics, Vol. 4, 1981, Cambridge, Mass.

"Grammatical Relations, Lexical Rules, and Japanese Syntax." Paper presented at the Arizona Conference on Japanese Linguistics, University of Arizona, Tucson, January, 1981. To appear in Coyote Papers, Vol. 2, University of Arizona.

"Re Reduplication." To appear in Linguistic Inquiry.

In addition to the conference papers listed above as publications, the author's paper, "The Ergative Parameter," was read at the fifth GLOW Colloquium in Göttingen, FDG, April, 1981. He is co-editor with T. Stowell of the MIT Working Papers in Linguistics, Vol. 4, to appear in the Fall of 1981.