

INVESTIGATION OF PHONATION USING EXCISED LARYNXES

by

Thomas Baer

S.B., S.M., Massachusetts Institute of Technology  
(1969)

E.E., Massachusetts Institute of Technology  
(1970)

SUBMITTED IN PARTIAL FULFILLMENT OF THE  
REQUIREMENTS FOR THE DEGREE OF  
DOCTOR OF PHILOSOPHY  
at the  
MASSACHUSETTS INSTITUTE OF TECHNOLOGY

February, 1975

Signature of Author . . . . . *Thomas Baer*  
Department of Electrical Engineering, February 6, 1975  
Certified by . . . . . *Kenneth H. Stevens*  
Thesis Supervisor  
Accepted by . . . . .  
Chairman, Departmental Committee on Graduate Students

## INVESTIGATION OF PHONATION USING EXCISED LARYNXES

by

Thomas Baer

Submitted to the Department of Electrical Engineering on February 6, 1975 in partial fulfillment of the requirements for the degree of Doctor of Philosophy

## ABSTRACT

Excised canine larynxes were used to study the mechanism of phonation. Apparatus and procedures were developed for producing laryngeal configuration appropriate for phonation and for supplying airflow through the glottis. Both flow-regulator and pressure-regulator air sources were used. The pseudo-subglottal tract contained a window permitting a direct view of the vocal folds from the inferior as well as the superior aspect. Particles placed on the vocal folds served as discrete visual reference points. A stereoscopic dissecting microscope was used to observe the vibrations from the superior, inferior, or oblique aspect under stroboscopic illumination. A system utilizing the microscope was developed for determining the absolute frontal-plane position of any point that could be observed on the vocal fold surfaces. This system was used with adjustable-phase synchronous stroboscopic illumination to measure the trajectories of particles in the frontal plane when the larynxes produced steady phonation. Measurements on three different particles during one run served as quantitative reference points to reconstruct the shapes of the glottis at eighth-cycle phase increments.

In addition to measurements of glottal shape during phonation, observations of gross responses to changes in subglottal pressure and tissue properties were made. Chest register and falsetto could be produced. Fundamental frequency in chest register varied at rates of 5 to 7 Hz./cm. H<sub>2</sub>O as subglottal pressure was changed. Substantial changes in fundamental frequency were produced by changes in longitudinal tension. Some aspects of the performance were sensitive to desiccation of surface tissues. The ability to produce falsetto was more dramatically impaired than the ability to produce chest voice when the tissues became desiccated.

Vibration patterns of the vocal folds in chest register were complex. Individual particles were sometimes on the superior vocal fold surfaces and on the glottal walls during different portions of a glottal cycle. The overall shape of individual particle trajectories was roughly elliptical, but the ellipses contained perturbations which sometimes formed secondary loops. Particles always traversed the ellipses



clockwise in the coordinate system with the lateral direction to the right. For particles on the superomedial parts of the folds, trajectories had large vertical and horizontal components. More lateral particles had predominately vertical trajectories and more inferior particles had predominately horizontal trajectories.

Some aspects of the vibration patterns were interpreted as travelling wave phenomena. Apparent wave velocities were determined by direct measurement and were inferred from measurements of particle trajectories at different locations along the vocal-fold surfaces. Glottal closure exhibited wavelike properties.

In addition to travelling wave vibrations on the surface membranes, measured glottal shapes suggested string vibrations of the vocal ligament. A mechanism of phonation in which aerodynamically-driven waves on the surface membranes drive vibrations of the ligament was suggested.

Particle trajectories were measured as the surface tissues of the vocal folds became desiccated. The results of these experiments and analysis of glottal shapes measured during steady phonation suggested that vertical components of forces on the vocal folds were important for phonation. These experiments showed that particle trajectories could be considered as vibrations about a static operating point.

When the vocalis muscles were removed, larynxes could produce nearly normal chest register phonation but not falsetto. This result has implications with regard to the phonatory function of the vocalis muscle.

Preliminary measurements of the static behavior of preparations for different values of subglottal pressure were made. These results and the results of dynamic measurements were used to directly test a two-mass model of the larynx with linear mechanical elements. The aerodynamic aspects of the model were found to be adequate to account for measured pressure-flow relationships. The mechanical aspects were found to be inadequate to account for some experimental results.

THESIS SUPERVISOR: Kenneth N. Stevens

TITLE: Professor of Electrical Engineering

Thomas Baer

## ACKNOWLEDGEMENTS

I am deeply grateful to Professor Kenneth N. Stevens for allowing me to join the Speech Communication Group and for supervising this thesis. Its inception and ultimate completion would not have been possible without his constant guidance, encouragement, and support.

Dr. Dennis H. Klatt and Prof. William T. Peake served as readers on my doctoral committee. Both have provided valuable advice and assistance and have offered constructive criticism about the performance and reporting of this research.

Though the members of my doctoral committee contributed much toward the virtues of this thesis, they are not responsible for its obvious remaining inadequacies.

Dr. Nelson Y.-S. Kiang, who consulted on this research only in its initial phases, is also responsible in many ways for its successful completion. I am extremely grateful for the many hours he spent trying to teach me the fundamentals of scientific research.

Mr. Donald K. North provided useful help during the construction of apparatus and in the experimental phases of the research. Ms. Hedy Kodish did an admirable job of typing the manuscript under trying conditions. The technical illustration staff of R.L.E. did an excellent job on many of the figures. I also wish to thank Shinji Maeda and Jacqueline Vaissiere for their generosity during the final stages of the ordeal.

I offer thanks to my wife, Mary Ann, for encouraging me to begin this program and allowing me to finish it. I also apologize to my wife and children, Michael and Christine, for their loss of my time, salary, and good humor.

During the course of this research, I received support from a National Institutes of Health training grant.

TABLE OF CONTENTS

	<u>PAGE</u>
ABSTRACT . . . . .	2
ACKNOWLEDGEMENTS . . . . .	4
TABLE OF CONTENT . . . . .	5
CHAPTER 1 - INTRODUCTION . . . . .	8
CHAPTER 2 - ANATOMY OF LARYNX . . . . .	15
General Plan of Laryngeal Anatomy; Cavity of the Larynx	16
Cartilages . . . . .	17
Ligaments and Membranes . . . . .	22
Joints . . . . .	25
Controlling Musculature . . . . .	30
· Intrinsic Muscles . . . . .	30
Extrinsic Muscles . . . . .	35
Nerve Supply and Sensory Anatomy . . . . .	36
Cross Section of the Vocal Folds . . . . .	37
Lower Respiratory Tract and Vocal Tract . . . . .	40
Anatomy of the Canine Larynx . . . . .	40
CHAPTER 3 - PHYSIOLOGY OF THE LARYNX . . . . .	42
Methods for Studying Laryngeal Physiology . . . . .	42
Laryngoscopy . . . . .	42
Glottography . . . . .	43
Radiography . . . . .	44
Electromyography . . . . .	45
Measurement of Glottal Airflow and Subglottal Pressure	
Experiments with Excised Larynxes and Animal	
Preparations, and Observations of Human Pathologies	48
Some Aspects of Basic Laryngeal Physiology . . . . .	49
Valvular Closure . . . . .	49
Reflex Mechanisms . . . . .	50
Growth Patterns . . . . .	51
Physiology of the Respiratory System . . . . .	51
Elastic Properties of the Vocal Ligaments . . . . .	53
Contraction Properties of Laryngeal Muscles . . . . .	55
Physiology and Mechanics of Voice Production . . . . .	58
Chest Voice . . . . .	59
Falsetto . . . . .	63
Other Registers . . . . .	63
Chest Voice and Falsetto in More Detail . . . . .	66
Laryngoscopy, Glottography, and Radiography . . . . .	66
Electromyography . . . . .	69
Airflow and Pressure Measurements . . . . .	71
Experiments with Excised Larynxes and Live Animals . . . . .	74

CHAPTER 4 - MODELS OF THE PHONATORY MECHANISM . . . . .	81
Development of the One-Mass Model . . . . .	82
Development of the Two-Mass Model . . . . .	91
Discussion: Other Models . . . . .	98
CHAPTER 5 - APPARATUS AND PROCEDURES . . . . .	102
Source of Larynx . . . . .	102
Preparation of Specimens . . . . .	103
Apparatus for Producing and Observing Phonation . . . . .	106
Subglottal System . . . . .	106
Control of Larynxes' Configuration . . . . .	113
Observation of Phonation . . . . .	114
Measurement of Particle Trajectories . . . . .	115
CHAPTER 6 - RESULTS I: GROSS PERFORMANCE OF EXCISED LARYNXES . . . . .	129
Registers . . . . .	129
Stability . . . . .	132
Variables Describing Steady State Phonation . . . . .	133
Initiating and Sustaining Phonation . . . . .	138
Regulation of Phonation . . . . .	140
CHAPTER 7 - RESULTS II: DETAILED MEASUREMENTS . . . . .	148
1A: Data from "Normal" Phonatory Larynxes . . . . .	149
Amplitudes and Directions of Vibration . . . . .	149
Particle Trajectories . . . . .	152
Trajectories of Nearby Particles . . . . .	166
Supraglottal Waves . . . . .	169
Glottal Closure . . . . .	169
Subglottal Pressure Waveform . . . . .	179
1B: Analysis and Discussion . . . . .	180
General Issues in the Interpretation of Results . . . . .	180
Interpretation of Vibrations as Surface Waves . . . . .	184
Sketching and Analysis of Vocal-Fold Silhouettes in the Frontal Plane . . . . .	194
Conclusion . . . . .	214
2A: Measurements During Changes in Tissue Properties . . . . .	215
2B: Discussion . . . . .	224
3A: Data from Larynxes with Vocalis Muscles Excised . . . . .	226
3B: Discussion . . . . .	233
4A: Static Response to Varying Subglottal Pressure . . . . .	235
4B: Discussion . . . . .	241

CHAPTER 8 - APPLICATION OF RESULTS TO A LARYNGEAL MODEL . . . . .	246
Location of Glottal Segments in the Frontal Plane . . . . .	246
Vertical Level . . . . .	246
Horizontal Displacement . . . . .	247
Results of Calculations . . . . .	249
Aerodynamic Theory: Calculation of Average Airflow . . . . .	254
Calculation of $P_1$ . . . . .	261
Sample Calculations of Mechanical Constants for the	
Two-Mass Model . . . . .	267
Derivation of Elastic Constants . . . . .	267
Further Analysis of Dynamic Results . . . . .	272
CHAPTER 9 - CONCLUSIONS . . . . .	275
Experimental Limitations . . . . .	275
Summary of Results . . . . .	276
'Suggestions for Further Research . . . . .	289
REFERENCES . . . . .	293
BIOGRAPHICAL NOTE . . . . .	304

## Chapter 1 Introduction

The mammalian larynx is the organ of voice. Though not the primary function of the larynx from a biological point of view, voice production is a tremendously important function which cannot be adequately performed by other organs. During production of voice and speech, the human larynx produces controlled gradations of fundamental frequency, intensity, and voice quality, and is also responsible for producing acoustic contrasts in phonetic segments. Understanding the mechanisms by which these different sounds are produced and representing this understanding in terms of a quantitative mechanistic model of the larynx would represent a significant advancement in several diverse fields. These fields include engineering applications of speech synthesis and analysis, linguistic research into the nature of speech and language, and clinical applications such as detection, diagnosis, and treatment of pathology and the development of prostheses.

The general principle by which the larynx produces voice is well known. Anatomically, the larynx contains paired vocal folds and an extensive set of machinery for controlling their configuration. The vocal folds form a slit-like constriction called the glottis in the vocal tract. Functionally, when the vocal folds are placed in an appropriate configuration and air from the lungs is forced

through the glottis, the vocal folds are set into vibration. The resulting modulation of the airflow produces the acoustic energy which is the source for voiced sounds. The so-called "myoelastic-aerodynamic" theory (e.g. van den Berg, 1958), which states that the mechanical vibrations are due to passive interaction between aerodynamic forces in the glottis and mechanical forces in the vocal folds, has survived despite attempts to introduce an active theory of phonation (Husson, 1950).

Although this general principle of the phonatory mechanism has been established, little is actually known about the details of the aerodynamic-mechanical interaction. Due to the inaccessible location of the larynx in the throat, physiological techniques for measuring detailed characteristics of individual glottal cycles are limited. Most significantly, techniques have not been perfected for measuring the mechanical vibrations in the frontal plane (or more generally, in three dimensions). The efforts that have been made using stroboscopic x-ray techniques (Hollien, et al., 1968), high speed cineradiography (Sovak et al., 1971), and ultrasonic imaging (Minifie et al., 1968) have had insufficient resolution to produce useful results on the normal larynx. Other methods for monitoring mechanical activity of the vocal folds, including measurement from high speed films (e.g. Farnsworth, 1940), photoelectric and electric

glottograms (e.g. Sonesson, 1960; Fabre, 1958), and waveforms from externally placed accelerometers (Henke, 1974) are only indirectly related to the detailed vibration patterns. There are only preliminary (and conflicting) direct measurements of the detailed subglottal pressure waveform (van den Berg, 1962; Hiki et al., 1970). Even the acoustic source waveform - glottal volume velocity - has never been measured directly. Estimates of this waveform, using such methods as calculations from a simple aerodynamic model of the glottis (Flanagan, 1968), inverse filtering techniques (Mathews et al., 1961; Rothenberg, 1973), and pressure measurement in an anechoically-terminated tube (Sondhi, 1974) are indirect and of limited accuracy.

Mathematical modelling is an indirect method for studying the phonatory mechanism. Modelling efforts from those of Wegel (1930) to several of the last decade have resulted in the development of sophisticated models capable of self-oscillation. Most recently, modelling studies have demonstrated the value of vertical phase differences in the mechanical vibration patterns for coupling aerodynamic energy to the vibrations (Ishizaka and Matsudaira, 1968). Computer simulation of phonation using these models (e.g. Ishizaka and Flanagan, 1972) has produced results roughly consistent with available physiological data. However, the adequacy of these models cannot be evaluated in detail.



There is uncertainty about the aerodynamic relations for a glottis of a given shape, little is known about the mechanical properties of the vocal folds, and - as already pointed out - the actual glottal shapes are themselves not known. Without such data, it is not possible to realistically determine model parameters and evaluate model performance.

Fabricated mechanical models of the larynx have found limited use in the study of phonation (e.g. Smith, 1962), but excised-larynx preparations have been found to be extremely useful physical analogues of the normal larynx (e.g. van den Berg and Tan, 1959; Matsushita, 1969). Such preparations, mounted within apparatus to supply airflow and to control the adjustments normally produced by the laryngeal muscles, are capable of reproducing much of the gross behavior of the normal larynx. There are several advantages to studying phonation with the excised larynx. The preparation is accessible for observations and measurements that are impossible with the intact larynx. The "muscles" and "respiratory source" can be maintained in steady state for extended durations while the vibrations are studied. Various parameters may be manipulated systematically and independently. There are, however, also limitations to the use of excised larynxes. The death of the tissues no doubt changes their mechanical properties somewhat. More significantly, activity of the vocalis muscle, which forms part

of the body of the vocal folds and which is active during speech, cannot be adequately simulated. Nevertheless, useful results have been obtained from experiments with excised larynxes, including the original observations of the nature of phonation (Ferrein, 1741).

This thesis represents a logical extension of previous excised-larynx studies. Previous studies involved qualitative observation of the detailed vibration patterns and quantitative measurement of variables not directly associated with the details of individual glottal cycles. Aside from extending these results, the present study involves quantitative measurement of the detailed mechanical vibration patterns using optical methods. Apparatus was constructed with which vibrating excised larynxes could be observed both from the customary superior aspect and also from the inferior aspect. The apparatus included instrumentation for measuring the location of any observable landmark in the frontal plane. Small particles were attached to the vocal folds to serve as landmarks and the vibrating larynxes were illuminated with synchronous stroboscopic light at adjustable phase in the glottal cycle. The particles were useful for qualitatively observing the vibration patterns as well as serving as reference points for measurements. Measurements were made of the trajectories of these particles in the frontal plane. By tracking several particles "simultaneously", it

was possible to estimate the detailed shape of one vocal fold in the frontal plane throughout a glottal cycle. Other measurements were made when the vocal folds were stationary.

The implications of the data collected in the present study are examined in this report, both from the point of view of characterizing the nature of the vibrations in general and from the point of view of examining in detail the adequacy of an existing laryngeal model. The ultimate goal of this research is full understanding of the mechanisms of phonation and the development of a laryngeal model for phonation that is both mechanistically correct and descriptive of the output.

Larynxes excised from dogs were used for these experiments. Because the larynxes were canine, and because of the limitations of the excised larynx preparation in general, care must be taken in applying the results of these experiments to normal human phonation. Nevertheless, the excised canine larynx is a useful simplified model of the intact human larynx, and understanding the phonatory mechanism of this preparation is a reasonable first step toward understanding that of its intact human analogue.

This report is organized into nine chapters. Following this introductory chapter, the next three provide the necessary background for the problem under study. Chapter 2 covers laryngeal anatomy, and Chapter 3 covers phonatory

physiology, describing what is known about phonation and showing how the limitations of this knowledge justify the present research. Chapter 4 discusses laryngeal modelling, which on one hand provides a framework for analyzing the results and on the other hand demonstrates the need for more results. Following these introductory chapters, Chapter 5 describes the experimental apparatus and procedures, and Chapter 6 describes the performance characteristics of excised larynxes, considering some of the aspects which have been measured during normal phonation. Chapter 7 contains the major experimental results and also includes discussion about their implications. Chapter 8 describes an attempt to fit a laryngeal model to some of the results of Chapter 7. Finally, Chapter 9 contains a summary of results and their implications, and includes suggestions for further research.

Chapter 2 Anatomy of the Larynx

The anatomy of the larynx and surrounding structures is largely known and is described in numerous texts (e.g. Gray, 1959; Grant 1962; Pernknopf, 1952; Negus, 1949; Sonesson, 1968). It will be briefly reviewed here. Some uncertainties about laryngeal anatomy (and physiology) still remain, and these could affect our understanding of vocal mechanisms. They will be mentioned in the course of this chapter (and in the next). Finally, although canine larynxes have often been used as analogs of the human larynx -(e.g. Ueda et al., 1971; Koyama et al., 1969, 1971; Rubin, 1963; Matsu-shita, 1969) - there are some anatomical differences which will be pointed out.

In the discussion of laryngeal anatomy and physiology, an overview should be maintained. As Negus (1949) pointed out, the most important function of the larynx from an evolutionary point of view is that of protective respiratory closure. Many other requirements - such as those of deglutition, olfaction, respiratory capacity, and regulation of thoracic pressure - have affected the development of the larynx to a greater extent than has the requirement of voice production. The larynx should thus not be thought of as solely "the organ of voice". Also, Negus' (1949) study of laryngeal evolution and the voice production characteristics of various species led him to conclude that man's

unique vocal abilities depend not on any uniqueness in the structure of the organ itself but on his unique will and ability to control it. There is no reason to believe that the mechanisms of phonation in dogs or other animals are essentially different from those in humans.

General Plan of Laryngeal Anatomy; Cavity of the Larynx

The larynx is located in the throat, where it controls the opening between the trachea and the pharynx, and helps to separate the respiratory tract from the alimentary tract. Its support comes from connections to the "floating" hyoid bone above, the trachea and sternum below, and the lower pharyngeal wall and esophagus posteriorly.

The larynx consists of a cartilaginous skeleton, connected by several ligaments and controlled by an extensive musculature. The membranes lining the internal cavity are gathered into two pairs of bilateral folds - the vocal folds and the ventricular folds - which extend into and constrict the airway. The folds are supported by two pairs of bilateral ligaments, sharing a common anterior origin but attaching to separate, mobile cartilages posteriorly. The ligaments can thus be approximated and tensed in order to perform the valvular function of the larynx. In the vertical direction, each fold is shaped to form a gradual constriction on one side and a sudden constriction on the other. The ventricular folds form a sudden constriction inferiorly,

thus forming an efficient outlet valve, while the true vocal folds have the opposite orientation and form a more efficient inlet valve.

Fig. 2-1 shows schematically a coronal section through the larynx at the level of the vocal folds. As indicated, the space between the vocal folds is known as the glottis. (The glottis consists of two parts - an anterior intermembranous part between the vocal folds and a posterior intercartilaginous part between the cartilages supporting them.) The cavity between the upturned edges of the vocal folds and the downturned edges of the ventricular folds is the ventricle (sinus of Morgagni). It is extended, at some levels, into a saccule. Above the level of the ventricular folds is the laryngeal vestibule, or opening of the larynx. Lateral to the membranes surrounding the vestibule but medial to the outer cartilaginous skeleton is the piriform recess, which serves as a food channel around the opening of the lower airway and into the esophagus.

#### Cartilages

There are three unpaired cartilages (cricoid, thyroid, and epiglottis) of the human larynx and three sets of paired cartilages (arytenoid, corniculate, and cuneiform). They are illustrated in Fig. 2-2.

The cricoid cartilage forms the base of the laryngeal skeleton and much of its back cover. It is shaped like a signet ring with the arch extending anteriorly and the broad

FIGURE 2-1

Schematic frontal section of the larynx.(from Broad,  
1973).



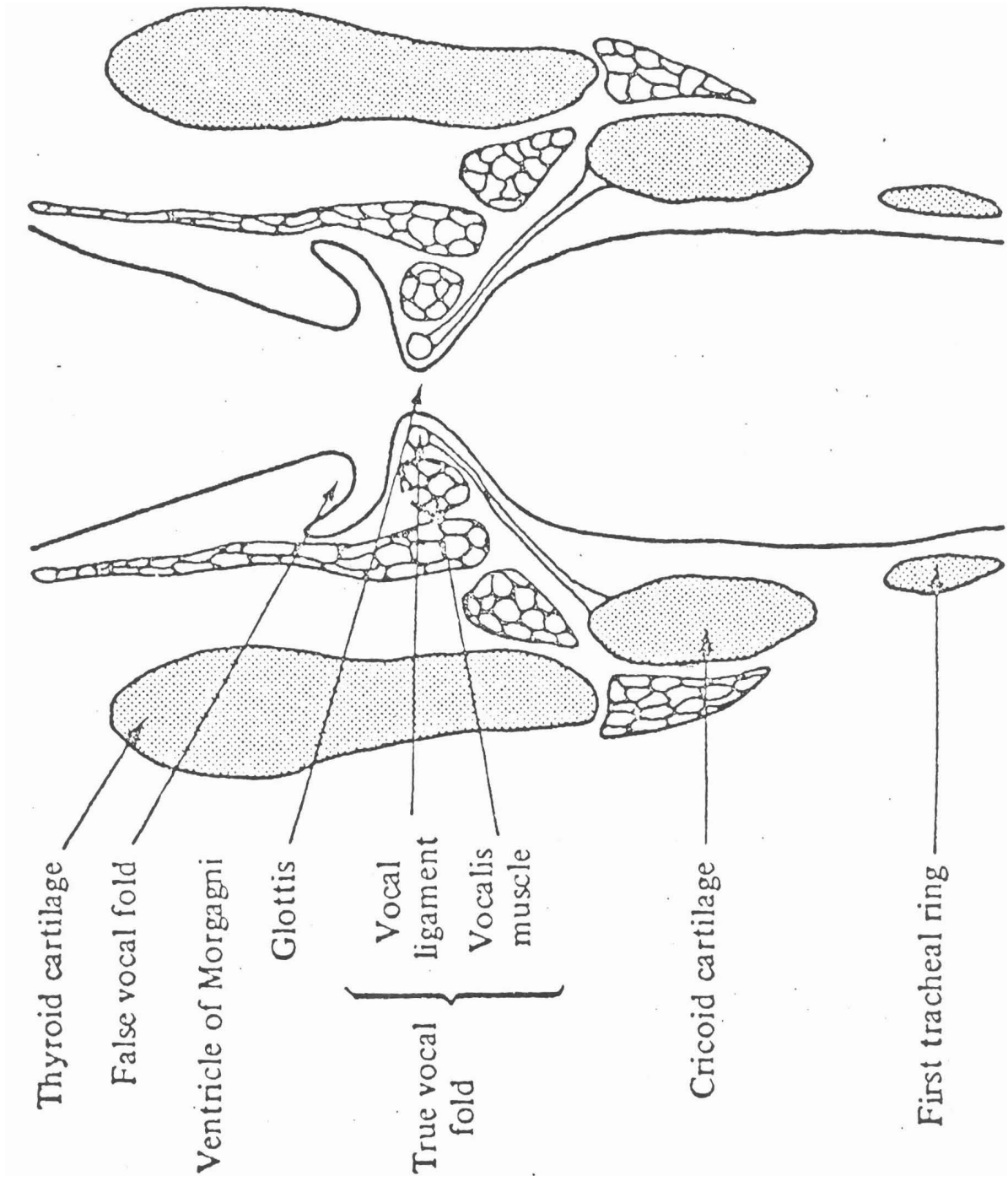

Thyroid cartilage

False vocal fold

Ventricles of Morgagni

Glottis

Vocal ligament

Vocalis muscle

True vocal fold

Cricoid cartilage

First tracheal ring

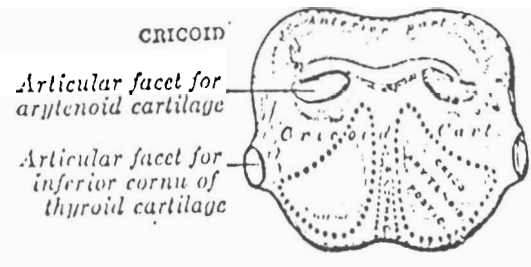
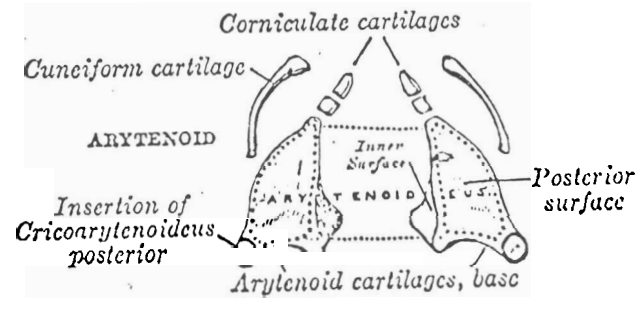
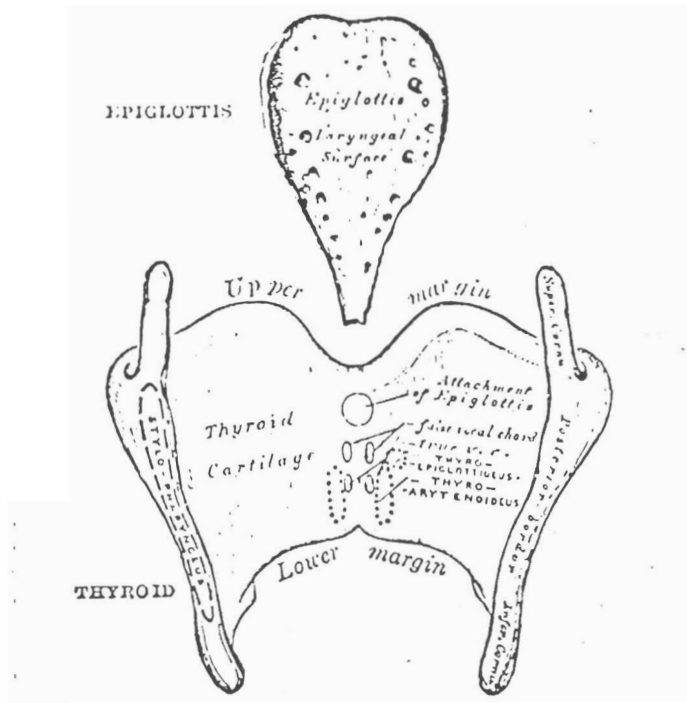

FIG. 15-11.—The cartilages of the larynx. Posterior view.

FIGURE 2-2

The cartilages of the larynx. (from Gray, 1959).

face, or lamina, facing posteriorly. The thyroid cartilage, which is the largest laryngeal cartilage, forms the front and side cover. Its two wings (alae, or laminae) are joined anteriorly at the midline, meeting at an angle of roughly  $90^\circ$  in adult males,  $120^\circ$  in adult females, and almost smoothly in children. Among its prominent anatomical features are the laryngeal prominence (Adam's apple) anteriorly and the superior and inferior cornu posteriorly. The superior cornu rises toward the hyoid bone (to which it is attached by a ligamentous band) and the inferior cornu articulate with the lateral aspect of the cricoid cartilage.

The epiglottis, rising upward and back from the superior part of the thyroid angle, forms the anterior wall of the vestibule. Its primary function is to deflect food around the entrance of the larynx into the piriform recess.

The paired arytenoid cartilages form the mobile posterior support for the laryngeal folds. They are usually described as small truncated pyramids whose three faces point medially, posteriorly, and anterolaterally. The surface of the base articulates with the cricoid cartilage, as will be described later. There are two projections from the base. The vocal process projects forward, giving rise to the vocal ligament, while the muscular process projects laterally, serving as the attachment for several laryngeal muscles.

The corniculate and cuneiform cartilages lie superior to the arytenoid cartilage. The corniculate (cartilage of Santorini) is continuous with the arytenoid, forming its apex. The cuneiform (cartilage of Wrisberg) lies anterior to the corniculate, imbedded in and providing support for the membranous folds between the arytenoid cartilage and the epiglottis. Both the cuneiform and corniculate cartilages are considered vestigial in man, and the cuneiform is sometimes entirely lacking.

#### Ligaments and Membranes

The locations of most of the laryngeal ligaments are indicated in Fig. 2-3. They perform a connective function, connecting the larynx to the hyoid bone, supporting the laryngeal joints, and limiting movements about these joints. The most important laryngeal ligaments are, of course, the vocal and ventricular ligaments. The function of many of the other ligaments (and muscles) are considered in terms of their effects upon these two. A typical length for the vocal ligament in adult males is about 1.4 cm. Dimensions will be discussed in more detail later.

The membranes lining the airway consist of an elastic inner lining and a mucous membrane at the surface. The elastic layer lines almost the entire laryngeal cavity, with the exception of the ventricular walls. It is thus separated into a superior part (the quadrangular membrane) and

FIGURE 2-3

Ligaments of the larynx. (from Sonesson, 1968).

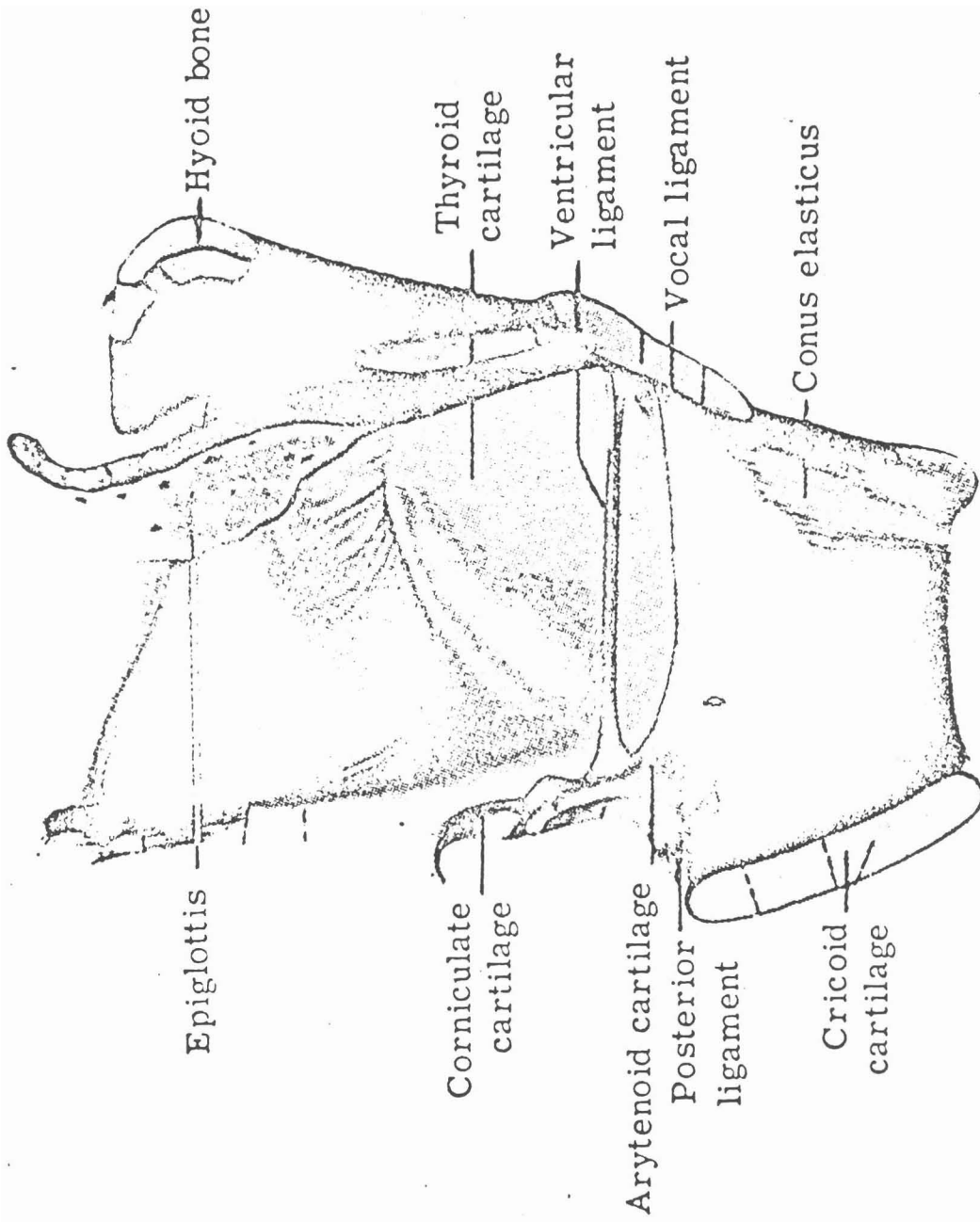

Posterior

an inferior part (the triangular membrane). The quadrangular membrane lines the ventricular folds and passes up to the epiglottis, forming the aryepiglottic folds, which separate the vestibule from the pirigorm recess. The triangular membrane lines the floor of the ventricle and is continuous with the vocal ligament. It passes downward from the ligament and arytenoid cartilage to attach to the lower circumference of the cricoid cartilage, thus forming a conical surface called the conus elasticus.

The mucous membrane lines the entire laryngeal cavity and is continuous with the mucous linings of the airway both above and below. It is particularly richly supplied with mucous glands at the level of the ventricle. At areas subject to frequent wear (the level of the glottis and ventricular folds and parts of the aryepiglottic folds) it consists of tougher tissue not containing mucous glands. It is loosely connected to the submucous tissue except at these locations of frequent wear, where it is closely connected.

### Joints

There are two paired joints of the larynx: the cricothyroid and the cricoarytenoid.

The cricothyroid joint provides an articulation between the lateral surfaces of the cricoid cartilage and the inferior cornu of the thyroid cartilage, as shown in Fig. 2-4. As the figure shows, movement about this pair of joints is

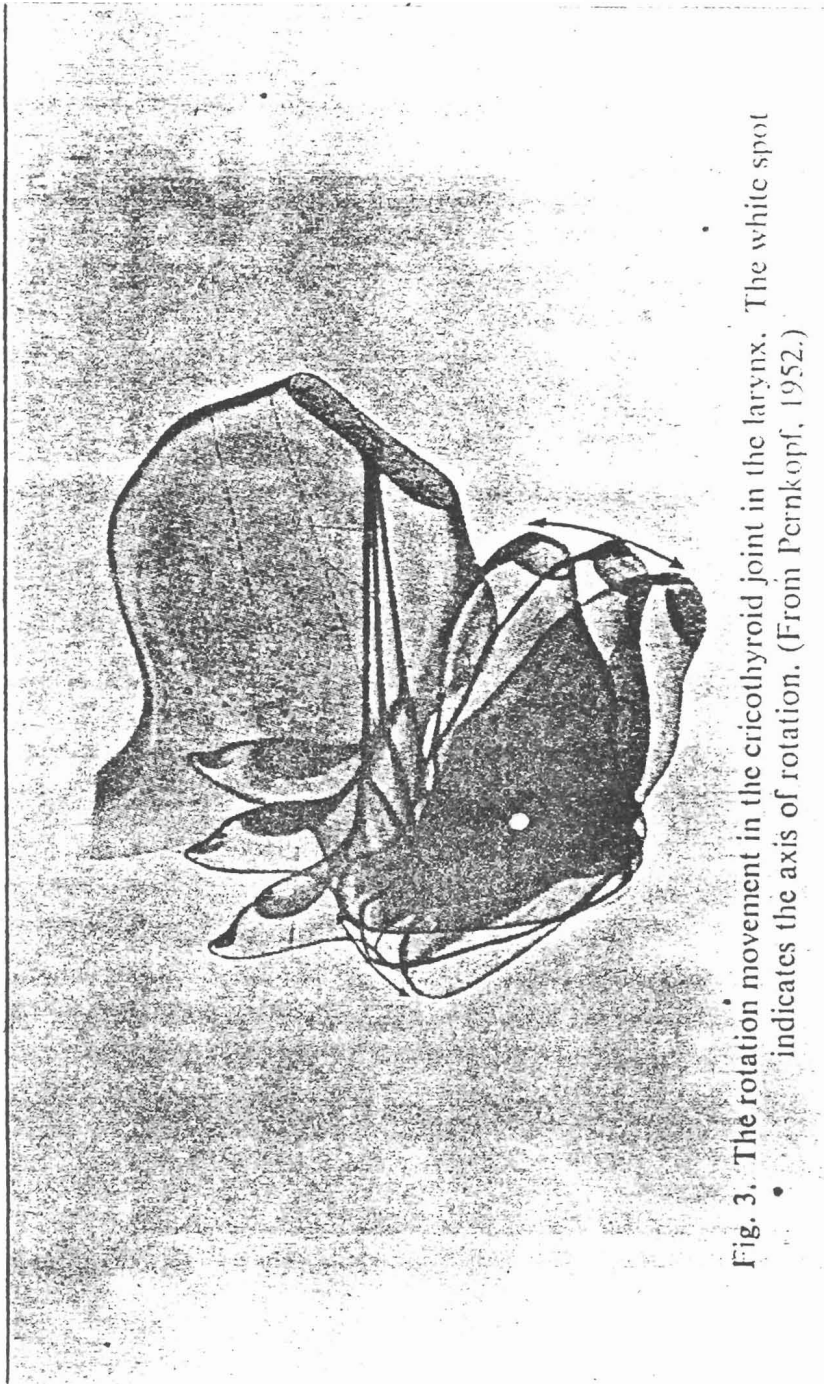

Fig. 3. The rotation movement in the cricothyroid joint in the larynx. The white spot indicates the axis of rotation. (From Pernkopf, 1952.)

FIGURE 2--4

The cricothyroid joint. (from Sonesson, 1968).



is generally rotational about an axis passing through the two joints. Because the joint is below the level of the vocal folds, the folds are stretched (tensed) or shortened (laxed) when the anterior parts of the cartilage are rotated toward or away from each other, respectively.

The cricoarytenoid joint is an articulation between the bases of each arytenoid cartilage and the posterolateral parts of the cricoid cartilage's superior ridge. Its function is to regulate the size and shape of the glottal opening. The manner in which it does so is somewhat difficult to visualize and hence has often been misunderstood.

The articulating surfaces of the cricoarytenoid joint consist of a convex cylindrical surface on the ridge of the cricoid cartilage matched by a similar convex surface on the ridge of the cricoid cartilage matched by a similar convex surface on the base of the arytenoid cartilage, as shown in Fig. 2-5 (which is a photograph of a dissected joint from a dog's larynx). This arrangement allows for rotation of the arytenoid cartilage about the cylinder axis. The cricoid surface is somewhat longer than that of the arytenoid, so a limited amount (roughly 2 mm.) of gliding along the axis is allowed. The orientation of the cylindrical axis is from posteromediosuperior to anterolateroinferior, as indicated in Fig. 2-6.

When the arytenoids are rotated medially from the

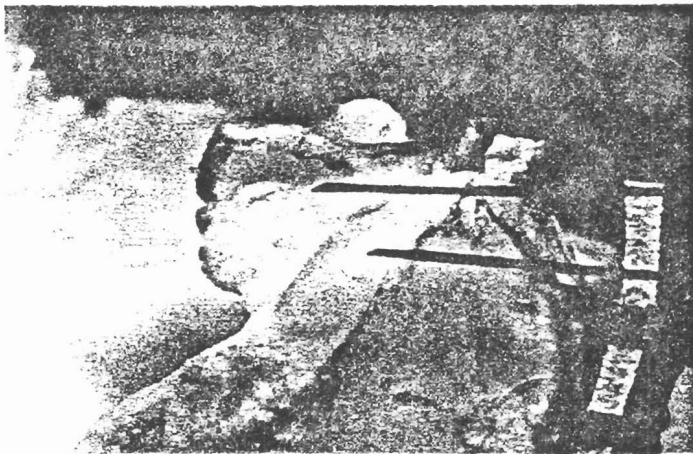

— concave facet on base  
of arytenoid cartilage

— convex facet on  
cricoid cartilage

Fig. 2-5

Photograph of dissected cricoarytenoid joint.

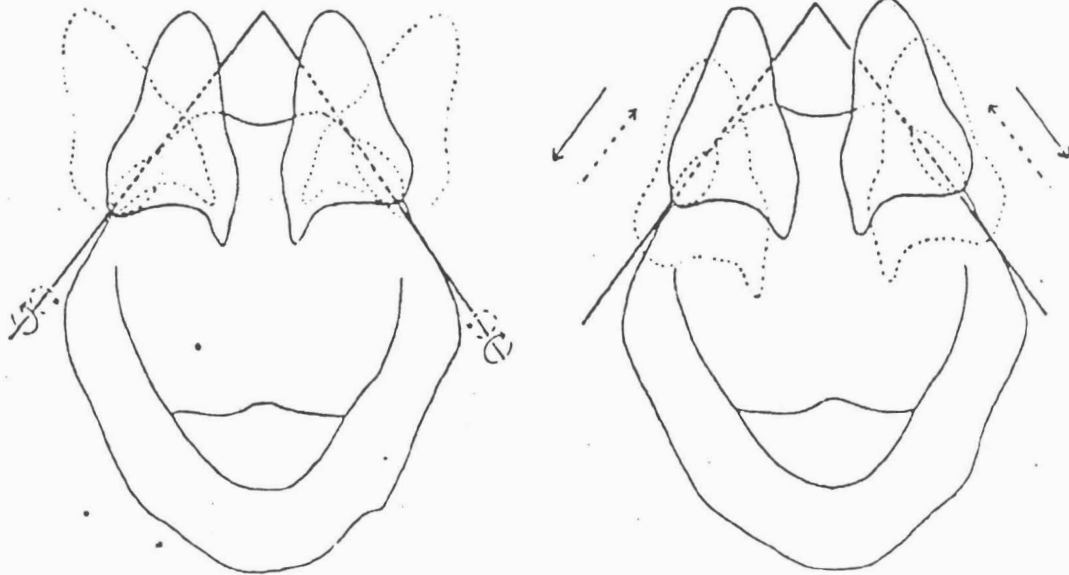

Fig. 5. The two types of movement in the cricoarytenoid joint. (From Sonesson, 1959; in Hjortsjö: Rörelseapparaten.)

FIGURE 2-6

Function of the cricoarytenoid joint. (from Sonesson, 1968).

breathing position, the vocal processes move medially and can be made to approximate (adducting the vocal folds). Because of the cylinder axis orientation, however, they simultaneously move anteriorly (shortening the folds) and inferiorly. The intercartilaginous and intermembranous glottis may be either both open or both closed simultaneously. In addition, with the arytenoid cartilages pulled back along the axis, it is possible to approximate the cartilages without closing the membranous glottis. Similarly, with the arytenoids pulled forward, the vocal processes may be approximated while the intercartilaginous glottis is still open.

#### Controlling Musculature

An extensive musculature is provided for manipulating the internal configuration of the larynx and for moving the larynx as a whole. The muscles are divided into two groups: the intrinsic muscles, which are associated only with the larynx itself, and the extrinsic muscles, which are also associated with other structures. The intrinsic muscles are often further divided into functional groups, depending on the effects of their contractions on the vocal folds.

#### Intrinsic Muscles

All the important intrinsic muscles except one (the transverse arytenoid) are paired. With the exception of

the cricothyroid muscle, they are all attached to the arytenoid cartilage. The locations and actions of the muscles are indicated in Fig. 2-7.

The cricothyroid muscle arises from a small region along the anterior arch of the cricoid cartilage and fans out to insert on the inferior border of the thyroid lamina and the anterior border of the inferior cornu. Its contraction rotates the anterior portions of the two cartilages toward each other and pulls the thyroid cartilage slightly anteriorly with respect to the cricoid. Both these actions contribute to the tensing of the vocal ligaments.

The posterior cricoarytenoid muscle arises from the muscular process of the arytenoid cartilage and fans out to insert along the length of the median ridge on the posterior lamina of the cricoid cartilage. Its contractions tend to abduct the glottis by rotating the arytenoid cartilage about its cylinder axis.

The lateral cricoarytenoid also arises from the muscular process, but passes anteriorly to insert into the superior border of the cricoid ring. Its contraction pulls the arytenoid cartilage anteriorly a little and rotates it medially by virtue of its anterior and medial direction of pull. The muscle thus contributes to the adduction of the vocal folds.

The interarytenoid muscle connects the two arytenoid cartilages posteriorly. The transverse component is the

FIGURE 2-7

Locations and actions of the intrinsic laryngeal muscles.  
(from Sonesson, 1968).

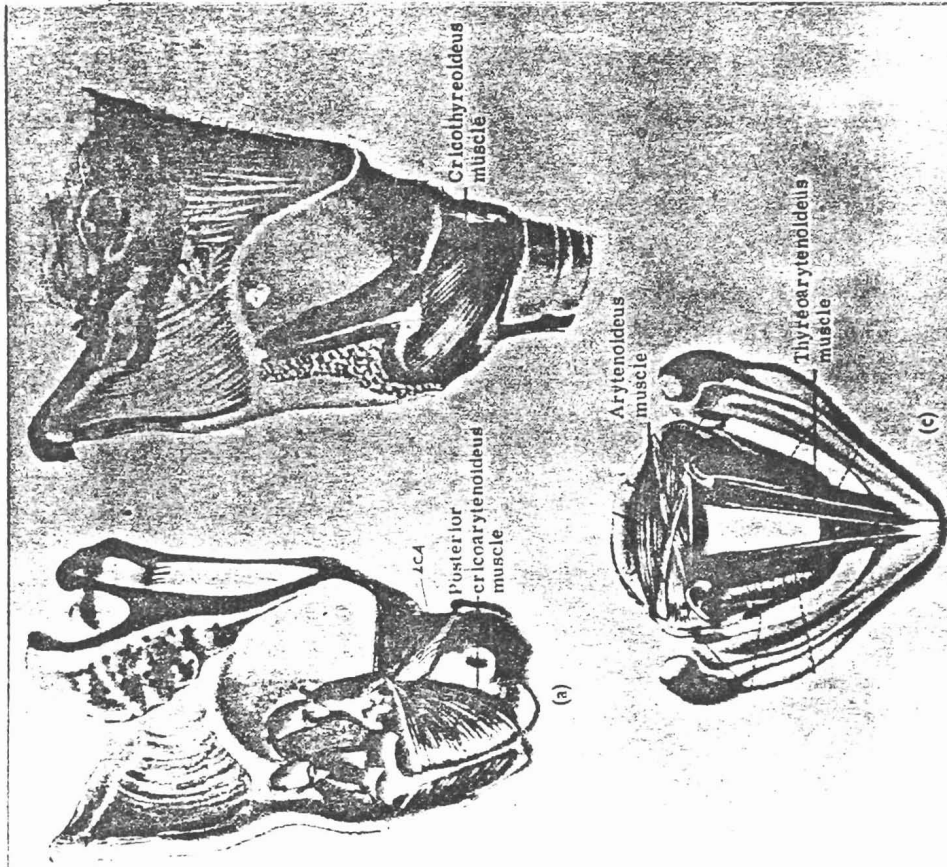

Fig. 6. The laryngeal muscles; (a) posterior view of the larynx: the posterior cricoarytenoid muscle, (b) anterior view of the larynx: the cricothyroid muscle, (c) the larynx seen from above: the thyroarytenoid muscle. (From Pernkopf, 1952.)

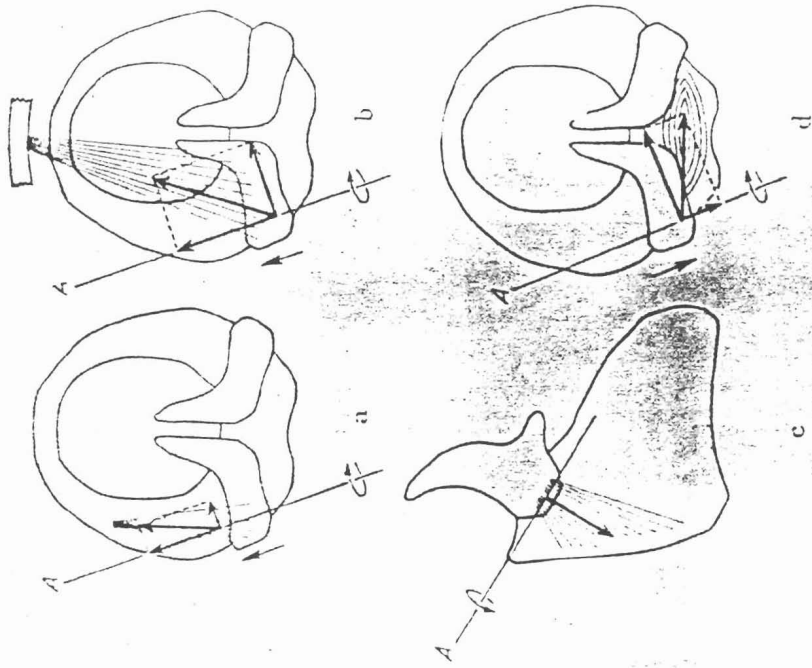

Fig. 7. Schematic drawings of the laryngeal muscles. The arrows indicate the direction of the force exerted by the muscles; (a) the lateral cricoarytenoid muscle, (b) the posterior cricoarytenoid muscle, (c) the arytenoid muscle, (d) the thyroarytenoid muscle. (From Sonesson, 1959.)

only unpaired intrinsic muscle, connecting the posterior surfaces and lateral margins of the two cartilages. The oblique component is a crossed muscle, arising from the muscular process of one cartilage and inserting into the apex of the opposite one. Some fibers continue past the apex and pass along the aryepiglottic folds to the epiglottis. Contraction of the interarytenoid draws the posteriors of the arytenoid cartilages together, which also prevents them from sliding forward. Thus, the muscle may act as an adductor or as a tensor, and it may be thought of as controlling differences between intermembranous and intercartilaginous configuration.

The structure and function of the remaining intrinsic muscle, the thyroarytenoid muscle, has been the source of much controversy and is probably still not fully understood. The muscle is attached on one side to the angle of the thyroid cartilage and on the other to the arytenoid cartilage. It is divided functionally but probably not anatomically into two parts. The medial portion, known as the vocalis muscle, forms part of the body of the vocal folds. Its fibers do not appear to insert into the vocal ligament (Sonesson, 1960), as has been asserted by some (Husson, 1950), although some inferior fibers do seem to innervate the conus elasticus. Its contractions may be thought of as increasing the tension in the body of the vocal folds



or decreasing the tension in the ligament. The external part, which arises inferiorly at the thyroid cartilage and attaches more laterally on the arytenoid cartilage, is considered a glottal adductor, acting similarly to the lateral cricoarytenoid muscle. The most superior fibers form the walls for the laryngeal ventricle, and some turn back past the arytenoid cartilage to join the aryepiglottic muscle (forming the thyroepiglottic muscle). These fibers thus help to perform supraglottal closure - i.e. closure of the ventricular folds and aryepiglottic sphincter.

#### Extrinsic Muscles

The extrinsic muscles are capable of moving the larynx as a whole, since they attach to surrounding structures. By virtue of their laryngeal attachments, however, they may also affect the internal configuration of the larynx (Sonninen, 1968).

There are basically three pairs of these muscles. Two of them are the strap muscles, which attach to the oblique line of the thyroid cartilage (which is shown in Fig. 2-2). The thyrohyoid passes superiorly to attach to the hyoid bone, and the sternothyroid passes inferiorly to attach to the sternum. They can draw the larynx up or down, respectively, and in doing so can also rotate the thyroid cartilage with respect to the cricoid. The third pair of muscles is the inferior pharyngeal constrictors, which arise from the sides of the cricoid and thyroid cartilages and meet on the

posterior wall of the pharynx. The interiormost of these fibers form a muscle called the cricopharyngeus, which forms a sphincter around the opening of the esophagus.

Since the larynx is suspended from the hyoid bone, muscles which affect the bone may also affect the larynx. There are several muscles capable of elevating and depressing the hyoid bone and also to some extent moving it forward and backward.

#### Nerve Supply and Sensory Anatomy

The larynx is innervated by two separate branches of the vagus nerve. The superior laryngeal nerve has an external branch which provides motor innervation to the cricothyroid muscle and an internal branch which supplies sensory innervation and innervation to the mucous glands above the level of the vocal folds. The recurrent laryngeal nerve, which enters the larynx in an upward course, provides motor innervation to all the intrinsic muscles except the cricothyroid and provides sensory and secretomotor innervation up to the level of the vocal ligament. The recurrent nerves of the two sides differ in length, with the left nerve longer since it must pass around the aortic arch.

There is a rich supply of receptors in the mucosal and submucosal membranes of the larynx. These include pressure (tactile) receptors as well as others (pain, chemoreceptors) associated with respiratory function. There are also

receptors in the joint capsules (articular mechanoreceptors). The issue of the possible presence of myotatic (stretch) receptors in the intrinsic muscles has been a controversial one (Pressman and Kelemen, 1955; Sawashima, 1970) which has not been completely settled. It appears, however, that there is at least a primitive kind of stretch receptor if not the common muscle spindle found in other skeletal muscle.

#### Cross Section of the Vocal Folds

A typical schematic coronal section of the vocal folds at a level anterior to the vocal process is shown in Fig. 2-8. The thyroarytenoid muscle is lateral and inferior to the vocal ligament. Superior to the cricoid cartilage is muscular tissue which includes components from the cricothyroid muscle and lateral cricoarytenoid muscle in proportion depending on the level of the transaction. Fig. 2-9, shows a schematic horizontal section at the level of the vocal processes. The length of the glottis consists of roughly  $\frac{2}{3}$  inter-membranous part (when stretched) and  $\frac{1}{3}$  intercartilaginous part, with a total length of about 2 cm., for adult males. As Fig. 2-9 shows, the membranous part can constitute less than half the length of the glottis. Glottal width can vary anywhere from zero (glottal closure) to 8 mm. (normal breathing) to about 15 mm. (deep inhalation). Typical maximum width during voice production is one or two mm. (roughly 20 mm.<sup>2</sup> maximum area).

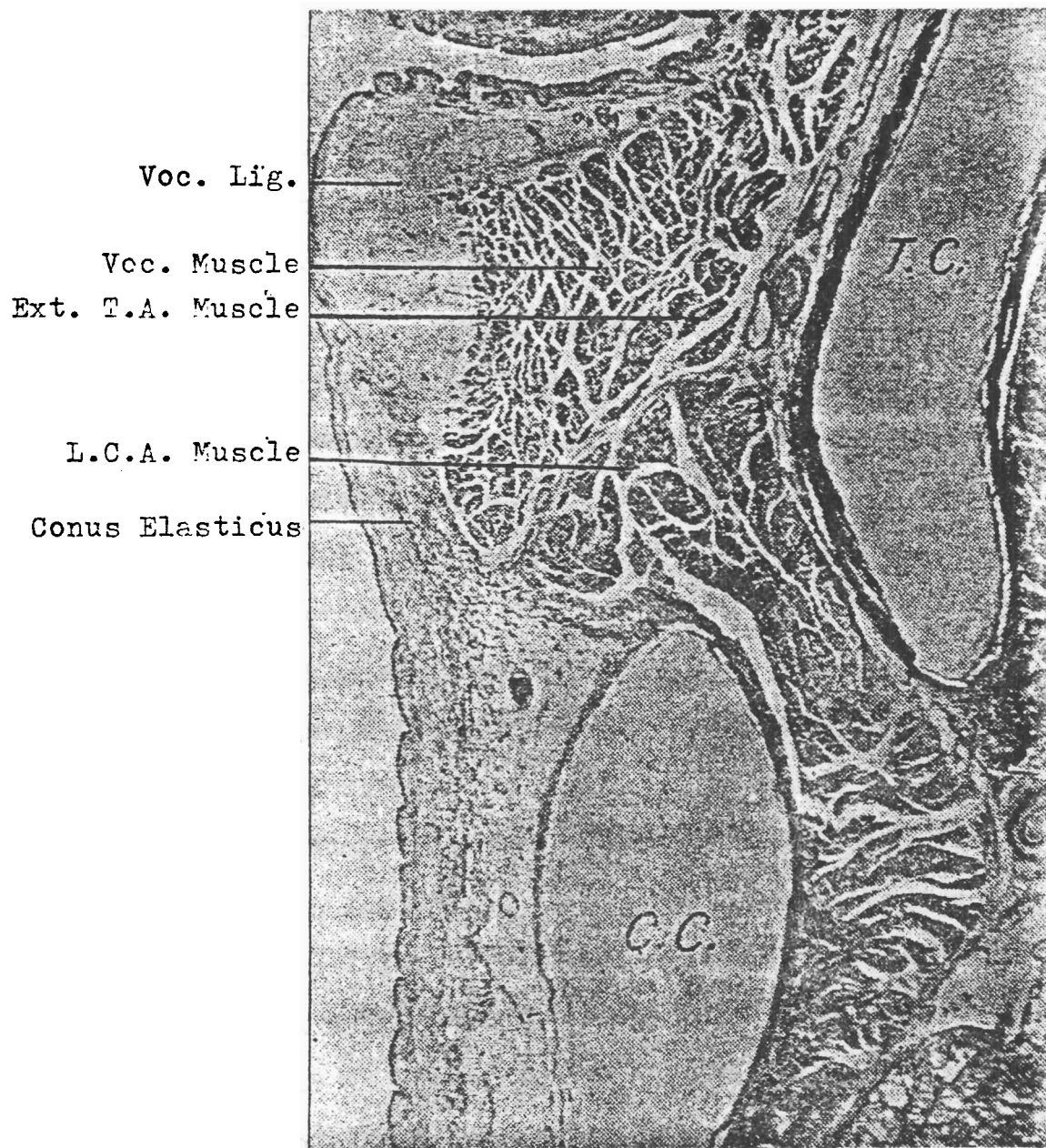

FIGURE 2-8

Frontal section of the larynx (from Sonesson, 1960).

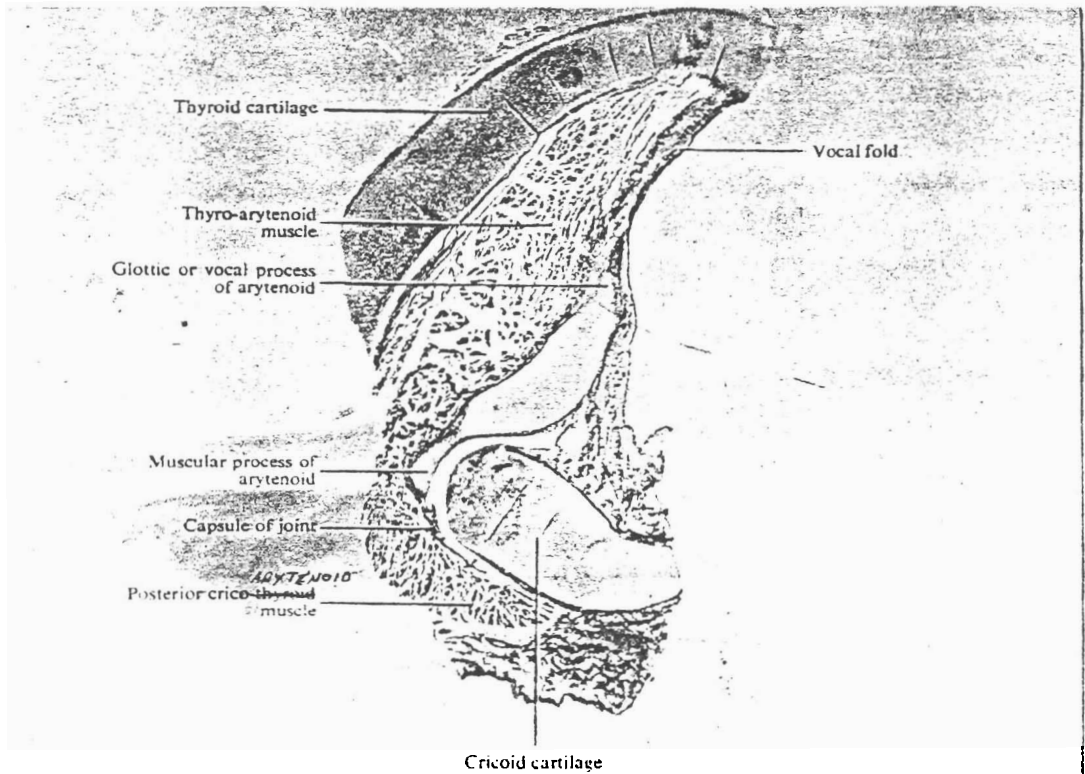

FIG. 172 — Transverse section of larynx of a child, to show the crico-arytenoid joint and the vocal and muscular processes of the arytenoid.

FIGURE 2-9

Horizontal section of the larynx (from Negus, 1949).

### Lower Respiratory Tract and Vocal Tract

The anatomy and physiology of the lower respiratory tract has been extensively studied (see Fenn and Rahn, 1964). The trachea descends for roughly 12 cm. and then splits into two bronchi, which subsequently divide and so on for up to twenty generations. The statistics of the airway anatomy (e.g. average generation number, total number of branches, total airway cross section all as a function of distance from the glottis) have been measured (Weibel, 1964). The total cross sectional area of the tract grows slowly at first (from an initial value of about 2.5 cm.<sup>2</sup>) and then grows very rapidly as the level of the alveoli is approached, although the cross sections of individual air passages decreases.

The anatomy of the supraglottal tract during speech production has been the subject of much research in the past several years. (Fant, 1960, Perkell, 1969). It consists of a tube (terminating with the lips) roughly 17 cm. long (for an adult male) whose cross section is adjustable at virtually every level. Just above the larynx, its area is about 2.5 cm. A nasal tube may be switched in or out depending on the action of the velum.

### Anatomy of the Canine Larynx

The larynx of dogs like those used for this thesis (Mongrels, 20 - 30 kg.) is similar in size to an average human larynx, and its anatomical structure is grossly

similar, though it differs in several details (Bradley, 1959, Miller et al., 1964). The epiglottis, for example, is larger, in accordance with its more basic function in olfaction (Negus, 1949). It is supplied with a pair of hyopiglottic muscles capable of pulling it anteriorly to isolate the mouth cavity from the respiratory system.

There are some differences in the shape of the thyroid cartilage. It is less angulated than the human male's cartilage, and its superior horns articulate more directly with the hyoid bone.

The most important differences are in the dorsal region. The interarytenoid muscle, which in man is thick and effective and which consists of both crossed and uncrossed components, is small and indistinct and consists of only an uncrossed (but paired) component. In the dog, there is an extra little cartilaginous nodule, the interarytenoid cartilage, connecting the two arytenoids. The transverse arytenoid (interarytenoid) muscle, which arises from the region of the muscular process of the arytenoid cartilage, inserts into the interarytenoid cartilages, and does not pass the midline. The cuneiform cartilage of the dog is larger than that of man, consistent with the need for more efficient aryepiglottic function. The ventricular muscle, which is indistinct in man, is a thick muscle connecting the arytenoid and interarytenoid cartilages with the ventral part of the cuneiform cartilage.

### Chapter 3 Physiology of the Larynx

In this chapter, methods for studying laryngeal physiology - particularly as it applies to voice production - are reviewed. Some aspects of basic laryngeal physiology and the physiology of voice production are then discussed.

#### Methods for Studying Laryngeal Physiology

##### Laryngoscopy

Direct observation of the larynx through the mouth is possible, though it is essentially a surgical procedure and can be difficult and painful for the subject. Indirect laryngoscopy, utilizing a mirror at the back of the mouth to reflect light onto the larynx and reflect back the image, has been more commonly used.

During phonation, either stroboscopic methods or high speed cinematography must be used to observe the vibrations of the vocal folds. Resolution using high-speed cinematography is limited by the frame rate (which is typically 1000 to 6000 frames per second). Stroboscopic methods can only be used to observe steady phonation. Resolution is limited by the dynamic variations of the vibrations (Lieberman, 1961; Moore and von Leden, 1958).

Some disadvantages of the laryngeal mirror are that it may interfere with normal vocal activity, that normal activities may interfere with the view obtained with it (especially due to movements of the epiglottis), and that use



of the mirror is not tolerated by many subjects. Some of these disadvantages have been overcome through the development of a fiberoptic laryngoscope (Sawashima and Hirose, 1968) which can be inserted into the pharynx via the nose and which interferes only minimally with normal speech production. It has been used for cinematography at rates up to about 64 frames per second (Sawashima and Ushijima, 1971). With improved light sources, this limit should be extendable to the high-speed range, or stroboscopic methods might be used. The fiberoptic laryngoscope allows, for the first time, observation of the larynx engaged in the production of connected speech (Sawashima et al., 1970).

#### Glottography

Several techniques other than laryngoscopy have been used to monitor glottal vibrations.

Photoelectric glottography involves directing light toward the glottis, either from above or below, and measuring the amount transmitted to the other side using a photoelectric device. The technique has been used as a straightforward way to represent the performance of excised preparations as early as 1935 (van den Berg, 1968). It was adapted by Sonesson (1960) and later by Lisker et al. (1969) for use during normal steady phonation and running speech, respectively, but it gives at best only qualitative information about the state of the glottis.

Ultrasonic imaging of the larynx has been attempted with only limited success (see review in Sawashima, 1970). Essentially, it is useful only for detecting presence or absence of glottal closure.

Electronic glottography (Fabre, 1958), which measures variations in electrical impedance across the neck due to vibrations of the vocal folds, also yields very qualitative results, and hence is only moderately useful. It has found application as a transducer to measure voicing fundamental frequency (Fourcin and Abberton, 1971), but throat microphones and accelerometers (Nickerson and Stevens, 1973) are also useful for this purpose.

#### Radiography

Still- and cine-radiographic techniques have been used to monitor gross movements of the speech anatomy in general (e.g. Perkell, 1969) and the larynx in particular (Sonninen, 1968; Hollien and Curtis, 1962, Kitzing and Sonesson, 1967). Lateral-view radiography has been used to study the length of the vocal folds during changes in fundamental frequency (Damste et al., 1968) and frontal-view radiography has been used to measure changes in the vertical thickness of the folds (Hollien and Colton, 1969). These techniques are limited in both the spatial and time domains, although there have been recent attempts at improvement (Sovak, et al., 1971) in order to study the details of the glottal cycle.

Although conventional radiograms are essentially only

shadow images, it is possible to focus on a particular internal plane using the technique of laminagraphy or tomography, in which the x-ray source and detector are moved around the plane of focus during exposure to blur out all the undesired planes. This technique has been frequently used to obtain images of coronal (frontal) sections of the larynx, but of course the exposure time is large compared to a glottal period. The technique was refined by Hollien et al. (1968), who flashed the x-ray source stroboscopically during the laminagraphic procedure. For steady phonation, they could thus obtain images of instantaneous laryngeal cross sections at successive phases within a cycle. Although this technique of stroboscopic laminagraphy (STROL) is potentially of great value, its usefulness has been limited by the relatively poor quality of the images obtained.

#### Electromyography

Electromyographic studies of laryngeal muscles have been reported since the 1950's. The early studies (Faaborg-Andersen, 1957) utilized bipolar needle electrodes, which were found to be difficult to work with and which probably interfered with normal function. Later, hooked wire electrodes, which are inserted by a needle that is subsequently withdrawn, were introduced (Hirano and Ohala, 1969), making it possible to record from all the intrinsic muscles with a minimum of interference with normal function. With the new electrode techniques and new data processing techniques, results are

only currently beginning to really accumulate (e.g. Gay et al., 1972; Shipp and McGlone, 1971; Hirano et al., 1970).

Measurement of Glottal Airflow and Subglottal Pressure

Average subglottal pressure can be measured directly by coupling a pressure transducer to the subglottal region through a tracheal puncture. In a small number of cases, there are surgical patients with tracheostomas as well as normal larynxes. In such cases, as with excised larynxes, it is possible to better couple a pressure transducer, so that more of the dynamic information can be recorded (van den Berg, 1962). Subglottal pressure can also be measured indirectly using an esophageal balloon (van den Berg, 1956). It has been shown that changes in esophageal pressure differ from those in tracheal pressure over the course of a single expiratory cycle (Kunze, 1964), but corrections can be made from these differences.

With tracheal punctures and esophageal balloons, only average or low-frequency subglottal pressure information can be recorded. Such information is, of course, useful for studying such aspects as fundamental frequency, intensity, and registration control. Using modern miniaturized pressure transducers, however, it appears possible to make broadband subglottal pressure measurements by lowering the transducer through the glottis directly into the trachea (Koike and Perkins, 1968; Hiki, Koike, and Takahashi, 1970; Koike and Hirano, 1973; Perkins and Koike, 1969).

Average airflow during voice production can be measured with a body plethysmograph, which indirectly measures changes in lung volume (Mead, 1960). Hot wire devices (anemometers) might be useful, though they have not generally been used. Pneumotachographs, which are face masks or tubes incorporating linear flow resistors (viz. fine mesh screens) and pressure transducers, are perhaps the most useful. They have been used to measure average flow rates for sustained sounds (e.g. Isshiki, 1964), to measure flow rates over the course of phonetic segments (Klatt, Stevens, and Mead, 1968), and even to measure the detailed acoustic volume velocity waveform at the lips (Rothenberg, 1973). In the latter case, airflow at the glottis was also estimated by inverse filtering, to negate the effects of the vocal tract. The acoustic component of volume velocity through the glottis can also be estimated by inverse filtering of the radiated acoustic pressure waveform (Mathews, Miller, and David, 1961; Holmes, 1963), although this is one step further removed from the glottis. Other attempts to estimate aerodynamic events at the glottis have included aerodynamic modelling in conjunction with glottal area data measured from high speed movies (Flanagan, 1958) and experiments with excised larynxes and animal preparations.

For understanding the mechanism of phonation, the distribution of pressure within the glottis is important as

well as the pressure drop across it. Some attempts have been made to derive this distribution by means of mathematical and physical modelling, and these will be discussed in the following chapter.

Experiments with Excised Larynxes and Animal Preparations, and Observations of Human Pathologies

Experiments with excised larynxes, both of animals and humans, have added much to understanding of laryngeal mechanisms. Such experiments were reported by Ferrein as early as 1741, predating general understanding of the larynx's function in voice production. More recent experiments, most notably by van den Berg (1959, 1960, 1968) and by others (Anthony, 1968; Matsushita, 1969; van Michel, 1971), have made use of more modern equipment and more careful techniques to elucidate the kinds of vocal activity of which the laryngeal structures are intrinsically capable. Observations and measurements can be made more completely than with a normal larynx, and physiological parameters such as airflow (or pressure) and laryngeal configuration can be controlled and systematically varied.

The major limitation of the excised preparation - namely that its death changes some of its mechanical properties, including its ability to tense the vocalis muscle - can be overcome by using live animal preparations. There are many reports in the literature of experiments using animals, mostly dogs, to study phonatory physiology (e.g., Rubin,

1963; Ueda et al., 1971; Koyama et al., 1969; Koyama et al., 1971. In such experiments, pressure and airflow can be either measured or regulated, and laryngeal muscle activity can be controlled. Animal preparations are, of course, also used for studying more basic aspects of laryngeal physiology such as reflex mechanisms (e.g., Kirchner and Wyke, 1965).

To some extent, it should be possible to do limited experimental work on pathological human larynxes during surgical procedures, but such work has not been extensively reported. However, observations of the effects of various pathologies on voice production (e.g. Tanabe, et al., 1972; Hiroto, 1966) have added to the understanding of normal laryngeal physiology and probably will do so much more in the future.

#### Some Aspects of Basic Laryngeal Physiology

Material in this section can be found in Negus (1949) or in review articles (Pressman and Kelemen, 1955; Sawashima, 1970). Only material specifically from other sources is referenced below.

#### Valvular Closure

As already discussed, the larynx's basic function is to protect the lower respiratory tract. In higher species, this function is distributed over two or three levels. The highest of these, the aryepiglottic sphincter, serves mainly

as a lateral food channel, diverting liquids around the respiratory opening and excluding solid objects. At the lower level, the thyroarytenoid folds perform a more effective closure capable of maintaining a significant pressure difference between the upper and lower respiratory systems. In many species (including dogs and humans), the thyroarytenoid fold is split into a ventricular fold and a vocal fold, separated by the ventricle. The lower section, with flat top and domed bottom, is specialized as an inlet valve. The superior section is specialized as an outlet valve, with the flat side below.

#### Reflex Mechanisms

The peripheral sensors available for reflex mechanisms have been mentioned in the previous chapter. For purposes of sound production, there is acoustic feedback as well as that from touch and pressure receptors in the mucosa, stretch receptors in the muscles, and tension receptors in the laryngeal joints. It appears that proprioception from these latter receptors is responsible for coordinating the movements of the various laryngeal muscles (Kirchner and Wyke, 1965). Thus, for example, there might be a reflex adjustment of configuration for the sudden change of conditions that occurs at the onset of voice production.

The larynx behaves as if its two halves were controlled by a common source. All normal functions of the larynx are bilateral, and it is not possible to make voluntary



unilateral gestures with the normal larynx.

### Growth Patterns

The larynx of a child is relatively high in the neck compared to that of adults and the thyroid angle is more rounded. The vocal folds are not only shorter, but are proportionately smaller with respect to body size. The infant glottis is also relatively long compared to the diameter of the trachea. The adult female glottis is about as long as the tracheal width. Male laryngeal development is identical to female until puberty, when large changes occur. The vocal ligament may as much as double in length and the vocal muscle becomes generally more massive, so the adult male glottis is again longer than the diameter of the trachea. The thyroid cartilage grows forward and becomes more angulated. It is not clear whether the cracking of the voice while it is changing is due to inherent instability of the vibration patterns or due to loss of control. Growth of the female larynx at puberty is less dramatic than that of the male.

### Physiology of the Respiratory System

The respiratory system has been studied in detail from several aspects. Muscular control of respiration is achieved by expanding and contracting the thorax, due to expansion or contraction of the rib cage and/or movements of the diaphragm due to muscular activity in the diaphragm or in the abdominal wall. When the thorax expands, pressure becomes negative and

the lungs fill with air, while positive thoracic pressure tends to expel air from the lungs. Pressure in the lungs is the sum of the pressure in the thorax and the elastic recoil of the lung tissues. During deep inspiration, this recoil pressure can be as large as 30 to 40 cm. of water, and during the most extreme types of vocal behavior, even greater pressure may be used. For normal speech (or voice) production, however, lung pressure is maintained approximately constant at values typically in the range of 5 to 10 cm. of water. The respiratory muscles thus typically need to oppose passive deflation of the lungs at the beginning of a long utterance and support deflation at the end (Draper et al., 1959).

The DC aerodynamic resistance of the subglottal tract is on the order of 1 to 2 cm. water per liter second, and that of the supraglottal tract is less. The acoustic characteristics of the supraglottal tract have, of course, been investigated in detail by speech scientists. The acoustic impedance looking down the trachea from the glottis has been measured by van den Berg (1959b) and by Ishizaka (see Fant et al., 1972). Both investigators agree that the system can be modelled, to a rough first order, as a uniform tube terminating in a large volume at the distal end. This result is consistent with morphometric measurements of the lung airways (Weibel, 1964). However, the investigators disagree about the acoustic properties of the tube. Currently, Ishizaka's results indicating a first resonance at about

600 Hz. seem more tenable than van den Berg's, which indicated a resonance at 300 Hz. Both van den Berg's and Ishizaka's results show that the acoustic impedance at resonance may be 10 times its level at DC. According to Ishizaka's results, it may be as great as 50 acoustic ohms.

#### Elastic Properties of the Vocal Ligaments

Measurements of some of the elastic properties of the vocal folds in excised human larynxes have been reported by van den Berg and Tan (1959) and by Ishizaka and Kaneko (1968) (see also Kaneko et al., 1971). Van den Berg applied longitudinal forces of up to 300 grams to the vocal folds and to vocal ligaments alone. Some typical results are reproduced in Fig. 3-1. The abscissas for the plots of the vocal ligament data were normalized by the cross sectional area of the ligaments. According to van den Berg (1973) the indirectly measured cross sections varied from 1.0 to 3.5 mm<sup>2</sup>. The maximum extension was about 30 per cent of the rest length, and at this extension the ligaments became nonelastic. The curves of elongation versus tension for the ligament and for the entire fold were roughly similar over much of the range, indicating that in the excised preparation (with no vocalis activity) the ligaments were stiffer than the vocal muscle and surface tissues.

Ishizaka and Kaneko (1968) exerted medially-directed tension on a thread attached to the vocal ligament or to

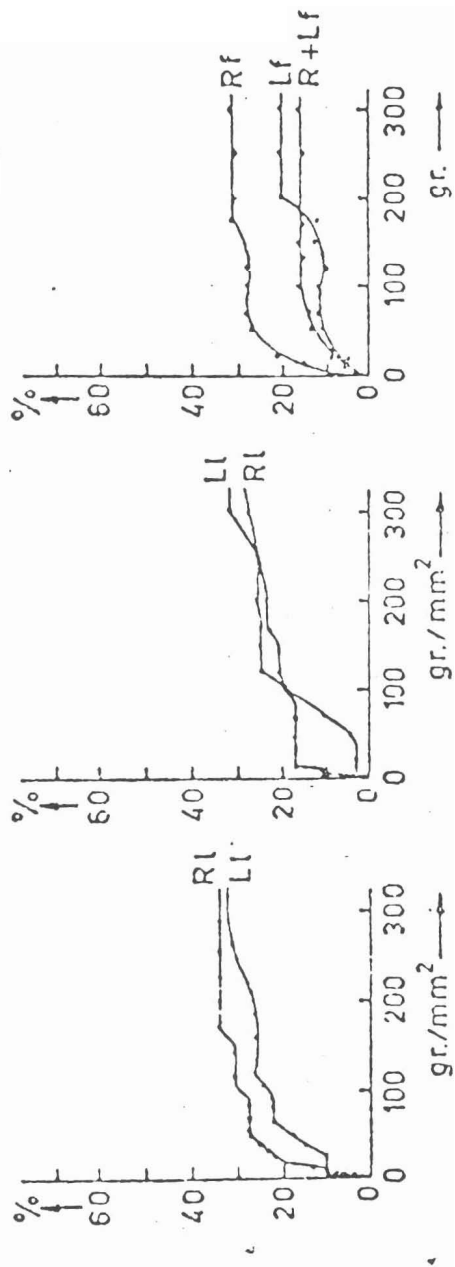

Fig. 2. Experiments with human larynxes. Elongation on account of a longitudinal force. Lf and Rf: vocal folds, left and right. Ll and Rl: vocal ligaments, left and right.

FIGURE 3-1

Elastic properties of the vocal folds. (from van den Berg and Tan, 1950).

the mucous membrane of an excised larynx that had been transected along the midline. The plot of their results is reproduced in Fig. 3-2. This plot also shows that the mucous membrane was less stiff than the vocal ligament.

The vocal ligament has been modelled as a string under tension in order to derive equivalent mechanical constants, both from van den Berg's data (Crystal, 1966) and from Ishizaka's (Ishizaka and Kaneko, 1968; Kaneko et al., 1971). Using this model, it is possible to compare the two sets of data. The longitudinal tensions in Ishizaka's experiments were equivalent to those in the leftmost range of van den Berg's curves. The rates of increase of tension with total length were about the same.

#### Contraction Properties of Laryngeal Muscles

Isometric tension of the thyroarytenoid muscle has been measured by Hast (1966), who found that the muscle in dogs was capable of exerting up to 300 grams force. The maximum isometric tension developed at a given length was a function of the length, reaching a maximum at about 30 per cent over the resting length. Thus, if van den Berg's measurements on dead humans can be compared to Hast's measurements on live dogs, the vocal muscle develops its maximal tension at the length where the vocal ligament is maximally stretched, and its maximum force is as great as that necessary to stretch the ligament to its maximum length.

Several investigators have examined temporal aspects

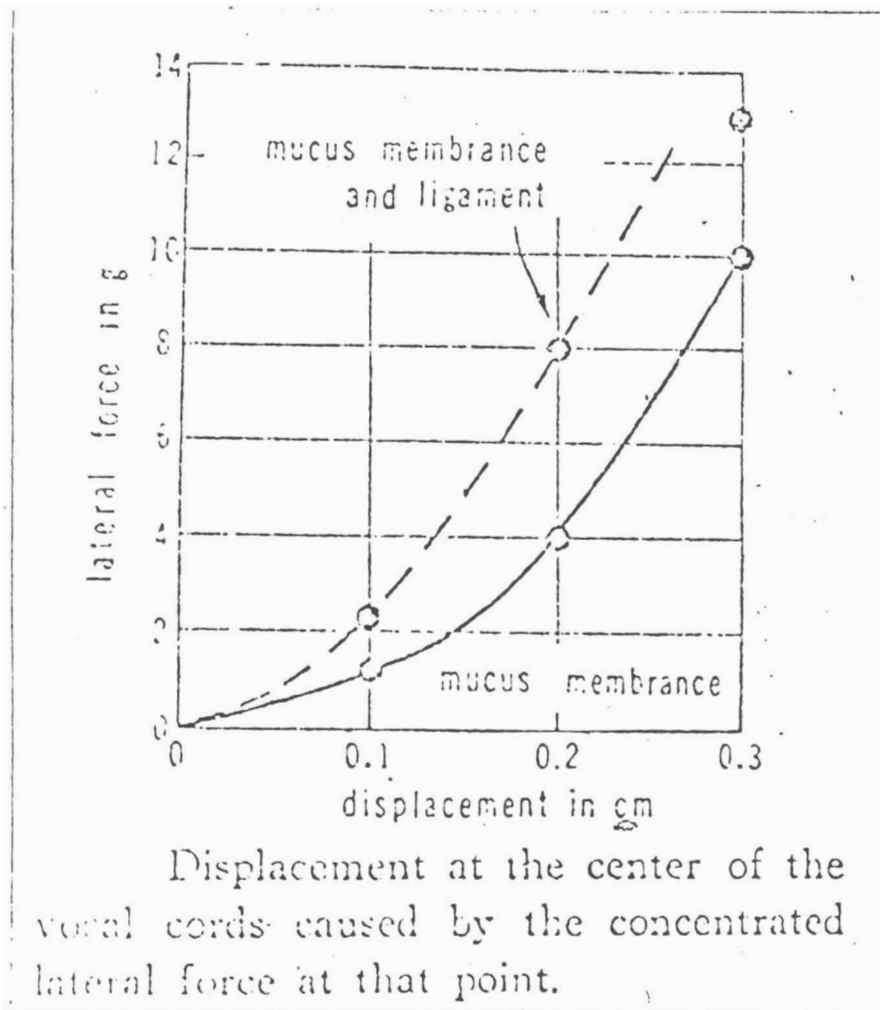

FIGURE 3-2

Elastic properties of the vocal folds. (from Ishizaka and Kaneko, 1968).

of contractions of the laryngeal muscles in various animals (Martensson and Skoglund, 1964; Hast, 1966; Hirose et al., 1969). Although there are some differences in the details from different investigators and different species, the following results seem generally true:

The contraction time (measured from beginning to peak of mechanical twitch) of the thyroarytenoid and lateral cricoarytenoid muscles - the adductor muscles - is of the order of 15 msec. That is, they are among the fastest muscles in the body, exceeded only by the muscles controlling eye movements. The cricothyroid and posterior cricoarytenoid, on the other hand, have contraction times on the order of 30 msec., which is comparable to fast skeletal muscles.

Fusion frequencies (i.e., electrical stimulation rates for which individual twitch responses first fuse into a smooth tetanus) of 100 per second (Hirose et al., 1969; Hast, 1969; Marakami and Kirchner, 1972) or even several times that (Martensson and Skoglund, 1964) have been reported. Nevertheless, investigators who observed the glottis while stimulating the laryngeal motor nerve observed that amplitudes of glottal movements were small (or zero) at shock rates equivalent to voicing frequency (and Marakami and Kirchner report that reflex closure cannot follow at shock rates above 10 per second). For this reason, as well as for some other very compelling reasons (e.g., Rubin, 1960) it is felt that

Husson's (1950) thesis of a centrally controlled "neuro-chronaxic" mechanism of phonation can be discarded.

Physiology and Mechanics of Voice Production

Sound production at the glottis may be due solely to the formation of turbulent airflow or to phonation. The former, which does not require any mechanical vibrations, includes whisper, aspiration, and whistle or flute register, in which - according to van den Berg (1968) - very high pitches are produced by exciting a cavity resonance with turbulence noise produced in the intercartilaginous chink. Here we are more interested in phonation, which always involves both mechanical vibrations of the vocal folds and flow of air between them.

By varying different adjustments, the voice can be produced anywhere within a continuum of fundamental frequencies (often more than three octaves), intensity levels (at least 30 dB at constant fundamental frequency, measured at the mouth), and qualities, and it is used to differentiate phonetic categories. However, there are clearly distinct modes of vibration associated with different frequency bands, having distinct acoustic and auditory correlates. Changes between these different modes of vibration are usually evident when an untrained singer attempts to sing a scale from the lowest to the highest tones he can produce. These different modes are called "registers".



There is much confusion concerning the number of different registers and their names. This is due not only to confusion about how sounds are produced but also because there is no general agreement whether registers should refer to the perceptual or acoustic properties of the sounds or the way they are produced. For our purposes, we will attempt to treat registers as physiological phenomena - different physiological states of the glottis having distinct acoustic and perceptual correlates.

It is generally agreed that chest (or "modal" register and falsetto represent distinct modes of phonation. Many authors also distinguish a mid-register - used especially by trained singers as a transition region between the former two (van den Berg, 1960). Other modes of phonation that might be recognized as registers are breathy voice or Strohbass and creaky voice or vocal fry.

#### Chest Voice (Main or "Modal" Register)

Chest register is the mode used for normal speaking and singing. It typically encompasses a range from 80 to 300 Hz. in adult males or 150 to 600 Hz. in adult females. To produce chest voice, the vocal folds are completely or nearly completely adducted (in the absence of airflow) and they are generally comparatively short and thick rather than stretched.

Fig. 3-3 shows some short exposure photographs of the glottis throughout one cycle of typical chest register phonation. The amplitudes of vibration are comparatively

## FIGURE 3-3

Short exposure photographs of male vocal folds at six phases in a glottal cycle. Fundamental frequency was 150 Hz. (from Smith, 1954).

1

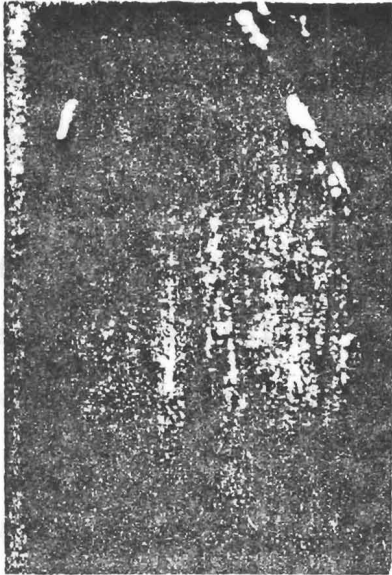

2

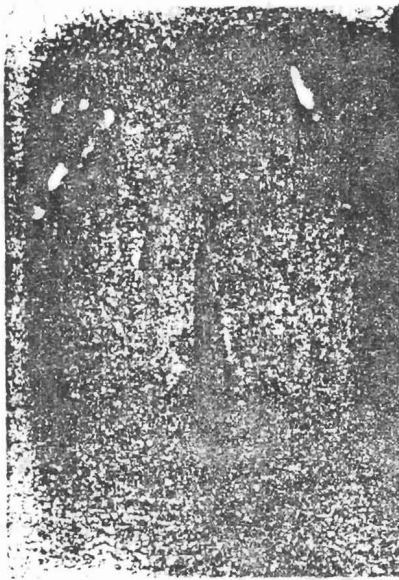

3

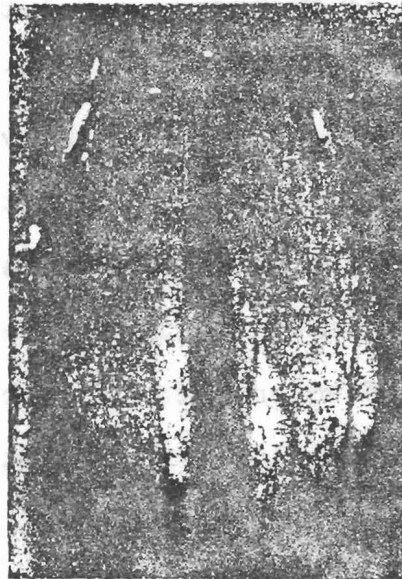

4

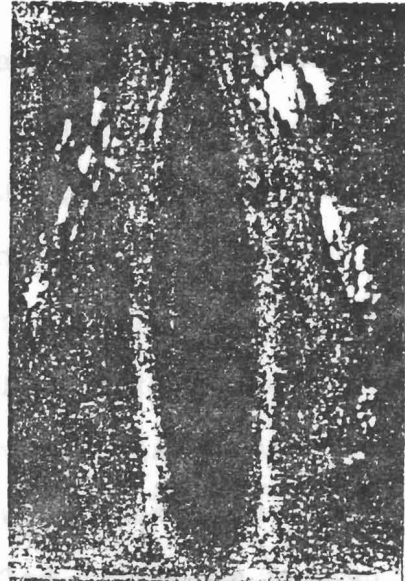

5

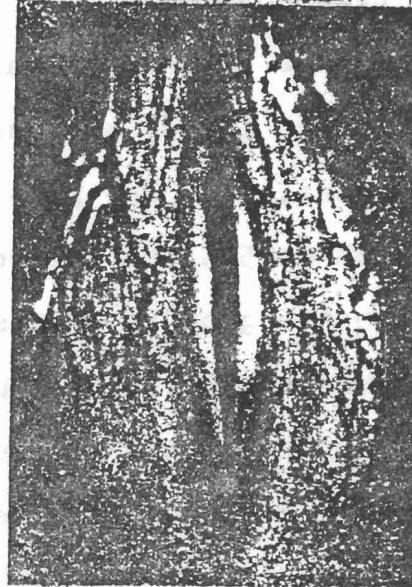

6

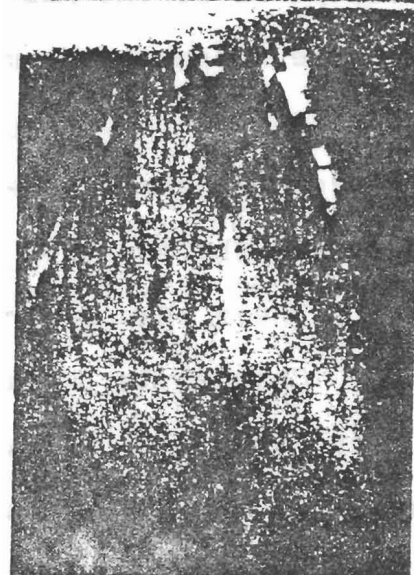

large. At its widest opening, the glottis is typically lozenge-shaped, with a maximum width as large as 4 or 5 mm. (Farnsworth, 1940) and a maximum area of about 30 mm<sup>2</sup>. (Flanagan, 1958). The vibrations involve much of the body of the vocal fold (i.e., the vocalis muscle) as well as the ligament, and the intercartilaginous glottis may also participate (i.e., the arytenoid cartilage may vibrate). The glottal walls appear to perform undulatory movements, with the inferior parts adducting and abducting before the superior parts. (Movements may also be nonuniform in the longitudinal dimension, but this effect is not as consistent as the effect in the vertical dimension.) The glottis closes for a significant part (as much as 50%) of each cycle. The airflow thus passes through the glottis in discrete puffs, or pulses.

When chest register phonation is initiated, the initial vibratory movements may be inward, if the glottis is initially open, or outward if the glottis is initially closed. Different aspects of the mechanisms of frequency and intensity control are discussed in more detail below. In general, as frequency is raised during sustained phonation, the vocal folds become longer, the amplitudes of vibration become smaller, and the relative duration of glottal closure decreases. These changes are due to the activity of various muscles. Changes in fundamental frequency can also be caused by changes of average subglottal or supraglottal pressure. As intensity increases, the amplitudes of vibration

may or may not increase, but the duration of glottal closure increases. These changes are probably caused by increase of subglottal pressure.

### Falsetto

The frequency range of the falsetto register is higher than that of the chest voice, though they may overlap. A typical range might be 250 to 500 Hz. for adult males or 500 to 1000 Hz. for adult females. To produce falsetto, the vocal folds are stretched to nearly their maximum adducted length and they are thus thin. Available evidence suggests that the vocal muscle is kept relatively relaxed, compared to production of the same frequencies in chest voice, so the ligament supports greater tension than the muscle.

During a typical cycle of falsetto phonation, the glottal shape is roughly a narrow rectangle and amplitudes of vibration are small. The vibrations are largely restricted to the vocal ligaments (not the muscles), and there is negligible vertical phase difference. During the cycle, the glottis is closed only briefly if at all, and the waveforms of glottal area and airflow are more nearly sinusoidal than pulsatile. In falsetto, fundamental frequency is probably controlled mainly by variation of tension in the ligament, and intensity is probably controlled largely by varying subglottal pressure.

### Other Registers

Mid-voice represents a mid region between chest register

and falsetto. Not all authors agree that such a register exists, and if it does, it is not clear how the vibration patterns are distinct from chest voice. In experiments with excised larynxes, as fundamental frequency was raised, van den Berg observed two distinct breaks in the vibration patterns which he attributed to register shifts from chest- to mid-voice and from mid-voice to falsetto (van den Berg and Tan, 1959). If there are distinct adjustments for chest and mid registers, it is entirely possible that experimental results taken from phonation erroneously characterized as chest or "modal" register might have led to some confusion. Such a possibility is suggested, for example, by the work of Atkinson (1973), who found an apparently different frequency control mechanism in the upper and lower frequency ranges of the speaking voice.

Breathy voicing, which is probably similar to the "Stroh bass" described by van den Berg, may be acoustically described by relatively low fundamental frequency, spectral distribution weighted more toward lower frequencies than chest voice, and possibly a noise component. It is produced with the vocal folds slack and with the glottis less adducted than chest voice. The intercartilaginous glottis may be chronically open, as it is when whisper is produced. The vocal folds may not meet at all during their vibratory cycle. Breathy voicing occurs in "soft" vocal attack. In some languages breathy voicing is used to convey phonetic

information (Ladefoged, 1964).

Vocal fry is the mechanism by which the lowest fundamental frequencies are produced (down to 20 Hz. or lower). The perceptual correlate of vocal fry is low pitch and harshness. Acoustically, vocal tract resonances excited by a glottal excitation die out before a succeeding excitation occurs (Hollien et al., 1966). The physiological adjustment for vocal fry seems to involve virtually unopposed contraction of the vocalis muscle, so that the vocal folds are short and thick and flaccid (McGlone and Shipp, 1971). Possibly the ventricular folds also vibrate. There are two possible vibration patterns in the vocal fry register (Hollien and Michel, 1968). In the first, the glottis opens once for only a small part of each cycle - i.e., the air seems to pass through the glottis in bubbles. Timke et al. (1959) have shown another pattern, where alternate glottal cycles differ in length, or there are two glottal pulses per cycle. In either case, the open frication is relatively small and the subglottal pressure is at least not greater than in chest voice (McGlone and Shipp, 1971), so the airflow rate is small.

Like breathy voicing, vocal fry might be considered pathological if it occurs chronically. However, it occurs commonly in English speech at the end of a sentence.

### Chest Voice and Falsetto in More Detail

The purpose of this section is to briefly describe some results obtained with the experimental techniques enumerated in the beginning of this chapter.

#### Laryngoscopy, Glottography, and Radiography

Stroboscopic and high-speed films are the main source of descriptions of the "vertical phase difference". It is useful to point out that these observations are limited - especially since the view of the inferior parts of the vocal folds is impeded during much of the glottal cycle, and also since the image is not stereoscopic. These films show that the glottal surfaces sometimes have a concave shape known as a "sulcus" during part of the cycle (Smith, 1954). They also show that a wave passes across the superior surface of each vocal fold in the lateral direction after glottal opening (van den Berg, 1958).

High speed films of vocal initiation have shown that the initial adjustment from the breathing position occur over a period of typically 150 msec. prior to the initiation of vibrations. In this type of vocal attack, the initial vibratory movements can be inward. Generally, closure does not occur in the first vibratory period. Rather, the vibrations build up over a period of several cycles (typically 4 in normal attack - before reaching steady state).

The "glottal area" waveform during steady phonation has been systematically studied using high speed films and



photoglottograms. Two useful abstracts of these records are open quotient (the fraction of the glottal cycle during which the glottis is open) and speed quotient (the ratio of opening time to closing time during the open part of the cycle). These results are effectively summarized by Sonesson (1960). Open quotient varies between about 0.4 and 1.0. It decreases with increasing intensity and increases with increasing frequency. However, open period (the actual duration of the open part of the cycle) decreases with increasing frequency. Speed quotient varies less systematically than open quotient. It is roughly independent of fundamental frequency, but increases slightly as a function of intensity. It is generally near unity.

Both film studies and lateral x-ray studies show a correlation between glottal length and fundamental frequency (see review in Sawashima, 1970; and articles by Hollien and associates). Glottal length generally increases as fundamental frequency increases in chest register (although the relationship is not always monotonic) but there is little change in glottal length in falsetto. The total increase in vocal fold length is about 25 to 30% of its low-frequency length. Hollien (1960) and Hollien and Moore (1960) report that the glottal length in abducted position (breathing) is greater than the maximum length during phonation. It is possible that this result is an artifact of their measure-

ment scheme (from cine-photographs), since it disagrees with the results of radiographic measurements (e.g. Sonninen, 1968). Glottal length is not correlated with vocal intensity at a given frequency.

Hollien and Colton (1969) and Hollien and Coleman (1970) studied cross-sectional area and vertical thickness of the vocal folds, using conventional and stroboscopic frontal laminagrams. Thickness was defined to be area divided by lateral width during closure. Thickness decreases as fundamental frequency increases in chest voice but is roughly constant in falsetto, as could be predicted from the length data. Although the data from individuals exhibit a great deal of variability, the group data suggest that vocal fold thickness is closely related to fundamental frequency control. It was observed in at least one set of group data that the results for males and females, which fell into different but overlapping ranges, seemed to lie on nearly the same curve.

Various techniques, including radiographic methods and measurements with "thyrometers" (Kakita and Hiki, 1972; Vanderslice, 1967) show a general correlation between larynx height and fundamental frequency in speech and singing - especially for untrained singers. Sonninen (1956) also showed that there are anterior movements of the thyroid cartilage, and that most of the movement about the cricothyroid joint involves rotation of the cricoid cartilage

rather than the thyroid.

### Electromyography

An early result of EMG studies was the observation that EMG activity associated with the initiation of phonation preceded this initiation by generally more than 100 msec., and most often 350 to 550 msec. More sophisticated analysis of EMG activity during speech production also showed a delay between the activity of individual muscle and their corresponding effect on the fundamental frequency contour equivalent to their contraction times (Atkinson, 1973).

A summary of the results of EMG studies with respect to fundamental frequency and intensity control (as well as control for speech gestures) can be found in Sawashima (1970). EMG activity in the adductor muscles (vocalis, lateral cricoarytenoid, interarytenoid) and the cricothyroid muscle is generally associated with the control of voicing. For sustained phonation in chest register, activity in all these muscles generally increases as fundamental frequency is increased. At the highest fundamental frequencies, the posterior cricoarytenoid may also become active, serving as a tensor in opposition to the cricothyroid. The interarytenoid muscle is not normally active during sustained phonation. Whether there is any correlation between laryngeal muscle activity with intensity is unclear. The shift from chest (or mid-) voice to falsetto at a given fundamental frequency appears to be accomplished by reduction

of vocalis muscle activity. There may be a small reduction in cricothyroid activity, consistent with a decreased need to oppose vocalis tension in order to maintain tension of the vocal ligament. Thus, chest voice seems to require tension of both the vocal ligament and the vocalis muscle, while in falsetto only the ligament should be tensed. However, the function of vocalis tension in chest voice is unclear.

As frequency increases in falsetto, cricothyroid activity reaches a maximum and does not increase further. Extrinsic muscles are then responsible for further increases in fundamental frequency. In general, the extrinsic muscles may be responsible for both high and low extremes of fundamental frequency. However, the mechanisms of this control are controversial.

The issue of how fundamental frequency is lowered is also controversial. There are at least four proposed mechanisms: lowering due to relaxation of the muscles and/or subglottal pressure responsible for raising pitch, pitch lowering due to the ability of certain intrinsic muscle to shorten the vocal folds, lowering caused by a decrease in transglottal pressure produced by constriction of the supraglottal sphincters (Lindquist, 1969; 1971); and reduction in "vertical tension" of the surface tissues of the vocal folds, due to lowering of the larynx (Ohala, 1972). Of course, all or some of these mechanisms might operate

together or at different times.

#### Airflow and Pressure Measurements

Average subglottal pressure during phonation may be as low as about 2 cm. H<sub>2</sub>O for low frequency chest register (Bouhuys et al., 1962; Lieberman et al., 1969) and possibly lower for vocal fry phonation (Murry and Brown, 1971). Minimum subglottal pressure for higher fundamental frequencies is greater. The highest subglottal pressures used for phonation are on the order of 50 to 60 cm. H<sub>2</sub>O (Bouhuys et al., 1968; van den Berg, 1962). During conversational speech, subglottal pressures of 5 to 10 cm. H<sub>2</sub>O are common.

Subglottal pressure and vocal intensity are related. Isshiki (1964) found that intensity vs. subglottal pressure at constant pitch was roughly proportional to the 3.3 power of subglottal pressure. Other investigators obtained similar results (Bouhuys et al., 1968; van den Berg, 1956; Ladefoged, 1962).

Increases in subglottal pressure with other parameters held constant also affect fundamental frequency, but there is disagreement concerning the magnitude of this effect. Van den Berg (1957), Ohman and Lindqvist (1965), and Ladefoged (1967) all report experiments in which subglottal pressure was changed rapidly by pressing unexpectedly on the chest of a phonating subject. The purpose of this experiment is to remove control of subglottal pressure from

the subject and to record the vocal response before reflex adjustments could be made. The rates of change of fundamental frequency with respect to subglottal pressure from these experiments were 5 Hz./cm. H<sub>2</sub>O, 1.5 to 3 Hz./cm. H<sub>2</sub>O, and 5 cm. H<sub>2</sub>O, respectively.

Lieberman et al. (1969) also modulated transglottal pressure, by sinusoidally varying supraglottal pressure. Changes of 3 to 18 Hz./cm. H<sub>2</sub>O were found. However Hixon et al. (1971) tried to replicate these experiments using one of the same subjects. Varying either subglottal pressure or supraglottal pressure, rates of only 2-4 Hz./cm.H<sub>2</sub>O were produced. These results were obtained both for steady phonation and during the production of phonetic segments. Other estimates as high as 20 Hz./cm. H<sub>2</sub>O have been reported (Lieberman, 1967), but in these measurements it is unlikely that the configuration of muscle activity was held constant as subglottal pressure varied.

Average airflow rates during the production of sustained tones in chest voice are generally in the range of 100 to 200 cc./sec. For low fundamental frequencies, airflow rate increases little or even decreases as intensity is raised (Isshiki, 1964). This is due to the fact that open quotient decreases as subglottal pressure increases. At higher fundamental frequencies, flow rate increases with intensity. In falsetto, flow rates are generally in the range of 50 to 100 cc./sec., and they increase almost

linearly with subglottal pressure. Abnormal airflow rates are frequently associated with laryngeal pathology and are hence a useful diagnostic tool (Hirano et al., 1968).

Subglottal pressure variations during a glottal cycle were measured directly by van den Berg (see van den Berg, 1962) in a patient with a tracheal stoma and a normal larynx. Peak-to-peak variations of about 1 to 1 1/2 cm. H<sub>2</sub>O were recorded. Preliminary measurements with a miniaturized pressure transducer lowered through the glottis of a normal subject (Koika and Perkins, 1968; Hiki et al., 1970) indicate that the peak-to-peak amplitudes may be at least as great as 3 cm. H<sub>2</sub>O. The waveforms obtained in both sets of measurements showed a ringing component at a frequency which seems to correspond to the first subglottal resonance, as measured by Ishizaka (see Fant et al., 1972). A similar component was noted in the waveform obtained from an accelerometer attached to the external skin surface near the trachea (Henke, 1974).

The glottal volume velocity waveform has never been measured directly. Estimates of the waveform obtained by inverse filtering (e.g. Mathews et al., 1961; Holmes, 1963; Rothenberg, 1973) show that the glottal pulse is typically symmetric at low intensities with peak flow rates of typically 500 cc./sec. As intensity is increased, the pulse becomes skewed. Its falling phase becomes more sharp and

shorter than the opening phase, and there is a slope discontinuity at the end of this phase.

#### Experiments with Excised Larynxes and Live Animals

With excised human larynxes, van den Berg independently controlled airflow rate and configuration of the laryngeal cartilages to examine their effect on phonation (van den Berg and Tan, 1959; van den Berg, 1960, 1968). The effect of these parameters on the production of different registers and on the variation of vibration patterns within registers was studied.

In van den Berg's experiments, the larynx was attached to a pseudosubglottal system which supplied air at regulated flow rate. (All experiments by other investigators with excised larynxes and animals utilizing artificial air supplies also used airflow rather than pressure regulation.) The cricoid cartilage was fixed to a rigid support. A thread attached to the thyroid notch could exert longitudinal tension on the vocal folds. Different methods were used for controlling the configuration of the arytenoid cartilages. These methods are illustrated in Fig. 3-4. In early experiments, from which most of the detailed reported results were obtained, the arytenoid cartilages were either fixed separately with threads to the rigid support or were connected by a single thread. Adductory force was applied directly to the cartilages, as shown in part A of Fig. 3-4. In later experiments, threads were attached to the



## FIGURE 3-4

Experimental methods of van den Berg.

- A. (from van den Berg and Tan, 1959).
- B. (from van den Berg, 1960c).

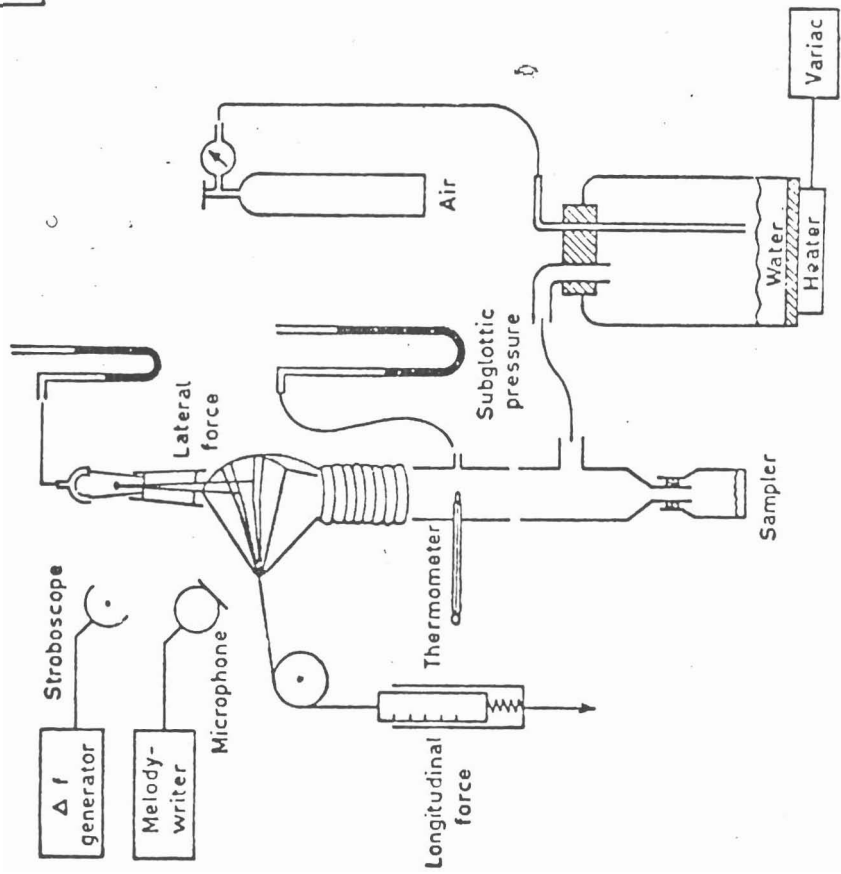

A. Experiments with human larynxes. Method.

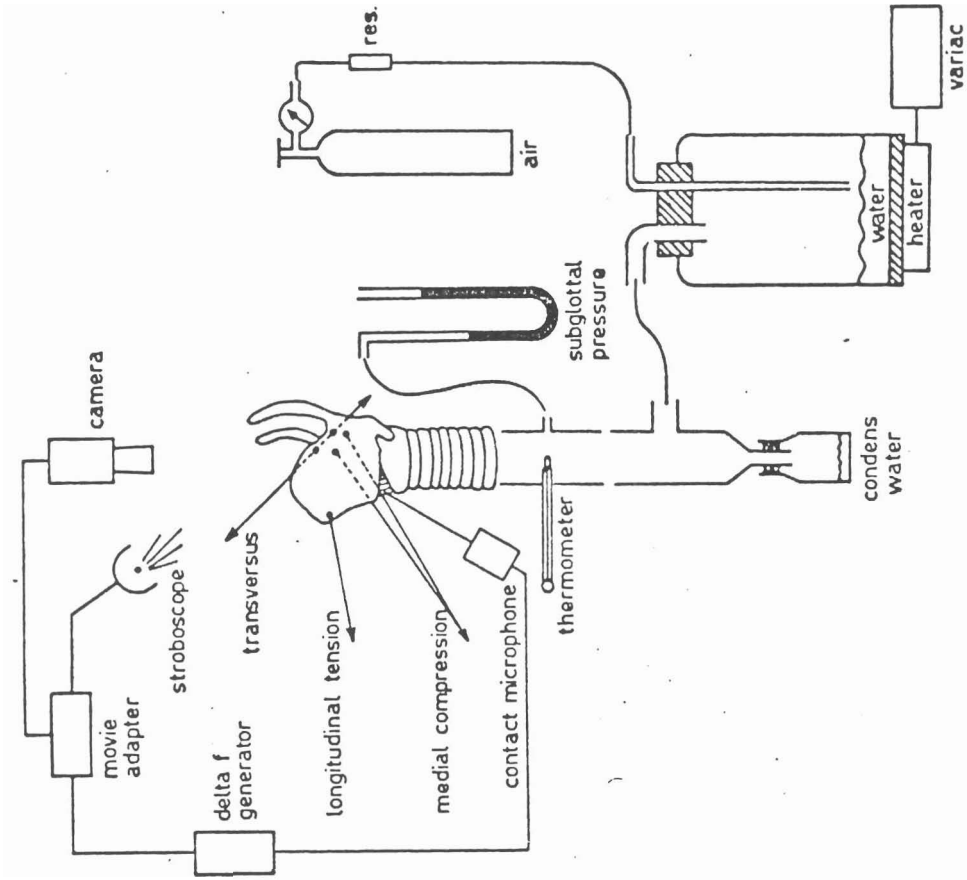

B. Scheme of the experimental arrangement

interarytenoid and adductor muscles and were used to exert tension parallel to the muscles, as shown in part B of the figure.

Van den Berg found that excised larynxes could produce all the vocal registers. Longitudinal tension of the vocal folds was primarily responsible for determining the register and was also primarily responsible for controlling fundamental frequency within the register. Although manipulation of the vocalis muscle was not necessary to produce all the registers, the frequency range in chest and mid register could be increased by compressing the alae of the thyroid cartilage. Van den Berg asserted that this procedure, which limited the lateral vibrations of the ligament, was equivalent to tensing the muscle.

For chest voice, van den Berg found minimum subglottal pressure levels of 2 to 3 cm.  $H_2O$  and minimum flow rates of only 30 or 40 cc./sec. For apparently normal voice production, maximum flow rate was 400 cc./sec. and maximum subglottal pressure was about 40 cm.  $H_2O$ . Fig. 3-5 shows van den Berg's curves relating flow rate, subglottal pressure, and fundamental frequency for a larynx producing chest voice as flow rate was varied. Variations of fundamental frequency with subglottal pressure were not linear, but were generally in the range of 5 to 8 Hz./cm.  $H_2O$ . The thyroid cartilage could have moved somewhat during these

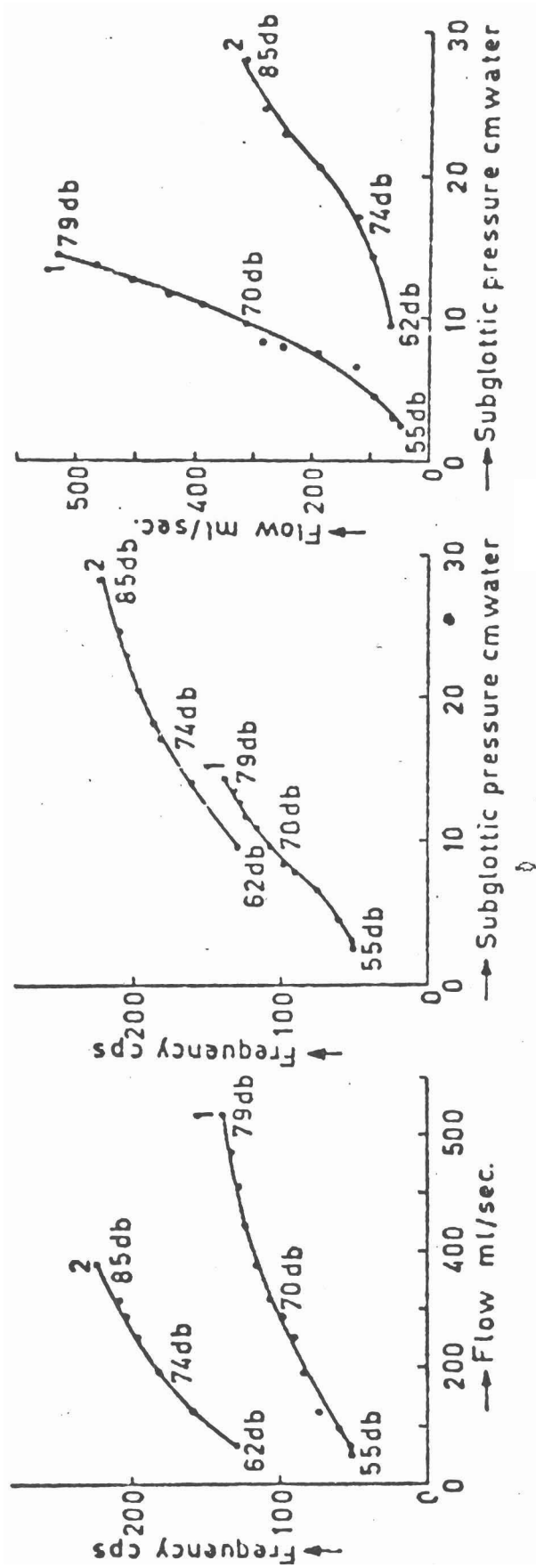

Experiments with human larynxes. Chest voice. Relations between the fundamental frequency, flow and subglottic pressure. 1: small lateral forces, 2: large lateral forces.

FIGURE 3-5

Relationships between flow rate, subglottal pressure, and fundamental frequency in an experiment with an excised human larynx. (from van den Berg and Tan, 1959).

measurements.

With stroboscopic illumination, van den Berg noted that there were vertical phase differences in the vibrations of the vocal folds. During the open period, a wave was seen to travel across the superior surface of the folds. Open quotient generally increased as longitudinal tension increased, but decreased with increases in flow rate. The vertical extent of the contacting area of the vocal folds during the closed period was found to increase from a minimum of about 1 mm. to a maximum of about 3.5 mm. as flow rate (and hence subglottal pressure) was increased.

Van den Berg noted some effects of acoustic coupling to the subglottal tract. When the first acoustic resonance of the tract was too sharp, larynxes were not able to phonate at the resonance frequency.

An excised-larynx experiment similar to van den Berg's was reported by Anthony (1968). In chest voice with a larynx producing fundamental frequencies of 350 to 600 Hz., fundamental frequency varied with subglottal pressure at a rate of 7 Hz./cm. H<sub>2</sub>O with longitudinal tension held constant. Large changes of fundamental frequency could be produced by varying longitudinal tension.

Excised larynx experiments were also reported by Hiroto (1966) and by Matsushita (1969). Matsushita studied the vibrations with high-speed cinematography. He showed pictures of the vibrations from the subglottal aspect,

systems. With electrode stimulation, phonation in different fundamental frequencies could be produced. Stimulation of the cricothyroid muscle produced large changes in fundamental frequency. Stimulation of the vocal muscle also produced changes in fundamental frequency, but this effect was smaller. All investigators found a linear relationship between subglottal pressure and intensity (in dB) similar to that found for normal human phonation. All but Rubin found a correlation between fundamental frequency and flow rate (subglottal pressure).

Chapter 4 Models of the Phonatory Mechanism

The purpose of this chapter is to discuss the development of models of the phonatory mechanism and to indicate their limitations.

The myoelastic-aerodynamic theory (van den Berg, 1958) accounts for the general framework of this mechanism. Subglottal pressure and glottal airflow give rise to aerodynamic forces on the walls of the vocal folds, setting them into vibration. These mechanical vibrations in turn modulate the flow, changing the aerodynamic forces and producing periodic acoustic energy. To describe this mechanism in detail, it is thus necessary to account for both the aerodynamic properties of the glottis and the mechanical properties of the vocal folds.

Early modelling efforts did not attempt to account for the origin of the vibrations, but were rather concerned with the control of fundamental frequency and intensity. For example, Woods (1892) applied the theory of vibrating strings, explaining changes of fundamental frequency in terms of manipulation of the natural frequency of the vocal "cords". The first mechanistic model was studied by Wegel (1930). Wegel hypothesized a mechanical system consisting of elastically hinged masses, and he analyzed its interaction with a model of the aerodynamic system. Recognizing that the mechanism of phonation involved mutual feedback paths, Wegel set up equations describing his model and made an analogy

to the theory of vacuum tube oscillators.

Following Wegel's work, little modelling work was done until after the advent of high-speed cinematography. Farnsworth's (1940) observation that initial vibratory movements could be inward, and Husson's subsequent formulation of the neurochronaxic theory revived interest in explaining the mechanism of phonation.

#### Development of the One-Mass Model

By modelling the glottis as a uniform rectangular orifice, as shown in Fig. 4-1, it is possible to predict the form of its aerodynamic properties on the basis of standard fluid-mechanics theory. (See, for example, Kaufman, 1963). The Bernoulli effect can produce negative glottal pressures. Resistance to static flow is generally of the form

$$\Delta P = R_v U + R_k U^2$$

where  $P$  is the pressure drop across the glottis and  $U$  is the volume velocity of flow through it.  $R_v$  accounts for viscous losses along the length of the glottis and  $R_k$  accounts for losses from the ideal Bernoulli relations at the glottal junctions. In the ideal case, the Bernoulli pressure drop

$$P_B = \rho U^2 / 2A_g^2$$

(where  $\rho$  is the density of air and  $A_g$  is the cross sectional area of the glottis) would occur at the junction with the



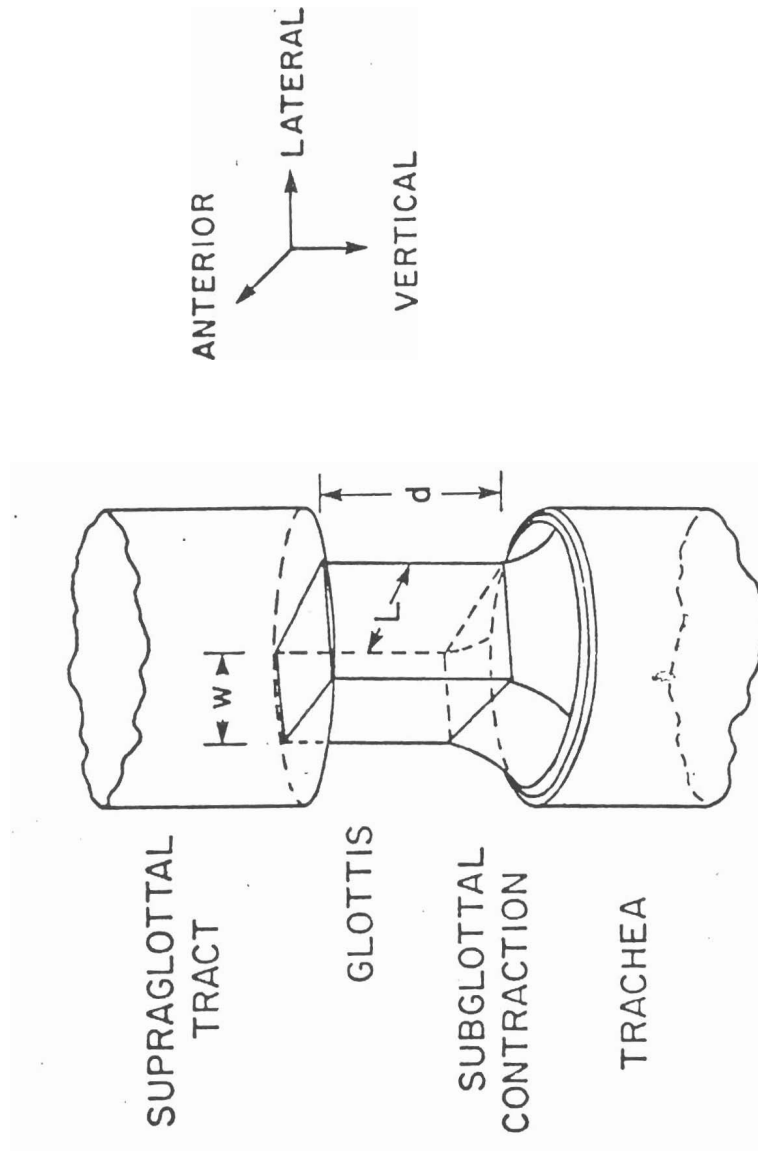

FIGURE 4-1

Model of the glottis as a uniform rectangular orifice. The area of the glottis,  $A$ , is equal to  $L \times W$ .

trachea and there would be subsequent recovery of the same pressure difference at the exit into the vocal tract. More precisely, however, the pressure drop at the upstream contraction is  $(1 + K_c)P_B$  and the recovery at the downstream expansion is  $(1 - K_e)P_B$ . At the gradual contraction, the loss component  $K_c$  is due partly to the formation of a vena contracta, or constricted flow, slightly past the junction. Since the apparent cross dimension of the glottis is thus reduced at its entrance, the pressure drop is increased and the additional drop is not recovered when the flow subsequently expands. At the sudden expansion, the loss component  $K_e$  accounts for the fact that the flow cannot immediately expand and that it loses energy when it does so. The form of the pressure distribution is thus as sketched in Fig. 4-2.

Van den Berg et al. (1957) made measurements on a plaster model of the larynx with a uniform rectangular glottis of varying width. The model was formed by making a plaster cast of a fully adducted excised larynx, separating it at the midline, and reconnecting the two halves with varying-width spacers between them. The model thus maintained some properties of the real larynx while having a simplified representation of the glottis. The results of these experiments showed that flow through the glottis was essentially laminar for most glottal widths and subglottal

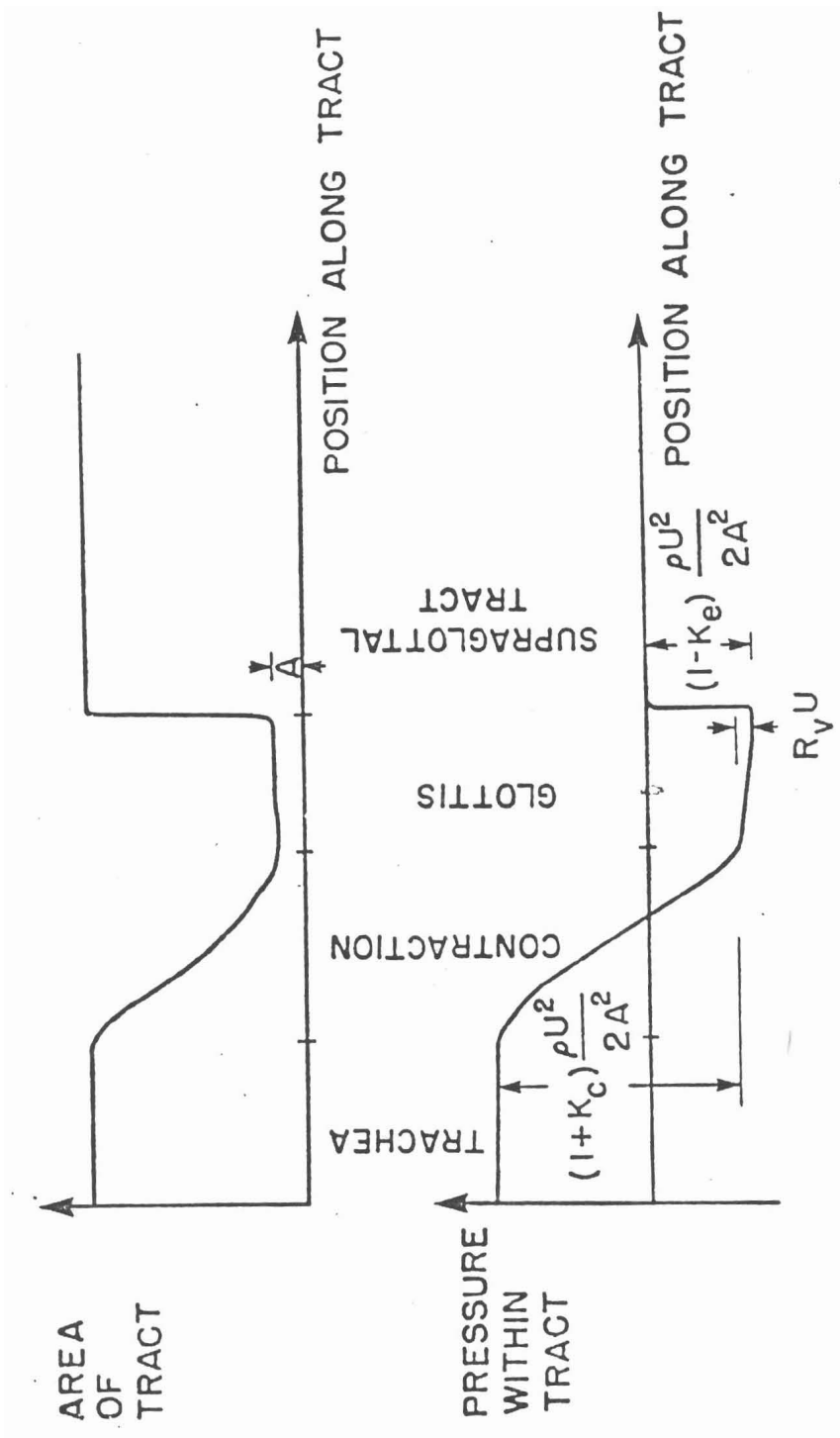

FIGURE 4-2

Theoretical form of the pressure drop in the model of the glottis shown in Fig. 4-1.

pressures encountered during normal voice production, and that the viscous resistance component,  $R_v$ , was well approximated by simple theoretical calculations. The kinetic loss coefficients,  $K_c$  and  $K_e$  were found to be 0.37 and 0.50, respectively, so that the kinetic loss,  $R_k U^2 = (K_c + K_e) \rho U^2 / 2A_g^2$  was equal to  $0.87 \rho U^2 / 2A_g^2$ . Comparison of the kinetic and viscous terms indicated that, for values of subglottal pressure in the speech range, the kinetic term dominates for values of glottal width greater than about 0.4 mm. The average pressure in the glottis is thus apparently negative until glottal width becomes very small. Neglecting the viscous term, the glottal pressure is  $-0.5P_B$ .

Flanagan (1958) and Crystal (1966) also took into account the time varying aspects of the model, due to both time varying flow and time varying glottal volume. Both inertance of glottal air and displacement of glottal volume were found to be significant only for very small glottal widths. Thus, a quasistatic model was found to be adequate for most of the glottal cycle.

Flanagan (1958, 1968) used these aerodynamic relationships to predict the volume velocity waveform given the glottal area waveform (measured from high speed films) and the value of subglottal pressure. Because of the non-linear relationship between glottal area and aerodynamic resistance, the glottal volume velocity waveform was found to be sharper than the area waveform.

The value of differential glottal resistance,  $R_v + 2R_k U$ , is typically 80-100 acoustic ohms. For maximum glottal areas during phonation, differential resistance is on the order of 30 ohms. The input impedance of the vocal tract becomes about that great near its first formant frequency. Thus, acoustic interaction between the glottis and the vocal tract was predicted for spectral components near the first formant frequency (Crystal, 1966; Flanagan, 1968). This interaction was found to offset the glottal flow waveform, but normally not the mechanical vibrations of the folds. However, effects on these vibrations can be noted when the formant frequency is reduced to near the fundamental frequency by having a subject phonate into a tube (Ishizaka et al., 1968).

Van den Berg et al. (1957) asserted that there was little acoustic effect of the subglottal tract. From both theory and measurements (van den Berg, 1962), peak-to-peak subglottal pressure variations during a glottal cycle were found to be about 5% of the mean subglottal pressure. However, the theoretical estimates were faulty, since they were based on DC resistance rather than acoustic impedance of the subglottal tract. Ishizaka's measurements of subglottal impedance (see Fant et al., 1972) show that the magnitude of this impedance can equal that of the glottis (for part of the glottal cycle) at frequencies near the

first subglottal resonance frequency, so some acoustic effect would be expected. Measurements of subglottal pressure by Hiki et al. (1970) suggest that the amplitude of the subglottal pressure waveform can be at least as great as that of the supraglottal pressure waveform and may be a few cm. H<sub>2</sub>O. There is also other indirect evidence that the subglottal formant is strongly excited at glottal closure (for example, Henke, 1974). Thus, there may be considerable variations in vertical forces on the vocal folds during the glottal cycle.

A simple one-mass model of the vocal folds was studied by Crystal (1966) and by Flanagan (Flanagan and Landgraf, 1968; Flanagan, 1969) in order to account for the effects of van den Berg's intraglottal pressure distribution on the vocal folds. The model of the vocal folds was a simple mechanical oscillator, as shown in Fig. 4-3. The form of this model was dictated by analytic simplicity and by the lack of a better form. It was apparently considered to be equivalent to a vibrating string, at least for the purpose of deriving its mechanical constants from physiological data.

To analyze the model, bilateral symmetry was assumed, so that calculations were made for only one vocal fold. The model basically accounts only for the part of the cycle in which the vocal folds are not in contact. Thus, Crystal (1966) analyzed only the open period of the glottal cycle.

vocal tract

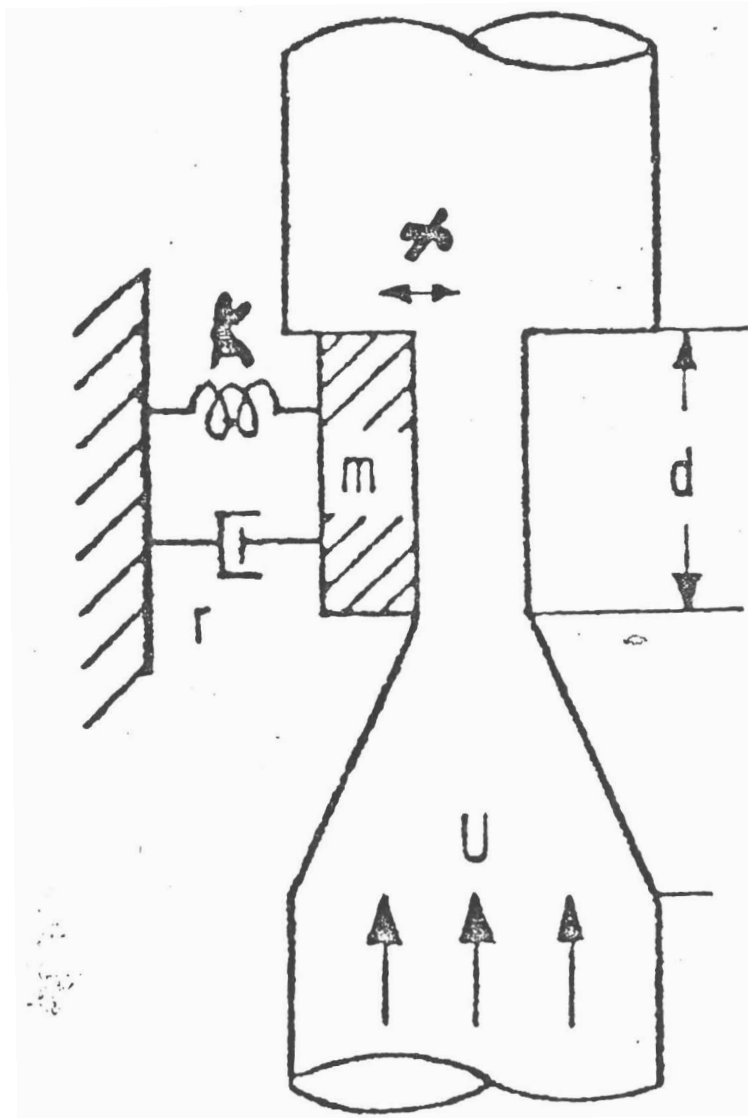

lungs

FIGURE 4-3

One-mass model of the larynx. (from Ishizaka and Matsudaira, 1968).

Flanagan and Landgraf (1968) and Flanagan (1969) developed an ad hoc model for the closed period. The masses were allowed to move past the midline (i.e. to penetrate into each other, but at the midline the mechanical properties were changed (stiffness and/or damping increased). This model of the collision may be considered to account for the dissipation of energy within the body of the folds.

If the quasistatic aerodynamic model of the glottis is used and if the pressure above and below the glottis is assumed to be constant, the one mass model cannot produce oscillations unless the mechanical losses (the viscous damping) are neglected, since there is no mechanism for the aerodynamic system to provide energy to the mechanical system. The intraglottal pressure,  $P_g$ , is a function only of the mass displacement  $x(t)$ . The work done by the pressure throughout a cycle is proportional to  $\oint P_g dx$ , the area of the trajectory of the vibrations in the  $P_g$ - $x$  plane. As long as  $P_g$  depends only on  $x$ , this trajectory is a straight line and its area is zero. Thus, with mechanical losses, the model cannot oscillate unless either dynamic glottal effects or acoustic coupling to the vocal tract or subglottal tract shift the  $P_g(t)$  waveform with respect to the  $x(t)$  waveform. Furthermore, even the lossless mechanical model cannot vibrate if its acoustic load has capacitive rather than inductive reactance (that is, if the first formant frequency



is lower than the fundamental frequency).

### Development of the Two-Mass Model

The one-mass model was inadequate at least in its inability to phonate under adverse acoustic loads and also since it could not produce different registers. The model of the glottis did not account for the vertical phase differences known to occur during normal phonation, and the model of the vocal folds did not allow a differential response to the variations in pressure along the vertical extent of the walls. A more fundamental objection was voiced by Ishizaka and Matsudaira (1968), who challenged van den Berg's aerodynamic model. On the basis of fluid mechanics theory and measurements on a rigid glottal model, they argued that the loss component  $K_e$  at the junction with the vocal tract was given by

$$K_e = 1 - 2N - 2N^2$$

where  $N$  is the ratio of glottal area to that of the vocal tract. Since  $N$  is small during phonation, they found that  $K_e$  was nearly unity rather than 0.5, and so the negative glottal pressure  $(1-K_e)P_B$  was smaller than predicted by van den Berg.

Ishizaka and Matsudaira argued that the vertical phase differences were aerodynamically significant, and that a model in which motions of the superior and inferior sections of the vocal fold were offset in time would not only better

represent the shape of the real glottis but would also account for the mechanism of phonation. They thus considered a model of the glottis consisting of two uniform slits in series, as shown in Fig. 4-4. The corresponding mechanical system consisted of two simple mechanical oscillators coupled by a spring.

The simple aerodynamic model of the one-section glottis was extended to the two-section model by applying Bernoulli's equation without losses to the junction between the sections. The equation for aerodynamic resistance can then be rewritten

$$\Delta P = R_{v1} U + K_c \rho U^2 / 2A_1^2 + R_{v2} U + K_e \rho U^2 / 2A_2^2$$

where  $R_{v1}$  and  $R_{v2}$  represent the viscous resistance of the inferior section and the superior section, respectively, and  $A_1$  and  $A_2$  are the cross sectional areas of the two glottal sections. It should be noted that the resistance depends unequally on  $A_1$  and  $A_2$ . This fact may explain why the volume velocity waveforms derived by inverting filtering are more skewed than those obtained from glottal area calculations. "Glottal area" is actually the minimum of  $A_1$  and  $A_2$ , and so resistance may be greater during the opening part of the cycle (when  $A_2$  is smaller) than during the closing part of the cycle (when  $A_1$  is smaller).

If only static aspects of the aerodynamic model are considered, and, as a further simplification, if viscous

## FIGURE 4-4

Two-mass model of the larynx. (from Broad, 1973).

Vocal tract

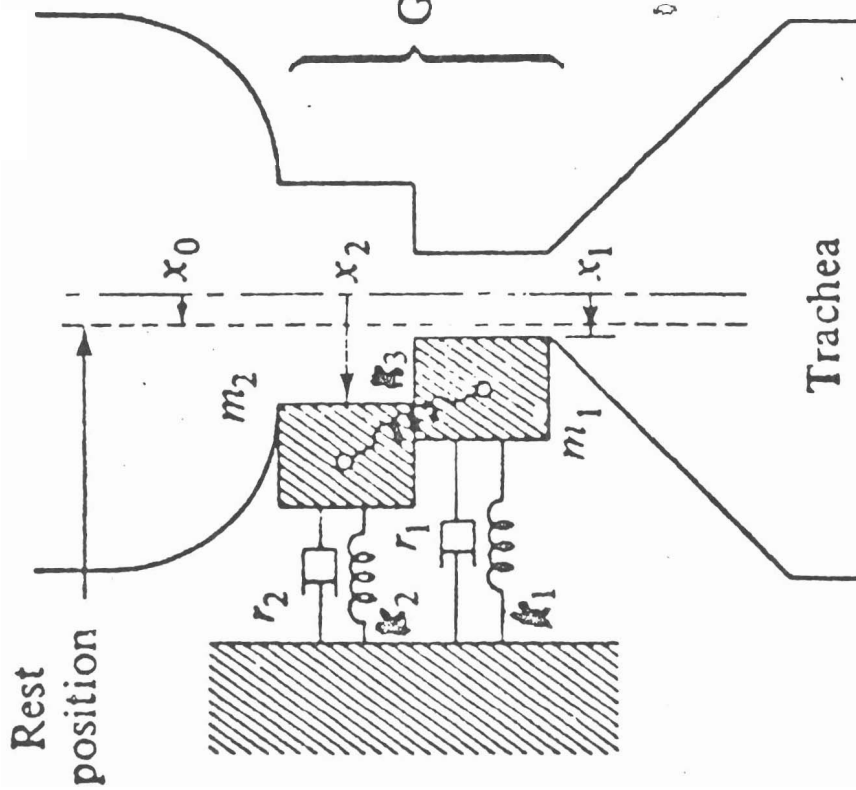

Frontal view

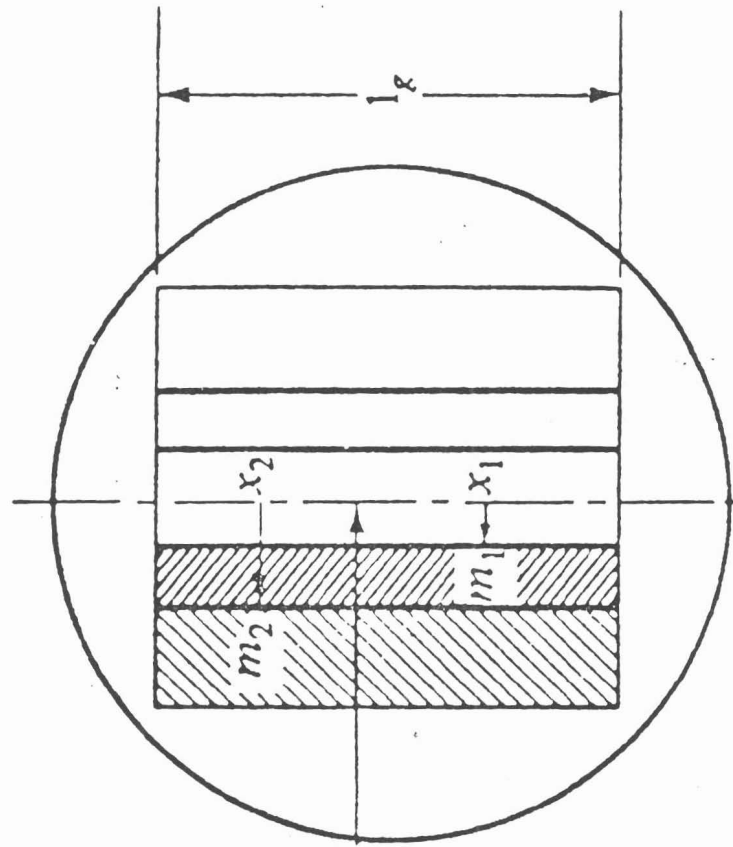

Top view

terms are ignored, the pressure,  $P_2$ , in the superior section is  $-(1-K_e) U^2/2A_2^2$  and the pressure,  $P_1$ , in the lower section is  $\frac{-\rho U^2}{2A_1^2} + K_e \frac{\rho U^2}{2A_2^2}$ . This latter equation shows that there is aerodynamic coupling between the two sections of the glottis. Given  $U$ , the pressure  $P_1$  can be either positive or negative depending on the relative values of  $A_1$  and  $A_2$ . Thus, the Ishizaka and Matsudaira value for  $K_e$  accounts not only for less aerodynamic effect directly on the superior section than van den Berg's (since  $P_2 = 0$ ), but also greater aerodynamic coupling between the two sections. The aerodynamic forces do no work directly on mass 2. Assuming that mass 2 leads mass 1 in phase during vibrations, however,  $A_2$  is smaller than  $A_1$  during the opening part of the cycle so that  $P_1$  is positive, and  $A_2$  is greater than  $A_1$  during the closing part so that  $P_1$  is negative. Thus, the aerodynamic system supplies energy to the mechanical system through its effect on mass 1.

The equations of motion of the two mass model are given by

$$m_1 \ddot{x}_1 + r_1 \dot{x}_1 + k_1(x_1 - x_{10}) + k_c(x_1 - x_2) = L d_1 P_1$$

$$m_2 \ddot{x}_2 + r_2 \dot{x}_2 + k_2(x_2 - x_{20}) + k_c(x_2 - x_1) = L d_2 P_2$$

where  $m_1$  is the effective mass,  $r_1$  is the viscous damping component,  $k_1$  is the spring stiffness constant,  $x_{10}$  is the spring offset value, and  $d_1$  is the vertical thickness

of the inferior part of the model. Similarly,  $m_2$ ,  $r_2$ ,  $k_2$ ,  $x_{20}$ , and  $d_2$  are the corresponding parameters of the superior part, and  $k_c$  is the stiffness constant of the coupling spring.  $L$  is the effective glottal length. The displacements  $x_1$  and  $x_2$  are measured from the midline. (The springs have been assumed linear, although this assumption is not necessary).

Computer simulation of these equations has been carried out by Dudgeon (1969) and, using the Ishizaka and Matsudaira aerodynamic model, by Ishizaka and Flanagan (1972). In these simulations, models of the closed period similar to those of Flanagan and Landgraf (1968) and Flanagan (1969) were used. These studies showed that the performance of the model was realistic in terms of its dependence on acoustic load. Other characteristics that were determined to be realistic were the dependence of fundamental frequency and waveshapes on mechanical constants and subglottal pressure, and the ability to simulate both chest register and falsetto. (Falsetto is produced by making the coupling stiffness,  $k_c$ , very large so that the model is essentially a one-mass model.)

Small signal analyses of the two-mass model have been reported by Ishizaka and Matsudaira (1968) and by Stevens (in preparation). Static equations for the masses were written by setting time derivatives equal to zero:

$$k_1(x_1 - x_{10}) + k_c(x_1 - x_2) = Ld_1P_1$$

$$k_2(x_2 - x_{20}) + k_c(x_2 - x_1) = Ld_2P_2 \approx 0$$

The expression for  $P_1$  is nonlinear in  $x_1$  and  $x_2$  and also depends on subglottal pressure,  $P_s$ . These equations can be solved to yield at least one static operating point (i.e. values of  $x_1$  and  $x_2$  for which the equations are satisfied.) For example, if  $x_{01} = x_{02} \neq 0$  and viscous aerodynamic terms are ignored, one solution of the equations is at the resting position. Considering only small displacements of the masses from these points, the equations were linearized and the powerful techniques of linear systems analysis were applied. The model can initiate vibrations only when the small signal equations have an unstable solution. The form of the instability can also be related in a rough way to the large signal performance characteristics of the models. The effects of acoustic loading can also be accounted for in the small signal equations.

Ishizaka and Matsudaira (1968) showed by small signal analysis that the oscillation conditions for the two mass model were essentially independent of acoustic load. Aerodynamic coupling appears in the form of an equivalent spring with negative spring constant coupling the two masses. Thus, if one mass is slightly displaced from its operating point, the mechanical coupling tends to pull the other mass along

while the aerodynamic coupling tends to push it the other way. For oscillations to occur, the aerodynamic coupling stiffness must be greater than the mechanical coupling stiffness. Stevens (in prep.) notes that there are two possible types of unstable solutions to the small signal equations. In one, the displacements grow exponentially while in the other they oscillate within a growing envelope. These solutions occur in different regimes, so that the former produces low fundamental frequencies and can be considered to be airflow controlled while the latter produces relatively higher fundamental frequencies and can be considered to be stiffness controlled. Stevens also suggests that the two-mass model may be able to account for some aspects of laryngeal behavior during both vowels and consonants in speech production.

#### Discussion: Other Models

The two mass model seems capable of reproducing many of the performance characteristics of the real larynx. The conclusion that the aerodynamic implications of vertical phase differences are an important aspect of the vibration mechanism is convincing. However, it cannot be concluded from these results that the particular form of either the aerodynamic system or the mechanical system for the two-mass model accurately reflects their real analogues. For example, Dudgeon (1969) produced realistic oscillation in a two-mass model with an aerodynamic system somewhat



different from that of Ishizaka and Matsudaira. More recently Titze (1973, 1974) produced oscillations with a model whose mechanical properties were distributed into two vertical levels in a manner different from that of the two-mass model of Fig. 4-4. An important aspect of Titze's model was that the masses could move both vertically and horizontally. Titze's model also explicitly accounted for the string properties of the structures by distributing their properties within eight segments in the longitudinal direction.

The development of the two-mass model required the generalization of the aerodynamic model of a one-section glottis to two glottal sections. Although the one-section model of the glottis was supported by physical measurements, no direct test of the extension to two segments was made. Similarly, development of the mechanical system has been guided more by analytic consideration than by physical fidelity. The correspondence between anatomical structures and model parameters is unclear. For example, the two masses in Ishizaka and Flanagan's model are considered to represent different parts of the vocal ligament and perhaps the vocalis muscle. In Titze's model, these structures are represented by one mass, and the other mass is considered as representing the mucous membrane. Hirano (1974) has suggested that the mucous membrane ought to be viewed as a vibratory structure distinct in general from the elastic and muscular structures. An implication of this assertion

is that the distribution of mechanical properties ought to be modelled in the lateral direction as well as in the vertical direction. It can be argued that a model with lateral distribution ought to at least be able to account more accurately for the mechanisms of glottal closure.

The assumption for the one mass model that vertical forces can be ignored might be challenged, on the basis of the preliminary results of Hiki et al. (1970, relating to the time variation of the pressure drop across the glottis. In the extension to two masses, moreover there are certainly large variations in pressure across the thickness of mass 2 during a cycle. Similarly, the assumption that vertical movements during the cycle are small might also be challenged, especially on the basis of observations by Matsushita (1969) and others.

In summary, the complex two-mass model has been shown to produce realistic results, and other complex models can probably also produce realistic results, at least as far as some aspects of the behavior are concerned. It would thus probably not be useful to continue extending and improving models on the basis of theoretical studies alone. Rather, it is more useful to develop constraints on the forms of acceptable models by direct physiological and physical experiments. Since many such experiments can only be performed on excised or animal larynxes, it is worthwhile to develop models for these preparations specifically

and to test them directly against their real counterparts as a step toward understanding the detailed mechanisms of the in vivo human larynx.

Chapter 5            Apparatus and ProceduresSource of Larynxes

Larynxes were excised within one hour post-mortem from mongrel dogs weighing 20 to 30 kg. The dogs were experimental animals from coronary research units at Harvard Medical School. All were anesthetized and were intubated with endotracheal tubes. Some, used only as blood donors, were sacrificed within an hour post-anesthesia. Others were used for experimental procedures involving surgical impairment of the coronary circulation and subsequent treatment for a duration of 4 to 24 hours. These procedures did not obviously impair the larynxes.

The larynxes were excised with some of their extrinsic structures, including a short section of trachea. After excision and when not in use, they were kept in a solution of  $3/4$  physiological saline (0.67% NaCl) in a refrigerator. The solution was found by van den Berg and Tan (1959) to be appropriate for maintaining the water content in the laryngeal tissues.

Typical unstretched glottal length for these specimens was 3 cm. from the anterior commissure to the posterior commissure, stretchable to about 3.6 cm. Of this length, about 1 cm. was intercartilaginous (i.e. between the bodies of the arytenoid cartilages, not including the vocal processes).

### Preparation of Specimens

Preparation of the larynxes was modelled after van den Berg's, as described in his later publications (e.g. 1960c). The larynxes were first stripped of their extrinsic structures, except for a short section of the trachea, and of their ventricular folds. A small rigid bar was attached to the lamina of the cricoid cartilage, using several sets of surgical threads which passed into the cartilage but not through its internal surface. The bar was subsequently used to fix the cartilage to the apparatus. Three sets of threads were then attached to simulate the activity of the arytenoid muscle, the adductor muscles, and the tensor muscles, respectively. (Activity of the vocalis muscle cannot be adequately simulated.) Photographs illustrating these attachments are shown in Fig. 5-1.

The attachment of the bar is best illustrated in part A of Fig. 5-1. Parts A and B show the attachment of the threads to simulate the interarytenoid muscle. After the muscle was freed along its length, loops of thread were attached at each side near the insertions into the muscular processes. These loops were subsequently crossed (as shown) and then tensed to simulate muscle activity. Attachment of the threads to simulate the adductors is shown in parts C and D of the figure. The lateral cricoarytenoid muscles were freed along their lengths, and threads were attached

## FIGURE 5-1

Photographs illustrating preparation of the Larynx.  
(A.) Lateral aspect, (B.) Supero-Latero-Dorsal aspect,  
(C.) Lateral aspect, with thyroid ala deflected showing  
attachments to the muscular process, (D.) Anterior  
aspect.

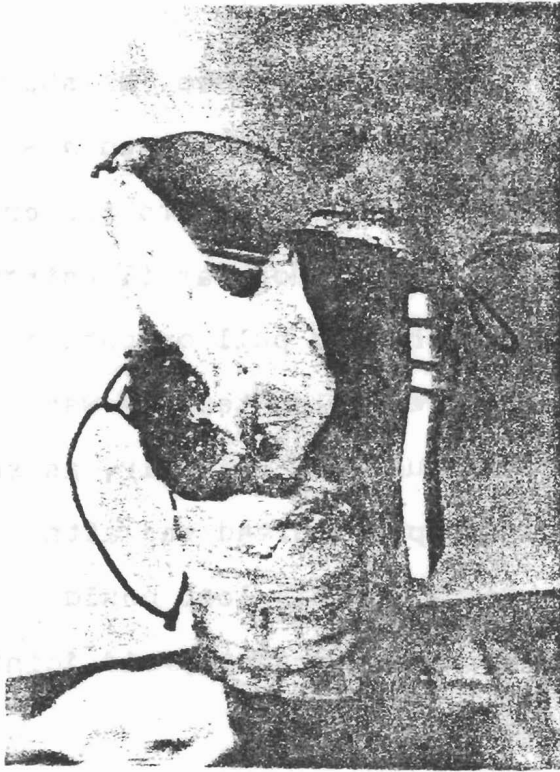

A

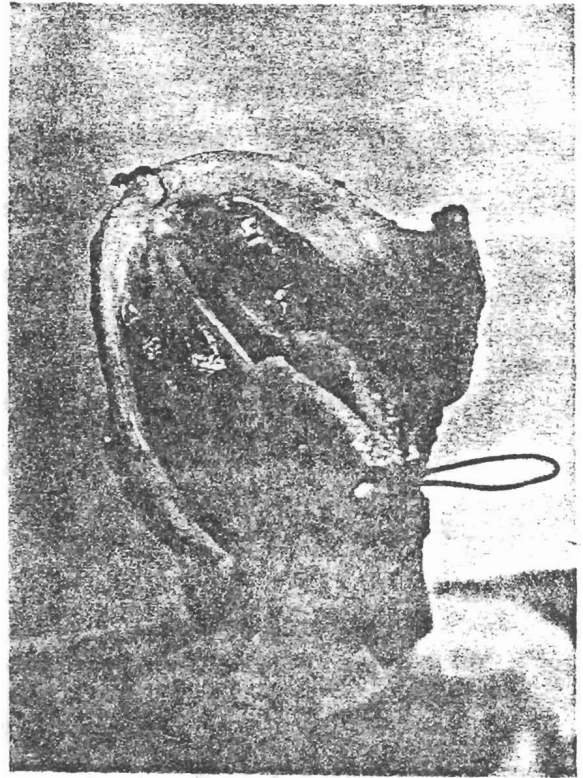

B



at their insertions into the muscular processes, as shown in part C of the figure. These threads were passed anteriorly through the cricothyroid space medial to the cricothyroid muscle and connected to form a loop, as illustrated in part D. Another loop was attached to pull on both sides simultaneously when tensed. The resulting tension was roughly parallel to the adductor muscles. Finally, as shown in part D of Fig. 5-1, a small loop of thread was attached at the thyroid notch. Attachments to this loop could be used to rotate the cartilage about the cricothyroid joint, simulating activity of the tensor muscles.

#### Apparatus for Producing and Observing Phonation

A schematic sketch of the overall experimental setup is shown in Fig. 5-2. A photograph is shown in Fig. 5-3. The apparatus can be conveniently discussed in three stages: a subglottal system (which itself can be described in three parts) which supplies warm, moist air to the larynx at known pressure and flow rate, apparatus for supporting the larynx and controlling its configuration, and apparatus illuminating the larynx and aiding in its observation.

Subglottal System: The subglottal system consists of a regulation stage, a warming and humidification stage, and finally a pseudo-subglottal tract.

Air was obtained from compressed-gas cylinders with delivery pressure adjustable in the range of tens of PSI. In



FIGURE 5-2  
Schematic sketch of the Apparatus.

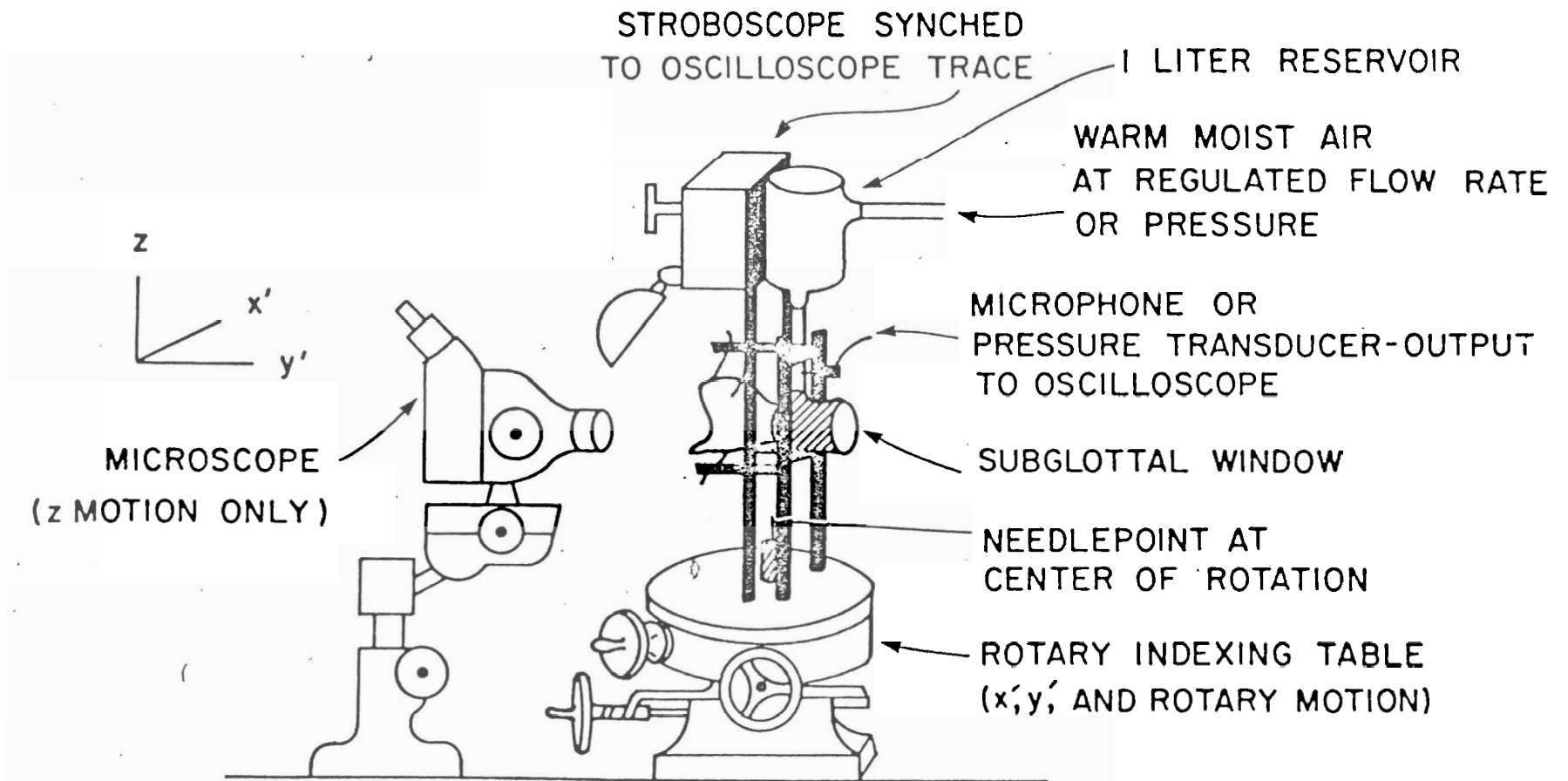
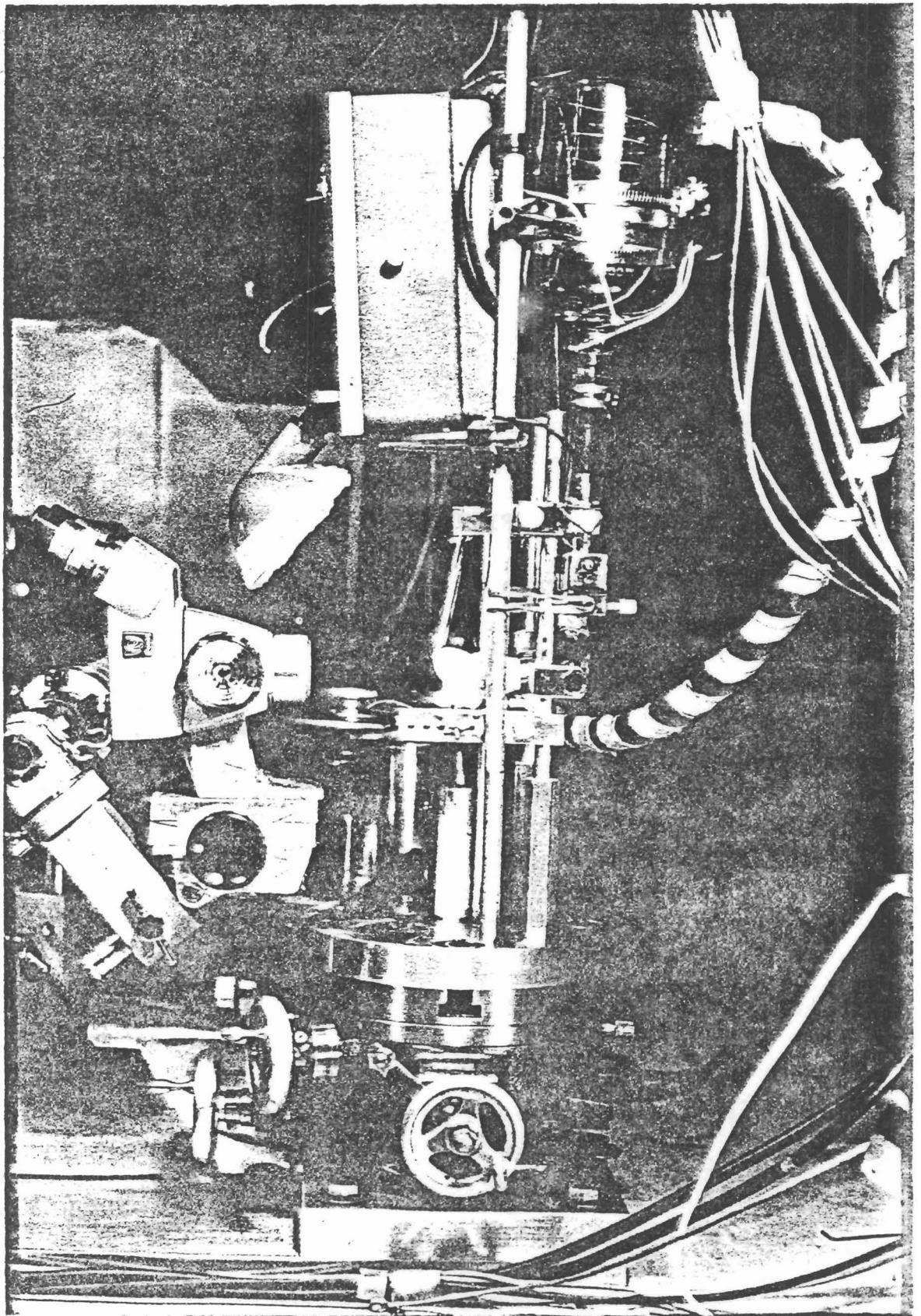

FIGURE 5-3

Photograph of the apparatus.

C



early experiments, the air was then passed through a constriction with aerodynamic resistance much greater than that of the larynx. As a result, the system delivered air at regulated flow rate proportional to the regulator delivery pressure. The flow rate was monitored using a floating-ball flowmeter in line with this system. All previously published excised-larynx work has employed similar flowrate sources. In most of the experiments reported here, an attempt was made to better simulate the human subglottal system by regulating subglottal pressure instead of flow rate. A low pressure line regulator (0 - 40 cm. H<sub>2</sub>O) replaced the airway constriction. The regulator (Matheson model 70B) was modified to reduce its source resistance. However, the effective source resistance was still roughly 7 to 10 cm. H<sub>2</sub>O per liter per second for just the regulator. In addition, the rest of the subglottal system adds more resistance, so that the total effective resistance of the subglottal tract was 15 to 20 cm. H<sub>2</sub>O per liter per second, or roughly ten times that of the human subglottal tract.

In the flow-regulator system, warming and humidifying the air was accomplished by bubbling it through warm water. From this stage, the air was passed through a large reservoir (a modified pressure cooker) which served to smooth out the flow. It was also useful for attaching a manometer to monitor average subglottal pressure, and a thermistor to

monitor temperature. In the pressure-regulator system, warming and humidification was accomplished in the pressure cooker itself to reduce the resistance associated with this stage. The air was vented through filter floss which was moistened by warm water at the base of the reservoir. From the reservoir, the air passed through a long section of tubing to the pseudosubglottal tract.

In addition to the conditioning of the supplied air, steps were taken to keep the entire room as warm and as humid as possible. As noted by van den Berg and Tan (1959), these conditions were necessary to prevent the larynxes from drying out, thus impairing their function.

The pseudosubglottal tract is illustrated in Figs. 5-2 and 5-3. Air arrives through the long tubing from the pressure cooker into a 1 liter reservoir, which roughly simulates the acoustical effects of the lungs (by forming a relatively large volume termination to the tract from the glottis). It passes through a section of  $3/4$  inch ID tubing, simulating part of the tracheobronchial tree, to the subglottal fitting. The subglottal fitting is fashioned from a brass "tee", one opening of which is sealed by an optical glass window for viewing the phonating larynx from the subglottal aspect. The fitting has an internal diameter of  $1/2$  inch at its narrowest point, so it does not significantly constrict the airway. At the flow rates of interest, the bend should also not

significantly affect the airflow patterns at the glottis. The entire tract from the pressure cooker to the larynx is heated using loosely wrapped nichrome wire in order to minimize condensation and prevent fogging of the subglottal window.

The section of trachea attached to the larynx is connected to the subglottal fitting using an adjustable hose clamp. The entire length of the tract from the opening of the 1 liter reservoir to the glottis is then roughly 25 cm. The system was found to have a first resonance at about 400 Hertz with the glottis closed.

Control of Larynxes' Configuration: The apparatus for supporting and controlling the larynx is illustrated in Figs. 5-2 and 5-3. The bar attached to the cricoid cartilage was clamped at an adjustable height and angle below the subglottal fitting. The larynxes were supported in a horizontal position so that observations could be easily made from both the supraglottal and subglottal aspects. They were supported with the anterior surface up for several reasons: this orientation simplifies control of the threads, causes most of the condensation to exit through the interarytenoid space rather than the membranous glottis, and is the orientation that would be used for in-vivo experiments.

Adjustable tension was applied to the interarytenoid and adductor threads using springs attached to threaded

rods. These could be attached to the apparatus at various locations to change the angles at which the tensions were applied. In the early experiments, a similar scheme was used to apply tension to the tensor thread. However, for most of the experiments described here, a rigid rod was used to fix the thyroid cartilage with respect to the apparatus, and the cartilage was attached to the rod using an elastic band attached to the loop of thread.

As shown in the figures, the apparatus for supporting the larynx, the subglottal fitting, and the tension production apparatus was supported between two rods which were designed to minimize vibrations or flows. The rest of the apparatus with external attachments (the 1 liter reservoir and electrical equipment with cables) was mounted on a separate set of rods which were most flexible.

Observation of Phonation: The support apparatus was mounted on an aluminum disk on the top of a rotary indexing table. The tabletop could be translated along two horizontal rectangular axes and rotated, so that observations could be made from any aspect. (The tubing from the pressure cooker to the 1 liter reservoir was long enough to allow this rotation.) Observation was made either with the naked eye or through an American Optical stereo microscope, which had a nominal 4 inch working distance and available magnification of 10, 20, and 40 times. The microscope's working



distance was sufficiently long to focus on the vocal folds through the subglottal window.

As shown in Figs. 5-2 and 5-3, the larynxes were illuminated from the anterior-superior aspect by a General Radio model 1531A stroboscope suspended above the specimen. A mirror surface was placed below and in front of the larynx to reflect this light back to the anterior parts of the glottis (even when it was closed) to illuminate the subglottal space. The stroboscope could be operated asynchronously, to show the vibrations in apparent slow motion, or synchronously, to stop the motion at an arbitrary phase in the glottal cycle. This mode is described below.

A Sanborn physiological pressure transducer (model 268B) was coupled to the subglottal tract, roughly 10 cm. from the glottis using a 16 gauge hypodermic needle. This system had a limited frequency response (to about 300 Hz.) similar to those reported by Edmonds et al (1971). It was used to derive a signal related to the subglottal pressure waveform. For some experiments, a weatherproofed miniature electret microphone (Thermoelectron model 5336CX), which had a flat frequency response throughout the audio range and a dynamic range up to 150 dB SPL, was also mounted about 10 cm. from the glottis. (This transducer proved to be inadequately weatherproofed for this application. A bonded strain gauge transducer for wideband monitoring of subglottal pressure would perform better.) The output of

one of the pressure transducers was used to trigger a Tektronix model 532 oscilloscope, which displayed the waveform. The oscilloscope has a delayed sweep mode with delay controlled by a panel dial. This feature was used to generate a trigger pulse at an adjustable delay, which was monitored on the scope face. This pulse was used to trigger the stroboscope at the desired phase. The trigger output of the oscilloscope was also input to a frequency counter which was used to measure fundamental frequency. This method of measuring fundamental frequency provided visual confirmation that no triggers were missed and no false triggers were included in the count.

Figure 5-4 shows photographs at eight phase increments of a typical cycle of phonation from the supraglottal and subglottal aspects. These photographs were made with 1/4 second exposures using the stroboscope triggering described above (roughly 10 flashes per exposure). The resolution of the photographs indicates that the system provided a sufficiently stable trigger signal. There are black spots evident on the photographs. These are due to clumps of small carborundum particles which were placed on the vocal folds. The photographs illustrate that these particles were useful for visualizing the vibration patterns.

#### Measurement of Particle Trajectories

The microscope - rotary-table apparatus was used with

## FIGURE 5-4

Photograph showing a phonating glottis from the superior and inferior aspects at eight phase increments through the cycle. The photographs are shown two to a page with time increasing from top to bottom and in order of increasing page number. The inferior and superior views at corresponding phase increments face each other on alternate pages.

(

(

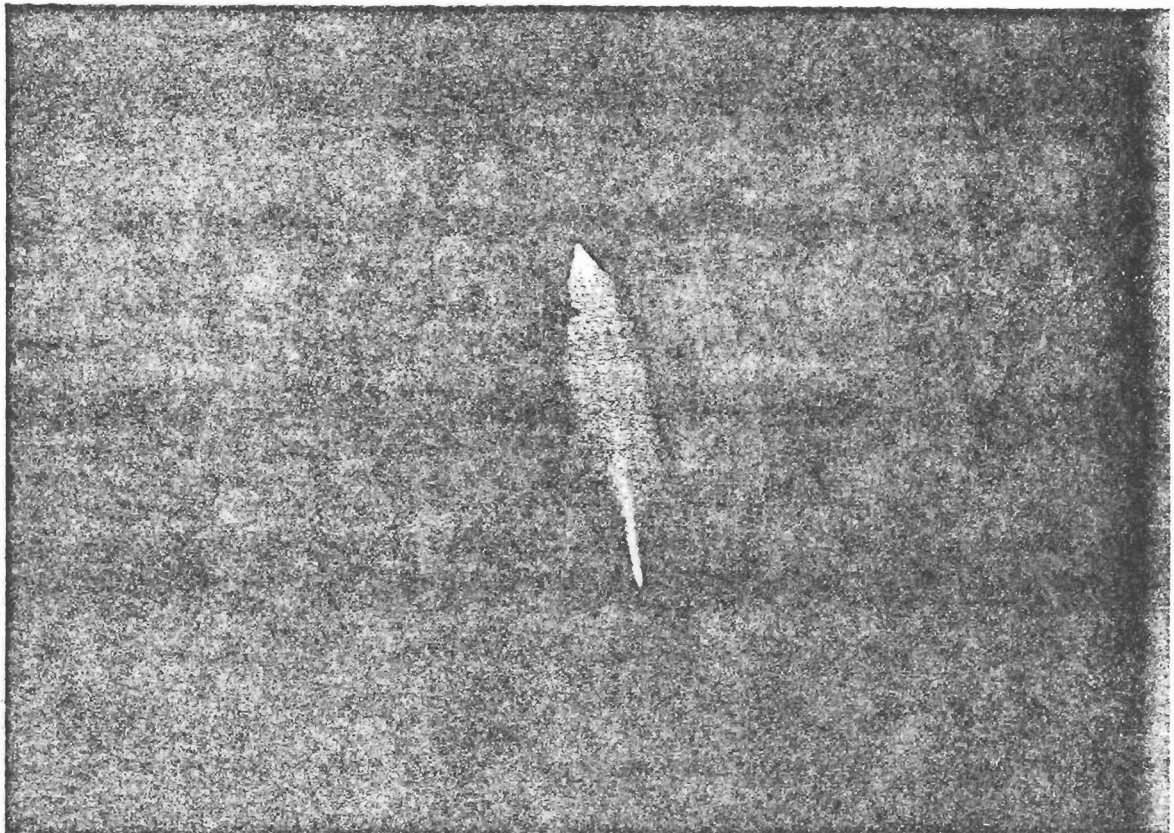
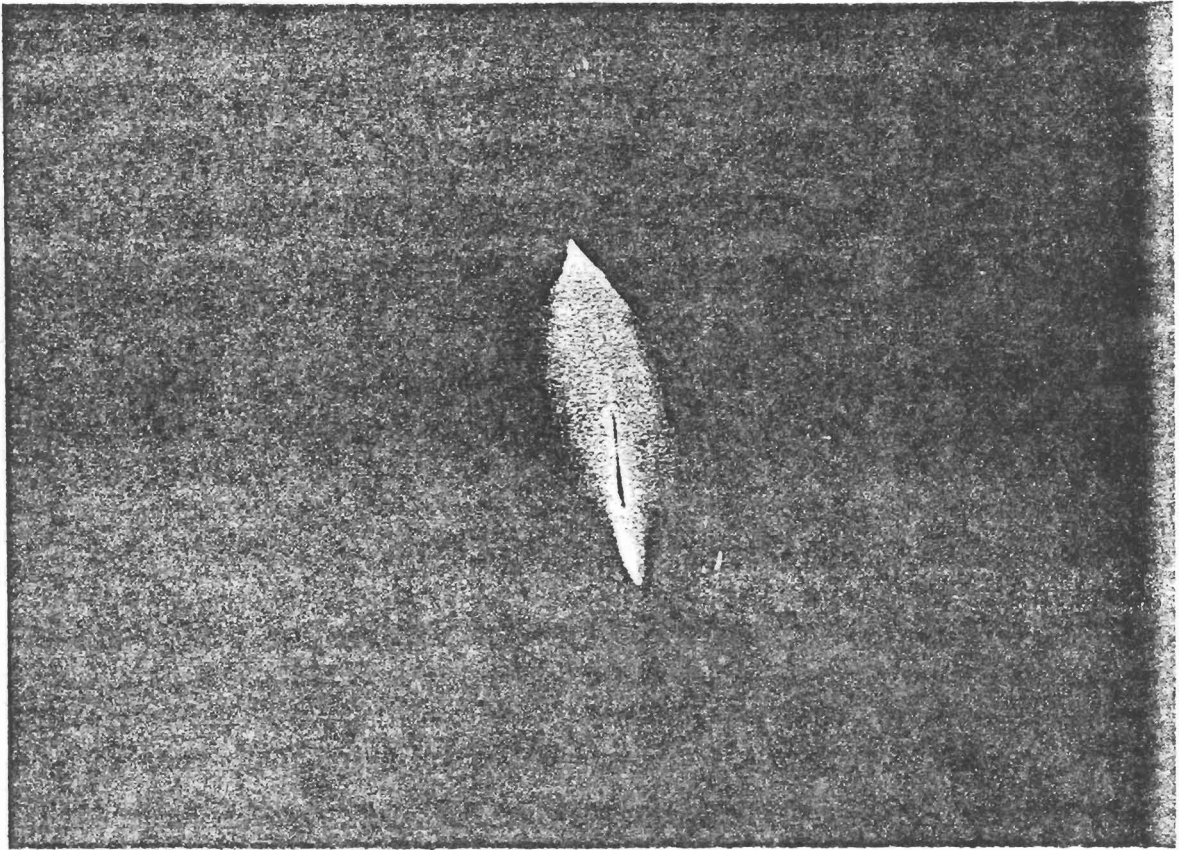



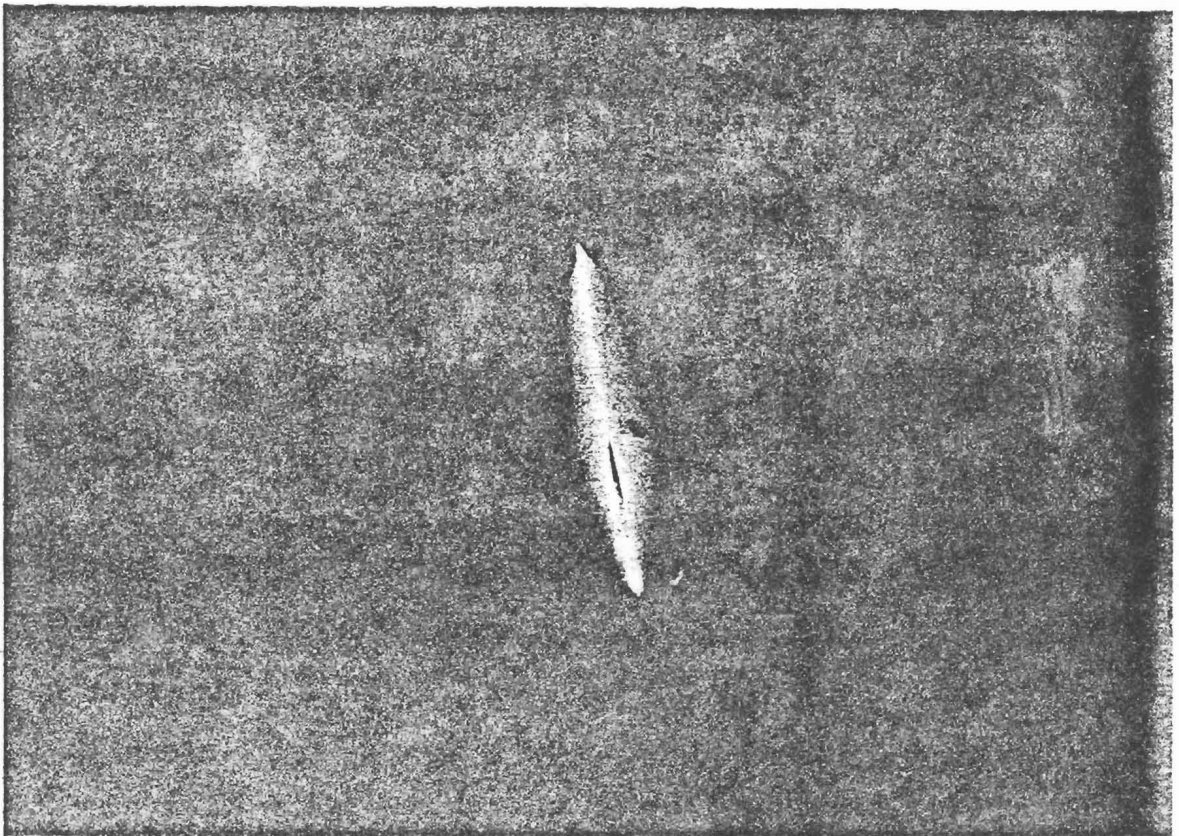
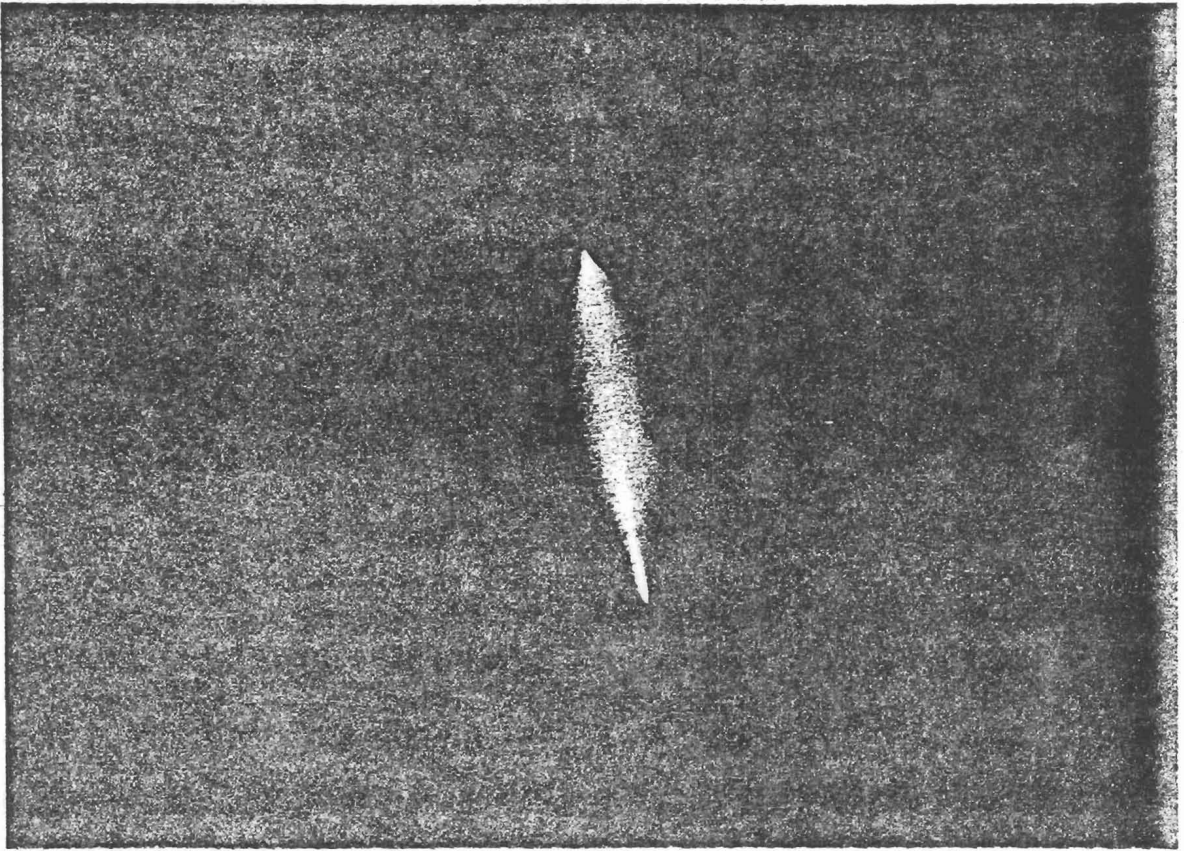





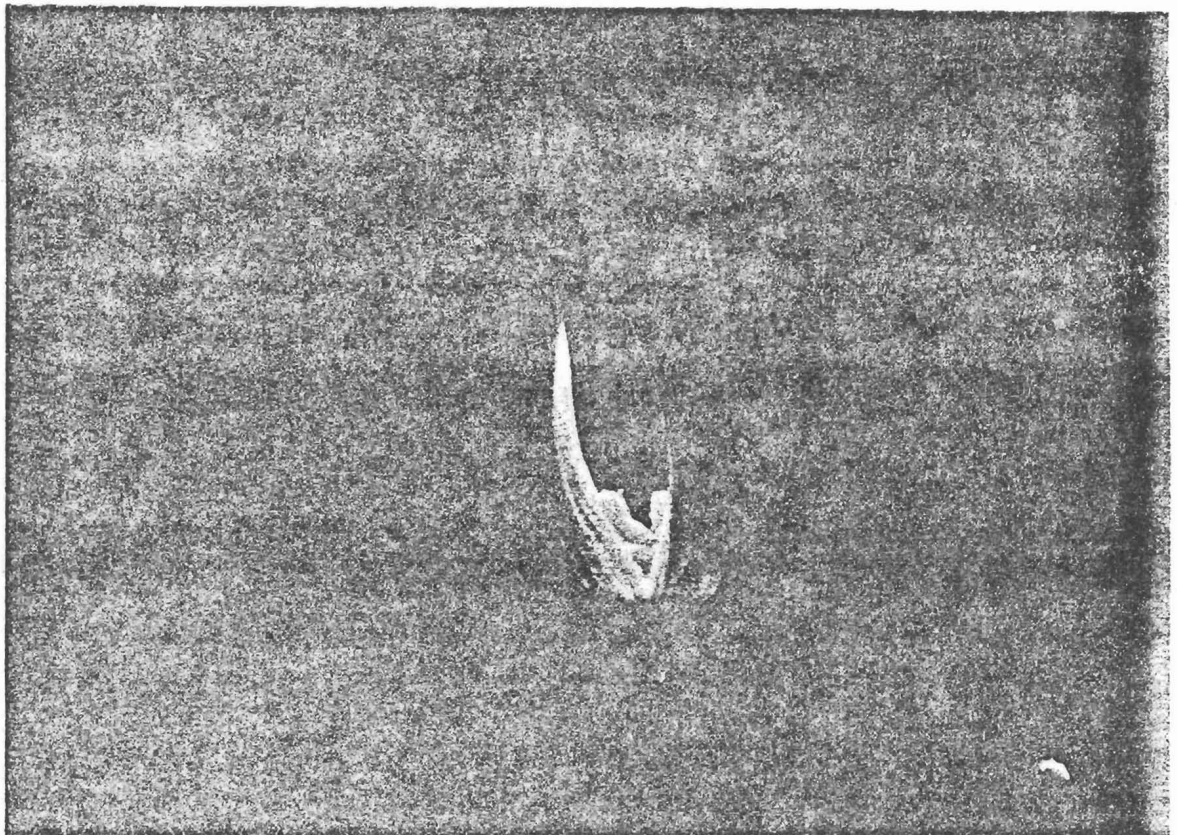
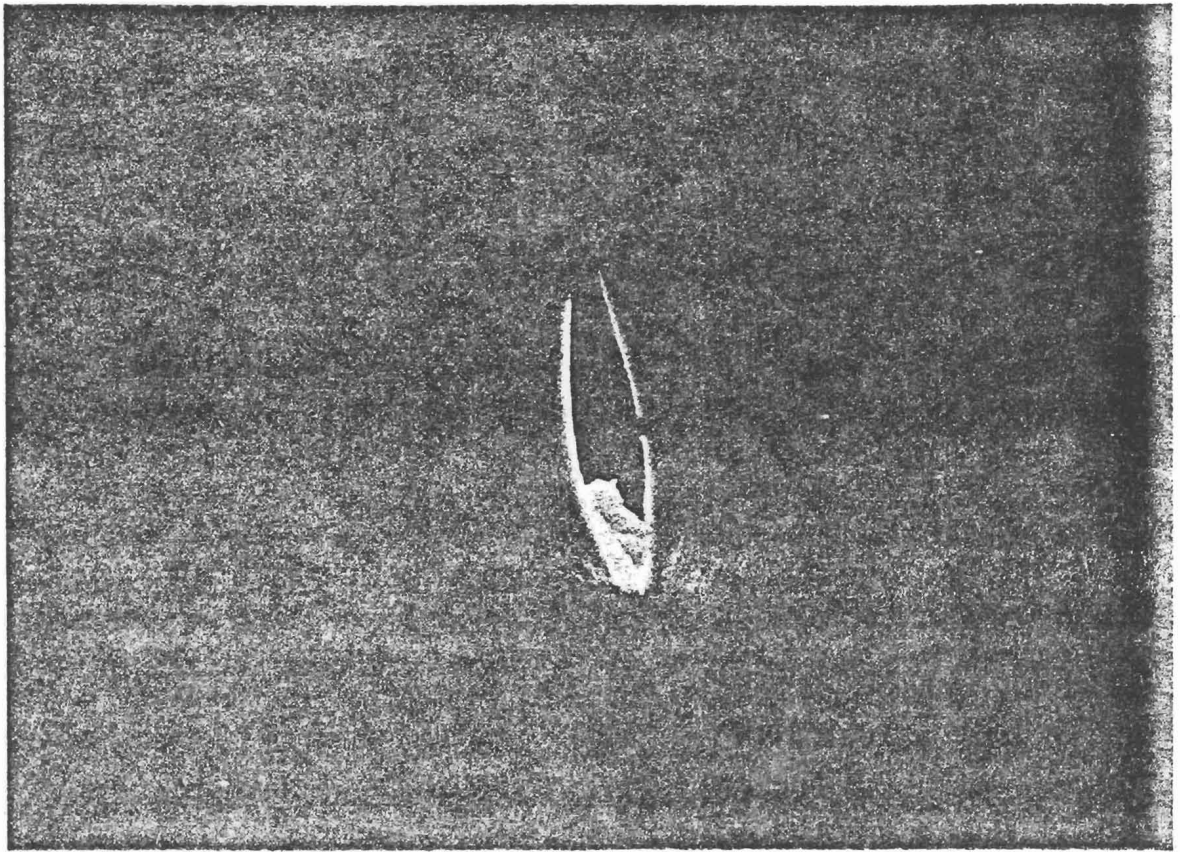



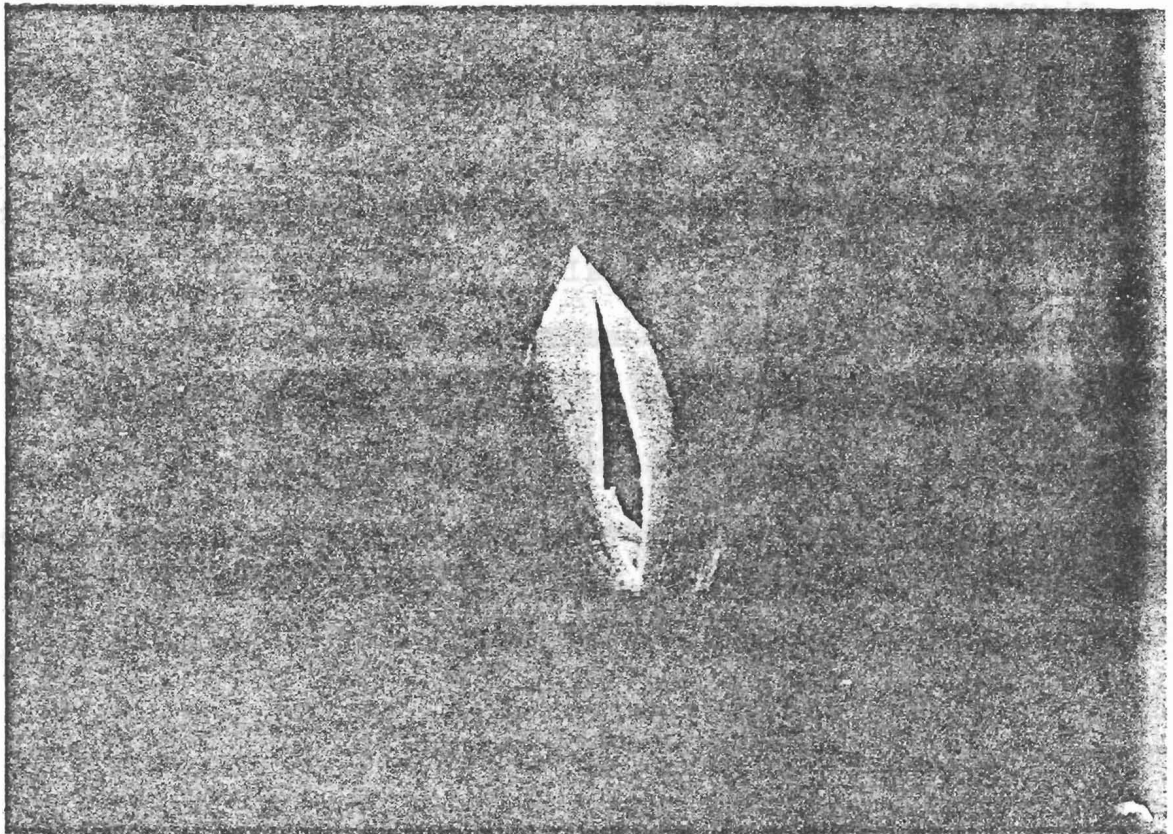
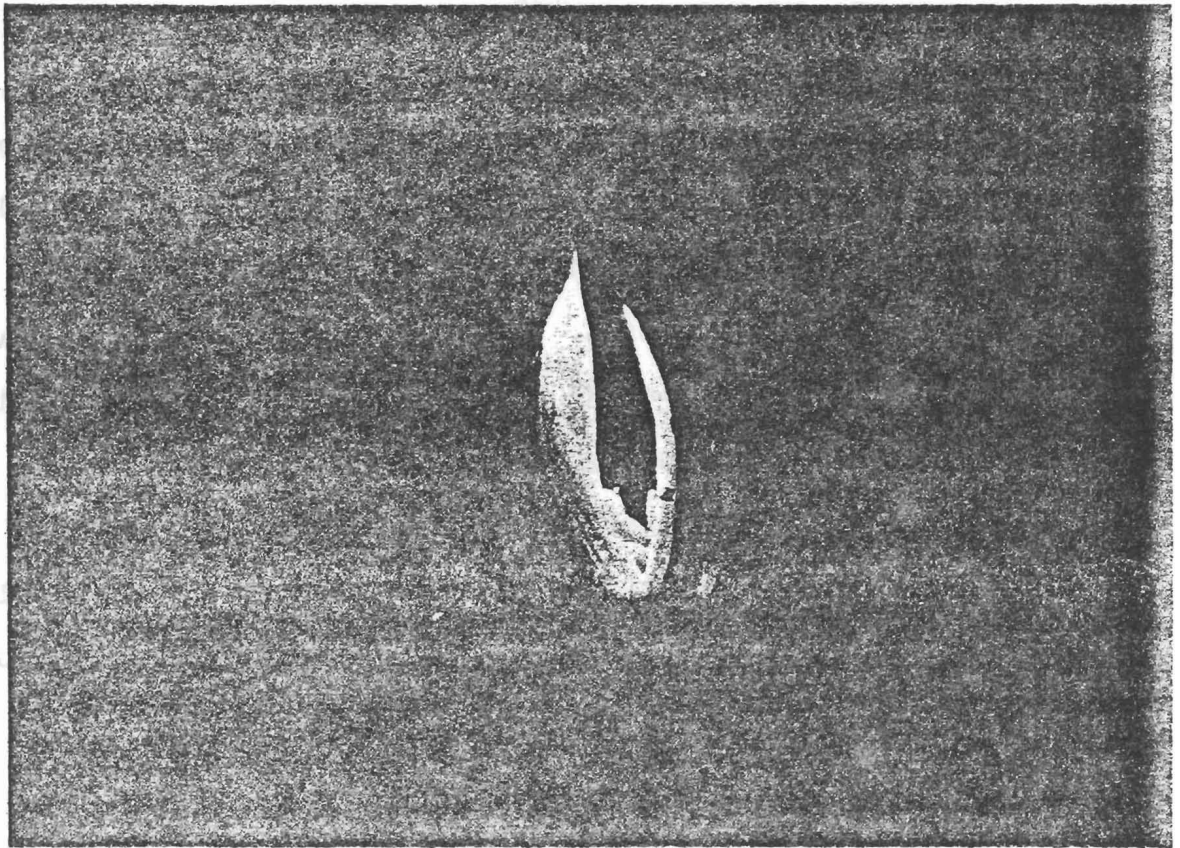

synchronous stroboscopic illumination to measure the instantaneous frontal-plane positions of the carborundum particles or other points on the vocal fold surfaces. To make these measurements, the microscope and rotary table were both fixed to a rigid base. The microscope could only move in the vertical direction (i.e. perpendicular to the frontal plane), as indicated in Fig. 5-2. All other motion was provided by the rotary table, whose translation axes were oriented roughly parallel and perpendicular to the optical axis. As already mentioned, the tabletop could be rotated so that the optical axis was at any horizontal angle with respect to the larynx.

For measurements, only one eyepiece of the stereo microscope was used. Measurements were made using the highest available magnification. The particles used for measurement were small enough ( $\frac{1}{320}$  inch) that their size did not limit the resolution of the measurements. Measurements perpendicular to the optical axis were made with the aid of a microscope eyepiece reticle. Measurements parallel to the axis were made using the limited focal depth of the microscope at its highest magnification.

Two rectangular coordinate systems were defined. One was the frontal plane coordinate system (X-Y) attached to the tabletop and thus fixed with respect to the larynx. The X axis was in the lateral-medial direction and the Y axis

was in the inferior-superior direction. The primed coordinate system ( $X'-Y'$ ) was defined by the translation axes of the table. The optical axis was roughly parallel to the  $Y'$  axis. Both coordinate systems had a common origin, which was fixed to the center of rotation of the tabletop. The angle of rotation,  $\theta$ , between them was read from the rotation dial of the table. The dial was calibrated in 3 minute intervals.

The measurement system was initialized by translating the tabletop until its center of rotation was centered in the eyepiece reticle and also centered within the depth of focus. A telescoping needlepoint accurately aligned with the rotation axis was provided for this purpose. With the tabletop in this position, the adjustable axis dials were set to zero. The  $X'-Y'$  position of any point could then be measured by translating the tabletop until the point was similarly centered in the microscope's field. The coordinates were then simply read off the axis dials. The angle  $\theta$  is also recorded, and this information was used to convert the measurements to the common  $X-Y$  coordinate system. Thus, measurements could be made from any angle for which the point was visible, including through the subglottal windows.

Translation along the table's axes was calibrated in 0.001 inch increments and was accurate to 0.002 inches

(0.05 mm.). Measurement accuracy along the Y' axis was limited by the optics, and was usually accurate to within 0.005 inches (0.13 mm.). Because of the coarseness of the measurement along the Y' axis, the measurement was generally repeated several times (by defocussing and refocussing the image) before the value was recorded. Measurement accuracy in the X-Y coordinate system is found by transforming the limits in the X'-Y' system for the value of  $\theta$  used. Resolution of the angle does not significantly affect this accuracy.

## Chapter 6 Results I: Gross Performance of Excised Larynxes

The purpose of this chapter is to describe the gross behavior of the excised larynxes at a level that can be compared with normal human phonation and with the results of other excised-larynx studies. This description sets the context for the detailed results presented in the next chapter. The results presented here also represent a contribution to the study of phonation in general.

### Registers

By varying the controls of the larynxes' configuration and the subglottal source, phonation could be produced in different registers. The initial (no-flow) configuration used for most experiments was with the glottis closed or nearly closed and the vocal folds at nearly their natural (relaxed) length (as the subglottal source was slowly activated, the glottis opened prior to the initiation of phonatory vibrations, however). In this configuration, a "modal" register - i.e. one typical of the human speech range - was produced. Photographs illustrating phonation in this register were shown in the previous chapter. Phonation in this register could also be produced with no-flow glottal width ranging from closed to about 1 mm.

A clearly distinguishable falsetto register with properties similar to those described by van den Berg (fundamental frequency greater than 200 Hz, thin glottis, small vibration



amplitudes and no vertical phase difference, open quotient at or near unity) was produced when the vocal folds were stretched to nearly their maximum length. It was found, however, that falsetto could not be produced with a larynx whose condition had deteriorated, due either to the effects of advanced post-mortem age or to desiccation during the course of an experiment.

At the other extreme, an analogue of van den Berg's Stroh bass register (shortened glottis, large amplitude vibrations at low fundamental frequency with no closure, low values of subglottal pressure and airflow) was not normally produced. Rather, with small longitudinal tension and small values of flow and pressure, an apparent pulse register or vocal fry (with fundamental frequency typically 60-80 Hz and closure for as much as 3/4 of the cycles) was produced. Low- to moderate-frequency phonation with no closure and generally high flow rates was produced with larynxes which had become desiccated during the course of an experiment. [Open quotient and flow rate generally increased as desiccation progressed.] Other anomalous modes of phonation, for example with two pulses per cycle, were also produced under some conditions.

Within the "modal" register, sudden shifts in the vibration patterns sometimes occurred, either spontaneously or when the controls were changed slightly. The characteristics of this shift seemed consistent with the chest



register-mid register dichotomy described by van den Berg. Compared to the lower (chest) register, the higher (mid) register had higher fundamental frequency, larger open quotient, and correspondingly smaller glottal resistance. For example, with the flow rate at the regulated value of 200 cc/sec., a spontaneous shift from the higher to the lower mode occurred with the following characteristics:

"mid voice" -  $F_0 = 200$  Hz,  $P_s = 10$  cm.  $H_2O$ ,  $OQ = 7/8$

"chest voice" -  $F_0 = 140$  Hz,  $P_s = 17$  cm.  $H_2O$ ,  $OQ = 3/4$

In another example, an  $F_0$  jump between 85 Hz and about 200 Hz was produced repeatedly by varying subglottal pressure. Under stroboscopic observation, the greatest distinction between the two vibration patterns was on the lower surfaces of the vocal folds. In the higher mode, this part of the glottis vibrated little or not at all about its average width, which was relatively narrow. For the lower mode, the average width was wider but amplitudes of vibration were large enough to cause closure. Preceding the shift from the higher to the lower mode, small vibrations could sometimes be seen building up in the subglottal region until the change of state suddenly occurred.

According to van den Berg (1960) the transition between chest register and mid register need not be discontinuous. If there are indeed two registers, there is no fixed boundary between them. As can be said for other

studies of phonation, the experiments may have included a mix of two registers, although we have attributed them to chest voice.

### Stability

For larynxes in good condition operating in the middle of their ranges with appropriately warmed and humidified supplied and ambient air, cycle-to-cycle stability (jitter) was not a limiting factor for the experiments. Under these conditions, the subglottal pressure trace on the oscilloscope was steady and particles on the vocal folds were stable and sharply defined under synchronous stroboscopic illumination. However, significant condensation in the subglottal tract caused increased jitter. Jitter also increased when the larynx was not operating in a "comfortable" range, either near the extreme of subglottal pressure or when the tissues became desiccated or otherwise deteriorated in physiological condition. (The high extreme of subglottal pressure in these experiments was when the vibrations became very irregular, excessive noise was produced, or the vibrations seemed otherwise non-physiological.)

During an extended run, stability was a severely limiting factor. It was found difficult to maintain steady state vibration for the periods (at least greater than 15 minutes) required to make measurements. The balance between avoiding condensation and fogging of the subglottal window on one hand and tissue desiccation on the other hand was difficult

to achieve. It was hoped that the pressure-regulated subglottal source would maintain stable vibrations over a wider range of tissue conditions than the flow-regulated source, since pressure seems to be more directly related than airflow to the control of phonation. However, no dramatic improvement was obtained. Thus, many runs for detailed measurements were terminated with an incomplete or invalid set of measurements.

Run-to-run and day-to-day variability, which depend on the configuration of the larynx as well as the condition of the laryngeal tissues, was of course large. However, no dramatic effect of post-mortem age was noted up to the point where the tissues visibly deteriorated. For runs simulating normal phonation, larynxes were used up to a post mortem age of about 3 weeks, though most runs were within 2 weeks post-mortem. It was already noted, however, that difficulty was encountered in producing falsetto in some old larynxes.

#### Variables Describing Steady State Phonation

Table 6-1 shows measured values of the variables fundamental frequency ( $F_0$ ), subglottal pressure ( $P_s$ ), glottal volume velocity ( $U_g$ ), and open quotient (OQ) from experiments in which detailed measurements were made. As noted in the table, some rows reflect changing conditions within a run. Because of the stability problems mentioned above, a majority of these experiments did not result in a complete

TABLE 6-1

Measured values of phonatory parameters during experimental runs. The variables tabulated are post-mortem age of the preparations in days, fundamental frequency ( $F_0$ ) in Hz., average subglottal pressure ( $P_s$ ) in cm.  $H_2O$ , glottal flow rate ( $U_g$ ) in cc./sec., and open quotient <sup>2</sup>(OQ). OQ was not measured for all cases. This list does not include runs where only partial information about the other 4 parameters is available.

Larynx	Post-Mortem	F <sub>0</sub> (Hz)	P <sub>s</sub> (cm H <sub>2</sub> O)	U <sub>g</sub> (cc/sec)	OQ	Comments
	Age (days)				(Where Measured)	
<u>U<sub>g</sub> Regulation</u>						
L3-30-3	4	120	9	300	1	Weak vibrations Deteriorated
	5	140	12	250	5/8	
	5	140	12	200	6/8	
	10	87	9	325	5/8	
L7-13-3	6	83	9	225	-	
<u>P<sub>s</sub> Regulation</u>						
L8-23A-3	11	90	8	380	-	Same run but conditions drifted
	11	80	7	400	-	
	12	90	7	310	4/8	
	12	100	7	330	5/8	
L8-23B-3	14	110	9	230	-	Same run after 70 minutes
L8-24-3	11	110	8½	310	6/8	
L9-28-3	5	102	13	300	-	Same run after 10 minutes
	5	100	11	375	-	
	12	100	8	275	-	
L10-12-3	17	86	8	450	4/8	Same experiment
	17	84	7½	525	5/8	
L11-1-3	12	120	11	450	-	
L1-18-4	18	130	12	250	-	
	18	139	9	275	-	
	18	105	8	190	-	
	19	81	5	500	1	Open no- flow glottis
	19	80	6	275	1	
	19	112	7	250	1	Open glottis Deteriorated
	19	103	8	250	5/8	
L2-26-4	6	88	7	215	-	
	7	94	8	375	-	
	7	110	7	400	-	Same run after 15 minutes
	7	125	9	250	-	

set of detailed measurements. The table thus represents a sample of measurements. It also does not account for all the experiments whose results will be discussed in the next chapter.

Figure 6-1 shows a scatter plot of  $F_0$  vs  $P_s$  from Table 6-1. There is a point on the plot for each row in the table, and different larynxes are represented by different plotting symbols. These symbols are unfilled for experiments in which the subglottal source was a volume velocity regulator and filled for those with a pressure regulator. The variability reflected in the plot has an intra-larynx component and a larger inter-larynx component. The differences between source regulation do not appear to be systematic.

Subglottal pressure and fundamental frequency both fall into ranges typical for normal human phonation.  $P_s$  is in the range of 5 to 17 cm  $H_2O$  with greatest concentration in the 7 to 9 cm.  $H_2O$  range, while  $F_0$  ranges from 80 to 140 Hz, with greatest concentration in the 80-110 Hz range. The scatter plot indicates a rough correlation between the variables. Data points seem to cluster around the 6 Hz/cm  $H_2O$  line which has been drawn. There is no dramatic clustering into groups that would indicate distinct modes. Flow rate ranged from 100 to over 500 cc/sec., with greatest concentration in the 225 to 325 cc/sec. range. These rates

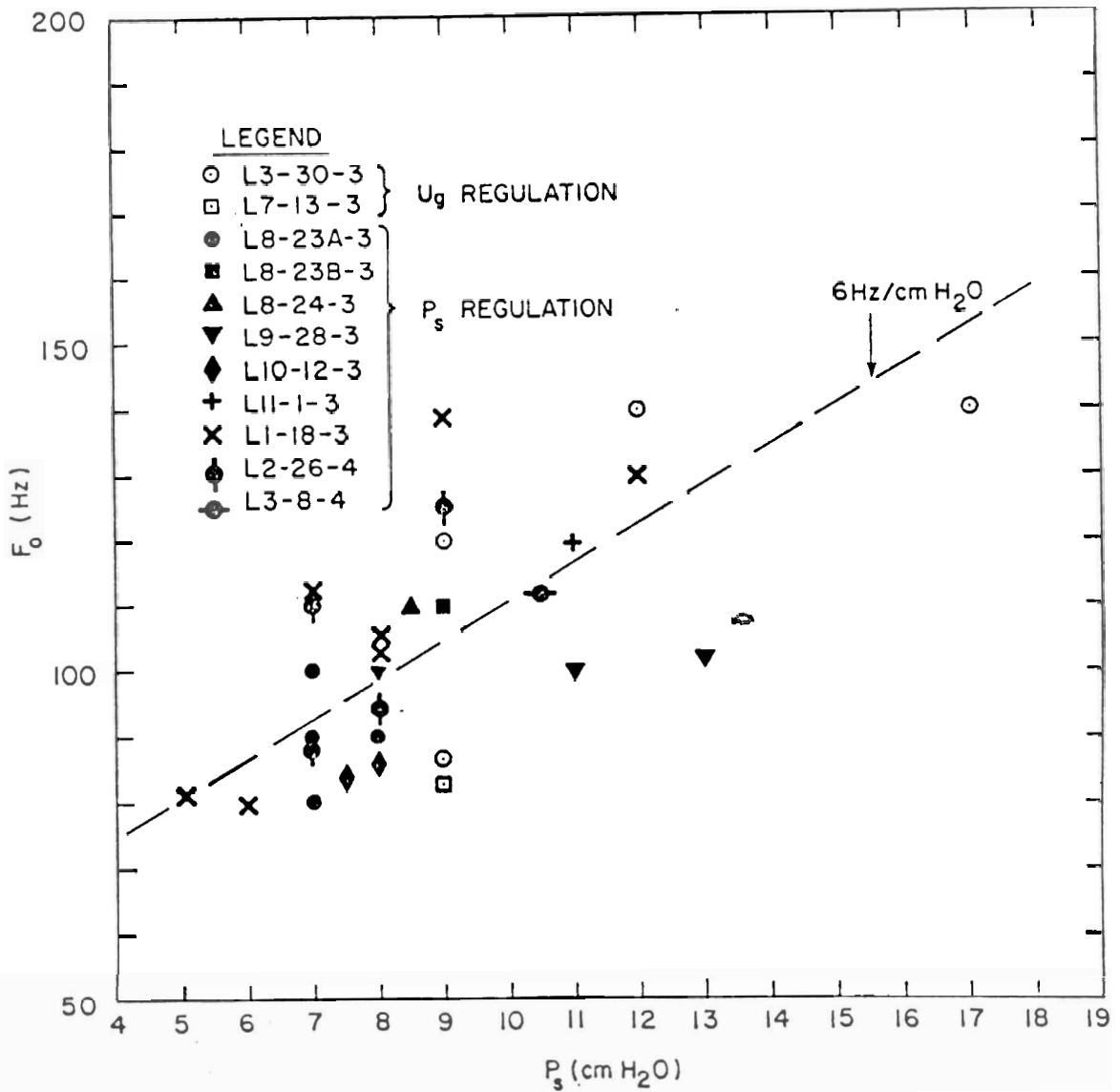

FIGURE 6-1

Scatter plot of fundamental frequency versus subglottal pressure from Table 6-1. The 6 Hz./cm. H<sub>2</sub>O line was drawn in arbitrarily.

are higher than those typical for human phonation, but they are similar to those reported in other experiments with excised larynxes (e.g. van den Berg and Tan, 1959) and live dogs (Koyama et al., 1971). The difference is partly due to incomplete closure of the interarytenoid part of the glottis. It was already noted that  $OQ$  increases as the tissues become desiccated, and  $U_g$  increases correspondingly. Probably because of these factors, there was no obvious correlation between  $U_g$  and any of the other variables.

$OQ$  was in the range  $1/2 - 1$ . The higher values were obtained generally when the state of the laryngeal tissues had deteriorated significantly from their "normal" condition during an experiment. Often, the glottis closed over part of its length but complete closure was not attained.

#### Initiating and Sustaining Phonation

Phonation was initiated by adjusting the larynx to an appropriate configuration and then slowly increasing subglottal pressure. The no-flow glottal configuration was closed or nearly closed for these experiments, although phonation could also be initiated with the glottis open somewhat. The value of  $P_s$  for which initiation occurred was found to be at least 3 cm.  $H_2O$  for these experiments. The value was extremely sensitive to the condition of the laryngeal tissues. For example, a value of 3 cm.  $H_2O$  was required at the beginning of one experimental session, but



but at the end of the session (after 1 3/4 hours) when the laryngeal tissues were quite dry, a subglottal pressure of 8 cm. H<sub>2</sub>O was required.

Similar values of subglottal pressure for initiating phonation were found with volume-velocity regulator and pressure regulator subglottal sources. Of course with the volume velocity source, pressure increases suddenly as the vibrations start and glottal resistance increases. With the smaller source resistance of the pressure-regulator source, pressure is more nearly constant as phonation starts.

With the configuration held steady, phonation could be sustained as subglottal pressure was reduced to a value below that for which phonation was spontaneously initiated. A minimum value of 2 cm. H<sub>2</sub>O was found. This value was also found to depend on the condition of the tissues. In the example cited above (in which the values of P<sub>s</sub> for initiation were 3 cm. H<sub>2</sub>O and 8 cm. H<sub>2</sub>O at the beginning and end of a session, respectively, the corresponding minimum values to sustain vibration were 2 cm. H<sub>2</sub>O and 4 cm. H<sub>2</sub>O, with flow rates of 110 cc/sec and 380 cc/sec respectively.

For values of subglottal pressure slightly below those required for spontaneous phonation, vibrations could sometimes be started by deflecting the thyroid cartilage or the folds themselves. With P<sub>s</sub> very near the critical value, only the slightest disturbance (such as banging on the table)

was required. Cases were noted where actual phonation began after an initial period during which small growing vibrations were evident. This result suggests validity for the modelling concept of predicting phonation on the basis of instability of a small-signal model (Ishizaka and Matsudaira, 1968; Stevens, in preparation).

#### Regulation of Phonation

Phonation could be regulated either by varying the configuration of the laryngeal tissues or by adjusting the subglottal source. Only the effect of subglottal pressure variations on fundamental frequency were studied quantitatively.

Previous work with excised larynxes (e.g. van den Berg and Tan 1959; Anthony, 1968) utilized volume-velocity regulators for the subglottal source. The results of these studies suggest that  $F_0$  varies with  $P_s$  at an average rate of 5 to 7 Hz/cm  $H_2O$ , when subglottal pressure is varied by adjusting source flow-rate.

Some experiments were carried out in which the pressure-regulator subglottal source was used. In these experiments, pressure was varied in 1-cm  $H_2O$  steps. It was found that fundamental frequency varied with subglottal pressure at a rate of 5-7 Hz/cm  $H_2O$ , and flow rate also increased as pressure increased.

Figure 6-2 shows the results of one such run, comprising

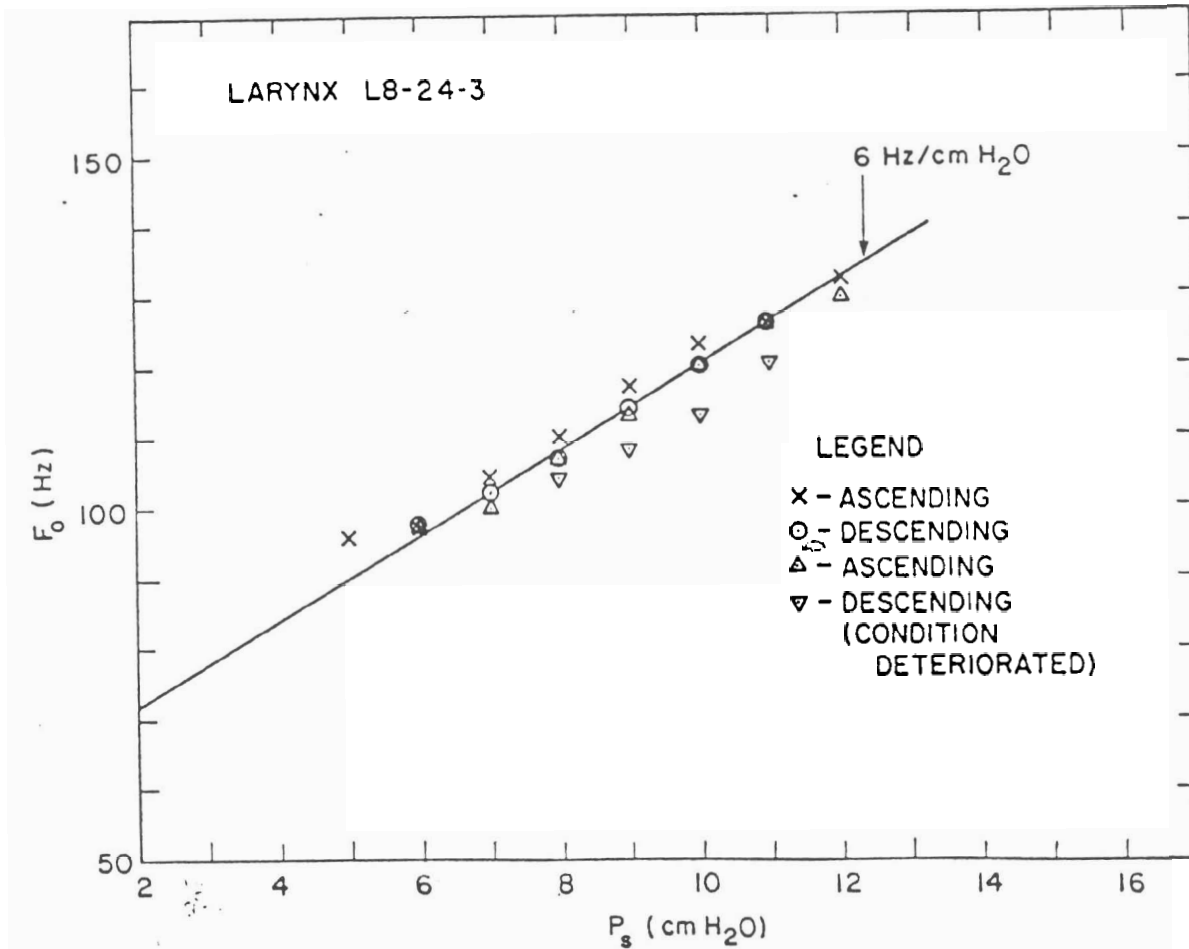

FIGURE 6-2

Fundamental frequency vs. subglottal pressure during a single run. The condition of the larynx deteriorated toward the end of the run. The 6 Hz./cm. H<sub>2</sub>O is a subjective fit to the data.

two ascending-descending series. For most of the range over which  $P_s$  was adjusted,  $F_o$  varied at a rate of about 6 Hz/cm  $H_2O$ . Toward the end of the run, when the tissues were severely desiccated,  $F_o$  became less sensitive to pressure changes. (In other experiments, rates below 3 Hz/cm  $H_2O$  were measured with desiccated preparations.) Results of a run with another larynx in which variations of both  $F_o$  and  $U_g$  were measured are displayed in Fig. 6-3. The slope of the  $F_o$  versus  $P_s$  line is about 5 Hz/cm  $H_2O$  in this case. The figure shows that volume velocity increased as subglottal pressure was raised. It also indicates that little systematic effect on  $F_o$  resulted from increasing tension on the adductory threads. (Their initial tension caused a closed no-flow glottis.) This lack of influence conflicts with van den Berg's findings (van den Berg and Tan, 1959).

In Fig. 6-3, the arytenoid cartilages separated somewhat for the highest subglottal pressures during the first run but not for the second run, due to increased adductory tension. The resulting airflow rate is higher in the first run. This illustrates that, in interpreting such experiments, it should be remembered that the laryngeal configuration was held constant in the sense that the thread adjustments were not changed, but not necessarily in the sense of maintaining the cartilages in fixed position.

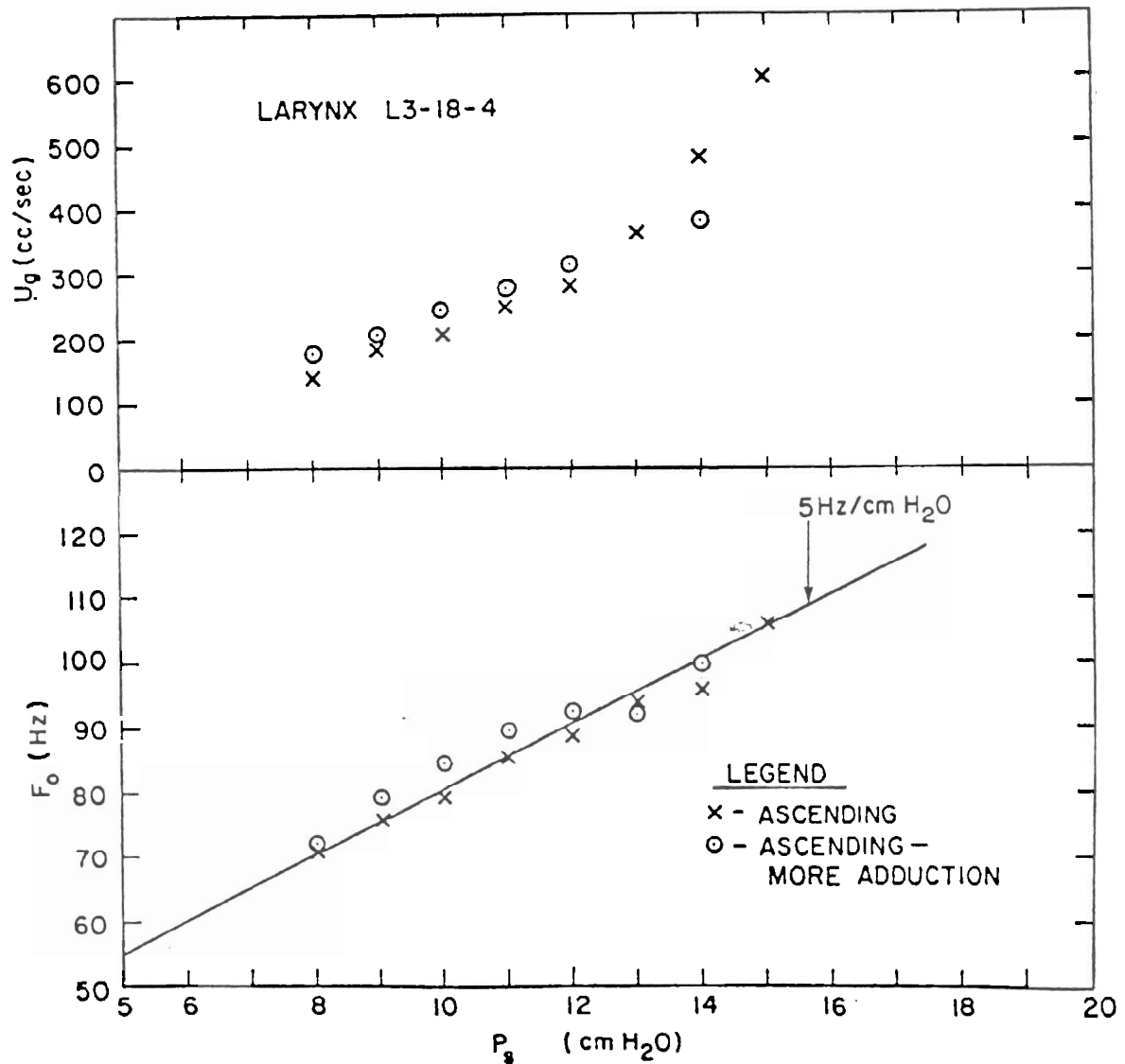

FIGURE 6-3

Fundamental frequency and flow rate versus subglottal pressure for a single run. Two ascending series with differing adductory tension are represented. The 5 Hz./cm. H<sub>2</sub>O line is a subjective fit to the data.

The rate of change of  $F_0$  with  $P_s$  was not always constant over its whole range. Figure 6-4 shows the results of one experiment in which the average slope was about 5 Hz/cm  $H_2O$  over a range that would be normal for human phonation. At the higher range, however, the rate was 3.5 Hz/cm  $H_2O$ .

Figure 6-4 also illustrates another phenomenon. In some (but not all) experiments, a systematic difference was noted between runs with ascending and descending changes in subglottal pressure. The explanation for the hysteresis effect is not known. It may reflect only the cumulative drying effects of flow on the condition of the laryngeal tissues. Another possible explanation, however, is that shifts occur at the high and low extremes so that ascending and descending series represent slightly different vibration modes.

Some runs were made with open no-flow glottal configurations (as wide as 1 mm.). The rate of change of  $F_0$  with  $P_s$  was found to be within a similar range - about 4.5 to 7.5 Hz/cm  $H_2O$ .

Figure 6-5 illustrates the effect of lengthening the vocal folds (without register change). Fundamental frequency at a fixed value of subglottal pressure increased. Variations of fundamental frequency with subglottal pressure were similar in the two glottal conditions.

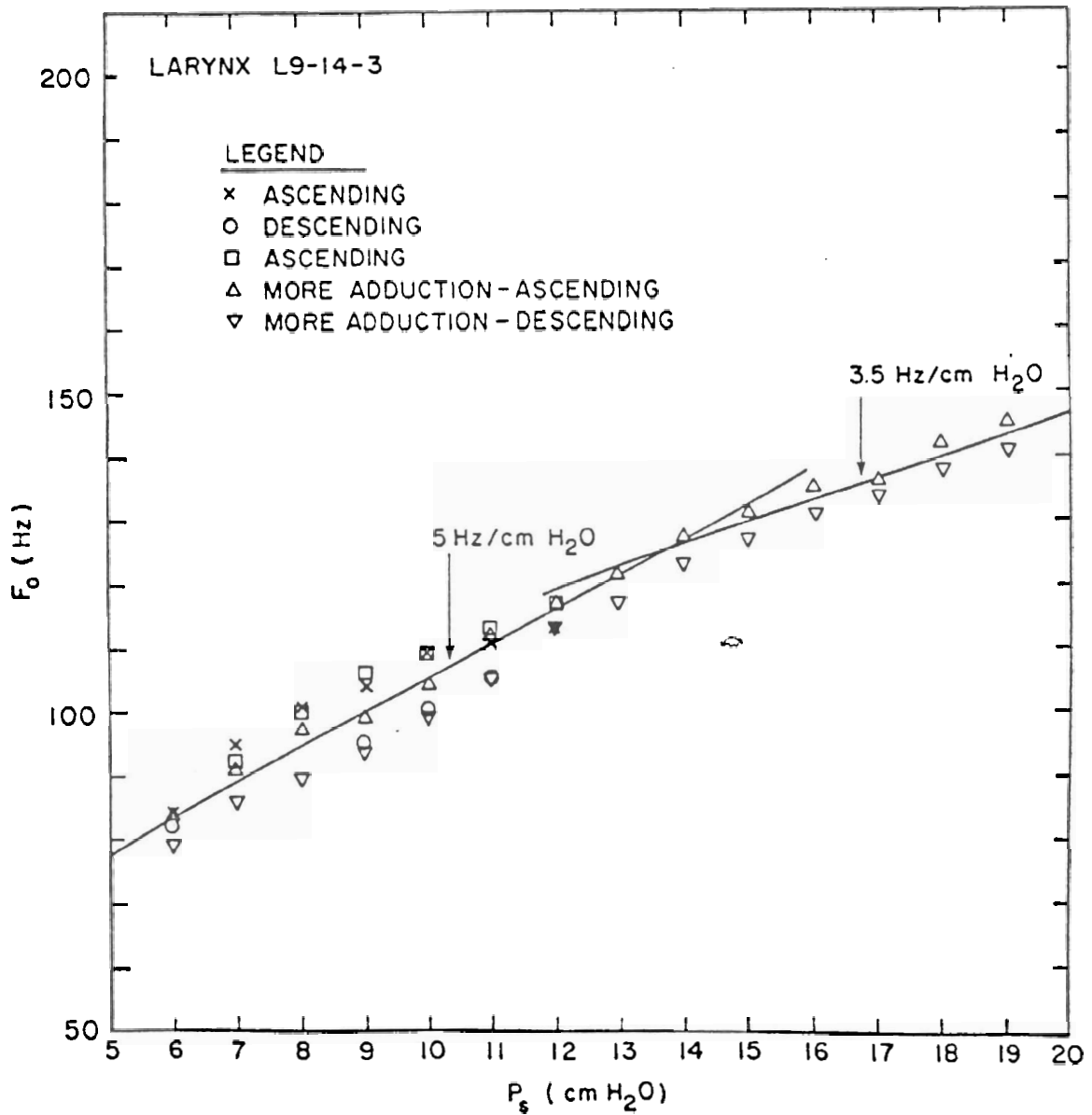

FIGURE 6-4

Fundamental frequency versus subglottal pressure for an extended range of subglottal pressure. The 5 Hz./cm. H<sub>2</sub>O and 3.5 Hz./cm. H<sub>2</sub>O lines were fit subjectively to the data.

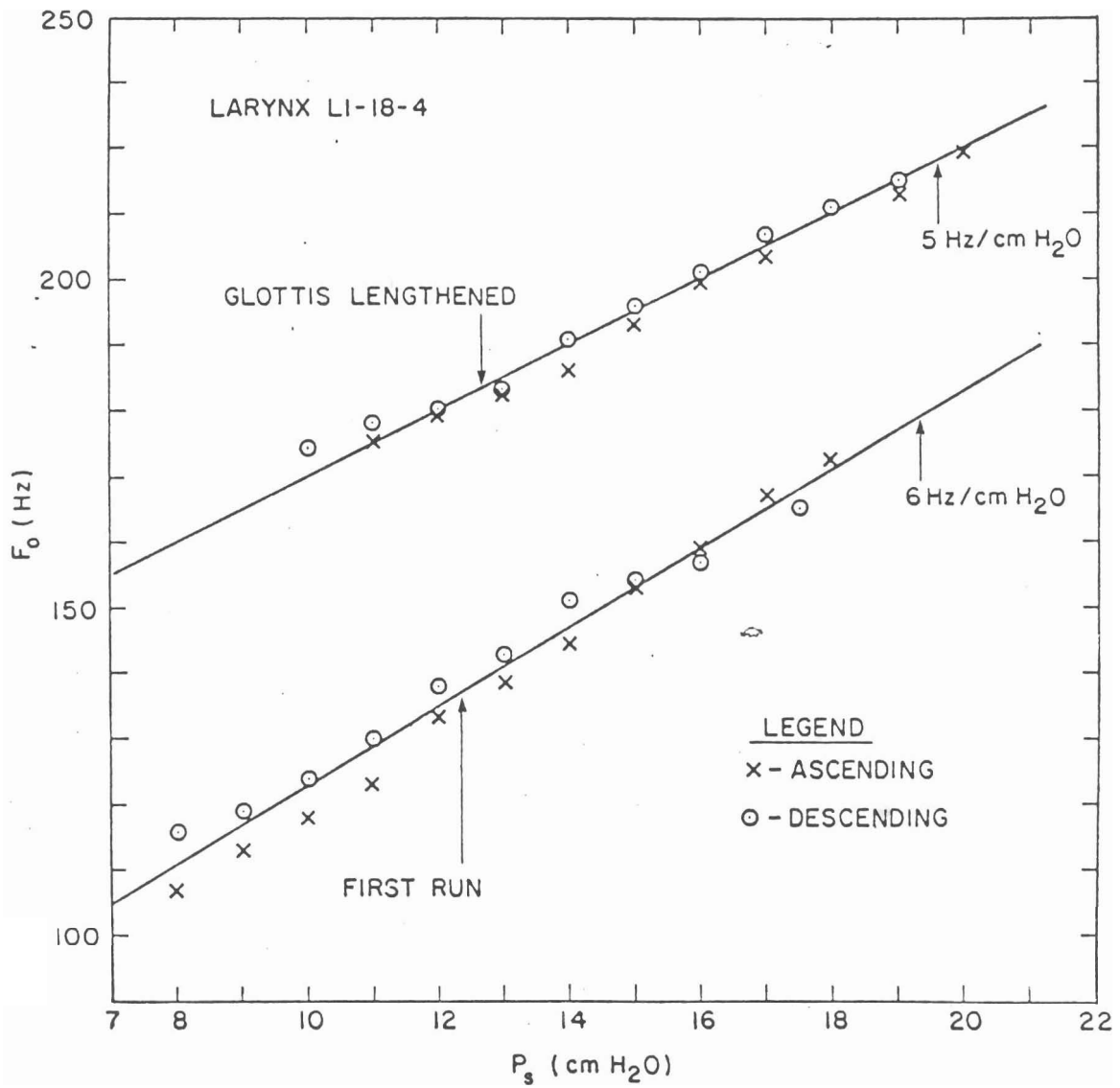

FIGURE 6-5

Fundamental frequency versus subglottal pressure for two different glottal lengths. The 5 Hz./cm. H<sub>2</sub>O and 6 Hz./cm. H<sub>2</sub>O lines were fit subjectively to the data.



It was already noted that the dependence of  $F_0$  on  $P_s$  decreased when preparations became desiccated. In this condition, dependence on length of the vocal folds also changed. Sometimes,  $F_0$  actually decreased or phonation stopped completely if the glottis was lengthened, and  $F_0$  sometimes increased if the glottis was shortened. The inability of these preparations to produce falsetto was already noted.

## Chapter 7 Results II: Detailed Measurements

This chapter is concerned with measurement of the mechanical vibration patterns and of properties of the vocal folds at a detailed level. That is, it is concerned with movements of the vocal fold surfaces or of individual particles on these surfaces. The chapter is organized into four major sections, each of which consists of a presentation of results followed by analysis and discussion. The first section is concerned with the measurement of steady state vibrations representative of normal phonation. It contains the most important results in the thesis. The second section concerns measurements of vibration patterns during phonation which was not steady state since tissue properties were changing. The third section concerns vibration patterns from preparations which were altered by removal of one or both vocalis muscles. Finally, the fourth section relates measurements of the varying static position of the vocal folds as subglottal pressure was varied at levels below those for which phonation was initiated. Such measurements are useful for determining mechanical properties of the vocal folds, as will be discussed in the following chapter.

IA Data from "Normal" Phonating Larynxes  
Amplitudes and Directions of Vibration

An initial set of measurements and observations was made to establish some general aspects of the vibration patterns. These aspects include range of amplitude of vocal-fold vibration to be expected and the region of the vocal fold surface over which vibration is observed.

Figure 7-1 shows the outline of a vocal fold in frontal section. The envelope of points of maximum excursion is drawn, based on measurements of the amplitudes of vibration of the surfaces at five different vertical levels as measured from the subglottal aspect. Also indicated are estimated shapes of the vocal fold at two phases in the vibratory cycle. During the closed period, just before opening, the depth of glottal closure is very small (the order of 0.1 mm), so that the superior surface of the fold and the undersurface are at almost the same level. The lowest level at which closure occurs is about 3 mm. lower. At this level and lower, particle trajectories have larger horizontal than vertical components. For the case shown, the total horizontal excursion for a particle at the lowest level of closure is about 1.2 mm. At a level 2.3 mm. lower, the excursion amplitude is only 0.3 mm. At 7.5 mm. still lower, there are very small (less than 0.1 mm.) vibrations that are probably related to the complex acoustic pressure variations

FIGURE 7-1

Outline of the frontal section of a vocal fold during phonation based on measurements from the inferior aspect. The envelope of the vibrations (the locus of maximum excursions) is indicated by solid lines. The estimated shapes at two instants in the cycle are indicated by broken lines where they do not lie along the envelope of the vibrations. The plotting symbols represent actual measurements. The accompanying text contains observations recorded during the experiment. The tick marks approximately delimit the region in which measurements shown in the rest of this chapter were taken.

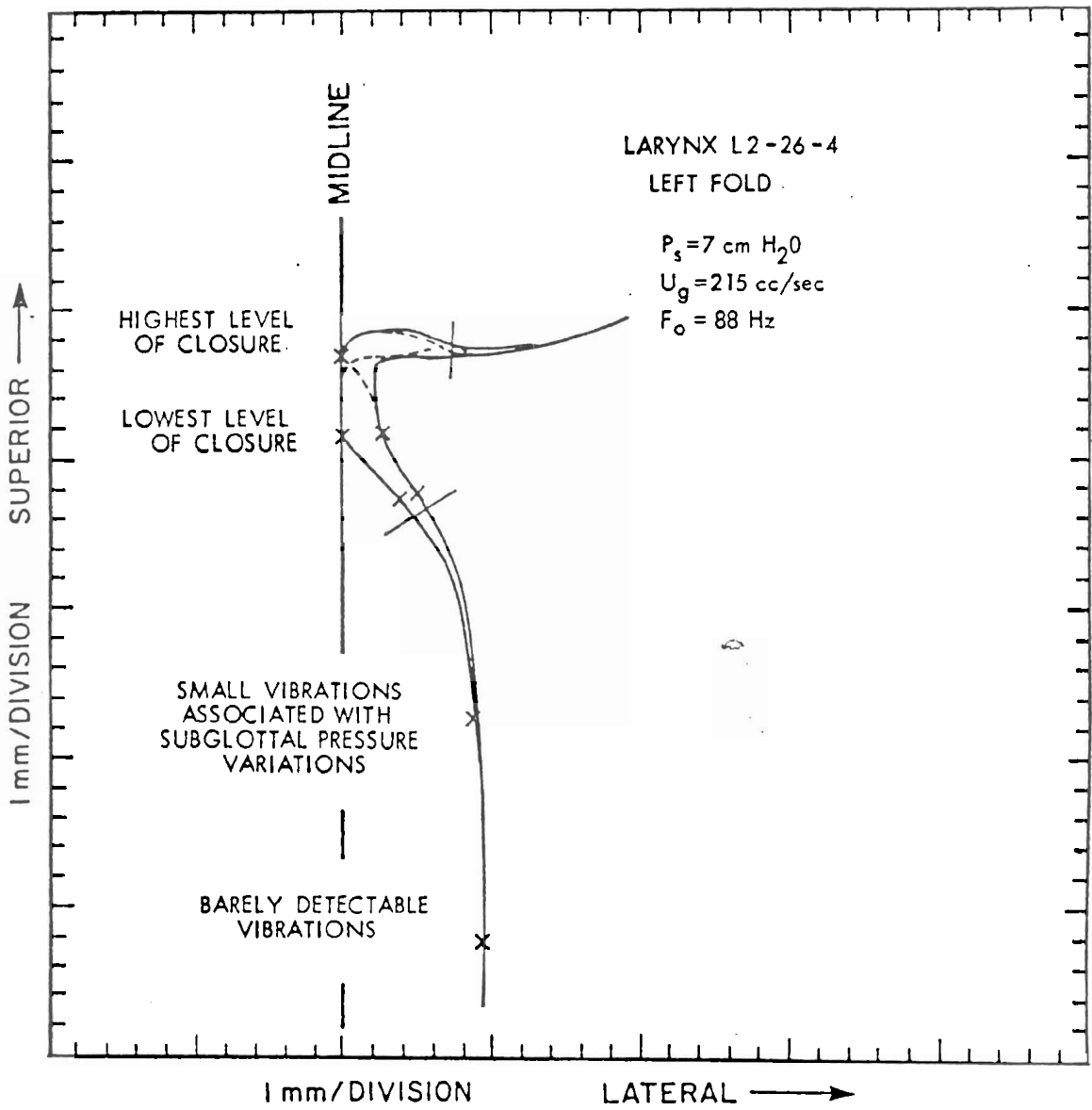

in the pseudotrachea. On the upper surface of the folds, the movements (not shown in this figure) are complex near the midline, where vibration amplitudes are generally in the range of 1-3 mm. Vertical components are largest on this part of the surface. More laterally, vibrations are essentially vertical and amplitudes become smaller. Though smaller movements can be detected very far laterally (1 cm. in the case shown), they become very small (less than 0.1 mm.) beyond about 5 mm. from the midline.

Measurements to be discussed in this chapter were taken from several larynxes over a range of locations roughly corresponding to the region between the tick marks in Fig. 7-1.

#### Particle Trajectories

Figure 7-2 contains the main experimental results of the thesis. Its various parts show the trajectories of 11 different particles (measured in 8 different runs on 6 different larynxes), as estimated from measurements at eighth-cycle increments.\* These data were collected over a period of about 1/2 year during which the apparatus, techniques, procedures, and methods of data interpretation were undergoing development. Consequently, the set of information

\* With the exception of Part F, these runs are all thought to represent normal phonation. In part F, open quotient was smaller than that encountered in normal phonation.

## FIGURE 7-2 (A-H)

Measured trajectories of particles during eight different runs. The measured particle positions are indicated by the plotting symbols. The trajectories are arbitrarily drawn by hand. The midline positions are drawn from estimates or approximate measurements, as indicated. The inset on the right of each figure tabulates additional information about each run. The regulated source variable ( $P_S$  or  $U_G$ ) is listed first in each case.  $\theta$  is the rotation angle of the tabletop (see Chap. 5). Notes and sketches recorded during the experiment are included in the inset. The sketch on the upper left of each inset shows schematically the general orientation of each particle being tracked.

LARYNX L3-8-3

LEFT FOLD

$U_g = 350$  cc/sec

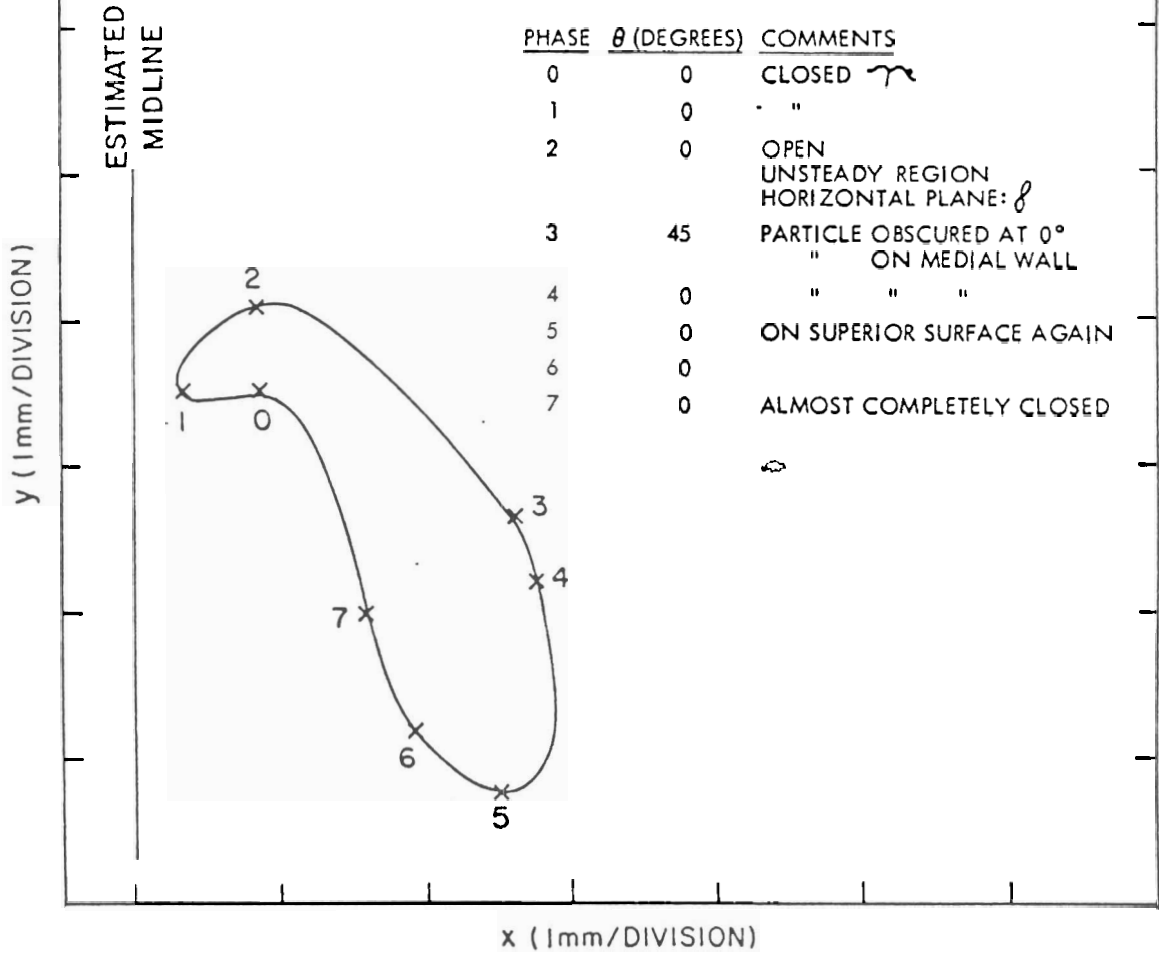

A



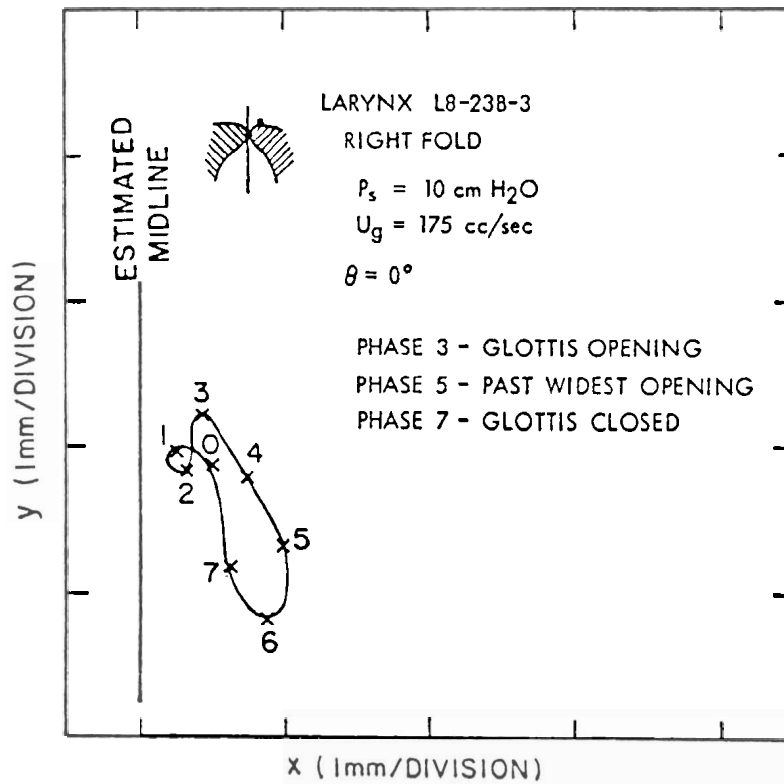

B

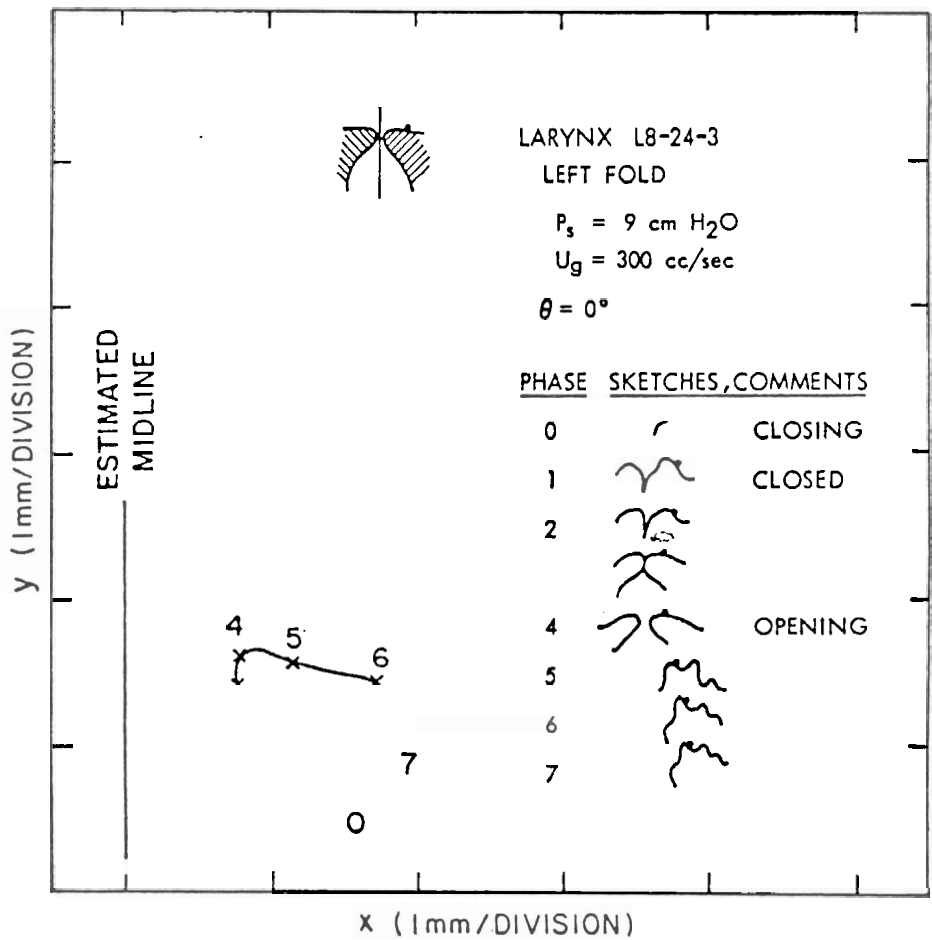

C

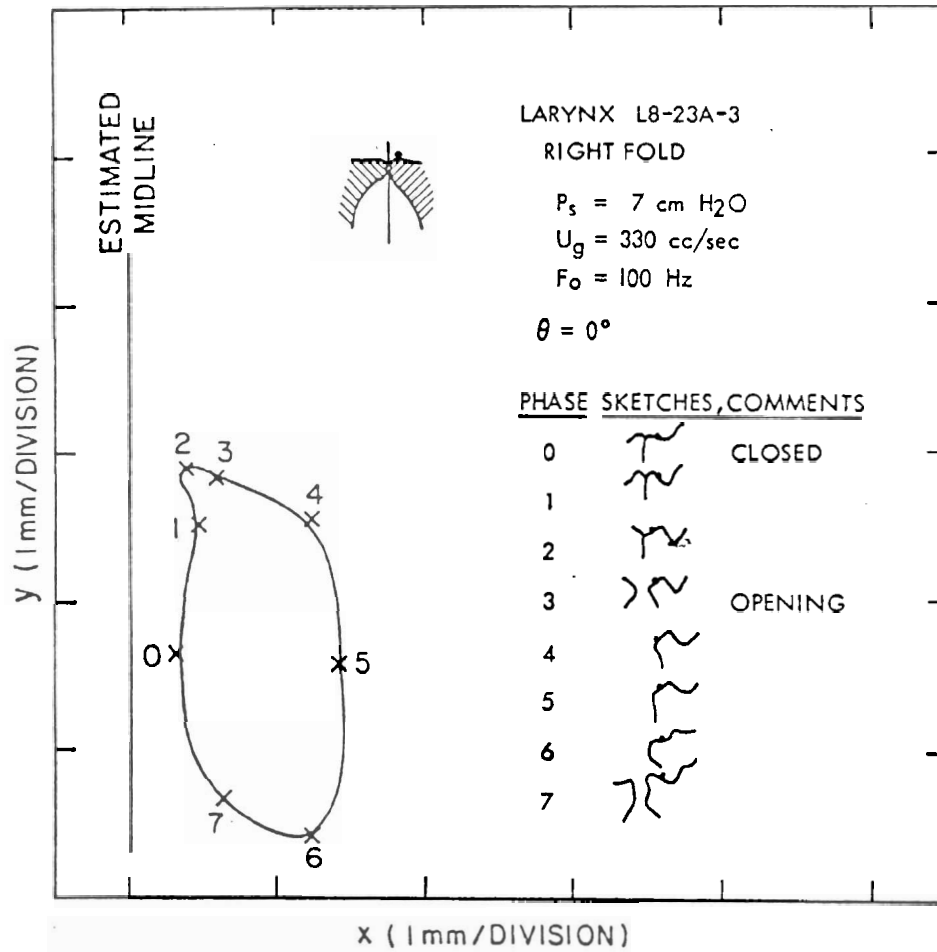

D

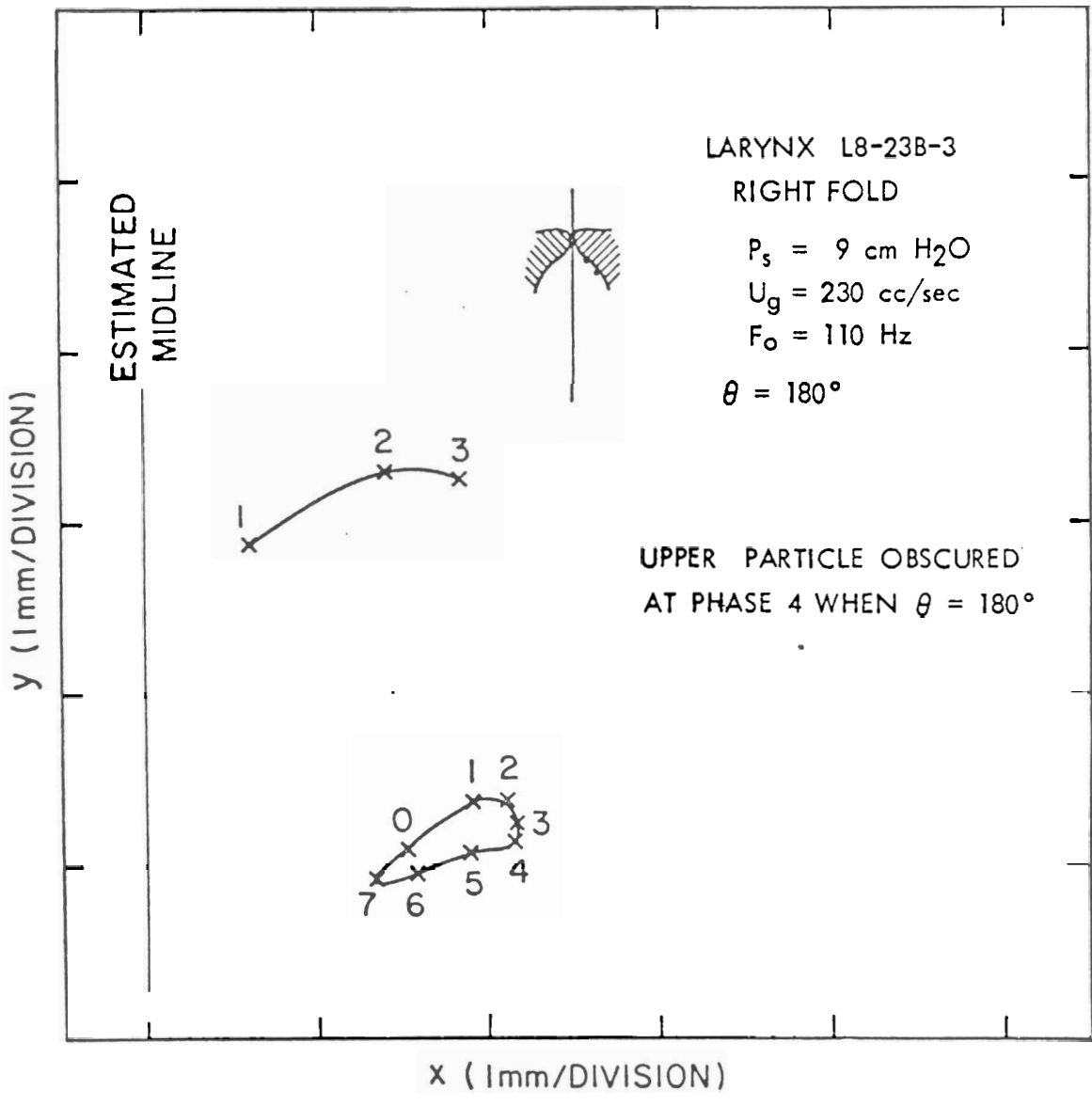

E

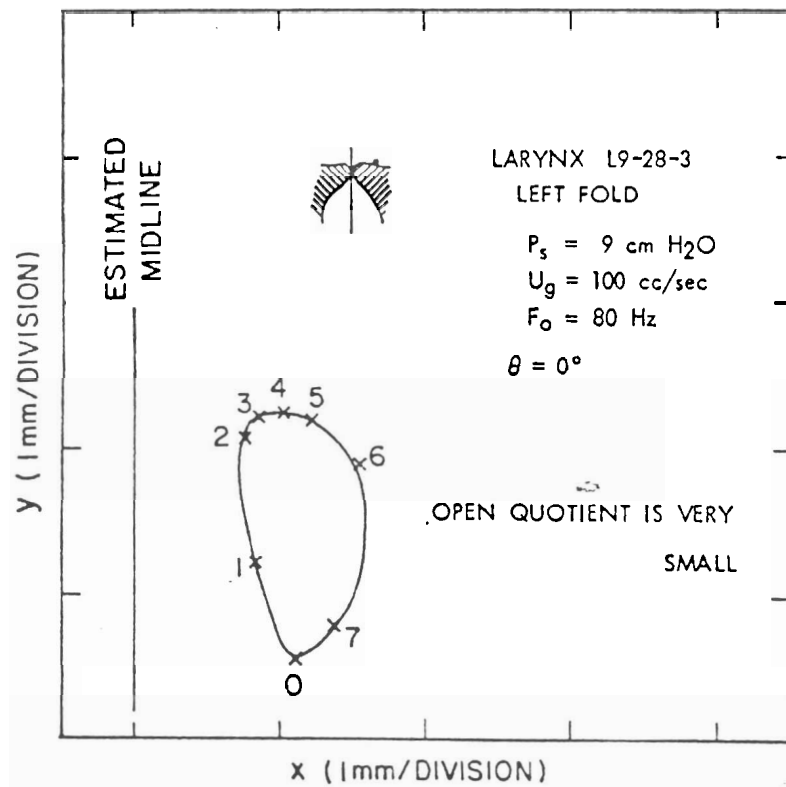

F

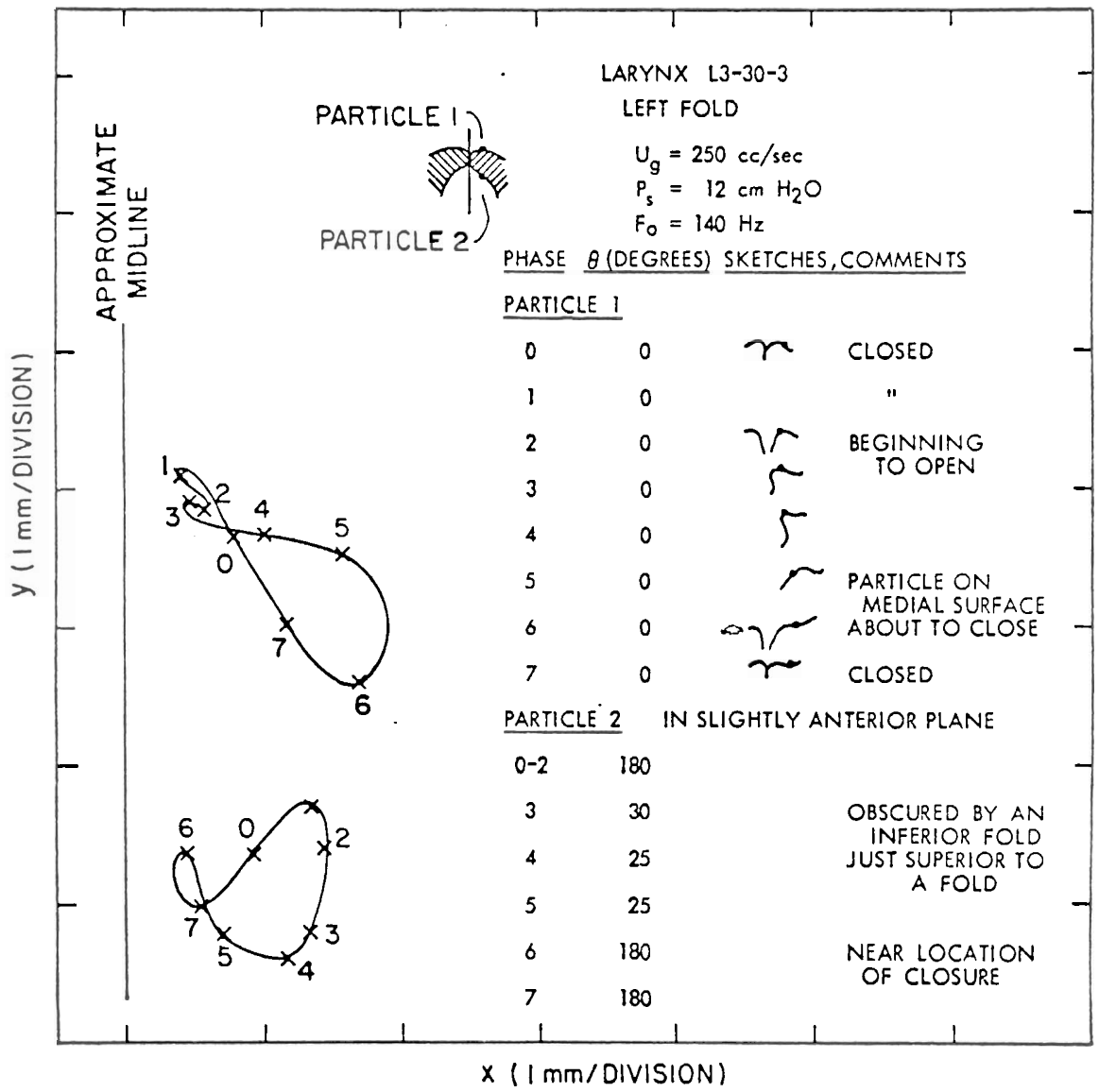

G

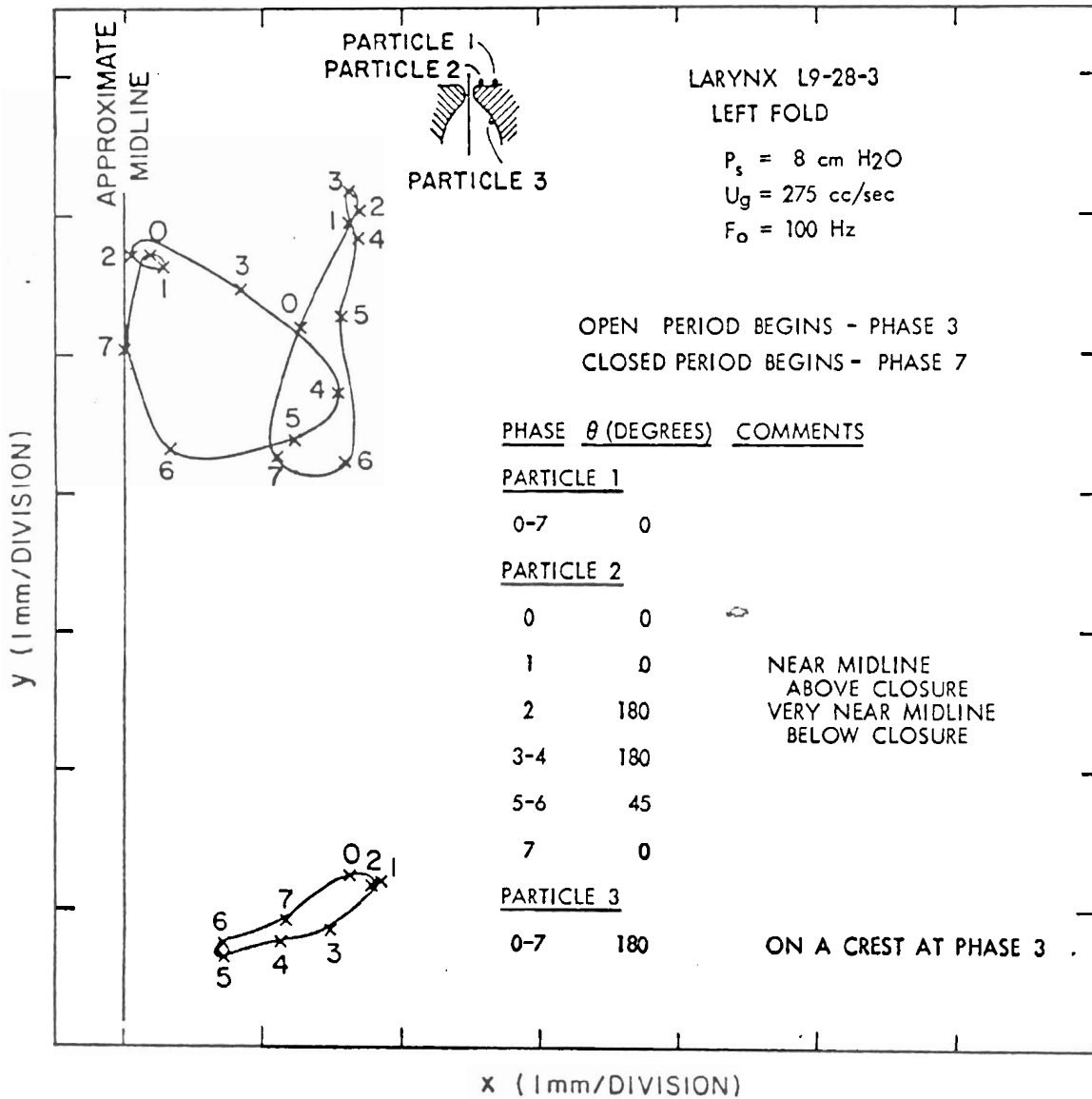

H

available in addition to the trajectories in each case is generally incomplete. However, the types of information available include subglottal pressure ( $P_s$ ), airflow rate ( $U_g$ ), fundamental frequency ( $F_0$ ), phase interval of glottal opening and closure, approximate location of the midline, and rough sketches of the vocal fold shape in the region of the particle. The information available for each trajectory is indicated within the figure. The observation angle,  $\theta$ , was defined in Chapter 5. Even where actual measurement of the midline position was not made, or sketches of the overall shape not recorded, an attempt has been made to estimate them in the different parts of Fig. 7-2, in order to provide a better context for the trajectories.

Several details concerning parts of the figure are pointed out here. The figures show data from both left and right vocal folds (as indicated in the plots), but by convention they are plotted in an X-Y coordinate system where X increases in the lateral direction for the fold concerned and Y increases in the superior direction. In almost all cases, data were collected for only one fold. For most purposes, bilateral symmetry may be assumed. It should be noted, however, that the midline is not accurately determined even when its X location is measured at one Y level. The apparatus does not constrain the midline to the Y axis,



and deviations of  $5^\circ$  or  $10^\circ$  in either direction are possible. Particles were generally in the anterior and posterior middle third of the vibrating portion of the folds, so that they were at or near the region of maximum excursion amplitude. Finally, the oscilloscope's trigger point on the pressure waveform (i.e. phase 0) does not occur at any specific identifiable part of the cycle, though it is often during the closed period.

Inspection of Fig. 7-2 indicates that the trajectories are usually not simple. In general, they are well characterized by neither straight lines nor ellipses, but a useful characterization may be elliptical with perturbations. For particles furthest from the midline, such as in Figs. 7-2E and H (particles 1 and 3), the trajectories are usually nearly elliptical, and sometimes well approximated by straight lines. Nearer the midline, trajectories are usually more complex, and the main "elliptical" part is usually more circular. When the particles are on the superior surface, a perturbation occurs near the supero-medial part, as in Figs. 7-2A and D. Sometimes this may become a secondary loop or more complicated shape, as in Fig. 7-2G (particle 1) or 7-2H (particle 2). Secondary loops may also appear for particles on the subglottal aspect, as in Fig. 7-2G (particle 2), if the particle's level is high enough and it comes sufficiently near the midline.

In all cases, the particles traverse the main parts

of their trajectories in the clockwise sense (for the coordinate convention we have adopted). That is, the lateral-going parts are superior to the medial-going parts. For particles on the inferior aspect (as indicated in Figs. 7-2G and H) motion is generally superior and lateral during the closed period and inferior and medial during the open period. Figures 7-2A, B, C, D, G, and H show that particles on the superior surface not too far from the midline include the closed period in at least part of the superior-medial-going part of the trajectory. The perturbation, when present, occurs at the end of the closed period, and the trajectory is subsequently lateral- and inferior-going during the open period. For more than half of these particles (viz., those in parts A, D, G, and H), it can be determined either from the sketches, the notes, or the record of observation angles in Table 7-1, that the particle appears to be on a medial-facing surface during at least part of the open period though it is clearly on the superior surface for much of the cycle.

In Figs. 7-2G and H, "simultaneous" trajectories are shown for 2 and 3 particles, respectively. That is, for both cases, data were collected during a period in which the phonatory state of the preparation was approximately constant.

In Fig. 7-2G, as described above, particle 2 (on the

undersurface of the fold) moves upwards and laterally during the closed period while particle 1 (on the superior surface) moves upwards and medially. Both trajectories exhibit perturbations at their medial extremes. There appears to be a phase lag of about 3 eighth-cycle increments from parts of the trajectory for particle 2 to corresponding parts for particle 1.

In Fig. 7-2H, the trajectory of particle 2 actually touches the midline. At its lateral extreme (phase 4), particle 2 is lateral to particle 3, which is approaching its medial extreme. This illustrates that the total horizontal excursion of a particle is often greater than the maximum half-width of the glottis itself, due to vertical phase differences.

Particles 1 and 3 in Fig. 7-2H both have very flat trajectories, the former primarily vertical and the latter primarily horizontal. Considering displacement as positive directed outward from the vocal fold surface, the trajectory of particle 1 lags behind that of particle 3 by about 5 phase increments. On the other hand, if supero-lateral displacements are considered positive for both, the forms of the trajectories become strikingly similar, and the apparent phase lag is only 1 phase increment.

Considering the trajectory of particle 2 and the accompanying information in the inset of Fig. 7-2H, it is

noted that the particle moves from the superior surface of the folds to the undersurface (at phase 2) during the closed period. During the first part of the open period, it is clearly on the glottal wall rather than the superior surface of the fold. Comparing the trajectory of particle 1 (which is clearly on the superior surface), it can be noted that the trajectories intersect. The particles are at about the same horizontal level near phase 6 (the latter part of the open period). At phase 4, during the open period, they are nearly alligned vertically. A straight line drawn from particle 2 to particle 1 rotates counterclockwise from approximately phase 7 to phase 4 (the closed period and part of the open period) and then clockwise back to phase 7 (the rest of the open period).<sup>6</sup>

#### Trajectories of Nearby Particles

Fig. 7-3 shows the positions of 2 particles on a supraglottal surface during part of a glottal cycle including the last part of the closed period and the early part of the open period. The particles are close enough that a straight line between them can be assumed to represent the local orientation of the vocal-fold surface. From a horizontal orientation at phase 7, the line rotates counterclockwise to nearly a vertical orientation at phase 3. For the rest of the cycle, the particles are not visible without rotating the optical axis, so presumably the surface is medial-facing.

## FIGURE 7-3

Measured frontal-plane positions of two supraglottal particles during part of a glottal cycle. The format of this figure is similar to that of Fig. 7-2.

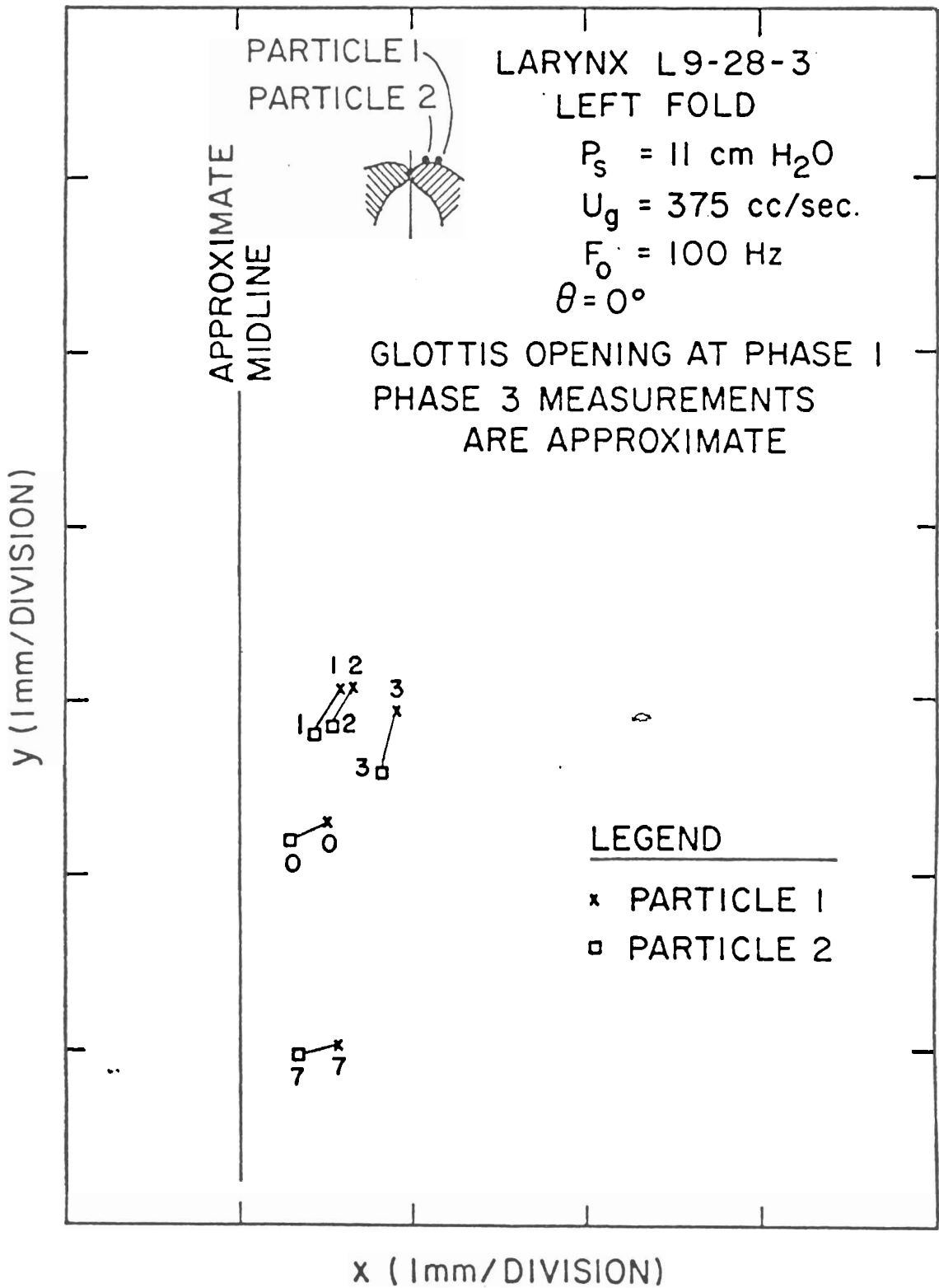

Supraglottal Wave

During phonation, a displacement wave can be quite clearly seen propagating in the lateral direction on the superior surface of the vocal fold. The crest of this wave appears to build up near the midline during closure and it continues to propagate during the open period. From informal measurements, the propagation velocity of the wave over the muscular part of the supraglottal surface was determined to be 0.3 to 0.5 m/sec.

Fig. 7-4 shows measurements in the frontal plane of the position of the estimated wave peak at eighth-cycle increments for a single run. Within the half cycle from phase 3 to phase 7, where the measurement is over the muscular part of the fold, the apparent velocity is 0.5 m/sec. The lines drawn through the data points at phase increments 0, 1, and 2 indicate successive shapes of the vocal fold during the closed period. The extra rapid movement from phase 2 to phase 3 is probably related to glottal opening, which occurs during this period. This figure illustrates that buildup of the wave seems associated with the closed period, while lateral propagation over the muscular part of the folds begins during the open period.

Glottal Closure

Closure, though not a necessary part of phonation in general, accounts for a significant part of the normal phonatory cycle. It should be borne in mind, however, that

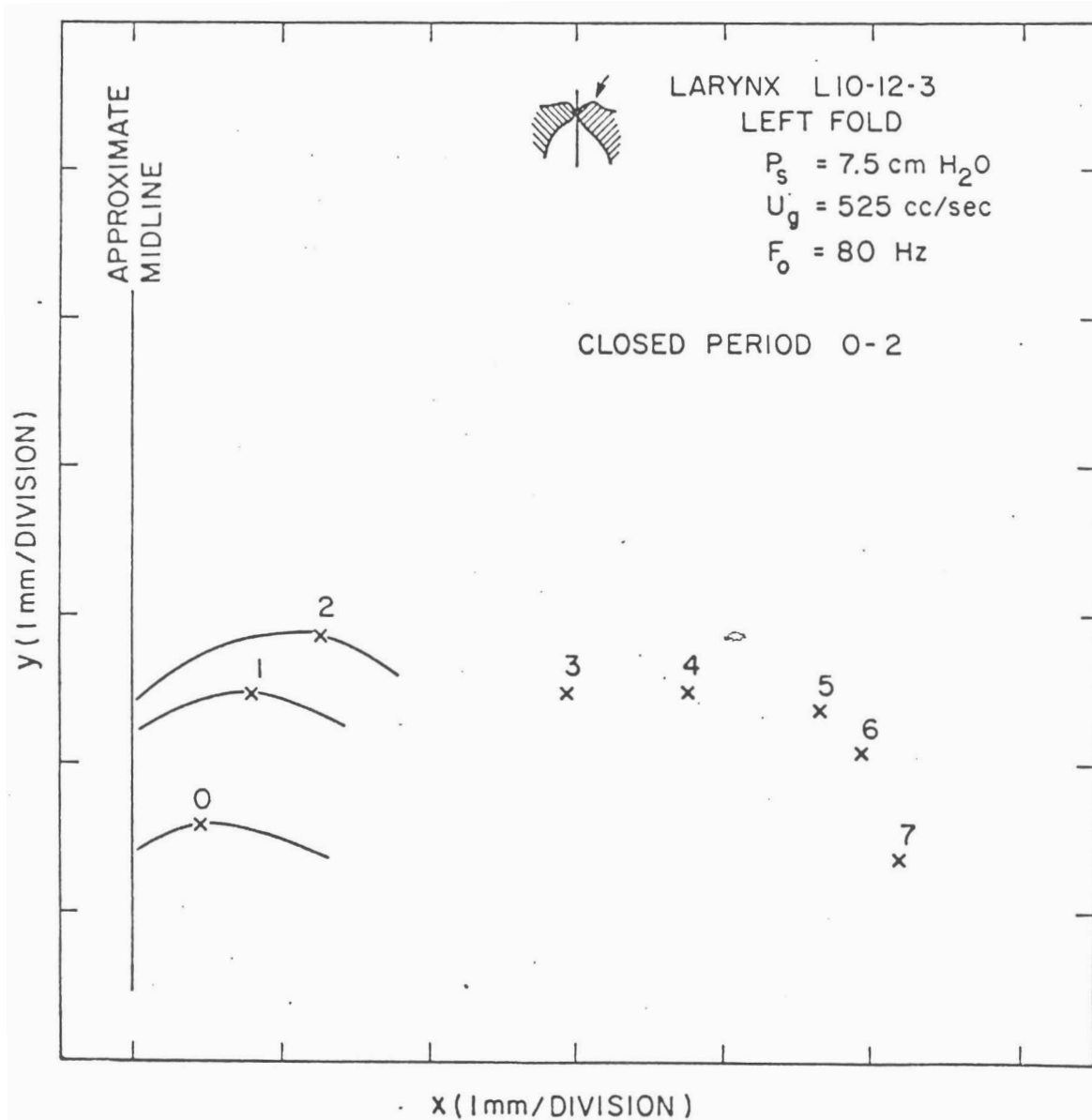

FIGURE 7-4

Frontal plane positions of a peak of the supraglottal wave throughout a cycle. The lines show the shapes of part of the vocal fold surface during the closed period. The format of this figure is similar to that of Fig. 7-2.



it is a variable phenomenon - occurring to varying degrees and possibly in different manners. Thus, results of measurements on one larynx or in one run may not apply to other larynxes or other runs.

Several results have already been noted: Figs. 7-2G and H indicate that closure is a wavelike phenomenon, at least in the sense that particles just below the region of closure move laterally while those just above it or lateral to it move toward midline. Fig. 7-2H seems to indicate that the region of closure can propagate past a particle, so that the particle is above closure at one phase increment but below it at the succeeding increment. Also, it was noted at the beginning of this chapter that the depth of closure may be infinitesimally small just before the glottis opens.

Qualitative observations from the subglottal aspect indicate that the vocal folds often form an acute angle in the frontal plane at the initiation of closure, as sketched in Fig. 7-5A. However, near the end of the closed period, the undersurface is often more dome-shaped, as sketched in Fig. 7-5B.

Some observations are also in order concerning the importance of surface tension between the two folds during closure. In several experiments, attempts were made to vary the surface properties using soap solution and photographic wetting agents. It was not possible to do systematic

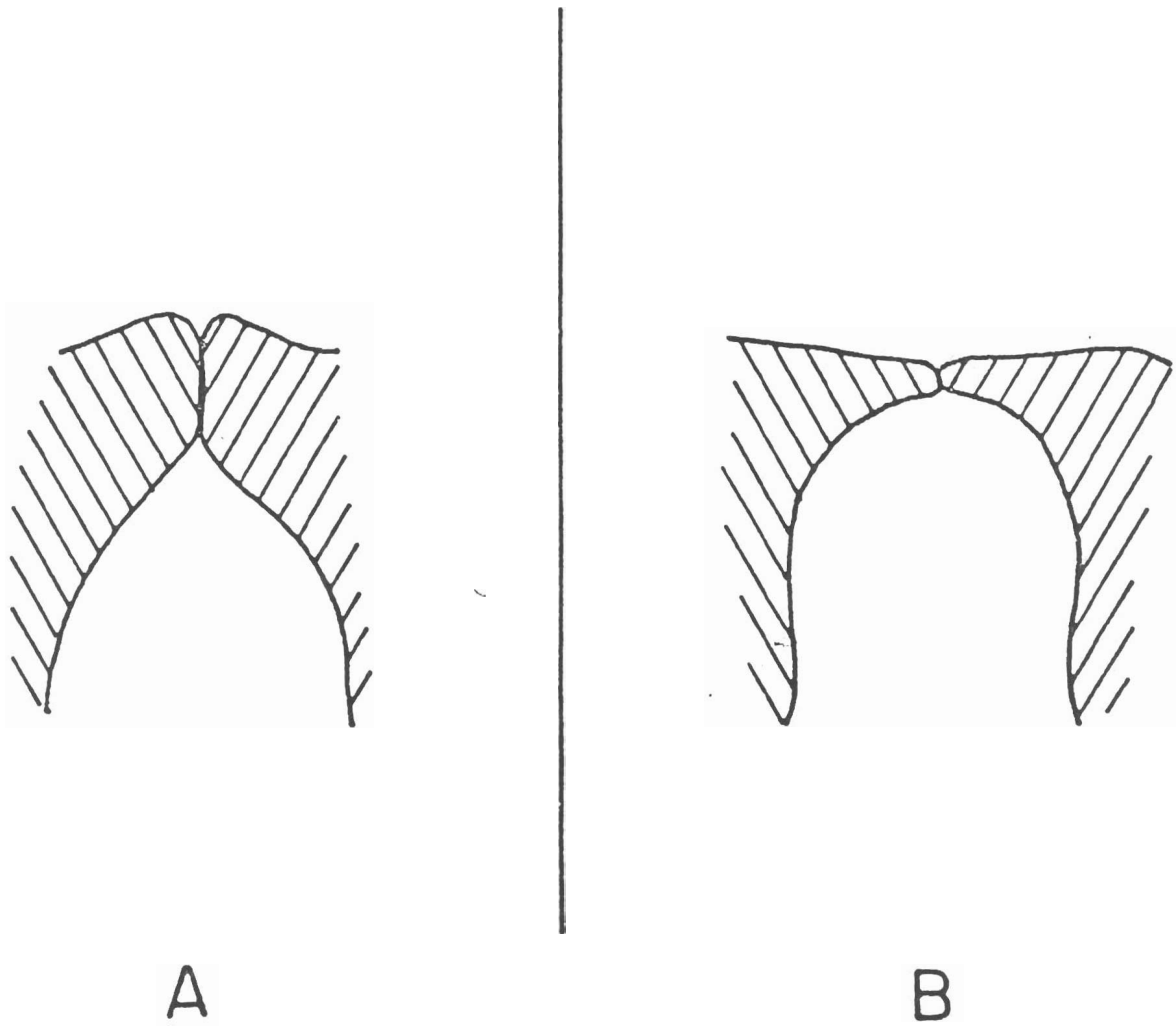

FIGURE 7-5

Schematic drawing showing the shape of the subglottal surface of the folds during the closed period.  
(A) Beginning of the closed period.  
(B) End of the closed period.

experiments of this type, but in informal experiments, no gross effect on phonation was noted. Some minor effects of surface tension in static situations were observed, however. With the larynx in a completely adducted state and with no subglottal pressure applied, heating of the subglottal tract (see Chap. 5) caused a buildup of subglottal pressure to about 1 or 2 cm.  $H_2O$ . At about that pressure, surface tension was overcome, the glottis opened momentarily to release the pressure, and then the cycle was repeated. Thus, relaxation oscillations were produced as a result of surface tension. Under some other conditions with the glottis nearly closed, surface effects caused it to close completely, starting from the ends.

Figure 7-6 shows measurements of the vertical position of the top and bottom of closure as a function of phase during the closed periods of a phonatory cycle. The depth of closure is large (over 3 mm.) near the beginning of the closed interval. The locus of the bottom of closure moves upward continuously during the half cycle that the glottis is closed. During one eighth-cycle interval (1.5 msec.), it moves up almost 3 mm. The locus of the upper edge of closure also moves up continuously but at a slower rate. At the last measurement phase within the closed period, the depth of closure is about 0.1 mm.

Fig. 7-7 shows the position of the upper end of

## FIGURE 7-6

Vertical location of closure during three phase increments of a closed period. The plotting symbols represent the measured superior and inferior vertical boundaries of the region of contact between the folds. The line connecting them represents the vertical extent of this contact.

VERTICAL POSITION (1mm/DIVISION)

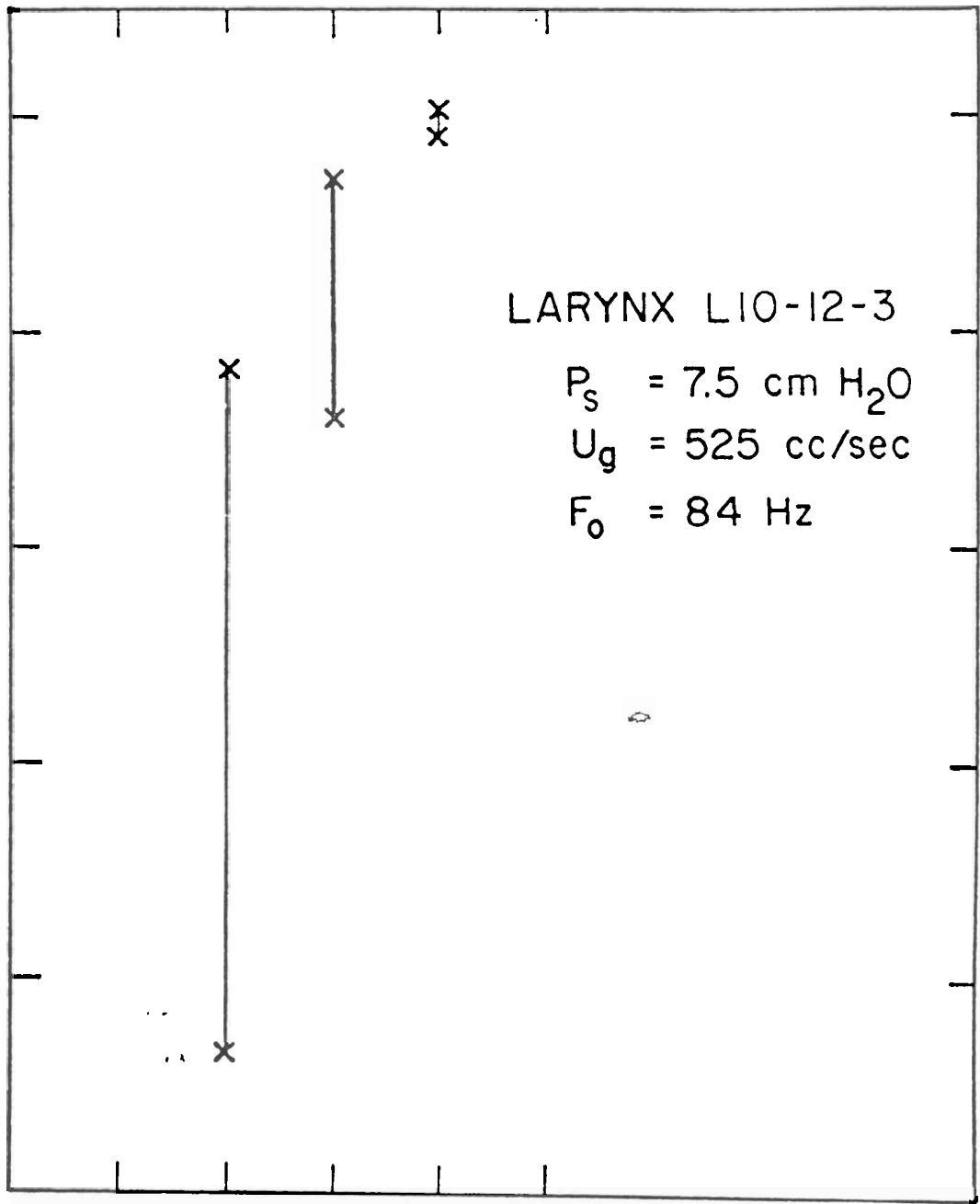

PHASE (1/8 CYCLE/DIVISION)

FIGURE 7-7

Trajectory through a half cycle of a supraglottal particle and corresponding locus of the superior edge of the region of closure. At phase 4 the particle is at the upper border of closure. Rest positions (with  $P_s=0$ ) of both the particle and the region of closure are shown. The static position of the particle (with  $P_s=2$  cm.  $H_2O$ ) is also indicated. At this pressure the glottis was open.

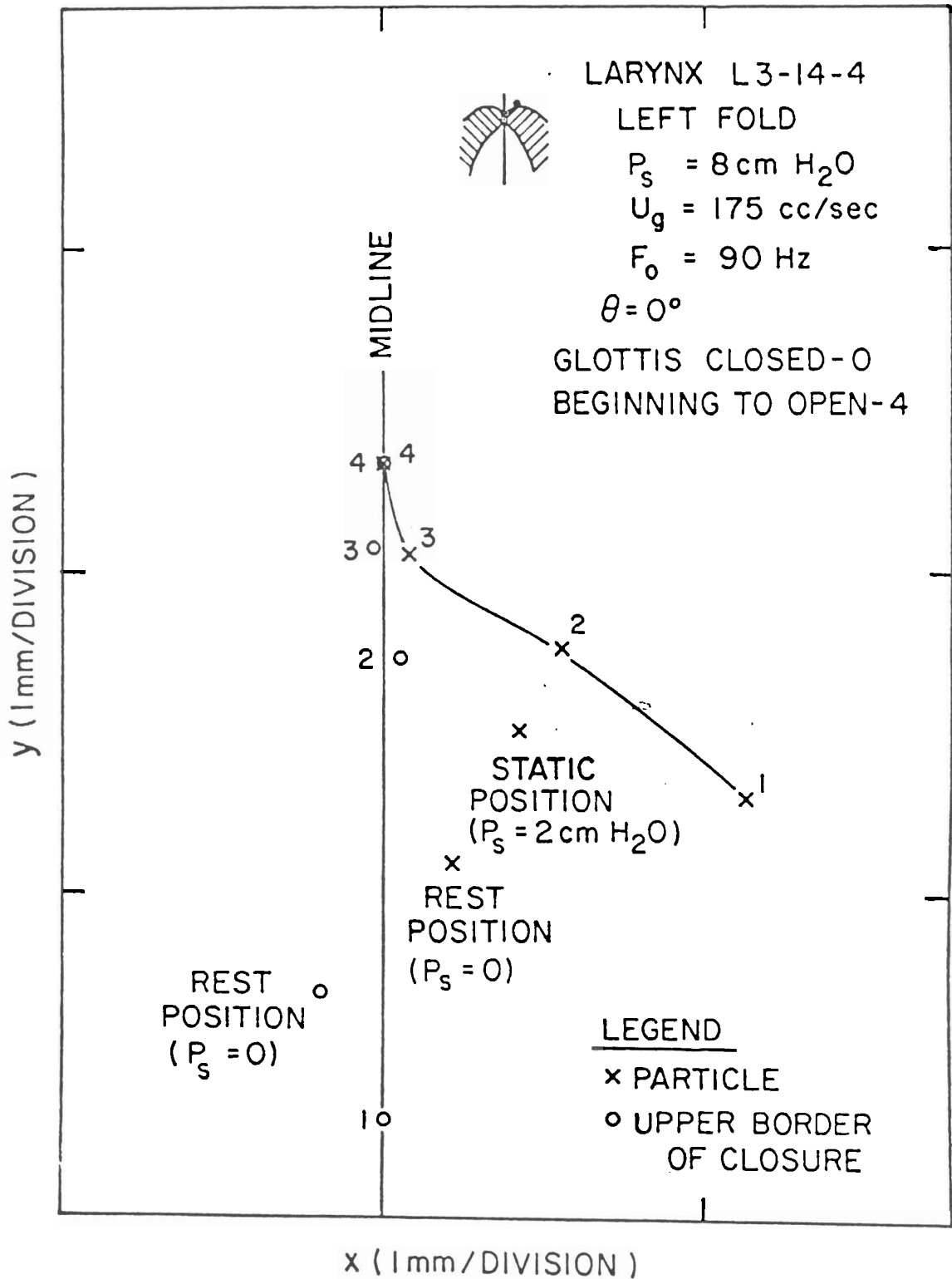

closure and of a particle on the supraglottal surface during the closed period (for a larynx different from that in Fig. 7-6). (The glottis is actually beginning to open at phase 4. At the phase increments preceding and following the interval shown, the particle is not visible from an optical axis parallel to the Y axis.) The particle and upper edge of closure both move upwards and the particle also moves medially during the closed period. At phase 4, the particle is essentially at the midline, and it moves relatively inferior to the edge as the glottis opens. At first the locus of closure moves up faster than the particle, but as they become closer, they move at the same rate.

In Fig. 7-7, the initial rest position (with zero subglottal pressure) of both the top of closure and the particle are indicated. For the closure, this position is slightly above the lowest level during phonation. For the particle, the rest position is vertically below its lowest position during phonation. For the particle, the rest position is vertically below its lowest position during the closed period and horizontally in the middle of the range it sweeps during the closed period. When the pressure is increased to 2 cm.  $H_2O$ , the static position of the glottis is open, and the particle moves up and out, as shown. As the subglottal pressure is increased to 3 cm.  $H_2O$  and



beyond, phonation is initiated, but presumably the associated "static operating point" moves inside the trajectory.

#### Subglottal Pressure Waveform

In much of the work reported here, the subglottal pressure waveform was obtained from the Sanborn Physiological Pressure Transducer coupled to the pseudo-trachea with a 16 ga. hypodermic needle. This system had a poor frequency response. However, a few runs were made with the miniature electret condenser microphone (Thermoelectron 5336 CX) mounted in the wall of the pseudotrachea (see Chap. 5). In both cases, the location of the transducers was on the lateral wall of the pseudotrachea about 10 cm. from the glottis. At this distance, differences are expected between the measured waveform and the actual waveform just below the glottis, but only for spectral components in the range of 850 Hz (the  $1/4$  wavelength frequency corresponding to 10 cm.) and above.

The subglottal pressure waveform exhibited ringing behavior with both transducers, demonstrating a large spectral component around 300-400 Hz, apparently corresponding to a resonance frequency of the subglottal tract (see Chap. 5). No real effort was made either to change the length or the degree of damping in the subglottal tract, or to use gases other than air, so the dependence of this phenomenon on the details of the subglottal tract was not examined.

Fig. 7-8 shows a sketch of a typical waveform obtained from the microphone. Though the forms of the waveform from the microphone and the Sanborn transducer were similar, there were systematic differences when relating the transducer outputs to the glottal area waveform. For both, the broad relative minimum preceding the major peak in the waveform corresponded closely to the maximum in the glottal area waveform. This seemed to be the most stable correlate. The maximum of the first (large) peaks leads to the onset of closure (or minimum glottal area) by as much as 0.1 or 0.2 cycles for the electret microphone, or lags closure somewhat for the Sanborn transducer. Release of glottal closures (when it occurs) does not always correspond to a specific aspect of the pressure waveform. ↻

Peak-to-peak subglottal pressure amplitudes as measured with the microphone were at least as much as 5 cm. H<sub>2</sub>O (or 35% of the average subglottal pressure) in one case and possibly as much as 100% of the average pressure (8 cm. H<sub>2</sub>O) in another case. The exact maximum value is unclear because of a loss of microphone sensitivity (over a period of days), the time course of which was not followed.

## 1B Analysis and Discussion

### General Issues in the Interpretation of Results

In interpreting the results of these experiments, it is useful to bear in mind the often-repeated warning from

FIGURE 7-8

Schematic sketch of a typical waveform from the subglottal electret microphone.



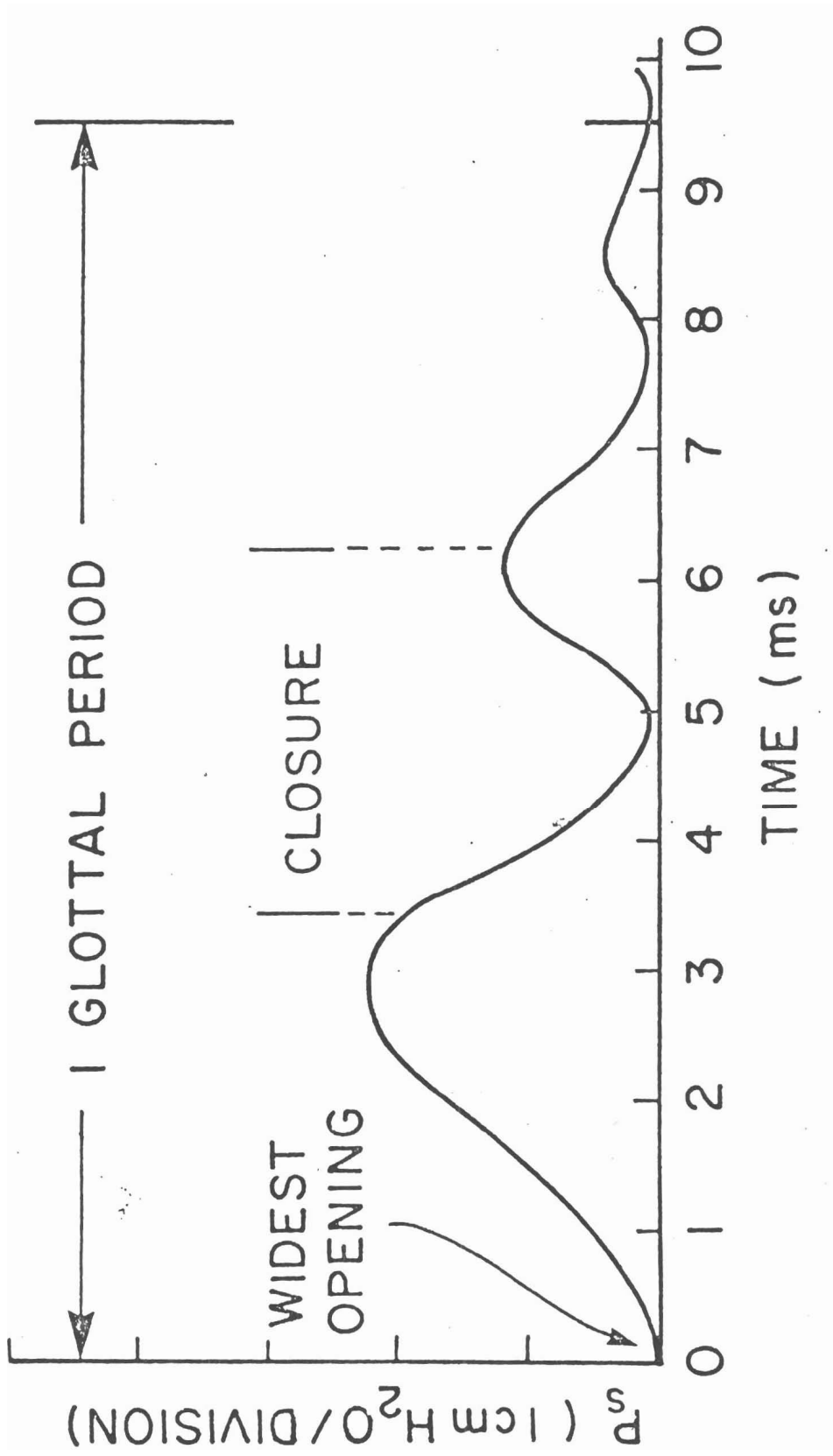

van den Berg and Tan (1959) that "each larynx sang after its own fashion". Not only were there striking inter-larynx differences (as evidenced in the trajectories and qualitative sketches in Fig. 7-2), but also there were intra-larynx differences for different runs or different conditions. In examining these data to uncover the important aspects of the phonatory process, it should be remembered that there may be different mechanisms of phonation or that different aspects may predominate under different conditions. In Fig. 7-2, for example, there are striking differences between the sketches in the insets for parts C, D, and G. Another example is that although Fig. 7-3 indicates counter-clockwise rotation of the supraglottal surface during the closed period and early open period (and this was qualitatively observed to occur in many runs), the sketches in parts C and G of Fig. 7-2 and the data in Fig. 7-7 seem to indicate a different type of behavior.

It is important to consider the relationship between the particle trajectories and the vibrations of the vocal fold tissues. The position of a particle always indicates the position of the vocal fold surface, of course. However, we must consider whether a particle adheres tightly to the surface tissue layer or whether it slides across it during the cycle. (The particles have, after all, mass subject to inertial effects and surface area exposed to aerodynamic forces.) Furthermore, if a particle adheres to the surface

layer, we must still consider the relationship between the surface tissues and the underlying structures such as the vocal ligament (see, for example, Hirano, 1974). (In analogy, the skin on many body surfaces, such as anterior to the larynx, and the mucosa inside the mouth seem quite mobile over their underlying structures.) In examining these issues, it was noted that there were some cases where there was a thick layer of mucous or soft mucosa (especially in old preparations). In these cases, some particles slid along the outer surface while others seemed closely associated with the underlying tissues. Thus, it is in fact possible that there are systematic particle movements with respect to the underlying tissue during the cycle, but it is felt that in most cases these would have been detected during the measurement procedure. Although the main reason for using the particles is the lack of good landmarks on the tissues themselves to serve as reference points for measurements, it is felt that there were usually sufficient landmarks on the preparations for these experiments to detect particle movements with respect to them. Whether or not the ligament or other structures can move independently from the surface tissue is a matter for further discussion and research.

#### Interpretation of Vibrations as Surface Waves

On observation, vibrations of the (subglottal

and supraglottal) regions well off the midline appear like surface waves propagating up the glottal walls on the lower part and laterally on the supraglottal surface. The measured trajectories of particles well off the midline such as in parts E and F and particle 1 and 3 of part H of Fig. 7-2 seem consistent with this interpretation. In shape, they are roughly elliptical, and they traverse this shape in the clockwise direction (for the coordinate system used, in which the lateral direction is to the right). (It may be noted that similar trajectories apply to particles on the surface of water with long wavelength waves propagating in the same direction). Particle velocities around the trajectories are not uniform. For example, in part E of Fig. 7-2, velocities are smaller in the lateral part of the trajectory than in the medial part, and in part F they are smaller in the superior part than the inferior part. In terms of presumed surface waves, these results would indicate a broad trough and sharp peak on the lower part of the fold in part E, and a broad peak and sharp trough on the supraglottal surface in part F. For particle 3 in part H of Fig. 7-2, velocity is roughly symmetric around both axes of the ellipse, as would occur for a more symmetric surface wave. These observations about the forms of the presumed surface waves are consistent with the relative durations of the closed periods in parts F and H

of the figure.

To interpret tissue vibrations as surface waves becomes more difficult nearer the midline, due to the occurrence of glottal closure and to the fact that the fold has an edge. Particles in these regions, it was noted, have generally more complex trajectories, which can be separated into a roughly elliptical part and a perturbation. For supraglottal particles, the perturbation seems to just precede or coincide with opening. When the perturbation occurs, velocities are relatively small during the perturbation and relatively large following it. One may wonder, on the basis of this evidence, whether the perturbation is associated with surface tension or some other phenomenon causing energy storage during closure. In the case of at least one subglottal particle (particle 2 in part G of Fig. 7-2) a perturbation just precedes closure. In this case, it cannot be due to surface tension, since this force requires contact between the two sides.

The notes and sketches associated with Fig. 7-2 suggest that the perturbations are often associated with the passage of a "corner" or ripple (i.e. a displacement wave) past the particles. In part D, for example, the sketch shows a corner medial to the particle at phase 1, slightly lateral to it at phase 2 (the tip of the perturbation), and further lateral at phase 3. In part G a peak builds up medial to



to particle 1 between phases 2 and 3 and moves past it during phases 4 and 5. Particle 2 is apparently superior to a ripple at phase 3, since it is obscured from the subglottal aspect. As the notes in the inset of the figure indicate, the ripple apparently moves closer to the particle at phase 4 and is very near the particle at phase 5. At phase 6, the ripple has apparently moved past the particle; since it is visible from below. (This does not seem to agree well with the fact that the perturbation is centered between phases 6 and 7. It could be noted that the closure occurs between phases 6 and 7, at a level somewhat superior to the particle. Possibly, then, the perturbation is more directly related to closure itself than to wave phenomenon.)

Glottal closure shows apparent wavelike properties. The region of closure progresses upward so that tissues below closure move away while tissues above move toward midline, as sketched in Fig. 7-9. Individual particles near the midline also move up during closure, but closure itself moves up faster. As shown dramatically with particle 2 in part H of Fig. 7-2, closure can move past a particle.

We have not established whether vibration patterns can be accurately described simply as a surface wave phenomenon. However, assuming such a description, we can estimate apparent wave velocity on the medial surface from the two sets of simultaneous trajectories in parts G and H of Fig. 7-2. In part G, there appears to be a  $3/8$  cycle

FIGURE 7-9

Sketch showing the mechanism by which the locus of closure moves upward. The solid line represents the frontal section at one instant during the closed period. The broken line represents the frontal section at a subsequent instant. The arrows indicate that tissues below closure move laterally and superiorly, while tissues above closure move medially and superiorly.

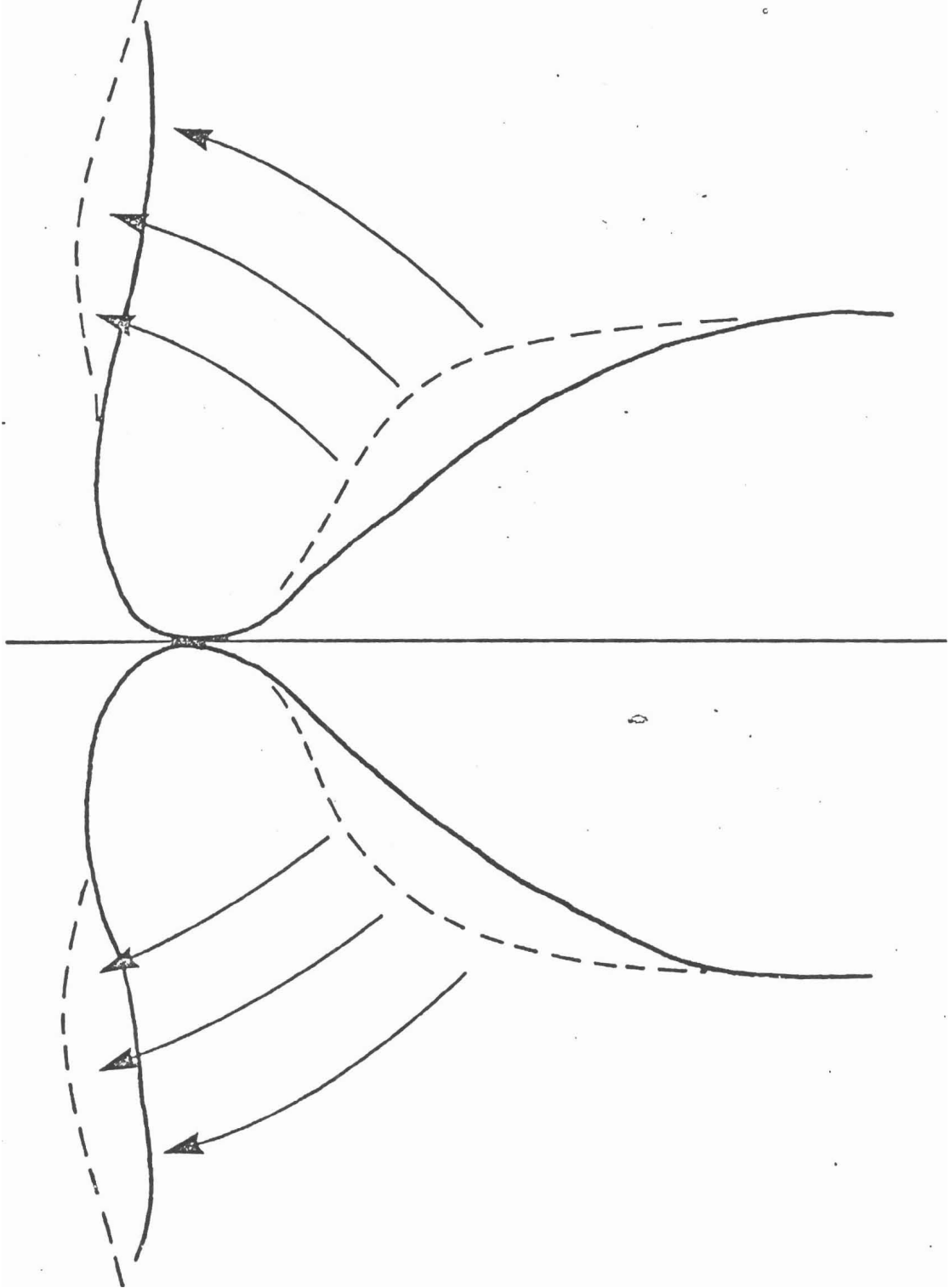

(2.7 msec) delay between corresponding parts of the trajectories from particle 2 to particle 1. The distance between particle 2 at phase 6 and particle 1 at phase 1 (for both cases, the particle is presumably near the wave crest) is about 2.7 mm. (This is straight line distance, as opposed to distance along the surface, but the differences should be small at these phases.) The propagation velocity is thus on the order of 1.0 m/sec. Similarly, for the trajectories in part H, there is an apparent phase lag of  $1/2$  cycle ( 5 msec.) from particle 3 to particle 2, and another  $1/8$  cycle (1.3 msec.) from particle 2 to particle 1. The separation of these particles with the appropriate delays is approximately 5.0 mm. and 1.5 mm. respectively, measured with particle 2 around phases 0, 1 or 2 (when it is near the corner of the fold). Thus, again the derived propagation velocities are on the order of 1.0 m/sec. This value may be compared with the value of 1.6 m/sec. reported by von Gierke et al. (1952) on human skin on such places as the thigh or forearm. As discussed earlier, however, wave velocity on the more lateral parts of the superior surface drops to 0.3 to 0.5 m/sec., perhaps because the membranes are more slack or because the effective thickness is greater.

In part H of Fig. 7-2, the phase lag from particle 3 to particle 1 has already been described as  $5/8$  cycle using the surface-wave description (i.e. with the positive di-

rection of displacement directed outward from the fold), or  $1/8$  cycle if the sense of one of them is reversed. That is, if displacements of particle 3 into the fold are compared to the displacements of particle 1 out of the fold, then its two trajectories are only  $1/8$  cycle out of phase (which is almost in phase). This observation leads to speculation that movements on the superior surface of the folds should be considered as displacement of mass from the lower medial surface to the upper surface, as indicated by the arrows in the sketch in Fig. 7-10. In other words, perhaps the relationship between these generally elliptical trajectories is due to displacement of the mass of the body of the vocal folds rather than to propagation of a surface phenomenon.

The notes and sketches associated with parts A, D, and G of Fig. 7-2 illustrate a feature of the vibration patterns for some supraglottal particles. Though a particle may be clearly on the supraglottal surface for most of the cycle, it may appear to be on the medial-facing glottal wall during part of the open period (generally the most lateral part of its trajectory). More generally, its position relative to the "corner" changes systematically through the cycle. This phenomenon may correspond to the passage of a surface wave - the apparent location of the corner depending on the location of the wave peak. However, there are other pos-

FIGURE 7-10

Sketch illustrating possible displacement of mass from the lower medial surface to the upper lateral surface of the vocal folds during the closed period. The solid line represents the frontal section of the folds at one instant during the closed period. The broken line represents the frontal section at a subsequent instant.

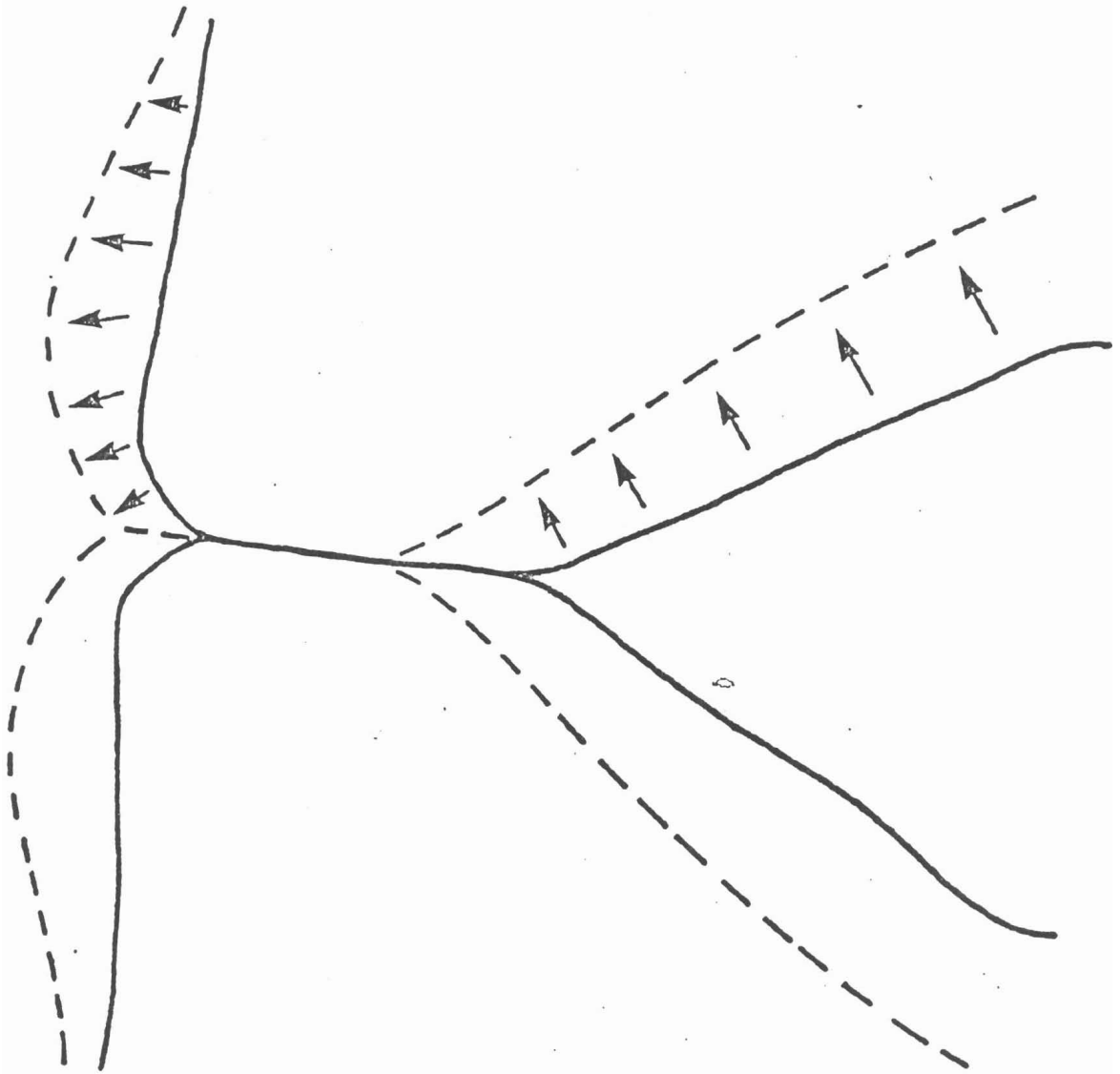

Handwritten text or markings at the bottom left of the page.

sible explanations; for example, the surface tissues may be sliding across the underlying tissues.

In partial summary then, the trajectory measurements and some other observations seem explainable as a surface wave phenomenon. However, the evidence is not at all conclusive, and other explanations are possible.

#### Sketching and Analysis of Vocal-Fold Silhouettes in the Frontal Plane

The information contained in part H of Fig. 7-2, along with other qualitative information about phonation in general, was found to be sufficient to estimate the instantaneous shape of the vocal folds in frontal section. For each of the eight phase increments represented in the figure, a line was drawn through the three data points to represent the silhouette in the frontal section. The resulting sketches are shown in Fig. 7-11. (Although measurements were made on only one side, the other side has been drawn in mirror image for display purposes only.)

The shapes shown in Fig. 7-11 were drawn with the following criteria: 1. They pass through the three points established by particle measurements, 2. They are consistent with the accompanying observations recorded during the run and also with the measurement angles used (i.e. there is indeed a line of sight to the particle position along the prescribed axis), 3. They are consistent with the other notions already established such as an apparent



## FIGURE 7-11

Estimates of the shapes of the vocal fold based on the data in Fig. 7-2H. The three data points from each phase increment in Fig. 7-2H are represented by three asterisks in each part of this figure. A line representing the surface of the vocal fold at each instant has been drawn through them (see text). The shape to the left of the midline is a reflection of the shape to the right. The digits in each part of the figure indicate the phase increment as numbered in Fig. 7-2H. The corners in the upper left of each part of the figure represent 1 mm. scales in the vertical and horizontal directions.

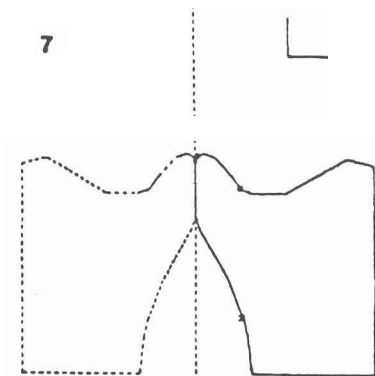
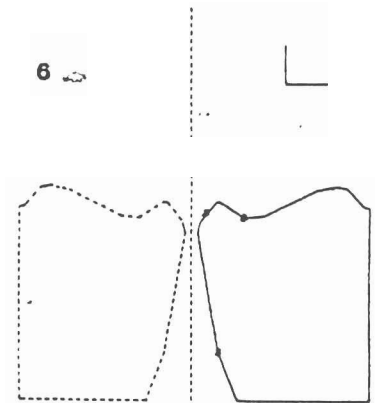
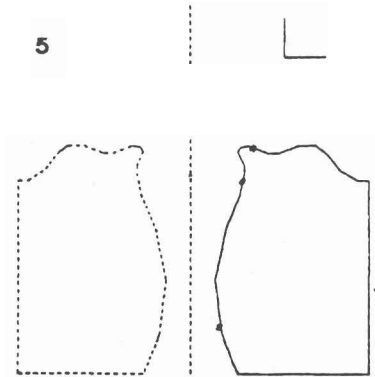
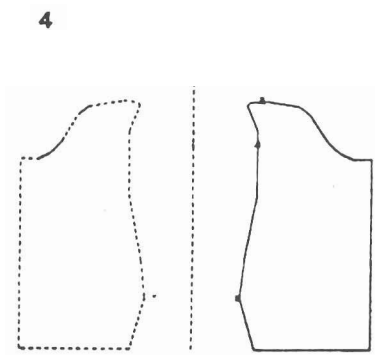
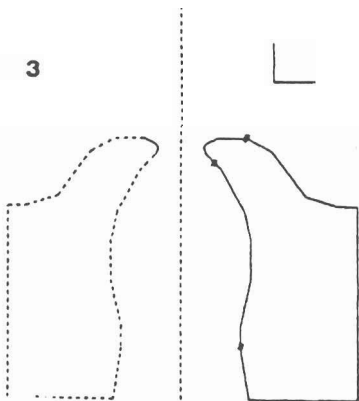
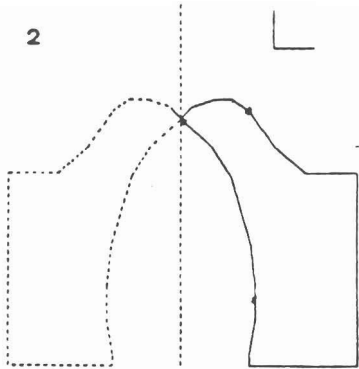
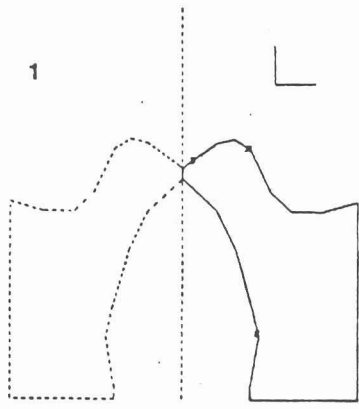
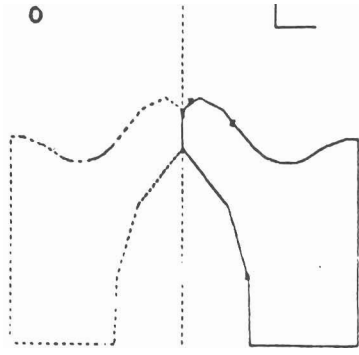

10  
11  
12

surface wave with propagation velocities of 1 m/sec. on the medial surface and 0.3 to 0.5 m/sec. on the superior surface, and an appropriate locus of the boundaries of closure as a function of phase. Also, they agree qualitatively with sketches recorded during other runs, 4. Finally, after initial sketches were made, they were adjusted to produce smooth movements when shown in animation on a computer CRT output.

Bearing in mind that the sketches are only estimates, and then are based on only one episode of phonation, it is still useful to discuss vibration patterns using the sketches as a reference and to make further measurements on the sketches themselves.

Fig. 7-12 shows a replot of the individual sketches with the trajectories superimposed, and also shows a composite plot of all the sketches. In these plots, the wave-like nature of the vibrations is apparent. (It is even more apparent when the sketches are animated.) Particles 1 and 3, at least, appear to be on wave peaks during the outermost parts of their trajectories and in troughs during the innermost parts. For particle 2, it is difficult to demonstrate such a simple interpretation. In the composite plot, a succession of wave peaks and troughs in the superior surface is evident. These appear to propagate through the successive phase increments with an average velocity of

## FIGURE 7-12

· Replot of Fig. 7-11 with the particle trajectories superimposed. The top part of the figure shows a superposition of the right parts below.

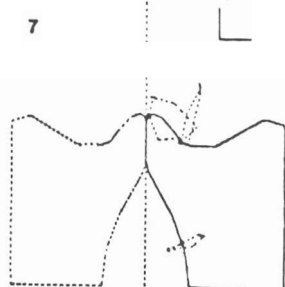
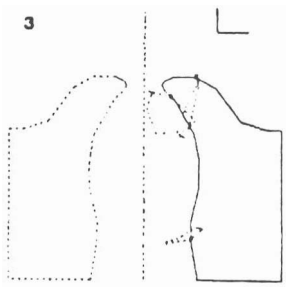
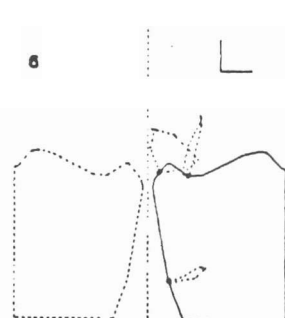
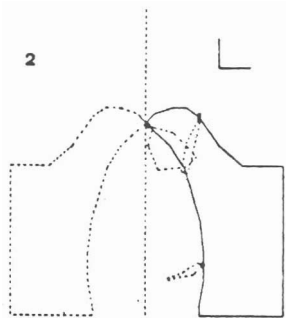
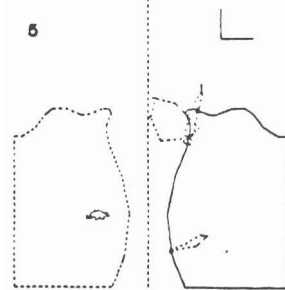
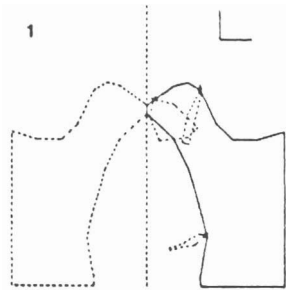
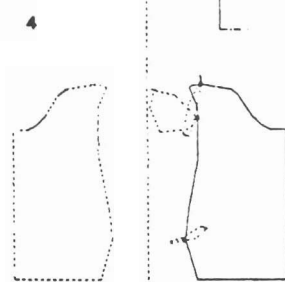
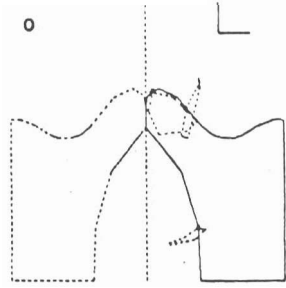
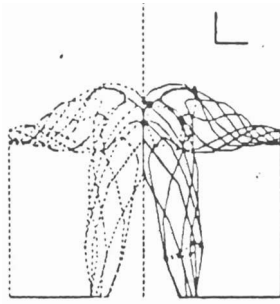

0.3 to 0.4 m/sec. Apparent wave propagation with an average velocity of about 1.0 m/sec. can also be discerned on the medial surface. The composite plot confirms that the trajectories of particles 1 and 3 are oriented perpendicular to their associated surfaces.

Fig. 7-13 shows a plot of the locus of the borders of glottal closure during the closed period. The lower border moves upward continuously. The upper border moves up at a slower average rate. It may be noted in Fig. 7-11 or Fig. 7-12 that the subglottal aspect forms a much more acute angle at the midline at phase 7 than at phase 2. At the latter increment, it is more dome shaped.

Useful measurements can be made from the sketches that cannot be made on the preparation itself. Among these measurements are length along the surface of the frontal section and area of the frontal section itself. Measurements at the eight phase increments of the surface distance between particles 1 and 2 and particles 2 and 3 and of the vocal-fold area enclosed by the sketches are shown in Fig. 7-14.

The measurements of surface length between the particles indicate that the surface tissues are stretched significantly during the cycle, if the sketches are accurate and the particles are well attached to the tissues. For particles 3-2, the variation of distance is about 30% of its average value. For particles 2-1, it is over 50% of

## FIGURE 7-13

Vertical location of closure measured from the sketches  
in Fig. 7-11. (cf. Fig. 7-6.)

VERTICAL POSITION ( 1mm/DIVISION )

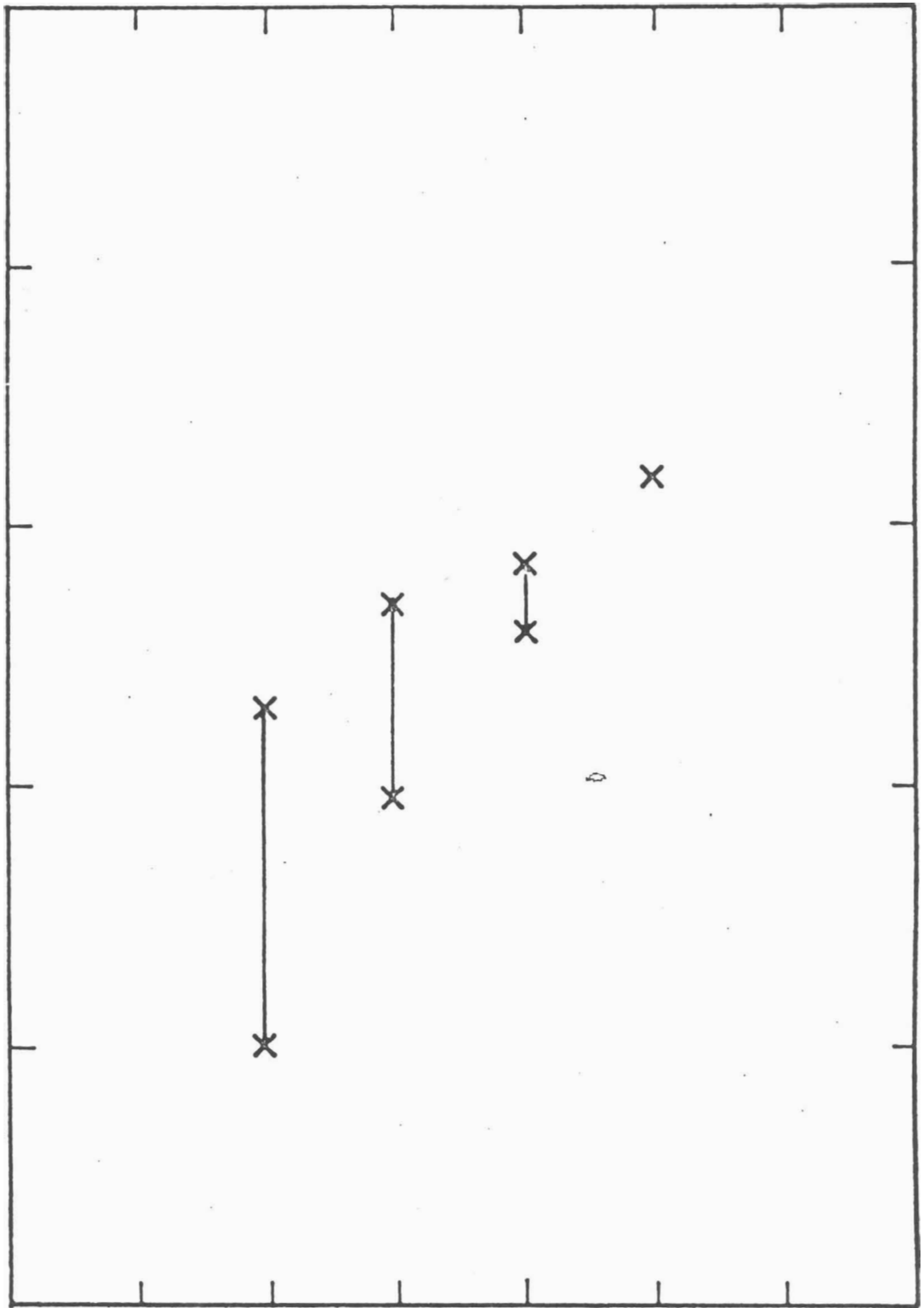

PHASE ( 1/8 CYCLE/DIVISION )



## FIGURE 7-14

Measurements from the sketches in Fig. 7-11. The top part contains plots of the lengths represented by the line segments joining the indicated particles. The lower part is a plot of the area represented by the closed figure on each side of the midline.



4  
5  
6  
7  
8  
9  
10  
11  
12  
13  
14  
15  
16  
17  
18  
19  
20  
21  
22  
23  
24  
25  
26  
27  
28  
29  
30  
31  
32  
33  
34  
35  
36  
37  
38  
39  
40  
41  
42  
43  
44  
45  
46  
47  
48  
49  
50  
51  
52  
53  
54  
55  
56  
57  
58  
59  
60  
61  
62  
63  
64  
65  
66  
67  
68  
69  
70  
71  
72  
73  
74  
75  
76  
77  
78  
79  
80  
81  
82  
83  
84  
85  
86  
87  
88  
89  
90  
91  
92  
93  
94  
95  
96  
97  
98  
99  
100

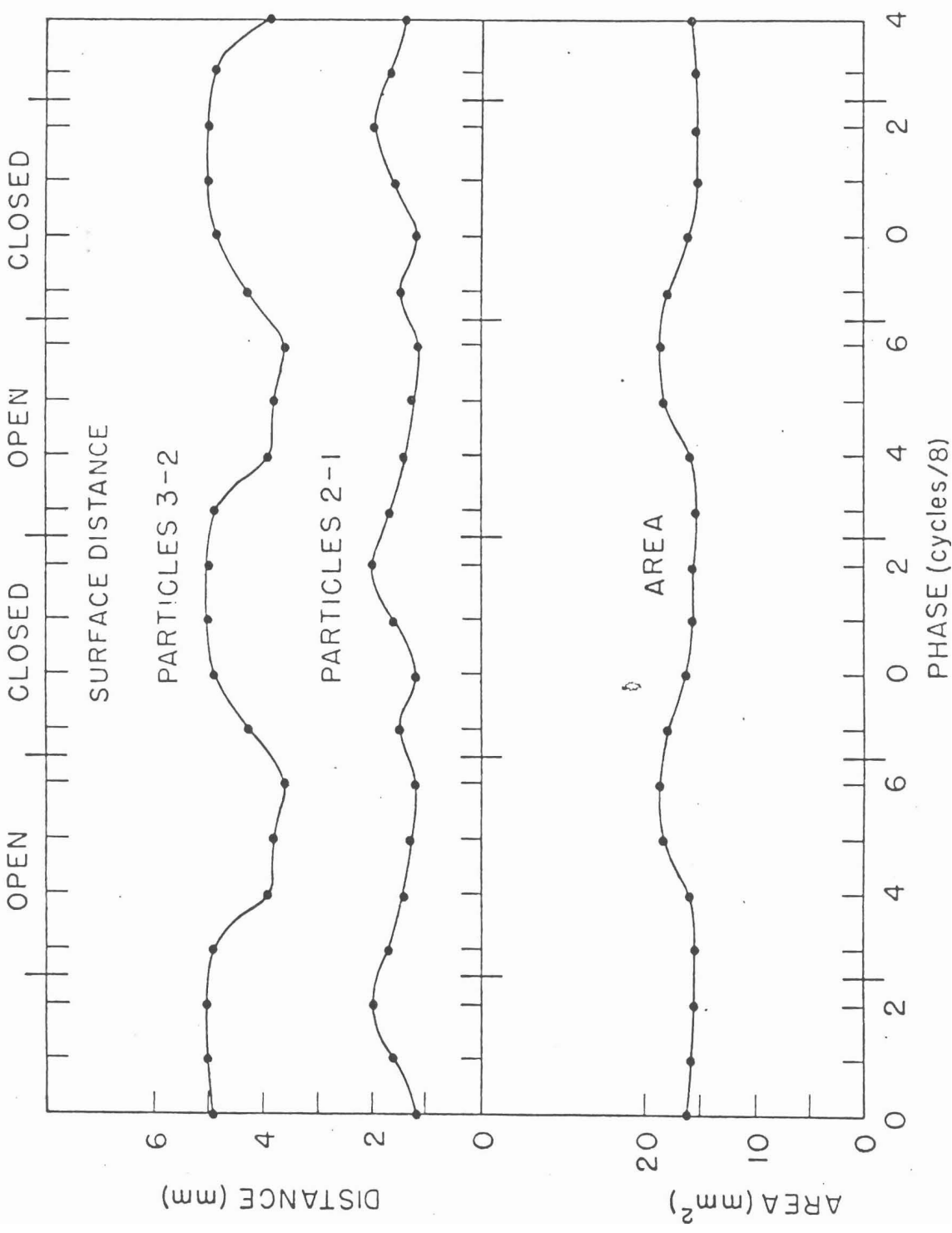

average. In both cases, the waveform is near a maximum when the glottis opens and near a minimum when the glottis closes. It is interesting to note that - to the extent that stiffness of the surface tissues is significant - energy is stored when the tissues are stretched. Thus, mechanical energy is stored during the closed period and released during the open period.

The area waveform shows area changes of about 20% ( $3 \text{ mm.}^2$ ) during the cycle. The area is minimum when the glottis opens and near a maximum when the glottis closes. Thus, at opening, the area is roughly minimum but is enclosed by a surface with maximum periphery. At closure, the area is maximum but the length of the surface is approximately minimum.

To the first order, at least, laryngeal tissues are incompressible. Much of the composition of the vocal folds can be thought of as fibers or membranes fixed at their anterior and posterior ends. When these fibers or membranes are deflected in the frontal plane, their length increases. Assuming incompressibility, the instantaneous cross section should vary in inverse proportion to length. However, variations in length during a cycle are almost certainly less than 20%, especially when averaged across the different parts of the frontal section. For example, assuming an undisplaced length of 12 mm. and a maximum deflection of 2 mm., the total change in length of an ideal string is less

than 11% for all the different patterns of displacement sketched in Fig. 7-15. Thus, change in length does not seem sufficient to account for change in cross sectional area as represented in the sketches. This implies that (1), the sketches overestimate the area change due to area changes outside the region represented, (2), the approximation of tissue incompressibility is not accurate, or (3), the sketches are grossly inaccurate. Of these possibilities, the first and third are most likely.

The sketches in Figs. 7-11 and 7-12 show that the frontal-plane area of the airway below closure increases and the area of the airway above closure decreases during the closed period. Thus, there is not effective airflow during the closed period. However, subglottal and supraglottal flow are not equal. Due to the increase in vocal-fold area, as indicated in Fig. 7-14, the effective subglottal flow toward the glottis is greater than the effective supraglottal flow from the glottis. The average rates of subglottal and supraglottal flow, assuming the measured area displacement distributed over an effective length of 1.25 cm. for the three intervals within the closed periods are plotted in Fig. 7-16. (It is interesting to note that many of the volume-velocity waveforms derived by Rothenberg (1973) show a small airflow rate of similar magnitude during the closed period - although they have a negative slope,

## FIGURE 7-15

Increase in Length (  $L$  ) for different patterns of displacement of an elastic string with fixed ends. The rest length (  $L$  ) is assumed to be 12 mm.

Rest Position

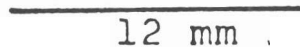

Triangular

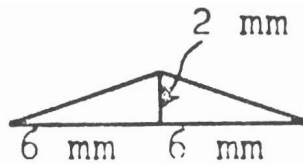

$$\Delta L = 0.6 \text{ mm}$$

$$\Delta L/L = 5\%$$

Triangular

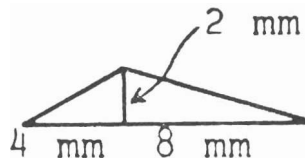

$$\Delta L = 0.7 \text{ mm}$$

$$\Delta L/L = 6\%$$

Trapezoidal

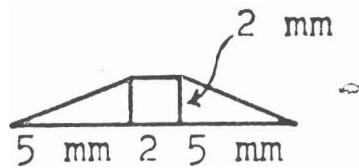

$$\Delta L = 0.8 \text{ mm}$$

$$\Delta L/L = 7\%$$

Trapezoidal

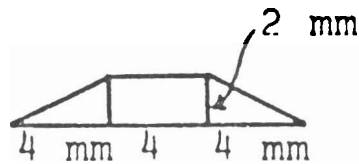

$$\Delta L = 0.9 \text{ mm}$$

$$\Delta L/L = 8\%$$

Circular Arc

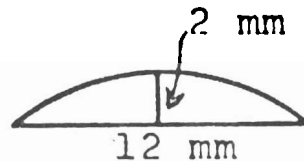

$$\Delta L = 1.3 \text{ mm}$$

$$\Delta L/L = 11\%$$

## FIGURE 7-16

Equivalent flow rate due to displacement of tissues during the closed period. The calculations are based on the area (in the frontal plane) of the supraglottal airway and of the subglottal airway during the closed period. An effective glottal length of 1.25 cm. was assumed.

AVERAGE FLOW RATE

SUPRAGLOTTAL (cc/sec)

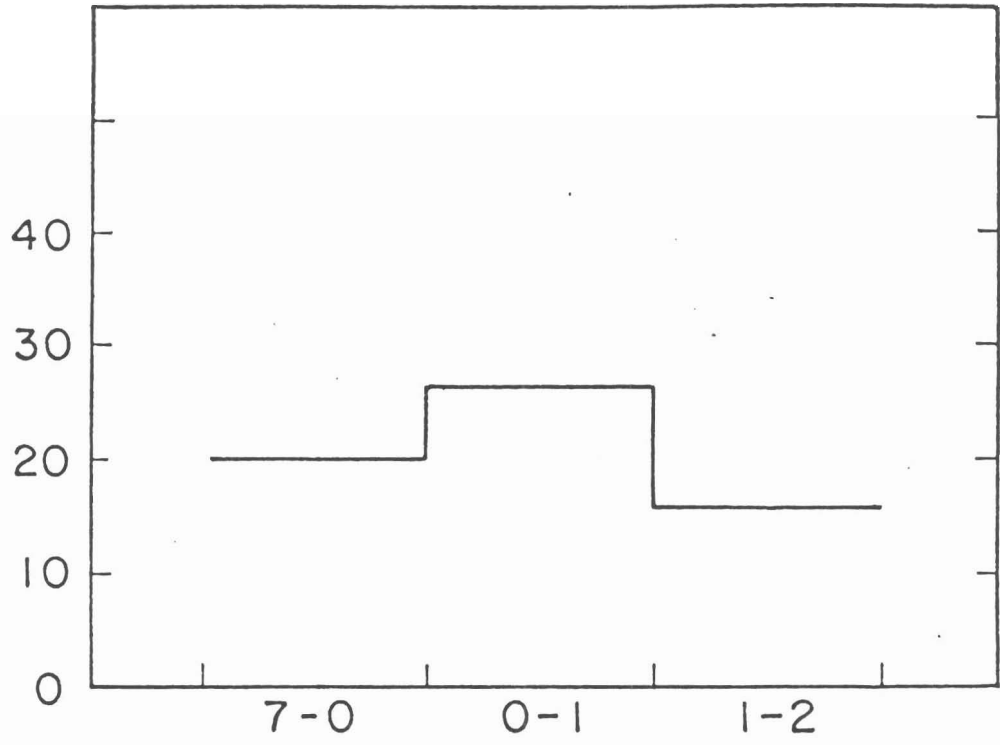

AVERAGE FLOW RATE

SUBGLOTTAL (cc/sec)

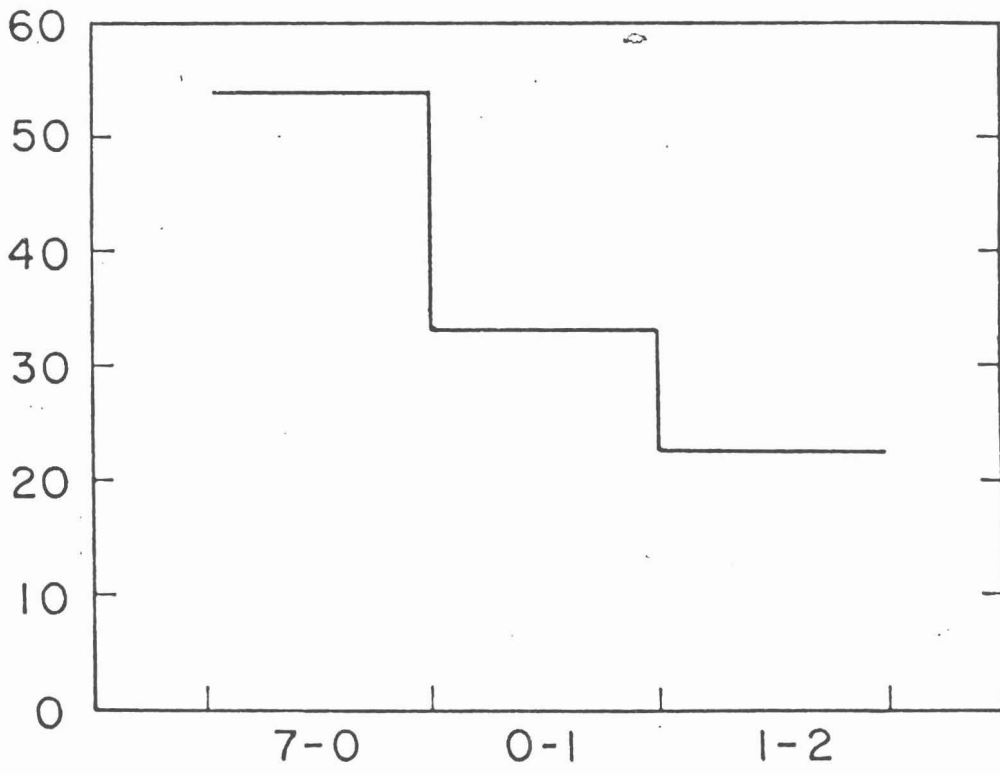

INTERVAL



unlike the supraglottal flow calculation in Fig. 7-16.).

While the changing vocal fold area reduces the effective supraglottal flow during the closed period, it should contribute to the supraglottal flow in the middle of the open period. Such an effect, as well as dynamic airflow effects, may contribute to the commonly observed phenomenon that the flow waveform is largely asymmetric while the glottal area waveform is nearly symmetric. The additional flow component due to the displacement by the vocal folds may be large enough to prolong the rising phase of the glottal flow waveform. However, the magnitude of the effective flow component is probably too small to be significant.

In the cumulative plot shown in Fig. 7-12, the "corner" of the vocal fold looks like an essentially fixed shape that translates around a roughly circular trajectory and tilts. In Fig. 7-17, the sketches have been replotted with such a shape fit to the corner. The shape rotates counterclockwise during the closed period while translating upward. During the open period, it springs back in the clockwise direction while translating inferiorly.

We may speculate whether the shape shown in Fig. 7-17 represents the cross section of the vocal ligament. (There is some doubt, of course, whether the ligament could be so well identified separately from the elastic membrane and, if so, whether its shape would remain so undistorted

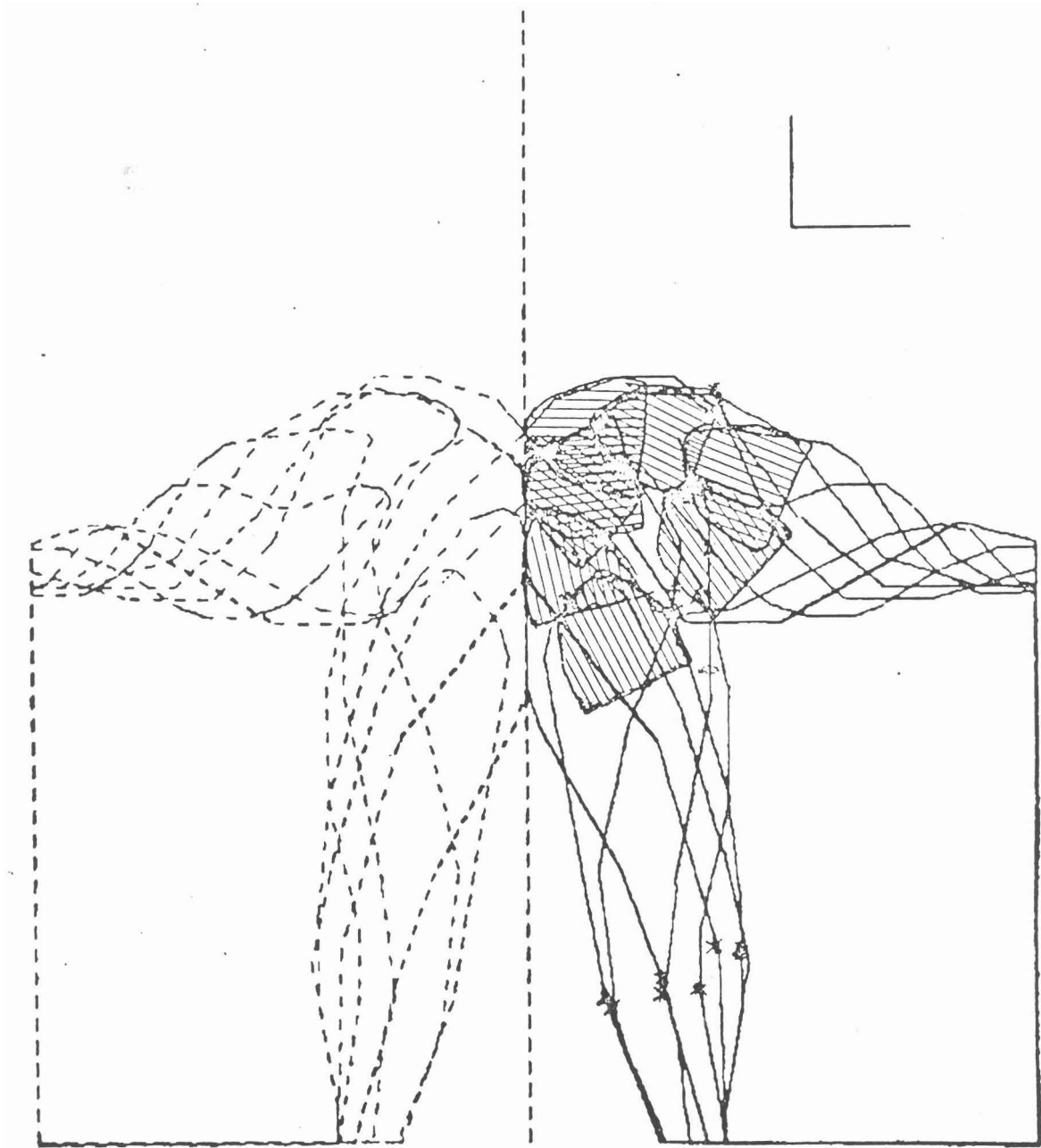

FIGURE 7-17

Composite plot of the sketches in Fig. 7-11 with a fixed shape fit to the "corner" in each sketch.

throughout the cycle.) If the shape actually represents such an identifiable structure, then the two components of movement described above correspond to rotation of the center of mass (string vibrations) and rotation of the mass around an interior axis. It may be noted that these are essentially the two degrees of freedom of the two-mass model, except of course that vibration of the center of mass are represented in only one dimension for the model (see Dudgeon, 1969). The aerodynamic and mechanical forces producing this type of movement can thus be partly understood from modelling efforts involving the 2-mass model (see Chap. 4), although the tissues below this section are also clearly involved and must be considered. According to this concept, the vibration patterns consist of string-vibrations of the ligament and propagating surface waves on the conus elasticus. This concept is appealing for the purpose of modelling, since there is sufficient complexity to account for inter-larynx and intra-larynx variability.

Referring back to Fig. 7-17, it may be noted that, in order to accept this description, we must accept that particles 1 and 2 slide across the surface tissue or that the surface tissues slide over the ligament. The particles move in a clockwise direction with respect to the shape from the last half of the open period to the first half of the closed period, and in the other direction for the other half cycle.

As the sketches indicate, a "sulcus vocalis" as described by Smith (1954) (i.e. a concave depression on the medial wall of the vocal fold) seems to be a normal part of the vibration patterns encountered during these experiments. Such a shape may be noted during phase increments 3-5 in the sketches. It results from a vibratory phase difference between the upper and lower parts of the fold. (To the extent that this phenomenon is important, it points out the inadequacy of a two-section model of the vocal folds.) Another example of a sulcus can be noted in a qualitative sketches associated with part D of Fig. 7-2.

#### Conclusion

In describing vocal fold vibrations in this discussion, we have hypothesized some possible mechanisms (viz. surface vibrations of the elastic tissues; possibly string vibrations of the vocal ligament.) However, the only information available in addition to a description of the outside shape of the vocal folds as a function of time is average flow rate and subglottal pressure, and some rough measurements of the subglottal pressure waveform. More data on the vocal folds themselves and on the aerodynamics of the glottis is needed before anything more certain can be learned about phonatory mechanisms.

The results of our measurements of dynamic subglottal pressure (i.e. intracycle pressure variations) indicate that,

for these experiments, intracycle subglottal pressure variations are not so insignificant as has been assumed by many modellers. In this respect, we agree both with the preliminary measurements of Hiki et al. (1970) and with the theoretical implications of measurements of subglottal tract impedance (Fant et al., 1972) for human talkers (see Chap. 3). Thus, vertical forces on the vocal folds may have to be considered. Certainly, other aerodynamic measurements such as instantaneous volume velocity, or instantaneous vertical distribution of pressure would add greatly to the usefulness of the data obtained in these experiments.

#### 2A. Measurements During Changes in Tissue Properties

During many experimental runs, there was a gradual change of state of the preparation during the measurements, so that successive measurements at a given phase increment gave different results. Figure 7-18 shows sets of such measurements (for 5 particles on 4 different larynxes). To make these measurements, the time base of the oscilloscope was adjusted, if the fundamental frequency changed, so that a glottal cycle always corresponded to 8 cm. horizontal deflection. Measurements were made cyclically at each of the eight phase increments in order. The duration of this measurement procedure was typically 15 minutes per cycle. Of course, the form of the subglottal pressure waveform changed (as well as  $F_0$ , in general), and with uncertainty

## FIGURE 7-18 (A-E)

Measured particle trajectories during runs with changing tissue properties. Measurements were made over more than one measurement cycle. Part B also shows the measured static position of a particle after the vibrations stopped. The format of the figure is the same as that for Fig. 7-2.



LARYNX L7-13-3  
RIGHT FOLD

ESTIMATED  
MIDLINE

AT START:

$$U_g = 225 \text{ cc/sec}$$

$$P_s = 9 \text{ cm H}_2\text{O}$$

$$F_0 = 83 \text{ Hz}$$

AT END:

$$U_g = 225 \text{ cc/sec}$$

$$P_s = 7 \text{ cm H}_2\text{O}$$

$$\theta = 0$$

LEGEND

- X - FIRST CYCLE
- O - SECOND CYCLE
- - THIRD CYCLE

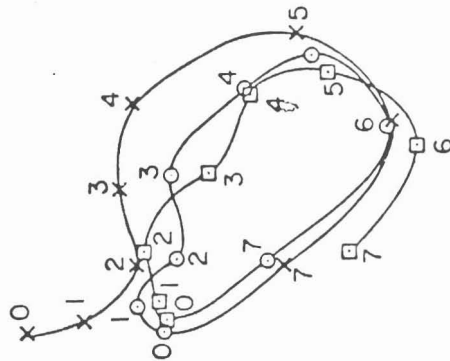

X (1 mm/DIVISION)

Y (1 mm/DIVISION)

A

B

Y (1mm/DIVISION)

APPROXIMATE  
MIDLINE

LARYNX L3-30-3  
LEFT FOLD



AT START:

$U_g = 325$  cc/sec

$P_s = 10$  cm  $H_2O$

AT LAST MEASUREMENT

$U_g = 325$  cc/sec

$P_s = 8$  cm  $H_2O$

$F_0 = 87$  Hz

$\theta = 0^\circ$

FOR FIRST CYCLE:

- 0 OPENING
- 1
- 2
- 3 SOME CHANGE IN VIBRATIONS
- 4
- 5
- 6 CLOSED
- 7

LEGEND

- x - FIRST CYCLE
- o - SECOND CYCLE
- - THIRD CYCLE
- - NO VIBRATIONS - WITH FLOW
- ▲ - NO VIBRATIONS - NO FLOW

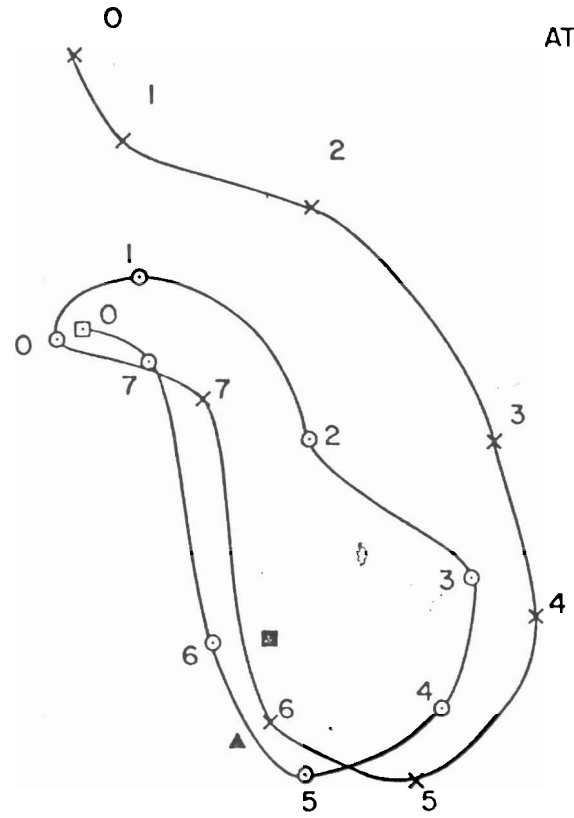

X (1mm/DIVISION)



LARYNX L8-24-3  
LEFT FOLD



AT START:

$$P_s = 9 \text{ cm } 0$$

$$U_g = 200 \text{ c } \text{ sec}$$

$$\theta = 0^\circ$$

END OF FIRST CYCLE -

PEAKS OF  $P_s$  WAVEFORM  
DELAYED ABOUT 1/16 CYCLE

VIBRATIONS STOP AFTER  
PHASE 4 SECOND CYCLE

ESTIMATED  
MIDLINE

Y (1mm/DIVISION)

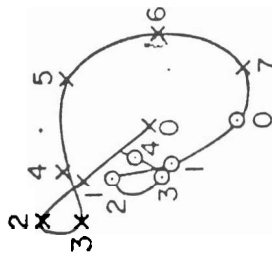

LEGEND

x - FIRST CYCLE  
o - SECOND CYCLE

X (1mm/DIVISION)

D

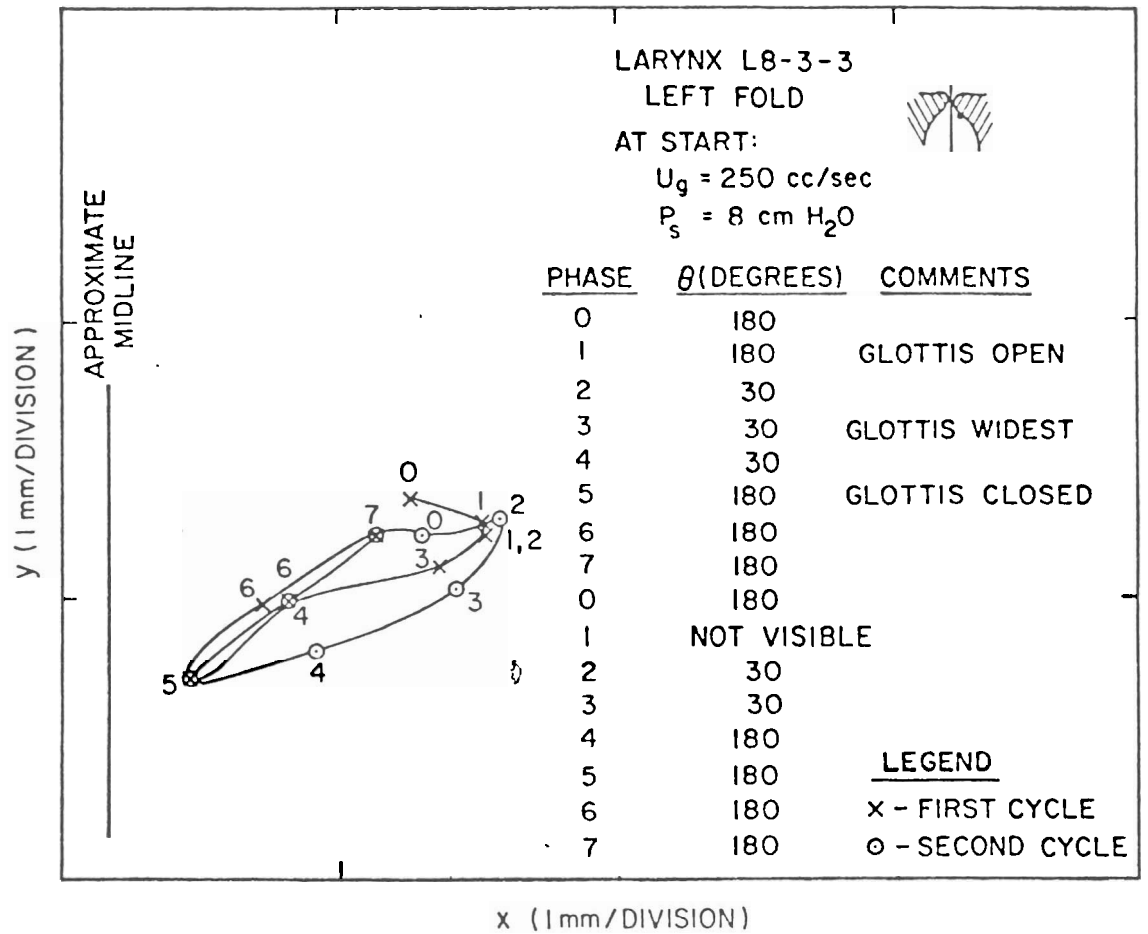

E

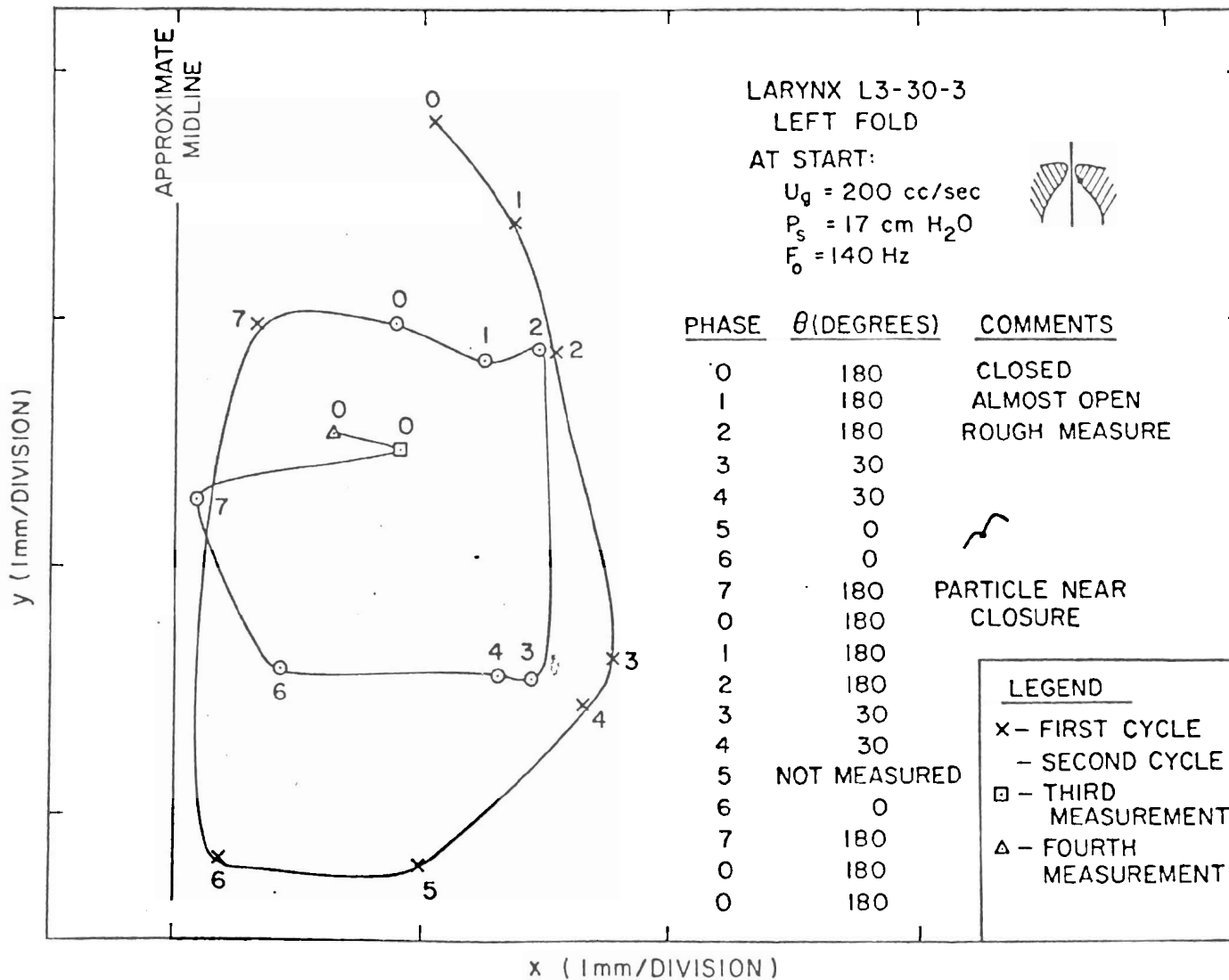

about the trigger point on the waveform, there is certainly no guarantee that equal-numbered phase increments on successive measurement cycles refer to corresponding parts of the mechanical vibration cycle.

The change of state giving rise to the changes shown in Fig. 7-18 was mostly attributed to desiccation of the laryngeal tissues due to insufficient warmth or humidity in the supplied or ambient air. The mechanical effect of tissue desiccation was an increase of the stiffness of the tissues and presumably a loss of mass. As the tissues dried out, their surface properties presumably changed. As one might expect from these factors, fundamental frequency often increased somewhat during the drying process. However, sometimes it decreased, with an accompanying loss of subglottal pressure (if subglottal pressure regulation was not very good) since the average aerodynamic resistance of the glottis decreased. The most consistent correlates (perceptually, and in the subglottal pressure waveform) of the drying process was that the sound became weaker and the waveform less sharp as glottal closure became shorter and less abrupt. In some cases, the vibrations ceased completely and could not be re-initiated.

The first three parts of Fig. 7-18 show the trajectories of particles on the superior surface of their vocal folds. The main effect of desiccation in these cases seems to be a

reduction of the vertical component of the vibrations, with most of the loss on the superior side. Horizontal components were also reduced somewhat, but less dramatically than the vertical components. In parts A and B, where flow rate was regulated, the average subglottal pressure dropped by about 2 cm. H<sub>2</sub>O during the course of the run. With the pressure-regulated source, pressure still dropped somewhat and flow rate increased during the run.

In part A of Fig. 7-18, the "perturbation" apparent in the earlier measurements seems to have disappeared by the third measurement cycle, so that the trajectory becomes quite smooth. In part B, the perturbation remains in the second cycle. A remaining perturbation is more evident in part C, where it forms a loop.

In part B of Fig. 7-18, the end of the run occurred when the vibrations stopped spontaneously. The particle's position was then measured, and it was measured once more when the subglottal source was turned off. The two measurements are indicated in the plot. In terms of models, the static position with airflow may be considered as the operating point, which has become stable due to changing tissue properties. It lies inside the trajectory during vibrations. The no-flow position is alongside the lower part of the trajectory on the medial side.

Parts D and E of Fig. 7-18 show trajectories of

particles at a lower level of the vocal folds, so that they can be viewed from only the subglottal aspect for at least half of the cycle. In these plots, the main difference between successive measurement cycles also seems to be in the vertical direction, but the differences are less systematic. In part E, the trajectory becomes more compressed on both the superior and inferior sides.

## 2B Discussion

For particles both inferior and superior to the region of closure, the principal effect of tissue desiccation appears to be decrease of the vertical component of vibration, with apparently little change in the horizontal component until the vibrations stop completely. Although we know that there was some decrease in the average subglottal pressure, measurements of the subglottal pressure waveform were not recorded. Thus, it is not determined whether there was a decrease in the dynamic transglottal pressure corresponding to the decrease in the vertical amplitude of the trajectories. In any event, these observations suggest that vertical components of the trajectories are closely associated with the mechanisms essential for phonation - a fact that is not accounted for in models of the vocal folds which represent only horizontal motion.

For the supraglottal particles in the first section of this chapter, perturbations occurred in the trajectories to

varying degrees. In this section, the perturbation disappeared during phonation in one case (part A of Fig. 7-18) and persisted quite markedly until phonation ceased in another (part C). Thus, it appears that the perturbation itself does not indicate a process necessary for the maintenance of phonation.

The measurement of final static position in part B of Fig. 7-18 suggests that a trajectory may be interpreted as showing rotation of individual tissue elements around an operating point located within the trajectory.

In the experiments for which phonation ceases spontaneously, it does so suddenly rather than gradually dying away (although as mentioned, the effect is preceded by a change in voice quality). According to at least one informal observation, apparent surface waves can be observed from the subglottal aspect even when the tissues are quite dried out prior to the loss of phonation. This observation is consistent with the notion that the subglottal vibratory activity is a necessary part of the phonation process. Again according to informal observations, the gradual change in voice quality may be correlated with a decrease in the horizontal amplitude of vibration at the lower subglottal levels. However, the examples in parts D and E of Fig. 7-18, which are at a relatively high subglottal level, do not exhibit this phenomenon.

### 3A. Data from Larynxes with Vocalis Muscles Excised

In one series of experiments, the effect on phonation of removing the vocalis muscle was investigated. The entire thyroarytenoid muscle was removed on one or both sides, leaving only the vocal ligament and conus elasticus and their surface tissues for phonatory vibrations. The sketch in Fig. 7-19 indicates roughly the part of the frontal section that was removed. The thickness of the remaining tissues was typically 1 to 1.5 mm.

The apparent effects of excising the muscle were surprisingly small. When the muscle on only one side was dissected, the subglottal aspect on that side demonstrated larger vibration amplitudes than the "normal" side, but basically the same patterns. Even the supraglottal aspect looked surprisingly similar, though the superior surface of the fold (the ventricular floor) was largely removed. Fundamental frequencies of phonation were not grossly affected. Furthermore, little additional change was noted when the muscle on the other side was removed.

Fig. 7-20 shows trajectories of two single particles on the remaining superior surfaces of separate vocal folds, each of which had its vocal muscle unilaterally excised. In part A, the vibrations were steady. However, in part B, the measurements were taken over two complete cycles (as in part 2 of this chapter) as the tissues desiccated



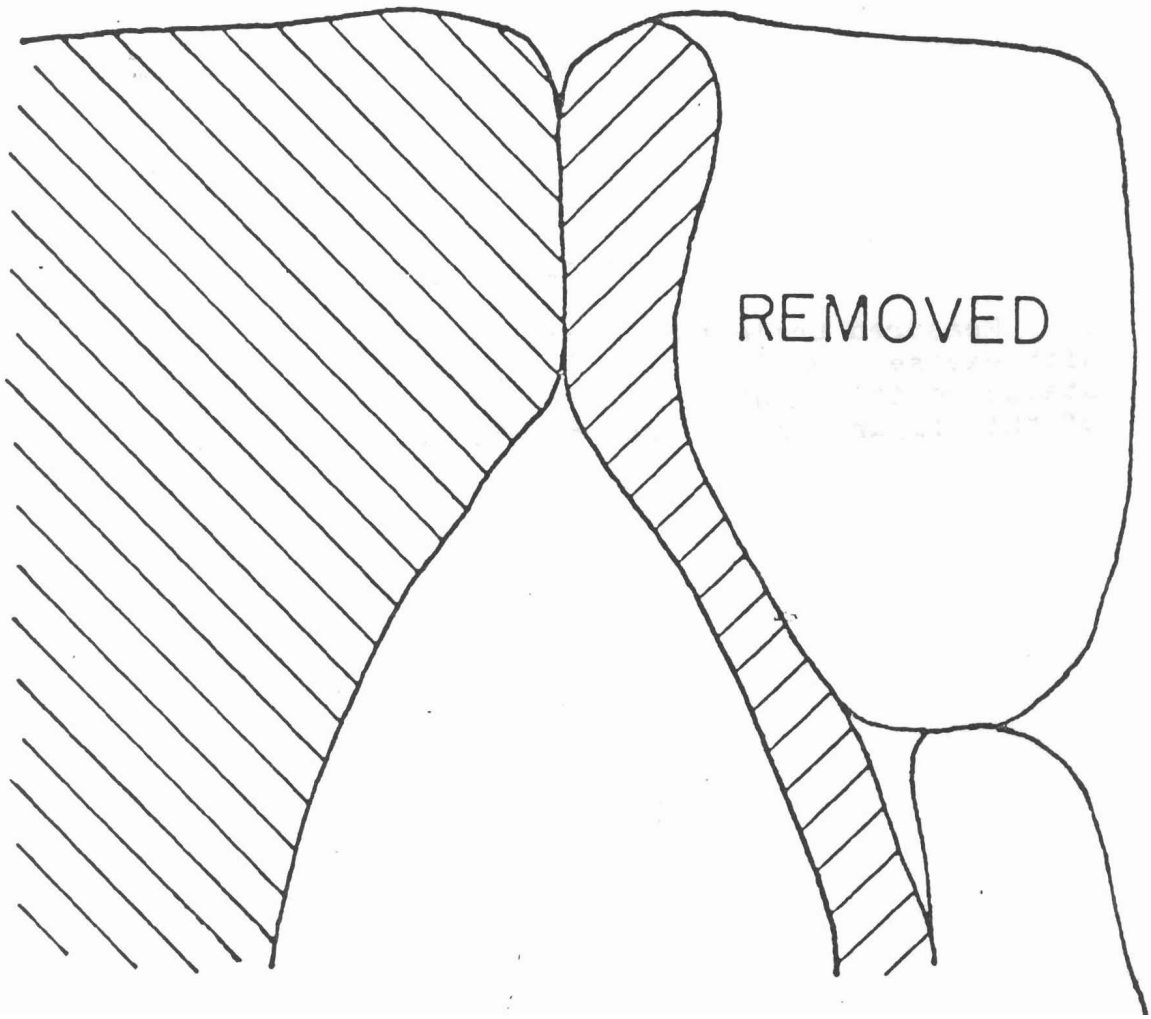
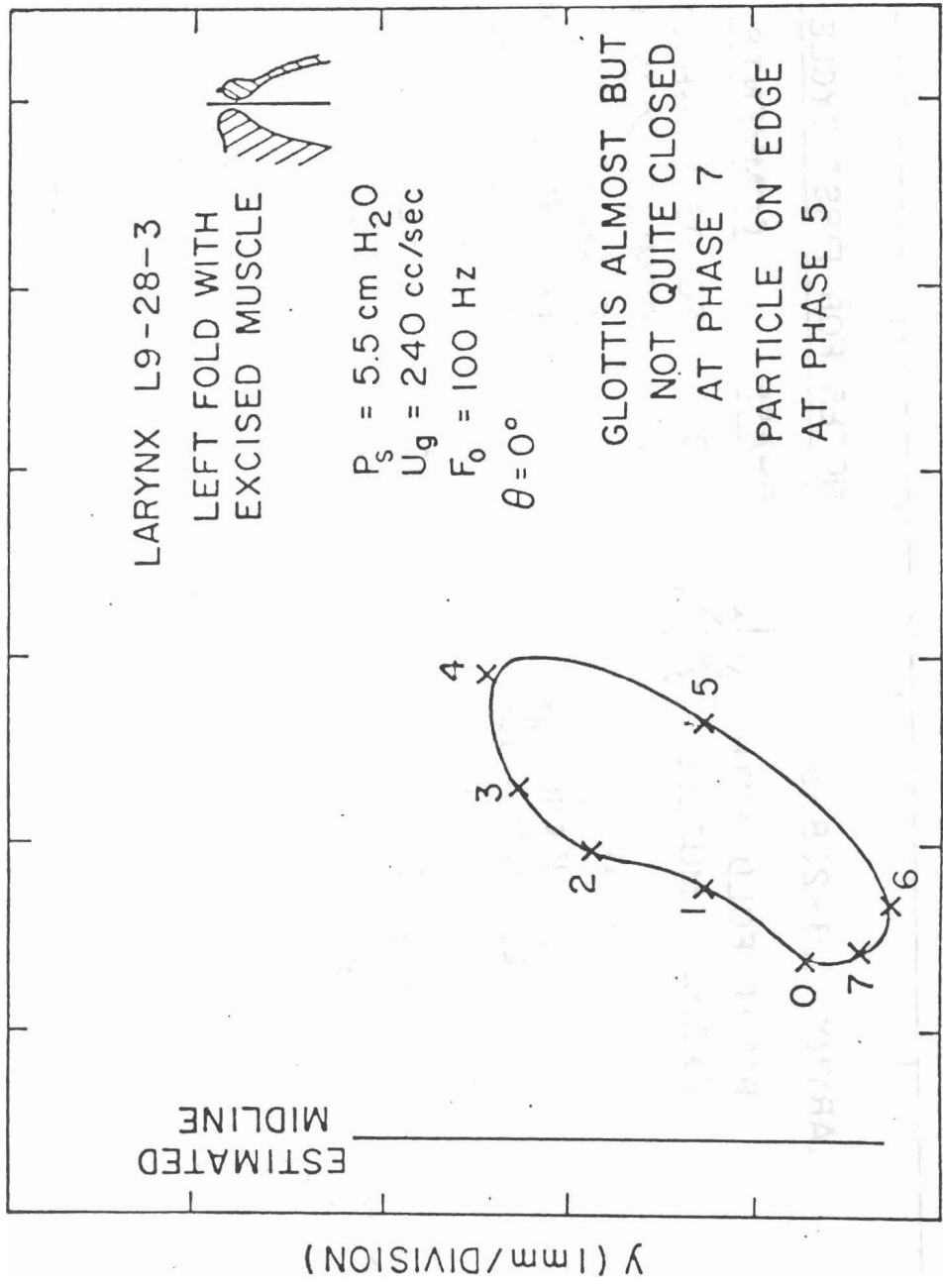

FIGURE 7-19

Schematic representation showing the portion of the vocal fold removed in excised-muscle experiments.

FIGURE 7-20 (A,B)

Measured trajectories of particles on preparations with excised vocal muscles. Part B also shows a measured static position when the vibrations stopped. The format of this figure is the same as that for Fig. 7-2.



A

B

LARYNX L8-23B-3

RIGHT FOLD WITH  
EXCISED MUSCLE



AT START:

$P_s = 8 \text{ cm H}_2\text{O}$   
 $U_g = 620 \text{ cc/sec}$   
 $F_0 = 101 \text{ Hz}$

AT END:

$P_s = 7 \text{ cm H}_2\text{O}$   
 $U_g = 680 \text{ cc/sec}$   
 $F_0 = 103 \text{ Hz}$   
 $\theta = 0^\circ$

NOTES FOR FIRST CYCLE

<u>PHASE</u>	<u>COMMENTS</u>
0	FOLDS SLIGHTLY APART
1	COMING TOGETHER
2	WELL APART
3	PARTICLE NEAR EDGE
4	BOTTOM ADDUCTING
5	CLOSING
6	CLOSED
7	CLOSED

LEGEND

- x - FIRST CYCLE
- o - SECOND CYCLE
- - THIRD MEASUREMENT
- △ - NO VIBRATIONS, NO FLOW

ESTIMATED  
MIDLINE

y (1mm/DIVISION)

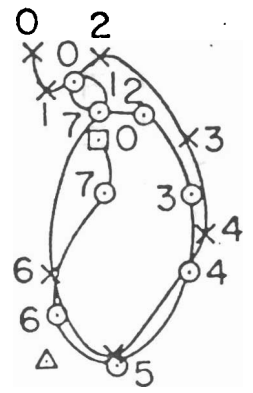

x (1mm/DIVISION)

somewhat during the course of the experiment. Although the excised muscle preparations operated quite normally for short periods of time, the increased exposure of the tissues to the air seemed to accelerate desiccation. As a result, it was found difficult to maintain steady-state vibrations long enough for a complete set of measurements.

The trajectory in part A of Fig. 7-20 seems particularly simple in shape, with no apparent perturbation. However, this simplicity is probably not due to the lack of the vocalis muscle. The trajectories in part F and part H (particle 1) of Fig. 7-2, both of which involve the same larynx with the muscle intact, are also comparatively simple. The trajectory for the excised-muscle preparation seems abnormal in that its major axis is tilted away from rather than toward the midline, but other aspects are normal. Glottal closure occurs during the rising part of the trajectory, and the particle becomes more associated with the medial vocal fold surface during the open period of the cycle and on the inferior-going part of the trajectory.

The trajectory in part B of Fig. 7-20 contains a perturbation component. It shows some similarity to the trajectory in part B of Fig. 7-2, which involves the same larynx with the muscle still intact. However, as was the case for part A of Fig. 7-20 the axis of the major part of the trajectory in part B tilts away from the midline.

The airflow rate for the run in part B was abnormally high, but this seemed to be largely due to an interarytenoid leak. The accompanying comments in the figure indicate that there was a small opening and closing gesture at the end of the closed period (The corresponding part of the trajectory, around phase increments 0, and 1 is at the perturbation.) This tendency for double-pulsing (opening and closing twice in one cycle) occurred mostly for dried-out preparations with high flow rates.

As in previous figures for supraglottal particles, glottal closure occurred in the lower rising part of the trajectory. During the open period in the cycle and on the descending part of the trajectory, the particle moved closest to the medial-superior edge. When desiccation occurred, the greatest changes were in the vertical component at the superior part of the trajectory. The measured static position of the particle at the end of the experiment with the subglottal pressure set to zero was near the lower medial part of the trajectory.

With excised muscle preparations, vibrations of the subglottal membranes could be viewed from the outside as well as through the subglottal window. These vibrations apparently formed a wave propagating in the superior direction. In one case, a rough estimate of the propagation velocity was made by measuring the approximate position of

the peak at two phase increments. The velocity was estimated to be 1.1 m/sec., agreeing roughly with previous estimates already discussed. Looking at the tissues near the base of the vocal fold, it was also noted that the vibrations were related to the details of the subglottal pressure waveform. The medial extremes of membrane position corresponded to dips in the subglottal pressure waveform. The major extreme coincided with the pressure dip following the peak associated with closure, but another local extreme corresponded to a subsequent minimum in the ringing pressure waveform.

Two other observations were made concerning phonation of excised-muscle preparations. First, several efforts to produce falsetto-mode phonation proved unsuccessful, although falsetto can be produced with an intact larynx (see Chap. 6). Though this does not necessarily indicate that falsetto phonation is impossible without the muscle, there is at least some effect. Second, when significant parts of the vocal ligament were cut away, the preparation would no longer sustain phonation.

### 3B. Discussion

Inasmuch as previous observations and measurements seem to indicate a membrane-wave or surface-wave phenomenon, it is appropriate to examine the degree to which the vocal ligament and vocal muscle, which form most of the body of

the vocal fold, are involved. We examined this question by studying the phonatory effect of altering the muscle (and ligament). We could not independently manipulate the tension of the muscle. (This is, in fact, the main limitation of the excised larynx preparation, and it is important to recall that these experiments simulate at best only low vocalis-tension situations.) Thus, instead of manipulating the tension, we altered the muscle by removing it.

The results of this experiment indicate that the vocal muscle in excised larynxes does not play an essential role in producing chest voice, though it may be important for falsetto. The apparent waves on the medial vocal-fold surface have the same approximate propagation velocity in intact and excised preparations. In our small sample, the only significant effect of removing the muscle on the trajectory of a particle on the superior surface was to change the angle of its major axis. However, even if the slack muscle does not play a significant role in producing phonation, varying the tension of the muscle is probably important in regulating phonation. We can only speculate on mechanisms for this control such as adjusting the tension of the vocal ligament and elastic tissues, or controlling the shape of the undersurface of the folds. Though removing the muscle does not seem to appreciably change the velocity of the apparent wave, perhaps tensing the intact



muscle would have some effect.

Aside from their implication about the importance of the muscle itself, the results of this section also indicate that the surface tissues on the lateral part of the vocal fold's superior surface probably do not influence phonation. They also show that the body of the vocal ligament itself is an essential structure in producing phonation.

#### 4A. Static Response to Varying Subglottal Pressure

In order to determine some of the static mechanical characteristics of the vocal folds, the static shape of the folds in the frontal plane was measured as subglottal pressure was systematically increased. The larynxes were placed in a phonatory configuration (with the glottis closed), and then subglottal pressure was varied through a range of values below those for which phonation was initiated. The measurement apparatus was used to obtain coordinates of several points along the vocal fold surface at each value of subglottal pressure. Three sets of these measurements, for two different larynxes are shown in Fig. 7-21.

In parts A and B of Fig. 7-21, measurements were made largely on only one fold (the left). In part C, more extensive measurements were made on both folds.

The results shown in Fig. 7-21 should be considered preliminary, and the experiments should eventually be redone more carefully. In each case, data were collected

FIGURE 7-21 (A-C)

Measured positions of the static vocal-fold surfaces in the frontal plane as a function of subglottal pressure. Each part of the figure represents an individual run in which subglottal pressure was systematically increased from zero cm. H<sub>2</sub>O in 1 cm. H<sub>2</sub>O steps. The plotting symbols represent actual measurements. They are joined by smooth lines to represent the shapes of the folds.

B

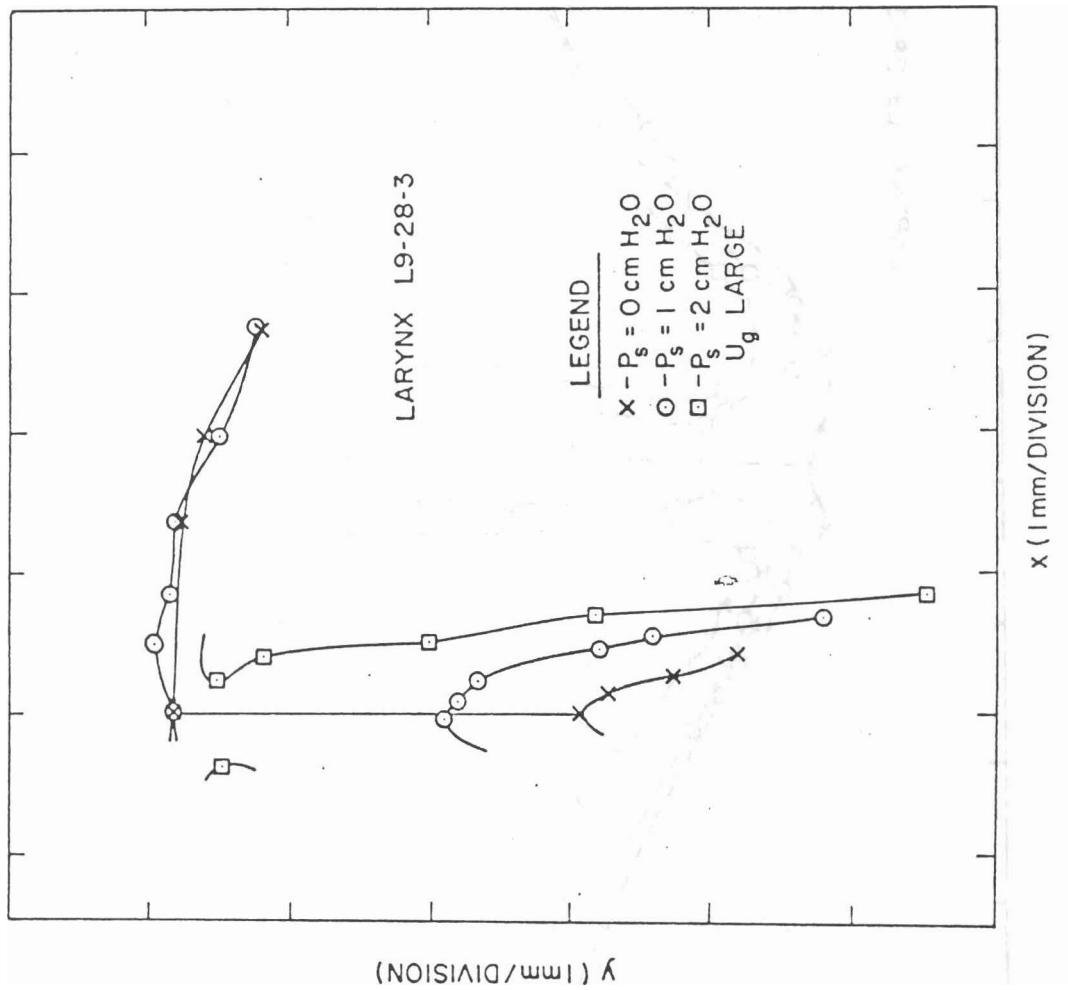

LARYNX L9-28-3

LEGEND  
X -  $P_s = 0$  cm H<sub>2</sub>O  
O -  $P_s = 1$  cm H<sub>2</sub>O  
□ -  $P_s = 2$  cm H<sub>2</sub>O  
U<sub>g</sub> NOT RECORDED  
U<sub>g</sub> = 100 cc/sec.

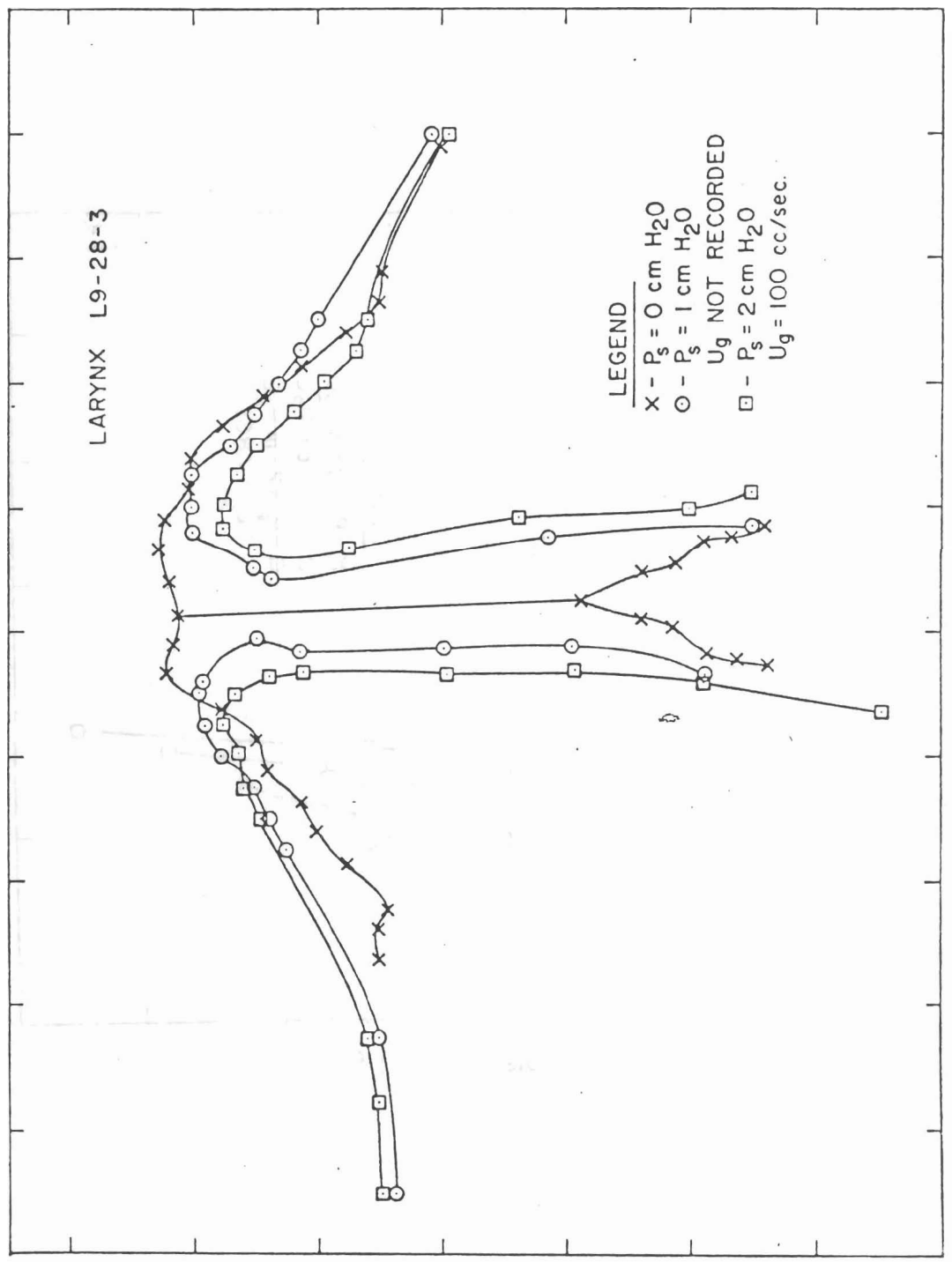

y (1 mm/DIVISION)

x (1 mm/DIVISION)

C

first for the zero subglottal pressure condition and then at successive 1 cm.  $H_2O$  increments. The measurement procedure was quite lengthy - for example, the duration of the measurements was over one and a half hours for part B and almost three hours for part C. During this period, the tissues became desiccated and the resulting change in their mechanical properties probably introduced a systematic error. For example, in parts B and C, the vertical level of the superior surface dropped during successive measurement runs, even though the subglottal pressure increased. The significance of these errors could have been estimated by repeating some of the measurements, or it could have been reduced by randomizing the order of the measurements.

Parts A and B of Fig. 7-21 show that the tissues on the inferior aspect of the vocal folds are "peeled" apart at successively higher levels as the subglottal pressure is increased. Parts B and C, which refer to the same larynx (though not necessarily in the same configuration), are similar on the medial surface for the 0 cm.  $H_2O$  and 2 cm.  $H_2O$  conditions. However, at 1 cm.  $H_2O$  subglottal pressure, the glottis is closed in part B but open in part C. Actually, during the experiment associated with part C of the figure, hysteresis was noted in the behavior of the vocal folds with varying subglottal pressure. At 1 cm.  $H_2O$ , the glottis could be closed or open, depending on whether the

value of subglottal pressure was approached from below or above, respectively. The open configuration was chosen for measurements because it was more stable.

Fig. 7-22 shows the static position as a function of subglottal pressure for the left fold of the same larynx as in part B and C of Fig. 7-21, after the vocal muscle was unilaterally excised. The plot thus shows essentially the inner and outer surfaces of the conus elasticus and ligament and whatever surface tissues are attached. The thickness of all these tissues is about 1 to 1 1/2 mm. for the 0 cm. H<sub>2</sub>O and 1 cm. H<sub>2</sub>O conditions, during which the glottis is closed. However, the measured thickness was smaller when the subglottal pressure was increased to 2 cm. H<sub>2</sub>O. This may be due to desiccation, which would be accelerated by the flow of air through the open glottis during this last part of the experiment. At the beginning of the experiment, it was noted that phonation (with a fundamental frequency of 80 Hz) was initiated at a subglottal pressure value near 2 cm. H<sub>2</sub>O. As a result of the desiccation, at the end of the experiment, the preparation would not phonate at any value of subglottal pressure.

#### 4B. Discussion

Because of experimental problems, the validity of the data presented in this section is questionable. Disregarding these problems, however, data such as these may be used

FIGURE 7-22

Measurements similar to those in Fig. 7-21 for a larynx with the left vocal muscle excised. At each value of subglottal pressure, both the inside and the outside surface of the left vocal fold is represented.

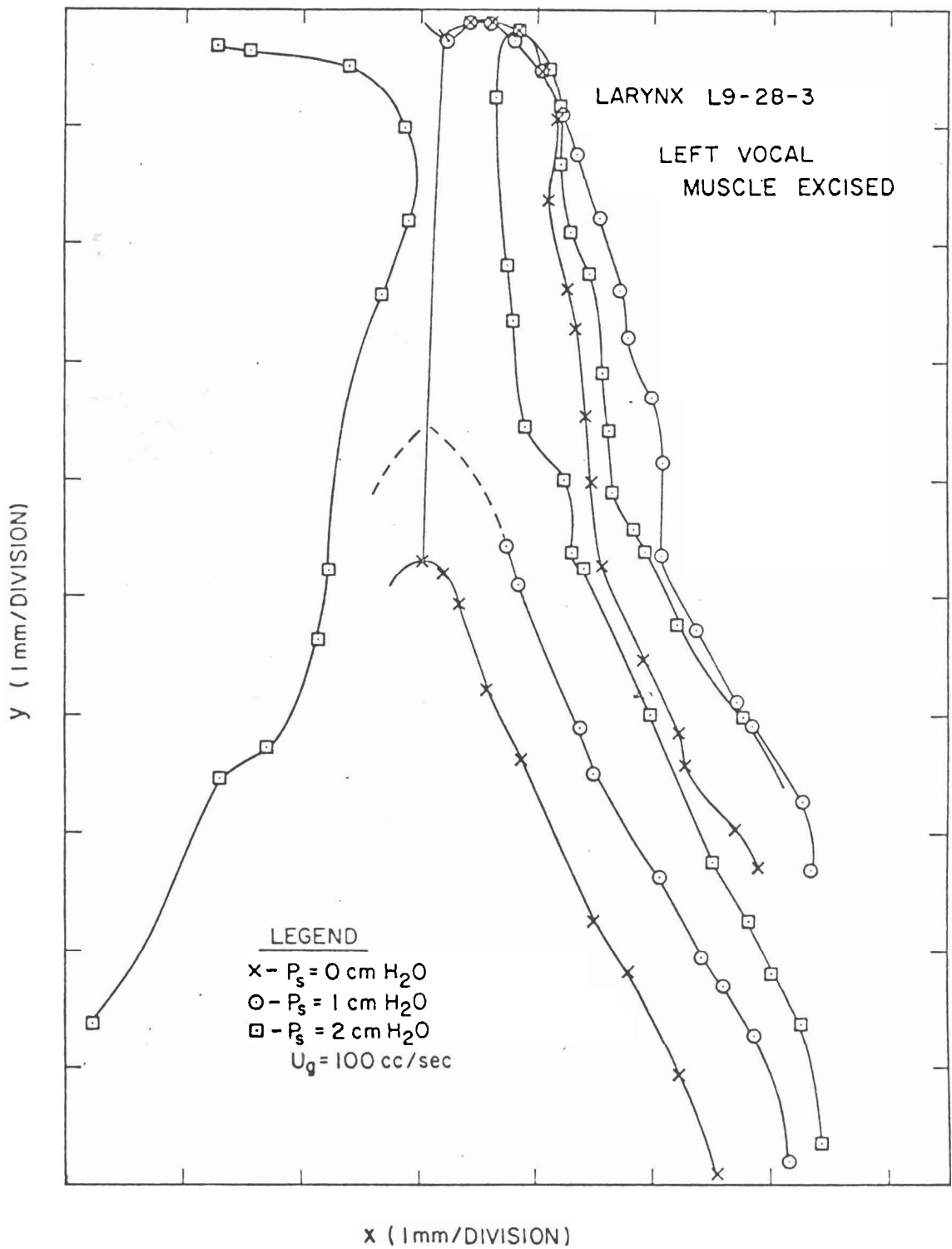



to evaluate the static mechanical constants of models of the vocal folds. In terms of the two-mass model, for example, the mass displacements,  $x_1$  and  $x_2$ , can be derived from the measurements themselves. The forcing function (pressure) is known when the glottis is closed and can be estimated when the glottis is open. From this information, the spring constants  $k_1$ ,  $k_2$ , and  $k_c$  (see Chap. 4) can be estimated. This analysis of the results will be discussed further in the following chapter.

The hysteresis effect in the glottal opening as subglottal pressure is varied may be due to surface tension effects. When the glottis is closed, surface tension may keep it closed as pressure is raised, though the glottis may be open (in the absence of surface forces) if the same value of subglottal pressure is reached from above with the glottis open. Whether or not surface tension contributes in such a way to the mechanical behavior of the folds should be investigated further if measurements such as these are used to derive mechanical properties of the tissues. (Note also the discussion of surface tension in the first part of this chapter.) It should be pointed out that surface tension is not necessary to account for the hysteresis. Such an effect can be predicted within the framework of the two-mass model, since there are, in general, at least two solutions to the static equations for the model.

Area in the frontal plane is not conserved as subglottal pressure is raised, especially in part C of Fig. 7-21 and in Fig. 7-22. In these experiments, the loss of area is probably due to loss in the water content of the tissues. However, further attention should be paid to this issue if the experiments are repeated. In part A of Fig. 7-21, the superior surface seems to bulge upward when subglottal pressure is increased to 2 cm. H<sub>2</sub>O, as mass is displaced on the undersurface of the vocal folds. The possibility of such a phenomenon was suggested in the first section of this chapter (see Fig. 7-10). However, this kind of tissue displacement does not seem to occur in parts B and C of the figure.

## Chapter 8 Application of Results to a Laryngeal Model

A stated purpose of this thesis is to produce quantitative data which can be applied directly to the problem of laryngeal modelling. The type and amount of data we have produced are not sufficient to rigorously test existing models or to develop new ones. However, it is possible (and interesting) to examine how well a specific model of the larynx (a two-segment model of the glottis and a two-mass model of the vocal folds which was discussed in Chap. 4) can be fit to the data to account for the interrelationships we have measured. Though we do not expect significant differences, it should be borne in mind that we are referring to the model for an excised dog larynx rather than a live human. This chapter is devoted to applying a two-segment fit to the measured or estimated frontal plane descriptions, and then examining how well the theory developed for the two-mass model accounts for the observed aerodynamic and mechanical phenomena.

### Location of Glottal Segments in the Frontal Plane

Vertical Level: The results presented in the previous chapter indicate that there are vertical movements of at least parts of the folds which are of significant magnitude compared to the horizontal movements, whereas the model allows only horizontal movements of the two masses. We will allow the vertical position of the two segments to vary,

following the (subjectively defined) upper edge of the folds as reconstructed from the data. This assumption does not conflict with the aerodynamic theory. However, it does conflict with the assumptions of the mechanical two-mass model. Our procedure is valid only if vertical and horizontal components of the vibrations are not coupled.

We will set the total vertical thickness of the two segments to three millimeters, as has been commonly assumed by modellers of the human glottis (e.g. van den Berg et al., 1957; Crystal, 1966; Ishizaka and Flanagan, 1972). We will also arbitrarily set the two segments equal in vertical thickness (each 1.5 mm).

An alternative method, which we did not adopt, is suggested by our finding that vertical extent of the trajectories decreases with descending level. The glottal segment corresponding to mass 1 may be more nearly fixed in vertical level, and that corresponding to mass 2 would vary in vertical thickness, extending from the top of mass 1 to the superior surface of the fold. This procedure might be warranted by the observation that the superior surface of the fold in Fig. 7-11 and Fig. 7-12 bulges up near the midline during the closed period and early open period as if the mass of that part of the fold is "squeezed" - i.e. reduced in horizontal depth but increased in vertical thickness.

Horizontal Displacement: Given a graphical representa-

tion of the shape of the glottis in frontal section, an objective method is needed to assign horizontal positions for the two segments. The horizontal distance from the midline of the graphical representation will normally vary over the vertical extents of interest. For mechanical considerations, we are concerned with displacements of a "center of mass". Since the glottal segments represent the surface of model masses, a reasonable procedure is to set the horizontal position of the segment equal to the average horizontal position of the graph over the appropriate vertical range (i.e. "simple averaging"). For aerodynamic considerations, however, this method gives insufficient weighting to small glottal widths. For example, if the glottis is closed over only a small part of its thickness, the simple average will give a nonzero width although clearly there can be no airflow. Thus, for aerodynamic considerations, a more appropriate algorithm is to set the inverse square of the model's horizontal position equal to the average inverse square value of the measured displacements over the appropriate vertical range (i.e. "inverse square averaging"). The results of this calculation, when substituted into the aerodynamic formulae for the two-segment glottis give a more realistic estimate of glottal airflow. Given the airflow and assuming ideal Bernoulli relationships along the part of the glottis corresponding to mass 1, then the

calculated value of the pressure  $P_1$  corresponds to the average value of pressure over the range if the inverse square displacements are used.

As a result of these considerations, we will use the inverse square calculations except when applied to the lower segment while the upper segment is closed. In this restricted situation, when there is no airflow, we will use the simple average calculation.

Though it is not necessary to consider the horizontal depth of the masses here, we observe that this value should probably be 1.0 to 1.5 mm., in accordance with our findings in the previous chapter that essentially normal vibrations are possible with only a membrane of that thickness.

Results of Calculations: The two-segment model was fit to the sketches (shown in Figures 7-11 and 7-12) which were reconstructed from measurements. Figure 8-1 shows the horizontal displacement waveforms for the two segments and also a plot of their vertical level. Fig. 8-2 shows the segments superimposed on the sketches themselves, to illustrate graphically the averaging procedure. In Fig. 8-1, the dashed line indicates the result of using inverse square averaging rather than simple averaging for the segment corresponding to mass 1 when the one corresponding to mass 2 is closed. At phase 7 mass 1 momentarily touches the midline according to the inverse square calculation,

FIGURE 8-1

Plots of the varying parameters of the two section fits to the glottal shapes in Fig. 7-11. The upper part of the figure shows variation in the vertical level of the two sections. The lower part of the figure shows the horizontal distance from the midline of the two sections. The plotting symbols show the results of the calculations. They have arbitrarily been joined by a smooth curve. The symbols joined by the solid line show the results of applying the algorithm described in the text. The symbols joined by the broken line show the result of applying the inverse-square calculation to the lower section when the upper section is closed.

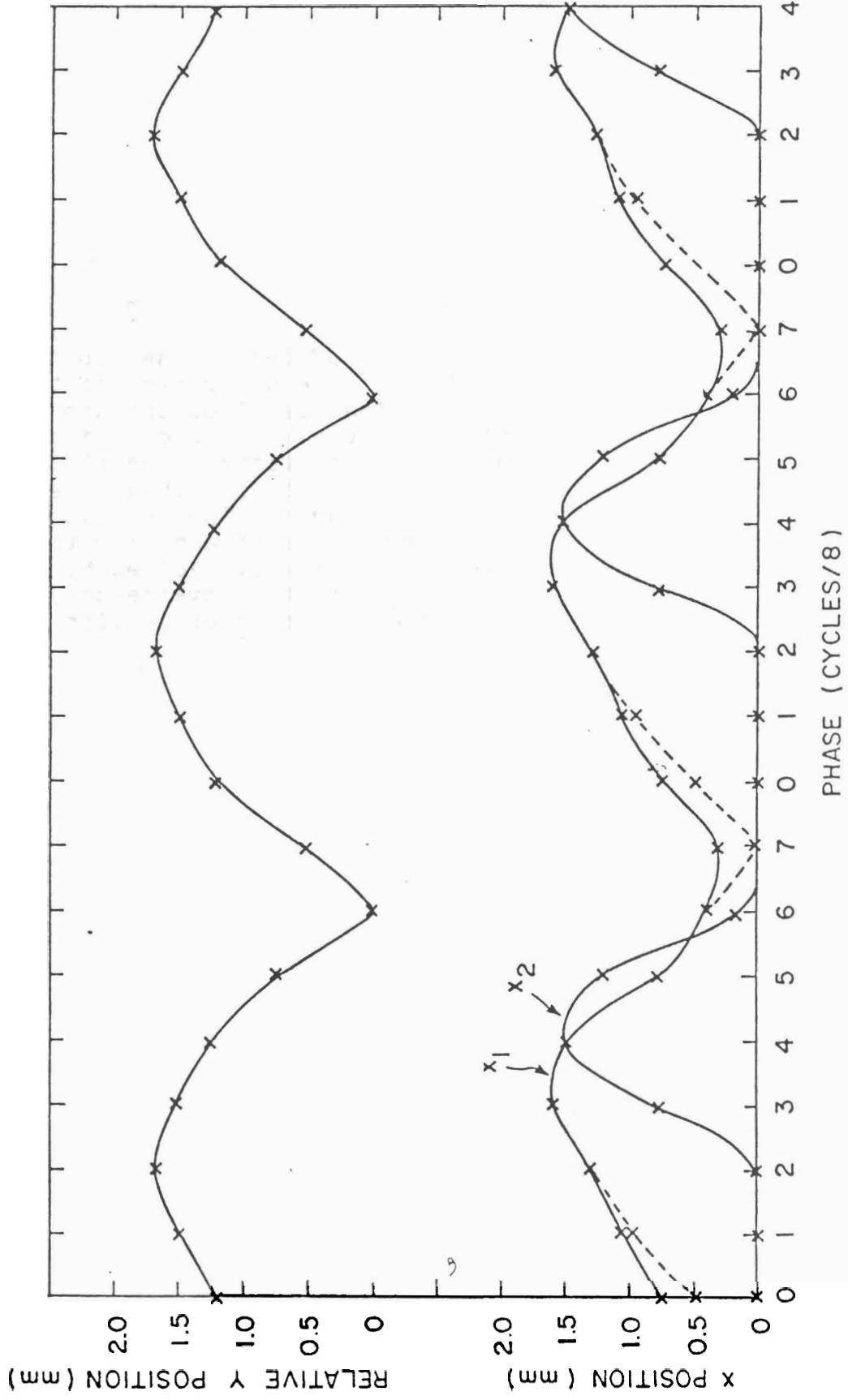
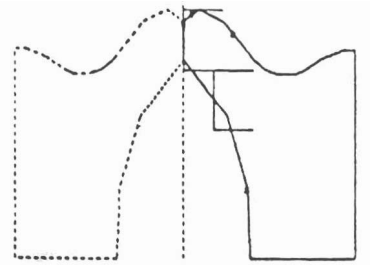



FIGURE 8-2

Sketches of the vocal-fold frontal sections from Fig. 7-11 with the derived two-section approximation superimposed.

0



4

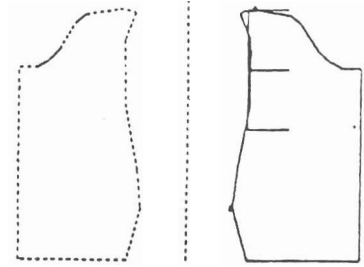

1

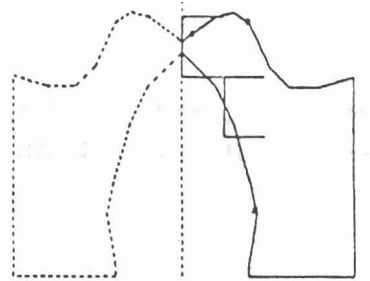

5

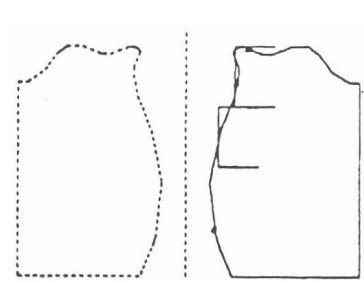

2

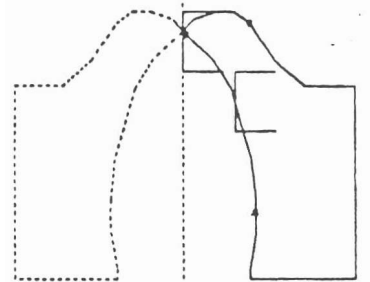

6

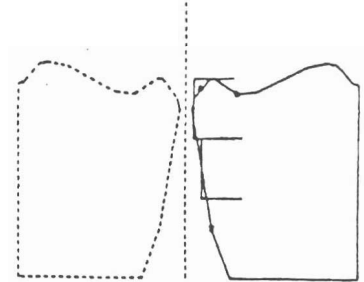

3

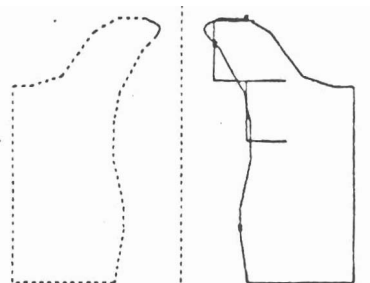

7

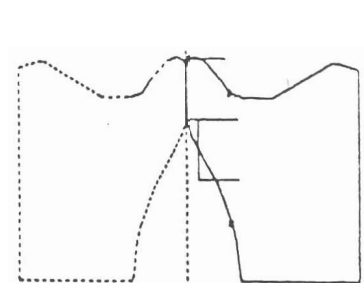

but Fig. 8-2 shows that the actual border of the fold touches the midline only at the extreme of the vertical range of mass 1. Thus, the simple average calculation appears more realistic for this situation.

The waveform for  $x_1$ , then, never reaches zero. It is a fairly smooth waveform (weighted toward the low part of the spectrum) with a maximum slightly past phase 3 and a minimum roughly a half cycle away at phase 7. The waveform for  $x_2$  is more pulsatile, since it is zero for almost one-half of the cycle. Its peak occurs near phase 4, lagging about  $1/8$  cycle the peak for  $x_1$ . (This is despite the fact, observed in the previous chapter, that particle 2 lags behind particle 3 by about  $1/2$  cycle.)

A two-segment fit was also applied to the results of the static experiments described in the previous chapter. The segment positions were calculated for the shapes plotted in Fig. 7-21 and Fig. 7-22 using the same averaging procedures as for the vibration case. The results are tabulated in the fifth and sixth columns of Table 8.1.

#### Aerodynamic Theory: Calculation of Average Airflow

According to the aerodynamic theory developed for the two-mass model, glottal airflow can be calculated from the relationship

$$U^2 = 2/\rho \frac{P_s (2L)^2}{(.37/x_1^2 + 1/x_2^2)}$$

(see chapter 4). For the purposes of this chapter,  $x_1$  and  $x_2$  are the assigned displacements of the glottal segments corresponding to mass 1 and mass 2, respectively, and  $L$  is the length of the equivalent rectangle (having the same area as the actual glottis).  $L$  is thus generally smaller than the total length of the glottis. It may be noted that the above relationship ignores not only time varying effects but also effects of viscosity. However, calculations (Stevens, in preparation) indicate that viscous effects are insignificant for displacement values greater than about 0.2 mm when  $P_s$  is at a normal value for phonation, so we are justified in ignoring them in most of our calculations for the vibrating case. However, the critical value is higher for smaller values of  $P_s$ , so it may not be valid to neglect these effects for the static cases.

The above relationship was applied to the data plotted in Fig. 8-1, which was derived from the phonatory patterns sketched in Figs. 7-11 and 7-12. In thus deriving the volume velocity waveform, we followed the convention of other modellers in assuming that subglottal pressure is constant (at its measured value of  $8 \times 10^3$  dynes/cm<sup>2</sup>), though actually there may be significant variation during the cycle (see Chap. 7).

The results of the calculation, normalized to the effective length,  $L$ , are plotted in Fig. 8-3. The average

FIGURE 8-3

Calculated waveforms of normalized glottal volume velocity from the model. The quantity represented is volume velocity per unit glottal length. The plotting symbols indicate the calculated values. They are arbitrarily joined by a smooth curve.

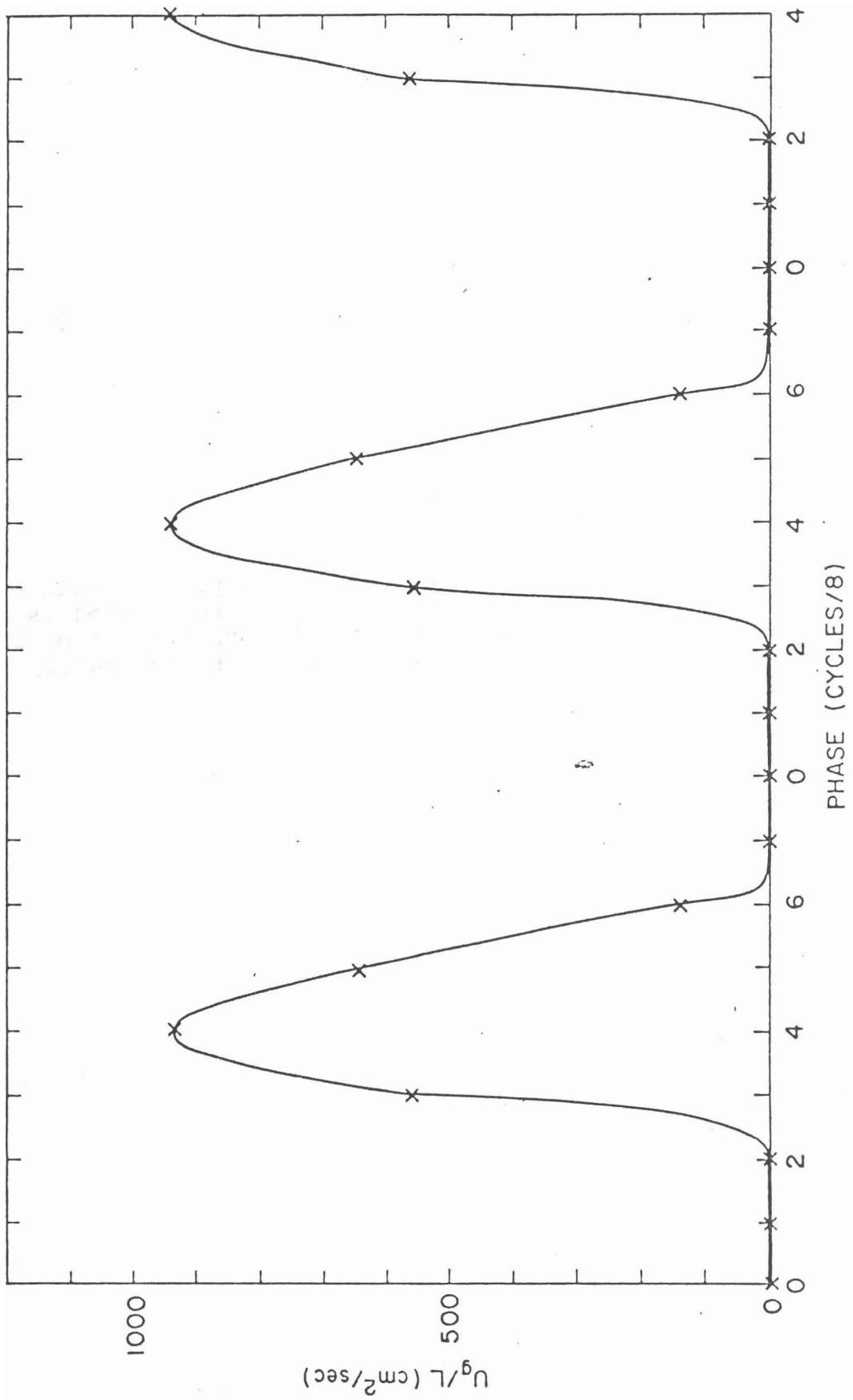

value of this normalized variable is about  $286 \text{ cm}^2/\text{sec}$ . In order to agree with the measured value of  $U_g = 275 \text{ cc/sec}$ ,  $L$  must be close to  $1.0 \text{ cm}$ . This value is probably reasonable. [The actual glottal length was not measured during the experiment, but it was probably about  $1.2 \text{ cm}$ .] However, it should be pointed out that we are assuming all the measured flow is through the intermembranous glottis. If there is a significant intercartilaginous leak, then the actual flow through the intermembranous glottis is less than  $275 \text{ cc/sec}$ ., and the effective length would have to be smaller in order to force agreement.

In chapter 7, it was noted that an effective term due to volume displacement of the vocal folds should be added to the volume velocity waveform. The magnitude of this term during the closed period (phase increments 7 to 2) was shown in Fig. 7-16, where it was calculated over an effective length of  $1.25 \text{ cm}$ . For the supraglottal component, the magnitude is  $15 - 25 \text{ cc/sec}$ . Reference to Fig. 7-14 indicates that the component due to displacement of area during the open period might add a maximum of about  $25 \text{ cc/sec}$ . during the phase interval 4-5. These values are seen to be quite insignificant in comparison to the calculated through-flow values.

The form of the calculated volume velocity waveform is that of a series of pulses. Each pulse has a sharper onset

than offset, and the rising portion is shorter in duration than the falling section. Both these attributes are opposite to those of the normal human volume velocity waveform. However, the cause of this result is probably just that glottal inertence was not considered, or possibly that there are variations in the effective length,  $L$ . Also, viscous effects would sharpen the waveform somewhat near the closed period. The calculated volume velocity waveform in fact resembles the glottal width waveform (i.e. the minimum of the widths for  $m_1$  and  $m_2$ ), which is known to commonly have a shorter rising than falling phase (Sonesson, 1960; Timke et al., 1958).

Further test of the aerodynamic theory can be made using the results of the static experiments. The third column of Table 8-1 indicates that there are three cases for which measurement of the actual volume velocity are available. The fourth column of the table shows that actual measurements of the glottal length are available for two of these three cases.

The results of applying the volume velocity calculations using the subglottal pressure from column 2 and the displacements from columns 5 and 6 are tabulated in column 7 of table 8-1. The values are expressed normalized to the effective length,  $L$ . For the first case where there is a measured value of  $U_g$  the calculated value of  $U_g/L$



is  $170 \text{ cm}^2/\text{sec}$ , compared to a measured value for  $U_g$  of  $150 \text{ cc}/\text{sec}$ . Therefore, this agreement seems reasonable with a value of  $L$  equal to  $0.9 \text{ cm}$ . In the second case, the calculated normalized value is  $156 \text{ cm}^2/\text{sec}$ , compared to the measured value of  $100 \text{ cc}/\text{sec}$ . To force agreement, the value of  $L$  must be between  $0.6$  and  $0.7 \text{ cm}$ . As shown in column 4 of the table, the actual length of the glottis for this situation was measured as  $0.8 \text{ cm}$ . Since the effective value will generally be smaller than the actual length, agreement is not unreasonable. In the last case (the excised muscle experiment), the calculated value is  $143 \text{ cm}^2/\text{sec}$  and the measured value is  $100 \text{ cc}/\text{sec}$ . Thus,  $L$  must be about  $0.7$  to force agreement. The actual measured length of the glottis was about  $1.0 \text{ cm}$ . This agreement is again probably within allowable limits to confirm the aerodynamic model.

In summary, to the limited extent we were able to perform an analysis, the aerodynamic theory developed for the two-mass model seems adequate to account for measured relationships between glottal airflow and subglottal pressure. This agreement tends to support Ishizaka's formulation for the kinetic loss at the glottal exit (Ishizaka and Matsudaira, 1972) rather than van den Berg *et al.*'s (1957) findings - which would imply a coefficient of  $0.5$  rather than  $1.0$  for the  $1/x_2^2$  term. However, more detailed data

are required in order to test the theory adequately.

#### Calculation of $P_1$

Given the subglottal pressure,  $P_s$ , and the displacements  $x_1$  and  $x_2$ , the pressure in the lower section,  $P_1$ , can be calculated from the relationship

$$P_1 = P_s \frac{1 - (x_2/x_1)^2}{1 + .37(x_2/x_1)^2} \quad \text{when } x_1 \neq 0.$$

The parameter  $L$  does not enter into this calculation. As before, viscous and time-varying effects have been neglected. According to the theory,  $P_2$  is always near zero when the glottis is open.

The  $P_1$  waveform for the vibration pattern illustrated in Fig. 7-11 and Fig. 7-12 was calculated, again using the data plotted in Fig. 8-1 and assuming  $P_s$  constant at 8 cm.  $H_2O$  throughout the cycle. Fig. 8-4 shows a plot of the results. The pressure  $P_1$  is always well defined, since  $x_1$  never becomes zero.

According to the calculation,  $P_1$  is negative at only one of the eight phase increments (viz. phase 5). The magnitude of this negative value, however, is greater than the maximum positive value ( $P_s$ ). The  $P_1$  waveform therefore is a negative pulse with its peak near phase 5. The average value of  $P_1$  is 4.22 cm.  $H_2O$ . Therefore, the average (negative) magnitude of the pressure waveform, considering 8-cm.  $H_2O$  as a baseline, is 3.78 cm.  $H_2O$ .

FIGURE 8-4

Calculated waveforms of the pressure,  $P_1$ , in the lower section of the model. The calculated values are indicated by the plotting symbols. They are arbitrarily connected by a smooth curve.

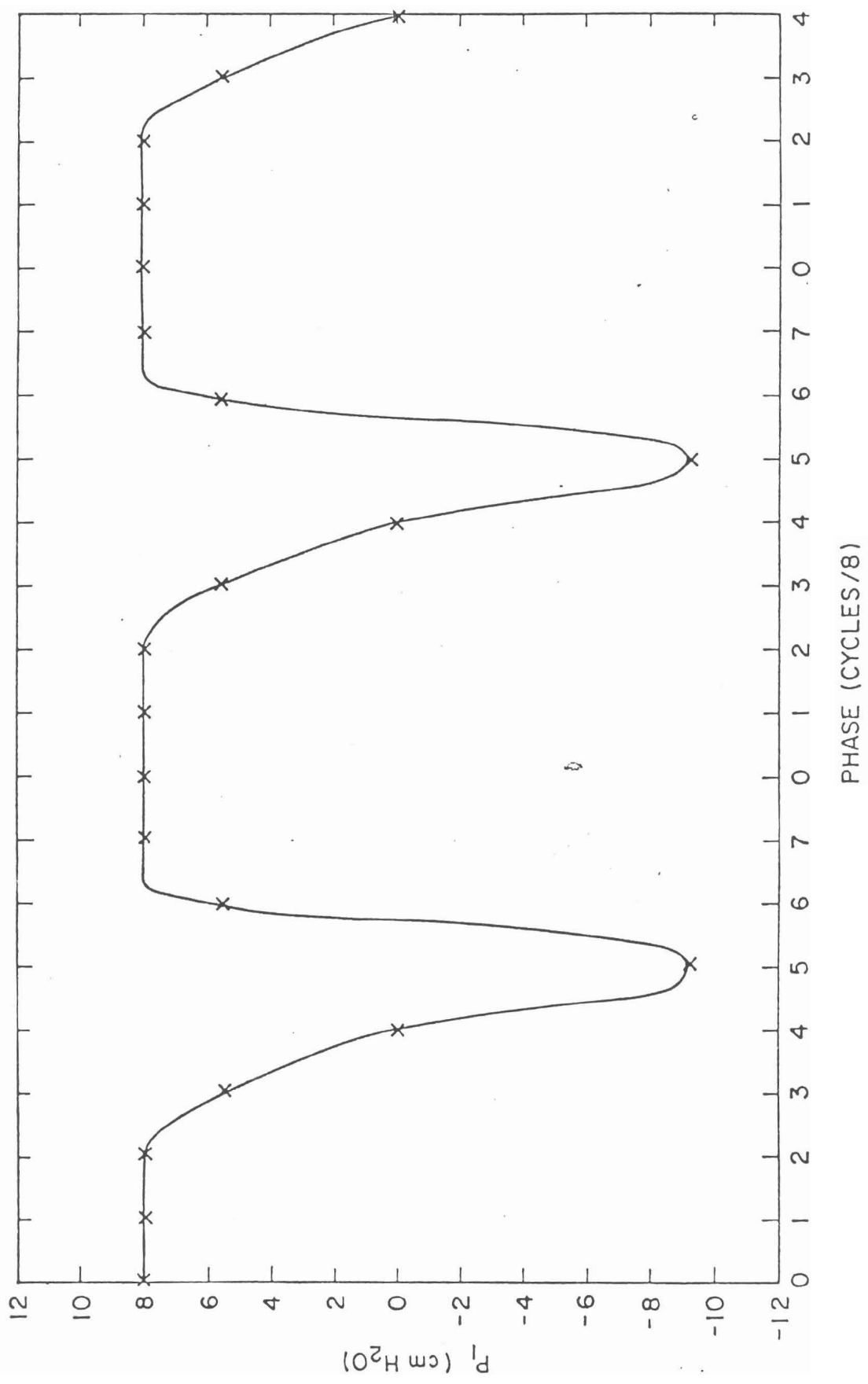

Small text or stamp, possibly a date or reference number, located in the middle left margin.



The work done by  $P_1$  in driving the mechanical vibrations is proportional to the term

$$\oint P_1 dx_1 = \int_0^{\tau} P_1 \frac{dx_1}{dt} dt ,$$

where the left integral is taken around a complete cycle of  $x_1$ , and the right integral is correspondingly taken over one glottal period. The left hand integral is taken as the area of the locus of the vibrations in the  $P_1 - X_1$  plane. The integrand of the right hand expression is the instantaneous power transfer from the aerodynamic system in the glottis to the mechanical vibrations.

Figure 8-5 shows the trajectory of the vibrations in the  $P_1 - X_1$  plane. The sense of the trajectory is such that its area in the above expression is positive. Thus, the theory does indeed provide that aerodynamic forces drive the mechanical vibrations. The regions of the trajectory enclosed by broken lines in Fig. 8-5 are the only ones for which the power transfer, as defined in the right hand expression above, is negative. During these parts of the cycle, mechanical energy stored during the rest of the cycle is used to oppose the aerodynamic forces. One such part of the cycle immediately precedes closure. Thus, closure itself is due to momentum of mass 1 and/or elastic restoring forces, but is not directly caused by negative glottal pressure. (However, it is indirectly caused partly by the negative glottal

FIGURE 8-5

Trajectory of vibrations of the model in the  $P_1 - X_1$  plane. The portions of the trajectory enclosed by the broken lines are those for which the aerodynamic-to-mechanical power transfer is negative.

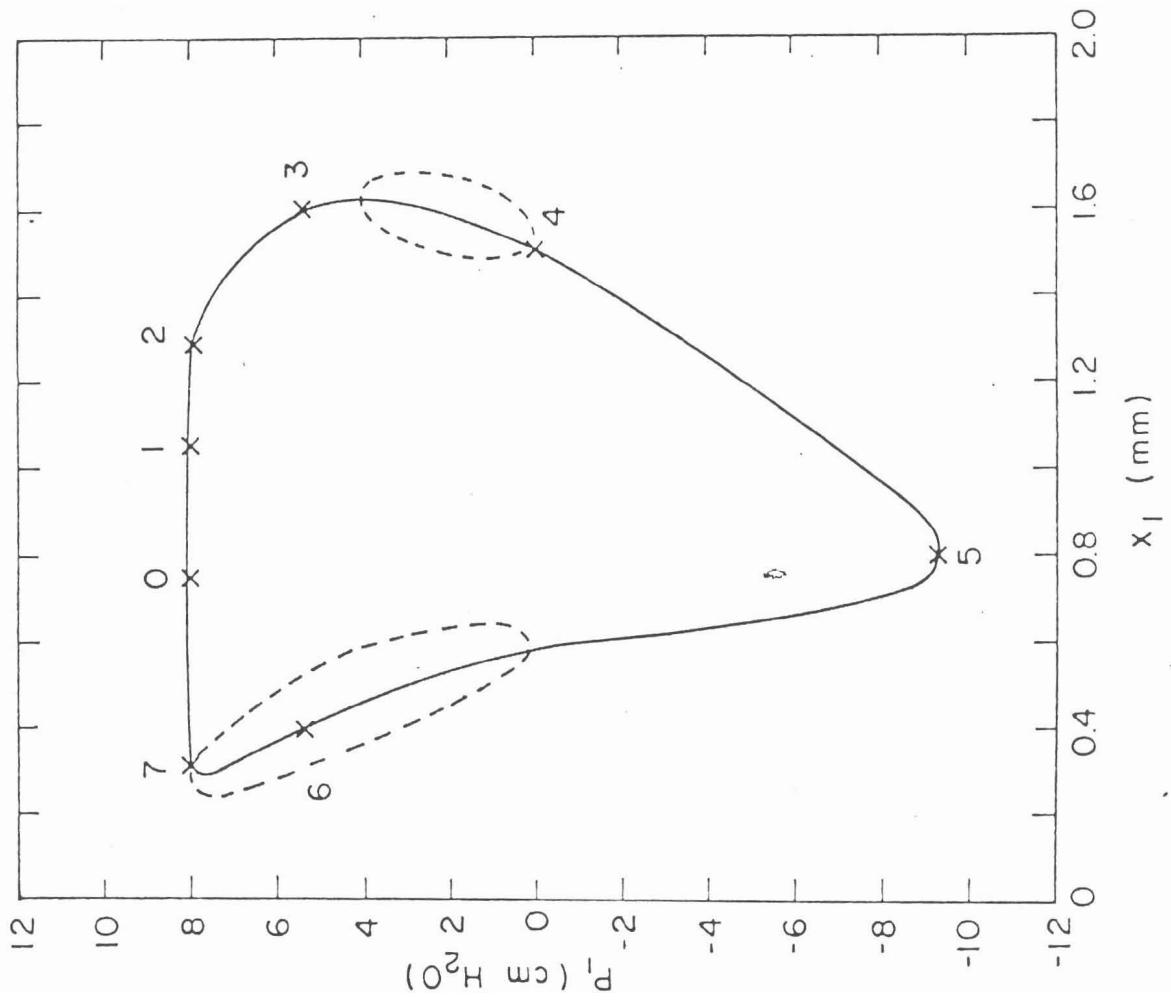

pressure at phase increment 5).

$P_1$  has also been calculated for the static experiments. The results are tabulated in the last column of Table 8-1. Pressure cannot be determined, or is not meaningful, when  $x_1 = 0$ . In the first static experiment, it is interesting to note that  $P_1$  decreases despite an increase of  $P_s$  when the glottis opens.

The calculated values of  $P_1$  will be applied to further analyses in the next section.

#### Sample Calculations of Mechanical Constants for the Two-Mass Model

Derivation of Elastic Constants: The results of the static experiments can be substituted into the static equations for the two-mass model to estimate some of the constants. In their simplest form (assuming the elastic forces linear), the static equations are:

$$k_1(x_1 - x_{10}) + k_c(x_1 - x_2) = P_1 L d_1$$

$$k_2(x_2 - x_{20}) + k_c(x_2 + x_1) = P_2 L d_2 \quad \text{when } x_2 \neq 0$$

The constants which are to be estimated are the elastic constants  $K_1$ ,  $K_2$ , and  $K_c$ , and the offset values  $X_{10}$  and  $X_{20}$ . The offset values are apparently zero or negative for these experiments.  $Ld_1$  and  $Ld_2$  are the glottal-surface area of mass 1 and mass 2, respectively. For each static experiment,



we have several sets of values for  $x_1$ ,  $x_2$ , and  $P_1$  to substitute into these equations. There are not enough samples with  $x_2 \neq 0$ , so we cannot make much use of the second equation. However, we can use the first.

For the first static experiment, (see table 8-1)  $|K_1 x_{10}|$  is at least equivalent to a pressure of 1 cm.  $H_2O$ . If we assume that  $x_1$  becomes nonzero for  $P_1$  just slightly greater than 1 cm.  $H_2O$ , then the magnitude of  $k_1 x_{10}$  is just  $10^3 L d_1$  dynes. Then, for  $P_s = 2$  cm.  $H_2O$  and  $P_s = 3$  cm.  $H_2O$ , the equation yields

$$k_1 + k_c = L d_1 / .018 * 10^3 \quad \text{and}$$

$$k_c = L d_1 [ .055 / .043 * 1 / .018 + 1 / .011 ].$$

This produces the contradictory relationship  $K_c > K_1 + K_c$ . Thus, the simple two-mass theory is not adequate to account for these results, either because of the form of the mechanical model itself or because of the aerodynamic model for estimating  $P_1$ . Possibly the neglect of viscosity was not appropriate. (It may be noted that a consistent result may have been obtained if a higher value of  $P_1$  had been used for the  $P_2 = 3$  cm.  $H_2O$  condition.) If, in fact, it is the aerodynamic calculation and not the mechanical theory which is inadequate, then the estimate of  $k_1 + k_2$  is still valid. Assuming representative values of  $L$  and  $d_1$ , we would then

TABLE 8-1

Results of fitting a two section glottal model to results of static experiments (see text). Actual glottal length was measured in only 4 cases.

Experiment	Measured Values			Calculated Values			
	$P_s$ (cm H <sub>2</sub> O)	$U_g$ (cc/sec)	Glottal Length (cm) (where measured)	$x_1$ (mm)	$x_2$ (mm)	$U_{g/L}$ (cm <sup>2</sup> /sec)	$P_1$ (cm H <sub>2</sub> O)
Larynx L9-14-3 (Fig. 7-21A)	0	0	-	0.0	0.0	0	-
	1	0	-	0.0	0.0	0	-
	2	0	-	0.18	0.0	0	2.00
	3	150	-	0.50	0.43	170	0.60
Larynx L9-28-3 (Fig. 7-21B)	0	0	-	0.0	0.0	0	-
	1	Leak	-	0.23	0.0	0	1.00
	2	Large	1.3	0.60	0.40	133	1.00
Larynx L9-28-3 (Fig. 7-21C)	0	0	-	0.0	0.0	0	-
	1	Not Recorded	0.6	0.39	0.30	70	0.33
	2	100	0.8	0.57	0.48	156	0.46
Larynx L9-28-3 (Fig. 7-22)	0	0	-	0.0	0.0	0	-
	1	0	-	0.0	0.0	0	-
	2	100	1.0	0.57	0.43	143	0.71

find  $k_1 + k_c$  to be the order of  $10^4$  dynes/cm. This value is somewhat smaller than those suggested by Ishizaka's associates -  $k_1 > 50$  to  $80 \times 10^3$ ,  $k_2 > 12 \times 10^3$ ,  $k_2 < k_1$  (Kaneko et al., 1971; Ishizaka and Flanagan, 1972).

For the second experiment in Table 8-1, we know that  $|K_1 x_{10}| < Ld_1 \times 10^3$ . Then, from the  $P_s = 1$  cm.  $H_2O$  condition,  $K_1 + K_c \leq 10^3 / .023 \times Ld_1$  with equality only if  $x_{01} = 0$ . (This value is only slightly smaller than that derived from the first experiment.) If we assume equality, then the  $P_s = 2$  cm.  $H_2O$  condition yields  $K_c = 10^3 / 0.28 \times Ld_1$ . Thus, we derive that  $K_c$  is about five times stiffer than  $K_1$ .  $K_2$  cannot be determined from these equations as long as  $x_{02}$  remains unknown. However, the relationship

$$k_2 = \frac{k_c}{2 + |x_{20}| / .020}$$

can be obtained, indicating that  $K_2$  is no bigger than  $K_c/2$  and maybe much smaller.

For this third experiment in Table 8-1, simultaneous equations can be solved eliminating  $|x_{10}|$  and  $k_c$ , since  $(x_1 - x_2)$  is the same for  $P_s = 1$  cm.  $H_2O$  and  $P_s = 2$  cm.  $H_2O$ . Thus, we derive  $K_1 = \frac{Ld_1}{0.14} \times 10^3$ , which is the order of  $10^3$  dynes/cm. assuming representative values for  $L$  and  $d_1$ . However, the solution of the equations yields an unphysical negative value for  $k_c$ . The value for  $K_1$  is one to two orders of magnitude below that derived by other investigators

(see Ishizaka and Flanagan, 1972).

For the last (excised muscle) experiment in Table 8-1, there is insufficient data to make any estimates.

In summary, the static experiments are not well described by a linearized two-mass model. However, it is not clear whether the main difficulty is with the mechanical model, with the aerodynamic theory for estimating  $P_1$ , or with the measurements themselves. The estimates of  $K_1 + K_c$  in the first two experiments, which depended only on data obtained with the glottis closed, are more consistent and more reasonable than the other results. Some of the unphysical results might have been more realistic if the estimated values of  $P_1$  during the open glottis configuration had been higher. However, as was already discussed in Chapter 7, there is also reason to distrust the experiments themselves. Rather than focusing on any individual results, it is more useful to consider this section as describing a method for evaluating constants in the two-mass model which should be pursued further.

Further Analysis of Dynamic Results: The fundamental spectral component of the waveform for  $x_1$  in Fig. 8-1 has a peak amplitude of about 0.06 cm, and the phase of this component is approximately phase 3 (i.e.  $3\pi/4$  radians relative to zero phase in the figure. The  $x_2$  waveform is approximately a squared half-rectified cosine whose peak is

slightly past phase 4. Using this approximation, its fundamental spectral component has an amplitude of  $2/3\pi \times 0.15$  cm. and a phase of about increment 4. Finally, if the  $P_1$  waveform shown in Fig. 8-4 is approximated as a negative pulse with average (DC) value of 4.25 cm.  $H_2O$ , its first spectral component has amplitude of about  $4.25 \times 10^3$  dynes/cm<sup>2</sup> and phase of increment 1.

The equation describing the dynamics of mass 1 is:

$$m_1 \ddot{x}_1 + r_1 \dot{x}_1 + k_1(x_1 - x_{10}) + k_c(x_1 - x_2) = Ld_1 P_1$$

in which  $x_1$ ,  $x_2$ , and  $P_1$  are functions of time (see Chap. 4).

Converting to the frequency domain:

$$(-m_1 \omega^2 + j2\alpha_1 \sqrt{(k_1 + k_c)m_1} \omega + k_1 + k_c)x_1 = Ld_1 + k_c x_2 + \text{DC terms}$$

where now  $x_1$ ,  $x_2$ , and  $P_1$  are functions of frequency,  $f$ , and  $\omega = 2\pi f$ . The damping ratio  $\alpha_1 = r_1 / 2\sqrt{(k_1 + k_c)m_1}$  has been introduced. ( $j$  is the square root of  $-1$ .)

We can make a (very rough) estimate of some constants by solving this equation for  $f$  at the fundamental frequency (100 Hz):

$$-40 \times 10^4 m_1 + j12.6 \times 10^2 \alpha_1 \sqrt{(k_1 + k_c)m_1} + k_1 + k_c = \frac{j3.78 \times 10^3 Ld_1 + (1-j)/\sqrt{2} \cdot .032 k_c}{.06}$$

Equating real terms:

$$40 \times 10^4 m_1 = k_1 + .63 k_c$$

If we arbitrarily set  $M_1 = .020$  grams, then

$k_1 + .63 k_c = 0.8 \times 10^4$ , which is similar to the estimates derived from the static experiments.

Equating imaginary terms:

$$6.3 * 10^2 \alpha_1 \sqrt{(k_1 + k_2)m_1} = 63 * 10^3 Ld_1 - 0.37k_c$$

Again setting  $m_1 = .020$  grams and  $K_1 + K_c = 10^4$ , the result

$$\alpha_1 \approx Ld_1 \frac{6.3 * 10^3}{1.8 * 10^4} - \frac{0.37k_c}{1.8 * 10^4}$$

is obtained. Assuming a representative value for  $Ld_1$ , this becomes

$$\alpha_1 \approx 0.6 - \frac{0.37k_c}{1.8 * 10^4}$$

We expect  $K_c$  to be the order of magnitude of  $10^4$  dynes/cm.

Therefore  $\alpha_1$  is expected to be about 0.4, which implies somewhat more damping than the approximate value of 0.1 suggested by Ishizaka (see Ishizaka and Flanagan, 1972).

It is emphasized that this analysis was carried out on only the first spectral component, and was based on only rough estimates of the spectra. Further experimentation and further analysis of results would be useful.

## Chapter 9 Conclusions

The results of this thesis are briefly summarized and discussed in the first part of this chapter. In short, experimental equipment and techniques were developed and used to observe phonating excised larynxes in apparent stopped- or slow-motion, both from the supraglottal and subglottal aspects. Detailed measurements of the vibration patterns of the larynxes were made. It can be concluded that useful results were produced using the equipment and techniques. A body of data was collected and was used to test aspects of a specific theory of phonation and to develop constraints for models in general. A tentative new interpretation of the nature of the mechanical vibrations was formulated.

The line of research initiated with these experiments should be continued and extended. Specific suggestions for such further research are contained at the end of this chapter.

### Experimental Limitations

Aside from the inherent limitations of the excised larynx preparation (for example, that tissue properties are not exactly those of the live larynx and that vocalis muscle activity is impossible to simulate), some further experimental limitations were noted. Physiological steady-state was difficult to maintain for the duration of a run, due largely to the problem of maintaining constant properties of the laryngeal tissues. In particular, it was difficult to



prevent desiccation of the tissues. The flow rates produced were generally somewhat greater than those for normal human phonation. The high flow rates were probably due in part to the anatomical differences between canine and human larynxes and possibly due in part to physiological differences between live and excised larynxes. The subglottal system was an inaccurate model of the normal human or dog subglottal system, although it was probably more accurate than those in other such experiments. Although the "respiratory source" for many of the experiments was basically a pressure regulator rather than a flow regulator, its effective DC source resistance was approximately ten times that of the normal human or canine system. The acoustic properties of the subglottal system were also somewhat inaccurate. The first resonance (with the glottis closed) was in the range of 300 to 400 Hz. and the resonances were probably too poorly damped. Finally, a limitation in interpreting the data from particle-trajectory measurements was imposed by uncertainty as to whether the particles were firmly attached to the surface tissues. (The particles whose trajectories were measured were probably well fixed on the tissues.)

#### Summary of Results

An apparently normal chest register vibration pattern could be produced and falsetto register could also be achieved. However, the ability to produce falsetto was

dramatically impaired when the tissues became desiccated. A distinct mid register, differentiated by the degree of activity of the subglottal portions of the vocal folds, may have been produced. However, apparent register shifts may be attributable solely to acoustic effects of the subglottal tract rather than shift of the overall mode of vibration. (This phenomenon should be studied in greater detail.) Only phonatory vibrations that were classified as "chest voice" were used for measurements.

The minimum value of subglottal pressure for which phonatory vibrations were spontaneously initiated was about 3 cm. H<sub>2</sub>O. The minimum value for sustaining phonation was about 2 cm. H<sub>2</sub>O. In general, the value of subglottal pressure necessary to initiate phonation was greater than that necessary to sustain phonation. (This finding has possible implications for explaining the coarticulation of voicing during the production of consonants in speech.) Both values increased dramatically as the surface tissues of the larynx became desiccated.

Effects of surface tension forces between the surfaces of the two vocal folds were noted on non-phonatory larynxes. Surface tension did not seem to be an important factor during phonation, however.

As subglottal pressure was systematically increased with other factors remaining constant, fundamental frequency

was found to increase at a rate of 5 to 7 Hz./cm.  $H_2O$  (Figs. 6-2, 6-3, and 6-4). Substantial increases in fundamental frequency were obtained by stretching the vocal folds (Fig. 6-5).

Initial measurements on one larynx (Fig. 7-1) showed that the total vertical extent in a frontal plane of "large" (greater than about 0.3 mm.) vibrations was about 5 to 7 mm. The vertical extent of the locus of points at which closure occurred was about 3 mm. Another measurement (Fig. 6-7) showed this locus to encompass about 4.5 mm., with maximum instantaneous depth of closure about 3 mm. The minimum instantaneous depth of glottal closure, just before opening, was almost infinitesimally small.

Measurements of particle trajectories during simulated normal phonation (Fig. 7-2) formed the main source of quantitative results directly relating to phonation. The shapes of the trajectories were generally described as perturbed ellipses, although trajectories of particles furthest from the midline were more nearly straight lines. Movement around the ellipses was clockwise in the coordinate system with medial to the left and superior up. The perturbations of the ellipses often included secondary loops, which were usually near the most medial parts of the trajectories. Vertical components were greater than horizontal components for particles on or near the superior surfaces of the vocal folds. Horizontal components were greater for more inferior

particles. In terms of the overall vibration patterns, particles on the undersurface generally moved laterally during the closed period and medially during the open period. Particles on or near the supraglottal surface moved medially and superiorly during the closed period and began moving inferiorly and laterally at the beginning of the open period. The vibrations were such that particles near the superior-medial "edge" of the vocal folds appeared to be on the superior surface for some parts of the cycles and on the glottal walls during other parts of the cycle. "Simultaneous" measurements of the trajectories of two or more particles during a run (parts G and H of Fig. 7-2) revealed phase differences between corresponding parts of the trajectories of particles at different vertical levels.

Vibrations of the glottal wall appeared to be describable as displacement waves propagating in the superior direction. The vertical phase differences and the concave shape of the glottal walls noted in high-speed films of phonation (Farnsworth, 1940; Smith, 1954) are natural consequences of this wave motion. Propagation velocity was found to be about 1 m/sec. Glottal closure, which according to this concept results from contact between wave peaks of both sides, appeared to propagate as a wave. There was clearly a displacement wave propagating laterally on the superior surfaces of the vocal folds. Such waves can also be seen

in high-speed films of normal human phonation (van den Berg, 1958). The velocity of this wave was found to be about 0.3 to 0.5 m/sec.

The shape of the lower part of the glottis during the closed period changed from that of an inverted V at the beginning of the period to dome shaped (inverted U) at the end of the period (Fig. 7-5). This pattern could be consistent with the notion of a propagating wave and could also be consistent with the notion of overall mass displacement such that the folds "roll" across each other (Fig. 7-9 and Fig. 7-10).

Peak-to-peak subglottal pressure variations, though not measured exactly, were at least 35% and possibly as much as 100% of the average subglottal pressure. Aspects of the subglottal pressure waveform were well correlated with the instant of maximum glottal opening and were also correlated with the instant of glottal closure (Fig. 7-8).

Measurements of trajectories were made while the tissues became desiccated (Fig. 7-18). In some cases, the tissues became so dry that phonatory vibrations were no longer sustained. Physical correlates of desiccation were presumably increase of stiffness, loss of mass, and/or change of surface properties. Fundamental frequency generally increased as the tissues became desiccated, though sometimes both fundamental frequency and subglottal pressure decreased. The principle

effect of tissue desiccation on the trajectories was decrease in their vertical components without much change in their horizontal components until vibrations stopped completely. It was thus concluded that vertical components are closely associated with the mechanisms for sustaining horizontal components. The decrease of the vertical components might have been associated with a decrease in the magnitude of the AC component of the subglottal pressure waveform. This effect should be studied in future work. Perturbations in the trajectories were not affected in a systematic way by tissue desiccation. Thus, the perturbations themselves did not appear to be essential for phonation. Measurement of the final static position of a particle (Fig. 7-18B) after the vibrations spontaneously stopped showed that the trajectory could be considered as oscillation about a static operating point within the trajectory. The operating point is apparently lateral and superior to the rest position of the particle with zero subglottal pressure (Fig. 7-18B, Fig. 7-7).

Excised larynxes were able to produce nearly-normal vibration patterns even when the vocalis muscle on one or both sides was completely removed. The trajectories of particles near the superior surfaces of these vocal folds were similar to those from preparations with intact muscles, except that the major axes of the ellipses tilted in the

supero-lateral direction rather than the supero-medial direction. With the excised-muscle preparations, the apparent waves on the glottal walls could also be observed on the external surfaces of the membranes. A similar propagation velocity (1.1 m/sec.) was measured. It did not seem possible to produce falsetto phonation with excised-muscle preparations. This result seems counterintuitive, since falsetto is thought of as involving only the tightly stretched vocal ligament while chest voice is thought to involve both the muscle and the ligament. (This result suggests that the vocal muscle on the superior surface of the fold must be present to limit vibrations of the ligament and/or suppress vibrations on other parts of the folds in order to produce falsetto.) It was not possible to produce chest register phonation when the vocal ligament was significantly impaired. Thus, properties of the vocal ligament are important for chest voice. The experiments also show that the supraglottal wave observed in chest voice phonation of "normal" larynxes is not necessary for phonation.

Measurements were made on non-vibrating larynxes to reconstruct the glottal shapes (in frontal section) when they were initially closed but gradually opened as subglottal pressure was increased (Fig. 7-21 and 7-22). The data contain a systematic bias, since measurements were made in order of increasing subglottal pressure and the tissues became desiccated during the runs. The data were used to test some

of the assumptions and evaluate some of the constants of the two-mass model (in Chap. 8). Because of the experimental difficulties, conclusions about the mechanical system are tenuous. However, conclusions relating to the aerodynamic system depend only on the measurements for a single value of subglottal pressure and are thus less sensitive to the experimental problems.

Using the three data points in Fig. 7-2H and some additional information, estimates were made of the shape of the vocal fold at each phase increment (Figs. 7-11 and 7-12). According to these sketches, the surface tissues of the larynx were significantly stretched in the vertical direction during the closed period and slackened during the open period (Fig. 7-14). Assuming the laryngeal tissues to be incompressible, it was not possible to account for the mass of the vocal folds throughout a cycle on the basis of the sketches (Figs. 7-14 and 7-15). The sketches show that there is effective airflow during the closed period due to the displacement of volume above and below closure. However, analysis of the magnitude of this effect (Fig. 7-16) showed that it produced flow rates insignificant (less than 5%) compared to those of the open period (Fig. 8-3).

The form of the sketches of the vocal folds at different phases of the vibration cycle suggested that string vibrations of the vocal ligament, as well as the surface waves



on the mucosa and conus elasticus, contributed to the vibration patterns (Fig. 7-17). These "string vibrations included both translation of the mass of the string around the trajectory and also torsional flexure of the string. This concept is discussed further below.

The sketches and aerodynamic data obtained during phonation and from the static experiments were analyzed using the framework of the two-mass model. In order to apply a two-section fit to the sketches of the glottis, it was necessary for the sections to vary in vertical position. According to the fitting algorithm adopted, the lower section never closed during the glottal cycle. Vertical movements of the sections were found to be of about the same magnitude as the horizontal movements (Fig. 8-1).

The aerodynamic theory of the two-mass model, as formulated by Ishizaka and Matsudaira (1968, 1972) was adequate to roughly account for the relationships between average subglottal pressure and average airflow. The intraglottal pressure predicted by this theory (Fig. 8-4) was reasonable to the extent that it fed energy to the mechanical system (Fig. 8-5). These tests of the theory are not very sensitive, however.

Using the results of the static experiments, attempts were made to estimate values for the elastic constants of the two-mass model. The sum  $k_1 + k_c$  was estimated to be

about  $10^4$  dynes/cm., or about an order of magnitude less than that suggested by other investigators. Although some further estimates of elastic constants were made, the linearized mechanical model could not be well fit to the data. The results suggested, however, that  $k_c$  is greater than both  $k_1$  and  $k_2$ .

Very rough analyses of the dynamic results yielded similar estimates for the elastic constants  $k_1$  and  $k_c$ . It also suggested a value of 0.4 for the damping constant,  $\alpha_1$ , implying a more damped system than that suggested by other investigators.

In summary, the results of evaluating the two-mass model suggested that its aerodynamic aspects could account for our results but its mechanical aspects were inadequate in some respects. (It was pointed out, however, that our tests of the aerodynamic model were not very sensitive. Actual dynamic subglottal pressure and dynamic glottal flow were not measured for the experiment with phonation, and the vertical distribution of pressure was not measured in any of the experiments.) With respect to the mechanical model, although the data leading to the static analysis in Chapter 8 were questionable, the dynamic analyses showed that vertical movements of the folds could not be ignored. In Chapter 7, not only were vertical components of the vibrations found to be significant in magnitude, but also the results of the measurements during tissue desiccation suggested that they

were functionally significant. (It might be argued that the vertical movements could be ignored if they were independent of the horizontal movements, but apparently they were not.) Measurement of the subglottal pressure waveform showed that relatively large variations in vertical forces were produced during a cycle, as expected from models and in agreement with some measurements on humans (see Chaps. 3 and 4). Analyses of the sketches of the frontal sections showed that the surface tissues were stretched during the cycle (presumably producing vertical forces) and also that the glottis assumed shapes which could not be well approximated by a two-section model. Finally, accounting for the duration of the closed portion of the glottal period, which is handled in an ad hoc fashion in two-mass-model simulations' (Ishizaka and Flanagan, 1972), appeared to follow from the description of glottal closure as a wave or wavelike phenomenon. That is, although tissues were almost immediately peeled apart at the lower edge of closure, tissues on each fold above closure continued to move toward the midline.

We have suggested, as an alternative to the two-mass model, one which provides for membrane or surface waves on the conus elasticus and mucous membrane and also possibly string vibrations of the vocal ligament. This concept bears some similarity to the theory recently discussed by Hirano (1974), in which vibrations of the mucous membrane (treated as the "cover" of the vocal fold) were differentiated from

those of all the muscular and elastic tissues (the "body" of the vocal fold). Because of the results of the experiments with excised vocal muscles, however, we consider the mucous membrane and conus elasticus to form a single vibratory unit in the lateral dimension. It is not clear whether the ligament should be considered to include its mucous cover as a single unit.

The possible modelling implications of our characterization of the mechanical vibrations are that the vocal ligament should have an essentially lumped-parameter representation (consisting of perhaps only one mass) while the model of the membrane should be essentially distributed (consisting of several small coupled masses). These masses should be movable in the vertical as well as the horizontal direction. The model for the ligament might include torsional flexure (rotation). The masses associated with the membrane have a relatively small effective thickness (ratio of mass to surface area) and are exposed to aerodynamic forces with large dynamic components. The ligament has greater ratio of mass to surface area and is exposed (directly or indirectly) to relatively small aerodynamic forces. The forces on the ligament are a consequence of mechanical coupling from the membrane. The elements representing the membrane must be adjusted such that a disturbance at one section in the presence of airflow propagates downstream at an effective

velocity of about 1 m/sec.

It is unclear, both for the model and for the real larynx, what mechanisms are responsible for controlling such aspects of the vibrations as fundamental frequency and open quotient. At least in some modes of vibration, the properties of the vocal ligament must be primarily responsible for controlling fundamental frequency. However, in chest register, we can speculate that the properties of the membrane are also important. This notion might be supported by the extreme dependence of the performance of excised larynxes on the properties of the tissues (since performance was severely affected before the properties of the ligament could have changed very much).

We have noted that the vibrating portion of the membrane was roughly 5 mm. in vertical extent and that wave velocity was 1 m/sec., so that a wave traversed the extent of the membrane in about 5 msec. At a fundamental frequency of 100 Hz. - roughly the average fundamental frequency produced without stretching the folds in these experiments - the extent of the membrane was 1/2 wavelength so that disturbances traversed the membrane in 1/2 cycle. Thus, as the glottis opened, a medial deflection occurred near the base of the membrane and this deflection reached the level of the ligament 1/2 cycle later, pulling it closed again. Perhaps the mechanism of phonation required that the vertical extent of the membrane remain in some fixed range with respect to a

wavelength (whose magnitude varies inversely with fundamental frequency). A correlation between vocal fold thickness and fundamental frequency has been noted for normal human phonation (Hollien and Colton, 1969; Hollien and Coleman, 1970). It is interesting, though not necessarily meaningful, to note that when the fundamental frequency is 50 Hz. (about the lowest frequency produced by excised larynxes in chest voice), the extent of the membrane would be just  $1/4$  wavelength. It is tempting to speculate that it is just this relationship which sets the lower limit of fundamental frequency.

#### Suggestions for Further Research

Further experimentation and theoretical analysis are required to further specify and evaluate the model of the vocal folds and to confirm or refute the speculations, contained in the previous paragraphs. Such questions as whether the propagation velocity depends on the length of the glottis or the rate of airflow past the tissues, or whether the effective vertical extent of the membrane varies with subglottal pressure might be investigated. It would also be useful to determine the natural frequency of the ligament in the absence of aerodynamic forces.

In general, the techniques developed for this thesis can be exploited in future work both to obtain more and better data of the type already collected and to extend the type of measurements made. Along with more complete measure-

ments of glottal shapes, better measurements of subglottal pressure waveforms and the inclusion of measurements of the glottal volume velocity waveforms are needed. With these data, it would be possible to systematically study the aerodynamic properties of actual glottal shapes and adequately test models of the aerodynamic system. For example, rigid models of the glottis could be reconstructed from the measurements and be instrumented for detailed aerodynamic measurements (using techniques such as those of van den Berg, 1957). Measurements of the pressure distribution within an actual glottis might also be made, at least during static experiments.

The properties of the mechanical system may also be more systematically studied. The static experiments described in Chapter 7, for example, would be more useful if the effects of tissue desiccation were removed and also if the vertical distribution of pressure were known more accurately. The properties of the mechanical system could also be profitably studied by applying dynamic excitations. For example, it would be interesting to determine the mechanical response to spatially-constant but time-varying intraglottal pressure, if such a pressure could be produced. To produce it would require the attachment of a supraglottal chamber.) This kind of experiment would not only produce direct measurement of the mechanical impedance of the folds, but would also provide a direct test of the importance of

vertical distribution of glottal pressure (as opposed to the magnitude of intraglottal pressure itself) in producing vocal fold movements. It would also be useful to apply direct mechanical (vibrotactile) excitations - for example, over small areas to determine whether waves are propagated and to measure their properties. Lateral distribution of the vibrations is another aspect of the mechanical system that can be studied using various techniques. Finally, in order to investigate the function of the vocalis muscle, techniques for manipulating its physical properties might be investigated.

The effects of the subglottal system on phonation should be investigated in more detail. In addition, if a supraglottal tract were attached, the effects of the vocal tract could be studied. Experiments in which larynxes are actuated with gasses other than air and under abnormal ambient pressure conditions may also improve our understanding of phonation.

Although the research described here was largely concerned with the detailed study of steady phonation using stroboscopic techniques, it would be extremely worthwhile to study in detail the initiation of phonation using high-speed techniques. Careful observation should be made of the initiation of vibrations from both the subglottal and supraglottal aspects. These observations would determine, for example, whether phonatory vibrations originate as



subglottal ripples or as deflections of the tissues in the superior parts of the glottis.

Finally, it is pointed out that some of the measurements made on excised canine preparations should also be repeated on excised human preparations and ultimately also on live canine preparations. It was pointed out in Chapter 1 that the experiments reported here apply directly only to phonation as produced by excised canine larynxes. The additional experiments would help to determine both the importance of the canine-human distinction and of the excised-live distinction.

## References

- Anthony, J.K.F., "Study of the Larynx II", Works in Progress no. 2, 77-82, Dept. of Phonetics and Linguistics, University of Edinburgh, Scotland (1968).
- Atkinson, J.E., Aspects of Intonation in Speech: Implications From an Experimental Study of Fundamental Frequency, Ph.D. Thesis, U. of Conn. (1973).
- Bouhuys, A., J. Mead, D.F. Proctor, and K.N. Stevens, "Pressure"Flow Events During Singing", *Annals N. Y. Acad. Sci.* 155, 165-176 (1968).
- Bradley, O.C., Topographical Anatomy of the Dog, Macmillan and Co., N.Y. (1959).
- Broad, D., "Phonation", Chapter in Normal Aspects of Speech, Hearing, and Language, Minifie, Hixon, and Williams, eds., Prentice Hall, Englewood Cliffs, N.J. (1973).
- Crystal, T.H., A Model of Laryngeal Activity During Phonation, Sc.D. Thesis, M.I.T. (1966).
- Damste, P.H., "X-Ray Study of Phonation", *Folia Phoniatr.* 20, 65-88 (1968).
- Damste, P.H., H. Hollien, P. Moore, and T. Murry, "An X-Ray Study of Vocal Fold Length", *Folia Phoniatr.* 20, 349-359 (1968).
- Draper, H.H., P. Ladefoged, and D. Whitteridge, "Respiratory Muscles in Speech", *J. Speech Hearing Res.* 2, 16-27 (1959).
- Dudgeon, D., Multi-Mass Simulation of the Vocal Cords, B.S.-M.S. Thesis, M.I.T. (1969).
- Edmonds, T.D., D.J. Lilly, and J.C. Hardy, "Dynamic Characteristics of Air-Pressure Measuring Systems Used in Speech Research", *J. Acoust. Soc. Am.* 50, 1051-1057 (1971).
- Faaborg-Anderson, K., "Electromyographic Investigation of Intrinsic Laryngeal Muscles in Humans", *Acta Physiologica Scandinavica* 41, supplementum 140 (1957).
- Fabre, M.P., "Etude Comparée des Glottogrammes et des Phonogrammes de la Voix Humaine", *Ann. d'Otolaryng.* 75, 767-775 (1958).

- Fant, A., Acoustic Theory of Speech Production, Mouton and Co., 's-Gravenhage (1960).
- Fant, G., K. Ishizaka, J. Lindqvist, and J. Sundberg, "Subglottal Formants", Speech Transmission Laboratory, Quarterly Progress and Status Report 1/1972, 1-12, Royal Institute of Technology, Stockholm (1972).
- Farnsworth, D.W., "High-Speed Motion Pictures of the Human Vocal Cords", Bell Lab. Record 18, 203-208 (1940).
- Ferrein, A., "De La Formation de la Voic de l'Homme", Hist. Acad. Roy. Sc. 409-432 (1741).
- Flanagan, J.L., "Some Properties of the Glottal Sound Source", J. Speech Hearing Res. 1, 99-116 (1958).
- Flanagan, J.L., "Source-System Interaction in the Vocal Tract", Annals N. Y. Acad. Sci. 155, 9-17 (1968).
- Flanagan, J.L. and L. Landgraf, "Self-Oscillating Source for Vocal-Tract Synthesizers", IEEE Trans. Audio Electroacoust. AU-16, 57-64 (1968).
- Flanagan, J.L., "Use of an Interactive Laboratory Computer to Study an Acoustic-Oscillator Model of the Vocal Cords", IEEE Trans. Audio Electroacoust. AU-17, 2-6 (1969).
- Fourcin, A.J. and E. Abberton, "First Application of a New Laryngograph", Medical and Biological Illustration 21, 172-182 (1971).
- Gay, T., H. Hirano, M. Strome, and M. Sawashima, "Electromyography of the Intrinsic Laryngeal Muscles During Phonation", Ann. Otol. Rhinol. Laryng. 81, 401-409 (1972).
- Grant, J.C.B., Grants Atlas of Anatomy, Williams and Wilkins, Baltimore (1962).
- Gray, H., Anatomy of the Human Body, Lea and Febiger, Philadelphia (1959).
- Hast, M., "Physiological Mechanisms of Phonation: Tension of the Vocal Fold Muscle", Acta Oto-Laryngologica 62, 309-318 (1966).
- Hast, M., "Studies on the Extrinsic Laryngeal Muscles", Archives Otolaryng. 88, 71-76 (1968).

- Henke, W., "Signals from External Accelerometers During Phonation: Attributes and Their Internal Physical Correlates", Quarterly Progress Report 114, 224-231, Research Lab. of Electronics, M.I.T. (1974).
- Hiki, S., Y. Koike, and H. Takahashi, "Simultaneous Measurement of Subglottal and Supraglottal Pressure Variation", J. Acoust. Soc. Am. 48, 118-119 (1970).
- Hirano, M. Y. Koike, and H. von Leden, "Maximum Phonation Time and Air Usage During Phonation", Folia Phoniatr. 20, 185-201 (1968).
- Hirano, M. and J. Ohala, "Use of Hooked-Wire Electrodes for Electromyography of the Intrinsic Laryngeal Muscles", J. Speech Hearing Res. 12, 362-373 (1969).
- Hirano, M., J. Ohala, and W. Vennard, "The Function of the Laryngeal Muscles in Regulating Fundamental Frequency and Intensity in Phonation", J. Speech Hearing Res. 12, 616-628 (1969).
- Hirano, M., W. Vennard, and J. Ohala, "Regulation of Register, Pitch, and Intensity of Voice", Folia Phoniatr. 22; 1-20 (1970).
- Hirano, M., "Morphological Structure of the Vocal Cord as a Vibrator and its Variations", Folia Phoniatr. 26, 89-94 (1974).
- Hirose, H., T. Ushijima, T. Kobayashi, and M. Sawashima, "An Experimental Study of the Contraction Properties of the Laryngeal Muscles in the Cat", Ann. Otol. 78, 297-307 (1969).
- Hiroto, I., "The Mechanism of Phonation - Its Pathophysiological Aspects", Oto-Rhino-Laryngol. Clinic, Kyoto 39, 229-291 (1966). (in Japanese)
- Hixon, T.J., D.H. Klatt, and J. Mead, "Influence of Forced Transglottal Pressure Changes on Vocal Fundamental Frequency", J. Acoust. Soc. Am. 49, 105 (1971).
- Hollien, H., "Vocal Pitch Variation Related to Changes in Vocal Fold Length", J. Speech Hearing Res. 3, 150-156 (1960).

- Hollien, H. and P. Moore, "Measurements of the Vocal Folds During Changes in Pitch", J. Speech Hearing Res. 3, 157-165 (1960).
- Hollien, H. and J. Curtis, "Elevation and Fitting of the Vocal Folds as a Function of Vocal Pitch", Folia Phoniatr. 14, 23-36 (1962).
- Hollien, H. P. Moore, R.W. Wendahl, and J. F. Michel, "On the Nature of Vocal Fry", J. Speech Hearing Res. 9, 245-247 (1966).
- Hollien, H.; R. Coleman and P. Moore, "Stroboscopic Laminagraphy of the Larynx During Phonation", Acta Oto-Laryngologica 65, 209-215 (1968).
- Hollien, H. J.F. Curtis, and R.F. Coleman, "Investigation of Laryngeal Phenomena by Stroboscopic Laminagraphy", Medical Research Engineering 7, 24-27 (1968).
- Hollien, H. and J.F. Michel, "Vocal Fry as a Phonational Register", J. Speech Hearing Res. 11, 600-604 (1968).
- Hollien, H. and R.H. Colton, "Four Laminagraphic Studies of Vocal Fold Thickness", Folia Phoniatr. 21, 179-198 (1969).
- Hollien, H. and R.F. Coleman, "Laryngeal Correlates of Frequency Change: A STROL Study", J. Speech Hearing Res. 13, 271-278 (1970).
- Holmes, J., "An Investigation of the Volume Velocity Waveform at the Larynx During Speech by Means of an Inverse Filter", Proc. of the Speech Communication Seminar, Speech Transmission Lab., Royal Institute of Technology, Stockholm (1963).
- Husson, R., Etude de Phenomenes Physiologiques et Acoustiques Fondamentaux de la Voix Chantee, Thesis, Paris (1950).
- Ishizaka, K. and T. Kaneko, "On Equivalent Mechanical Constants of the Vocal Cords", J. Acoust. Soc. Japan 24, 312-313 (1968).
- Ishizaka, K. and M. Matsudaira, "Analysis of the Vibration of the Vocal Cords", J. Acoust. Soc. Japan 24, 311-312 (1968).

- Hollien, H. and P. Moore, "Measurements of the Vocal Folds During Changes in Pitch", J. Speech Hearing Res. 3, 157-165 (1960).
- Hollien, H. and J. Curtis, "Elevation and Fitting of the Vocal Folds as a Function of Vocal Pitch", Folia Phoniatr. 14, 23-36 (1962).
- Hollien, H. P. Moore, R.W. Wendahl, and J. F. Michel, "On the Nature of Vocal Fry", J. Speech Hearing Res. 9, 245-247 (1966).
- Hollien, H.; R. Coleman and P. Moore, "Stroboscopic Laminagraphy of the Larynx During Phonation", Acta Oto-Laryngologica 65, 209-215 (1968).
- Hollien, H. J.F. Curtis, and R.F. Coleman, "Investigation of Laryngeal Phenomena by Stroboscopic Laminagraphy", Medical Research Engineering 7, 24-27 (1968).
- Hollien, H. and J.F. Michel, "Vocal Fry as a Phonational Register", J. Speech Hearing Res. 11, 600-604 (1968).
- Hollien, H. and R.H. Colton, "Four Laminagraphic Studies of Vocal Fold Thickness", Folia Phoniatr. 21, 179-198 (1969).
- Hollien, H. and R.F. Coleman, "Laryngeal Correlates of Frequency Change: A STROL Study", J. Speech Hearing Res. 13, 271-278 (1970).
- Holmes, J., "An Investigation of the Volume Velocity Waveform at the Larynx During Speech by Means of an Inverse Filter", Proc. of the Speech Communication Seminar, Speech Transmission Lab., Royal Institute of Technology, Stockholm (1963).
- Husson, R., Etude de Phenomenes Physiologiques et Acoustiques Fondamentaux de la Voix Chantee, Thesis, Paris (1950).
- Ishizaka, K. and T. Kaneko, "On Equivalent Mechanical Constants of the Vocal Cords", J. Acoust. Soc. Japan 24, 312-313 (1968).
- Ishizaka, K. and M. Matsudaira, "Analysis of the Vibration of the Vocal Cords", J. Acoust. Soc. Japan 24, 311-312 (1968).

- Koike, Y. and M. Hirano, "Glottal-Area Time Function and Subglottal Pressure Variation", *J. Acoust. Soc. Am.* 54, 1618-1627 (1973).
- Koyama, T., M. Kawasaki, and J.H. Ogura, "Mechanism of Voice Production I. Regulation of Vocal Intensity", *Laryngoscope* 79, 337-354 (1969).
- Koyama, T., J.E. Harvey, and J.H. Ogura, "Mechanism of Voice Production II. Regulation of Pitch", *Laryngoscope* 81, 47-65 (1971).
- Kunze, L.H., "Evaluation of Methods of Estimating Sub-Glottal Air Pressure", *J. Speech Hearing Res.* 7, 151-164 (1964).
- Ladefoged, P., "Subglottal Activity During Speech", *Proc. of the Fourth Int. Congress of Phonetic Sciences*, Helsinki, Mouton (1962).
- Ladefoged, P., A Phonetic Study of West African Languages, Cambridge Univ. Press, Cambridge (1964).
- Ladefoged, P., Three Areas of Experimental Phonetics, Oxford Univ. Press, London (1967).
- Lieberman, P., "Perturbations in Vocal Pitch", *J. Acoust. Soc. Am.* 33, 597-603 (1961).
- Lieberman, P., Intonation, Perception, and Language, Research Monograph no. 38, M.I.T. Press, Cambridge (1967).
- Lieberman, P., R. Knudson, and J. Mead, "Determination of the Rate of Change of Fundamental Frequency with Respect to Subglottal Air Pressure During Sustained Phonation", *J. Acoust. Soc. Am.* 45, 1537-1543 (1969).
- Lindqvist, J., "Laryngeal Mechanisms in Speech", *Quarterly Progress and Status Report 2-3/1969*, 26-32, Speech Transmission Laboratory, Royal Institute of Technology, Stockholm (1969).
- Lindqvist, J. and J. Sundberg, "Pharyngeal Constriction", *Quarterly Progress and Status Report 4/1971*, 26-31, Speech Transmission Laboratory, Royal Institute of Technology, Stockholm (1971).
- Lisker, L., A.S. Abramson, F.S. Cooper, and M.H. Schweg, "Transillumination of the Larynx in Running Speech", *J. Acoust. Soc. Am.* 45, 1544-1546 (1969).

- Martensson, A. and C.R. Skoglund, "Contraction Properties of Intrinsic Laryngeal Muscles", *Acta Physiologica Scandinavica* 60, 318-336 (1964).
- Marakami, Y. and J.A. Kirchner, "Mechanical and Physiological Properties of Reflex Laryngeal Closure", *Ann. Otol. Rhinol. Laryng.* 81, 59-71 (1972).
- Mathews, M., M. Miller, and E. David, "Pitch Synchronous Analysis of Voiced Sounds", *J. Acoust. Soc. Am.* 33, 179-186 (1961).
- Matsushita, H., "Vocal Cord Vibration of Excised Larynges: A Study with Ultra-high Speed Cinematography", *Otologia Fukuoka* 15, 127-142 (1969).
- McGlone, R.E. and T.S. Shipp, "Some Physiological Correlates of Vocal Fry Phonation", *J. Speech Hearing Res.* 14, 769-775 (1971).
- Mead, J., "Volume Displacement Body Plethysmograph for Respiratory Measurements in Human Subjects", *J. Appl. Physiol.* 15, 736-740 (1960).
- Miller, M., A. Christensen and H. Evans, Anatomy of the Dog, W.B. Saunders Co., Phila. (1964).
- Miller, R.L., "Nature of the Vocal Cord Wave", *J. Acoust. Soc. Am.* 31, 667-677 (1959).
- Minifie, F.D., C.A. Kelsey, and T.J. Hixon, "Measurement of Vocal-Fold Motion Using an Ultrasonic Doppler Velocity Monitor", *J. Acoust. Soc. Am.* 43, 1165-1169 (1968).
- Moore, P. and H. van Leden, "Dynamic Variations of the Vibratory Pattern in the Normal Larynx", *Folia Phoniatr.* 10, 205-238 (1958).
- Murry, T. and W.S. Brown, Jr., "Subglottal Air Pressure During Two Types of Vocal Activity: Vocal Fry and Modal Phonation", *Folia Phoniatr.* 23, 440-449 (1971).
- Negus, V.E., The Comparative Anatomy and Physiology of the Larynx, Heinemann Med. Books, London (1949).
- Nickerson, R.S. and K.H. Stevens, "Teaching Speech to the Deaf: Can a Computer Help?", *IEEE Trans. Audio Electroacoustics* AU-21, 445-455 (1973).



- Ohala, J., "How is Pitch Lowered?", *J. Acoust. Soc. Am.* 52, 124 (1972).
- Perkell, J., Physiology of Speech Production: Results and Implications of a Quantitative Cineradiographic Study, Research Monograph no. 53, M.I.T. Press, Cambridge (1969).
- Perkins, W.H. and Y. Koike, "Patterns of Subglottal Pressure Variations During Phonation", *Folia Phoniatr.* 21, 1-8 (1969).
- Pernkopf, E., Topographische Anatomie des Menschen, Vol. 3, Urban and Schwarzenberg, Wien-Innsbruck (1952).
- Pressman, J.J. and G. Kelemen, "Physiology of the Larynx", *Physiol. Rev.* 35, 506-554 (1955).
- Rothenberg, M., "A New Inverse-Filtering Technique for Deriving the Glottal Air-Flow Waveform During Voicing", *J. Acoust. Soc. Am.* 53, 1632-1645 (1973).
- Rubin, H., "Experimental Studies on Vocal Pitch and Intensity in Phonation", *Laryngoscope* 73, 973-1015 (1963).
- Sawashima, M. and H. Hirose, "New Laryngoscopic Technique by Use of Fiber Optics", *J. Acoust. Soc. Am.* 43, 168-169 (1968).
- Sawashima, M., "Laryngeal Research in Experimental Phonetics", (Chap. prepared for Current Trends in Linguistics Vol. XII, Sebeok, ed., Mouton, The Hague), Status Report on Speech Research 23, 69-116, Haskins Lab., New Haven (1970).
- Sawashima, M.; A. Abramson, F. Cooper, and L. Lisker, "Observing Laryngeal Adjustments During Running Speech by Use of a Fiberoptic System", *Phonetica* 22, 193-201 (1970).
- Sawashima, M. and T. Ushijima, "Use of the Fiberscope in Speech Research, Annual Bulletin no. 5, 25-34, Research Inst. of Logopedics and Phoniatrics, U. of Tokyo (1971).
- Shipp, T. and R.E. McGlone, "Laryngeal Dynamics Associated with Voice Frequency Change", *J. Speech Hearing Res.* 14, 761-768 (1971).
- Smith, S., "Remarks on the Physiology of the Vibrations of the Vocal Cords", *Folia Phoniatr.* 6, 166-178 (1954).

- Smith, S., "On Artificial Voice Production", Proc. of the 4th Int. Congress of Phonetic Sciences, Helsinki, Mouton (1962).
- Sondhi, M.M., "Measurement of the Glottal Pulses", J. Acoust. Soc. Am. 55, 396 (1974).
- Sonesson, B., "On the Anatomy and Vibratory Pattern of the Human Vocal Folds", Acta Oto-Laryngologica, Suppl. 156 (1960).
- Sonesson, B., "Functional Anatomy of the Speech Organs", Chap. in Malmberg, ed., Manual of Phonetics, North Holland Publishing Co., Amsterdam (1968).
- Sonninen, A., "The Role of the External Laryngeal Muscles in Length Adjustment of the Vocal Cords in Singing", Acta Otolaryng., Suppl. 130 (1956).
- Sonninen, A., "The External Frame Function in the Control of Pitch in the Human Voice", Annals N.Y. Acad. Sci. 155, 68-90 (1968).
- Sovak, M., J. Courtois, C. Haas, and S. Smith, "Observation on the Mechanism of Phonation Investigated by Ultraspeed Cinefluorography", Folia Phoniatr. 23, 277-287 (1971).
- Stevens, K.N., "An Analysis of Glottal Activity During Consonant Production", (in prep.)
- Tanabe, M. N. Isshiki, and K. Katajima, "Vibratory Pattern of the Vocal Cord in Unilateral Paralysis of the Cricothyroid Muscle", Acta Oto-Laryngologica 74, 339-345 (1972).
- Timke, R., H. von Leden, and P. Moore, "Laryngeal Vibrations: Measurement of the Glottic Wave. Part 1, The Normal Vibratory Cycle", A.M.A. Arch. Otolaryng. 68, 1-19 (1958).
- Titze, I.R., "The Human Vocal Cords: A Mathematical Model. Part I", *Phonetica* 28, 129-170 (1973).
- Titze, I.R., "The Human Vocal Cords: A Mathematical Model. Part II", *Phonetica* 29, 1-21 (1974).
- Ueda, H., M. Ohyama, J. Harvey, G. Magi, and J. Ogura, "Subglottic Pressure and Induced Live Voices of Dogs with Normal, Reinnervated, and Paralyzed Larynxes. I. On Voice Function of the Dog With a Normal Larynx", *Laryngoscope* 81, 1948-1959 (1971).

- van den Berg, Jw., "Direct and Indirect Determination of the Mean Subglottic Pressure", *Folia Phoniatr.* 8, 1-24 (1956).
- van den Berg, Jw., J. Zantema, and P. Doornenbal, "On the Air Resistance and the Bernoulli Effect of the Human Larynx", *J. Acoust. Soc. Am.* 29, 626-631 (1957).
- van den Berg, Jw., "Sub-Glottal Pressure and Vibrations of the Vocal Folds", *Folia Phoniatr.* 9, 65-71 (1957b).
- van den Berg, Jw., "Myoelastic-Aerodynamic Theory of Voice Production", *J. Speech Hearing Res.* 1, 227-244 (1958).
- van den Berg, Jw. and T.S. Tan, "Results of Experiments with Human Larynges", *Pract. Oto-Rhino-Laryng.* (Basel) 21, 425-450 (1959).
- van den Berg, Jw., "Vocal Ligaments versus Registers", *Curr. Probl. Phoniater. Logoped.* 1, 19-34 (1960).
- van den Berg, Jw., "An Electrical Analogue of the Trachea, Lungs, and Tissues", *Acta Physiologica et Pharmacologica Neerlandica* 9, 361-385 (1960b).
- van den Berg, Jw., Voice Production. Guide to Instructional Film, Univ. of Groningen (1960c).
- van den Berg, Jw., "Modern Research in Experimental Phoniatrics", *Folia Phoniatr.* 14, 81-149 (1962).
- van den Berg, Jw., "Sound Production in Isolated Human Larynges", *Ann. N.Y. Acad. Sci.* 155, 18-27 (1968).
- van den Berg, Jw., Private Communication (1973).
- Vanderslice, R., "Larynx vs. Lungs: Cricothyrometer Data Refuting Some Recent Claims Concerning Intonation and 'Archetypality'", *Working Papers in Phonetics* 7, 69-79, UCLA (1967).
- van Michel, Cl., "Functionnement Mécanique du Larynx" *Folia Phoniatr.* 23, 239-246 (1971).
- von Gierke, H., H. Oestreicher, E. Franke, H. Parrack, and W. von Wittern, "Physics of Vibrations in Living Tissues", *J. Appl. Physiol.* 4, 886-900 (1952).
- Wegel, R.L., "Theory of Vibration of the Larynx", *Bell Sys. Tech. J.* 9, 207-227 (1930).

Weibel, E.R., "Morphometrics of the Lung", Chap. in Fenn and Rahn, eds., Handbook of Physiology: Respiration, Vol. 1, Amer. Physiol. Soc., Washington, D.C. (1964).

Woods, R.H., "Law of Transverse Vibrations of Strings Applied to the Human Larynx", J. Anat. and Physiol. 27, 431-435 (1892).

BIOGRAPHICAL NOTE

Thomas Baer

Degrees: B.S., M.S. M.I.T., June, 1969

Thesis: Picture Coding Using the Medial Axis Transformation

Electr. Eng. M.I.T., Sept., 1970

Birthdate: May 17, 1945

Marital Status: Married

Children: 2, ages 8 yrs. and 4 yrs.

Societies: Professional: Acoustical Society of America, IEEE  
Honorary: Tau Beta Pi, Sixma Xi

Undergraduate History: 9/63 Entered M.I.T.

6/65 Entered Co-operative course in Electrical Engineering, Co-op work at Air Force Cambridge Research Laboratories, Bedford, Mass. Work, Mostly in computer picture processing, was the basis of Master's thesis.

Graduate History: 6/67-9/67 on co-op  
9/67-6/68 Teaching Assistant  
Courses: Sensory Communication  
Circuits, Signals, and Systems  
Electrical Components and Measurements (Lab)  
6/68-9/68 Research Assistant - Eaton  
Peabody Lab. of Auditory  
Physiology  
9/68-1/71 N.I.H. Trainee - Research at the  
Eaton Peabody Lab. (N. Kiang)  
2/69-1/71 Research Assistant in Otolaryn-  
gology at Mass. Eye and Ear  
Infirmary (no salary)  
2/71-6/74 N.I.H. Trainee - Research in  
Speech Communication Group  
(K.N. Stevens)  
6/74-9/74 Research Assistant - Speech  
Communication Group

## LIST OF PUBLICATIONS

### THESIS

Picture Coding Using the Medial Axis Transformation,  
S.M. Thesis, M.I.T., May, 1969

### PAPERS

Mott-Smith, J.C. and T. Baer, "Aera and Volume Coding of Pictures", Picture Bandwidth Compression, Huang and Tretiak, eds., Gordon and Breach, New York, 451-486 (1972).

(Presented at the Symposium on Picture Bandwidth Compression, Boston, April 2-4, 1969.)

Goldstein, J.L., T. Baer, and H.V.S. Kiang, "A Theoretical Treatment of Latency, Group Delay, and Tuning Characteristics of Auditory-Nerve Responses to Clicks and Tones", Physiology of the Auditory System, M. Sachs, ed., National Educational Consultants, Baltimore, 133-141 (1972).

(Presented at the Workshop on the Physiology of the Auditory System, Baltimore, June 26-27, 1971.)

Baer, T., "Measurement of Vibration Patterns of Excised Larynxes", Quarterly Progress Report No. 110, M.I.T. Research Laboratory of Electronics, 169-175 (1973).

### ABSTRACTS

Kiang, H.V.S., T. Baer, E.M. Marr, and D. Demont, "Discharge Rates of Single Auditory-Nerve Fibers as Functions of Tone Level", J. Acoust. Soc. Am., 41, 106 (1969).

Baer, T., "Measurement of Vibration Patterns of Excised Larynxes", J. Acoust. Soc. Am., 54, 318 (1973).

Baer, T., "Vibration Patterns of Excised Larynxes", J. Acoust. Soc. Am., 55, S79 (1974).

Baer, T., "Modelling Implications of Measurements on Excised Larynxes", submitted to Acoust. Soc. Am.