

**A Systematic Approach to
Tool Qualification
for Injection Molding**

by

Kristine Trowbridge Budill

B.S. Electrical Engineering, Yale College, 1989

Submitted to the Sloan School of Management and
the Department of Electrical Engineering and Computer Science
in Partial Fulfillment of the Requirements for the Degrees of

Master of Science in Management
and
Master of Science in Electrical Engineering

at the
Massachusetts Institute of Technology
June 1993

© 1993 Massachusetts Institute of Technology

All Rights Reserved

Signature of Author

Department of Electrical Engineering and Computer Science
Sloan School of Management
May 7, 1993

Certified By

Karl T. Ulrich, Associate Professor
Sloan School of Management
Thesis Advisor

Certified By

David E. Hardt, Professor
Mechanical Engineering
Thesis Advisor

Accepted By

Jeffrey A. Barks
Associate Dean, Master's and Bachelor's Programs
Sloan School of Management

A Systematic Approach to Tool Qualification for Injection Molding

by

Kristine Trowbridge Budill

**Submitted to the MIT Sloan School of Management and
the Department of Electrical Engineering and Computer Science
in Partial Fulfillment of the Requirements for the Degrees of
Master of Science in Management
and
Master of Science in Electrical Engineering**

Abstract

This thesis summarizes the progress made in developing a tool qualification procedure for injection molding. The results contained in the thesis were obtained through experimentation at United Technologies Automotive Taylor plant and United Technologies Research Center. Tool qualification refers to the pre-production process that the plant uses to 1) establish that a mold is capable of producing plastic parts which meet the customer specifications and 2) determine the machine settings to be used in production. Currently, an engineer tweaks the machine variables until he hits a combination that produces parts which meet the customer specifications.

Experimentation was used to demonstrate the feasibility of applying designed experiments to the tool qualification process. Three molds were qualified--a single cavity, four cavity, and eight cavity mold. Using a Box-Behnken designed experiment, a process model was constructed which mapped critical part dimensions to machine settings. Variation in dimensions was correlated with changes in injection speed, nozzle and barrel temperatures, mold coolant temperature, and hold pressure. Based on the process model developed, optimal processing conditions were established.

This structured approach to tool qualification produced benefits in terms of both efficiency and effectiveness. The proposed experimentation and analysis requires approximately one week to complete. This represents about an 85% decrease in tool qualification time. In addition, the systematic exploration of the process window eliminates unnecessary mold modifications and non-optimal machine variable settings which often result from "dialing in" settings. This work was critical in influencing the plants to adopt the proposed procedure.

Thesis Advisors:

**Karl Ulrich, Associate Professor of Management
David Hardt, Professor of Mechanical Engineering**

Acknowledgments

The research presented in this thesis was performed under the patronage of the Leaders for Manufacturing Program, a partnership between MIT and major U.S. manufacturing firms. I gratefully acknowledge the support and resources made available to me through the LFM Program during my studies at MIT.

I am indebted to the employees at United Technologies Research Center (Polymer Science Group) and United Technologies Automotive Division (Taylor and Peru plants) for their support, encouragement, and hospitality during my internship at United Technologies. The guidance of Joe Bak, Jim Irish, Tom Latham, and Blair Souder was invaluable. I would especially like to thank Blair for his expert tutelage and significant contributions to this thesis.

I would like to thank Doug Cooper and Suzanne Woll from the University of Connecticut for sharing their knowledge of injection molding and control theory.

Special gratitude goes to Dan Berkery, LFM Class of '93, who was my internship partner. He provided insights which contributed significantly to this thesis and was a great friend. The internship would not have been nearly as productive or enjoyable without his company. I am grateful for the efforts of my advisors, David Hardt and Karl Ulrich. Their direction and encouragement are greatly appreciated.

I thank my parents and my husband, Mac, for their continual loving support and for their patience during my two years at MIT.

Table of Contents

1.0 Introduction	13
1.1 Introduction.....	13
1.2 Injection Molding Process Description.....	13
1.3 Tool Qualification.....	15
1.4 Goals and Motivation.....	16
1.5 Summary of Research.....	22
1.6 Thesis Overview.....	24
2.0 Overview of Injection Molding	25
2.1 Introduction.....	25
2.2 Process Description	25
2.3 Raw Materials Description.....	27
2.3.1 Plastic Properties	27
2.4 Machine Description	32
2.4.1 Machine Settings vs. Molding Variables.....	34
2.4.2 Plastication.....	35
2.4.3 Injection	35
2.4.4 Switchover from Injection to Packing	39
2.4.5 Determination of Hold Time.....	40
2.4.6 Cooling.....	42
2.5 Mold Design	44
2.6 Material Variation	45
3.0 UTA Taylor Plant	49
3.1 Introduction.....	49
3.2 An Overview of UTA.....	49
3.3 An Overview of the Input Controls Division	52
3.4 An Overview of Taylor.....	54
4.0 Related Work	61
4.1 Introduction.....	61
4.2 Literature Search.....	61
4.2.1 Part and Mold Design	61
4.2.2 Mold Check Out.....	62
4.2.2.1 Four Key Process Variables	62
4.2.2.2 Design of Experiments	66
4.3 Industry Benchmarking	66
5.0 Methodologies for Qualification	71
5.1 Introduction.....	71
5.2 Current Tool Qualification Procedure.....	71
5.3 Improved Tool Qualification Procedure	73
5.3.1 Design of Experiment.....	77

5.3.1.1	Selection of Response Variables	77
5.3.1.2	Measurement of Response Variables.....	78
5.3.1.3	Selection of Process Parameters	78
5.3.1.4	Design Selection	84
6.0	Experiments	89
6.1	Introduction.....	89
6.2	Single Cavity Mold.....	89
6.2.1	Design Preparation and Execution	90
6.2.1.1	Selection of Response Variables	90
6.2.1.2	Selection of Process Parameters	92
6.2.2	Experimental Outcomes.....	94
6.3	Four Cavity Mold	102
6.3.1	Design Preparation and Execution	103
6.3.2	Experimental Outcomes.....	106
6.4	Material Specific Results.....	111
6.5	Eight Cavity Mold.....	113
6.5.1	Design Preparation and Execution	114
6.5.2	Experimental Outcomes.....	115
6.5.3	Mold Diagnosis.....	116
7.0	Conclusion	119
7.1	Summary of Results.....	119
7.2	Critical Success Factors for Methodology	120
7.3	Future Work.....	122
	Endnotes.....	125
	Appendix A	128
	Appendix B	136
	Appendix C	153
	Bibliography	159

List of Figures

Figure 1-1 Heater Blower Assembly.....	14
Figure 1-2 Injection Molding Machine	14
Figure 1-3 Mold Schematic	15
Figure 1-4 Tool #1 Dimensional Range	19
Figure 1-5 Tool #2 Dimensional Range	19
Figure 1-6 Tool #2 Samples using Optimal Settings	20
Figure 1-7 Influences on Part Quality.....	21
Figure 2-1 Injection Molding Process	26
Figure 2-2 Commercial Plastic Composition	27
Figure 2-3 Plastic Structure.....	28
Figure 2-4 Injection Molding Machine	33
Figure 2-5 The Injection Unit	33
Figure 2-6 Hydraulic Pressure Control	37
Figure 2-7 Injection Velocity Control.....	37
Figure 2-8 Effects of Hydraulic Pressure Control.....	38
Figure 2-9 Effects of Injection Velocity Control	38
Figure 2-10 Switchover from Injection to Pack.....	40
Figure 2-11 Determining Hold Time based on Cavity Pressure	41
Figure 2-12 Determining Hold Time by Part Weight	42
Figure 2-13 Mold Schematic	43
Figure 2-14 Cooling Line Hook-Up.....	44
Figure 2-15 Geometric Balance.....	45
Figure 2-16 Proportional Loader System	46
Figure 2-17 Effect of Variation in Material Re grind Levels.....	46
Figure 2-18 Influences on Part Quality.....	47
Figure 3-1 UTC Organization	50
Figure 3-2 UTA Organization	51
Figure 3-3 UTA 1991 Sales	52
Figure 3-4 Taylor Organizational Structure	57
Figure 3-5 Heater Blower Assembly.....	58
Figure 3-6 Power Relay Assembly	59
Figure 4-1 Qualitative Model of the Molding Process	63
Figure 4-2 Cooling Line Hook-Up.....	68
Figure 5-1 Current Tool Qualification Procedure.....	72
Figure 5-2 Proposed Tool Qualification Procedure	75
Figure 5-3A Hydraulic Pressure Control.....	80
Figure 5-3B Injection Velocity Control.....	80
Figure 5-4 Determining Hold Time	81
Figure 5-5 Qualitative Model of the Molding Process	82
Figure 6-1 Part Produced by Single Cavity Mold	90
Figure 6-2 Single Cavity Mold, Dimension #1	95
Figure 6-3 Single Cavity Mold, Dimension #2	95

Figure 6-4 Optimization Results for Single Cavity Mold	97
Figure 6-5 Single Cavity Mold, Dimension #1	99
Figure 6-6 Single Cavity Mold, Dimension #2	99
Figure 6-7 Relationship of Cp and Cpk	101
Figure 6-8 Part Produced by Four Cavity Mold.....	103
Figure 6-9 Four Cavity Mold, Dimension #1.....	107
Figure 6-10 Four Cavity Mold, Dimension #2.....	107
Figure 6-11 Four Cavity Mold, Dimension #1.....	109
Figure 6-12 Four Cavity Mold, Dimension #2.....	109
Figure 6-13 Four Cavity Mold, Cpk.....	111
Figure 6-14 Single Cavity Mold Dimension Interdependence	112
Figure 6-15 Four Cavity Mold, Dimension Interdependence	112
Figure 6-16 Part Produced by Eight Cavity Mold.....	114
Figure 6-17 Eight Cavity Mold, Dimension Means	116
Figure 6-18 Eight Cavity Mold, Steel vs. Part Dimensions.....	117
Figure 6-19 ISOBASE Cavity Layout.....	118

List of Tables

Table 2-1 Plastic Properties Related to Structure	28
Table 2-2 Plastic Properties which Influence Molding	32
Table 2-3 Influences on Part Shrinkage.....	35
Table 5-1 Influences on Part Quality	83
Table 5-2 DOE Control Factor Selection	83
Table 5-3 Summary of 3-Level Design Types.....	85
Table 5-4 Box-Behnken Design.....	86
Table 6-1 Response Variables for Single Cavity Mold.....	91
Table 6-2 Experimental Factors and Levels for Single Cavity Mold	92
Table 6-3 Experimental Design Matrix for Single Cavity Mold.....	93
Table 6-4 Values of Cp and Associated Defective PPM	100
Table 6-5 Experimental Factors and Levels for Four Cavity Mold.....	104
Table 6-6 Experimental Design Matrix for Four Cavity Mold	105
Table 6-7 Four Cavity Mold, Process Capability Ratios	110
Table 6-8 Experimental Factors and Levels for Eight Cavity Mold.....	115

Chapter One

Introduction

1.1 Introduction

This thesis summarizes the progress made in developing a tool qualification procedure for injection molding. The results contained in the thesis were obtained through experimentation at United Technologies Automotive (UTA) Taylor plant and United Technologies Research Center (UTRC) and demonstrate the feasibility of using design of experiments (DOE) in the tool qualification process. A complete tool qualification procedure, which provides the context for use of design of experiments, is also suggested.

1.2 Injection Molding Process Description

Many of the subassemblies UTA produces for the automobile manufacturers include injection molded plastic components. Figure 1-1 provides an example of the type of product produced by UTA. The housing shown in the picture is injection molded at the Taylor plant.

In injection molding, melted plastic material is injected into the cavities of a tightly closed mold (or tool) where the shape of the product is formed (Figure 1-2). The mold may consist of a single cavity or a number of similar or dissimilar cavities, each connected to flow channels or "runners" that direct the flow of the melted plastic to the individual cavities. The mold is kept closed for a specified cooling time during which the liquid plastic solidifies. Heat that has been transferred to the mold by the molten plastic is carried away by a coolant that circulates through passages in the mold--a

process that accelerates the cooling time (Figure 1-3). At the end of cooling time, the mold opens and the parts are ejected.

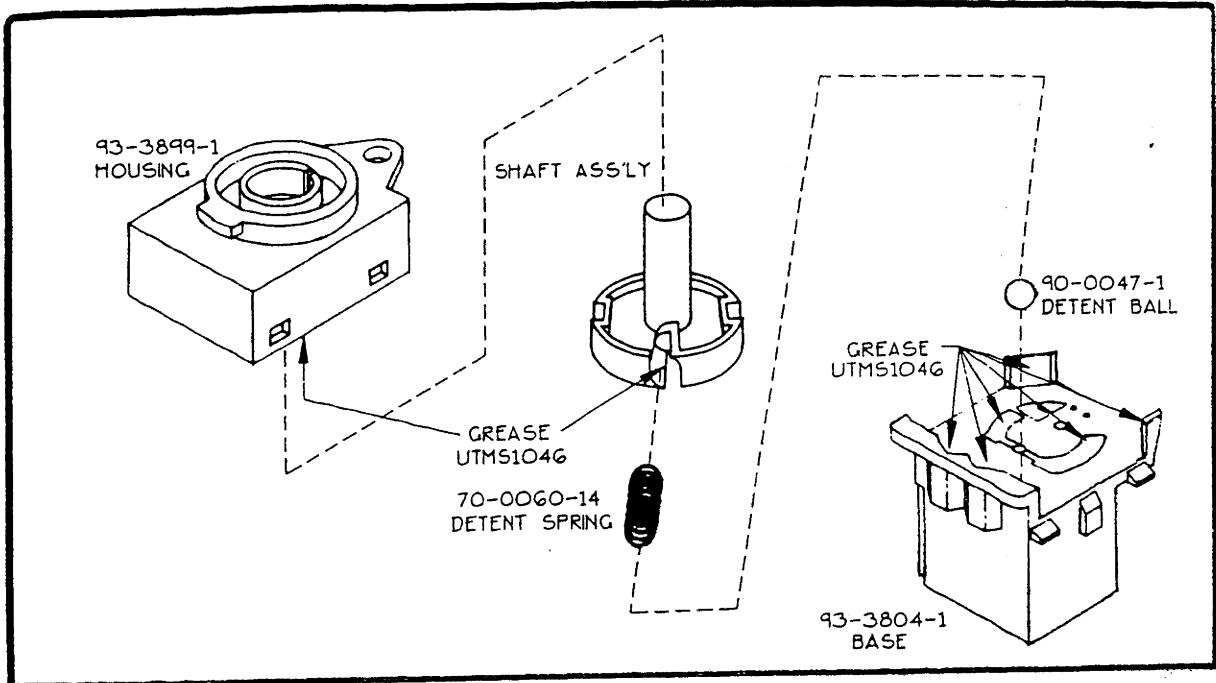

Figure 1-1: Heater Blower Assembly

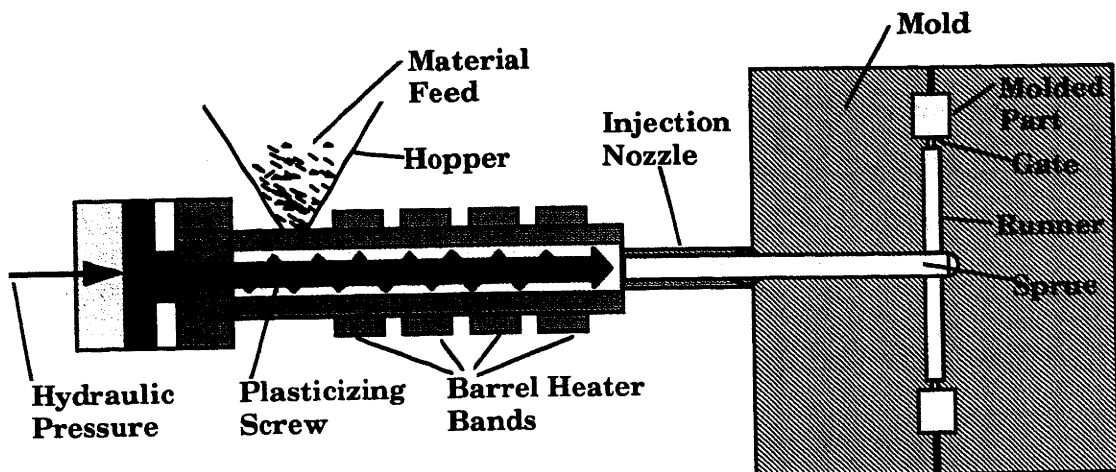

Figure 1-2: Injection Molding Machine

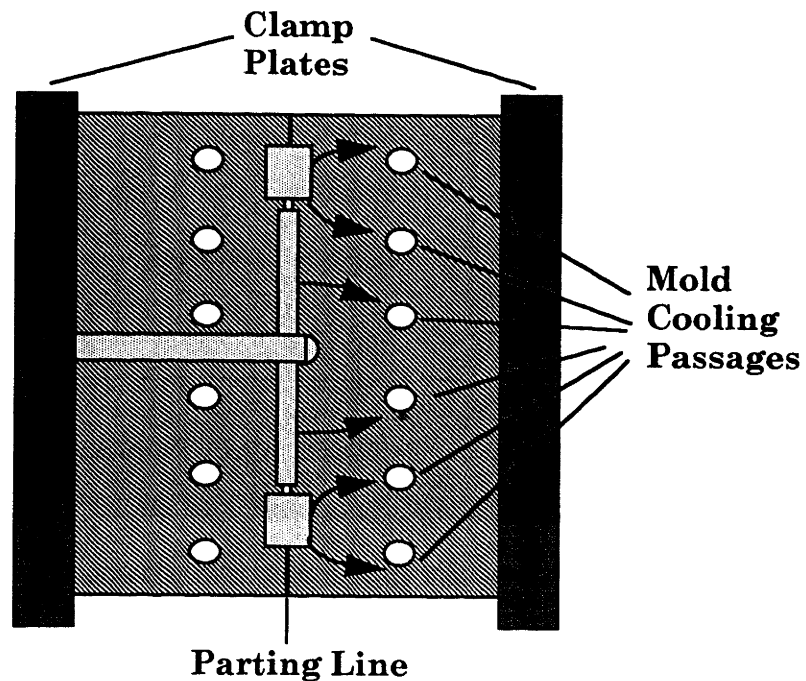

Figure 1-3: Mold Schematic

1.3 Tool Qualification

Tool qualification refers to the pre-production process that the plant uses to 1) establish that a mold is capable of producing plastic parts which meet the customer specifications and 2) determine the machine settings to be used in production. The current tool qualification procedure results in acceptable, not optimal, machine settings. It is also an extremely inefficient process. Complex part geometries and multi-cavity molds require numerous critical dimensions to be satisfied. A typical part has 25 critical dimensions and most of Taylor's molds are either four or eight cavity molds. Currently, an engineer tweaks the machine variables until he hits a combination that produces parts which meet the customer specifications. This process can take as many as six weeks.

1.4 Goals and Motivation

The overriding goal was to transform the current estimation process to a repeatable and systematic procedure. The technical goal of the project was to demonstrate to the UTA plant personnel that using design of experiments in the tool qualification process will

- significantly reduce tool qualification time,
- indicate if machine settings can be used to avoid costly tool modifications and
- identify the optimal processing conditions.

The managerial goal of the project was the timely and effective technology transfer of the DOE process from the research stage to practical application.

The motivation to develop the tool qualification procedure is linked to current industry trends and the role tool qualification plays in allowing plants to move from part inspection to process monitoring. Industry benchmarking efforts and discussions with UTA plant personnel uncovered three trends which drive revision of the current tool qualification procedure.

1) Four Month Product Development Cycles-- State of the art injection molding houses have set the goal of advancing from product design to production (i.e. "print to part") in four months or less. A four month product development cycle requires early involvement of tool designer/maker, molder and maintenance technicians in product design and sophisticated computer aided design tools. UTRC and the leadership at UTA are working together to establish the infrastructure needed to shorten the product development cycle time. UTA plants, however, can immediately begin accelerating the time to develop production capable processes by using an efficient procedure to qualify their tools. If customer specifications--i.e. critical dimensions--can be

brought into specification with changes to the injection molding machine settings, the cost and lead time required to make physical modifications to the tool can be avoided.

2) *Complex Part Designs* -- Designs for plastic parts are becoming increasingly complex. In addition, economic constraints have led to the use of multi-cavity molds. So, not only is the number of critical dimensions increasing as a result of complex part geometries, but it is also increasing by a factor equal to the number of cavities in the mold. Optimizing a process becomes more difficult when there are more critical dimensions to meet. The plants need a procedure to systematically determine which set of processing conditions will optimize all the critical dimensions.

3) *Tight Tolerance Demands* -- Tight tolerance molding permits variations of only ± 0.001 inch (or ± 0.025 mm) in critical part dimensions. It is, therefore, especially important for molders to establish that they have received a balanced tool. A balanced tool--i.e. each cavity in a multi-cavity mold has equal runner and gate dimensions and uniform cooling--reduces the risk of dimensional variation across cavities. As part of tool qualification, the plant should perform a capability study on critical part dimensions. The capability measurement must reflect variation across all cavities, not only variation within a single cavity. Once the tool enters production, success in meeting the tight tolerances will depend on delivery of consistent material to the machine and consistent cooling line hook-up, as well as control methodology used in the molding machine.

The demand for more capable processes stems not only from the advent of tight tolerance molding but also from customers' increasingly stringent quality requirements. Customers are demanding zero rejects. Given the high volume nature of injection molding, it is not feasible to inspect every part. Plants are therefore motivated to link process conditions to quality criteria through development of a process model that allows parts to be rejected or accepted at the molding machine rather than on the customer's assembly line.

Tool qualification provides the foundation upon which such a process model may be developed. Through tool qualification, the range of possible values for the quality characteristic--for instance, a dimension--are determined and the optimal processing conditions within this window are established.

The range in part quality is identified by systematically varying the machine settings and measuring the quality of the parts produced. The goal of this exploration is to determine the limits on using process to affect part quality. To produce values for part quality outside this range, modifications to the tool or the material must be made. Material modifications are rarely feasible because the plastic properties are linked to the part's application. Tool modifications are the typical area of attack. Possible changes target cavity, runner or gate dimensions and cooling passages.

Figures 1-4 and 1-5 show the possible outcomes from exploring the process window. The customer typically specifies a target dimension and an acceptable tolerance on that dimension. The limits on the dimension are referred to as the upper and lower specification limits (USL and LSL). Tool #1 (Figure 1-4) is not capable of producing the specified dimension and must

be modified. Tool #2, however, can produce the specified dimension if the correct combination of machine settings is chosen.

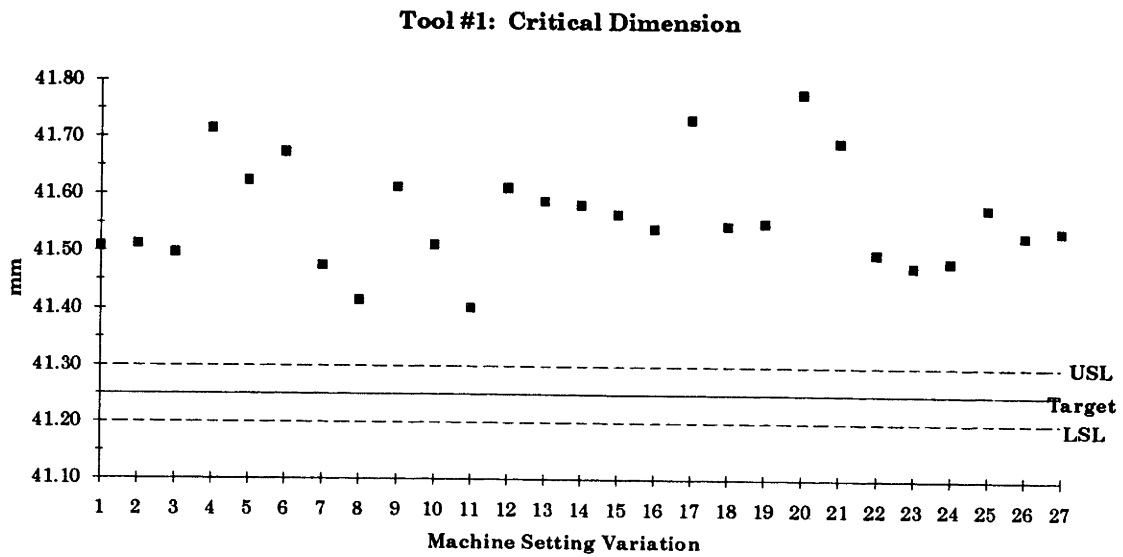

Figure 1-4: Tool #1 Dimensional Range

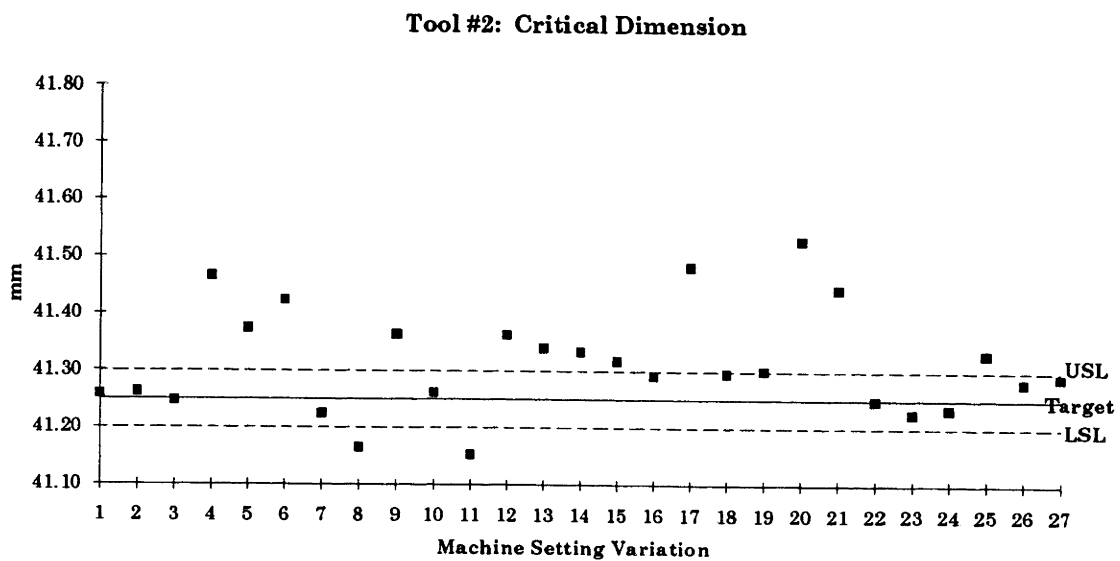

Figure 1-5: Tool #2 Dimensional Range

Once the tool is capable of producing the specified quality characteristics, the optimal machine settings are established. Using the machine settings as inputs and the quality measurements as outputs, a process model is developed from which the optimal processing conditions can be identified. When the tool is run using the optimal machine settings, a mean and standard deviation on the quality measurement will emerge (Figure 1-6) from which the mold's capability can be calculated.

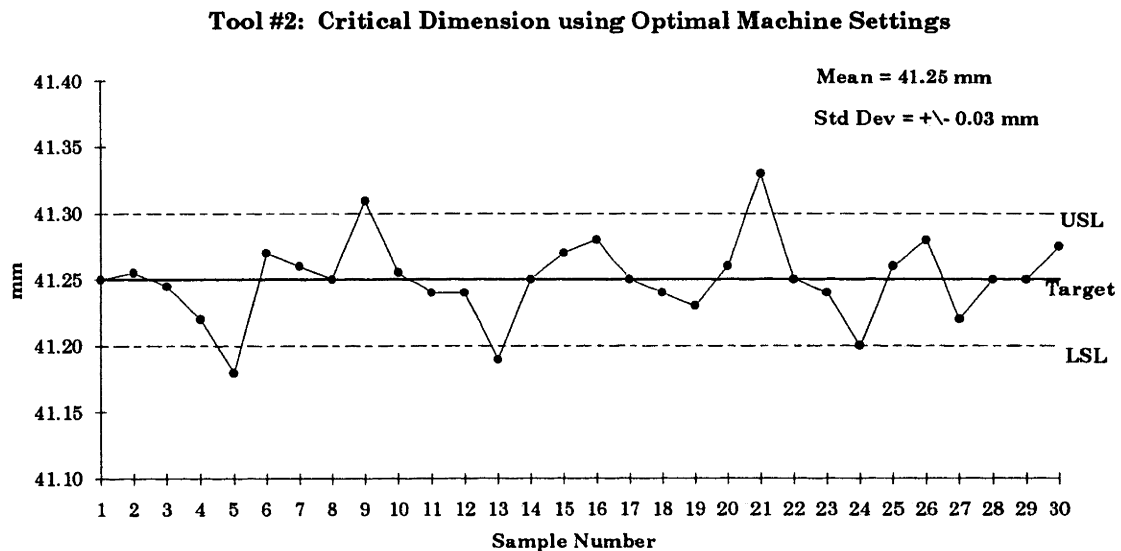

Figure 1-6: Tool #2 Samples using Optimal Settings

As described above, tool qualification first establishes if tool modifications must be made and then optimizes the process to produce the best mean for the customer specified quality characteristics. The model used to optimize the process correlates process conditions with part quality. Based on this process model, meaningful limits--limits that reflect quality loss in the part--on the process conditions can be established. Process monitoring allows deviation from these limits to be identified and, in combination with a

part diverter on a molding machine, allows bad parts to be rejected at the machine. Process monitoring is used to reduce the standard deviation associated with the quality characteristic mean by eliminating outliers from the parts shipped to the customer; it cannot, however, shift the mean.

Figure 1-7 highlights the effects of the tool and process monitoring on part quality.

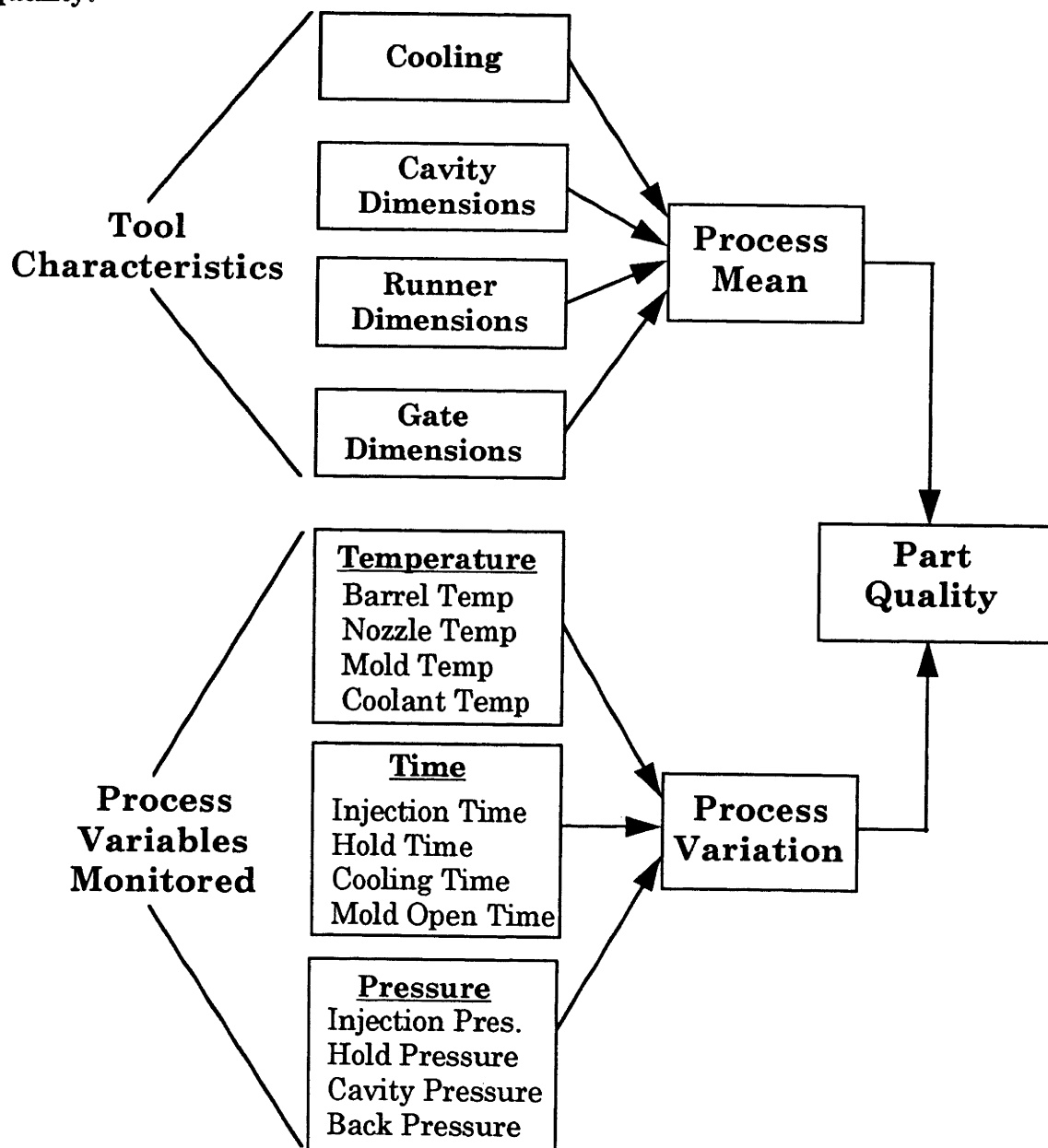

Figure 1-7: Influences on Part Quality

As developed above, tool qualification plays a critical role in the ability to implement process monitoring for two reasons. First, tool qualification establishes the range of possible values for the quality characteristics given the current tool design. Tool design might be described as the coarse adjustment knob for producing quality parts and process design--i.e. selecting the machine settings--as the fine adjustment knob. As shown in Figure 1-4, there is very little, if anything at all, that process design can do to correct for unbalanced or poorly cooled tools. If the tool is incapable of producing the specified part dimensions, no amount of process monitoring will improve the situation. Second, tool qualification determines the machine settings that optimize the quality of the plastic part. Consequently, deviation in processing conditions from the machine settings, which process monitoring will detect, should represent a decrease in quality of the part produced.

1.5 Summary of Research

Research to develop the tool qualification procedure described in this thesis included a literature search, surveys of industry practices and experimentation. The literature search served to validate the focus on tool qualification. The literature emphasizes the use of computer aided design tools (mold filling simulation) during part and mold design to improve the manufacturability of parts; thereby indicating the influence that tool design has on developing production capable processes.

In addition, the literature search results were used to design the experimentation. While modern injection molding machines give the molder control over dozens of machine parameters, literature on the qualitative theory of injection molding provided justification for reducing the critical

process parameters to just four variables. Literature on designed experiments permitted efficient exploration of how changing these machine settings impacts part quality.

Surveys of industry practices were used to speed the development of the tool qualification procedure by adapting techniques that had already been developed rather than reinventing them. In addition, these surveys provided a backdrop against which to judge the effectiveness of the procedure developed.

Finally, experimentation was used to demonstrate the feasibility of using designed experiments in the tool qualification process. Three molds were qualified--a single cavity, four cavity, and eight cavity mold. Using a Box-Behnken designed experiment, a process model was constructed which mapped critical part dimensions to machine settings. Variation in dimensions was correlated with changes in injection speed, nozzle and barrel temperatures, mold coolant temperature, and hold pressure. Based on the process model developed, optimal processing conditions were established.

This structured approach to tool qualification produced benefits in terms of both efficiency and effectiveness. The experimentation and analysis for each study required approximately one week to complete. This represents about an 85% decrease in tool qualification time. In addition, the systematic exploration of the process window eliminated unnecessary mold modifications and non-optimal machine variable settings which often result from "dialing in" settings. This work was critical in influencing the plants to adopt the proposed procedure.

1.6 Thesis Overview

Chapter 2 provides an overview of injection molding of thermoplastics for those who are unfamiliar with the technology. Molding vocabulary which is used throughout the thesis is defined.

Chapter 3 presents a description of United Technologies Automotive, its Input Controls Division, and the Taylor injection molding plant. The purpose of this discussion is to provide the context in which the tool qualification procedure will be implemented.

Chapter 4 reviews significant results of the literature search and industry surveys. This information helps establish the criteria for an improved tool qualification procedure.

Chapter 5 describes the improved tool qualification procedure. The current procedure is reviewed in order to demonstrate the need for an enhanced procedure.

Chapter 6 presents the results of three experiments which were conducted to show the feasibility of using design of experiments in the tool qualification process.

Chapter 7 presents conclusions of the work conducted and recommendations for future experimentation.

Chapter Two

Overview of Injection Molding

2.1 Introduction

This chapter provides a background in injection molding of thermoplastics for those who are unfamiliar with this process technology. The injection molding process is primarily a sequential operation that results in the transformation of plastic pellets into a molded part. The technology is being increasingly utilized in the manufacture of lower cost, lighter and safer consumer products. Typical applications range from the automotive to camera industries; with the size and quality of the final product having considerable variability. Factors which contribute to the increased use of injection molded plastics are:¹

1. Production of complex shapes in a single step
2. Ability to automate the process with tendent increases in production rates and manufacturing productivity
3. Replacement of metal components by plastic parts for lower cost consumer products

Critical to the adoption of this high volume, low cost process technology is the ability to consistently produce quality parts. In describing the injection molding process, factors which influence the repeatability of the molding process will be highlighted.

2.2 Process Description

The injection molding machine production cycle is characterized by four successive stages of *plastication*, *injection*, *packing*, and *cooling* (Figure 2-1). During plastication, the plastic material is pushed forward from the

feed hopper through the barrel and toward the nozzle by a rotating screw (also referred to as a reciprocating or plasticizing screw) and, at the same time, is heated by electric heater bands which surround the barrel. Plastication transforms the solid plastic pellets into a melt which is at an elevated and uniform temperature and uniform viscosity.

As pressure builds up at the mold entrance, the rotating screw moves backward to a predetermined distance, thus controlling the volume of material to be injected, and stops rotating. Upon injection, the melt is pushed through the nozzle and into the mold cavity by the application of hydraulic pressure to the screw.

After the mold cavity is filled, continued pressure on the piston connected to the screw forces more melt into the cavity to compensate for part shrinkage due to initial cooling. As the plastic material is trapped due to the mold gate freeze-off, the mold continues to cool the molten part until it solidifies in the cavity shape.

When the hold pressure is removed, plastication within the barrel occurs once more in preparation for the next cycle. After solidification and cooling is complete, the part is ejected from the mold and the process repeats.²

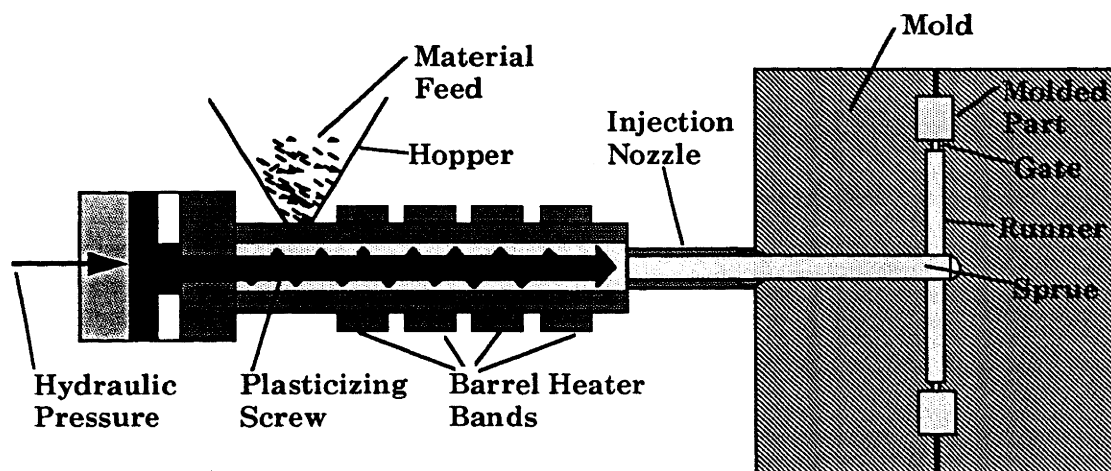

Figure 2-1: Injection Molding Process

2.3 Raw Materials Description

The molder works with commercial plastics which are composed of a base plastic plus additives (Figure 2-2). Base plastics are man-made materials known as polymers. Polymers are very long molecular chains composed of repeating smaller, simpler chemical units. Additives are used to enhance the properties of the base plastics. Individual additives fulfill many requirements, including: reduction in heat sensitivity during molding; stability during exposure to ultraviolet light; color; reduction of flammability; reduction in material cost. The complex composition of commercial plastics limits the processing range of the material. Exact processing specifications, unique for each plastic, are outlined by the material manufacturers.³

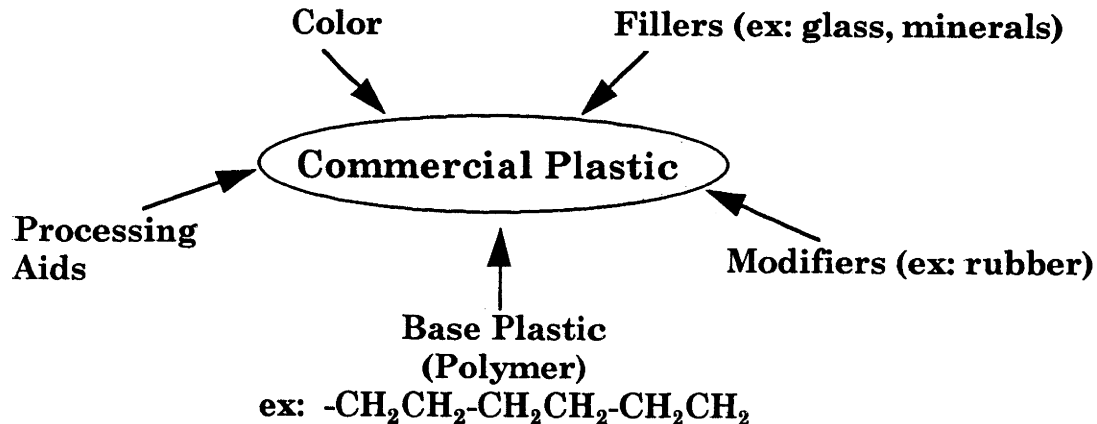

Figure 2-2: Commercial Plastic Composition

2.3.1 Plastic Properties

The polymer chains that comprise the plastic fold, intertwine with each other, and are held together by covalent and van der Waals bonding

forces. Thermoplastics are classified as either amorphous or crystalline depending on their molecular structure at room temperature (Figure 2-3).

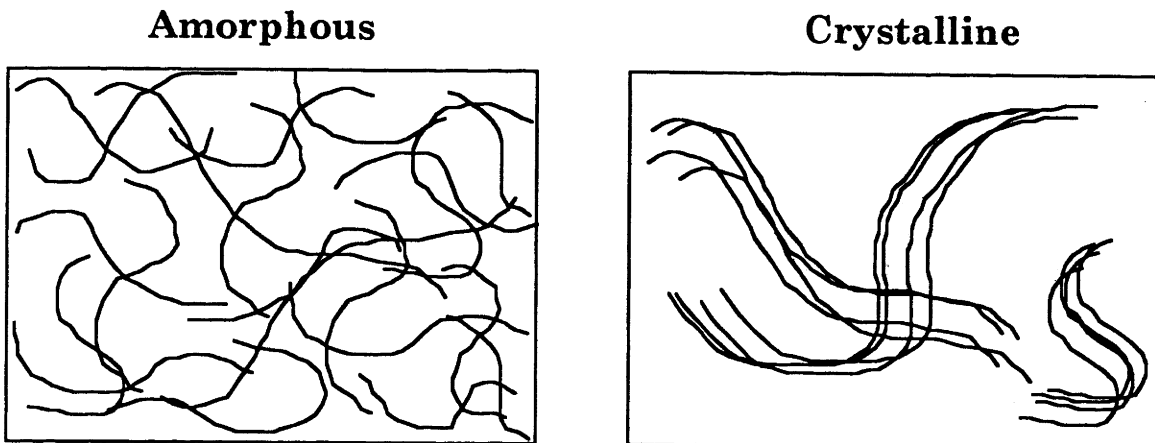

Figure 2-3: Plastic Structure

Amorphous plastics have a random structure. Crystalline plastics have an ordered structure, which takes up much less space than the amorphous state. Actually, no material is perfectly crystalline; amorphous sections will occur throughout a crystalline material. At melt temperature, all plastics are amorphous. The structure of the plastic is important because it affects the plastic's properties (Table 2-1).⁴

Properties	Amorphous	Crystalline
Example	Nylon (Minlon®)	Polycarbonate (Lexan®)
Structure	Random	Ordered
Melting point	Gradually softens	Distinct (i.e. ice to water)
Shrinkage	Less shrinkage	Higher shrinkage
Density	Lower density	Higher density
Stiffness	Lower	Higher
Tensile strength	Lower	Higher
Impact strength	Higher	Lower
Permeability	Higher	Lower
Warp	Lower	Higher

Table 2-1: Plastic Properties Related to Structure

Because the amount of crystallinity varies with the material and molding conditions, it is much more difficult to hold tolerances in crystalline materials than in amorphous ones. Plastics have several additional properties which influence the repeatability of the molding process (Table 2-2). First, plastics are compressible. The pressure in the mold cavity determines how much the melt is compressed. If all other variables are held constant, a higher hydraulic pressure results in a higher cavity pressure and will force more plastic into the mold cavities. Second, plastics shrink significantly when cooled. Together these properties indicate the need for the packing stage during the molding cycle. After the mold cavity is filled, continued pressure on the piston connected to the screw forces more melt into the cavity to compensate for part shrinkage due to initial cooling.

Shrinkage is also influenced by the cooling rate. A faster cooling rate--i.e. colder mold temperature--results in less shrinkage. When a part is cooled very quickly, the dimensions are "frozen-in" and, therefore, the part will shrink less. A slower cooling rate gives more time for the molecules to align and, consequently, the part will exhibit greater shrinkage. This discussion reveals the importance of controlling mold temperature to produce parts of consistent quality.

Finally, shrinkage is affected by polymer orientation--the alignment of the molecule and molecular segments in the direction of flow. Shrinkage is a result of two factors--a normal decrease in volume due to temperature change and relaxation of the stretching caused by carbon-carbon linkages. As there are more carbon-carbon linkages in the direction of the oriented flow, there will be greater shrinkage. Any parameter that affects the mobility of the molecular segments will affect orientation and consequently part shrinkage. This indicates the need for accurate temperature control for a repeatable

molding process.⁵ Orientation is also affected by melt flow rate. A fast fill rate increases orientation on the part surface and decreases orientation in the center of the part. A slow fill rate results in a less locally intense but more evenly distributed orientation through the whole cross section of the part.⁶

The third property of plastic is that its viscosity is dependent on temperature and flow rate of the melt. Viscosity is a measure of a material's resistance to flow and is defined as the ratio of shear stress to shear rate:

$$\eta \equiv \sigma / \dot{\gamma} \quad (2.1)$$

where: η = viscosity
 σ = shear stress
 $\dot{\gamma}$ = shear rate

The viscosity of the plastic melt decreases as the shear rate increases. Fluids that behave in this way are said to be shear thinning. Based on high-shear-rate data for a number of polymers, an empirical "power law" expression has been suggested to describe the dependence of viscosity on shear rate:

$$\eta = K\dot{\gamma}^{n-1} \quad (2.2)$$

The shear stress is then given by:

$$\sigma = K\dot{\gamma}^n \quad (2.3)$$

A Newtonian liquid is special case for which $n=1$. For molten polymers, n is usually observed to be in the range of 0.3 to 1.0.⁷

The viscosity of the melt also decreases with an increase in temperature. A simple expression often used to describe this effect is given by the equation:

$$\eta(T) = Ae^{E/RT} \quad (2.4)$$

where: T = temperature
 R = gas constant
 E = activation energy for viscosity

Mold filling software packages must model the dependence of viscosity on both shear rate and temperature. One example of such an expression is:

$$\eta = Ae^{E/RT} |\dot{\gamma}|^{n-1} \quad (2.5)$$

A qualitative explanation for why an increase in temperature lowers viscosity is related to the concept of free volume. This is the volume of space in the melt that is not actually occupied by molecules and is thus available to permit the mobility of the molecules. The greater the free volume, the easier it is for molecules to adjust to deformations, and this will be reflected in a lower viscosity. An increase in temperature results in thermal expansion and thus an increase in free volume. This explains the decrease in viscosity as the temperature increases.⁸

To summarize, increases in either flow rate or temperature reduce viscosity. An increase in flow rate results in greater shear thinning and consequently lower viscosity. Higher temperatures are an indication of greater molecular motion and consequently lower viscosity. Constant viscosity is required to produce parts of consistent quality. Viscosity can affect how much the polymer is compressed in the cavity and therefore how much shrink will take place. Lower viscosity results in smaller pressure drops along the flow path (runner and gate) and consequently higher cavity pressure. Higher cavity pressure results in greater compressibility and consequently less shrinkage.

Properties	Influences	Critical Process Variables
1. Plastics are compressible	<ul style="list-style-type: none"> • Higher hydraulic pressures force more plastic into the mold cavity • Reduced viscosity allows more efficient compression 	<ul style="list-style-type: none"> • Cavity Pressure
2. Plastics shrink when they cool	<ul style="list-style-type: none"> • Higher compression results in less shrinkage • Faster cooling rates result in less shrinkage • Less orientation results in less shrinkage 	<ul style="list-style-type: none"> • Cavity Pressure • Mold Temperature • Melt Temperature • Flow Rate
3. Plastic viscosity is dependent on temperature and flow rate	<ul style="list-style-type: none"> • Higher flow rates produce greater shear thinning and consequently lower viscosity • Higher temperatures are an indication of greater molecular motion and consequently lower viscosity 	<ul style="list-style-type: none"> • Flow Rate • Melt Temperature

Table 2-2: Plastic Properties which Influence Molding

2.4 Machine Description

An injection molding machine is composed of an injection unit, a clamping unit, a hydraulic unit and a control unit (Figure 2-4). The injection unit consists of the hopper, the barrel, the barrel heaters, the reciprocating screw and the nozzle (Figure 2-5). The clamping unit consists of the hydraulic clamping mechanism and the mold platens. The hydraulic unit consists of the hydraulic pump and all the associated plumbing and valving required to actuate the injection unit and the clamping unit.

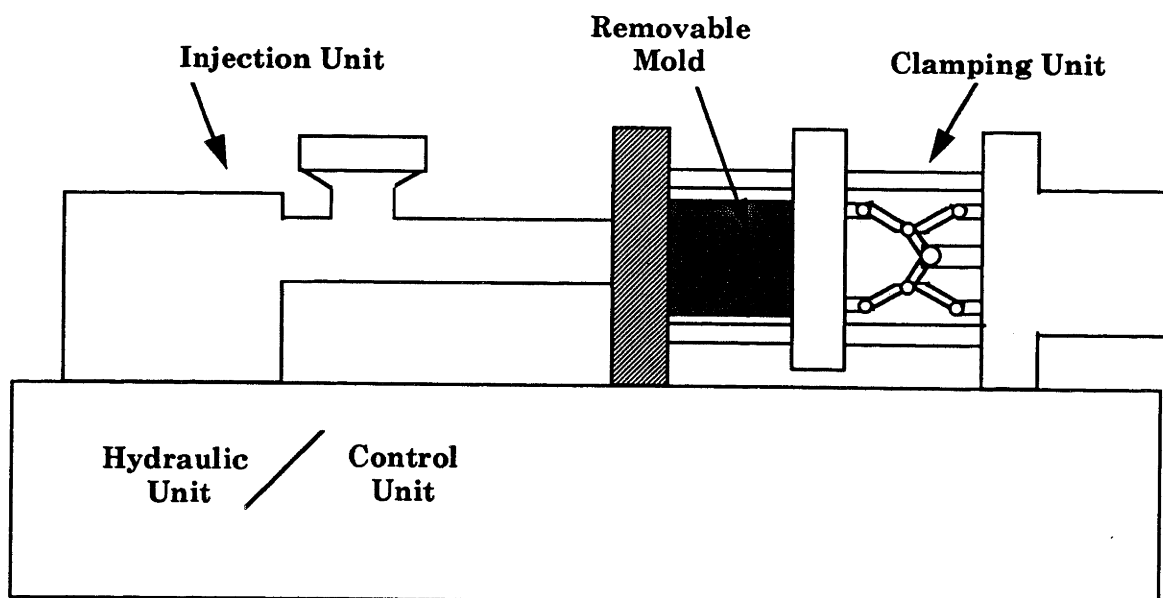

Figure 2-4: Injection Molding Machine

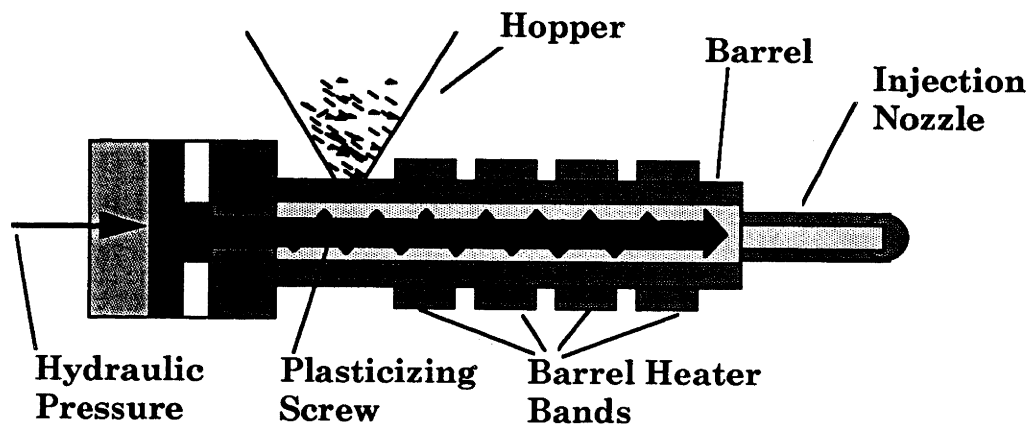

Figure 2-5: The Injection Unit

The purpose of the control unit is to establish the conditions for transferring from one stage to another, to impose process limits and to prevent damage to the equipment and personnel. Inputs are usually restricted to set point values unless the machine is in manual mode. Outputs from the control unit typically result in the opening or closing of hydraulic

valves or in the actuation of the screw. In actual implementation, the control unit may be driven simply by dial indicators and relays or by more sophisticated equipment involving microprocessors.⁹

2.4.1 Machine Settings vs. Molding Variables

The goal of injection molding is to produce parts of consistent quality. Part dimensions are frequently the measure of quality used. This leads to an argument for controlling shrinkage of the plastic part. The previous discussion on plastics indicated that shrinkage is dependent on the molding variables of cavity pressure, mold temperature, melt temperature, and flow rate. Consequently, these variables should be controlled.

The injection molding machine does not permit direct control over these variables but allows the operator to adjust machine settings that influence the molding variables. The inability to directly set and measure the molding variables that affect part shrinkage complicates the injection molding process. It is molding variables, properly defined and measured, not necessarily machine settings, that can be correlated with part properties. For example, if one increases barrel temperatures, melt temperatures do not necessarily also increase. Melt temperature is also influenced by screw design, rpm, back pressure and residence time. It is much more accurate to measure melt temperature and correlate it with properties than to correlate barrel settings with properties.

The following discussion reviews the four stages of the injection molding cycle (*plastication, injection, packing, cooling*) and indicates how machine settings are used to control the molding variables and consequently part shrinkage (Table 2-3).

Process Stage	Molding Variable	Machine Setting
1. Plastication	<ul style="list-style-type: none"> • Melt Temperature • Flow Rate 	<ul style="list-style-type: none"> • Barrel Temperatures • Screw Speed • Back Pressure
2. Injection	<ul style="list-style-type: none"> • Flow Rate 	<ul style="list-style-type: none"> • Injection Velocity
3. Packing	<ul style="list-style-type: none"> • Cavity Pressure 	<ul style="list-style-type: none"> • Hold Pressure
4. Cooling	<ul style="list-style-type: none"> • Mold Temperature 	<ul style="list-style-type: none"> • Coolant Temperature • Coolant Flow Rate • Cycle Time

Table 2-3: Influences on Part Shrinkage

2.4.2 Plastication

Plastication affects the repeatability of the molding process by influencing the viscosity of the melt. As previously discussed, viscosity is dependent on melt temperature and flow rate. During plastication, these molding variables are influenced by barrel temperatures and screw speed. Heat transferred from the barrel to the plastic results in the melting of the plastic pellets. The screw speed controls the shear force applied to the material. Shear force results in further heating--i.e. viscous dissipation--of the plastic. Back pressure also influences repeatability of the molding process because it determines the quantity of plastic in the barrel (compresses the plastic). Ranges for these temperature, speed and pressure settings are usually provided by the material suppliers, and should be repeated accurately set-up to set-up.

2.4.3 Injection

When the barrel is full and the mold halves are clamped and ready, hydraulic pressure is exerted on a piston connected to the screw. The pressure is intensified as a result of the difference in the area between the

piston surface and the cross section of the screw. The screw moves forward and plastic is discharged through the nozzle and into the mold.

Traditionally, injection was run under pressure control (Figure 2-6). In pressure control, the machine follows the pre-set injection pressure until switchover to packing. Injection rates that maintain the set hydraulic pressure will result. Today, injection controlled by velocity is preferred (Figure 2-7). In velocity control, the machine follows the set injection velocity. The hydraulic pressure limit is set high enough to allow the machine to maintain the set injection speeds without saturation.

The preference for velocity controlled injection relates to the goal of producing parts of consistent quality. Under hydraulic pressure control, variable injection rates result in response to fluctuations in material viscosity. Variable injection rates produce variations in pressure and flow characteristics in the mold cavities (Figure 2-8). (Section 2.3.1 described how flow rate affects viscosity, orientation, and the ability to compress the plastic.) Variation at the mold cavity usually translates to variation in finished part quality. Injection rate control does result in variable hydraulic pressures; however, cavity flow, pressure, and orientation are more consistent (Figure 2-9). Less variation at the cavity results in less variation in part quality. Therefore, velocity controlled injection is preferred.

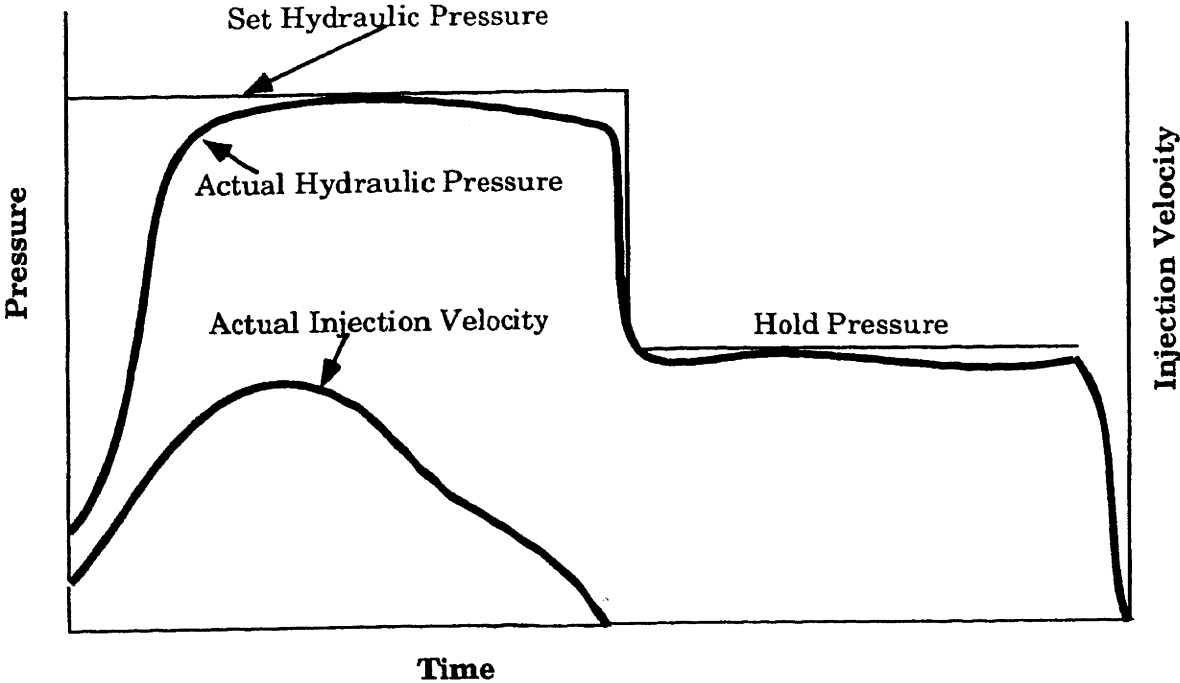

Figure 2-6: Hydraulic Pressure Control

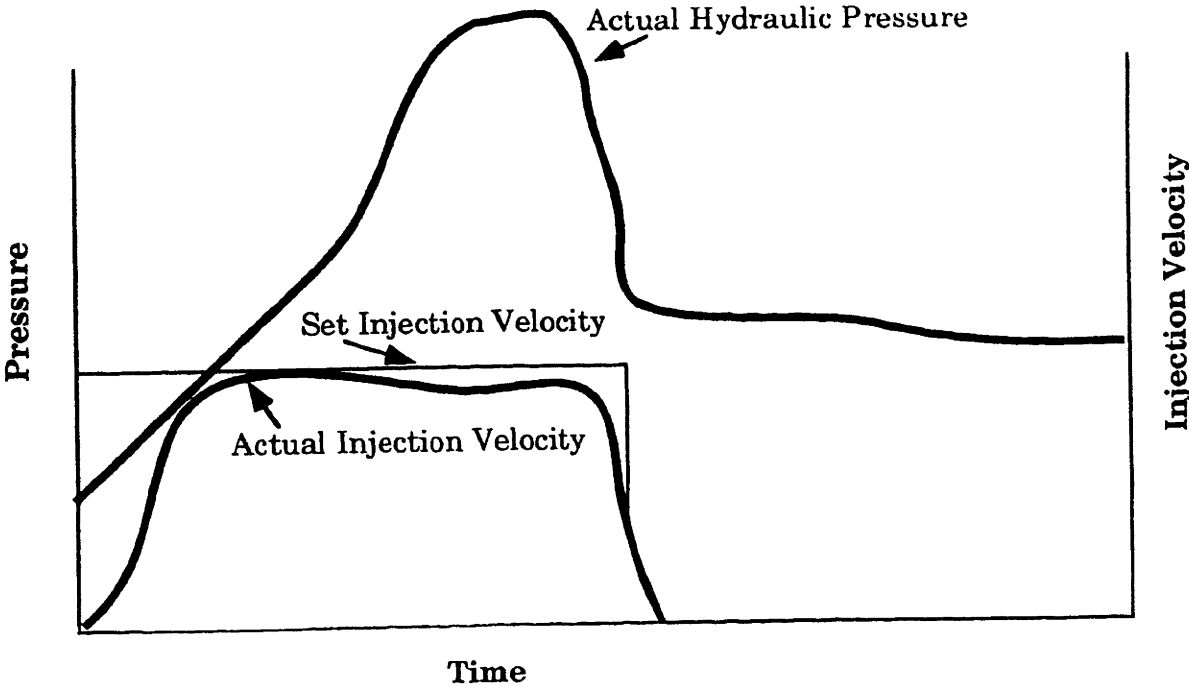

Figure 2-7: Injection Velocity Control

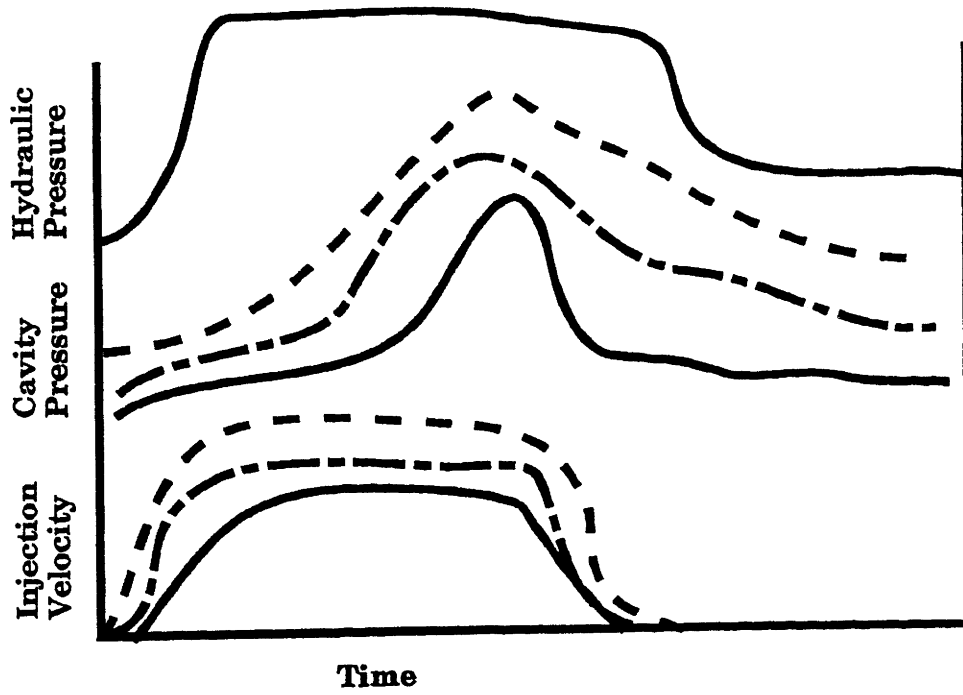

Figure 2-8: Effects of Hydraulic Pressure Control

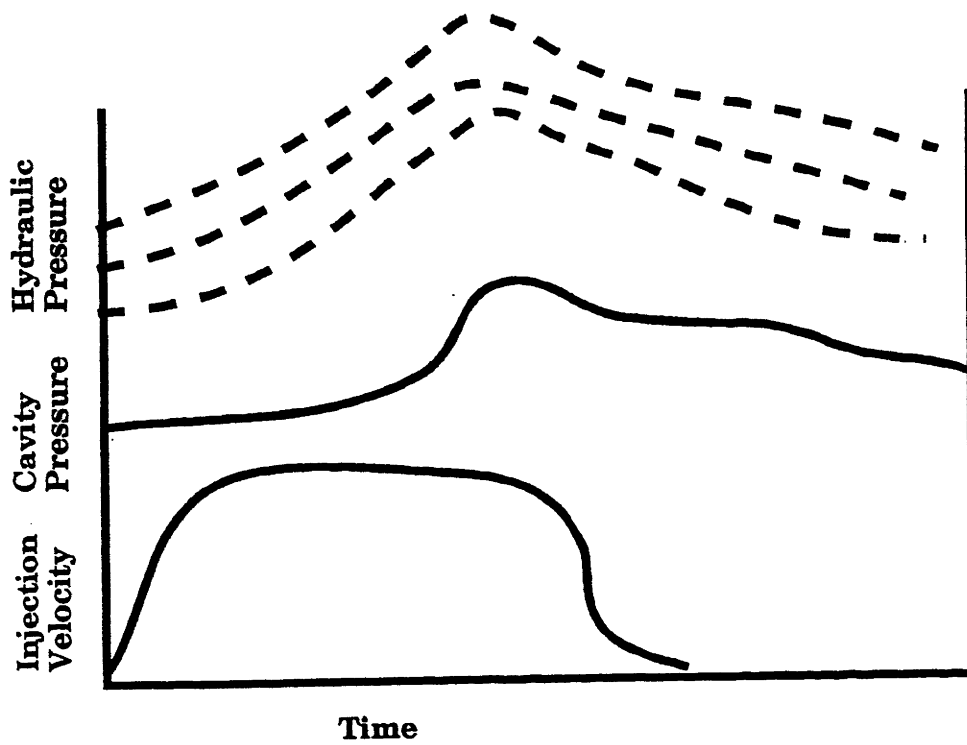

Figure 2-9: Effects of Injection Velocity Control

2.4.4 Switchover from Injection to Packing

Repeatability in the molding process is also dependent on consistent injection to pack switchover. Early switchover may result in short shots and insufficient packing. Late switchover can result in overpacking or flash. Switchover can be controlled by injection time, hydraulic pressure, injection position, or cavity pressure. Injection time is dependent on the operation of hydraulic valves and solenoid timing. The variability that occurs in these systems make injection time a poor candidate for switchover control. When injection is controlled by velocity, hydraulic pressure may vary slightly. Thus, switchover on hydraulic pressure is not recommended when the machine is operating in velocity control.

Switchover controlled by injection screw position corresponds to switching over when a certain volume of plastic has filled the cavity. Consistency in cavity fill helps ensure finished part consistency; therefore, injection position switchover is an acceptable choice. Cavity pressure gives an accurate assessment of conditions in the mold cavity, thereby providing the best indication of when to switchover. Cavity pressure switchover, however, requires additional instrumentation and, consequently, higher cost.

The experiments reviewed in this thesis used switchover controlled by injection screw position. In order to set the switchover position, use of cavity pressure sensors--located in the part close to the gate--or analysis of the hydraulic pressure is required. Switchover must occur before the part is completely full to avoid overpacking and/or flash. Therefore, when pressure begins to increase rapidly, switchover should occur.

Peak pressures in the cavity can be controlled by adjusting the point at which the molding machine switches over from injection to holding pressure. Figure 2-10 shows a late switchover (dotted line) compared to a good

switchover. If the pressure is peaking very high, the switchover position can be moved up--i.e. to a position it reaches earlier. If this is done, hold pressure may have to be raised slightly to allow completion of fill.

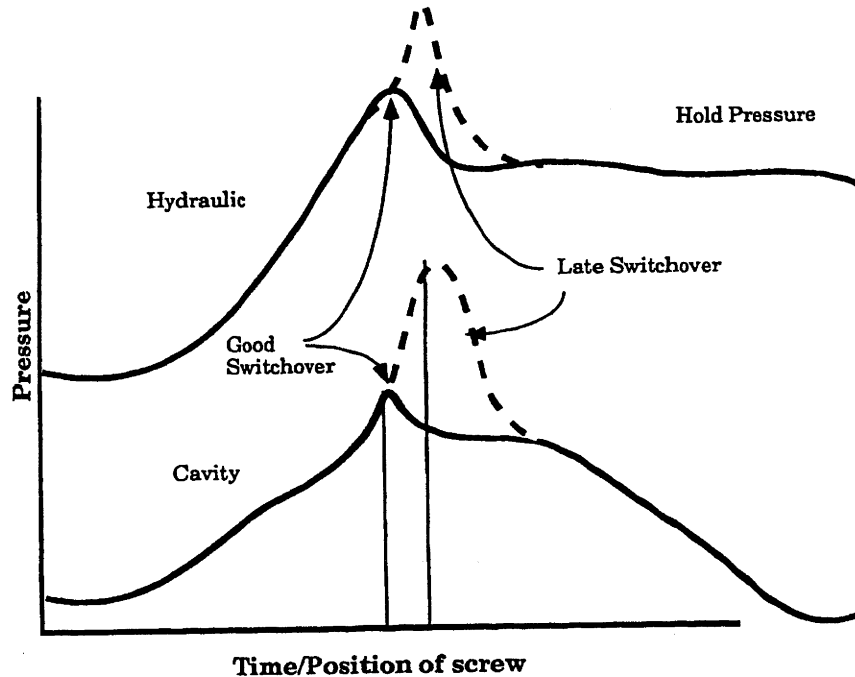

Figure 2-10: Switchover from Injection to Pack

2.4.5 Determination of Hold Time

After the mold cavity is filled, continued pressure on the piston connected to the screw forces more melt into the cavity to compensate for part shrinkage due to initial cooling. In order to achieve consistent part quality, hold pressure should be maintained until the gate freezes. Gate freeze-off time may be determined through use of cavity pressure sensors or part weight.

When using cavity pressure sensors, gate freeze-off time will be indicated by a sudden change in the slope of the cavity pressure trace during hold. This results because the cavity sensor no longer "sees" the pressure from the machine screw pushing. The cavity is now isolated from the hold

pressure so no more plastic can be forced into the cavity to compensate for part shrinkage. The contracting of the part as it cools results in a pressure drop.

If the hold pressure is released too early, a sudden reduction in cavity pressure will result, producing sinks, warp, or other dimensional problems. This results because plastic is now allowed to leave the part before solidification (Figure 2-11). Hold time which is too long, while not detrimental to the part, wastes energy.

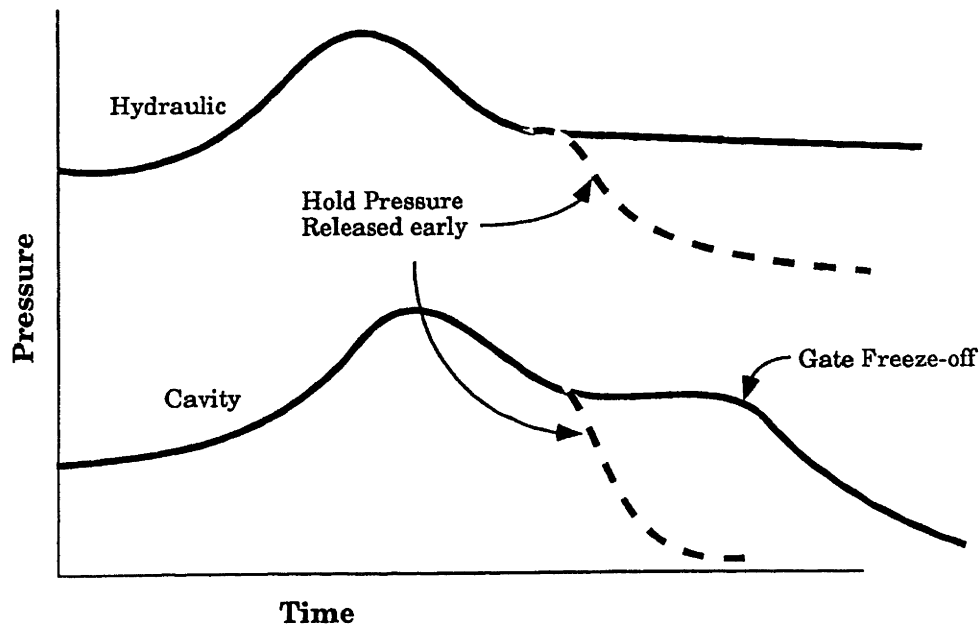

Figure 2-11: Determining Hold Time based on Cavity Pressure

If cavity sensors are not available, hold time may be progressively increased as each successive part is weighed. When increasing hold time no longer results in an increased part weight, the gate has frozen, and hold time may be set (Figure 2-12).

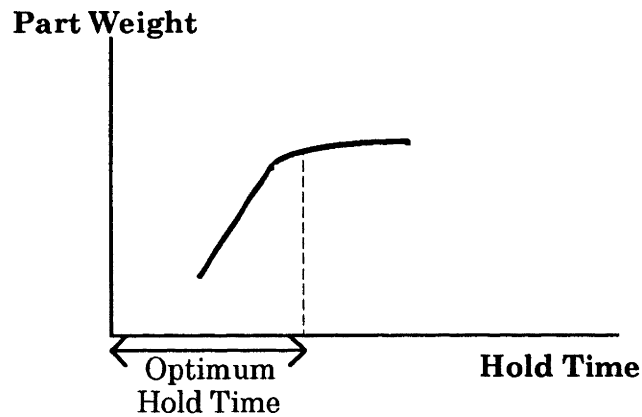

Figure 2-12: Determining Hold Time by Part Weight

2.4.6 Cooling

Cooling allows the plastic to solidify and become dimensionally stable before ejection. As discussed in section 2.3.1, cooling rate, which is determined by mold temperature, affects plastic orientation and shrinkage. Mold temperature, however, cannot be directly controlled. Heat that has been transferred to the mold by the molten plastic is carried away by a coolant that circulates through cored passages in the mold (Figure 2-13). Coolant temperature and flow rate determine the efficiency of heat removal.

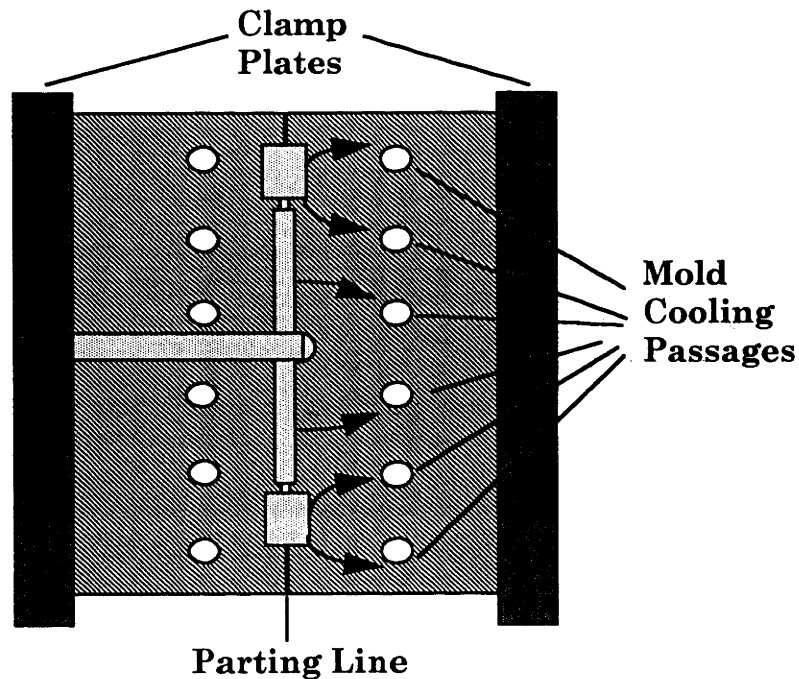

Figure 2-13: Mold Schematic

The design of the mold cooling passages also affects the ability to remove heat from the mold. The mold surfaces closest to the cored passages will cool first. Hook-up of the external hoses to the mold inlets and outlets will also influence cooling rate. Differences in mold temperature or mold temperature distribution will affect reproducibility of part moldings. Consequently, repeatability in molding requires optimizing cooling line hook-up and reproducing the same hook-up with every set-up. In general, the inlets and outlets for each cavity should be connected in parallel to their source of supply given that the pump can meet the required flow rates. Too many waterlines in series can cause high pressure drops and uneven mold surface temperature due to high temperature rise of the coolant (Figure 2-14). In addition, inside diameter of the hoses should be at least as large as, or preferably larger than, the coolant line diameter in the mold to avoid pressure drops and loss of cooling efficiency.¹⁰

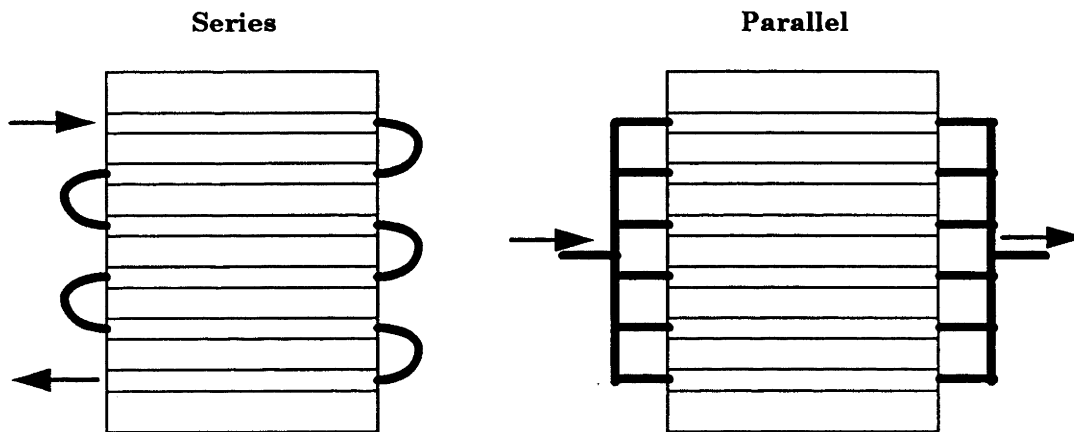

Figure 2-14: Cooling Line Hook-Up

2.5 Mold Design

As discussed in chapter one, mold design influences the ability to produce the desired part dimensions. The mold cavities are cut to dimensions larger than the desired part dimensions to compensate for the plastic shrinkage which occurs during cooling. The cavity dimensions are equal to the part dimensions plus some shrink factor which is supplied by the material manufacturer. There are usually two shrink factors given, one for dimensions in the direction of flow and one for dimensions across the direction of flow. Estimating shrinkage, however, is not straight forward. It is often difficult to predict the melt flow path in parts with complex geometries and therefore, not clear which shrink factor to apply. Also, as discussed earlier in the chapter, part shrinkage is influenced by the process conditions selected.

Mold design also affects the variation across cavities in a multi-cavity mold. First, the cavities must have very tight dimensional tolerances. Second, they must be geometrically balanced--each cavity has equal runner

and gate dimensions (Figure 2-15). Finally, mold cooling passages must provide uniform cooling to all the cavities.

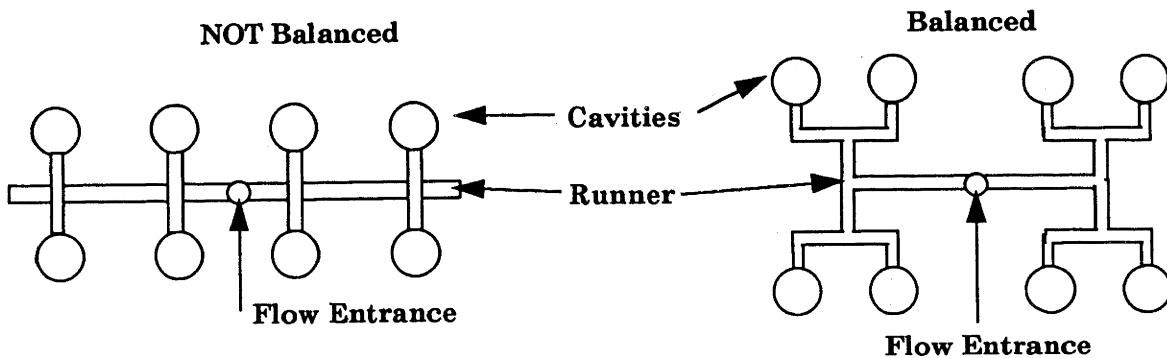

Figure 2-15: Geometric Balance

2.6 Material Variation

Material variation results in different melt viscosities and, therefore, different part quality. Sources of material variation include material lot number, dryness, and regrind level. Material suppliers produce plastic in "lots"--referring to batches of blended materials. Not all lots are the same; differences include molecular weights, molecular weight distributions, degrees of polymerization, and impurities. The molder can identify potential problems by sampling incoming material and comparing its characteristics with previous lots.

Material must be dry to allow proper processing. Some materials--i.e. Nylon--are especially sensitive to moisture. Dryness is controlled by residence time in the drying hopper, dryness of the air in the hopper--"dew point", and temperature of the air in the drying hopper.

Repeatable molding also requires consistent levels of regrind in the hopper. Sources of inconsistencies include regrind/virgin supply, proportional loader settings, and proportional loader function (Figure 2-16).

Loader settings should be adjusted to maintain consistent regrind levels, not require periodic adjustments. Figure 2-17 demonstrates the impact of varying regrind levels.¹¹ As previously mentioned, material variation results in different melt viscosities. The viscosity of the melt influences how the cavities fill and, consequently, the weight of the plastic part.

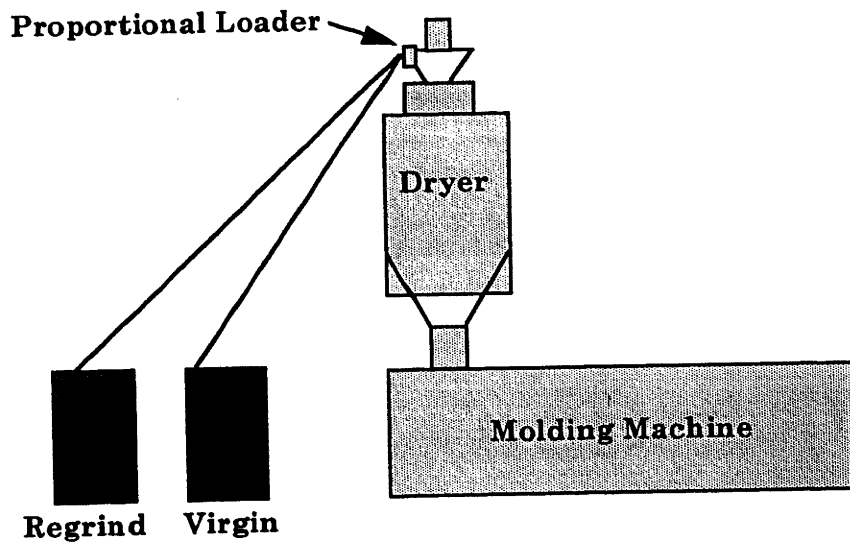

Figure 2-16: Proportional Loader System

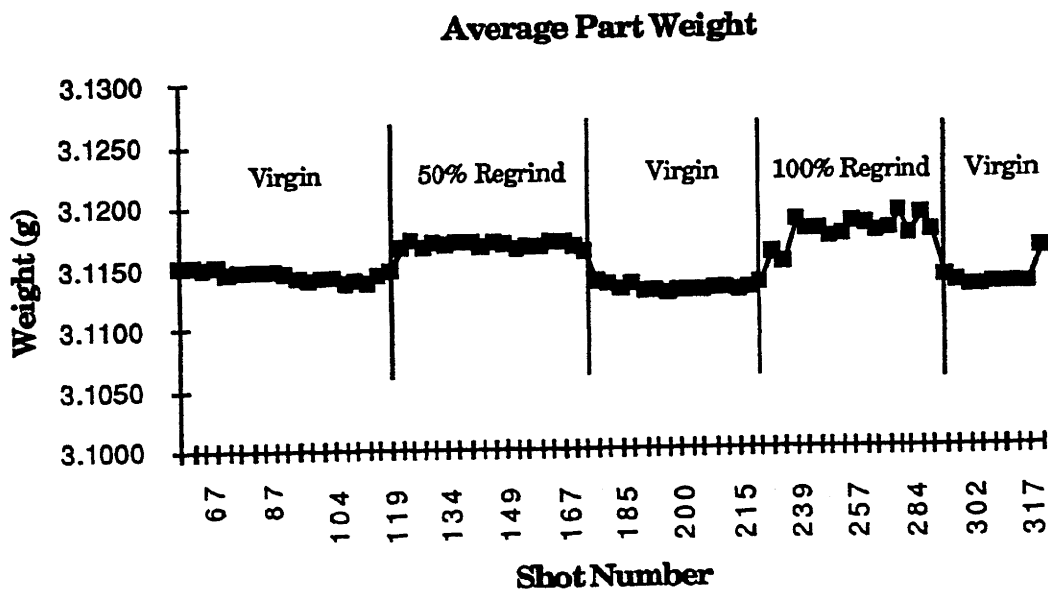

Figure 2-17: Effect of Variation in Material Regrind Levels

This chapter described the injection molding process with special emphasis on the issues which influence repeatable molding. Figure 2-18 summarizes the factors that determine part quality. The only area which the molder completely controls is machine settings. This is, therefore, the first area to target in eliminating variation from the process. Consistent machine settings must be used set-up after set-up. Process problems should be traced to their cause, not corrected for by tweaking machine settings.

Some sources of material variation--dryness and regrind level--are also under the molder's control and can be eliminated by following systematic procedures. Reducing lot to lot material variation will involve working with the material suppliers, and improving mold design will require collaboration with the tool designers and makers.

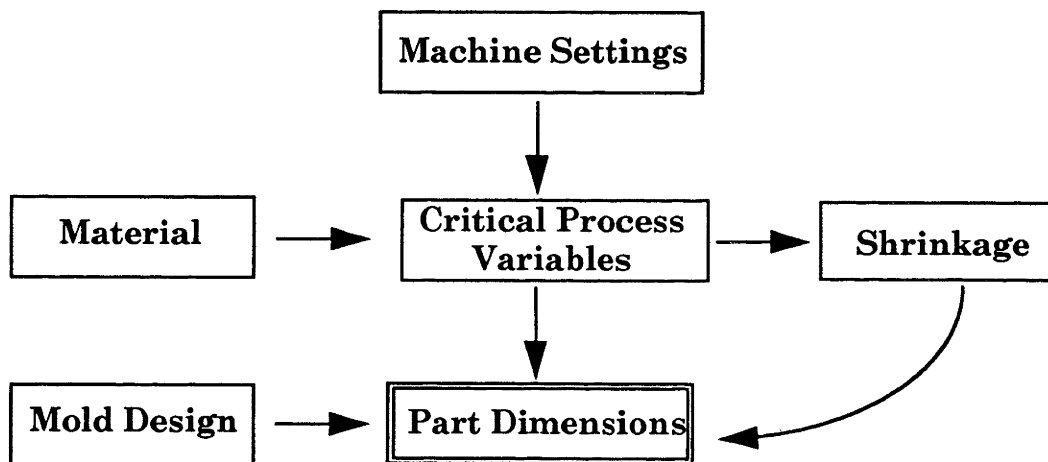

Figure 2-18: Influences on Part Quality

Chapter Three

UTA Taylor Plant

3.1 Introduction

Research that led to the development of the tool qualification procedure and process monitoring techniques was inspired by UTA's desire to accelerate the manufacturing approval process for new injection molded parts and increase the capability of production processes. Just as the Japanese automotive companies have attacked U.S. automotive companies' market share, so have the Japanese automotive suppliers attacked the U.S. automotive suppliers' market share. The ability to win business in the more competitive automotive market depends on a company's ability to compress product development cycle time and improve quality.

3.2 An Overview of UTA

In order to strengthen its position as an automotive supplier, UTA headquarters is attempting to identify industry best practices and implement them across the company. The ability to disseminate learning, however, is hindered by the autonomous nature of UTA's plants.

The autonomous nature of UTA is perhaps influenced by its parent corporation, United Technologies (UTC) (Figure 3-1). UTC provides a broad range of high-technology products and support services to customers in the aerospace, building and automotive industries worldwide. The corporation's best known products include Pratt & Whitney aircraft engines, Otis elevators and escalators, Carrier heating and air conditioning systems, Sikorsky helicopters, Hamilton Standard aerospace systems, Norden defense systems

and UT Automotive components and systems. United Technologies also supplies equipment and services for the U.S. space program.

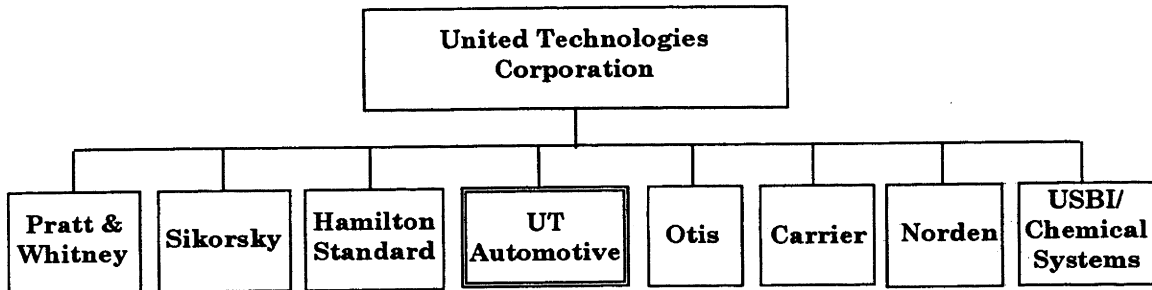

Figure 3-1: UTC Organization

In general, UTC is very decentralized and its unifying corporate culture is quite weak. Most of UTC's divisions were acquisitions. The culture of those organizations is tied strongly to the founder of the business, and the divisions continue to be recognized by the founder's name (e.g. Sikorsky Aircraft for founder Igor Sikorsky). In addition, there seems to be little movement of people between divisions, further insulating the cultures from one another.

United Technologies Automotive is, in some ways, a microcosm of the parent corporation. UTA's culture is weak. Most of UTA's injection molding plants were acquisitions and they have retained their original workforce and culture. Even when the plants are created by the division, the cultures that evolve are unique, strongly linked to the personality of the plant manager.

Development of a company culture is also hindered by UTA's decentralized structure. While both Sikorsky and UTA produce similar revenues, Sikorsky employs one third the people and concentrates production in southern Connecticut; UTA consists of over 100 manufacturing facilities in fourteen countries.

UTA's decentralized structure has also resulted in a wide range in sophistication of production control mechanisms employed across its plants. UTA leadership is currently focusing on how to elevate all the plants to an equally advanced level. One method is to devise systematic procedures, such as the tool qualification process, which can be applied across plants which use the same manufacturing technologies.

United Technologies Automotive produces 10% (\$2.1 billion in 1991) of UTC's revenues. 1991 revenues decreased \$537 million (20%).

Approximately one-half the decrease was due to significantly lower North American automobile production with the remainder primarily attributable to the divestiture of certain related businesses in 1990.¹² By increasing the company's ability to compete globally, UTA's leadership hopes to reduce the current dependence on North American car volume.

UTA includes 6 business units, organized by five product groups and one geographic region (Figures 3-2 and 3-3). Within the five product groups, over fifty major product lines are produced including: wire harnesses, electromechanical switches and controls, power window controls, wiper motors, door trim panels, instrument panels, and power brake hoses. UTA products are supplied to U.S., Japanese and European automotive companies.

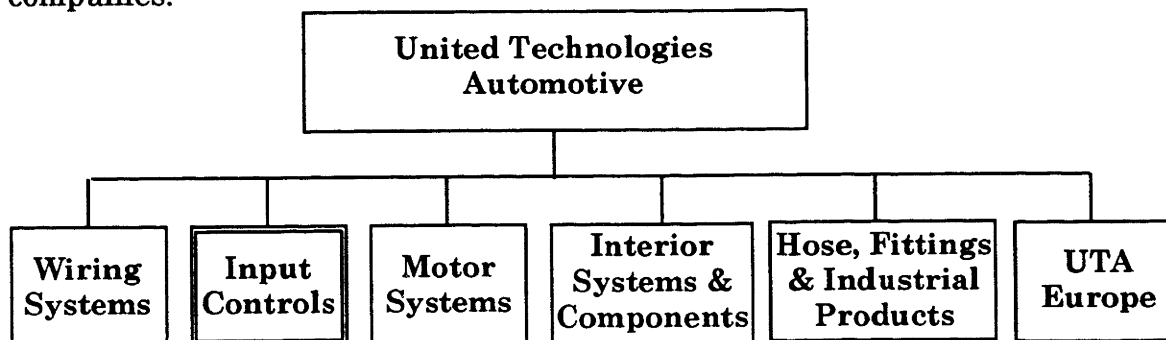

Figure 3-2: UTA Organization

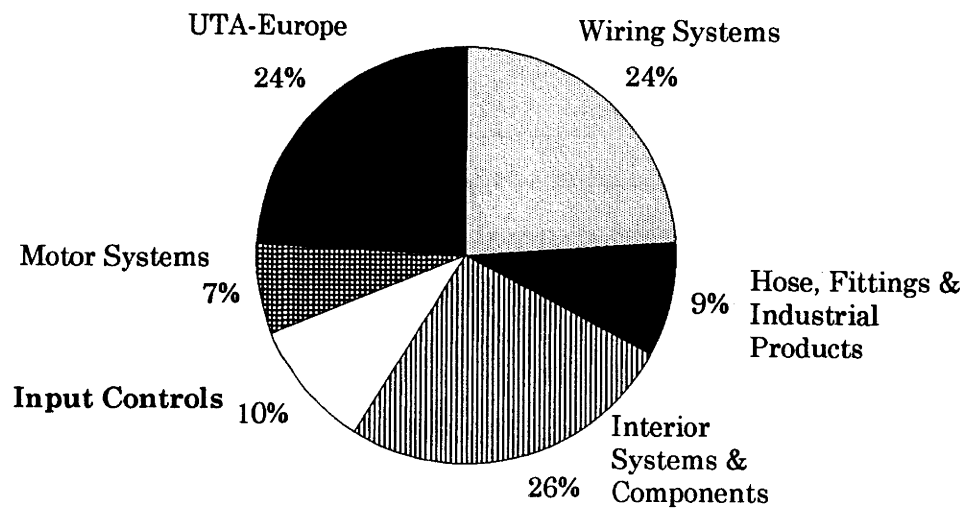

Figure 3-3: UTA 1991 Sales

3.3 An Overview of the Input Controls Division

UTA's Input Controls Division provides dozens of different subassemblies to the automobile manufacturers. Some of their product lines include: electromechanical switches and controls for turn signals, headlights, and windshield wipers; relays; electronic controls for power windows and door locks; and diagnostic modules. The research conducted in tool qualification and process monitoring is applicable to injection molding plants across UTA's business units. The Input Controls Division, however, is leading the company in adoption of new procedures. Several facts influence their receptiveness to new methods. First is the fact that the Input Controls' molding plant, Taylor, is a greenfield site. The opportunity to start over with the latest technology and human resource practices offers great opportunity as well as significant pressure to succeed. With less than two year's history, resistance to change is relatively low, and the employees are eager to demonstrate improved performance. Second, one of the business unit's

manufacturing engineers had the opportunity to spend six months at one of UTA's Japanese competitors. Since his return, he has been able to vividly convey that change is required in order to meet the Japanese standards. Third, Input Controls' business strategy includes aggressive pursuit of tight tolerance and insert molding business, both of which depend on extremely capable processes.

In order to compete effectively in the more competitive market, Input Controls must also transform their sequential product development process. The current product development cycle begins when the automobile manufacturer supplies the design envelope (or design specifications) for the subassembly. Input Controls engineers then design the subassembly and the tools required to produce to it. The construction of the molds used to produce the plastic parts is subcontracted to a tool builder; UTA does not own any tool makers. The finished mold is delivered to the injection molding plant. Molded plastic parts are shipped to assembly plants and completed subassemblies are delivered to the automotive producers.

Traditionally, there has been very little opportunity for the molding plant to transfer its experiential knowledge about part and mold design back to the design engineers. UTA's recognition that the ability to establish production capable processes is dependent on the quality of part and mold design led to the selection of Taylor as the site for the new molding plant. Located fifteen minutes from the design facility, Taylor offers the opportunity for molder and designer to work together daily.

One huge disconnect in the product development cycle has been produced by the use of an outside tool maker. The problem results from a difference in what the tool maker wants to sell and what the molder wants to buy. The tool maker sells steel cut to certain dimensions, while the molder

would like to buy the ability to produce a plastic part which meets the customer specifications.

Mold construction for plastic parts is extremely complicated. Differential shrinkage as the plastic part cools requires the mold maker to cut the tool steel larger than the print dimensions. Shrinkage estimates are based on material supplier recommendations and the tool maker's experience. Very few tool builders conduct a systematic try out of the mold before it is delivered to the molder. If the molding plant then identifies the need for tool modifications, it costs the molder's nickel. If Input Controls is unable to find an independent mold maker who is willing to work with them to produce parts, they may consider purchasing a tool shop.

3.4 An Overview of Taylor

The Taylor plant was inspired by a vision of what a world class molding facility might be. Extensive research effort was dedicated to the technology selection, facility layout, and development of human resource policies. The plant site was selected in early 1991 with actual production beginning in June of that year.

Taylor uses traditional injection molding and insert molding technologies. The plant manufacturing equipment includes 24 injection molding machines ranging in size from 55 to 200 tons and 4 insert injection molding machines ranging in size from 30 to 150 tons. Four more insert molding machines will be added in mid 1993 and an additional 4 insert machines in 1994.

The 24 injection molding machines were all purchased from the same vendor. This is important for several reasons. First, the injection molding process is sensitive to changes in any input variable, including machine

settings, material, or machine calibration. By buying all the machines from the same vendor, there is a better chance that the machine calibration variable will be eliminated. Being able to run molds on different machines using the same machine settings is almost a requirement given the large number of part numbers Taylor produces. Taylor has close to 100 different part numbers. Given this variety, it would be almost impossible to dedicate machines to molds. Second, by standardizing the equipment in the plant, training effort is minimized.

The layout of the facility was also given special consideration. The machines are organized into three identical cells of eight machines. While this involves higher initial training costs because each employee must learn to run the variety of machine sizes that comprise the cell, in the long run it allows individuals to be moved to a different cell with no extra training investment. An electronic mold storage unit and overhead electronic cranes facilitate mold changes which can be both time-consuming and dangerous when more manual labor is required.

Job descriptions are purposely vague in order to keep all employees aligned toward the ultimate goal of producing quality parts. In general, however, process engineers are responsible for technology development at the plant and for interfacing with the customer. The process engineers are organized by customer rather than by product line in order to provide better service.

The plant superintendent is responsible for scheduling and overseeing production. Production runs three shifts, with the workers on each shift referred to as Team One, Two and Three. Process technicians on each shift set-up the machines and lead problem solving efforts on the plant floor. Utility technicians are each assigned three machines. They watch for any

process disturbances, ensure that the machine has sufficient material, and empty full part bins. Minor mold repairs are attended to by the first shift mold technician.

In order to facilitate the development of a team environment, all employees are referred to as associates and everyone is salaried. Hiring has been extremely selective, even when it required current employees to assume additional responsibilities in the interim. Production began in June 1991 with 3 employees; the plant manager and two manufacturing engineers. One year later there were close to twenty employees. Today, the number of associates is approaching fifty and all the key positions in the plant have been filled (Figure 3-4). As a result of just recently filling all these positions and the focus on training in the technical areas, the formal training in team skills has not yet happened. The task for 1993 is to build team skills without losing the focus on improving quality, launching a significant number of new programs, and increasing volume to budgeted levels.

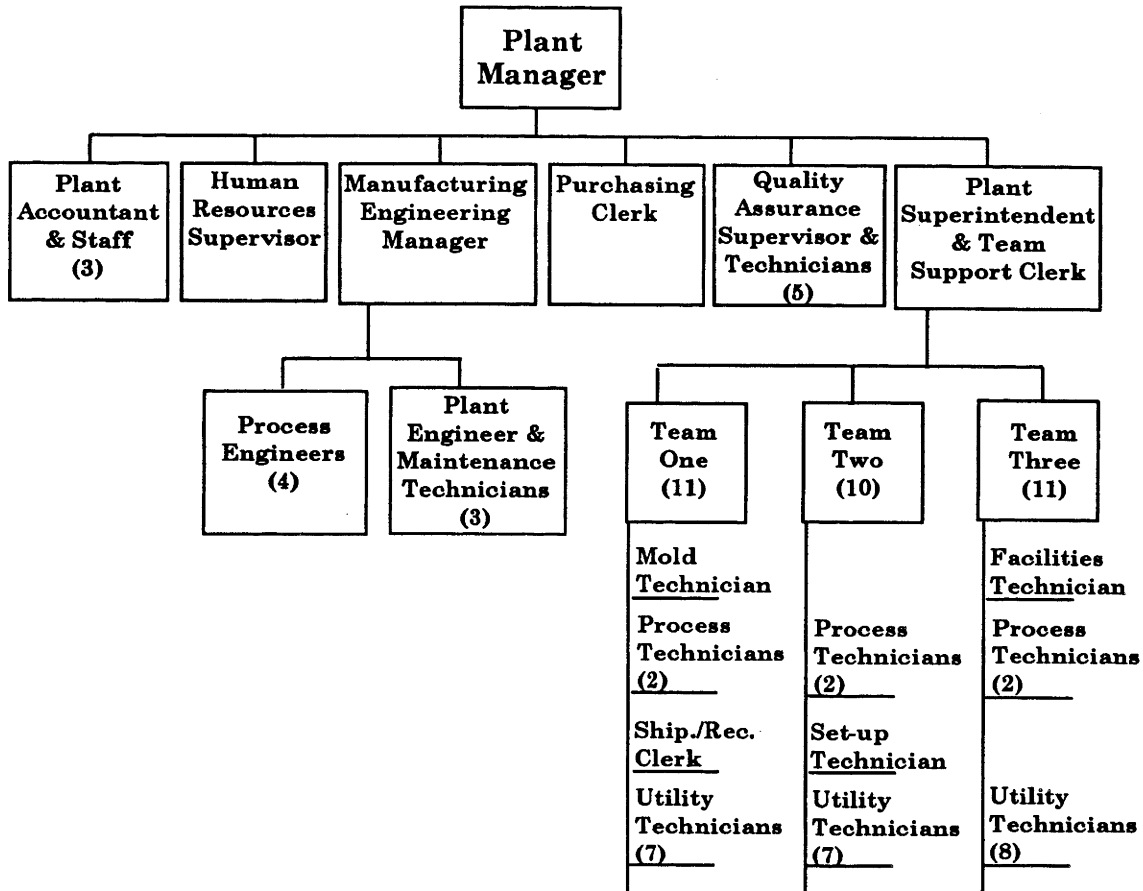

Figure 3-4: Taylor Organizational Structure

Until recently, Taylor has been a captive supplier to the Input Controls assembly plants. This was advantageous during start-up of the plant because it guaranteed Taylor business, while it was trying to improve its operating efficiency. Soon Taylor will begin supplying Chrysler directly. Figures 3-5 and 3-6 show examples of the parts supplied by Input Controls.

As mentioned earlier, Input Controls business strategy involves becoming a significant player in the tight tolerance molding market. The challenges associated with tight tolerance molding are increased by complex part geometries and use of multi-cavity molds (most of Taylor's molds are four or eight cavity molds). The tool qualification procedure and process

monitoring techniques developed during the LFM internship address Taylor's need for increasingly capable processes.

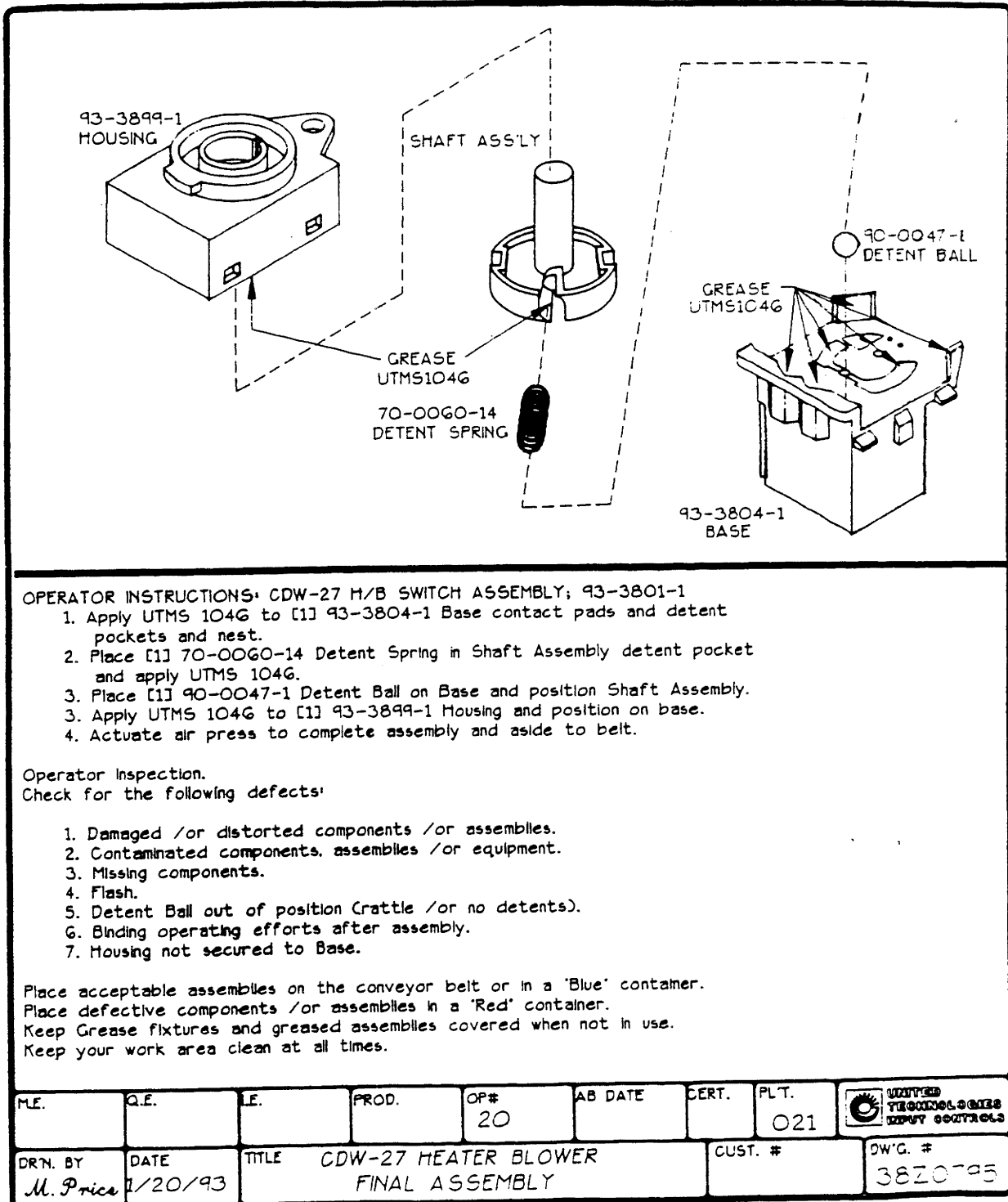
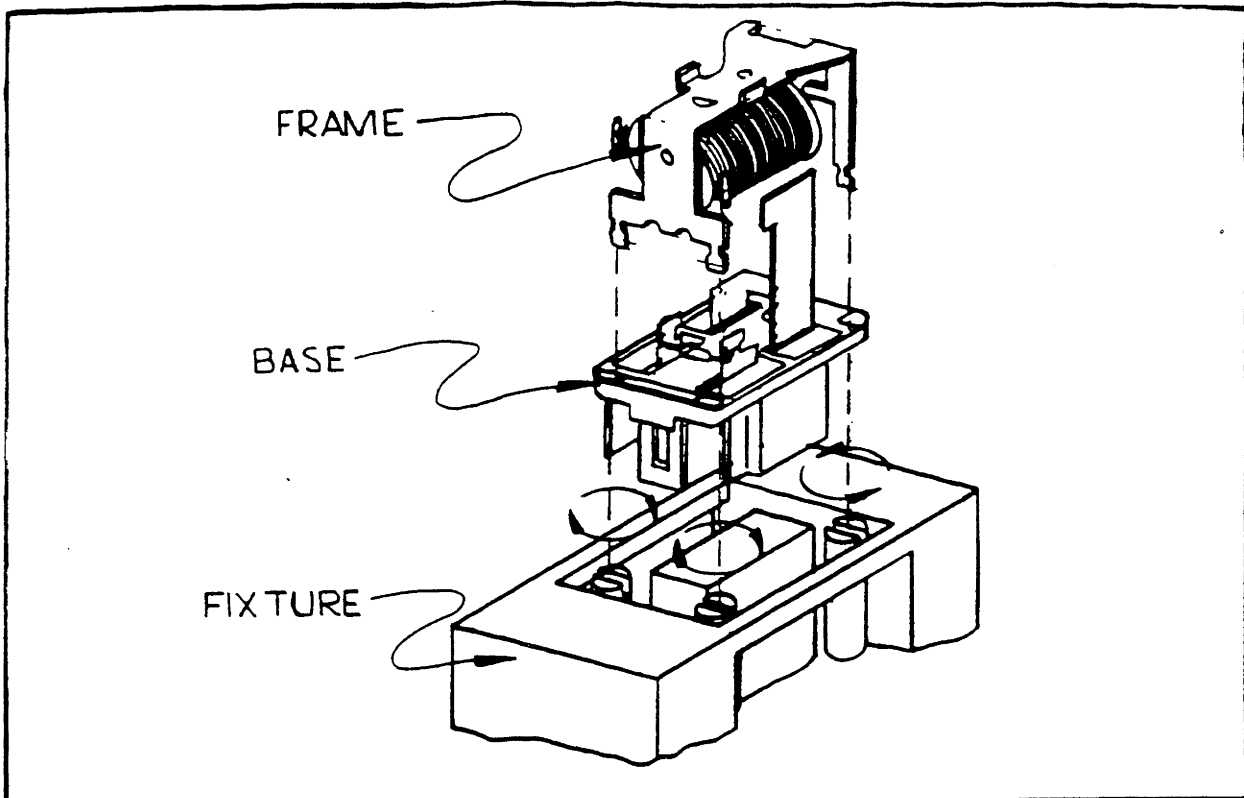

Figure 3-5: Heater Blower Assembly

OPERATOR INSTRUCTION

1. Place (1) base, frame and coil assembly into the fixture as shown above.
2. Press palm buttons to seat the frame into the base and twist the frame legs under the base.
Note: You must remove the relay immediately after the top air cylinder begins to move up.
3. Place the finished assembly on the belt conveyor, terminals down.

OPERATOR INSPECTION

Visual and check for the following defects:

1. Frame legs (3) not twisted.
2. Foreign material.
Place defective assembly in red reject container.
Keep work area clean at all times.
3. Compare the S.O.P. settings to the actual machine settings whenever you start running this operation. Insure that the actual settings agree with the S.O.P.

QC	WSB	EWK	FRS	OP	PLT	AS DATE	CERT NO	 UNITED TECHNOLOGIES AUTOMOTIVE
PC			TC	150	021	6/6/88	NO	

Figure 3-6: Power Relay Assembly

Chapter Four

Related Work

4.1 Introduction

The results of the literature search and industry practices survey provide insight into the tool qualification procedure developed. Specifically, the literature search indicated the high leverage areas in improving injection molding processes. Interviews with industry experts revealed techniques which provided demonstrated improvements. Together these two activities resulted in a focused and efficient approach to increasing the capability of the plant's production processes.

4.2 Literature Search

4.2.1 Part and Mold Design

Successful production in injection molding is a function of part design, mold design and construction, preparation of molding material (resin), processing, and monitoring of part parameters and process parameters. Initial interviews with UTA plant personnel indicated that processing and monitoring the process were areas which required improvement. As the literature on process was investigated, however, statements such as, "Next to resin selection and mold design, the performance properties of molded parts are determined by proper control over plastic processing conditions,"¹³ raised questions as to where research efforts should focus.

The literature contained numerous examples of effective use of mold filling simulation (computer aided design) to diagnose mold problems. Mold filling analysis of a car console identified the potential for visual defects related to weld and flow lines in the molded parts.¹⁴ A second analysis

accurately depicted the area of warpage seen in two products in the manufacturing facility and predicted which product is higher in quality.¹⁵ Flow simulation outputs were also used to assess detrimental effects such as warpage and dimensional instability for a drill housing mold.¹⁶

Some authors went even further upstream in the development cycle and addressed the importance of part design. As expressed by the president of Technical Plastics Corporation, "No amount of computer aided cooling and flow analysis will correct for an improper part design."¹⁷ The part design must be sufficiently robust to withstand upsets of variability inherent in production. Quality must be designed into the part.¹⁸

Given the focus in the literature on proper part and mold design, it appeared inefficient to develop improved process monitoring techniques if the foundation to which the techniques would be applied was weak. This conclusion led to development of a tool qualification procedure that would indicate if indeed the tool was capable of producing the parts specified by the customer.

4.2.2 Mold Check Out

In order to diagnose if the tool is capable of producing the specified parts, a systematic check out of the mold is required. Slight variations in processing conditions--temperatures, pressures, speeds, times--can affect part quality. In order to explore the range in part quality which the mold can produce, the effect of these process variations must be established.

4.2.2.1 Four Key Process Variables

Modern injection molding machines give the molder control over dozens of machine parameters. Trying to decide which parameters to vary is,

therefore, a daunting task. Injection molding literature helped reduce the complexity of this problem. Both Paulson and Groleau (two distinguished plastics processing consultants) agree that melt temperature, flow rate during filling and packing, cavity pressure and mold cooling (mold temperature) are the most important processing parameters in molding. Variations in these parameters can affect the dimensional stability, shrinkage and strength properties of finished parts.¹⁹

The theoretical justification for the importance of these parameters in molding is linked to the properties of plastic material. As discussed in Chapter Two, plastics are compressible, shrink significantly when they cool, and have a temperature- and flow-dependent viscosity. These properties allow a qualitative model to be developed which relates part quality to critical process variables (Figure 4-1).

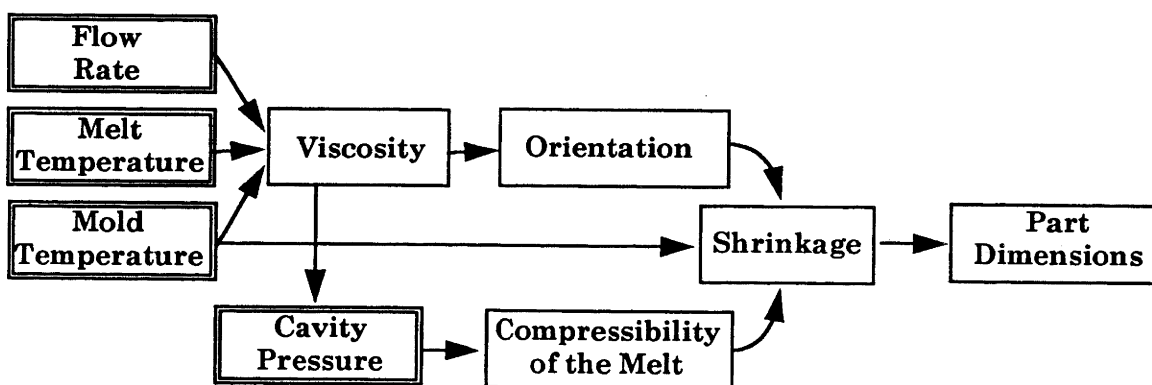

Figure 4-1: Qualitative Model of the Molding Process

Part quality is indicated above by "part dimensions" because dimensional variation is a common quality problem. Part dimensions are influenced by the mold design (the physical measurements of the steel) and the shrinkage of the material as it cools. Shrinkage is influenced by the compressibility of the melt, the cooling rate, and the polymer orientation.

Higher compression packs more molecules into the cavity, reducing the free volume--the volume of space in the melt that is not actually occupied by molecules--and, consequently, results in less shrinkage. Faster cooling rates--i.e. colder mold temperatures--give less time for the molecules to align and produce less shrinkage; the dimensions are essentially "frozen in." Less orientation--the alignment of the molecule and molecular segments in the direction of flow--reduces the number of carbon-carbon linkages in the direction of flow. Since shrinkage is partly due to the relaxation of the stretching caused by carbon-carbon linkages, less orientation results in less shrinkage.

Compressibility of the melt is influenced by the pressure in the cavity. Cavity pressure is dependent on melt viscosity. Lower viscosity results in smaller pressure drops along the flow path to the cavity and consequently higher cavity pressure. Higher cavity pressure results in greater compressibility and consequently less shrinkage. Orientation is affected by the viscosity of the melt. Viscosity is a measure of the melt's resistance to flow and is dependent on flow rate and temperature. An increase in flow rate results in greater shear thinning and consequently lower viscosity. Higher temperatures are an indication of greater molecular motion and consequently lower viscosity.

Hagan and Poiseuille's equation of the volumetric flow rate for a liquid through a tube (Equation 4.1) also provides insight into which process variables have the greatest influence on part quality:²⁰

$$Q = (\pi R^4 \Delta P) / (8L\mu) \quad (4.1)$$

where: Q = volumetric flow rate
 R = radius of tube
 L = length of tube
 ΔP = pressure drop
 μ = viscosity

The volumetric flow rate depends on three things: the physical constants of the tube (the part runners in injection molding), $\pi R^4/8L$; pressure; and viscosity. While Newtonian liquids are extremely sensitive to the radius of the tube, this effect is less important with plastic, where viscosity varies with shear rate. Viscosity is defined as the ratio of shear stress to shear rate:

$$\eta \equiv \sigma / \dot{\gamma} \quad (4.2)$$

where: η = viscosity
 σ = shear stress
 $\dot{\gamma}$ = shear rate

The viscosity of the plastic melt decreases as the shear rate increases. Fluids that behave in this way are said to be shear thinning. Based on high-shear-rate data for a number of polymers, an empirical "power law" expression has been suggested to describe the dependence of viscosity on shear rate:

$$\eta = K\dot{\gamma}^{n-1} \quad (4.3)$$

The shear stress is then given by:

$$\sigma = K\dot{\gamma}^n \quad (4.4)$$

A Newtonian liquid is special case for which $n=1$. For molten polymers, n is usually observed to be in the range of 0.3 to 1.0.²¹

The viscosity of the melt also decreases with an increase in temperature. A simple expression often used to describe this effect is given by the equation:

$$\eta(T) = Ae^{E/RT} \quad (4.5)$$

where: T = temperature
R = gas constant
E = activation energy for viscosity

To maintain the same volume of material in the mold cavity shot after shot (and consequently the same part quality), it is necessary to maintain the same pressure and viscosity conditions. In plastics (viscoelastic materials) the viscosity is both temperature- and speed-dependent and, therefore, these variables must also be consistent.

4.2.2.2 Design of Experiments

Literature on designed experiments provided guidelines on selecting response variables, critical processing conditions, and most importantly efficient methods for testing the effects of changing process parameters on part quality. More complete discussion on design of experiments is contained in Chapter Five.

4.3 Industry Benchmarking

Benchmarking of processors considered "state of the art" is a useful method to understand current practices in tool qualification. This provides the information necessary not to emulate, but to surpass current practices by learning what has been successful and what has not worked in industry. The benchmarking section of this report provides an overview of current practices in use for mold qualification in non-UTA molding operations recognized by industry experts as high-quality manufacturers.

Benchmarking information was obtained through both interviews with and visits to high quality molders, material suppliers and consultants with expertise in molding. These included C&J Industries, Eastman Kodak,

Intesys Technologies, Nypro Inc., Monsanto Applications Development Center, Paulson Training Programs, RJG Associates and RJG Technologies. Information was gathered on all aspects of the molding process and the complete summary is included as Appendix A. The ideas which relate to tool qualification are summarized below:

1) All molders had implemented a structured approach to mold qualification. For some of the molders this included an area set aside from production with machines dedicated to mold check out. Here, experiments (some used DOE's) could be performed to test the mold for dimensions and reproducibility. Other molders used less sophisticated procedures, but could still pinpoint problems such as an unbalanced runner system.

2) Critical dimensions used for qualification are best determined with part and tool designer input. The part designer selects critical dimensions from an applications point of view--dimensions which affect functionality. Tool designers can assist the molder in selecting dimensions from a processing point of view--dimensions which will show the greatest variation during production. Usually just one to three critical part dimensions will provide an indication of the other dimensions. This reduced number of critical dimensions greatly simplifies the qualification procedure.

3) Once the optimal machine settings have been identified, a capability study on the critical part dimensions is performed. The capability measurement must reflect variation across all cavities, not only variation within a single cavity. Typically, the customer prefers not to detect a difference in dimensions depending on which cavity produced the part. If

there is unacceptable variation across cavities, it will be the molder, not the customer, who will have to sort the parts by cavity number.

4) Reproducibility of process and experiments is a key aspect of qualification. For this reason precise set-up sheets must be maintained which include mold cooling line hook-up (Figure 4-2). In general, the inlets and outlets for each cavity should be connected in parallel to their source of supply given that the pump can meet the required flow rates. Too many waterlines in series can cause high pressure drops and uneven mold surface temperature due to high temperature rise of coolant. In addition, the inside diameter of the hoses should be at least as large as, or preferably larger than, the coolant line diameter in the mold to avoid pressure drops and loss of cooling efficiency.²² The process set-up sheet ensures reproducibility in processing conditions when the mold enters production.

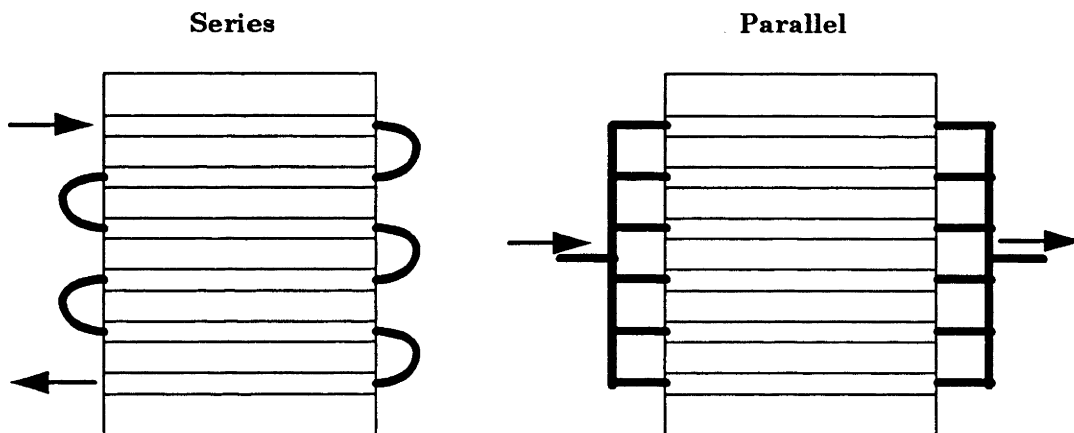

Figure 4-2: Cooling Line Hook-Up

5) As much as possible, molds are run on the same machine every time, thus reducing variability arising from slight differences in machine control parameters and calibration. If the mold must run on several different

machines, machine settings/set-up sheets for each machine will be determined during tool qualification.

In summary, two major steps were incorporated to successfully qualify a mold: optimizing the process and ensuring the reproducibility of the optimized process. These two steps provided the understanding and control of the process necessary for repeatable production of quality parts. The procedure developed here surpasses any structured procedures observed in industry and provides information not only to optimize the process, but develops an understanding of how the process affects critical quality criteria.

Chapter Five

Methodologies for Qualification

5.1 Introduction

This chapter provides an overview of Taylor's current tool qualification procedure. An improved procedure that addresses the weaknesses of the current procedure and capitalizes on knowledge gained through industry benchmarking is then suggested.

5.2 Current Tool Qualification Procedure

The current tool qualification procedure is an unsystematic process that results in repetitive activity. As outlined in Figure 5-1, molds coming into the plant are first tested using machine settings that are "dialed in"-- i.e. approximated based on a process engineer's experience. Sampled parts are measured, and these measurements are compared with dimension specifications. At least initially, if the sampled dimensions do not meet the specifications, the engineer tweaks the machine variables attempting to hit a combination of settings that will produce parts that satisfy the specifications.

After several iterations of changing machine settings, the engineer will usually conclude that the mold is not capable of producing these dimensions and will request a print deviation based on the dimensions that have been produced. If the customer refuses the request, mold modifications will be made to bring the part to print. The modified mold re-enters the tool qualification loop and the tweaking, sampling, measuring, tweaking process begins again.

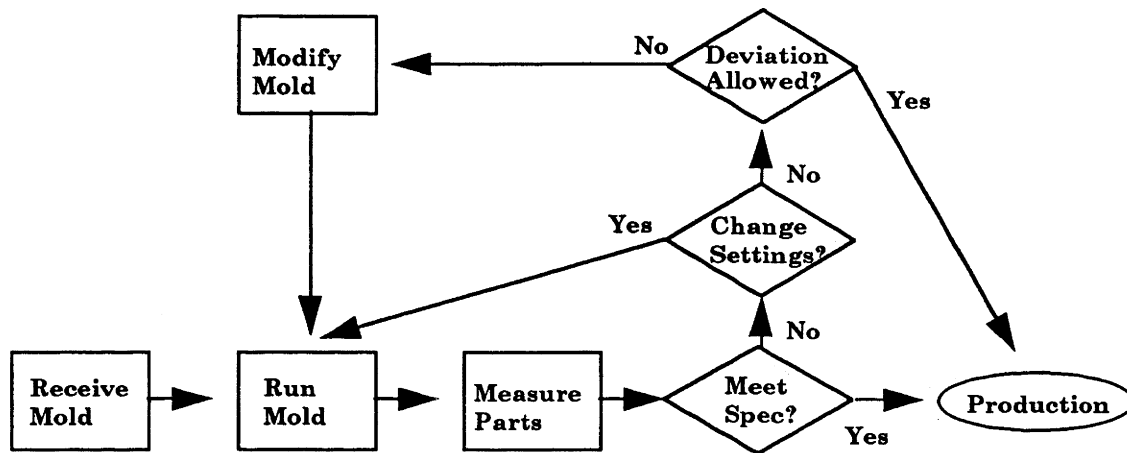

Figure 5-1: Current Tool Qualification Procedure

The current tool qualification procedure has several weaknesses. Clearly, it is an extremely inefficient process. Complex part geometries and multi-cavity molds require numerous critical dimensions to be satisfied. A typical part has 25 critical dimensions and most of Taylor's molds are either four or eight cavity molds. The process of changing machine settings and modifying the mold may be repeated several times before the part meets all the specifications. This process can take as many as six weeks. In addition, the "dialing in" of machine variables results in acceptable, not optimal, machine settings--the dimensions produced will not necessarily be centered within the specification limits.

This procedure may even falsely identify the need for mold modifications. Changing machine settings may bring part dimensions, which were initially unacceptable, within the specifications. The number of possible machine variable combinations, however, is infinite. The current procedure fails to systematically explore the ability to alter part dimensions

by changing machine settings and, therefore, may diagnose the need for costly mold modifications when changes to machine settings is sufficient.

5.3 Improved Tool Qualification Procedure

An improved procedure for tool qualification requires an accurate mapping of the molding process window to quantify the effects that machine settings have on part quality. Part quality criteria include part dimensions, surface quality, or even mechanical properties. The relationship between machine settings and quality can then be used to optimize the process. In the case of dimensional criteria, this would mean centering the dimensions, as much as possible, between the specification limits. Small disturbances in the process--fluctuations in process parameters or material quality--are best accommodated when the mean is centered because this is the point at which the widest dimensional variations in either direction can be tolerated. For surface quality, it would simply mean minimizing the surface defects. For mechanical properties, it might mean eliminating weld lines or maximizing tensile strength.

While mapping the machine settings to quality criteria could entail lengthy experimentation and analysis, statistical methods coupled with underlying assumptions about the process can be used to efficiently produce the desired result. Section 5.3.1 describes the methodology of applying designed experiments to tool qualification. The experiments outlined in Chapter Six then demonstrate the use of these techniques on three molds--a single cavity, four cavity and eight cavity mold.

In order to maximize the benefit of mapping the process, a structured approach must be applied to the entire tool qualification process. Reproducibility of process and experiments is a key aspect of qualification.

For this reason, precise set-up sheets must be maintained to ensure reproducibility in processing conditions once the tool enters production.

Figure 5-2 shows an overview of a tool qualification process based on these principles. (The complete procedure is included as Appendix B.) The key steps include mold layout--measurement of the mold steel dimensions, establishment of basic machine process conditions, use of instrumentation and statistical methods for process understanding and optimization, and finally, production capability analysis to examine stability and control needs.

Tool Qualification Process Flow

Pre-Processing Qualification

1. Layout mold, all cavities, to verify dimensional consistency of tool construction
2. Obtain schematic of mold cooling channels from tool designer

Establishing Set-Up Procedures

1. Select machine with appropriate barrel size and clamp capacity
 - select barrel with correct weight and plasticizing capacities
 - select machine with sufficient clamp capacity
2. Issue cooling line schematic that minimizes cycle time and maximizes cooling uniformity
 - maintain turbulent flow conditions in the mold
 - maintain uniform heat transfer in all parts of the mold
3. Determine material regrind percentage to be lesser of
 - an exact sprue-runner/shot weight ratio
 - maximum percentage allowable for application properties

DOE Preparation

1. Identify critical part dimensions and other part properties that will be the response variables
2. Determine minimum shot size that
 - fills all cavities
 - maintains a cushion
3. Establish switchover position based on hydraulic/cavity pressure trace
4. Determine holding time based on shot weight
5. Identify the critical process parameters that will be the input variables
6. Determine machine variable settings for the critical process parameters

Running the DOE

1. Plan the run conditions and enter them into the design matrix
2. Collect the DOE samples for each of the planned run conditions
 - set the machine parameters to the levels shown in the appropriate row of the run condition (or design) matrix
 - cycle the machine long enough to allow the process to equilibrate
 - collect samples (10 shots is suggested)
 - proceed to the next row in the design matrix

Figure 5-2: Proposed Tool Qualification Procedure

Tool Qualification Process Flow

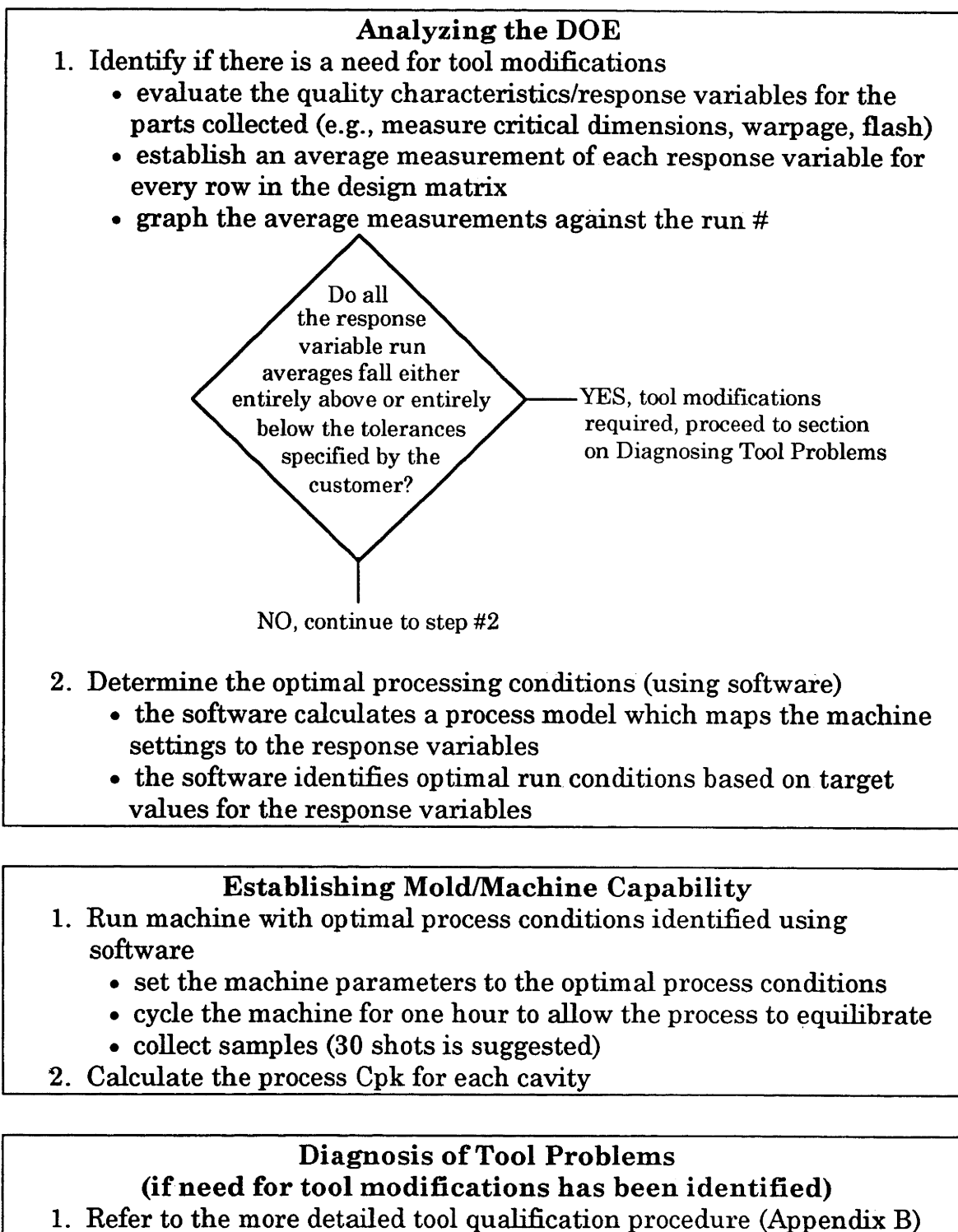

Figure 5-2: Proposed Tool Qualification Procedure

5.3.1 Design of Experiment

An improved procedure for tool qualification requires an accurate mapping of the molding process window to quantify the effects that machine settings have on part quality. While mapping the machine settings to quality criteria could entail lengthy experimentation and analysis, statistical methods coupled with underlying assumptions about the process can be used to efficiently produce the desired result. This section reviews the methodology for applying designed experiments to the tool qualification process.

5.3.1.1 Selection of Response Variables

The first step in designing an experiment is to determine which characteristics of the plastic part to measure. Phadke provides the following four guidelines for choosing the response variables, also referred to as "quality characteristics."²³

- 1) The quality characteristics chosen should directly affect the part function or assembly methods specified by the customer.
- 2) As far as possible, choose continuous variables as quality characteristics. Continuous variables provide the most descriptive information about the process.
- 3) Try to use quality characteristics that are easy to measure. Availability of appropriate measurement techniques often plays an important role in the selection of quality characteristics.
- 4) Ensure that quality characteristics are complete--that is, they should cover all the requirements for the plastic part.

In accordance with these guidelines, one or two critical dimensions per part were chosen as the response variables. Dimensions were selected for several reasons. First, dimensional variation is the most frequent cause of

quality problems at Taylor. Second, dimensions impact assembly of the part. Third, usually one to three critical dimensions will provide an indication of other critical dimensions. Fourth, unlike many other indicators of part quality--short shots, flash, sink marks, voids, poor welds, and flow marks--dimensions do not involve subjective measurements.

5.3.1.2. Measurement of Response Variables

The measurements for the parts produced by the single and four cavity molds were made with calipers of +/- 0.001" accuracy. All measurements in each experiment were made by one individual to eliminate variation across "operators." The critical dimension in the eight cavity mold study was measured using a shadow graph of +/- 0.0001" accuracy. Because of the significant set-up time required to position the part for taking the measurement and the large number of samples to be measured, measurements were made on three shifts by three different individuals. A coordinate measuring machine would have increased the speed and accuracy with which measurements could be made, allowing one individual to complete the entire job; however, the plant's coordinate measuring machine was broken.

5.3.1.3 Selection of Process Parameters

The next step in preparing the designed experiment is to identify the process parameters, or "control factors" that will be mapped to part quality. Control factors are defined as:

- 1) factors whose levels can be selected by the designer.
- 2) factors that influence a distinct aspect of the molding process.

At first, this would appear to be a difficult task. Modern injection molding machines permit dozens of machine variables to be controlled. In addition, such a variety of process control methodologies exist even within UTA that determining which variables to study would be part/machine dependent. There is, however, a way to simplify the process and reduce the number of variables involved.

Typically, injection of the plastic into the mold is controlled by setting an injection velocity, an injection pressure, an injection-to-hold switchover point and a hold pressure/time. The injection molding machine will attempt to follow the injection speed until it reaches the set injection pressure, at which point it will change to pressure control. In pressure control, the machine simply follows the pre-set injection pressure until the switchover point is reached. The injection-to-hold switchover may be based on the position of the screw, duration of injection, hydraulic or cavity pressure. Hold time is guessed. This description reveals the abundance of possible process variables which may have an impact on part quality. The following guidelines, however, simplify the task.

1) During injection of the plastic, the only control will be the velocity of the injection; the injection pressure will be set high enough to allow the machine to maintain the set injection speeds (Figure 5-3, A and B). Traditionally, injection was run under pressure control (Figure 5-3A). Injection rates that allowed the set hydraulic pressure not to be exceeded would result. Today, injection controlled by velocity is preferred (Figure 5-3B). In velocity control, the machine follows the set injection velocity. The hydraulic pressure is set high enough to allow the machine to maintain the set injection speeds without becoming pressure

limited. The preference for velocity controlled injection relates to the goal of producing parts of consistent quality. Flow rate affects viscosity, orientation, and compression of the plastic in the mold cavities. (See Figures 2-8 and 2-9 in Chapter Two.) Variation at the mold cavity usually translates to variation in finished part quality. Velocity controlled injection maintains a more consistent flow rate than does pressure controlled injection. Therefore, injection controlled velocity is preferred.

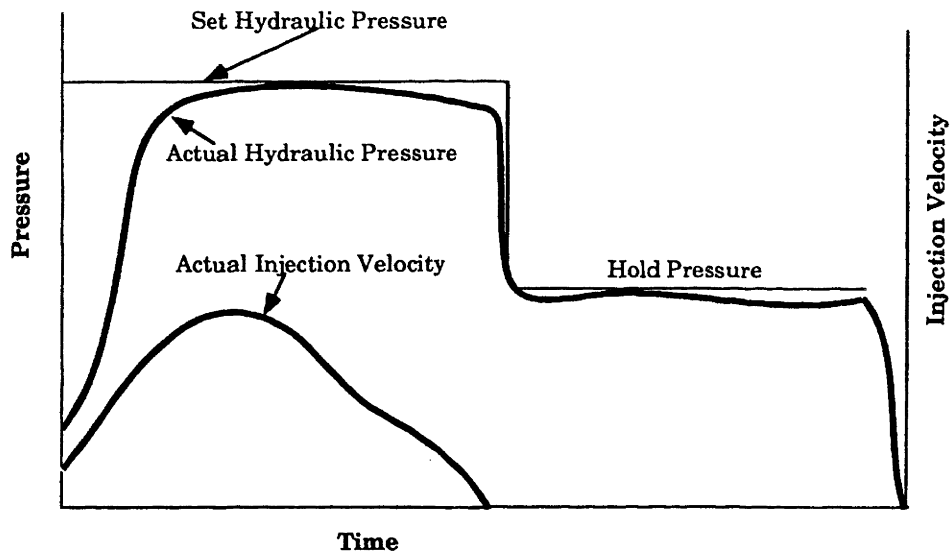

Figure 5-3A: Hydraulic Pressure Control

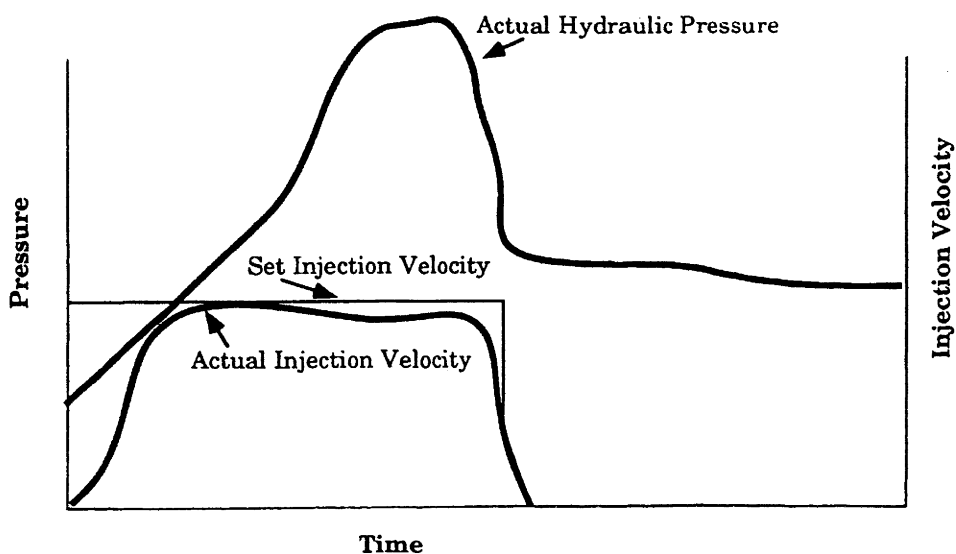

Figure 5-3B: Injection Velocity Control

2) The switchover point will be controlled by screw position.

Switchover controlled by injection screw position corresponds to switching over when a certain volume of plastic has filled the cavity. Consistency of cavity fill helps ensure finished part consistency. In order to set the switchover position, use of cavity pressure sensors or analysis of the hydraulic pressure is required. Switchover must occur before the part is completely full to avoid overpacking and/or flash. Therefore, when the pressure begins to increase rapidly, switchover should occur. (See Section 2.4.4 in Chapter Two for a more detailed explanation.)

3) Hold time is determined by gate-freeze-off time. This again, may be determined through the use of cavity pressure sensors. (See Section 2.4.5 in Chapter Two for a more detailed explanation.) If cavity pressure sensors are not available, hold time may be progressively increased as each successive part is weighed. When increasing hold time no longer results in an increased part weight, the gate has frozen and hold time may be set (Figure 5-4).

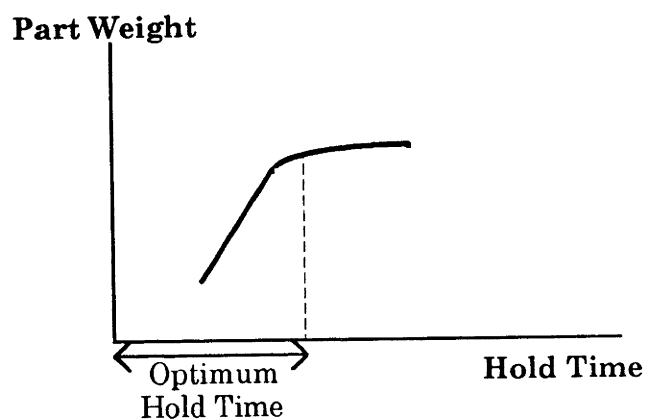

Figure 5-4: Determining Hold Time

Using these methods to set-up the process reduces the number of variables that have impact on part quality, and also results in better reproducibility while molding. The methods are all based on maintaining consistent conditions in the mold cavity. The number of critical process parameters is now reduced to the four variables presented in the qualitative model developed in Chapter Four and reprinted below (Figure 5-5).

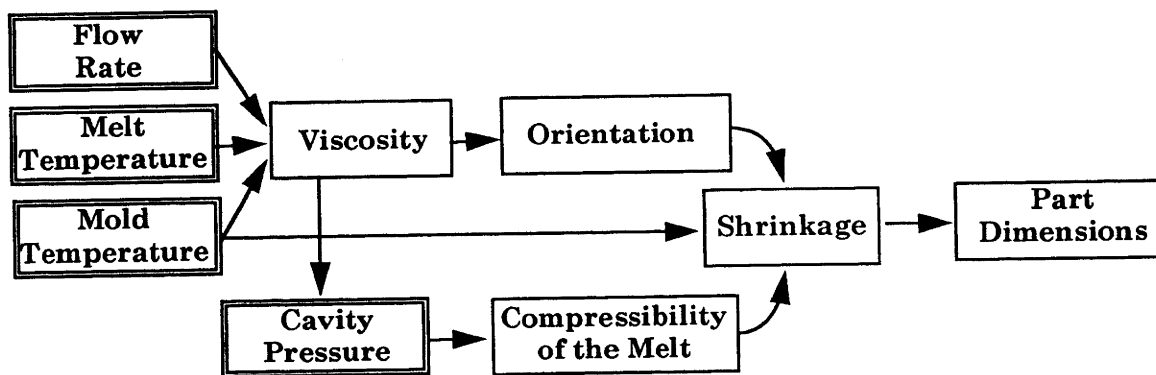

Figure 5-5: Qualitative Model of the Molding Process

The control factors in the designed experiment, however, must be variables that can be adjusted with machine settings. Since we cannot directly set flow rate, melt temperature, mold temperature, and cavity pressure, the machine variables which most directly affect these critical process parameters will be selected as the control factors. In addition, because of the interaction of the molding variables, only one variable at a time can be directly controlled.

Chapter Four discussed which molding variables are most critical during each of the four stages of the molding cycle and which machine settings influence those molding variables. The table developed is reprinted below (Table 5-1). As shown in the table, more than one machine variable may influence the critical molding variables of a single stage. The machine setting chosen as the control factor was the one considered to have the

biggest impact on the molding variables or most likely to vary if not directly controlled. The control factors chosen and their relationship to the critical molding variables are shown in Table 5-2. High, midpoint, and low settings of the control factors are established by following material supplier recommendations, using process experience, or briefly scoping out the process. Levels of the factors chosen are included in the discussion of the experiments in Chapter Six.

Process Stage	Molding Variable	Machine Setting
1. Plastication	<ul style="list-style-type: none"> • Melt Temperature • Flow Rate 	<ul style="list-style-type: none"> • Nozzle and Barrel Temperatures • Screw Speed • Back Pressure
2. Injection	<ul style="list-style-type: none"> • Flow Rate 	<ul style="list-style-type: none"> • Injection Velocity
3. Packing	<ul style="list-style-type: none"> • Cavity Pressure 	<ul style="list-style-type: none"> • Hold Pressure
4. Cooling	<ul style="list-style-type: none"> • Mold Temperature 	<ul style="list-style-type: none"> • Coolant Temperature • Coolant Flow Rate • Cycle Time

Table 5-1: Influences on Part Quality

Critical Process Parameters (Molding Variable)	Control Factors (Machine Setting)
Melt Temperature	Nozzle and Barrel Temperatures
Flow Rate	Injection Velocity
Cavity Pressure	Hold Pressure
Mold Temperature	Coolant Temperature

Table 5-2: DOE Control Factor Selection

5.3.1.4 Design Selection

For the purposes of this report, the subject of choosing a particular designed experiment will not be discussed in detail. Designed experiments are statistically sound methods to reduce the number of experiments necessary to gain information about a process. For instance, we chose four process variables, and will be studying three levels of each. Our goal is a detailed model of the process; i.e. how the variables, either individually or through interactions, affect the parts. To acquire this information using classical experimentation (changing one input at a time) would require 3^4 or 81 runs. However, by using designed experiments, the same information can be acquired in less than 30 runs. Schmidt and Launsby provide the comparison of three level designs shown in Table 5-3.

Design	Attributes
3 ^{k-q} (Taguchi type/ Orthogonal array)	<ul style="list-style-type: none"> • Used for qualitative or quantitative factors. • Estimate all linear and quadratic effects and, when higher order resolutions are designed, you can also estimate linear and quadratic 2-way interactions. • Typically the 3^{k-q} (q is some positive integer < k) is a good choice if you have qualitative factors with few or no interactions. This is not a good choice for factors that are quantitative. • Large number of experimental runs required. (for k=4 and all 2-way linear interactions, n=27)
Box-Behnken	<ul style="list-style-type: none"> • Used only for quantitative factors; however, for some k you can have one qualitative blocking factor--i.e. a factor which cannot be randomized. The experiment is run in blocks for each level of the blocking factor and randomization is performed within the blocks. • Estimate all linear, quadratic, and 2-way linear interactions plus experimental error. • Large number of experimental runs required. (for k=4, n=27)
Central Composite Design	<ul style="list-style-type: none"> • Used primarily for quantitative factors; however, if you have only 1 qualitative factor, the CCD can still be useful. • Estimate all linear effects, selected quadratics, and selected 2-way linear interactions plus experimental error. • This is typically your best choice for quantitative factors each at 3 levels. • Usually most efficient in terms of number of experimental runs required. (for k=4 and all 2-way linear interactions, n=20)
D-optimal	<ul style="list-style-type: none"> • Used for quantitative, qualitative, or a mix of both. • Can estimate any desired effect with reduced n. • This design will typically not be orthogonal, but it does minimize the non-orthogonality of the design. • Usually requires smaller number of experimental runs than does Box-Behnken . (for k=4, n=25)
Full Factorial	<ul style="list-style-type: none"> • Used for qualitative or quantitative factors. • Estimate all linear and quadratic effects plus all possible simple and higher order interactions. • Largest number of experimental runs required. (for k=4, n=81)

Table 5-3: Summary of 3-Level Design Types²⁴
(k=number of factors and n=number of experimental runs)

For the experiments discussed in this thesis, a Box-Behnken Design was chosen. The complete 27 run design is shown in Table 5-4. The Box-Behnken design is an efficient design for modeling quantitative factors with three levels if the ability to estimate all factor 2nd order effects and all linear 2-way interactions is desirable.²⁵ Since the interaction of temperatures, speeds, and pressures is significant in injection molding, the Box-Behnken design is a good choice.

Run #	Cooling Water Temp (°F)	Nozzle/ Barrel Temps (°F)	Injection Speed (%)	Hold Pressure (psi)
1	-1	-1	0	0
2	-1	0	-1	0
3	-1	0	0	-1
4	-1	0	0	1
5	-1	0	1	0
6	-1	1	0	0
7	0	-1	-1	0
8	0	-1	0	-1
9	0	-1	0	1
10	0	-1	1	0
11	0	0	-1	-1
12	0	0	-1	1
13	0	0	0	0
14	0	0	0	0
15	0	0	0	0
16	0	0	1	-1
17	0	0	1	1
18	0	1	-1	0
19	0	1	0	-1
20	0	1	0	1
21	0	1	1	0
22	1	-1	0	0
23	1	0	-1	0
24	1	0	0	-1
25	1	0	0	1
26	1	0	1	0
27	1	1	0	0

Table 5-4: Box-Behnken Design
(The +1, 0, and -1 indicate the high, midpoint and low levels respectively of the control factors.)

During the experiment, run conditions were varied in the order shown in Table 5-4. Ideally, a more random ordering is desirable. The compromise was made because of the time required for temperatures to equilibrate. It requires about one hour to raise the mold temperature (controlled by changing the cooling water temperature) 40 degrees. The time lag results from the inefficiencies of trying to heat all surfaces of a block of steel equally with a few internally cored cooling passages. Decreasing the mold temperature 40 degrees would require closer to three hours. The injection of molten plastic into the mold works against the efforts to cool the steel.

Changing the nozzle and barrel temperature also involves time lags. It was estimated that increasing these temperatures fifteen degrees would take 20 minutes and decreasing them, 30 minutes. Once the thermocouples are reading the correct temperatures, the plastic currently in the barrel must be used up before experimental samples can be collected because plastic properties are history dependent. The plastic in the barrel has undergone a change in temperature, and therefore, has a different heat history than plastic which has been heated with a consistent set of temperatures.

Chapter Six

Experiments

6.1 Introduction

In order to evaluate the benefit of using designed experiments in the tool qualification procedure, three molds were qualified--a single cavity, four cavity and eight cavity mold. This chapter reviews these experiments in terms of the ability to determine the relationship of process to quality criteria. Specifically addressed are the ability to:

- **Determine if the mold, as built, can produce acceptable parts in all cavities**

The tool qualification process establishes the capability of the tool to produce parts that meet the customer specifications. If the customer specifications--i.e. critical dimensions--can be brought into specification with changes to the injection molding machine settings, the cost and lead time required to make physical modifications to the tool can be avoided.

- **Establish the optimal processing conditions for production**

It has been demonstrated at the plants and in the DOE's that more than one set of processing conditions will produce parts that meet the customer specifications. The tool qualification process, however, will ensure that the processing conditions that produce the best centered mean and least variation will be identified.

6.2 Single Cavity Mold

The first experiment was run on a single cavity mold. The single cavity mold produces a terminal block which holds the turn signal switch in GM's CK Truck (Figure 6-1). The tool had never been qualified because GM did not accept UTA's bid for production. The job was awarded to a foreign supplier instead.

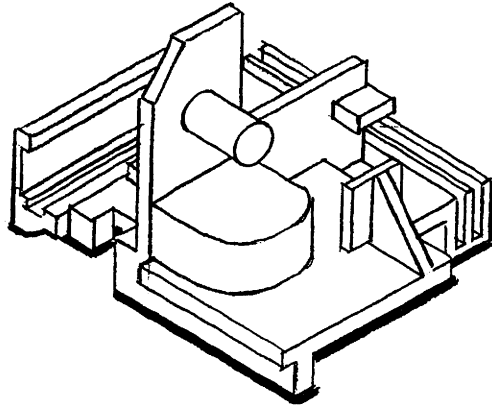

Figure 6-1: Part Produced by Single Cavity Mold²⁶

6.2.1 Design Preparation and Execution

6.2.1.1 Selection of Response Variables

Table 6-1 lists the five response variables selected for the experiment and their associated target values. The dimensions were chosen by referring to the print for the part. The print shows several "star" or critical dimensions. One length and one width star dimension were chosen as response variables. These were the largest starred dimensions and easy to measure with calipers, facts which would reduce both the potential for and impact of measurement error. (One individual made all the measurements which eliminated variation across "operators.") In addition, by choosing one dimension in the direction of plastic flow and one dimension across the direction of flow, these dimensions could be used as an estimate for the shrinkage differential in the part. For each of the 27 experimental runs, ten parts were collected and measured. The average measurement of the ten samples for each run was used as the response variable.

Additional response variables included the run standard deviations associated with the two critical dimensions measured. The standard deviation was calculated from the ten parts sampled. This response variable was used to influence the model to minimize variation while trying to satisfy the dimension specifications.

When examining the parts sampled during the experiment, certain run conditions were observed to produce severe flash. Flash is defined as excess material and usually appears on the surfaces of the part which lie along steel intersections in the mold cavity--i.e. the mold parting line. It is usually caused by a mold deficiency. Other causes are an injection pressure greater than the clamping force, overheated material, and insufficient venting.²⁷ In order to ensure that the optimal run condition selected would not produce flash, flash attribute data was included as a response variable. Each run was given a flash score. Parts with no flash received a score of zero. Parts with flash received a score of twenty plus some number between zero and seven to reflect its relative ranking. This scoring method was used to discourage the computer model from selecting a run condition that produced any flash.

<i>Response Variables</i>	<i>Target</i>
Dimension #1 Average	41.25 mm
Dimension #2 Average	38.80 mm
Dimension #1 Standard Deviation	smaller is better
Dimension #2 Standard Deviation	smaller is better
Flash	smaller is better

Table 6-1: Response Variables for Single Cavity Mold

6.2.1.2 Selection of Process Parameters

The process parameters selected include cooling water temperature, nozzle/barrel temperatures, injection speed and hold pressure. The justification for why these parameters have the most influence in injection molding is provided in Chapters Two, Four and Five. The levels for these parameters were selected based on material supplier recommendations for Minlon® 22C (black). The levels chosen for process parameters are shown in Table 6-2. The final experimental design is presented in Table 6-3. Response variable data is included in Appendix C.

<i>Process Design Parameters</i>	<i>LEVEL</i>		
	<i>low</i>	<i>midpoint</i>	<i>high</i>
Cooling Water Temperature (°F)	120	150	180
Nozzle/Barrel Temperatures (°F)	590/540/530/520	590/565/560/550	590/590/580/570
Injection speed (%)	10	30	50
Hold Pressure (psi)	100	300	500

Table 6-2: Experimental Factors and Levels for Single Cavity Mold

Run #	Coolant Temp (°F)	Nozzle* Temp (°F)	Injection Speed (%)	Hold Pressure (psi)
1	120	540	30	300
2	120	565	10	300
3	120	565	30	100
4	120	565	30	500
5	120	565	50	300
6	120	590	30	300
7	150	540	10	300
8	150	540	30	100
9	150	540	30	500
10	150	540	50	300
11	150	565	10	100
12	150	565	10	500
13	150	565	30	300
14	150	565	30	300
15	150	565	30	300
16	150	565	50	100
17	150	565	50	500
18	150	590	10	300
19	150	590	30	100
20	150	590	30	500
21	150	590	50	300
22	180	540	30	300
23	180	565	10	300
24	180	565	30	100
25	180	565	30	500
26	180	565	50	300
27	180	590	30	300

Table 6-3: Experimental Design Matrix for Single Cavity Mold

*Nozzle and Barrel Temperature Profile:

Heater	Low	Midpoint	High
HT1	590	590	590
HT2	540	565	590
HT3	530	560	580
HT4	520	550	570

6.2.2 Experimental Outcomes

Once the experiments have been run and the response variables measured, the first step is to identify if the tool is capable of producing the dimensions specified by the customer. The customer typically specifies a target dimension and an acceptable tolerance on that dimension. The limits on the dimension are referred to as the upper and lower specification limits (USL and LSL). The ability of the tool to produce parts that meet the customer specifications can be quickly established by plotting the range of dimensions produced in the designed experiment against the specification and its limits. The dimensional results at each processing condition are displayed in Figures 6-2 and 6-3.

As can be seen, there is tremendous variation in the dimensions as processing conditions are varied--as much as 0.4 mm which is 16 times the tolerance on tight tolerance dimensions. This is an important result; the spread of the points demonstrates that changes to machine settings can be used to affect part dimensions. Some machine settings produce parts with dimensions which fail to meet the specifications. It could be possible, that all combinations of machine settings would produce part dimensions entirely above or entirely below the customer specifications. This would indicate the need for modifications to the mold steel dimensions. Figure 6-2 clearly demonstrates that the tool must be modified in order to bring dimension #1 into specification. In the case of dimension #2 (Figure 6-3), however, there are machine setting combinations which produce acceptable part dimensions, thus costly tool modifications are not required.

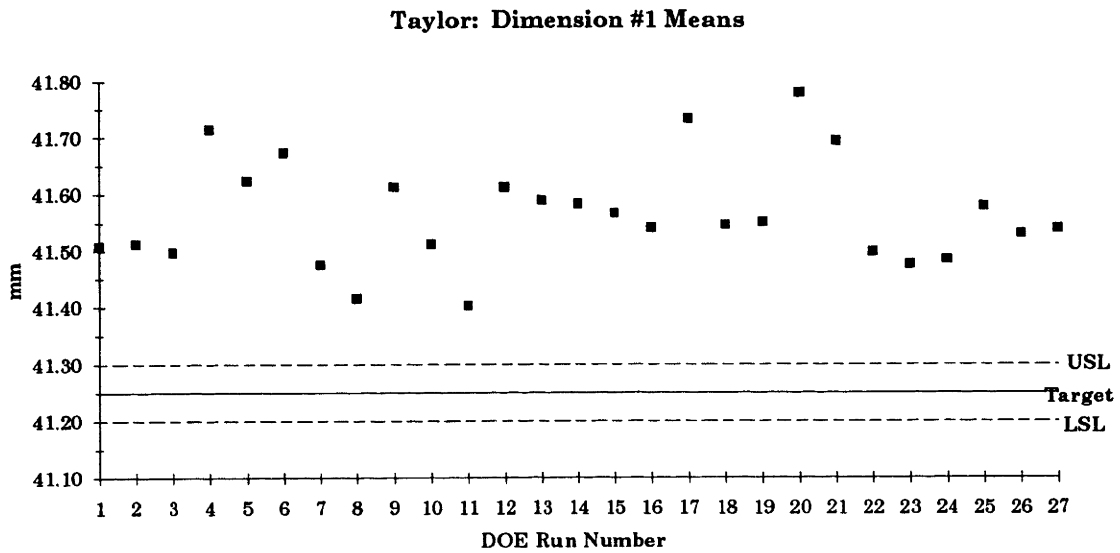

Figure 6-2: Single Cavity Mold, Dimension #1

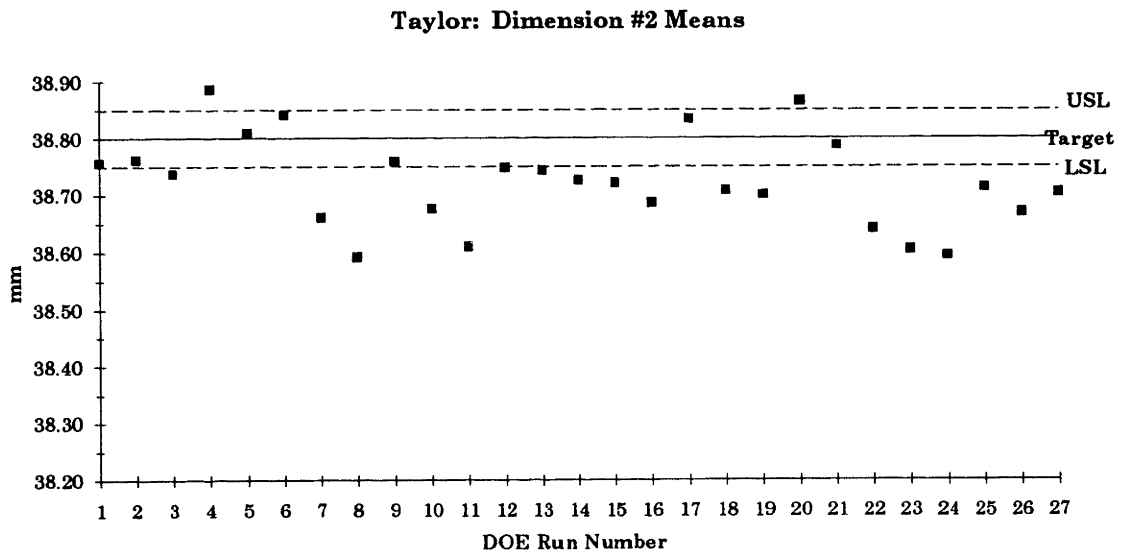

Figure 6-3: Single Cavity Mold, Dimension #2

In a true tool qualification process, one would stop at this point and diagnose the tool problems causing dimension #1 to fail to meet specification. But, in order to demonstrate the ability to predict optimal run conditions and

to reveal the inherent process capability of a modern injection molding machine if the tool is properly built, process mapping analysis was continued.

The dimensional and flash attribute data were correlated with the process conditions using BBN/Catalyst statistical software for the Macintosh. The data required by the software included the levels of the control factors and the corresponding response variable measurements for each run in the designed experiment and the target values of the response variables. It is important that the software be able to optimize based on several response variables. In this case, the process was optimized based on two dimensions (optimizing to a point), two standard deviations (minimizing the response variable), and flash (minimizing the response variable). The software attempts to move the response variables as a group close to their respective targets and suggests factor settings for the process to meet these targets. BBN/Catalyst displays the results of the optimization calculation as a matrix of plots that illustrate the predicted effects of changing factor settings on each response. The results can be seen in Figure 6-4.

At the bottom, the optimal process conditions are given. On the left axis, one sees the predicted values and the measured variability for the various response variables if the optimal process conditions are used. The individual plots indicate the relationship between the process variables and the response variables. For instance, increasing nozzle/barrel temperatures will result in a significant increase in critical dimensions. The vertical lines in each plot intersect the value for the optimal process condition. The dotted horizontal line (or lines) indicates the response limit. Rows with a single dotted line have a response whose goal is to minimize or maximize the output. Rows with two dotted lines have a response whose goal is to match a target value.

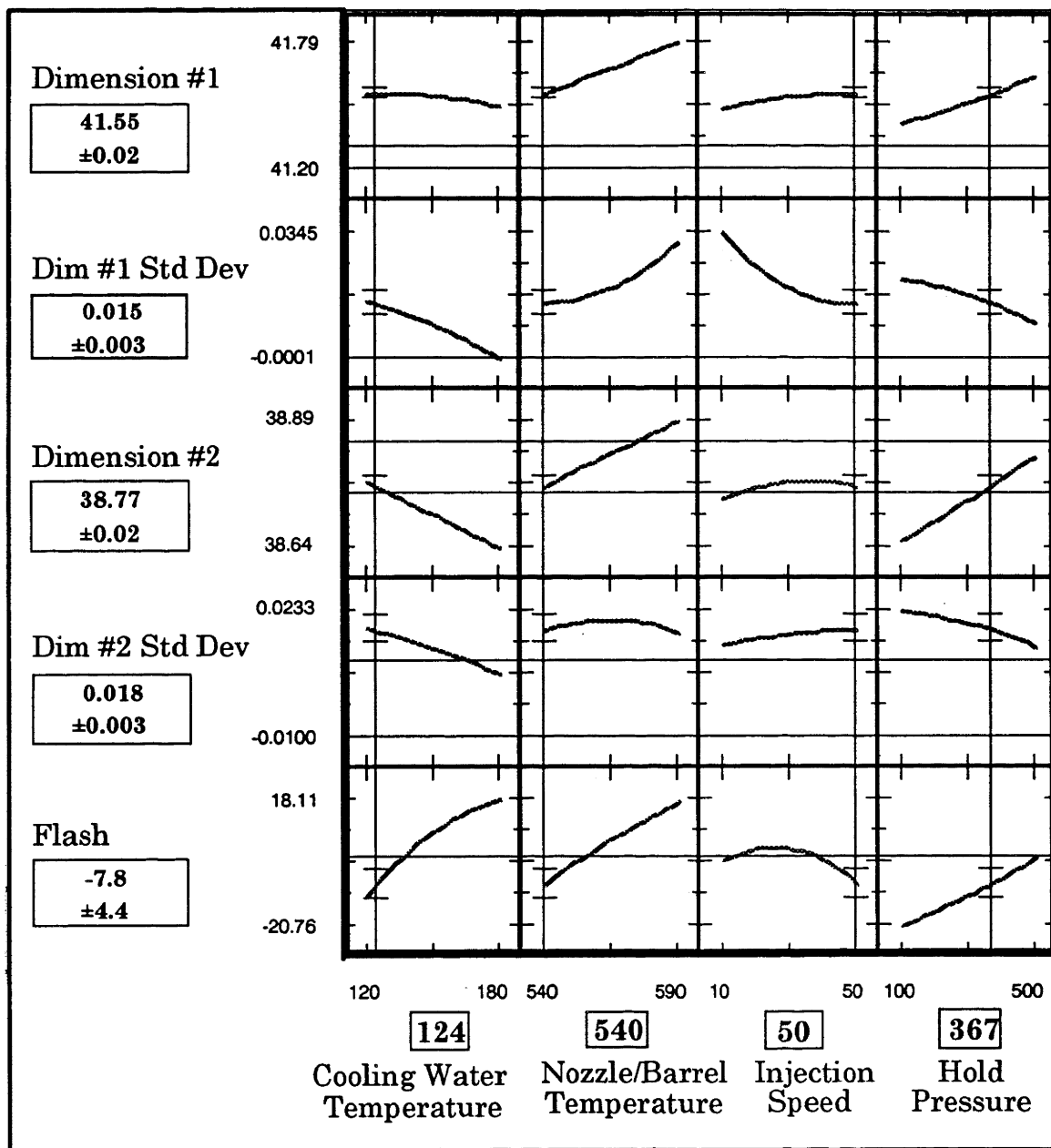

Figure 6-4: Optimization Results for Single Cavity Mold

To test the optimal process conditions predicted in the analysis, a capability study can now be run at these conditions. This allows comparison of actual versus predicted dimensions, and also provides an approximation of the capabilities of the process. In order to measure the capability of the process, the molding machine parameters were set to the predicted optimal process conditions and the machine was cycled for one hour to allow the process to equilibrate. Thirty samples were collected.

Figures 6-5 and 6-6 show the capability run results of this single cavity mold. As can be seen, the predicted dimensions correspond very well with the actual dimensions. The software predicted that the dimension #1 mean would be 41.55 +/- 0.02 mm. The actual mean was 41.555 mm. For dimension #2, the predicted mean was 38.77 +/- 0.02 mm. The actual mean was 38.774 mm. The accuracy in the measurement of the actual mean was +/- 0.005 mm which represents the tolerance of the calipers (+/- 0.025 mm) divided by the square root of the number of samples measured (30).

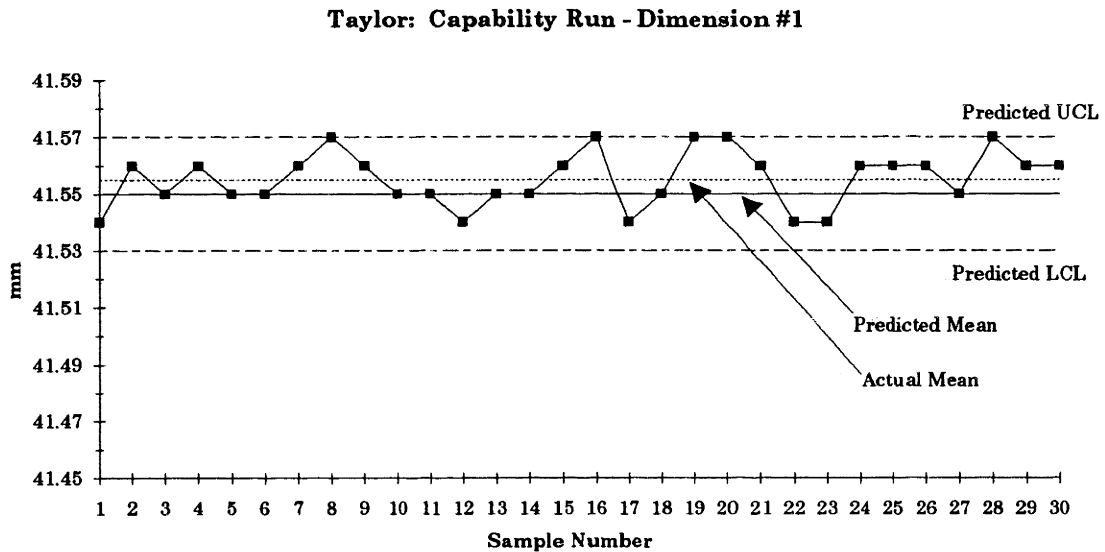

Figure 6-5: Single Cavity Mold, Dimension #1

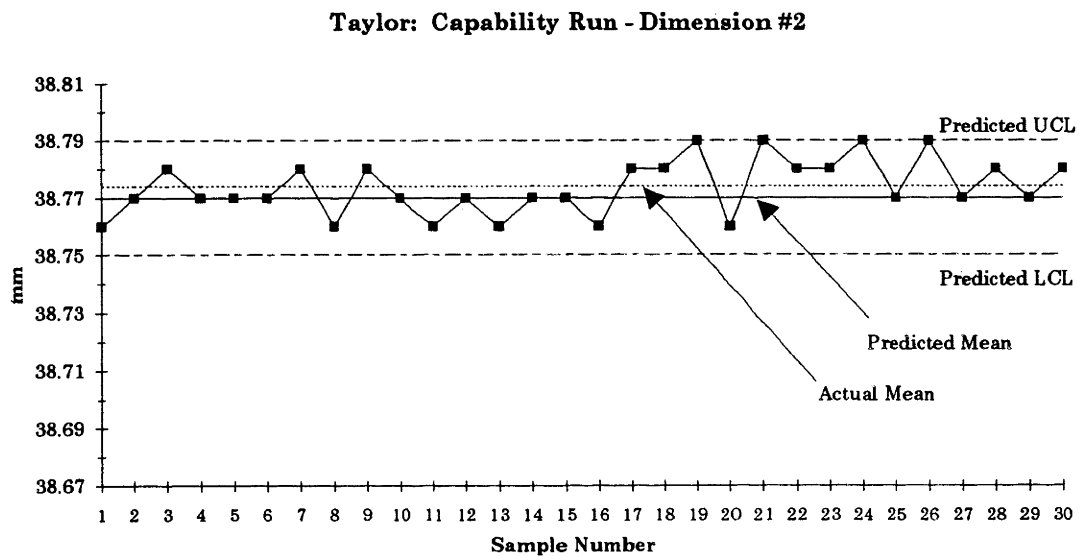

Figure 6-6: Single Cavity Mold, Dimension #2

As a measure of the ability of the process to manufacture product that meets specification, the UTA plants use the process-capability ratio, or " C_{pk} " (defined in Equation 6.1). Table 6-4 shows several values of the process

capability ratio, along with associated process fallout, expressed in defective or nonconforming parts per million (PPM). These process fallouts were calculated assuming a normal distribution for the quality characteristic, where the process mean is centered between the upper and lower specification limits--also known as C_p .²⁸

Process Capability Ratio	Defective PPM
0.25	453,255
0.50	133,614
0.60	71,861
0.70	35,729
0.80	16,395
0.90	6,934
1.00	2,700
1.10	967
1.20	318
1.30	96
1.40	27
1.50	7
1.60	2
1.70	0.34
1.80	0.06
2.00	0.0018

Table 6-4: Values of C_p and Associated Defective PPM

C_p does not take into account *where* the process mean is located relative to the specifications. C_p simply measures the spread of the specifications relative to the 6-sigma spread in the process. For example, the two normal distributions in Figure 6-7 both have $C_p=2.0$, but the process in panel (b) of the figure clearly has lower capability than the process in panel (a) because it is not operating at the midpoint of the interval between the specifications. This situation may be more accurately reflected by defining a

new process capability ratio, C_{pk} , that takes process centering into account. If $C_p = C_{pk}$, the process is centered at the midpoint of the specifications, and when $C_p > C_{pk}$ the process is off-center. It is usually said that C_p measures *potential capability* in the process, while C_{pk} measures *actual capability*.²⁹

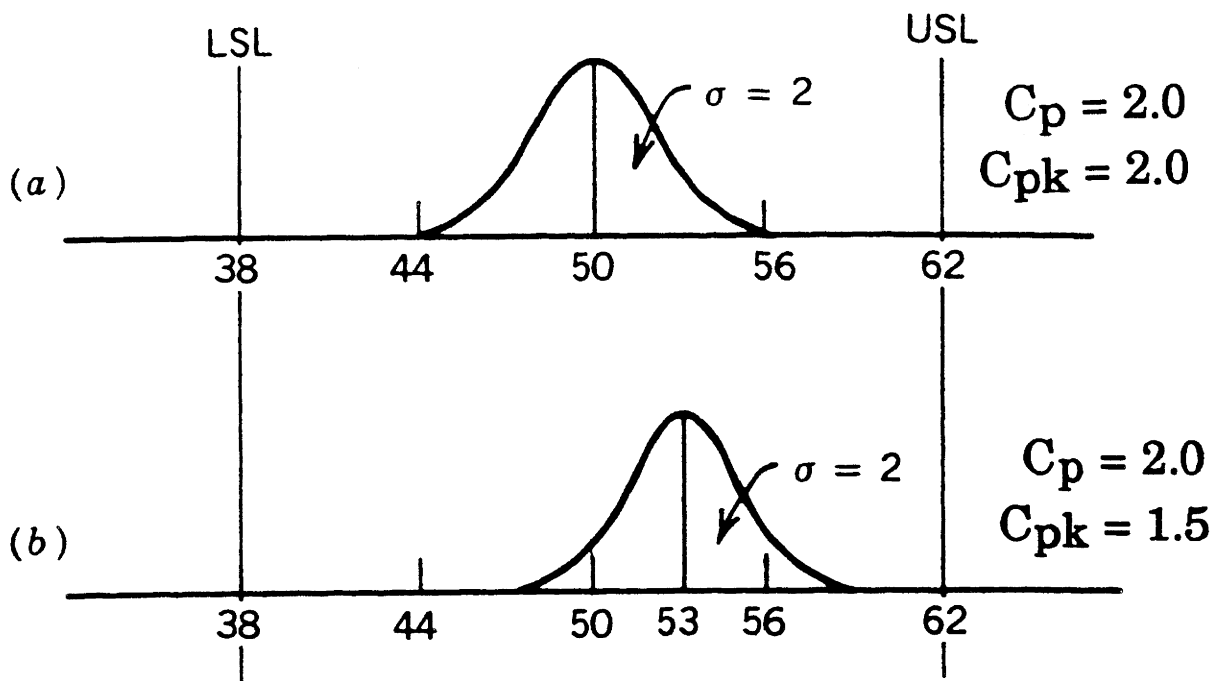

Figure 6-7: Relationship of C_p and C_{pk}

The plants have set a target of achieving a C_{pk} of 2.0 on all their processes. This goal is motivated by increasing customer demands and the high volume nature of injection molding for the automotive industry. The process capability measurement takes into account the mean and variability of the process and is calculated as shown below:

$$C_{pk} = \min [(USL - \mu)/(3\sigma), (\mu - LSL)/(3\sigma)] \quad (6.1)$$

where USL is the upper specification limit
 LSL is the lower specification limit
 μ is the mean of the process
 σ is the standard deviation of the process

To demonstrate the inherent process capability of the molding machine, one can calculate the C_{pk} using a centered process mean. Under these assumptions, calculation 6.1 is reduced to the following:

$$C_p = (USL - LSL)/(6\sigma) \quad (6.2)$$

Usually the process standard deviation σ is unknown and must be replaced by an estimate. To estimate σ , the sample standard deviation is typically used. The standard deviation for dimensions #1 and #2 on the 30 samples collected during the capability study was 0.01 mm. The specified tolerance for both dimensions was +/- 0.05 mm. Using these numbers, the inherent process capability for this part is 1.68, which corresponds to less than 1 defective part per million. This result demonstrates the benefits to be derived from ensuring that the tools are capable of producing the specified dimensions.

6.3 Four Cavity Mold

Most molds at the UTA Input Controls and Wire Systems molding plants are multi-cavity. While dimensional consistency becomes more challenging as the number of cavities increases, economic constraints often necessitate using multi-cavity molds. The same tool qualification procedure applied to the single cavity mold is used for multi-cavity molds. The time

required to complete data analysis increases, however, because additional measurements must be made. The analysis also includes a new topic -- the variability in dimensions across cavities.

The four cavity mold was borrowed from Taylor and qualified at the research center. It is one of a set of three identical molds currently producing a housing that fits in the steering column of a Chrysler vehicle (Figure 6-8). The housing subassembly is produced by the UTA Input Control's assembly plant in Juarez, Mexico. This experiment demonstrates that the tool qualification procedure may be used to diagnose mold problems on molds that have already entered production as well as molds that are new to the plant.

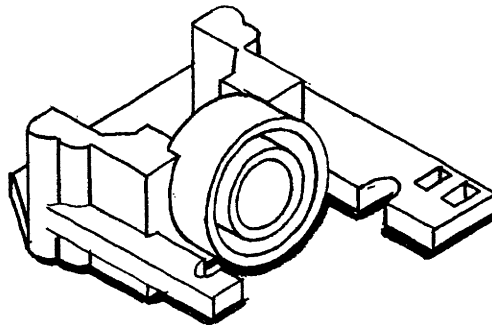

Figure 6-8: Part Produced by Four Cavity Mold³⁰

6.3.1 Design Preparation and Execution

Similar to the single cavity mold, two critical dimensions were chosen as the response variables. The potential for and impact of measurement error was reduced by selecting large dimensions that were easy to measure with calipers and by having one person make all the measurements. As in the last experiment, one dimension was in the direction of plastic flow and

one across the direction of flow, allowing estimates of shrinkage differentials to be made. For each of the 27 experimental runs, ten parts were collected and measured. For each dimension, the average measurement for each run was used as the response variable.

Unlike the single cavity mold, no standard deviations were incorporated as response variables. The optimization software would accept only twelve response variables and including the dimension standard deviations would require sixteen--2 dimensions and 2 standard deviations per cavity, for four cavities.

The process parameters selected were identical to those used in the first experiment. The levels for these parameters were selected based on material supplier recommendations for Minlon® 10B40 (white). The levels chosen for the process parameters are shown in Table 6-5. The final experimental design is given in Table 6-6. The design is identical to that used for the single cavity mold except for the fact that the five run conditions in the center of the experiment were ordered differently. This was done so that the three repeated center run conditions were not executed one right after the other and would, therefore, provide a better indication of the repeatability of the process. The response variable data is included in Appendix C.

<i>Process Design Parameters</i>	<i>LEVEL</i>		
	<i>low</i>	<i>midpoint</i>	<i>high</i>
Cooling Water Temperature (°F)	120	160	200
Nozzle/Barrel Temperatures (°F)	560/530/520/500	570/540/525/505	580/550/530/510
Injection speed (%)	15	30	45
Hold Pressure (%)	10	25	40

Table 6-5: Experimental Factors and Levels for Four Cavity Mold

Run #	Coolant Temp (°F)	Nozzle* Temp (°F)	Injection Speed (%)	Hold Pressure (%)
1	120	560	30	25
2	120	570	15	25
3	120	570	30	10
4	120	570	30	40
5	120	570	45	25
6	120	580	30	25
7	160	560	15	25
8	160	560	30	10
9	160	560	30	40
10	160	560	45	25
11	160	570	15	10
12	160	570	30	25
13	160	570	15	10
14	160	570	30	25
15	160	570	45	40
16	160	570	30	25
17	160	570	45	40
18	160	580	15	25
19	160	580	30	10
20	160	580	30	40
21	160	580	45	25
22	200	560	30	25
23	200	570	15	25
24	200	570	30	10
25	200	570	30	40
26	200	570	45	25
27	200	580	30	25

Table 6-6: Experimental Design Matrix for Four Cavity Mold

*Nozzle and Barrel Temperature Profile:

Heater	Low	Midpoint	High
HT1	560	570	580
HT2	530	540	550
HT3	520	525	530
HT4	500	505	510

6.3.2 Experimental Outcomes

As described for the single cavity experiment, once the experiments have been run and the response variables measured, the first step is to identify if the tool is capable of producing the dimensions specified by the customer. The customer has provided a target dimension and an acceptable tolerance on that dimension. The limits on the dimension are referred to as the upper and lower specification limits (USL and LSL). The ability of the tool to produce parts that meet the customer specifications can be quickly established by plotting the range of dimensions produced in the designed experiment against the specification and its limits. The dimensional results at each processing condition are displayed in Figures 6-9 and 6-10.

As in the last experiment, tremendous dimensional variation occurs when the process conditions change. In addition, dimensional variation across cavities is apparent. Looking at these charts, it is obvious that while dimension #1 consistently remains within the specification limits, dimension #2 does not at all conditions.

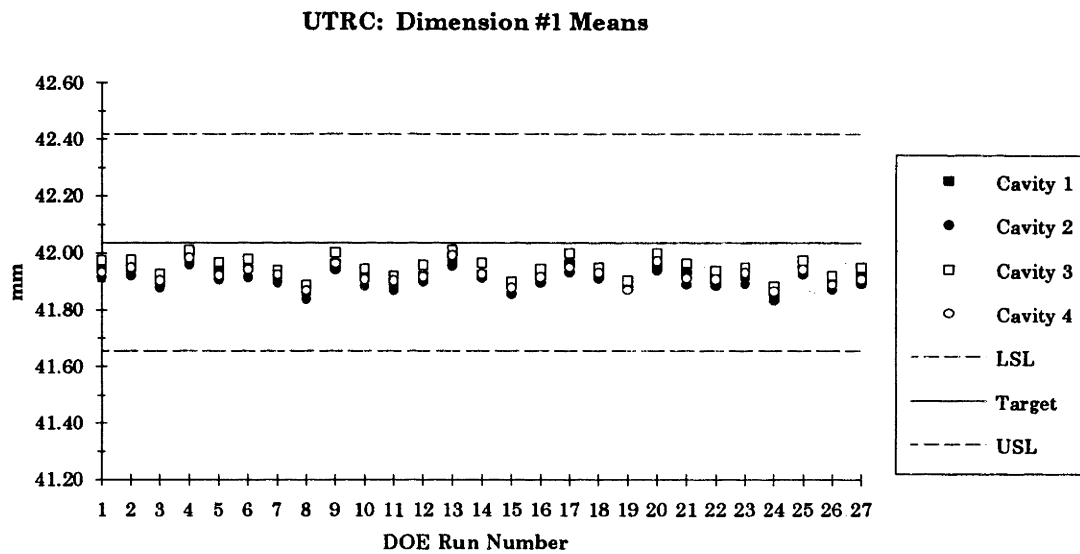

Figure 6-9: Four Cavity Mold, Dimension #1

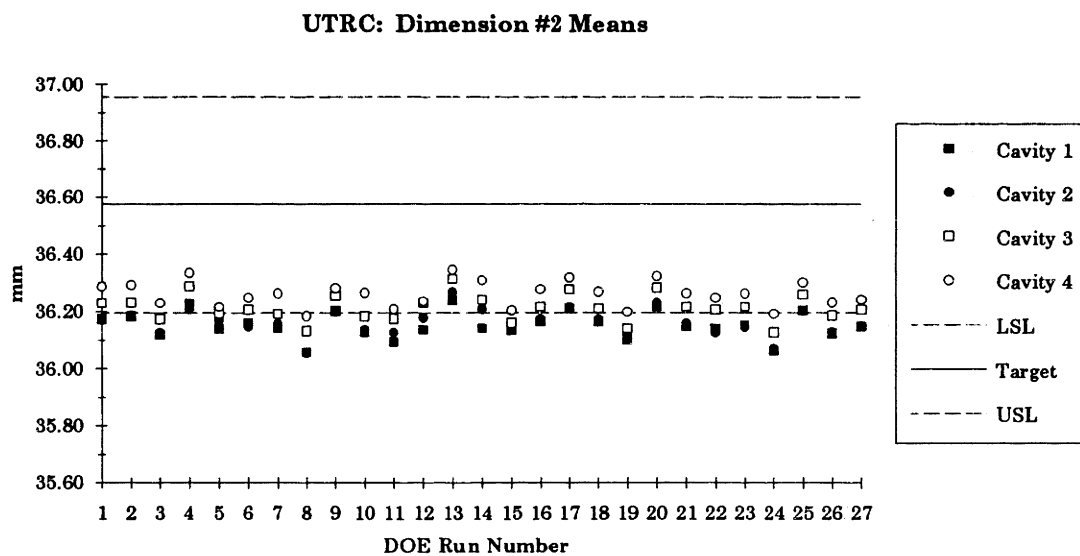

Figure 6-10: Four Cavity Mold, Dimension #2

While, ideally, mold diagnosis should take place at this point to uncover how to better center dimension #2, one can attempt to optimize the process so that dimension #2 will consistently fall just within the

specification limits. The dimensional data was correlated with the process conditions using statistical software.³² The data required by the software included the levels of the control factors and the corresponding response variable measurements for each run in the designed experiment and the target values of the response variables. In this case, the process was optimized based on two dimensions (optimizing to a point) for each cavity. The software attempts to move the response variables as a group close to their respective targets and suggests factor settings for the process to meet these targets. A capability study was performed using the predicted optimal processing conditions. Figures 6-11 and 6-12 show the results of these capability studies. The optimal conditions did indeed manage to bring both dimensions for all cavities within specification without mold modifications.

UTRC: Capability Run - Dimension #1

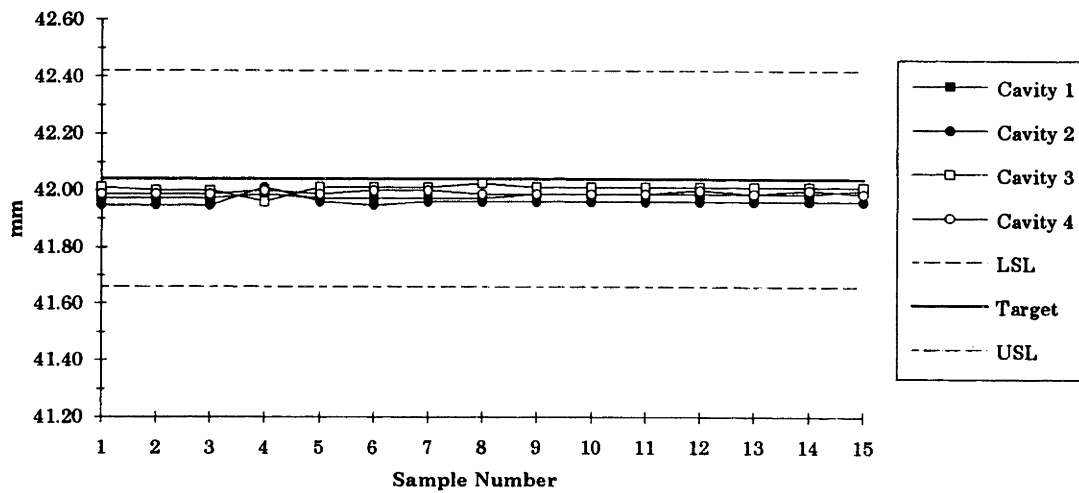

Figure 6-11: Four Cavity Mold, Dimension #1

UTRC: Capability Run - Dimension #2

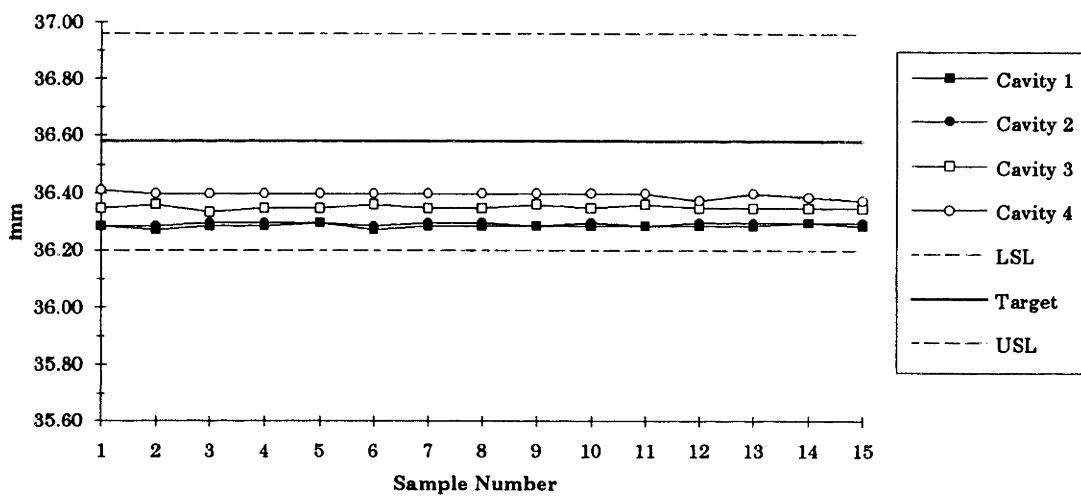

Figure 6-12: Four Cavity Mold, Dimension #2

As demonstrated for the single cavity mold, if the means of the part dimensions were centered within the specification limits, the process would be extremely capable. The actual process capability, however, meets the

plants C_{pk} target of 2.0 with plenty of margin. Such a large C_{pk} is a result of extremely wide specification limits, +/- 0.38 mm. Tight tolerance molding permits variations of only +/- 0.025 mm. Table 6-7 shows the potential process capability (if the means were centered) and the actual process capability for each dimension for each cavity.

	<i>DIM #1</i>				<i>DIM #2</i>			
	Cavity 1	Cavity 2	Cavity 3	Cavity 4	Cavity 1	Cavity 2	Cavity 3	Cavity 4
Process Sample Standard Deviation	.008	.015	.014	.006	.007	.006	.007	.010
Actual Process Capability Ratio	13.4	6.7	8.3	18.3	4.0	5.1	7.1	6.5
Potential Process Capability Ratio	15.8	8.4	9.0	21.1	18.1	21.1	18.1	12.7

Table 6-7: Four Cavity Mold, Process Capability Ratios

For a multi-cavity mold, variation in part dimensions across cavities must also be analyzed. Sometimes large variation across cavities, even when all cavities produce dimensions within the specification limits, is less desirable than a dimension that is out of specification but consistent across all cavities. This is the case for the eight-cavity mold discussed later in this chapter.

Figure 6-12 shows that once the optimal conditions have been established, there is little variation, within each cavity, in part dimension #2. This is further illustrated by the capability ratios for each cavity shown in Table 6-7. This means that the process is very capable. While cavities one and two produce very similar dimensions, cavities three and four both have significantly different means. Most of the variation in the mean across all cavities is now a result of tool design (i.e. dimensional or cooling differences

in the individual cavities). This conclusion is supported by the decline in process capability when the C_{pk} is calculated across cavities (Figure 6-13).³³

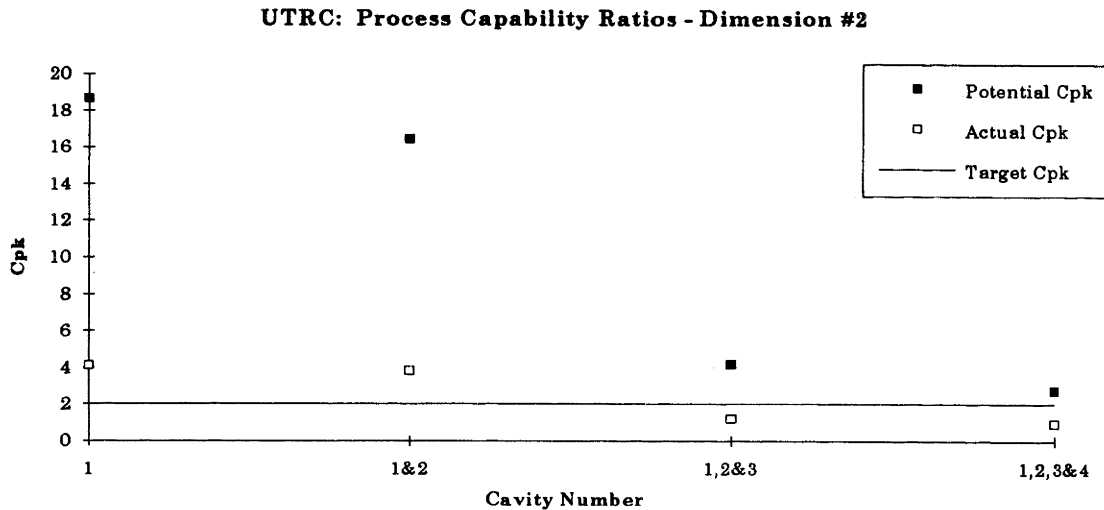

Figure 6-13: Four Cavity Mold, C_{pk}

6.4 Material Specific Results

The designed experiment is also useful for illustrating material properties and their impact on using process to modify dimensions. Both the single cavity and four cavity molds used Minlon® material. Minlon® is a mineral filled nylon which has a reduced shrinkage differential in and across the direction of flow.

The single cavity study demonstrates that, with this dimensionally stable material, dimensions in a single cavity are not independent. Figure 6-14 shows that if one dimension on a part does not meet specification, changing the process conditions to correct that dimension will also alter the other dimensions. The ability to correct the out of specification dimension with process will depend on the tolerances on the other dimensions.

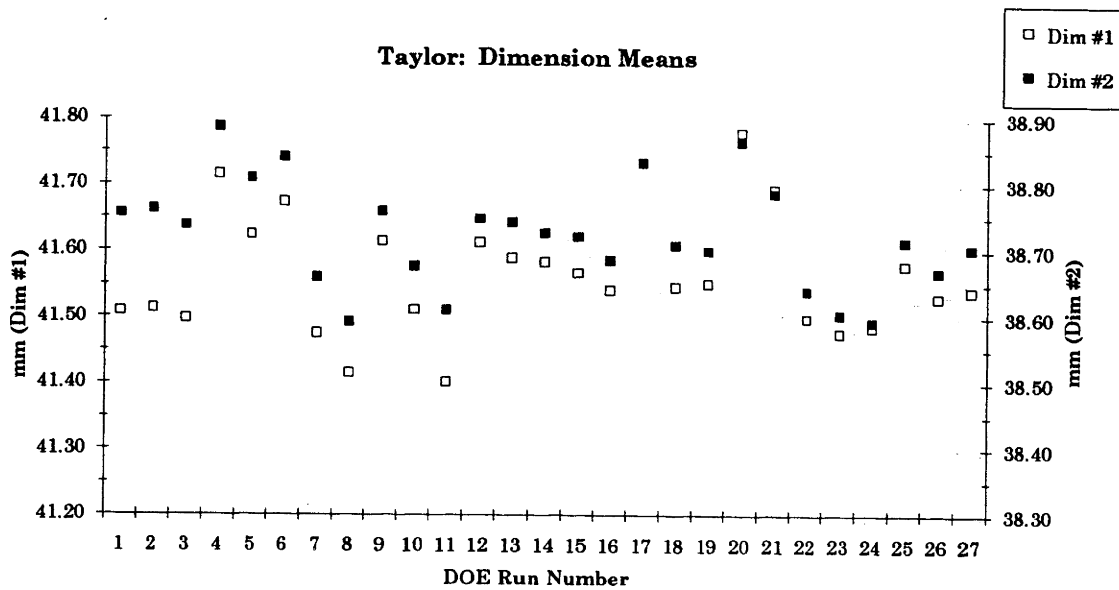

Figure 6-14: Single Cavity Mold, Dimension Interdependence

The four cavity study demonstrates that dimensions across cavities are not independent. The interdependence of dimensions across cavities leads to a parallel argument about the ability to correct a dimension in one cavity without adversely affecting that dimension in the other cavities (Figure 6-15).

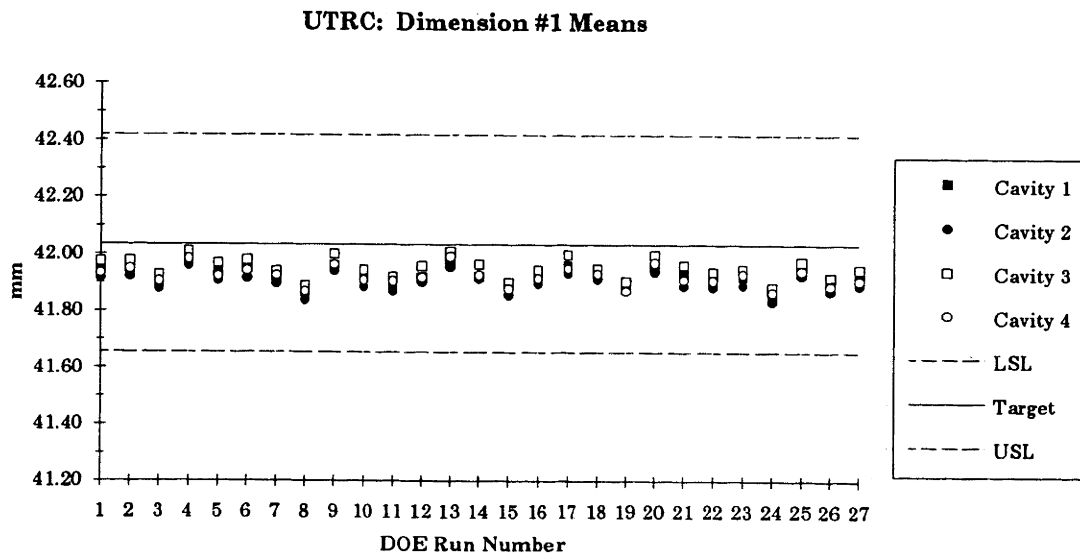

Figure 6-15: Four Cavity Mold, Dimension Interdependence

6.5 Eight Cavity Mold

The eight cavity mold produces a relay base which is found in both Ford and Chrysler vehicles (Figure 6-16). It is the largest volume production part at Taylor. The part is assembled at the Zanesville, Ohio Input Control's assembly plant.

Close to two years ago, Zanesville transformed their manual assembly operation to an automated line. One of the line set-up parameters is the distance between two slots on the relay base. The variation among the eight cavities is great enough that the line has to be set-up differently for each cavity number. While the assembly plant does not mind running eight batches of parts, it costs Taylor dearly.

When the molding machine opens at the end of the cooling cycle, all eight parts drop into a box below the machine. After one days production, about 10,000 parts have been produced. A technician, engineer, or even the plant manager will then sit under a bright light and sort the parts by cavity number.

The goal of running the designed experiment, therefore, was to identify if the variation could be reduced sufficiently to eliminate the need for sorting parts. The tolerance on the print, which specified a dimension of 6.55 ± 0.05 mm, did not reflect the increased demands of the automated assembly line. The engineer responsible for this part said that deviation from the target dimension would be tolerated if the variation in the means among cavities could be reduced to approximately 0.025 mm.

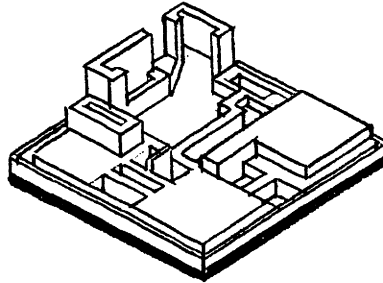

Figure 6-16: Part Produced by Eight Cavity Mold³⁴

6.5.1 Design Preparation and Execution

The critical dimension chosen as the response variable was the dimension used in the assembly line set-up. Only one dimension was chosen because it was clearly the most critical dimension and because choosing another dimension would increase the measurement effort by a factor of eight. In addition, the optimization software would accept a maximum of only twelve response variables.

The preferred method of measuring between the two slots was to use a coordinate measuring machine. The plant's coordinate measuring machine, however, was broken. The substitute technique was to use the shadow graph. This was a clearly inferior technique since significant set-up time is required to position the part before taking the measurement, and the distance between the two slots could not be directly measured. Four measurements were taken, from which the critical dimension could be calculated. While ten samples were collected for each of the 27 experimental runs, only 3 samples (24 parts) were measured. This required about 650

measurement set-ups and close to 2,600 measurements. Consequently, one individual could not make all the measurements. Measurements were made on three shifts by three different individuals.

The process parameters selected were identical to those used in the previous two experiments. The levels for those parameters were selected based on material supplier recommendations for 66480 Zytel (natural). The levels chosen for the process parameters are shown in Table 6-8. The final experimental design was identical to that shown in Table 6-6 and is included in Appendix C along with the response variable data.

<i>Process Design Parameters</i>	<i>LEVEL</i>		
	<i>low</i>	<i>midpoint</i>	<i>high</i>
Cooling Water Temperature (°F)	150	200	235
Nozzle/Barrel Temperatures (°F)	545/540/530/520	555/550/540/530	565/560/550/540
Injection speed (%)	50/50/40	70/70/60	90/90/80
Hold Pressure (psi)	500	700	900

Table 6-8: Experimental Factors and Levels for Eight Cavity Mold

6.5.2 Experimental Outcomes

The ability of the tool to produce parts that meet the customer specifications can be quickly established by plotting the range of dimensions produced in the designed experiment against the specification and its limits. The dimensional results at each processing condition are displayed in Figure 6-17.

It is quite obvious that the tool is incapable of producing parts which meet the specified target dimension. In addition, there is no run which produces a variation across cavity means of less than 0.025 mm.

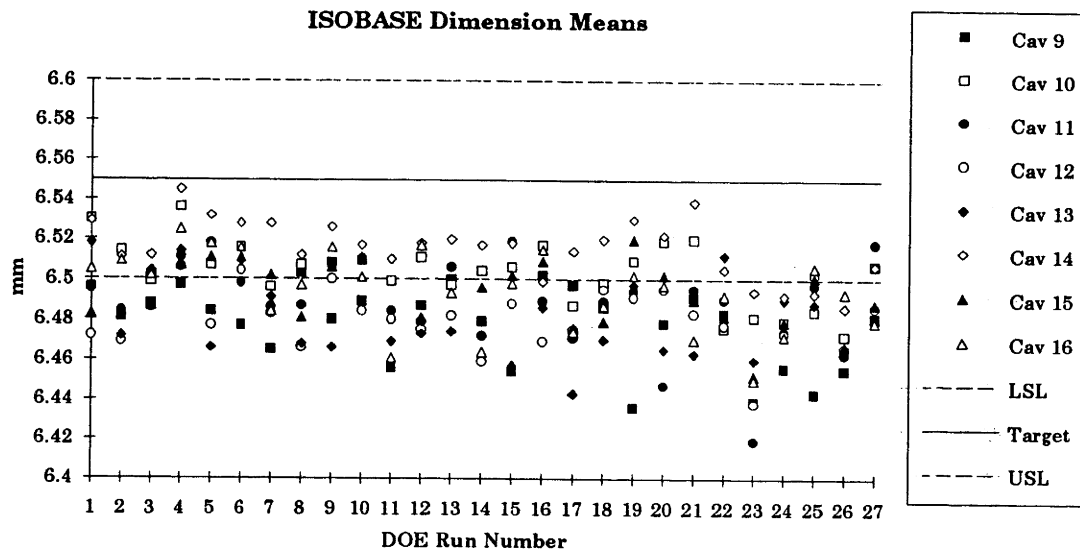

Figure 6-17: Eight Cavity Mold, Dimension Means

6.5.3 Mold Diagnosis

The use of designed experiments demonstrated to the plant personnel that changing process conditions alone was insufficient to satisfy the customer specifications. As a result, tool diagnosis was initiated. A layout of the critical dimensions showed that the major issue with this mold is one of poor tolerances in the mold. As can be seen in Figure 6-18, the range of values in the steel dimension across cavities is as large as the print tolerance for the part, ± 0.05 mm, and follows the same general cavity-to-cavity variation as was observed in part dimensions.

The current variation in tooling dimensions is considered unacceptable in this application. Part dimension tolerances of ± 0.05 mm on lengths of 5.0 to 8.0 mm demand tooling tolerances of ± 0.01 mm minimum. Dimensional tolerances of ± 0.025 mm (the tolerance actually required for the automated assembly line) demand tooling tolerances of ± 0.0075 mm.³⁵

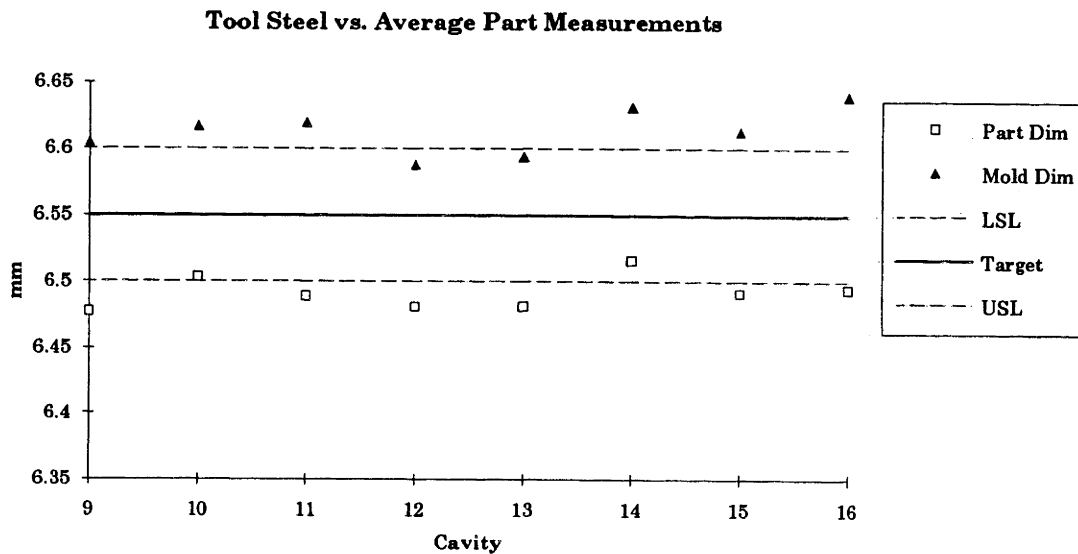

Figure 6-18: Eight Cavity Mold, Steel vs. Part Dimensions

Shrink actual values from the experiments are in the 1.4-2.1% range. Material supplier data estimate the shrink to be .4-1.1%. The discrepancy is probably due to small gate size, resulting in a large pressure drop and little packing pressure.

Suggested modifications for this dimension are to increase the dimension to 6.67 +/- 0.01 mm in all cavities. While the cavities could be "customized" as a result of the DOE, using a standard dimension across the tool will simplify tooling. This modification is much easier to specify since the process has been completely modeled using the tool qualification procedure. This modification assumes observed shrinkage; enlarging gates and/or runners may result in less shrinkage.

In addition to cavity modifications, the runner should be balanced. The current unbalanced runner system could also be contributing to the variation (Figure 6-19). Balancing the mold means eliminating non symmetrical runner elements.

The eight cavity experiment demonstrates the advantages of following a tool qualification procedure. These tooling variances would have been uncovered up front through a mold layout, and followed by process optimization. Even so, executing the procedure as a troubleshooting exercise, we were able to determine conclusively that the problem cannot be corrected through modifications to the process conditions.

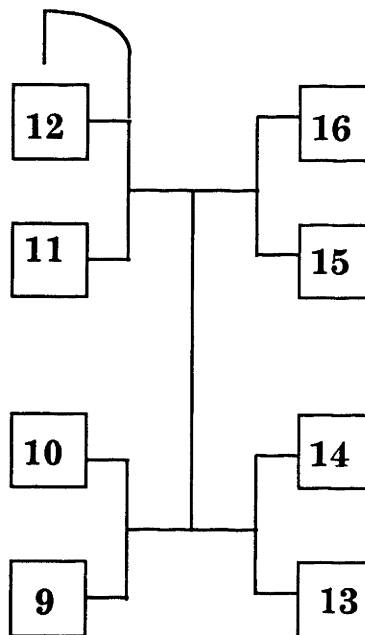

Figure 6-19: ISOBASE Cavity Layout

Chapter Seven

Conclusion

7.1 Summary of Results

This thesis demonstrates that a structured approach to tool qualification produces benefits in terms of both efficiency and effectiveness. The proposed experimentation and analysis requires approximately one week to complete. This represents about an 85% decrease in tool qualification time. In addition, the systematic exploration of the process window eliminates unnecessary mold modifications and non-optimal machine variable settings which often result from "dialing in" settings. Specifically, the proposed tool qualification procedure provides the following benefits:

- **Changes in machine settings map to changes in part quality.**

All molders recognize this fact, as demonstrated by the cycle of "dialing in" machine settings, collecting and measuring parts and then tweaking the settings in order to effect changes in part quality. The proposed procedure, however, allows one to accurately model the process to determine exactly the magnitude of effect on part quality that changing a machine setting will have.
- **Need for mold modifications can be identified.**

The mapping of part quality to machine settings also establishes the boundaries on using process to correct part dimensions. As was shown in the single cavity mold, dimension #1 could not be brought within specification using the process, while dimension #2 could. Therefore, unnecessary mold modifications will be avoided using this method, and

a precise understanding of the mold modifications necessary can be achieved.

- **Optimal process conditions can be established.**

This procedure uses designed experiments and analysis to efficiently identify the optimal processing window, as opposed to an iterative procedure of guessing during tool qualification time.

- **Relationships between dimensions can be identified.**

Changes in machine settings which produce a change in one part dimension usually have some effect on other part dimensions. These relationships can be quantified and used for optimization and mold modification.

- **Process stability may be determined.**

Some processing conditions are more stable than others. The information gathered during the DOE and process capability runs will provide an indication of the process capability. This, in turn, will indicate if advanced methods of process control will be necessary for tight tolerance/high C_{pk} molding.

7.2 Critical Success Factors for Methodology

The strength of this tool qualification procedure lies in its ability to accurately map the process variables to part quality. The expression which relates part quality--i.e. part dimensions--to a particular process variable is often more complicated than a simple linear equation. It is therefore necessary to appropriately define the process variable range to be tested in

order to correctly evaluate the correlation between part quality and machine settings. The molder can safely assume that he has chosen a wide enough range if he uses the min and max settings specified by the material supplier. While machine control would allow settings outside this range to be tested, the complex composition of commercial plastics results in narrowly defined process specifications. It is probably unwise for the molder to use settings outside the range specified by the material manufacturer because it may result in degradation of material properties.

In order to successfully identify the optimal machine settings, a complete set of response variables must be evaluated. The studies conducted during the internship used only one or two critical dimensions per cavity partially because of limits imposed by the software; the software used would accept a total of only 12 response variables. There is, however, software available that will accept a much larger number of response variables.

The molder must balance the information content provided by a large number of response variables with the measuring effort involved to evaluate these variables. Efficient measuring devices such as a coordinate measuring machine will allow many part dimensions to be quickly evaluated. When the print for the part specifies twenty-five critical dimensions, the molder must involve the part and tool designer in narrowing the number of response variables. A subset of critical dimensions would have to be defined eventually to allow periodic quality checks to be made when the mold is running production. The dimensions selected should be those most critical to part function and/or those that have the greatest tendency to vary with process changes. The latter might be established by collecting and measuring samples for three different run conditions--all machine settings at their minimum value, midpoint value and maximum value. The dimensions

which exhibit the greatest variation between runs should be selected as the response variables.

7.3 Future Work

Future work in tool qualification by UTRC will focus solely on implementation of these or similar procedures at manufacturing facilities of UTA. This will include establishment of experimental design procedures, data acquisition and analysis capabilities, and training in the use of in-mold cavity sensors.

Reducing tool qualification time from up to six weeks to one week represents a significant improvement in the time required to produce production capable processes. However, to really shorten the time required to bring new products to market, the focus should be placed on simultaneous engineering and rapid prototyping to accelerate and ensure a quality part is delivered quickly.

An area that might be addressed is the use of mold filling simulation in part design to both identify potential design problems when modifications are least costly and to educate part designers in design rules for plastic. Mold filling software might also be an effective tool for helping mold designers locate cooling passages. Unbalanced cooling is a difficult problem to correct when the steel has been cut. Tool makers who don't use mold filling software point to their inability to model complex geometries quickly and accurately. This argument would disappear if part designers adopted the use of mold filling simulation; the part geometry files created by the part designers could be transferred to the tool designers/makers. In general, there must be closer communication among part designer, tool designer/maker,

molder and tool maintenance person for the efficient transfer of knowledge to occur.

In conjunction with efforts to shorten the product development cycle time, methods which will increase the capability of production processes will be studied. The demand for more capable processes is driven by the advent of tight tolerance molding and by customers' increasingly stringent quality requirements. Customers are demanding zero rejects. Given the high volume nature of injection molding, it is not feasible to inspect every part. Process monitoring allows process deviations which correlate to quality loss to be identified and, in combination with a part diverter on the molding machine, allows bad parts to be rejected at the machine. Advanced control techniques which permit on-line viscosity correction are also being studied.

Endnotes

¹A. Shankar and F.W. Paul, "A Mathematical Model for the Evaluation of Injection Molding Machine Control," Transactions of the ASME, Vol. 104, March 1982, p. 86.

²Ibid.

³Dominick V. Rosato and Donald V. Rosato, Injection Molding Handbook (New York: Van Nostrand Reinhold Company, 1986), p. 92.

⁴M.L. Berins, SPI Plastics Engineering Handbook (New York: Van Nostrand Reinhold Company, 1991), pp. 154-155.

⁵Ibid, p. 158.

⁶Dominick V. Rosato and Donald V. Rosato, Injection Molding Handbook (New York: Van Nostrand Reinhold Company, 1986), p. 505.

⁷Ibid, p. 637.

⁸Ibid, pp. 635-636.

⁹Suzanne Woll, "Development of a Pattern Classifier for Use in a Novel Injection Molding Control," Fall 1992.

¹⁰Dominick V. Rosato and Donald V. Rosato, Injection Molding Handbook (New York: Van Nostrand Reinhold Company, 1986), pp. 190,360.

¹¹Figure 2-17 displays the results of an experiment conducted at UTRC. The mold used in the study has four identical cavities which produce wiring harness connectors. The material used was Noryl. Different levels of regrind were produced by mixing different proportions by weight of virgin material and 100% regrind material--provided by the UTA Peru plant from which the mold was borrowed. The average part weight was determined by weighing the four parts produced in a single shot and averaging these weights.

¹²United Technologies 1991 Annual Report, p. 25.

¹³Carl Kirkland, "Injection Control: Open- or Closed-Loop?," Plastics World, February 1992, p. 24.

¹⁴D. Weissmann, "Mold Filling Simulations--Do They Provide the Needed Answers?," In Search of Excellence Annual Technical Conference, ANTEC '91 Conference Proceedings v 37 (Brookfield, CT: Society of Plastics Engineers, 1991), pp. 264-266.

¹⁵A. T. Sajan, "An Evaluation of Mold Filling Analysis on an Injection Molded Exterior Product," In Search of Excellence Annual Technical Conference, ANTEC '91 Conference Proceedings v 37 (Brookfield, CT: Society of Plastics Engineers, 1991), pp. 2663-2669.

¹⁶Ioannis Pandelidis and Qin Zou, "Optimization of Injection Molding Design. Part I: Gate Location Optimization," Polymer Engineering and Science, Mid-August 1990, Vol. 30, No. 15, pp. 873-882.

¹⁷Ron D. Douglas, "Injection Molding of Electrical Parts in Today's Materials," Proceedings of the 19th Electrical Electronics Insulation Conference, IEEE 1989, pp.133-136.

¹⁸E. C. Bernhardt and G. Bertacchi, "Quality Molding by Design," Annual Technical Conference, ANTEC '89 (Brookfield Center, CT: Society of Plastics Engineers, 1989), pp. 299-302.

¹⁹Carl Kirkland, "Injection Control: Open- or Closed-Loop?," Plastics World, February 1992, pp. 24-30.

²⁰M.L. Berins, SPI Plastics Engineering Handbook (New York: Van Nostrand Reinhold Company, 1991), pp. 155-156.

²¹Dominick V. Rosato and Donald V. Rosato, Injection Molding Handbook (New York: Van Nostrand Reinhold Company, 1986), p. 637.

²²Ibid, pp. 190,360.

²³Madhav S. Phadke, Quality Engineering Using Robust Design (Englewood Cliffs, NJ: Prentice Hall, 1989), p. 135.

²⁴Stephen R. Schmidt and Robert G. Launsby, Understanding Industrial Designed Experiments (Colorado Springs, CO: Air Academy Press, 1988), p. 3-33.

²⁵Ibid, p. 3-24.

²⁶Sketch by Charles Bajnai, April 21, 1993 (Rhode Island School of Design).

²⁷M.L. Berins, SPI Plastics Engineering Handbook (New York: Van Nostrand Reinhold Company, 1991), p. 162.

²⁸Douglas C. Montgomery, Introduction to Statistical Quality Control (New York, NY: John Wiley & Sons, 1985), p. 372.

²⁹Ibid, pp. 373-374.

³⁰Sketch by Charles Bajnai, April 21, 1993 (Rhode Island School of Design).

³¹The output of the BBN Catalyst software package, which maps the process conditions to the part dimensions, is included in Appendix C.

³²When C_{pk} is computed for cavity #1, the mean and standard deviation are calculated using only the measurements for cavity #1 samples. When C_{pk} is computed across cavities #1 and #2, the mean and standard deviation are calculated using the measurements for cavity #1 and #2 samples. C_{pk} across cavities #1, #2, and #3 uses measurements for cavity #1, #2 and #3 samples. C_{pk} across cavities #1, #2, #3 and #4 uses measurements for cavity #1, #2, #3 and #4 samples.

³³Sketch by Charles Bajnai, April 21, 1993 (Rhode Island School of Design).

³⁴Dominick V. Rosato and Donald V. Rosato, Injection Molding Handbook (New York: Van Nostrand Reinhold Company, 1986), p. 270.

Appendix A

Competitive Benchmarking Summary

Kristine Budill

Fall 1992

Interviews with:

C&J Industries

Eastman Kodak

Intesys Technologies

Monsanto Applications Development Center

Paulson Training Programs

RJG Technologies

Part Design

Need to educate part designers about design rules for plastic

- Several individuals mentioned that part designers have not adapted their designs to satisfy the constraints of plastic material; they are not taking advantage of the unique design opportunities plastic offers and/or they are imposing unrealistic constraints on the process (e.g. still use steel tolerancing).
- Mold filling simulation was highly recommended for the part design stage. One individual mentioned its use in identifying where weld lines would form. These software packages may be the best way to communicate to the designers the design rules for plastic.

Part designers must be committed to concurrent engineering

From the custom molders point of view, they are somewhat at the mercy of their customer (the part designer) for how involved they become in part design. In the worst case, a molder may become involved in the project after even the tool has been designed and built. Everyone interviewed expressed that the part designer, tool designer/maker, molder and tool maintenance person must constantly interact, starting when there is only a product concept. One individual interviewed believed that when this cross functional team is assembled, most design problems can be brought to the surface and solved in about one hour.

Material

Must establish a system which allows you to deliver consistent material to the injection molding machine

- The importance of this recommendation is highlighted by the report from one individual surveyed that two-thirds of their quality problems are a result of material fluctuations.
- No one material handling system emerged as the clear winner; even within a single plant, mixed strategies were evident. The selection of which strategy is appropriate for your plant depends on your ability to maintain the system chosen. The systems suggested include the following:
 - Cascading Systems (i.e. no mixing of virgin and regrind materials)
 - Batch mixed material delivered in tightly sealed containers
 - sometimes using regrind repelletized by a material reprocessor
 - Proportional loaders at the machines
 - some people mentioned using very accurate proportional loaders, both commercially available and patented systems
 - one person described a closed system where a machine is dedicated to certain material and regrind generated at the machine is fed directly back into the process
 - another manufacturer only uses proportional loaders when the regrind generated per shot is less than 10% of the shot weight

Mold Design

An excellent molder need not be an excellent tool maker, but must be able to specify balance and cooling

- Several respondents compared tool design to a coarse adjustment knob for producing quality parts and process design to a fine adjustment knob. Specifically, they believe there is very little, if anything at all, that process design can do to correct for unbalanced or poorly cooled tools.
- Most individuals interviewed suggested using mold filling simulation during tool design. One person mentioned its use in optimizing the gate location. I am not sure of its utility for investigating balanced cooling but suggest it be used in this role if it provides meaningful results. Those tool makers who don't use the mold filling software pointed to their inability to model complex geometries quickly and accurately. It seems that this argument would disappear if the part designers created the part geometry files.

Economic analysis over the life of the tool is needed to encourage higher initial investment for better tool design

- One molder who is also a tool maker will sometimes spend more than their competitive quote to build a better tool because they will more than recover this extra investment during production with higher yields.
- To demonstrate the boundaries on how high this initial investment might have been, use the injection molders records on total dollars invested in tool modifications over the life of the tool.
- If detailed tool modification records are kept, this information could also be fed back to part and tool designers to help them improve their designs for the production environment.

Reduction in tool design/build cycle time can be improved with cross functional sharing of information

- Reducing development cycle time is a hot topic. One tool maker/molder was able to make headway in this area. They can accept part designs electronically from customers and build molds from those designs.
- Also if the mold filling software is as good as its owner's commercials claim, the ability to do part and tool design right the first time, with only one time consuming modeling exercise, sounds like a significant time savings.

Mold Design (continued)

Build in appropriate tool wear characteristics by understanding the plastic material properties and production quantities

- By understanding the abrasiveness of the materials they run, one tool maker/molder has essentially eliminated tool wear by using a titanium coating on the mold cavities.
- For molds that run less abrasive materials, a chrome plating which changes color when dipped in copper sulfate solution has been used to diagnose the very first hint of tool wear.

Building complexity into the mold also increases complexity of process control

This comment was motivated by the opinions I received on recommended number of cavities per mold and use of cold or hot runners. One consultant recommended one cavity molds and use of cold runners only. He supported his recommendations by saying that: 1) one cavity molds have the highest shear rates, are easiest to flow and maximize part consistency and 2) hot runners are difficult to keep balanced. On the other hand, a manufacturer of a dimensionally simple product was satisfied with the performance of 48 cavity molds and said that from an economic standpoint hot runners are a must for this mold. Obviously neither individual has all the answers. We can conclude, however, that the concurrent engineering team should analyze how far their particular part will push the limits of process control if produced with a one cavity, cold runner mold before going to a higher number of cavities and hot runners.

Use tool qualification to verify that the tool design meets your requirements

- One molder begins tool qualification with a capability study on critical part dimensions. The capability measurement reflects variation across all cavities, not only variation within a single cavity. Critical dimensions are selected by both the customer and the molder. The customer selects critical dimensions from an applications point of view--dimensions which affect functionality. The molder selects critical dimensions from a processing point of view--dimensions which show the greatest variation during production.
- Another molder who identified lack of balance as the number one problem for multi-cavity molds begins tool qualification with a balance analysis. The balance analysis, described below, is much cheaper than dimensional studies.

Mold Design (continued)

Balance Analysis

- Step 1: Conduct short shot analysis - find fill time which produces only one full cavity (don't worry about sink)**
- Step 2: Collect 10 shots at this fill time.**
- Step 3: Calculate the average % incomplete for each cavity, i**
For each cavity, i, and for each of the 10 shots, calculate:
 $(\text{full cavity's weight} - \text{cavity } i \text{ weight}) / \text{full cavity's weight}$
For each cavity, i, calculate an average value over the 10 shots
- Step 4: Plot the average % incomplete for each cavity**
- Step 5: Modify tool if it does not have acceptable balance**

Process Design

Mold filling analysis for process design is not recommended

Not one respondent suggested using mold filling software during the process design stage. One person said that they don't use the software for process design because the simulation programs contain poor process assumptions. Another respondent said that the only value in using mold filling analysis during process design is if you are committed to changing part or tool design.

Use process variables to predict part quality

- When asked what measures of part quality they used, most molders listed dimensions, warp, visual appearance, and gage fit. The most innovative, however, spoke of their ability to predict if a good part had been produced by monitoring the process variables. One molder said that they have been able to relate critical part dimensions to certain process variable values. They can, therefore, maintain quality parts with process control--i.e. they don't monitor the parts; they monitor the process variables. A consultant spoke more specifically of his ability to correlate cavity pressure to part constraints and thus to know if parts are good before they come out of the mold by monitoring cavity pressure.
- As a result of this line of questioning, discussions of weight as a quality measure emerged. The most complete discussion had this to say. Weight is a practical, fast, and low cost metric for implementing SPC. Weight data can also be used for process analysis to expose "assignable causes" and other process characteristics. Weight data can sometimes be used for "product aimpoint control" because sometimes some characteristic of the molded product will correlate highly with the absolute value of part weight. Process variables are still the way to go.

There are four important process variables to monitor

- The four most frequently monitored process variables are:
 - fill time -- cavity pressure
 - mold temp -- melt temp
- Other variables listed as important to monitor were hydraulic pressure, barrel temp (most likely in lieu of melt temp), positions, and times. One person commented, however, that overmonitoring process variables reduces the value of doing it all. I believe this comment was motivated by his belief that the incremental cost of monitoring certain variables is higher than the value of their information content.

Process Design (continued)

Using switchover on cavity pressure may reduce the machine dependence of control settings

- One consultant stated that process control is mold-machine independent if accomplished from the plastic point of view. He was also one of two people who proposed velocity control with switchover on cavity pressure. Another molder stated directly that process control is not mold-machine dependent if you can sense cavity pressure at the front and end of fill. We also have come across a paper by Kistler Instruments which uses cavity pressure to find the optimal processing window.
- When dealing with multi-cavity molds, two strategies for where to sense cavity pressure were suggested: 1) if the mold is balanced, use runner pressure and 2) use cavity pressure in the cavity with the greatest pressure fluctuations.

It is very critical to have consistent cooling line hook-up

This can be accomplished by labeling the in and out ports on the mold and recording the number of hoses to be used and their lengths.

Dedicate machines to materials to reduce contamination and need for time consuming material change-over

Operate injection molding machines in a temperature and humidity controlled environment

Appendix B

Suggested Tool Qualification Procedure

Kristine Budill

December 18, 1992

Contents

Pre-Processing Qualification

Establishing Set-Up Procedures

DOE Preparation

Running and Analyzing DOE

Establishing Mold/Machine Capability

Diagnosis of Tool Problems

References

- 1) **Injection Molding Handbook**, edited by Dominick V. Rosato and Donald V. Rosato, Van Nostrand Reinhold Company, New York, 1986.
- 2) **Quality Engineering Using Robust Design**, Madhav S. Phadke, Prentice Hall, Englewood Cliffs, NJ, 1989.
- 3) **Introduction to Statistical Quality Control**, second edition, Douglas C. Montgomery, John Wiley & Sons, New York, 1985.

Tool Qualification Procedure

Pre-Processing Qualification

Layout Mold, all cavities, to establish dimensional consistency

Several variables in the injection molding process can affect the dimensions of the plastic part; therefore, the mold must be manufactured within a small percent of the tolerance allowed on the plastic part. Table 1 shows the tolerance allowed to the moldmaker according to the tolerance and size of the plastic part. (ref. 1, p. 269)

Table 1: Dimensional tolerances allowed to moldmakers. (ref. 1, p. 270)

Print Dimension	Plastic Tolerance	Mold Tolerance
	+/- .002 in.	+/- .0004 in.
0.0 to 1.0 in.	.005	.00125
	.010	.0025
	.020	.006
1.0 to 2.0	.005	.0005
	.010	.003
	.020	.006
2.0 to 3.0	.005	.001
	.010	.003
	.020	.006
3.0 to 5.0	.005	.001
	.010	.003
	.020	.006
	.030	.009
5.0 to 8.0	.010	.003
	.020	.006
	.030	.009
8.0 to 12.0	.010	.003
	.020	.006
	.030	.009
	.040	.012
12.0 to 16.0	.020	.006
	.030	.009
	.040	.012

Interchangeable mold components must be produced to even closer tolerances, usually +/- .0001 inches nonaccumulative. (ref. 1, p. 271)

Establishing Set-Up Procedures

Select machine with appropriate barrel size and clamp capacity

- Select barrel with correct weight and plasticizing capacities

Rule of Thumb: The shot weight is generally taken to be 75 to 80% of the shot capacity of the machine. (ref. 1, p. 169)

Unfortunately it is not always possible to size the mold with the machine. The lower the shot size as a percent of machine capacity, the longer the residence time. This means that degradation is more difficult to control and quality problems due to the greater temperature gradient of the melt off the screw are more apt to occur. (ref. 1, p. 590)

To establish if barrel size is acceptable:

- 1) Calculate shot size as a percentage of rated machine capacity.
- 2) Approximate cycle time.
- 3) Decide if average residence time is appropriate for the application.

Verify that the required plasticizing capacity (shot weight x the estimated number of shots per minute) is less than the plasticizing capacity of the machine. (ref. 1, p. 169)

- Select Machine with Sufficient Clamp Capacity

Rule of Thumb: Good molding practice requires about three tons (2000 psi = 1 ton) of clamp for each square inch of projected area of the molded shot. (ref. 1, p. 171)

To calculate required clamp capacity use the following equation (ref. 1, pp. 170-171):

Minimum clamping force = Projected area x plastic cavity pressure

- Projected area is defined as the area of the shadow cast by the molded shot when it is held under a light source with the shadow falling on a plane surface parallel to the parting line.
- For a given plunger pressure, the actual pressure developed within the cavity varies directly with the thickness of the molded section, and inversely with the melt viscosity.
- Consider including a safety factor of about 10 to 20 percent.

Calculated against the mold clamping force, the total projected surface area of the moldings must not exceed the machine's maximum permissible molding area when subjected to injection pressure. (ref. 1, p.170)

Issue cooling line schematic that minimizes cycle time and maximizes cooling uniformity

Rapid cooling improves process economics, while uniform cooling improves product quality by preventing differential shrinkage, internal stresses, and mold release problems. (ref. 1, p.189)

• **Maintain turbulent flow conditions in the mold**

The water flowing through the cooling lines removes heat from the mold wall and carries it out of the mold to the Thermolator where it is returned to the plant water system. The efficiency with which heat is removed is a function of the velocity of the coolant flow. Other things being equal, the greater the velocity of coolant flow, the greater the heat transfer from the mold to the coolant. After a certain point, however, increasing coolant velocity does not appreciably improve heat transfer from the mold.

At low coolant velocities, coolant flow will be laminar. In laminar flow, the coolant moves in layers parallel to the walls of the coolant passage; each thermal layer acts as an insulator, impeding heat transfer from the mold to the stream of coolant. In contrast, turbulent flow, the desired condition, creates random movement of coolant and substantially increases heat transfer. However, once turbulent flow conditions are reached, higher coolant velocities bring diminishing returns in improved heat transfer. (ref. 1, p. 369)

Turbulence of coolant is quantified by a dimensionless Reynolds number. It is directly proportional to cooling velocity and passage diameter, and is inversely proportional to coolant viscosity. The formula is as follows:

$$N_{Re} = (Vdp)/\mu$$

where N_{Re} is the Reynolds number
 V is the coolant velocity
 d is the coolant passage diameter
 p is the density of the fluid
 μ is the viscosity of the fluid

Reynolds numbers of up to 2300 indicate laminar flow. There is a transition zone between laminar and turbulent flow that is defined by Reynolds numbers ranging from 2300 to 3500. Reynolds numbers above 3500 indicate turbulence. (ref. 1, pp. 369, 195)

Most Common Mistake Made:

Processors run their coolant at too low a temperature, which may actually reduce cooling effectiveness instead of increasing it. (Lower temperatures increase viscosity which decreases Reynolds number.) In a large number of cases, they would actually be better off running at a higher temperature and a higher flow rate (gpm). In practice, a Reynolds number of at least 4000 should be achieved in the injection molds for efficient heat removal. (ref. 1, p. 370)

- **Maintain uniform heat transfer**

The efficiency of a large number of existing molds can be increased by checking them against the recommendations listed below. (ref. 1, pp. 368-369)

Number mold inlets and outlets and record length and diameter of the hoses to ensure consistent hook-up set-up after set-up.

Coolant channels should be cleaned before plumbing to the cooling system.

The cross-sectional areas of the cooling lines in each circuit should be uniform. Changes in diameter cause imbalance and losses in the coolant stream.

Cooling line length should be no more than 4 to 5 feet at the maximum, depending on the efficiency of mold cooling. Where cooling is less efficient, the length should be shortened to avoid introducing thermal gradients at the mold surface.

The inside diameter of the hoses should be at least as large as, or preferably larger than, the coolant line diameter in the mold to avoid a pressure drop and loss of cooling efficiency. (ref. 1, p. 360)

The length of these hoses should be kept to an absolute minimum.

Counter-bore coolant lines for pipe fittings with inside diameter equal to or greater than the diameter of the coolant line.

Quick disconnects must not restrict flow; oversize disconnects are required on all coolant lines.

The supply and return manifolds should have low pressure drop for proper distribution of coolant in all coolant channels. The manifolds should be sized for velocities between 2 and 3 ft/sec.

All piping should be insulated to reduce the ambient losses.

Connect the inlets and outlets for each cavity in parallel to their source of supply given that the pump can meet the required flow rates. Too many waterlines in series can cause high pressure drops and uneven mold surface temperatures due to high temperature rise of the coolant. (ref. 1, pp. 190, 360)

THE PLANT MUST HAVE A SCHEMATIC OF THE MOLD COOLING CHANNELS FOR USE IN TROUBLESHOOTING MOLD PROBLEMS.

Determine Recycle Percentage to be lesser of:

- 1) an exact sprue-runner/shot weight ratio or
- 2) maximum percentage allowable for application properties.

DOE Preparation

Identify critical part dimensions and other properties that will be the response variables

The response variables, also referred to as *quality characteristics*, should be selected in accordance with the following guidelines. (ref. 2, p. 135)

The quality characteristics chosen should directly affect the part function or assembly methods specified by the customer.

As far as possible, choose continuous variables as quality characteristics.

Try to use quality characteristics that are easy to measure. Availability of appropriate measurement techniques often plays an important role in the selection of quality characteristics.

Ensure that quality characteristics are complete—that is, they should cover all the requirements for the plastic part.

Finding quality characteristics that meet all of these guidelines is sometimes difficult. However, the Robust Design experiment will be inefficient to the extent these guidelines are not satisfied.

Determine shot size which:

- 1) fills all cavities
- 2) maintains a cushion

Establish switchover position based on cavity pressure trace

Switchover should occur just before cavity pressure begins its greatest acceleration. The area of greatest acceleration is represented by the maximum slope on the cavity pressure trace.

Determine holding time based on shot weight

Holding time should only be as long as time until gate freeze-off. When the gate freezes, no more plastic can be injected into the cavity. To determine gate freeze-off/holding time, increase holding time until shot weight just stabilizes.

Identify the critical process parameters that will be the input variables

By definition, the input variables, also referred to as *control factors*, are:

- 1) factors whose levels can be selected by the designer.
- 2) factors which influence a distinct aspect of the molding process.

Shown below are the critical process parameters and associated control factors for the DOE. The critical process parameters in injection molding are well established and do not vary from part to part. In order to use these process parameters as control factors in the designed experiment, they must be variables which can be adjusted with machine settings (condition #1 above). Since we cannot directly set mold temperature, melt temperature, and cavity pressure, we have chosen as the control factors the machine variables which most directly affect the critical process parameters identified.

In order to make the experimentation more efficient, we will only use the primary variables as control factors.

	<u>Critical Process Parameter</u>	<u>Control Factor</u>
Primary Variables:	Injection Speed Mold Temperature Melt Temperature Cavity Pressure	Injection Speed (velocity control) Thermolator Temperature Nozzle and Barrel Temperatures Hold Pressure
Secondary Variables:	Screw Speed Back Pressure Cooling/Cycle Time	Screw Speed Back Pressure Cooling/Cycle Time

Determine machine variable settings for the DOE

- Set high, low and midpoint levels for the primary variables using material supplier recommendations and process experience.
- Set secondary variables at standard (per material) settings.

Running and Analyzing DOE

Execute Designed Experiment

- **Plan Run Conditions**

Substitute the low, middle and high settings, determined during the DOE preparation, for the -1, 0 and 1 levels respectively in the 27 row design matrix shown below. (This is a Box-Behnken design which can be imported into the E-Chip software.)

Table 2: Box-Behnken Design

Run #	Thermolator Temp (°F)	Nozzle Temp (°F)	Injection Speed (%)	Hold Prs (psi)
1	-1	-1	0	0
2	-1	0	-1	0
3	-1	0	0	-1
4	-1	0	0	1
5	-1	0	1	0
6	-1	1	0	0
7	0	-1	-1	0
8	0	-1	0	-1
9	0	-1	0	1
10	0	-1	1	0
11	0	0	-1	-1
12	0	0	-1	1
13	0	0	0	0
14	0	0	0	0
15	0	0	0	0
16	0	0	1	-1
17	0	0	1	1
18	0	1	-1	0
19	0	1	0	-1
20	0	1	0	1
21	0	1	1	0
22	1	-1	0	0
23	1	0	-1	0
24	1	0	0	-1
25	1	0	0	1
26	1	0	1	0
27	1	1	0	0

If the mold has already been running production parts, add the current process conditions as a 28th run to the DOE.

• **Collect Samples**

Step 1: Set the machine parameters to the levels in the first row of the design matrix and cycle the machine for 1 hour to allow the process to equilibrate.

Step 2: Collect 10 shots.

Step 3: Set the machine parameters to the levels in the second row of the design matrix and cycle the machine for 30 minutes to allow the process to equilibrate.

Step 4: Collect 10 shots.

Step 5: Continue down through the rows of the design matrix, allowing the machine to equilibrate before collecting samples, and then collecting 10 shots per experimental run.

When changing machine levels, use the following guidelines to determine how long to wait before collecting samples.

<u>Variable Changed</u>	<u>Equilibration Time</u>
Thermolator Temperature	1 hour
Nozzle/Barrel Temperatures	30 minutes
Injection Speed	5 minutes
Hold Pressure	5 minutes

Identify if there is a need for tool modifications

Step 1: Evaluate the quality characteristics/response variables for the parts collected (e.g., measure critical dimensions, warpage, flash).

Step 2: Organize the information into a table similar to the one shown below.

Table 3: Sample Table for Recording Measurements

Run#/Shot#	Dimension #1 (in direction of flow)				Dimension #2 (across dir. of flow)			
	Cav 1	Cav 2	Cav 3	Cav 4	Cav 1	Cav 2	Cav 3	Cav 4
run 1/shot 1								
run 1/shot 2								
to								
run 1/shot 10								
run 2/shot 1								
run 2/shot 2								
to								
run 27/shot 10								

- Step 3:** Establish an average measurement for every combination of run #, cavity # and response variable. This can be done by averaging the 10 shots collected for each of these combinations. (e.g., Average #1 is for Run #1, Cavity #1, and Dimension #1)
- Step 4:** Compare the 27 run averages for each cavity with the target value for the first part characteristic and its tolerance.
- Step 5:** If none of the run averages for a cavity fall within the tolerances specified by the customer, there is a need for tool modifications on that cavity.
- Step 6:** Repeat this procedure for all part characteristics used as response variables.
- Step 7:** If tool modifications are required, proceed to the section on **Diagnosing Tool Problems**.
- Step 8:** If tool modifications are not required, continue.

Determine Optimal Processing Conditions

- Input to computer software, the average measurements and associated target values and tolerances.
- Follow software instructions for analyzing data to determine the optimal processing conditions.

Establishing Mold/Machine Capability

Run machine with process conditions identified using software

Step 1: Set the machine parameters to the optimal process conditions and cycle the machine for 1 hour to allow the process to equilibrate.

Step 2: Collect 30 shots.

Calculate the process Cpk for each cavity

Step 1: Evaluate the quality characteristics/response variables for the parts collected (e.g., measure critical dimensions, warpage, flash).

Step 2: Establish an average measurement for every combination of cavity # and response variable. This can be done by averaging the 30 shots collected for each of these combinations. (e.g., Average #1 is for Cavity #1 and Dimension #1)

Step 3: Establish a standard deviation for each of the average measurements calculated above. This is accomplished by taking the standard deviation of the 30 shots for each cavity # and response variable combination.

Step 4: Use the formula below to calculate the process Cpk for each cavity/response variable combination. (ref. 3, p. 373)

$$Cpk = \min [(USL-\mu)/(3\sigma), (\mu-LSL)/(3\sigma)]$$

where USL is the upper specification limit

LSL is the lower specification limit

μ is the average calculated above

σ is the standard deviation calculated above

Diagnosis of Tool Problems (if need for tool modifications has been identified)

The Injection Molding Handbook, edited by Dominick V. Rosato and Donald V. Rosato, includes an excellent troubleshooting guide. Shown below is an excerpt from the guide (ref. 1, p. 668) for analyzing dimensional variation, which seems to be the biggest problem at Taylor.

Problem: Dimensional Variation	
Possible Cause:	Inconsistent Machine Control Incorrect Molding Conditions Poor Part/Mold Design Variations in materials
Possible Remedy:	Machine Molding Mold--make corrections for: <ul style="list-style-type: none"> • Incorrect mold dimensions causing parts to appear out of tolerance • Distortion during ejection • Uneven mold filling • Interrupted mold filling • Incorrect gate dimensions • Incorrect runner dimensions • Inconsistent cycle, mold-caused Materials

Remedies Discussed:

- **Incorrect mold dimensions causing parts to appear out of tolerance**

Layout critical dimensions and compare with dimensional tolerances allowed to moldmakers (see Table 1).

- **Distortion during ejection**

Proper placement of ejector pins ensures even ejection of parts from the mold which is required to avoid part distortion.

Ejector pins may not be properly placed if:

- 1) parts appear to be sticking during ejection or
- 2) measurement of force on ejector pins is high.

- **Uneven mold filling**

Uneven mold filling may result from:

- 1) uneven cooling of the mold
- 2) gate location
- 3) number of gates

Uneven mold filling can be minimized by using mold filling simulation software during part and tool design.

- **Interrupted mold filling**

Interrupted mold filling may result from:

- 1) improper process set-up or
- 2) cold slug.

- **Incorrect gate dimensions (ref. 1, p. 183)**

Feeding into the center of one side of a long narrow molding almost always results in distortion, the molding being distorted concave to the feed.

In a multi-cavity mold, sometimes the cavities closest to the sprue fill first and the farthest cavities later in the cycle. This condition can result in sink marks or shorts in the outer cavities. It is corrected by increasing the size of some gates so that simultaneous filling of all cavities will result.

Submarine gate/Tunnel gate: For multiple cavities, an angular gate entrance requires special care in machining during moldmaking in order to ensure uniformity of the gate opening and consistency in the angular approach for a balanced runner system.

- **Incorrect runner dimensions**

Supply of material to each cavity must be balanced--this means that the shape and size of the runner (its length as well as the gate size) are identical. (ref. 1, p. 175)

Select the minimum runner size that will adequately do the job with the material being used. There are techniques for computing the minimum runner size required to convey melt at the proper rate and pressure loss to achieve optimum molded part quality. As a result, runner design has evolved from pure guesswork into an engineering discipline based on fundamental plastic flow principles.

At times, it is not possible to balance the cavity layout for equal flow distances to all cavities. The primary objective in the latter case is to design a runner system so that all cavities fill at the same rate. This is necessary to ensure that they cool at the same rate and provide uniform shrinkage. Molders will frequently try to balance the fill rates of individual cavities by changing the gate size. While this has some utility, it is a relatively ineffective way of making up for unbalanced runner layouts. The land length of the gate is too short to make any significant difference in pressure drop from one cavity to another. It is much better to vary the runner diameters and control fill rate. (ref. 1, p. 179)

- **Inconsistent cycle, mold-caused**

An inconsistent cycle will result if any of the design problems discussed above require the operator to interrupt the cycle to unstick parts.

Appendix C

Single Cavity Mold Response Variables

Run #	Dim #1 Run Mean (mm)	Dim #1 Run Std Dev (mm)	Dim #2 Run Mean (mm)	Dim #2 Run Std Dev (mm)	Flash Score (ordinal #)
1	41.508	0.0270	38.756	0.0237	0
2	41.512	0.0162	38.762	0.0123	0
3	41.497	0.0134	38.737	0.0206	0
4	41.715	0.0107	38.886	0.0141	23
5	41.623	0.0195	38.809	0.0233	0
6	41.673	0.0177	38.841	0.0137	23
7	41.475	0.0347	38.660	0.0149	0
8	41.415	0.0196	38.592	0.0132	0
9	41.613	0.0095	38.759	0.0129	20
10	41.511	0.0093	38.676	0.0113	0
11	41.402	0.0181	38.610	0.0205	0
12	41.612	0.0187	38.748	0.0239	23
13	41.589	0.0152	38.743	0.0245	21
14	41.583	0.0106	38.726	0.0222	21
15	41.567	0.0132	38.721	0.0176	20
16	41.541	0.0185	38.686	0.0232	20
17	41.733	0.0134	38.834	0.0165	25
18	41.546	0.0171	38.708	0.0204	22
19	41.551	0.0137	38.700	0.0205	24
20	41.779	0.0173	38.865	0.0184	27
21	41.693	0.0302	38.787	0.0206	26
22	41.498	0.0092	38.640	0.0194	20
23	41.476	0.0196	38.604	0.0246	0
24	41.484	0.0108	38.593	0.0200	20
25	41.579	0.0074	38.713	0.0211	24
26	41.530	0.0125	38.668	0.0162	24
27	41.539	0.0099	38.703	0.0221	25

Four Cavity Mold Response Variables

Run #	Dimension #1 (mm)				Dimension #2 (mm)			
	Cavity #1	Cavity #2	Cavity #3	Cavity #4	Cavity #1	Cavity #2	Cavity #3	Cavity #4
1	41.943	41.915	41.974	41.933	36.175	36.175	36.228	36.284
2	41.948	41.920	41.976	41.948	36.182	36.185	36.231	36.292
3	41.902	41.880	41.928	41.905	36.119	36.124	36.175	36.228
4	41.981	41.961	42.009	41.984	36.225	36.208	36.286	36.335
5	41.940	41.910	41.968	41.923	36.139	36.170	36.192	36.215
6	41.951	41.915	41.979	41.943	36.157	36.147	36.205	36.246
7	41.918	41.897	41.940	41.925	36.142	36.157	36.190	36.261
8	41.867	41.839	41.890	41.869	36.058	36.055	36.132	36.182
9	41.961	41.943	42.001	41.963	36.200	36.198	36.253	36.279
10	41.915	41.885	41.946	41.910	36.129	36.134	36.182	36.264
11	41.885	41.869	41.920	41.905	36.093	36.124	36.175	36.208
12	41.918	41.902	41.958	41.918	36.137	36.177	36.228	36.236
13	41.976	41.956	42.012	41.991	36.238	36.266	36.312	36.345
14	41.923	41.915	41.966	41.928	36.142	36.208	36.241	36.307
15	41.890	41.857	41.900	41.880	36.134	36.144	36.159	36.203
16	41.920	41.897	41.946	41.915	36.165	36.172	36.215	36.276
17	41.961	41.933	41.999	41.951	36.210	36.213	36.276	36.317
18	41.925	41.913	41.951	41.930	36.165	36.172	36.210	36.269
19	41.890	41.874	41.905	41.872	36.101	36.116	36.142	36.198
20	41.961	41.940	41.999	41.971	36.215	36.231	36.281	36.322
21	41.935	41.890	41.963	41.913	36.147	36.157	36.215	36.261
22	41.907	41.885	41.938	41.910	36.142	36.126	36.205	36.246
23	41.923	41.892	41.948	41.930	36.152	36.144	36.215	36.261
24	41.854	41.834	41.885	41.867	36.063	36.071	36.126	36.190
25	41.951	41.925	41.974	41.943	36.203	36.200	36.259	36.299
26	41.900	41.872	41.920	41.890	36.121	36.126	36.185	36.231
27	41.915	41.892	41.948	41.910	36.147	36.149	36.205	36.241

Four Cavity Mold Optimization Results

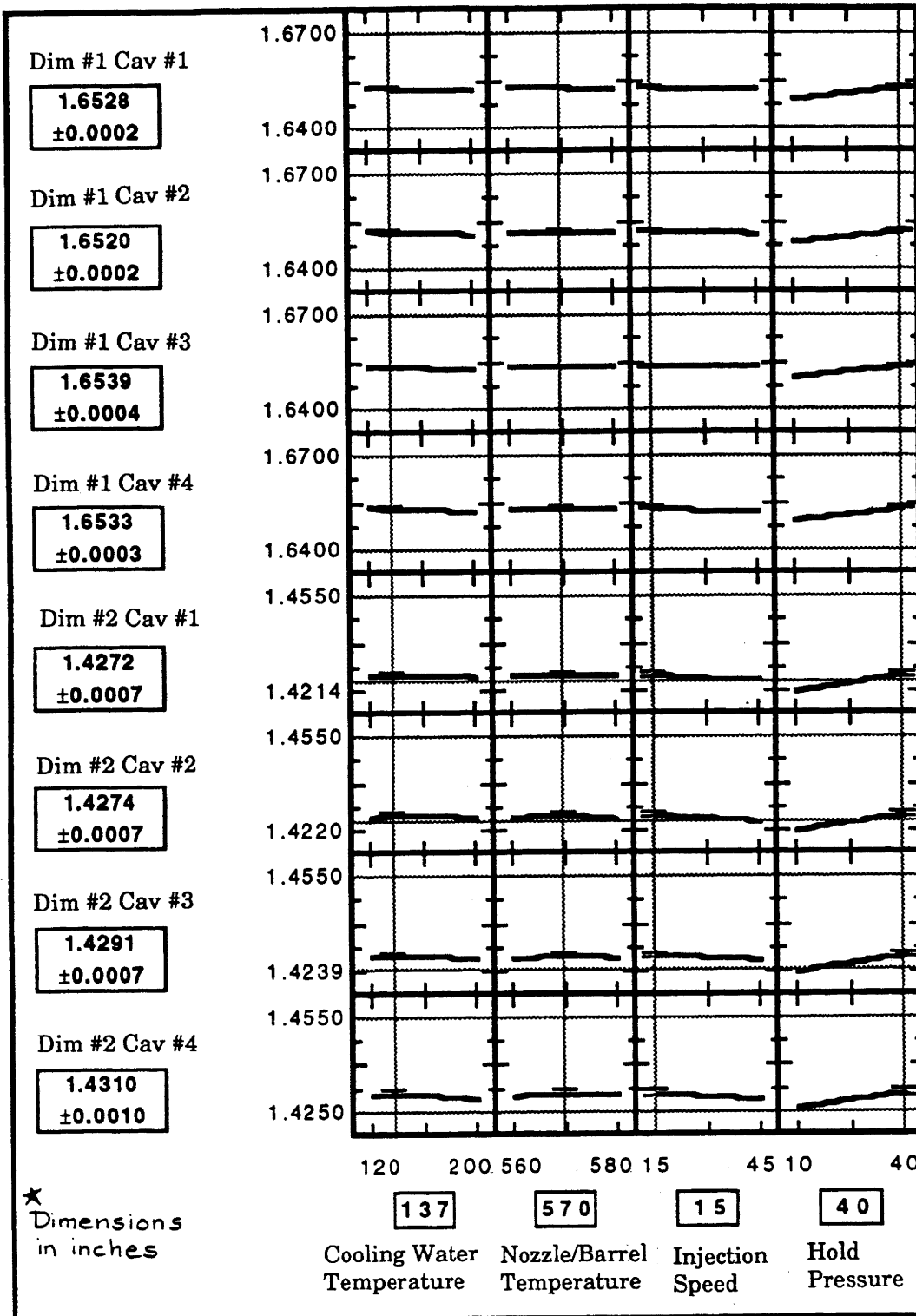

Eight Cavity Mold Experimental Design Matrix

Run #	Coolant Temp (F)	Nozzle Temp (F)	Injection Speed (%)	Hold Pressure (psi)
1	150	545	70	700
2	150	555	50	700
3	150	555	70	500
4	150	555	70	900
5	150	555	90	700
6	150	565	70	700
7	200	545	50	700
8	200	545	70	500
9	200	545	70	900
10	200	545	90	700
11	200	555	50	500
12	200	555	50	900
13	200	555	70	700
14	200	555	70	700
15	200	555	70	700
16	200	555	90	500
17	200	555	90	900
18	200	565	50	700
19	200	565	70	500
20	200	565	70	900
21	200	565	90	700
22	235	545	70	700
23	235	555	50	700
24	235	555	70	500
25	235	555	70	900
26	235	555	90	700
27	235	565	70	700

Nozzel/Barrel Temp Profile

Heater Low/Mid/High

HT1 545/555/565

HT2 540/550/560

HT3 530/540/550

HT4 520/530/540

HT5 520/530/540

Injection Speed Profile

Stage Low/Mid/High

1st 50/70/90

2nd 50/70/90

3rd 40/60/80

Eight Cavity Mold Response Variables

Run #	Dimension (mm)							
	Cavity #9	Cavity #10	Cavity #11	Cavity #12	Cavity #13	Cavity #14	Cavity #15	Cavity #16
1	6.496	6.530	6.495	6.472	6.518	6.529	6.483	6.505
2	6.481	6.514	6.484	6.469	6.472	6.511	6.484	6.509
3	6.488	6.499	6.502	6.486	6.504	6.512	6.487	6.502
4	6.497	6.536	6.511	6.506	6.514	6.545	6.507	6.525
5	6.484	6.507	6.518	6.477	6.466	6.532	6.511	6.518
6	6.477	6.516	6.498	6.504	6.509	6.528	6.511	6.516
7	6.465	6.496	6.486	6.483	6.491	6.528	6.502	6.484
8	6.503	6.507	6.487	6.466	6.468	6.512	6.481	6.497
9	6.480	6.508	6.508	6.500	6.466	6.526	6.506	6.516
10	6.489	6.509	6.509	6.484	6.511	6.517	6.511	6.501
11	6.456	6.499	6.484	6.480	6.469	6.510	6.458	6.461
12	6.487	6.511	6.479	6.475	6.473	6.518	6.481	6.517
13	6.500	6.497	6.506	6.482	6.474	6.520	6.493	6.493
14	6.479	6.504	6.472	6.459	6.479	6.517	6.496	6.464
15	6.454	6.506	6.519	6.488	6.457	6.518	6.502	6.498
16	6.502	6.517	6.489	6.469	6.486	6.499	6.509	6.515
17	6.497	6.487	6.471	6.475	6.443	6.514	6.476	6.474
18	6.486	6.498	6.489	6.495	6.470	6.520	6.479	6.487
19	6.436	6.509	6.494	6.491	6.497	6.530	6.520	6.502
20	6.478	6.519	6.447	6.495	6.465	6.522	6.502	6.497
21	6.491	6.520	6.495	6.483	6.463	6.539	6.490	6.470
22	6.483	6.476	6.490	6.477	6.512	6.505	6.482	6.492
23	6.439	6.481	6.419	6.438	6.460	6.494	6.452	6.450
24	6.456	6.479	6.474	6.473	6.490	6.492	6.479	6.472
25	6.443	6.484	6.497	6.502	6.488	6.493	6.501	6.506
26	6.455	6.472	6.463	6.466	6.465	6.486	6.467	6.493
27	6.481	6.507	6.518	6.486	6.479	6.507	6.488	6.479

Bibliography

- Berins, M.L., SPI Plastics Engineering Handbook (New York: Van Nostrand Reinhold Company, 1991).
- Bernhardt, E. C., and G. Bertacchi, "Quality Molding by Design," Annual Technical Conference, ANTEC '89 (Brookfield Center, CT: Society of Plastics Engineers, 1989).
- Douglas, Ron D., "Injection Molding of Electrical Parts in Today's Materials," Proceedings of the 19th Electrical Electronics Insulation Conference, IEEE 1989.
- Kirkland, Carl, "Injection Control: Open- or Closed-Loop?," Plastics World, February 1992.
- Montgomery, Douglas C., Introduction to Statistical Quality Control (second edition) (New York, NY: John Wiley & Sons, 1985).
- Pandelidis, Ioannis, and Qin Zou, "Optimization of Injection Molding Design. Part I: Gate Location Optimization," Polymer Engineering and Science, Mid-August 1990, Vol. 30, No. 15.
- Phadke, Madhav S., Quality Engineering Using Robust Design (Englewood Cliffs, NJ: Prentice Hall, 1989).
- Rosato, Dominick V., and Donald V. Rosato, Injection Molding Handbook (New York: Van Nostrand Reinhold Company, 1986).
- Sajan, A. T., "An Evaluation of Mold Filling Analysis on an Injection Molded Exterior Product," In Search of Excellence Annual Technical Conference, ANTEC '91 Conference Proceedings v 37 (Brookfield, CT: Society of Plastics Engineers, 1991).
- Schmidt, Stephen R., and Robert G. Launsby, Understanding Industrial Designed Experiments (Colorado Springs, CO: Air Academy Press, 1988).
- Shankar, A., and F.W. Paul, "A Mathematical Model for the Evaluation of Injection Molding Machine Control," Transactions of the ASME, Vol. 104, March 1982.
- United Technologies 1991 Annual Report.

Weissmann, D., "Mold Filling Simulations--Do They Provide the Needed Answers?," In Search of Excellence Annual Technical Conference, ANTEC '91 Conference Proceedings v 37 (Brookfield, CT: Society of Plastics Engineers, 1991).

Woll, Suzanne, "Development of a Pattern Classifier for Use in a Novel Injection Molding Control," Fall 1992.