

Wheelchair Exercise Roller Product Design

by

Benjamin W. Su

Submitted to the Department of Mechanical Engineering
on May 13, 2005 in Partial Fulfillment of the
Requirements for the Degree of Bachelor of Science in
Mechanical Engineering

Abstract

Inspired by bicycle training rollers, a wheelchair exercise roller (an exercise machine for the application of wheelchair users) was designed from conception of idea to alpha prototype. Background and market data was gathered through research with disabled people, members of disability and rehabilitation centers, and by examining other existing related products. Initial designs were created, and using these designs, functional requirements were set. These functional requirements were used to determine the main product modules (rollers, frame, and ramp) and desired features (simulated natural inertia/forces, varying resistance, tilt feature, etc.)

Keeping these in consideration, initial calculations and hands-on research were performed in particular to determine the effect of radial load and RPMs on the bearings. Then, by using test modules built with inline skate bearings, aluminum tube, and wood 2"x 4"s, the initial calculations and research were tested. The results of these tests helped to determine the eventual final design. Solid modeling software (Solidworks 2005) was then used to create various design iterations and make changes as needed.

Finally, using the final solid model, a functional prototype was built using 2"x 2" aluminum angle, conveyor belt rollers, and plywood. This prototype was then tested under the conditions the product was originally intended to function under. The result of these tests showed that in the current state, the prototype was not at a level ready to be marketed. The rollers in their current state did not fully simulate the natural inertia and forces felt when rolling on real ground. Also, several desired features had not yet been implemented. However, the prototype did succeed in ultimately showing potential functionality and feasibility of the product.

Thesis Supervisor: Alexander H. Slocum
Title: Professor of Mechanical Engineering

Table of Contents

1.0	Introduction.....	4
2.0	Background.....	4
2.1	Market Needs.....	4
2.2	Other Existing Exercise Products.....	5
2.3	Existing Wheelchair Roller Products.....	6
3.0	Development Stage.....	7
3.1	Conception of Idea.....	7
3.2	Existing Wheelchair Roller Products.....	8
3.3	Physical Intelligence Element.....	9
3.4	Initial Design Ideas.....	10
3.4.1	Functional Requirements.....	10
3.4.2	Product Modules and Features.....	12
3.4.3	Tilt Designs.....	14
4.0	Initial Research.....	14
4.1	Wheelchair Familiarity.....	14
4.2	Wheelchair Dimensions.....	16
5.0	Initial Calculations.....	16
5.1	Rollers.....	16
5.1.1	Radial Load on Bearings.....	17
5.1.2	RPMs.....	18
6.0	Test Modules and Experiments.....	20
6.1	Test Modules.....	20
6.2	Test Experiments.....	21
6.3	Peer Reviews.....	22
6.4	Design Changes Implemented.....	22
7.0	Solid Modeling Design Process.....	24
7.1	Initial Design.....	24
7.2	Final Prototype Design.....	25
8.0	Building the Prototype.....	28
8.1	Ordering and Construction.....	28
9.0	Testing the Prototype.....	31
10.0	Conclusion and Future Plans.....	32
	Acknowledgments.....	34
	References.....	35

1.0 Introduction

In connection with the SP.251 Physical Intelligence Seminar, given by Noah Riskin, and under the supervision of thesis advisor, Professor Alex Slocum, the project to be designed is an exercise machine created for wheelchair users. I had conceived and proposed this idea to Noah Riskin and Professor Slocum. This exercise machine, specifically a wheelchair “roller,” will allow wheelchair users to wheel themselves in place and in the comfort of their own home or exercise facility. It will be a means for wheelchair users to gain aerobic exercise, as well as allow them to learn and exercise proper wheeling techniques and develop the necessary muscle groups.

Although the popularity of wheelchair sports and exercise has recently been increasing, there still remains a general lack of encouragement for wheelchair users to strengthen their bodies. Also, though wheelchair specific exercise machines already exist, many of these do not strengthen the muscles routinely used by most wheelchair users, do not provide aerobic exercise, and are often too expensive for everyday consumer use. This project and the design of the wheelchair roller hope to address these issues in a simple and economical manner.

2.0 Background

2.1 Market Needs

A machine like this is important because exercise is an important activity for everybody to participate in – even those that have diminished capabilities due to physical disability. According to Gary Karp, the author of *Life on Wheels*, aerobic exercise, specifically, has many benefits such as making the heart stronger and improving circulatory efficiency¹. It also helps to reduce blood pressure and heart rate as well as control weight. From his experience, however, most manual chair users’ normal activity is not enough to provide for optimal health. A true aerobic exercise is marked by sweating and an increased heart rate. Most wheelchair users have the potential to remain very active and to continue building up the strength in their body even if they have limited use of their legs. This is particularly true, as improvements in technology and more effective uses of materials are making wheelchairs more versatile in their mobility.

In addition to the general benefits of aerobic exercise, it is also known that many wheelchair users suffer from overuse injuries. The rotator cuffs, especially, are a common site of

injury for non-athlete wheelchair users². Because they have to use their arms for nearly all of their activity, it is easy to overuse muscles that are not used to sustaining the strain put on them daily. Thus, this machine, in addition to providing aerobic exercise, can help lead to better joint health, by allowing the user to train complimentary muscle groups not often used, by wheeling in different directions. Strengthening these muscles could help reduce the possibility for future over-use injuries.

Keeping this all in consideration, there are two major potential customers for the product. One would be the everyday wheelchair user that is interested in keeping up physical activity and would like to have the ability to exercise in the comfort of his/her own home. The other potential customers are the various rehabilitation and disability centers. Mitch Carr, Manager of Fitness Services at the Rehabilitation Institute of Chicago (RIC), who works with wheelchair users on a daily basis expressed his interest in a roller product especially for at home use. Currently, the rehabilitation center owns many wheelchair exercise machines and a few wheelchair roller products. The rollers, however, are all geared toward wheelchair racing applications. He states that a compact wheelchair roller design that also allows for a user to use his/her own wheelchair would definitely be beneficial. The need for such a product is especially greater in regions with typically poorer weather. Finally, cost is an important factor to consider since many wheelchair users do not have a large expendable income.

2.2 Non-Roller Exercise Products

Current existing exercise products for wheelchair users tend to fall in two categories. First are the aerobic exercise machines that often include hand cranks or hand/foot cranks. The others are the strength building machines which primarily include weight lifting machines, or weight sets that are customized to fit a person that is confined to a particular range of motion in their wheelchair.



Fig. 1: From left to right: Upper body power trainer (hand crank), PowerFit 3000 (strength training), and Challenge Circuit 7000 (workout machine)³.

Although these products are effective and can achieve the necessary goals, they lack some of the advantages the wheelchair roller offers, such as directly improving the normal everyday movement of a wheelchair user. While strengthening the muscles in the arms, it also provides an aerobic workout.

2.3 Existing Wheelchair Roller Products

Upon preliminary research of various vendors, two other notable wheelchair roller devices were found. One device was a heavy-duty machine, named the Aero-trak that was designed primarily for wheelchair racers⁴. This design incorporated many of the features described above, including resistance and mimicked inertia by means of motors and computer control, as well as heart-rate monitoring. On this machine, two sets of rollers are driven by the wheels of the wheelchair. The market price for this product is \$1775. Another device was less technologically advanced, but maintained the necessary features of varying resistance and mimicked inertia (by means of flywheel). This machine only contains one set of rollers that are driven by the wheels of the wheelchair. The market price for this product is approximately \$640⁵. These two devices are shown below in Figure 2. A project developing a concept design for a modification to the second wheelchair roller machine is also shown below. This concept design appears to allow for a different strength building regimen⁶.

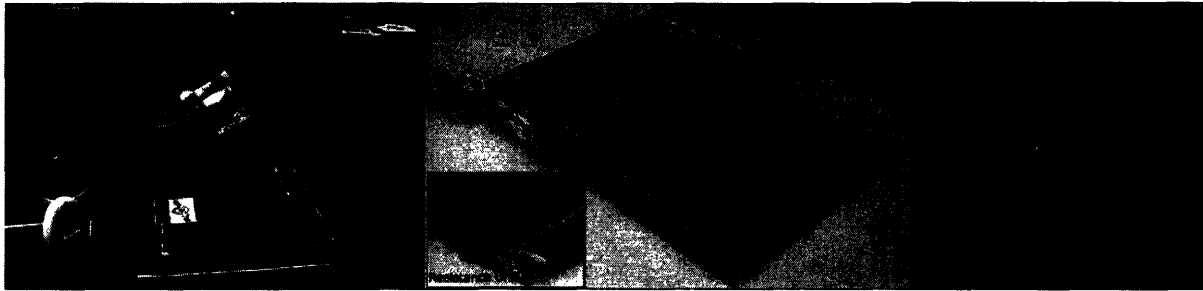

Fig. 2: From left to right, the Aerotrak, “Wheelchair Training Rollers,” and a concept design of a modified set of “Wheelchair Training Rollers.”

3.0 Development Stage

3.1 Conception of Idea

The idea for this design was originally inspired by bicycle training rollers. Bicycle training rollers were made to address the concerns of cyclists that require training during the off-season. They helped to avoid problems caused by weather issues, and to allow cyclists to train and exercise in the comfort of either their home or training facility. In addition, although there are other currently existing training machines, each of these trainers have inconveniences that are in some way addressed by the training rollers. They are as follows:

1. Stationary exercise bicycles typically do not accurately represent the feel of a riding a bicycle, because the machines cannot perfectly resemble the ergonomic feel of a bicycle. One primary reason is because these machines are sturdy stand-alone structures and lack the side to side range of motion felt when riding a real bicycle.
2. Bicycle “trainers” more accurately mimic the natural ergonomic feel of cycling by allowing the user to attach their own bicycle to it. However, some of this is diminished, because the trainer design does not allow contact between the back wheel and the ground. Optional resistance units do allow for a simulated natural feel, though. Also, these machines typically require some effort in attaching the machine to the bicycle.
3. Bicycle treadmills allow for a side to side range of motion, as well as a natural riding feeling due to forces felt by having contact between the wheels and the ground, but is unfortunately an expensive and space wasting solution. The machine is essentially a modified electric runner’s treadmill, large enough for a bicycle to fit on. In addition, because the bicycle’s motion is propelled by the electric treadmill, the primary exercise

comes from being able to keep up with the speed of the treadmill instead of from exerting a force necessary to propel a mass forward.

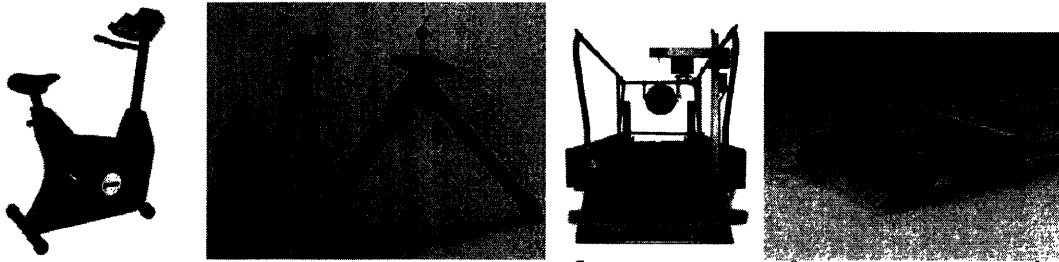

Fig. 3: From the left: stationary exercise bicycle⁷, bicycle ‘trainer’⁸, bicycle treadmill⁹, and bicycle training rollers⁸.

Bicycle training rollers, although still imperfect, have incorporated several novel features that help to alleviate these problems. First, similar to bicycle ‘trainers’ and bicycle treadmills, the user’s own bicycle can be used. Also, because the bicycle is not attached to any device, the natural side to side range of motion and necessity to keep balance is maintained. Most training rollers are also equipped with a flywheel which helps to mimic the forces and inertia felt when propelling and riding a bicycle. Finally, resistance units can be fitted to rollers to increase the intensity of the exercise session.

Having decided the project was to incorporate the design of sports equipment for handicapped users, it became clear that this roller technology could be applied to handicapped users confined to wheelchairs. Using a similar model modified for the size, shape, and dynamics of a wheelchair, an exercise machine allowing wheelchair users to obtain aerobic exercise while strengthening their most used muscle groups could be conceived.

3.2 Drawing from Existing Wheelchair Roller Products

Using the two previously mentioned designs, various insight for the final prototype design was gained. First, it was clear that mimicked inertia and varying resistance were features that must be included in the final design. It is important that the forces felt on the machine are similar to the forces felt when actually wheeling a wheelchair on the ground, since the machine is meant to allow users to gain the same exercising benefits as wheeling along an outdoor trail. Also, because users of different strength levels will be using the product, a varying resistance to either increase or decrease the difficulty of driving the wheels is desirable.

A comparison of both designs also yielded important information on safety. Because of the large supported base of the first device, the user will probably not fear falling off the rollers. However, in the second design, a sparse and thin frame may cause a user to feel less safe about whether the structure will support his/her weight and the weight of the chair, even though it is definitely strong enough for the expected loads. In addition, because the device is raised several inches off of the ground, any unnecessary height may cause a user to feel uneasy, as a wrong turn off the rollers could result in a devastating fall. Both machines also have rollers that are relatively close to each other which may lead to feelings on instability.

Finally, the first device contains many useful and desirable extra features. However, these features must be carefully considered as many of them, though useful, may not be necessary for the average everyday exerciser and would prove to be an unnecessary cost.

These two designs show how a range of features can be incorporated into such a device. However, the price of one is not feasible for an everyday user, and even though the other design seems to provide a simple solution for users not in need of fancy features, its price still does not reflect what the user gets. Nevertheless, by considering both of these designs, much can be learned and the right advantages of both can be implemented into a design that is economical yet still useful.

3.3 Physical Intelligence Element

As part of the Physical Intelligence seminar, many ideas about the human body and how it responds and adapts to changing environments was learned. This insight was also useful in the design of the exercise machine as it leant to designing a machine that exercised different “physical” aspects of the body rather than simply the standard “strength” or “muscles.” In this specific case, the use of a wheelchair is already a significant change to environment that requires the user to adapt and change his/her normal ranges of motion and use of muscles. Therefore, a wheelchair roller in its simplest form can already exercise physical intelligence by allowing a user to familiarize his/herself with the feeling, forces, and strain experienced when moving from place to place.

Under normal use, however, a wheelchair user does not just roll on flat terrain. To get in and out of buildings, wheelchair users often have to utilize ramps. This change in the gradient of terrain, uphill and downhill, is in itself another change to environment. The body will naturally

want to react by counterbalancing his/her weight if he feels that he is tipping backwards, or if he is tipping forwards. At the same time, because of the shift in position of the body, different muscles are utilized to propel a wheelchair. Noting this difference allows us to further expand the potential of physical intelligence exercise in the machine to be designed, whereby building a tilt varying frame, a user can experience the feeling of going either uphill or downhill and effectively exercise the different muscles used in each of these situations. Varying resistance could also be combined with this feature to further simulate the feeling.

Finally, another aspect of physical intelligence is the body's response to visual feedback. For the case of this product's design a physical readout of the virtual speed or RPMs (revolutions per minute) that the wheelchair user is moving at, can be an excellent teacher and motivator. A heart rate monitor could similarly be a useful tool, but as mentioned earlier, both of these additions would add cost, and thus should be options.

3.4 Initial Design Ideas

3.4.1 Functional Requirements

Pulling from all of the observations made, and what was learned from researching other existing products, several initial concept designs were made which incorporated both the aesthetic aspect of the design as well as the functional aspects of the design. Figures 4 and 5 show the two initial concept drawings.

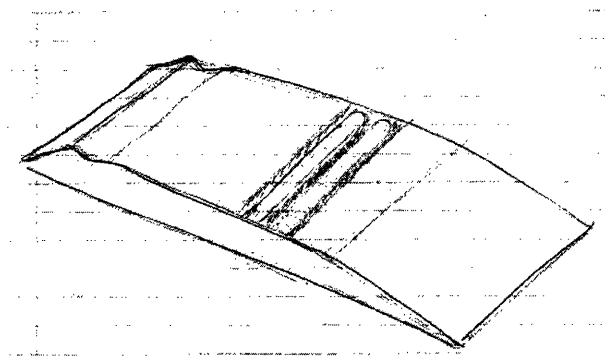

Fig. 4: 1st concept design drawing.

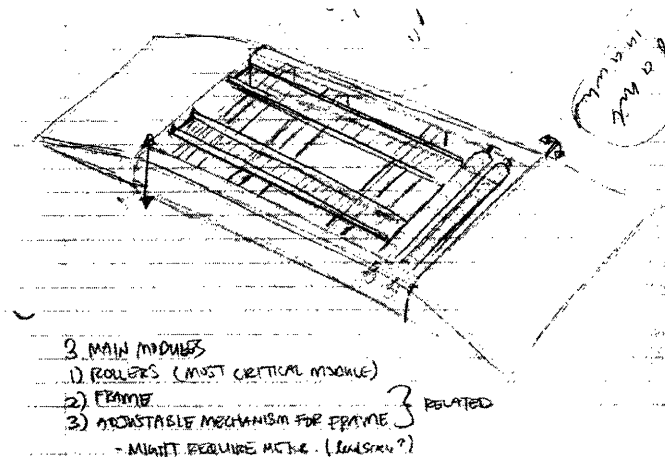

Fig. 5: 2nd concept design drawing - slightly more realistic concept design drawing outlining the main modules of the overall design.

While the sketches were simply physical representations of the ideas formulated in thought, the most important information gained from these initial concept designs were the functional requirements that the final design hoped to incorporate. The functional requirements were as follows:

- Geometry:** Because the product was intended to be used by everyday consumers, the final design would ideally be small enough to fit in any potential user's home. In particular, considering the product would be used and maintained by handicapped users, a large bulky machine would be much less than ideal. In addition, as seen in one of the existing wheelchair roller designs, the position of the wheelchair on the product (in this case, height) can make a big difference in how comfortable the user feels. The product also must consider the geometry of different sized wheelchairs and accommodate accordingly.
- Material and Cost:** These functional requirements are related because the materials used in a product can significantly affect the overall cost. This is true both in the cost of purchasing raw materials as well as in the difficulty of manufacturing and packaging a product. The materials used for the product are also important (independent of cost) because, again, if under use by an everyday consumer, a very heavy or bulky product would be undesirable.
- Forces:** Forces refer to several different important aspects in the design of the product. First, related to materials and geometry, it is necessary to design a product that minimizes

material cost, but is strong enough to handle the forces that are expected. Geometry similarly plays a role in the physics. Therefore it is important to analyze and understand the kinematics that the product might undergo. Secondly, forces refer to the forces felt by the user in using the product. As mentioned earlier, it is important that the product can mimic the forces felt when using a wheelchair on normal ground.

- **Ergonomics:** Ergonomics are important, especially because the product is being made for wheelchair users who typically have a limited capacity in their movement. Therefore, any attachments, handles, etc must be easily accessible and comfortable for the user.
- **Maintenance and Operation:** In order for this product to be successful, it must require little to no maintenance, and provide convenient maintenance service if necessary. In addition, it has to be an easily understood and operated machine.
- **Safety:** Safety is one of the major concerns of this product, as it is with any exercise equipment. The design has to reflect such that there are no safety issues in any normal use of the product. It also has to guard against the potential of misuse, such as minimizing pinch points and designing housings to cover up potentially dangerous mechanical parts. Implied within this, is that the product must also not appear unsafe, even if it is completely safe.

3.4.2 Product Modules and Features

Keeping the functional requirements, observations of existing products, and ideas of physical intelligence under consideration, the product can be divided in to three major modules:

1. **Rollers:** This is the most critical module of the product, as this is the main “technology” of the product. If the rollers are not functional or problems with the rollers cannot be resolved, the product is essentially useless.
2. **Frame:** The design of the frame is integral for several reasons. First, the frame has to be designed to accommodate to the motion of the rollers, so integration between the two parts is crucial. Secondly, the frame needs to be able to bear the load that is applied on it by the wheelchair user and wheelchair, as well as fit various wheelchair sizes within it. Three, the frame defines the aesthetic appeal of the product, and is a direct result of the functional requirements of Geometry, Material, Cost, Forces, and Safety.

3. **Ramp:** The ramp, though seemingly a small part of the entire design, is important because it caters to the overall comfort level of the user. If the user cannot easily position him/herself on the machine, then costumers will not like to use it.

With these basic modules set, the extra features, drawn from existing products and individual design ideas, in this product will hope to be (in order of importance):

1. **Mimicked natural inertia/forces:** This “feature” is self explanatory, again to make the exercising experience feel as natural as possible.
2. **Variable Resistance:** A varying resistance can help to simulate the natural resistance that a wheelchair user might feel on different types of terrain, or when going up inclines. Also, it will help to cater to different levels of users (i.e. less resistance for beginners, more resistance for experienced, stronger users).
3. **Two sets of Rollers:** As will be seen in the Tilt Design sketches, the wheelchair roller could be outfitted with two sets of rollers (one for each wheel), rather than just one set of rollers. The advantage of this would be to allow the user to have free control over each arm. This could allow them to practice turning applications, or in a rehabilitation situation, only work on the strength of one arm over the other. In addition, two sets of rollers would spread out the load over more rollers and more bearings, though it would come at a higher cost.
4. **Variable Tilt:** The varying tilt is a feature that is first in response to the physical intelligence aspect of the project, as it could help beginning wheelchair users become comfortable with adjusting their bodies to changing environments. Furthermore, exercise can be provided to different muscles that are used in these different environments.
5. **User Feedback Controls:** Different user feedback, such as how fast the wheelchair user is wheeling, how far a user has “traveled,” or heart rate monitoring could be potentially useful. According to Mitch Carr (of the RIC), on-screen displays showing workout information or giving feedback is extremely beneficial

3.4.3 Tilt Designs

The following figures (Fig. 6 and 7) show various initial designs that could be prototyped out of 2"x 4"s. These are simply different ideas of the mechanical aspect of how the frame could be built such that it would allow for upwards tilt. In each of these cases, a motor would have to be utilized to drive a lead screw that would drive the tilting frame. For user comfort, some type of wired remote would ideally come up from the motor with buttons that would allow the user to easily tilt the frame up or down. Also, as previously mentioned, the designs allow for the possibility of having two sets of rollers rather than one.

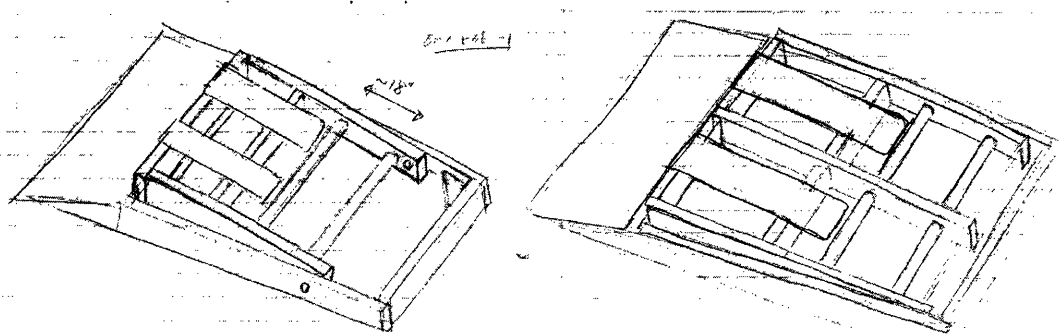

Fig. 6: Mockup design drawings - two designs drawn of how a mockup prototype could be built out of 2x4s (with tilt function). The designs differ in the numbers of roller sets.

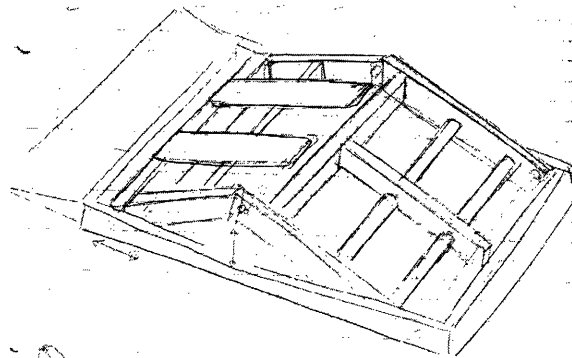

Fig. 7: Another mockup design drawing that shows a possible alternate tilt method

4.0 Initial Research

4.1 Wheelchair Familiarity

In order to effectively design the wheelchair roller, it was important to become familiar with a wheelchair. Fortunately, working with Tom Cronan from MIT Sports Medicine, a wheelchair was made available to borrow during the term. After securing it, the first part of the

process of becoming familiar with a wheelchair was simply wheeling around a track. The purpose for doing this was two-fold. First, it was necessary to get used to the arm motions required to propel a wheelchair, and secondly, by taking the time to wheel a significant distance, it would become quickly apparent which parts of your body were being worked the hardest.

At least twenty laps were completed in an indoor basketball court at the MIT Zesiger Sports Center, and at the completion of the laps, it became clear to me (though maybe obvious) that the arms were worked the hardest. Before conducting the research, it was speculated that the abdominals or other upper-body muscles might be more deeply engaged (especially if the user leans with the motion of the wheelchair). However, it seemed that for normal wheelchair use the abdominal muscles did not play a significant role.

Having better understood the normal arm “stroke” used in wheeling a wheelchair forwards on flat smooth terrain, I thought it would be interesting to experiment with how it felt rolling backwards, turning, going up and incline, and going down an incline. For each of these situations including rolling on flat ground, observations were made on the specific muscles used in the “stroke,” the feeling of how inertia and gravity played a role in the movement of the chair, and the force necessary to move the chair forward.

On flat ground, it was observed that three primary muscles groups were engaged in the following order: shoulders, triceps, and biceps. The shoulders are used in the initial push (when your arms are back), and the triceps help with the follow-through. The biceps are then engaged when pulling the arms back to prepare to push again. With an efficient use of all three muscles, a smooth and powerful repetitive stroke can be produced. Moving from zero velocity to positive velocity on flat ground takes a medium amount of force, but once the chair gets going the inertia keeps the chair moving rather steadily.

Going backwards requires a similar amount of force, and continues to roll similarly to going forwards. However, going backwards requires a different arm stroke and tends to work the shoulders and triceps much more than the biceps. It is also more difficult to pull the arms backwards than to push them forwards.

When traveling up an incline, the body tends to lean forwards slightly (to counterbalance the weight of the wheelchair leaning backwards). Because of this, slightly different muscle use is observed. The shoulders are still used, but there is less reliance on the triceps for the follow through. In addition, due to gravity, it is much harder to propel the wheelchair forward. Even

when you get it going, there is a very short time period in which inertia keeps the chair moving forward. As would be expected, if the user does not reset his hands on the wheels fast enough (to either push again or to hold the wheel still), the chair will start to roll backwards. Thus, during this stage in the wheelchair movement, the biceps are important in helping the arms pull back quickly. Also, the biceps (in addition to the triceps and shoulders) are engaged heavily in preventing the wheelchair from rolling backwards. Fortunately, the wheelchair is designed to not tip backwards easily. But, even knowing this, the feeling can still be unnerving.

Finally, going downhill requires more effort than one might expect. All three muscles are worked in order to hold the wheels and prevent the chair from rolling to fast (unless that is desired). With gravity on its side, the inertia due to the mass of the chair builds up the speed of the chair rather quickly. To stop the chair, a good amount of force is required, and the faster the speed of the chair, the more difficult it is to stop. A lot of strain is also put on the hands in order to stop the spinning wheels.

4.2 Wheelchair Dimensions

Not every wheelchair has the same design, so the product must accommodate for these variations. Fortunately, most of the dimensions that vary from chair to chair are not critical to the design of the wheelchair roller. The critical dimensions are the width between the back wheels and the diameter of the back wheel. From the United Nations Division of Social Policy and Development's Program on Disabled People, the average width between the back wheels of a manual wheelchair is 19.68"¹⁰. For the borrowed wheelchair used during the term, the distance was 20". An average dimension for the diameter of the back wheel is not given, but the dimension from the borrowed wheelchair is 25". These values, along with the other dimensions of the borrowed wheelchair will be used in the solid modeling of the chair, and used in the design of the machine.

5.0 Initial Calculations

5.1 Rollers

After conducting the initial research on general wheelchair information, it is important to run some initial calculations that will help determine the types of materials that are needed to implement the design. It is vital to the final product design to know and understand these values.

5.1.1 Radial Load on Bearings

There are many different types of bearings that are used for various applications. For this application, however, common ball bearings (used in inline skates and in the wheelchair axis), are more than sufficient.

Two major geometrical factors can affect the radial load applied at each bearing. These are “Roller Distance,” the horizontal distance between each roller, and “Roller Size,” the diameter of the roller. Figure 8 shows a cross sectional view of a wheelchair wheel in contact with a set of rollers. A number of forces and reaction forces felt by the bodies are shown. The wheelchair wheel is the large circle, and the two rollers are the smaller circles.

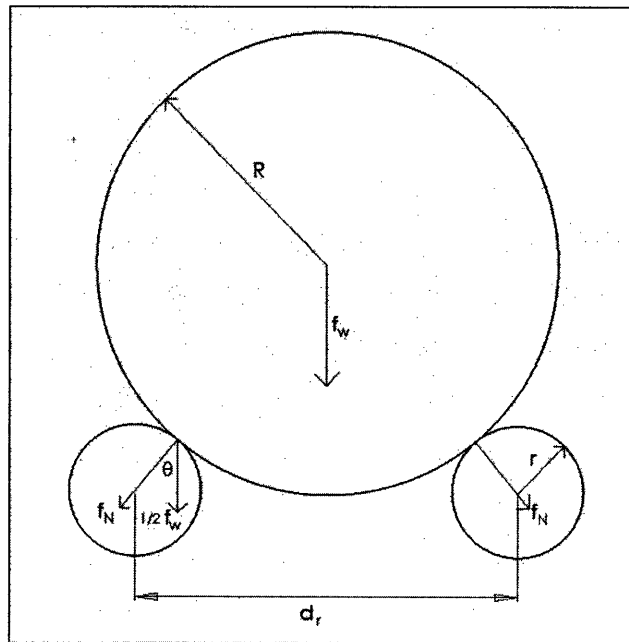

Fig. 8: Diagram outlining forces and force components felt on rollers due to wheelchair load.

As defined in Figure 8, d_r is the distance between roller axis, R is the radius of the wheelchair wheel, r is the radius of the roller, f_w is the force due to weight of the wheelchair and person, and f_n is the radial force on the rollers. $1/2 f_w$ is a component of the radial force, f_n . θ is the angle created between the radial force f_n and force due to the weight of the wheelchair, f_w .

Since both the distance between rollers, d_r , and the radius of the roller, r , are variable, in order to understand the relationship between one variable and the radial load, the other variable

must be held constant. With this in mind, the following two equations can be developed using geometric properties of the system.

$$\theta = \sin^{-1} \frac{(d_r)}{2(R + r)} \tag{1}$$

$$f_n = \frac{1}{\cos(\theta)} * \left(\frac{1}{2} f_w\right) \tag{2}$$

Using these Equations (1) and (2), the relationship between “Roller Distance” and radial load, and “Roller Size” and radial load can be calculated, as shown in Figures 9 and 10.

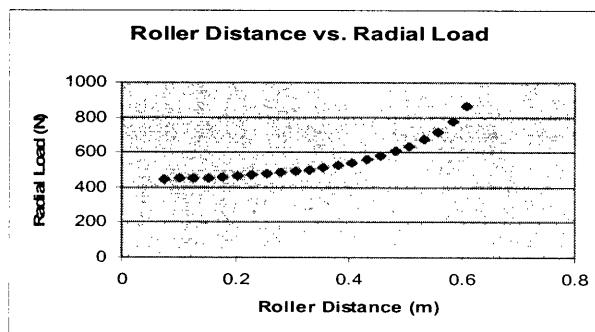

Fig. 9: Radial load felt on bearing as a function of the distance between rollers assuming rollers of radius .03m

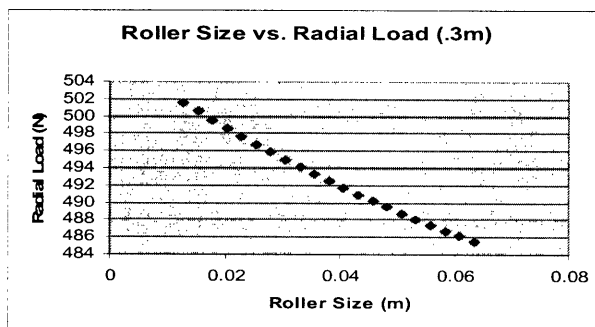

Fig. 10: Radial load on bearing as a function of the roller diameter (assuming .3 meter distance between rollers)

5.1.2 RPMs

In the same manner that bearings are rated for different loads, certain bearings are also designed to function under a maximum level of RPMs (revolutions per minute). In order to determine whether the bearings that we will use are adequate for this application, a maximum number of RPMs that can be outputted by a wheelchair user needs to be calculated. This can be

achieved by knowing the dimensions of the wheel, the dimension of the rollers, and the typical flat road speeds traveled by a wheelchair user.

First, a quick search of some wheelchair racing records yields a flat road speed of 21 mph¹¹. Although this is undoubtedly not the fastest in the world, it gives an adequate upper limit of speed. At the same time, since 21 mph is the *maximum*, two things are made clear. One, the speed must have been achieved during a sprint, and two, even during the race, the wheelchair was not traveling at 21 mph the entire time. With a wheelchair back wheel of 25” diameter, and rollers of 1” diameter, 21 mph yields 7060 RPMs for the rollers. To put this value in perspective, another source states that some public places (in this case a college) set a speed limit for wheelchairs at 4 mph¹². This speed could translate into a comfortable “walking” speed. Therefore, for most normal applications, such as if you wanted to simulate rolling along a trail for aerobic exercise, you could expect that the speed would not exceed 8-10 mph. These speeds would yield approximately 3000 RPMs.

As a point of comparison, ABEC-1 (lowest quality rating) ball bearings are built to function up to approximately 31,250 RPMs (based on an 8mm bearing and a DN value for an angular contact metallic cage ball bearing)¹³. Although the bearings being used are most likely not angular contact bearings, the speed rating is similar to specifications outlined on several inline skate ball bearing vendor sites, where 8mm ABEC-1 608 bearings have a maximum RPM rating of 32000 RPMs. Nevertheless, these ratings far exceed any application for the wheelchair roller.

Bearing life (L_{10} life) can also be approximated using the following equation¹⁴:

$$L_{10} = a_1 a_2 a_3 \left(\frac{C}{F_e}\right)^\gamma \quad (3)$$

where a_1 is 1.0 for 10% probability of failure, a_2 is a material factor (typically 3.0 for steel), a_3 is a lubrication factor (typically 1.0 for oil), C is a dynamic load rating (can be found for various bearings), F_e is the applied equivalent radial load, and γ equals 3 for ball bearings.

Approximating, using given and determined values, the L_{10} life is on the order of 1 billion revolutions.

6.0 Test Modules and Experiments

6.1 Test Modules

After running the initial calculations, it is clear that there should not be any problems associated with the forces or speeds that will be felt by the machine. However, these calculations must be tested in some manner, especially since the dynamic function of the rollers is not necessarily clear from the calculations.

Therefore, two test modules were built using wood 2"x 4"s and some scrap aluminum tubes that were scavenged from an old microphone stand. The advantage of using wood is easy machining and cheap materials. 16 ABEC-3 BSB Speed Ball Bearings (for Rollerblades) were also purchased along with BSB 688 Micro Spacers. The process in putting the test module together began first by attaching the ball bearings to the aluminum tubes. Because the bearings and aluminum tubes were slightly different sizes and any amount of machining involved in permanently attaching the two parts would have been overly time consuming, hose clamps were used to temporarily attach the two parts together. The clamps provided enough force that there was no slipping between the parts, so functionality was uncompromised. Having built the rollers, the spacers (made to fit the ball bearings) were then press fit into wood 2"x 4"s. At the completion of this, the rollers were aligned between the spacers and the 2"x 4"s were mounted together so they would not move. Figure 11 shows the two test modules.

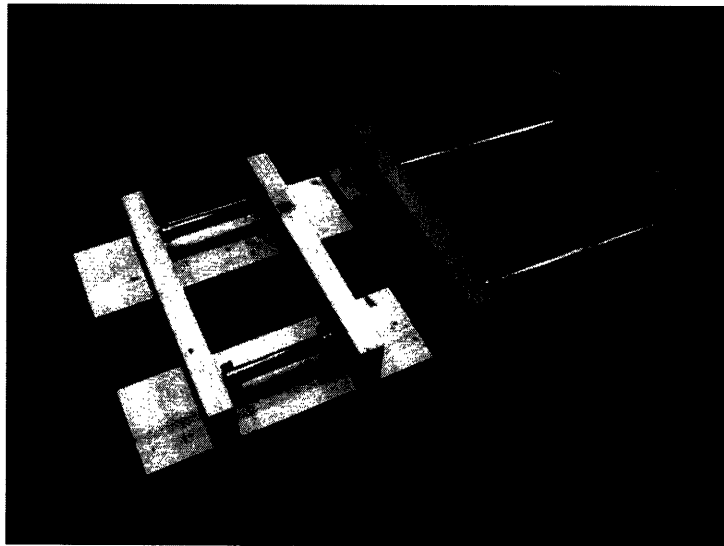

Fig. 11: Two test modules built using rollerblade bearings and 2"x 4"s.

One of the test rollers has a between frame length (approximate length of rollers + bearing) of 11 inches. The other set of rollers has a between frame length of 6 inches. In both sets, the rollers are approximately 10 inches apart. In an original non-functional mockup, different roller distances were experimented with to determine a comfortable length for the user. From those observations, it was determined that a longer roller distance felt more stable and was preferable. This works against the roller calculations which showed that larger roller distance yielded greater radial loads. However, the radial load does not increase significantly until a roller distance of approximately .35m (13.8"). The specific length of 10 inches was chosen largely due to geometrical considerations in preventing the wheel of the wheelchair to touch the floor as it is well shorter than 13.8" and would not yield an undesirable radial load on the bearings.

6.2 Test Experiments

The primary reason for building the test roller modules was to feel how the rollers reacted to use. First, the two sets of rollers were built with varying between frame lengths. The reason for this was to determine whether there was a significant effect due to roller bending (from the weight of the wheelchair and user). In other words, if the rollers were too long, the functionality of the bearings may be compromised because of bending moments felt at the frame/roller interface. After using both rollers and by applying heavy loads on the rollers, it was apparent that under both lengths, bending did not cause any significant change to bearing functionality.

Knowing this, then, the between frame length had to be tested for safety purposes. This is important because during the course of wheeling, the wheelchair may not stay centered within the rollers. Shorter rollers could potentially mean saving money on cost of materials. Using the two test modules, there seemed to be a noticeable level of drifting from side to side, but this was largely due to the fact that the rollers were not perfectly aligned. If aligned, it would be expected that drifting would be significantly lower. In the event that drifting became an issue, small rubber guides could be installed to help prevent this dilemma.

It was important also to determine how well the wheelchair roller mechanism functioned. The first noticeable factor was the weight of the load being applied on the rollers. Although bending was not an issue, the friction (though low) caused by the radial load was. With only the weight of the wheelchair on the rollers, the wheel and rollers would continue to spin freely for a few seconds after an initial push. However, with the weight of the person in the chair, the rollers

would stop spinning very shortly after the initial push. This was not necessarily a surprising result, because this system was lacking the effect of momentum experienced when actually rolling along the ground. The mass and moment of inertia of the rollers were not large enough to mimic this. Similarly, the force required to push the wheel forward was not as great as in a real situation. Again, this was not a surprising result because the force used was simply enough to drive low friction ball bearings, whereas when rolling on the ground, the user is applying enough force to move a large mass.

A test ramp was also prepared, simply using a large piece of plywood and height spacer. Using the plywood, different incline gradients were tested to see what would be the most comfortable. Although the government standards for wheelchair accessible ramps are a gradient ratio of 1 to 12,¹⁵ it was found that a 1 to 8 ratio still felt comfortable (and did not require much force) to the user for the short length of this ramp. Then, when combined with the test modules, the brake conception was tested. By impeding the motion of the front rollers, it was clear that the wheelchair would be able to come off of the rollers on to the ramp with little effort.

6.3 Peer Reviews

Other students and instructors in the Physical Intelligence seminar were able to test out the roller test modules as well. In response to these, most of the users felt that the action of the rollers was easy to spin and easy to use overall. However, one of the more common observations was a slight wobble in the rollers due to imperfect alignment. With more careful measurements and assembly, this problem can be easily avoided. Other comments for the wheelchair roller device alluded to many of the features described earlier as features that were hoped to be incorporated into the final design, such as mimicked inertia, variable resistance, and visual feedback. Some kind of interactive component could also be added to make the product more enjoyable to use.

6.4 Design Changes Implemented

Using the information gathered from experimenting with the test modules, it was determined what worked and what could be improved. This knowledge allowed for the decisions of what design ideas/changes would be implemented into both the final prototype design and an eventual final product design.

1. *Roller Distance*: Having experimented with different distances for comfort means, calculating the relationship between radial load and roller distance, and determining the geometrical plausibility of the length, a roller distance of 10 inches is reasonable. The length of the frame will be dependent on this dimension.
2. *Roller Length (Between Frame Length)*: Because bending due to the load of the wheelchair is negligible to bearing performance, roller length needs to be determined for comfort level and material cost. A length between 6-8 inches would probably be an adequate compromise. By centering the wheelchair on the rollers, the width of the frame will be determined from this dimension.
3. *Mimicked natural inertia/forces*: The rollers themselves do not provide enough inertia to simulate the natural feeling when rolling on the ground. Assuming the use of aluminum, and a between frame length of 8 inches, four rollers would need a radius of 8.939 inches each to equate the moment of inertia of the wheelchair (modeled as a hoop with mass 90.9 kg). Therefore, a flywheel, or some other means of more efficiently simulating this feeling (like a motor) would need to be applied to the system. By using a flywheel, the rollers would not only require a larger force to start turning, but would continue to turn for longer and not be affected as strongly by the radial load of the wheelchair and user. Bicycle rollers typically use flywheels for this purpose.
4. *Ramp*: Differing from my original drawings, with a roller distance of 10 inches, it would be impossible to have two ramps where one allows the user to roll up onto the rollers, and one allows him/her to exit. Therefore, there must only be one ramp that the user must back up on to. This design change is necessary although not ideal. Also, the length of the ramp will be built under a ratio of length to height of no less than 8:1.
5. *Brake*: A brake is necessary to prevent the front rollers from rolling if the user intends to get off the machine. This design module was not originally obvious, but is clearly an important aspect of the design. A brake may also be designed to be used to set roller resistance (by increasing friction on rollers).

7.0 Solid Modeling Design Process

7.1 Initial Design

The next step in the design process of the prototype is using a solid modeling program to design the different parts of the product and test how they fit and interact together. From the sketches made during the concept design stage, there was a general idea of what the prototype should look like. It was apparent at this stage, however, that the original goals in the aesthetic appearance of the product are no longer viable, both for functionality reasons, and in the interest of time and money. Therefore, the eventual prototype built for this thesis will most likely be simplified to the point of functionality. Consequently, another advantage of using a solid modeling program is that future designs and mechanisms (that cannot be built) can be shown and tested within the program (Solidworks 2005).

The initial design utilized the same ABEC-3 BSB Speed Ball Bearings used in the mockup. Instead of the spacers, however, a steel rod of diameter 8mm, the bore size of the bearings, would be placed through an 8" aluminum tube. The bearings would then be mounted onto the aluminum tube. The frame for the wheelchair roller would be made out of either 2x2 steel square tubing or out of 1x1 steel square tubing (and raised one inch of the ground so the wheelchair wheel does not touch the ground). Holes could be milled into the steel tubing to allow the rollers to be mounted in. The front of the frame would have a flat open section that the ramp would incline up to. In the flat section of the ramp, small holes could be cut out to secure the front wheels in place. These holes would also aid in preventing the wheelchair from drifting from side to side. The ramp could be made out of steel sheeting or simply out of plywood.

Figure 12 shows a solid model of the initial design.

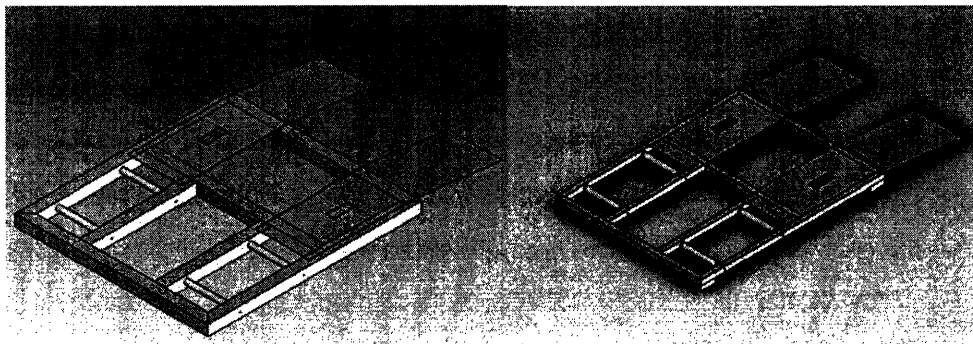

Fig. 12: Initial solid model drawings - (both are essentially the same but with different sized square steel tubing)

A brake was also designed in Solidworks as a slightly modified version of a brake that is found on a wheelchair itself. The brake, as shown below, comprises of a pulled lever that causes a rubber stopper (can be made out of weather stripping, or similar materials) to push up against the front roller and prevent it from moving. The lever also locks into place. The design of the lever must take into account how far a typical user could reach down and how much torque they could apply on the lever. The typical reach of a person in a wheelchair can be found also from the United Nations Division of Social Policy and Development's Program on Disabled People.

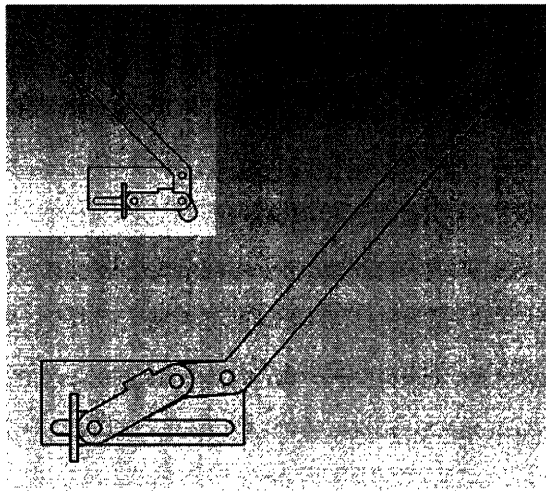

Fig. 13: Possible brake locking mechanism design

7.2 Final Prototype Design

After discussing the initial design with advisor Professor Alex Slocum, several design changes were suggested. Though the general shape and functionality of the design were acceptable, many alterations could be made to simplify the building process as well as decrease the materials use and cost. Taking the suggestions of Professor Slocum and determining what materials could be purchased from McMaster-Carr, the following design changes were decided upon:

1. Flanged ball bearings can be used instead of rollerblade ball bearings. In functionality, they should be equivalent. It will also make the rollers much easier to install. Shaft collars will need to be purchased as well, however, to ensure that the flanged ball bearings stay in place. The largest flanged ball bearings have a bore size of $\frac{3}{4}$ ". This is

desirable, because the larger diameter the supporting rod can be, the less likely bending moments at the frame/roller interface will become an issue.

2. 2"x 2" aluminum angle (.1875" thickness) will be used instead of steel square tubing. It is a cheaper alternative and will be easier to work with as well. In addition, it will require less welding and less complicated cuts. Aluminum angle will also work much better with the installation and placement of the flanged ball bearings. Finally, aluminum angle is preferable to steel because it is cheaper and would not have to be painted.
3. The rollers can be made out of a 1 ¼" diameter 6061 aluminum rod with the ends lathed down the ¾" in order to fit the flanged ball bearings and shaft collars. McMaster-Carr sells aluminum rods in lengths of 36". If this is divided into four equal length rollers minus the lengths of the lathed ends, we get 7" rollers between frame. This falls within the original length estimation.
4. The front of the frame, where the ramp flattens out, will be truncated as it is an unnecessary waste of material. With the front wheels sitting on the inclined ramp, it is found that the wheelchair is even more level than in the previous model. The ramp can be made out of plywood for the prototype. In the eventual design, a more aesthetic and durable material, such as various patterned floor plates, could be used, although these would also add to cost.

The following two figures show the modified design, and the modified roller design.

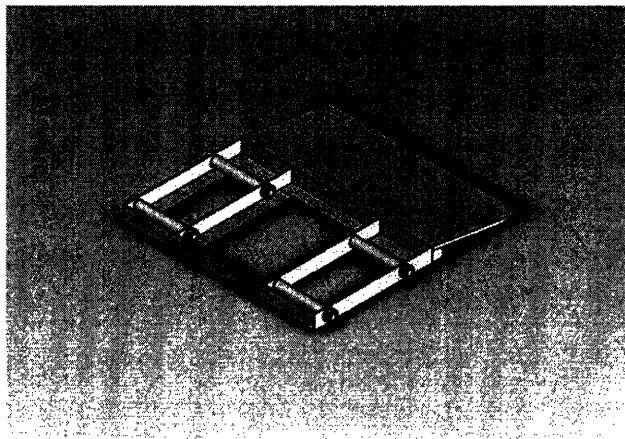

Fig. 14: Final modified solid model design using aluminum angle for the frame, aluminum rods for the rollers, flange ball bearings, and plywood ramp.

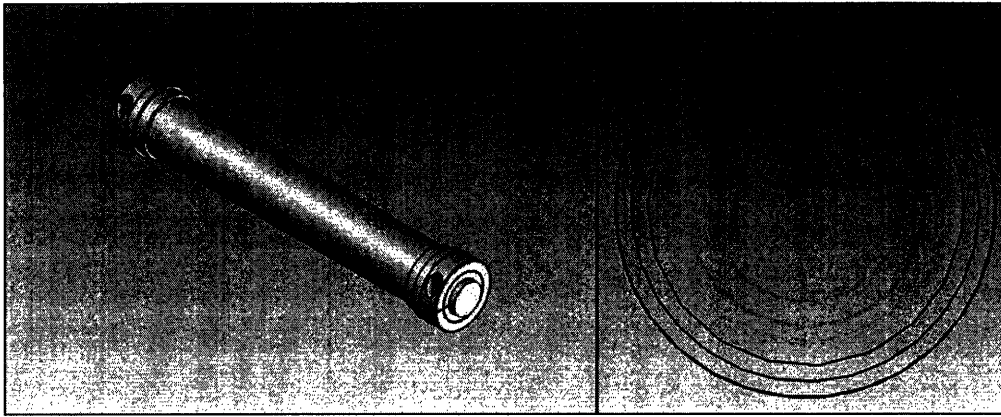

Fig. 15: Left: solid model of the modified roller using 1 ¼” diameter 6061 Aluminum rod, flange ball bearings and shaft collars; Right: cross-section of roller.

The final width of the frame will be 27.5”, to accommodate the 20” width of the wheelchair, the 7” rollers and the width of the steel angle (.1875). The length of the frame will be 17” to accommodate the 10” between frame length, and provide room for the rollers to roll freely. Including the ramp, the overall length will be close to 30”. The holes for the rollers will be 3” from the back frame and 4” from the front frame, respectively. Two other supports for the rollers will be mounted within the main rectangular frame as well.

For the sake of time and complexity, the prototype to be built will incorporate only the three main modules originally outlined in the design, which are the rollers, the frame, and the ramp. The role of the prototype will go to show the potential functionality of the design. One of the biggest differences of the prototype from the original design ideas is that the prototype does not incorporate a flywheel. If the rollers of the final prototype respond similar to the test rollers, they may not accurately simulate the inertia and forces felt when actually rolling along the ground. There is also the lack of a varying resistance. Finally, a tilt mechanism will not be built, both due to the complexity of the design and the cost of materials (the purchase of a motor is necessary). However, the figures below show Solidworks designs of a possible mechanism to incorporate a tilt function and the wheelchair on a tilted ramp.

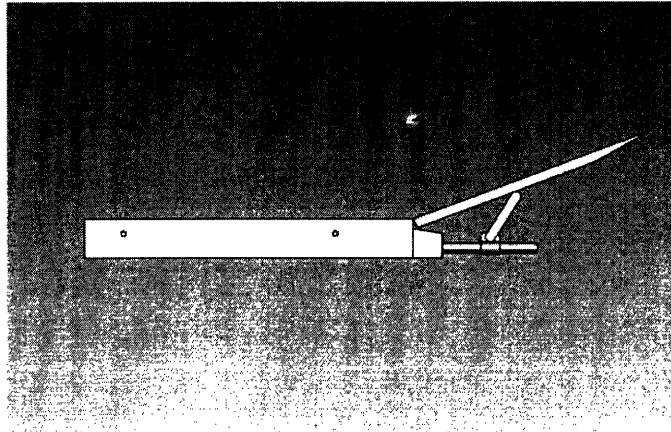

Fig. 16: Side view solid model of the ramp tilt mechanism, utilizing a motor and lead screw.

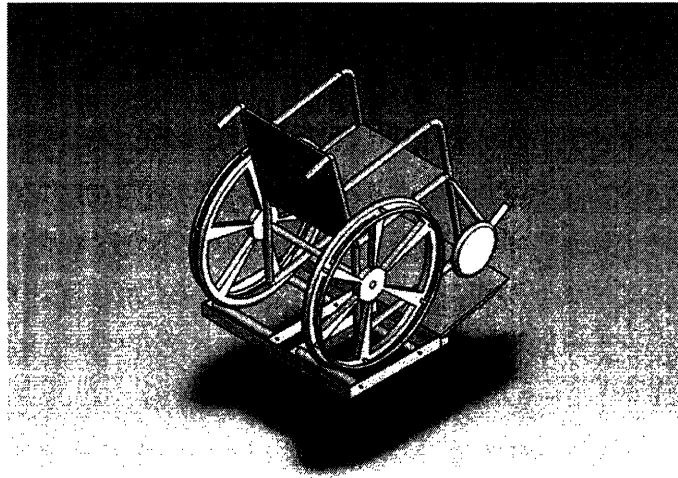

Fig. 17: Solid model showing a wheelchair tilted upwards due to the tilted ramp.

This design simplifies the problem by only raising the ramp. It is a convenient solution as the ramp is both light (made of plywood) and does not support a large percentage of the load. This decreases the amount of motor torque necessary to tilt the wheelchair and the amount of material needed in the hinges to withstand the load being applied to it.

8.0 Building the Prototype

8.1 Ordering and Construction

Based on the final prototype design, the following materials were ordered from McMaster-Carr (Figure 18):

Qty	Part #	Item	Price	Total
2	88805K54	Alloy 6063 Aluminum 90 Degree Angle 3/16" Thick, 2" X 2" Legs, 8' Length	\$39.23	\$78.46
1	8974K163	Alloy 6061 Aluminum Rod 1-1/4" Diameter, 3' Length	\$22.81	\$22.81
8	23775T7	Flanged Ball Bearing for 3/4" Axle Dia, 1-3/8" Bearing OD, 1-1/2" Flange OD	\$4.03	\$32.24
8	6157K16	One-Piece Aluminum Clamp-On Collar 3/4" Bore, 1-1/2" Outside Diameter, 1/2" Width	\$2.87	\$22.96

Fig. 18: Materials, part numbers, and total price of items ordered from McMaster-Carr.

When the parts arrived, construction of the frame began first. Even though the rollers are the most critical module, the integration of the frame and rollers makes each part equally as important. In addition, due to time constraints in working with Steve Haberek at the Pappalardo Lab to have my pieces welded, the frame had to be constructed and finished as soon as possible. Using a horizontal saw, the aluminum angle was cut into the appropriate pieces: 2 x 17", 2 x 27.5", and 2 x 16.625". Then, the ends of the 17" and 27.5" pieces were cut to a 45° angle, so that they could be welded together to make a square frame. Figure 19 shows the finished cut pieces.



Fig. 19: Finished cut pieces and relative placement for wheelchair roller frame

During the construction of the frame, and before the machining and assembly of the rollers, Dick Fenner, director of the Pappalardo lab, became aware of the project. On looking at the roller design to determine the necessary machining needed, he suggested the possible use of conveyor rollers. Fortunately, he happened to have purchased several at a prior time and had no use for them. These specific rollers were also 1 1/4" in diameter, but were 11 inches long. The

rollers were fitted with a ¼” diameter steel rod going through and had two ball bearings mounted within each roller. Because the diameter of the rollers allowed them to fit within then designed frame, and based on the original test results showing that the length of rollers should not affect the functionality of the machine, it was advantageous to use these rollers instead of manufacturing new ones. In addition, conveyor rollers are built to sustain large loads and maintain functionality. Specifications requested from a manufacturer of conveyor rollers nearly identical to the ones used give a load capacity of 50 lbs for each roller¹⁶. Figure 20 shows one of these rollers.



Fig. 20: A conveyor roller

Other similar conveyor rollers (with slightly different roller diameter, axle size/type, or material) can be purchased from McMaster-Carr as well. These all have a load capacity of 100 lbs or greater¹⁷, but tend to be more expensive than replacement conveyor rollers that can be found from a variety of vendors on the internet (though minimum orders must be places).

The introduction of the rollers fortunately occurred before drilling holes into the frame, thus allowing the ability to modify the design to fit these rollers instead. A Bridgeport mill was used to drill holes (using an F drill) into the side frame pieces. Because the side pieces were not cut exactly to length (17”) small modifications to the hole positions were made. The holes remained 10” apart, but the front hole was drilled 3.875” from the front. All holes were drilled 1 ¼” from the bottom of the frame piece. Similarly, the two roller support pieces (16.625” length) were also drilled with holes matching up to the holes in the side frame supports. A mill was used rather than a drill press because of the necessary accuracy in the placement of the holes. Not aligned perfectly, the rollers might function incorrectly. All the pieces were then welded

together. For the prototype, the rollers could not be replaced. However, design changes may need to be implemented in order to allow for replacement rollers in the final product. Some rollers come with spring-loaded axles for easier replacement.

Next, a ramp to allow the user to get on to the machine was built. First, a piece of ½” plywood, approximately 16” in length, was cut to match the width of the frame. Then, using a square bevel, the angle of the incline was set between the ramp and the front of the frame. Using the measurement of this angle, a band saw was used to trim the bottom of the plywood piece, allowing the ramp to be flush with the ground. Then, using a table saw, the side coincident with the frame was trimmed, again to match the angle of the incline. Finally, using a wood 2”x 4” and the measured angle, a support piece was cut with the table saw. The plywood and support piece were then mounted together. Figure 21 below is a picture of the final assembled prototype.

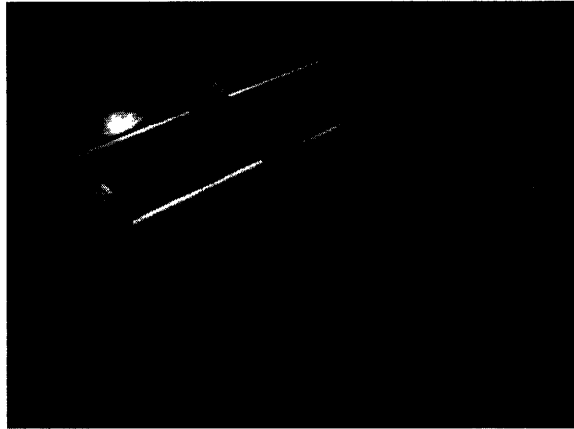

Fig. 21: Completed assembled prototype

9.0 Testing the Prototype

At initial testing, the prototype works as would be expected. The ramp provides a smooth and easy access to the rollers, and the ramp and machine are wide enough to accommodate for not backing in perfectly straight. Also, once the wheelchair falls into place, it naturally self aligns so that the load is distributed evenly among the four rollers. The rollers allow the wheels to move very smoothly without too much wobble, and it appears that any motion may actually be coming from the wheelchair (which was observed to wobble at certain speeds even on flat ground). Compared to the test rollers, which utilized the rollerblade ball bearings, the conveyor rollers tend to spin with less friction. After the initial push, they remain spinning for a longer period of time. This is a more accurate simulation of the real feeling, but

due to the reduced friction, the force necessary to propel the wheelchair is greatly reduced. An aerobic workout can definitely still be achieved, however.

10.0 Conclusions and Future Plans

This prototype is definitely not ideal, and at this stage in development is still not a viable product. Although the potential functionality is clearly there, there are many different aspects to the product that need to be more carefully worked out and tested. First, the incorporation of a flywheel should not be too difficult of an addition. It would be interesting to feel the difference in the rollers by simply coupling the rollers to a disc of larger mass. With the proper materials and testing means, an appropriate mass could be determined that most closely mimics the motion of a regular wheelchair's movement. This is most certainly the first step into improving the overall product.

Next, the tilting mechanism, though in some respects simply a novelty, is an addition that would also not be too difficult to incorporate. However, the questions regarding it, is whether or not the monetary investment (i.e. how much extra the product may cost to incorporate the electronics) is worth the physical benefit that would be received from such a feature. While it is clear that this feature would add a new dimension to the exercise machine and is novel in comparison to the already existing products on the market, many typical consumers may not find this feature necessary or worth their money. It truly depends on who the customer is. If the product is to be marketed to regular everyday consumers, cost may be the deciding factor over features. If the customer is a rehabilitation center or a fitness center for disabled people, then features may be a deciding factor over cost. Given that the initial product conception was meant to be marketed to everyday consumers, a motorized element may not necessarily be worth it.

Finally, varying resistance is a feature that should definitely be included in the product whether or not it is being marketed to regular consumers or to disability centers. However, many different resistance attachments (that work by a variety of methods) already exist and are already marketed by several companies. Instead of developing a new technology, it may be economically viable to work with another company to modify existing technology to fit this product. Figure 20 shows two types of resistance attachments.

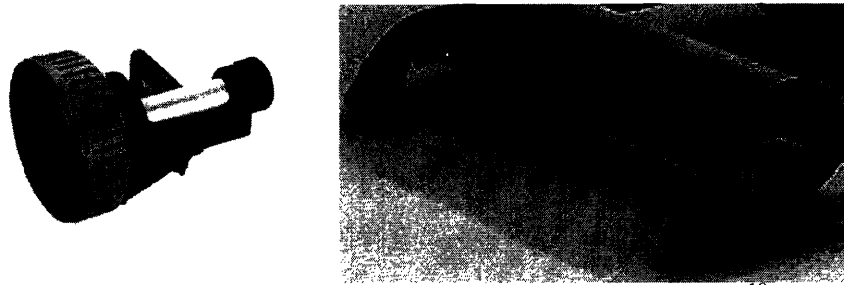

Fig. 20: Two types of roller resistance from companies Performance®¹⁸ and CycleOps®⁸

In addition to this, it may also be possible to work with existing companies to use their roller technologies and apply it to a wheelchair accessible device. Because these companies are already mass producing rollers and bearings that are designed for this exact purpose, it is not inconceivable that the company could branch off into creating a new product. A collaboration such as this would not only speed up the overall design process, but could also significantly curb manufacturing and design costs. Typical bicycle roller applications are sold anywhere from \$150 - \$300+. Ideally, a wheelchair exercise roller package could cost on the order of this – still at least more than half the price of the lowest existing price for a wheelchair roller. By pricing it in this range, nearly any wheelchair user that desired such a product would be able to purchase one.

Finally, there are still many places that this product could go. Because the prototype was largely designed to show potential functionality, it does not reflect what this product could turn in to. The prototype is simply a skeleton of an eventual marketable product. It is not what the final design would look like. It is already clear, in fact, from looking at my own design process, how the design evolved from step to step for either aesthetic or functional purposes. Given more time and design experimentation, the eventual final product may look noticeably different from the completed prototype. Keeping this in consideration, the whole process of designing this new potential product – examining the need for the product, determining the functional requirements, determining the geometry of components, examining the necessary materials – has still, however, come to show that a stronger and less expensive product could be achieved.

Acknowledgements

Thank you to the following people:

- Steve Haberek for welding my prototype
- Dick Fenner for providing conveyor rollers for me
- Tom Cronan and MIT Sports Medicine for allowing me to borrow their wheelchair
- Mitch Carr from the Rehabilitation Institute of Chicago for taking the time to speak with me about my design
- Noah Riskin and Aline Newton for providing physical intelligence input throughout the term
- Professor Alex Slocum for support, design, and thesis input.

References

- 1 Karp, G. (1999) "Life on Wheels: For the Active Wheelchair User." Patient Centered Guides Retrieved April 15, 2005 from <http://www.patientcenters.com/wheels/news/exercise.html>
- 2 McClintock, P. (2004) "Overuse Injuries in Wheelchair Users." National Center for Physical Activity and Disability Retrieved April 16, 2005 from <http://www.ncpad.com>
- 3 Image (February 2, 2005) retrieved April 28, 2005 from <http://www.sportaid.com>
- 4 "Aero-Trak," Exercise Fitness and Leisure (2001). Retrieved March 17, 2005 from http://www.exercise.co.uk/aero_trak.products/use.id.5.item_id.779.dept.1.cat.29/
- 5 "Wheelchair Training Rollers." Accessible Designs, Inc. (2003) Retrieved March 17, 2005 from <http://accessibledesigns.com/newroller.htm>
- 6 Roszko, Jared, Leschinski, M., Lim, H. P. "Wheelchair Treadmill." Retrieved May 12, 2005 from members.tripod.com/wheelchair_treadmill/
- 7 "Best Exercise Bikes," (2005) Mercantila. Image, retrieved May 5, 2005 from http://www.exercise-bikes-direct.com/catalog/buy/Exercise_Bike/exercise_bike_best/
- 8 Images (2003) retrieved April 28, 2005 from <http://www.cycleops.com>
- 9 Image (2004-2005) retrieved April 28, 2005 from http://www.coolbusinessideas.com/archives/super_trainer_bicycle_treadmill.html
- 10 "Accessibility for the Disabled – A Design Manual for a Barrier Free Environment." United Nations Enable (2003-2004) Retrieved April 28, 2005 from <http://www.un.org/esa/socdev/enable/designm/AD5-02.htm>
- 11 "Team CPK," Retrieved April 8, 2005 from <http://cpkweb.com/RacerBios.htm>
- 12 "LA College Puts Speed Limit on Wheelchairs," Accessibility.com (Jan 17 2003) Retrieved April 28, 2005 from http://www.accessibility.com.au/news/internat/speed_wheel.htm
- 13 Slocum, Alexander, "Fundamental of Design, Bearings" (2005) 2.007 Design Lectures, Retrieved May 12, 2005 from <http://pergatory.mit.edu/2.007>
- 14 Slocum, Alexander, "Design with Bearings," (2000) 2.007 Design Lectures, Retrieved May 12, 2005 from <http://pergatory.mit.edu/2.007>
- 15 "HAI – Access for all," Hospital Audiences.org (March 18, 2005). Retrieved May 1, 2005 from <http://www.hospitalaudiences.org/database/a4a-pref.htm>
- 16 Information retrieved by contacting www.materialflow.com
- 17 "Conveyor Rollers," McMaster-Carr (2005). Retrieved May 12, 2005, from www.mcmaster.com
- 18 Image retrieved April 28, 2005 from http://www.performancebike.com/shop/profile.cfm?SKU=17568&subcategory_ID=4122