

MASSACHUSETTS INSTITUTE OF TECHNOLOGY
13.413
PROJECT IN NAVAL SHIP CONVERSION
SPRING 2003

ADVANCED GUN SYSTEM (AGS) BACKFIT

DD-988 NAVAL GUNFIRE SUPPORT SHIP
CONVERSION

LT JULIE HIGGINS
LT JASON RHOADS
LT MICHAEL ROACH

EXECUTIVE SUMMARY

Installation of the AGS in USS THORN can be accomplished while retaining most of the baseline capabilities of the platform. The outcome of the analysis of alternatives indicated that placement of AGS mount aft, in place of Mount 52 and the NATO Sea Sparrow Missile system, as the preferred alternative. Among the reasons for its selection was the 304 round capacity of its magazine, the retention of more major war-fighting capabilities, and the minimization of cost and baseline ship impact. This configuration results in degradation of the AAW self-defense capability of the modified USS THORN, due to the loss of the NSSMS. However, with the full preservation of the baseline strike and anti-submarine capabilities, the ship remains a viable war-fighting platform.

The modified USS THORN exhibits structural characteristics largely unaffected by the installation of AGS. Electrical and auxiliary systems are seen to be capable of accommodating the gun system, although slight doctrine changes such as placing additional pumps online or splitting the electrical bus may be necessary. The electrical system will experience an increase of 719kW under battle conditions, best configured by splitting the bus to prevent the electrical draw of the gun from tripping other systems offline. The fire main system experiences an increased demand of 2438gpm, mostly due to a very high flow magazine sprinkling system, with the installation of the AGS. Placing additional fire pumps online can accommodate this increased demand. The chilled water system experiences an increase in demand of 31gpm, also correctable by placing additional chilled water pumps online if necessary.

Stability and seakeeping characteristics of the modified USS THORN are seen to differ only slightly from the baseline configuration. Further, all requirements of AAO-AA-SPN-010/Gen-Spec, DDS 100-1, 2, 4, 5, 6, 7, DDS 079-1 and DDS 079-2 are met by the modified USS THORN.

| | |
|--|-----------|
| EXECUTIVE SUMMARY | II |
| 1.0 -- MISSION NEED | 1 |
| 1.1 -- NATIONAL GUIDANCE AND POLICY | 2 |
| 1.2 -- CURRENT CAPABILITY ASSESSMENT | 2 |
| 1.2.1 -- <i>Anti-Submarine Warfare</i> | 4 |
| 1.2.2 -- <i>Anti-Surface</i> | 4 |
| 1.2.3 -- <i>Anti-Air</i> | 4 |
| 1.2.4 -- <i>Communications and Tactical Information</i> | 5 |
| 1.2.5 -- <i>Engineering</i> | 5 |
| 1.3 -- MISSION NEED | 5 |
| 2.0 -- DESIGN REQUIREMENTS AND PLAN | 7 |
| 2.1 -- REQUIRED OPERATIONAL CAPABILITY | 7 |
| 2.2 -- CONCEPT OF OPERATIONS/OPERATIONAL SCENARIOS | 7 |
| 2.3 -- GOALS, THRESHOLDS, CONSTRAINTS, AND STANDARDS | 8 |
| 2.4 -- RECOMMENDED ALTERNATIVES | 9 |
| 2.5 -- DESIGN PHILOSOPHY | 9 |
| 3.0 -- CONCEPT EXPLORATION | 11 |
| 3.1 -- OPTION 1: FORWARD MOUNT AT FRAME 70 | 11 |
| 3.1.1 -- <i>War-Fighting Capabilities Assessment</i> | 11 |
| 3.1.2 -- <i>Weight and Stability Analysis</i> | 12 |
| 3.2 -- OPTION 2: AFT MOUNT AT FRAME 440 WITH STANDARD MAGAZINE | 13 |
| 3.2.1 -- <i>War-Fighting Capabilities Assessment</i> | 14 |
| 3.2.2 -- <i>Weight and Stability Analysis</i> | 14 |
| 3.3 -- OPTION 3: AFT MOUNT AT FRAME 440 WITH EXTENDED MAGAZINE | 15 |
| 3.3.1 -- <i>War-Fighting Capabilities Assessment</i> | 16 |
| 3.3.2 -- <i>Weight and Stability Analysis</i> | 16 |
| 3.4 -- FINAL BASELINE CONCEPT DESIGN | 17 |
| 4.0 -- FEASIBILITY STUDY AND ASSESSMENT | 19 |
| 4.1 -- DESIGN DEFINITION | 19 |
| 4.1.1 -- <i>Principal Ship Characteristics Summary</i> | 19 |
| 4.1.2 -- <i>Arrangement</i> | 19 |
| 4.1.3 -- <i>Electrical and Auxiliaries</i> | 22 |
| 4.1.4 -- <i>Structural Design</i> | 25 |
| 4.1.5 -- <i>Weights, Stability and Margins</i> | 25 |
| 4.1.6 -- <i>Survivability</i> | 26 |
| 4.2 -- PERFORMANCE ANALYSIS (MISSION/OPERATION SCENARIOS) | 27 |
| 4.2.1 -- <i>Mission</i> | 27 |
| 4.2.2 -- <i>Seakeeping</i> | 27 |
| 4.2.3 -- <i>Underway Replenishment</i> | 27 |
| 4.3 -- COST | 28 |
| 4.3.1 -- <i>Total Estimated Cost</i> | 28 |
| 5.0 -- DESIGN CONCLUSIONS | 29 |
| 5.1 -- SUMMARY OF FINAL CONCEPT DESIGN | 29 |
| 5.2 -- FINAL CONCEPT DESIGN ASSESSMENT AND CONCLUSIONS | 29 |
| 5.3 -- AREAS OF FURTHER INVESTIGATION | 29 |
| LIST OF REFERENCES | 30 |

APPENDIX A – MISSION NEED STATEMENT FOR INSTALLATION OF THE ADVANCED GUN SYSTEM ON SPRUANCE CLASS DESTROYERS31

APPENDIX B – OPTION 1 DETAILS.....33

APPENDIX C – OPTION 2 DETAILS40

APPENDIX D – OPTION 3 DETAILS45

APPENDIX E – STRUCTURAL ANALYSIS51

APPENDIX F – STABILITY ANALYSIS58

APPENDIX G – PERMEABILITY83

APPENDIX H – SEAKEEPING.....85

APPENDIX I – COST ANALYSIS88

1.0 -- MISSION NEED

The purpose of this study is to design and evaluate the installation of the Advanced Gun System (AGS), designed for the DD(X) class of ship, on a Spruance-class destroyer as a “technology shake-down” platform. By testing and evaluating the performance of the AGS prior to lead-ship installation in the DD(X) program, significant risk mitigation can be accomplished. Therefore, this early technology insertion is essential to the success of a major weapon system in the DD(X) program. This feasibility-level investigation represents the groundwork for at-sea testing of the AGS on an existing Spruance-class platform. As a follow-on to the Arleigh Burke-class program, the Navy is evaluating concepts for a new generation of surface combatants that is expected to provide the future fleet with the necessary capabilities and to be built in sufficient quantities to provide the required number of ships for overseas presence and war-fighting missions. The DD(X) will initially replace older ships of the Spruance-class (DD-963) and Oliver Hazard Perry-class (FFG-7).

The DD(X) program encompasses a family of three surface combatant ships: a destroyer, a cruiser, and a smaller littoral operations craft. The DD(X) family will support the National Security and Military Strategies, which require the Navy to provide forces to support the major missions of Conventional and Strategic Deterrence: Land Attack, Theater Air Defense, Sea Control, Forward Presence, and Strategic Sealift. Required capabilities delineated in the Mission Needs Statement (MNS) include: Power Projection; Battlespace Dominance; Command, Control and Surveillance; Joint Force Sustainment; Non-combat Operations; and Survivability / Mobility.

The DD(X) program will provide a baseline for spiral development of the DD(X) and the future cruiser or "CG(X)" with emphasis on common hullform and technology development. The Navy will use the advanced technology and networking capabilities from DD(X) and CG(X) in the development of the Littoral Combat Ship with the objective being a survivable, capable near-land platform to deal with threats of the 21st century. The intent is to innovatively combine the transformational technologies developed in the DD(X) program with the many ongoing R&D efforts involving mission-focused surface ships to produce a state-of-the art surface combatant to defeat adversary attempts to deny access by U.S. forces.

The scope and complexity of the design work, which includes development and integration of new hull and ship systems as well as advanced combat systems, is unprecedented for a U.S. Navy surface combatant. To mitigate the risk associated with this project, Engineering Development Models (EDMs) are to be built and tested in parallel for key systems such as the integrated power system (IPS), the advanced gun system (AGS), and an integrated radar suite. Land-based and selected at-sea testing of the EDMs will be performed with the results engineered into the total ship system design. This feasibility-level investigation represents the groundwork for at-sea testing of the AGS EDM on an existing Spruance-class platform.

The AGS is a 155mm Gun Weapon System planned for installation in the DD(X) destroyers to provide high-volume, sustainable gunfire in support of amphibious operations and joint land battles. AGS is a fully integrated gun weapon system that will include at least one gun system for each DD(X) warship. The gun system will be capable of firing up to 12 rounds per minute from an automated magazine storing as many as 600 rounds. The 155mm rounds are about 6.1 inches in diameter, versus the 127mm diameter of the standard 5-inch projectile. The AGS ammunition is equivalent to the USMC M198 155mm Howitzer in firepower. The AGS program also includes development of a 155mm version of the Long Range Land Attack Projectile (LRLAP) as the first of a family of AGS munitions capable of

hitting targets accurately up to a distance of 100 nautical miles. Efforts are underway to achieve as much commonality as possible with U.S. Army 155mm projectiles.

The developer and manufacturer of the AGS is United Defense Limited Partnership, Minneapolis, Minnesota. United Defense began the design of the AGS in 1999 under a Section 845 Agreement with Bath Iron Works, the lead contractor for the DD 21 Shipbuilding Alliance. During 1999 United Defense conducted detailed analysis and trade studies for the AGS and recommended using a conventional single-barrel 155-mm naval gun. With the approval of the Shipbuilding Alliance and the Navy, United Defense began preliminary design of the AGS in November 2000.

With fully automated magazines and LRLAPs, the AGS in DD(X) will radically influence future naval gun developments. The vision for a littoral warfare strategy requires a system capable of providing effective and sustained Naval Surface Fire Support (NSFS) for amphibious operations and joint land battles. AGS will provide the needed accuracy, range, responsiveness, and volume of fire to fully meet the Navy's NSFS requirements.

As a result of this new gun technology, rigorous field and operational testing of the AGS is essential to the success of its installation on the DD(X) class of platforms. By installing AGS on Spruance-class destroyers in the near-term, at-sea evaluations can be conducted while simultaneously enhancing the war-fighting capabilities of a current, operational naval combatant.

1.1 -- NATIONAL GUIDANCE AND POLICY

Technical Instruction (TI) #6 of NAVSEA Contract Number N00024-02-C-2302 authorized engineering studies of ship's structure, support systems, combat system, and self-defense and stability requirements to determine the feasibility of installing and integrating the DD(X) Advanced Gun System (AGS) and its automated ammunition magazine on a Spruance-class (DD-963) ship. Northrop Grumman Ship Systems (NGSS) and United Defense LP (UDLP) subsequently executed a feasibility-level study (released in November 2002) to assess a rapid prototype gun installation concept that is also available for contingency operations.

The NGSS/UDLP analysis presumed removal or inactivation of numerous DD-963 systems assessed as not essential for self-defense, routine ship operations, or execution of the AGS Naval Gun Fire mission in order to provide necessary volume and weight allowance for AGS installation and reduce overall ship manning, operations and support (M, O&S) costs. New systems were added only to the extent necessary to sustain Naval and Joint interoperability or to facilitate execution of Naval Gun Fire. The converted ship was to retain a self-defense system capability comparable to planned upgrades for the amphibious ship force.

The resulting conversion provided a focused fire support ship that, in contingency operations, is capable of executing Naval Gun Fire missions envisioned for the AGS. As compared to an unmodified ship, the removal or inactivation of DD-963 systems enables a significant reduction in shipboard manning and an attendant reduction in overall ownership cost, but at the expense of creating a single mission NSFS platform.

Given the Navy's desire to incorporate the AGS into a Spruance-class ship with the minimum reduction in war-fighting capability, the present study was executed as an independent data point to assess the feasibility of integrating the AGS while maintaining balanced combat capabilities.

1.2 -- CURRENT CAPABILITY ASSESSMENT

Thirty-one Spruance-class destroyers were developed for the primary mission of anti-submarine warfare, including operations as an integral part of carrier taskforces. They have completed a long-term

modernization program during which they received SH-60B helicopters, Tomahawk missiles, and the Phalanx weapon system. Adding the Tomahawk suite has greatly expanded the Spruance's role in strike warfare. These expansions were made possible by the relatively large size of the Spruance-class ships. The Spruance-class destroyers are more than twice as large as a World War II destroyer and as large as a World War II cruiser.

The DD-963-class is expensive to maintain because of its age and large crew size and provides only marginal war-fighting capability due to the ship's older and more focused mission combat system. As of early 2002, the Navy had decided to decommission the 19 remaining Spruance-class destroyers by fiscal year 2006. The NGSS/UDLP conversion study investigated four of these platforms scheduled for decommissioning within the next 18 months to determine the best candidate for installation of the AGS. The study used nine factors to gage their decisions:

1. Scheduled decommissioning date and scheduled dockside maintenance periods.
2. Primary ship alteration mix.
3. Maintenance availability history and available growth margin.
4. Present displacement and KG status.
5. Port engineer recommendation/input.
6. Corrosion control input.
7. On-Site Tech Rep (OSTR) input.
8. Hull integrity/catastrophic event history.
9. 2-KILO maintenance item history.

The four platforms investigated were:

1. USS RADFORD (DD-968)
2. USS THORN (DD-988)
3. USS DEYO (DD-989)
4. USS BRISCOE (DD-977)

This extensive and thorough investigation led to the identification of USS THORN (DD-988) as the best candidate for installation of the AGS. The present conversion feasibility study accepts USS THORN as the preferred platform for AGS installation.

Built with future growth in mind, the Spruance design is modular in nature, allowing for easy installation of entire subsystems within the ship. Space and power margins were included to accommodate future weapons and electronics systems as they were developed. But displacements have risen considerably as equipment has been added; they were originally intended to displace under 7,000 tons in the full load condition. DD-988 displaces approximately 8741 long tons in the full load condition in its current configuration.

USS THORN had an earlier modernization with the introduction of the Vertical Launch System (VLS), which extended the combat system life beyond 20 years. The ship provides additional war-fighting capabilities with two MK45 5in/54cal guns and an Anti-Submarine Warfare (ASW) suite.

1.2.1 -- ANTI-SUBMARINE WARFARE

Anti-submarine warfare (ASW) capabilities include a sonar suite that contains one of the most advanced underwater detection and fire control systems on a surface platform. ASW weapons include two triple-barrel Mk 32 torpedo tubes and the Vertical Launch ASROC missile. In addition, the ships can embark two SH-60B LAMPS Mk III helicopters to extend the range of the ship's weapons and sensors. Ultimately fitted with the integrated SQQ-89 sonar system, incorporating the SQS-53B active bow sonar and the SQR-19 TACTASS and with twin hangars for LAMPS Mk III helicopters, USS THORN represents the forefront of the surface Navy's defense against submarine attacks.

1.2.2 -- ANTI-SURFACE

USS THORN received a 61-cell Mk 41 vertical-launch group in place of the deck-mounted ASROC launcher; the nominal load-out is 45 Tomahawk cruise missiles and 16 Vertical Launch ASROC, with Tomahawk launch performed by the Advanced TOMAHAWK Weapons Control System (ATWCS) launch system. This system enables USS THORN to engage shore-based and naval surface targets at long range. In its strike platform role, modernization makes this ship a formidable platform for offensive strikes against targets of military significance deep in enemy territory. State-of-the-art computer and satellite technology allow the ship to launch up to 61 precision-guided TOMAHAWK cruise missiles from its Mk 41 VLS at land targets as far away as 700 nautical miles.

USS THORN has had a major role in Naval Surface Fire Support (NSFS) for troops ashore, employing Harpoon anti-ship missiles and two 5-inch guns (also used for air defense and shore bombardment). The Harpoon Missile System is proven effective in engaging shipping at intermediate ranges. Fitted with two MK 45 lightweight 5in/54cal guns when built, the main battery can propel a projectile over 12 miles with a firing rate of 20 rounds per minute. The 5in/54cal gun represented a major step forward in medium-caliber ordnance for the U.S. Navy. The result is a weapon that allows a single man in a control center to fire a salvo of 20 shells without manual reloading of the 5-inch gun.

1.2.3 -- ANTI-AIR

Air defense capabilities include the NATO Sea Sparrow surface to air missile system, two 20mm Phalanx Close-In-Weapons Systems, the RAM system and the SLQ-32 Electronic Counter Measures system. NATO Sea Sparrow Point Defense Missile System (NSSMS), also known as Sea Sparrow, is a close-in air defense system employing the RIM-7M Sparrow Missile. The system is designed to counter the threat of enemy aircraft and anti-ship cruise missiles. In 1998, the Navy had assessed the ship self-defense capability of the whole class as being moderate relative to meeting the near-term threat requirement and low relative to meeting the mid-term threat requirement.

USS THORN has a capable self-defense system, with adequate low-altitude flyer detection source Mk 23 Target Acquisition System (TAS)/NSSMS Fire Control RADAR (FCR) in sector search. It provides moderate field-of-fire blockage zones for NSSMS off port/starboard bow. However, the missile range is short, and the long-range air search radar is 2D. The ship must be within 1.5nm of the High Value Unit (HVU) and on the threat axis to provide realistic area defense.

1.2.4 -- COMMUNICATIONS AND TACTICAL INFORMATION

The radio equipment aboard USS THORN enables transmission and receipt of messages from any part of the world. Communicating within a battle group for tactical purposes is accomplished through the Naval Tactical Data Systems (NTDS). All combat detection, tracking and fire control systems are integrated through the ship's digital Naval Tactical Data System Computer, providing the ships with fast and accurate processing of tactical information. Using high-speed computer-to-computer data links, NTDS assimilates the processing capabilities and sensors (RADAR, SONAR, etc.) of each of the individual units in company, presenting a complete tactical picture.

USS THORN has the NATO Link 11 data-sharing system. ASW is handled by the Mk 116 fire-control system. The Mk 91 Mod 0 fire-control system for Sea Sparrow uses a single radar director. In addition to the Cooperative OUTBOARD Logistics Update (COBLU) Phase I Signals Exploitation System, USS THORN has a SLQ-32 electronic warfare sensor, which provides tactical detection and analysis of enemy electronic emissions.

The AN/SYQ-17 RAIDS (Rapid Anti-ship Missile Integrated Defense System) system serves as a rule-based planning aid to coordinate the use of the ship's defensive systems and uses target input from the Phalanx CIWS RADAR. USS THORN also has four Super Rapid Blooming Off-board Chaff (SRBOC) Launchers and four SLQ-49 decoy launchers to confuse and decoy enemy homing missiles.

1.2.5 -- ENGINEERING

The Spruance-class ships were the first class of ships in the US Navy to have complete gas turbine propulsion and electrical generation power. The four General Electric LM-2500 engines are marine versions of the TF39 turbofan used on DC-10 and C-5A aircraft. Rated at 20,000 shaft horsepower each, the four main engines are similar to those found in modern jet aircraft and allow the ship to reach speeds in excess of 30 knots. Full speed can be reached from 12 knots in only 53 seconds. All propulsion machinery is under the control of a single operator in a central control station (CCS). Each of the three ship's service gas turbine generators produces 2,000 kilowatts of power. With two engines per shaft, the two shafts are each driven by locked train, double reduction and double helical reduction gears. Twin controllable-reversible pitch propellers provide the ship with a degree of maneuverability unique among warships of its size. The controllable-pitch propellers are 15ft in diameter and rotate at 168rpm at 30 knots.

1.3 -- MISSION NEED

The objective of this feasibility-level study is to determine the feasibility of installing and integrating the DD(X) AGS and automated ammunition magazine on a DD-963 class ship with minimal war-fighting degradation. This is conducted in accordance with the "Mission Need Statement for Installation of the Advanced gun System on Spruance Class Destroyers" ([Appendix A](#)). As a minimum, the feasibility studies shall include:

1. Engineering analyses of ship weight, moment, draft, speed, and stability for the installation concept.
2. Analyses of ship's services requirements for all AGS gun weapon system operating modes including but not limited to: electric power generation, power switching, power distribution, and chilled water.

3. Assessment of AGS impact on the ship's primary war-fighting mission areas (i.e. ASUW, ASW, etc.)
4. Analysis of magazine capacity with respect to Long Range Land Attack Projectiles (LRLAP).
5. Analysis of underway and vertical replenishment system and equipment to accommodate AGS palletized ammunition.
6. On the basis of the notional design concept, a rough order-of-magnitude (ROM) cost estimate.

2.0 -- DESIGN REQUIREMENTS AND PLAN

The overarching design philosophy of this conversion study is to augment an existing Spruance-class destroyer, in this case USS THORN, with the addition of the Advanced Gun System. This is to be accomplished while minimizing the degradation of the original war-fighting capabilities. The goal is to produce a multi-mission U.S. Navy warship with enhanced NSFS capabilities that meets all requisite U.S.N. combatant standards.

2.1 -- REQUIRED OPERATIONAL CAPABILITY

The Required Operational Capability of the converted USS THORN shall maintain a maximum of the existing ship capabilities while adding extended range NSFS to the ship. Table 1 lists the Required Operational Capabilities of the unmodified baseline USS THORN, and serves as a tool by which to measure the impact of possible system alterations.

| Table 1 -- Required Operational Capabilities of Unmodified USS THORN | |
|---|---|
| ROC's | Description |
| AAW 1.2 | Provide unit self-defense |
| AMW 6 | Conduct day and night helicopter operations |
| AMW 6.4 | Serve as a helo hangar |
| AMW 14 | Support/conduct Naval Surface Fire Support (NSFS) against designated targets in support of an amphibious operation |
| ASU 1 | Engage surface threats with anti-surface armaments |
| ASW 1 | Provide ASW defense against submarines for surface forces, groups and units |
| C4I 3 | Provide own unit's C4I functions |
| SEW 2 | Conduct Sensor and ECM operations |
| SEW 3 | Conduct sensor and ECCM operations |
| FSO 6 | Conduct SAR operations |
| INT 1 | Conduct intelligence collection |
| MIW 4 | Conduct mine countermeasures (avoidance) |
| MOB 1 | Steam to design capability in most fuel efficient manner |
| MOB 3 | Prevent and control damage |
| MOB 5 | Maneuver in formation |
| MOB 7 | Perform seamanship, airmanship and navigation tasks (navigate, anchor, mooring, scuttle, life boat/raft capacity, tow/be-towed) |
| MOB 10 | Replenish at sea |
| MOB 12 | Maintain health and well-being of crew |
| NCO 3 | Provide upkeep and maintenance of own unit |
| NCO 19 | Conduct maritime law enforcement operations |

2.2 -- CONCEPT OF OPERATIONS/OPERATIONAL SCENARIOS

The Concept of Operations and Operational Scenarios of the converted USS THORN with the AGS are essentially the same as those of unmodified Spruance-class destroyers with similar weapons system configurations, but with the added mission capability of extended NSFS. This configuration should allow the modified USS THORN to retain its utility as a Carrier Battle Group (CBG) or Amphibious Ready Group (ARG) asset in a traditional destroyer role of ASW, ASUW, Command, Control, Communication

Computers and Information (C4I), and Maritime Interdiction Operations (MIO) when the capabilities of the AGS are not required.

When the capabilities of the AGS with LRLAP are required, USS THORN will act as a Fire Support Ship. The Fire Support capability of USS THORN will be used mainly for direct NSFS of Marine Corps beach landing assaults. A secondary mission capability of the AGS could be the limited tactical bombardment of targets close to the shore. Table 2 depicts the probable NSFS scenario encountered by the modified USS THORN.

| Table 2 - Probable Scenario of Action for Modified USS THORN | |
|---|---|
| Day | |
| 1-6 | Transit with ARG from forward base to area of hostilities |
| 7-8 | Before arrival, detach from ARG. Proceed independently to within 25 nm of amphibious assault point. |
| 8 | Avoid/neutralize enemy diesel submarine attack. Prosecute, engage and kill enemy submarine. |
| 9-12 | Receive targeting information and perform cruise missile strike. |
| 13-16 | Conduct EM, visual and radio reconnaissance. |
| 17-18 | Conduct Helo surveillance of enemy targets at assault point. |
| 17 | Detect, engage and kill incoming cruise missile salvo on own unit. |
| 18-20 | Rejoin and escort ARG. |
| 19-20 | Continue Helo operations in support of landing operations. |
| 19-20 | Continue NSFS operations in support of landing operations. |
| 19 | Engage and destroy enemy patrol craft using missiles. |
| 20-22 | Escort ARG to forward base for rearming and embarking. |
| 22 | Rearm missiles at forward base. |

2.3 -- GOALS, THRESHOLDS, CONSTRAINTS, AND STANDARDS

The goal of the conversion project is to add the Advanced Gun System to USS THORN while maintaining its utility as a USN combatant. Because of the size and weight of the AGS hardware, it is anticipated that some current systems and installed hardware may be removed to accommodate this need for space and weight allowance. This not only entails balancing such parameters as overall displacement, center of gravity, ship's trim, electrical power and auxiliary services, but also the mix of war-fighting tools on the modified platform.

Measuring the performance of any possible conversion configurations of USS THORN with respect to the traditional naval architectural parameters such as displacement and trim is best conducted using the system of standards already in place. For the purposes of this conversion study, the following U.S. Navy standards will be addressed:

1. General Specifications for Ships of the United States Navy, NAVSEA (AAO-AA-SPN-010/Gen-Spec)
2. Structural Strength: Design Data Sheet (DDS) 100-1, 2, 4, 5, 6, 7
3. Stability and Buoyancy: DDS 079-1
4. Freeboard: DDS 079-2

The performance of the modified USS THORN, as a function of the combat systems mix, can also best be measured by an existing system. To scale the possible mixes of combat systems and hardware on all candidate configurations of the modified USS THORN, the standards established in the Ships Operational Readiness and Training System (SORTS) for the unmodified Spruance-class platform will be used as the baseline. Any permutation of combat system configuration on the modified USS THORN will be considered the functioning systems on a baseline Spruance for purposes of measuring the operational readiness (or M-Rating) of that configuration. For example, a combat systems combination may forgo the NATO Sea Sparrow Missile System (NSSMS) to accommodate the AGS. The M-Rating of this configuration would be determined by finding the M-Rating of a baseline Spruance with an inoperable NSSMS. Hence, the combat systems mix that retains a higher M-Rating represents a superior multi-mission capability.

Aside from limitations imposed by the standards adopted above, additional designer imposed limitations are also considered in this conversion feasibility study. A limiting threshold of the conversion project is to use no more than 50 to 75 percent of the available margins in each respective area. That is, any modified USS THORN configuration should utilize no more than three-quarters of the available weight margin, KG margin, et cetera.

2.4 -- RECOMMENDED ALTERNATIVES

Three alternatives are considered for the Spruance-AGS conversion. The first option is to place the AGS forward in place of the forward 5in/54 gun mount (Mount 51) and VLS launcher. A variation of this option was previously studied by Northrop Grumman Ship Systems (NGSS) and United Defense LP (UDLP). This study places the AGS forward and utilizes two magazines: one forward beneath the AGS mount and one aft in the existing mount 52 spaces with an ammunition transfer system along the main deck. The remaining two options involve placing the AGS system in the aft portion of the ship in place of the NSSM launcher and the aft 5in/54 gun mount (Mount 52). One of the aft alternatives replaces the two aft decks under the (removed) 5in/54 mount with automated magazine spaces and places a smaller primary magazine under the AGS mount located where the NSSM is removed. The second aft alternative is a modification of the above arrangement with an additional magazine space located on the main deck in an extension built out from the NSSM deck, over the original location of the 5in/54 mount.

A fourth possible alternative is to add AGS gun mounts both forward and aft, in place of Mounts 51 and 52. While this option may seem to be the most attractive from the view point of NSFS power projection, the electrical power requirements of the two AGS mounts (approximately 800 kW per mount) eliminates this option as not viable without significantly altering the electrical generating capacity of the ship. These alterations are considered well beyond the scope of this feasibility-level study. Therefore, this configuration is considered unfeasible with no further concept development.

Each of the alternatives assessed encompasses a variety of arrangements on a more detailed scale, including different magazine and track layouts, and elevator alignments. For the scope of the analysis of alternatives, a representative arrangement for each alternative is chosen for comparison purposes. An initial assessment of the various designs is performed to indicate the most feasible design in conjunction with the minimalist design philosophy described below. The quantitative details of the analysis of alternatives and trade-off study are presented in Chapter 3 of this report.

2.5 -- DESIGN PHILOSOPHY

The design philosophy of this conversion study is to add the Advanced Gun System to the ship while minimizing the impact to the ship and its remaining systems. Minimizing significant changes to the ship system as a whole minimizes both crew impact and construction costs. Maintaining most of the ship's

original capabilities while adding extended range NSFS allows for lower conversion costs, shorter conversion timeline, and lower risks during the conversion project.

3.0 -- CONCEPT EXPLORATION

A feasibility-level study was completed comparing the three major alternatives presented in the previous chapter. Each alternative was analyzed by calculating the anticipated Ships Operational Readiness and Training System (SORTS) Material Readiness Rating (M-rating) and by calculating the naval architectural features of the modified ship. By calculating the individual weights as well as the vertical and horizontal centers of gravity of each element added or removed from the ship, the modified ship's stability, trim, and survivability features were identified and compared. Once a "best" alternative among these three concepts was chosen, an analysis of the ideal detailed arrangements for that installation was conducted.

Each of the options examined had unique advantages and disadvantages. Based on the design philosophy adopted for this study, the first priority was to retain the highest level of war-fighting capabilities. Once the overall ship capabilities were determined, the options were analyzed for feasibility based on naval architectural and cost concerns. The quantitative determination of the feasibility of each option was made using the naval architectural assessments conducted. Factors of cost, relative among the options, although secondary in priority in the overall decision making process, provided a great deal of further guidance in choosing the "best" option overall. The three options are presented in the sections below, including their major features and comparative analyses.

3.1 – OPTION 1: FORWARD MOUNT AT FRAME 70

The first option explored involves removing the forward 5in/54cal gun mount, including its associated equipment and magazines, and removing the forward Vertical Launch System (VLS). Removing these two major systems provides the necessary space and weight allowance for a magazine of 320 rounds.

This magazine is divided into four compartments to maintain transverse watertight bulkheads for survivability considerations. The resulting magazine arrangement fills the main deck and first platform between frame 58 and frame 127 with a watertight bulkhead retained at frame 94. A two-level primary magazine exists under the AGS mount between frame 58 and frame 94. A secondary magazine occupies the space between frame 94 and frame 127, also on the main deck and first platform. The deck layouts for the main deck and first platform between frame 58 and frame 127 are shown in [Appendix B](#).

3.1.1 – WAR-FIGHTING CAPABILITIES ASSESSMENT









The war-fighting capabilities of USS THORN, modified as described above, are analyzed via a SORTS-based M-rating. Table 3 shows the ratings of each of the major warfare areas for USS THORN. The effect of adding the Advanced Gun System is not factored into this rating, since each of the alternatives involves installing the AGS and hence would alter each variant's M-rating equally. Each system removed to facilitate the AGS installation is modeled as "not operational," affecting the overall capabilities retained for that warfare area. The standard Navy reporting procedures are used. In this system, a rating of M-1 is represented as green. A rating of M-2 or M-3 is represented as yellow, or degraded. A rating of M-4 is represented as red, indicating that no significant capabilities are retained in that area. The overall rating of the ship is based on the lowest rating of any single warfare area.

The loss of the Tomahawk weapon system by removing the VLS automatically degrades the strike warfare readiness to a minimum. In addition, the loss of the VLS eliminates the Vertical Launch ASROC (VLA) from the ship's arsenal. Removing VLA capabilities degrades the anti-submarine warfare (ASW)

readiness significantly, leaving only over-the-side Surface Vessel Torpedo Tubes (SVTTs) and the embarked LAMPS III helicopter for anti-submarine weapons. Further, this arrangement eliminates the forward retractable kingpost near frame 94, degrading the ship's mobility (MOB) rating. Since ASW is a major warfare focus of the Spruance-class destroyers, the degradation in this area is significant. By eliminating an entire warfare area and degrading a major focus of the platform's capabilities, this conversion option significantly degrades the versatility of the ship system as a whole.

Table 3 -- Option 1 - Mount 61 forward, replacing MT51 and VLS

This readiness comparison is prepared using Ships Operational Readiness and Training System (SORTS) guidelines establishing material readiness levels WRT warfare area. The warfare areas included are: SUW - Surface Warfare, ASW - Anti-Submarine Warfare, AAW - Anti-Air Warfare, MIW - Mine Warfare, AMW - Amphibious Warfare, MOB - Mobility, STR - Strike Warfare, NAV - Navigation and Safety. The overall M-Rating is color coded with the accepted USN method for brief reporting of readiness: RED -- M-4,

| Warfare Area | Current | W/Conversion | Comments | Overall |
|-----------------------|---------|--------------|--|---|
| SUW | M1 | M1 | Although experiencing some degradation due to the loss of Mount 51, majority of SUW readiness is retained with Harpoon ASCM launchers. |  |
| ASW | M1 | M3 | Severely degraded with loss of VLA capability, limiting ASW to SVTTs and embarked Helo. |  |
| AAW | M1 | M1 | |  |
| MIW | M1 | M1 | |  |
| AMW | M1 | M1 | 320 rounds of AGS LRLAP. |  |
| MOB | M1 | M2 | Slightly degraded by loss of forward kingpost at Frame 94. |  |
| STR | M1 | M4 | Mission eliminated with loss of TLAM launch capability associated with VLS. |  |
| NAV | M1 | M1 | |  |
| Overall Rating | | | |  |

3.1.2 – WEIGHT AND STABILITY ANALYSIS

The displacement of USS THORN as a result of this conversion is reduced by approximately 156LT. Table 4 shows a summary of the weight additions and losses used to balance the new ship arrangement. The weight added includes the total gun system weight, the weight of the structural components necessary to rebuild the decks in the area of the removed VLS space, and 40 pallets (8 binary rounds per pallet) of ammunition in the magazine spaces. The details of the individual component weights and centers used to develop this balance are presented in [Appendix B](#) in the form of an accounting spreadsheet tracking each component of the overall AGS system. The weight removed includes all components and the magazine contents of the forward 5in/54 caliber gun mount (Mount 51). In addition, the components and missiles of the VLS and Tomahawk systems are subtracted from the ship's displacement.

As a result of the above-mentioned weight accounting, the total displacement of USS THORN is reduced by 156LT, to approximately 8585LT total. The ship's mean draft is therefore reduced by approximately 3 inches, as determined from the ship's curves of form. The resulting change in trim will be approximately 1.32 feet by the stern. Therefore, if the ship normally trims on an even keel, the converted ship will trim by the stern. This change in trim can be reduced by removing a portion of the 153.6LT of ballast added to the aft portion of the ship as part of the VLS installation modifications. Therefore, no major weight or stability issues are introduced as a result of this conversion installation option.

| Table 4 -- Option 1 - Mount 61 forward, replacing MT51 and VLS | | | | |
|---|-------------------------|----------------|--------------|---------------|
| ADDED WEIGHTS | | | | |
| Component | | Weight (LT) | VCG | LCG |
| | AGS Gun Assembly | 78.64 | 49.5 | 187.2 |
| | Ammo Handling System | 128.34 | 25 | 170.5 |
| | Cooling Skid | 1.29 | 18 | 170.5 |
| Core Gun System | | 208.27 | 34.21 | 176.81 |
| Deck-over VLS | | 30 | 33.21 | 159.78 |
| Ammo | | 100.00 | 33.6 | 171.3 |
| TOTAL ADDED | | 338.27 | 33.94 | 173.67 |
| REMOVED WEIGHTS | | | | |
| 5in/54cal Gun System | MT 51 Drum & Foundation | 2.24 | 42.37 | 195.08 |
| | MT 51 Gun Assembly | 22.35 | 50.16 | 194.92 |
| | 5in Ammo | 28.08 | 22.22 | 187.91 |
| | | 52.67 | 34.93 | 191.19 |
| VLS Missile Assy. | VLS & TWCS Systems | 275.56 | 29.92 | 150.77 |
| | Missiles | 165.9 | 32.96 | 152.74 |
| | | 441.46 | 31.06 | 151.51 |
| TOTAL REMOVED | | 494.13 | 31.47 | 155.74 |
| TOTAL CHANGE IN WEIGHTS | | -155.86 | 26.13 | 116.83 |
| CHANGE IN TRIM | | | | |
| Baseline Displacement | 8741 LTON | | | |
| Altered Disp. | 8585.14 LTON | | | |
| Baseline Draft | 20.5 ft | | | |
| TPI | 51.55 LTON/in | | | |
| Altered Draft | 20.25 ft | | | |
| LCG | -42.5 ft | | | |
| MT1" | 1565 ft-LTON | | | |
| Change in Draft | -0.25 ft | | | |
| Change in Trim | 15.87 in | | | By the Stern |
| | 1.32 ft | | | |

3.2 – OPTION 2: AFT MOUNT AT FRAME 440 WITH STANDARD MAGAZINE

The second option explored involves removing the aft 5in/54 caliber gun mount, its associated equipment and magazines, as well as removing the NATO Sea Sparrow Missile System (NSSMS). The AGS mount is placed on the O-1 level at frame 440, where the NSSM launcher is removed. The aft 5in/54 caliber gun mount is removed and decked over, and the spaces immediately below the mount are used as magazines. The fantail can be used as a vertical replenishment location for reload of the AGS magazines. Removing these two major systems provides the necessary space and weight allowance for a magazine of 304 rounds.

Again, this magazine is divided into four compartments to maintain transverse watertight bulkheads for floodable length considerations. The resulting magazine arrangement occupies the main deck between frame 426 and frame 464, the first platform between frame 426 and frame 506, and the second platform between frame 464 and frame 506, with a watertight bulkhead retained at frame 464. A two-level primary magazine exists under the AGS mount between frame 426 and frame 464. This primary magazine resides on the main deck and the first platform; the load drum assemblies (port and starboard) extend down into the second platform space directly below the gun at frame 440. A secondary magazine occupies the space between frame 464 and frame 506 on the first and second platforms. To move ammunition between the two magazines, the existing ammunition elevator is retained just aft of frame 464 to transport ammunition from the aft magazine to the main deck level, where the ammunition can be loaded into the AGS mount. The deck layouts for the main deck, first platform, and second platform between frame 426 and frame 506 are shown in [Appendix C](#).











3.2.1 – WAR-FIGHTING CAPABILITIES ASSESSMENT

The war-fighting capabilities of USS THORN, modified as described above, are analyzed via a SORTS-based M-rating in Table 5. Again, the effect of adding the Advanced Gun System itself is not factored into this rating, since each of the alternatives involves installing the AGS. Each system removed to facilitate the AGS installation is modeled as “not operational,” affecting the overall capabilities retained for that warfare area.

The removal of the NSSM system degrades the anti-air unit self defense area by eliminating one of the mid-range self-defense weapons. USS THORN still retains the Rolling Airframe Missile (RAM) system, but does experience a degradation of the total air-warfare self-defense system. This degradation can be eliminated with the integration of the Enhanced NATO Sea Sparrow Missile System (ENSSMS), which utilizes the existing NSSMS RADAR and fire control equipment, and launches Sea Sparrow missiles from the VLS. All other warfare areas are retained and fully capable with this arrangement, including all elements of the ASW suite. Therefore, there is only a minor degradation of the overall war-fighting capabilities of the ship as a result of this conversion option. There is, however, slight degradation to the area of mobility (MOB). This configuration necessitates removal of the aft kingpost, near frame 434, reducing the connected replenishment capabilities of the ship.

Table 5 -- Option 2 - Mount 62 replacing MT52 and NSSM

This readiness comparison is prepared using Ships Operational Readiness and Training System (SORTS) guidelines establishing material readiness levels WRT warfare area. The warfare areas included are: SUW - Surface Warfare, ASW - Anti-Submarine Warfare, AAW - Anti-Air Warfare, MIW - Mine Warfare, AMW - Amphibious Warfare, MOB - Mobility, STR - Strike Warfare, NAV - Navigation and Safety. The overall M-Rating is color coded with the accepted USN method for brief reporting of readiness: RED -- M-4, YELLOW -- M-2 or 3, GREEN -- M-1.

| Warfare Area | Current | W/Conversion | Comments | Overall |
|-----------------------|---------|--------------|--|---|
| SUW | M1 | M1 | Although experiencing some degradation due to the loss of Mount 52, majority of SUW readiness is retained with Harpoon ASCM launchers. |  |
| ASW | M1 | M1 | |  |
| AAW | M1 | M3/M1 | Potential degradation of unit self defense with elimination of NSSMS can be corrected with ESSMS in VLS. |   |
| MIW | M1 | M1 | |  |
| AMW | M1 | M1 | 304 rounds of AGS LRLAP. |  |
| MOB | M1 | M2 | Slightly degraded by loss of aft kingpost at Frame 434. |  |
| STR | M1 | M1 | |  |
| NAV | M1 | M1 | |  |
| Overall Rating | | | |  |

3.2.2 – WEIGHT AND STABILITY ANALYSIS

The displacement of USS THORN as a result of this conversion is increased by approximately 237LT. Table 6 shows a summary of the weight additions and subtractions used to balance the new ship arrangement. The weight added is composed of the total gun system weight and the weight of the 38 pallets (8 binary rounds per pallet) of ammunition in the magazine spaces. The details of the individual component weights and centers used to develop this balance are presented in [Appendix C](#) in the form of an accounting spreadsheet tracking each component of the overall AGS system. The weight removed

includes all components and the magazine contents of the aft 5in/54 caliber gun mount (Mount 52). In addition, the launcher components and missiles for the NSSM system are subtracted from the ship's displacement. The NSSMS RADAR illuminators and fire control equipment are retained to facilitate the possible future integration of ENSSMS.

As a result of the above-mentioned weight accounting, the total displacement of USS THORN is increased by 237LT to approximately 8978LT total. The ship's mean draft is therefore increased by approximately 4.6 inches. The resulting change in trim will be 1.93 feet by the stern. Therefore, if the ship normally trims on an even keel, the converted ship will trim by the stern. Again, this change in trim can be reduced by removing a portion of the 153.6LT of ballast added to the aft portion of the ship as part of the VLS installation modifications. Therefore, no major weight or stability issues are introduced as a result of this conversion installation.

| Table 6 -- Option 2 - Mount 61 aft, replacing MT52 and NSSM | | | | |
|--|----------------------------|---------------|--------------|----------------|
| ADDED WEIGHTS | | | | |
| Component | | Weight (LT) | VCG | LCG |
| | AGS Gun Assembly | 78.64 | 46 | -185.5 |
| | Ammo Handling System | 129.54 | 24.75 | -198.5 |
| | Cooling Skid | 1.29 | 18 | -211.5 |
| Core Gun System | | 209.47 | 32.69 | -193.70 |
| Ammo | | 95.00 | 24.75 | -209.6 |
| TOTAL ADDED | | 304.47 | 30.21 | -198.66 |
| REMOVED WEIGHTS | | | | |
| 5in/54cal Gun System | MT 52 Drum & Foundation | 2.24 | 30.4 | -223.92 |
| | MT 52 Gun Assembly | 22.35 | 37.27 | -223.92 |
| | 5in Ammo | 27.47 | 20.43 | -226.89 |
| | | 52.06 | 28.09 | -225.49 |
| | Launcher Assy. | 4.45 | 46 | -185.5 |
| NSSMS Assy. | Missiles in Launcher Assy. | 1.61 | 48 | -185.5 |
| | Missiles in Mag. | 9.09 | 44.93 | -143.8 |
| | | 15.15 | 45.57 | -160.48 |
| TOTAL REMOVED | | 67.21 | 32.03 | -210.83 |
| TOTAL CHANGE IN WEIGHTS | | 237.26 | 29.69 | -195.21 |
| CHANGE IN TRIM | | | | |
| Baseline Displacement | 8741 LTON | | | |
| Altered Disp. | 8978.26 LTON | | | |
| Baseline Draft | 20.5 ft | | | |
| TPI | 51.55 LTON/in | | | |
| Altered Draft | 20.88 ft | | | |
| LCG | -42.5 ft | | | |
| MT1" | 1565 ft-LTON | | | |
| Change in Draft | 0.38 ft | | | |
| Change in Trim | 23.15 in | | By the Stern | |
| | 1.93 ft | | | |











3.3 – OPTION 3: AFT MOUNT AT FRAME 440 WITH EXTENDED MAGAZINE

The third option explored is an extension of the second option described above in section 3.2. The AGS mount and magazine installations are identical, but an additional magazine space is included on the main deck in a new “shed” structure covering the original Mount 52 area. The AGS mount is still placed on the O-1 level at frame 440, where the NSSM launcher is removed. The aft 5in/54 caliber gun mount is removed, decked over, and a 22ft wide housing is built extending the O-1 level weather deck to frame 506. The spaces immediately below the mount are also used as magazines. The extension of the main deck allows an additional 12 pallets of binary rounds, increasing the total magazine capacity to 50 pallets

or 400 rounds. The deck layout for the main deck between frame 426 and frame 506 is shown in [Appendix D](#). The first and second platform arrangements are identical to those shown in [Appendix C](#) for the second conversion option.

3.3.1 – WAR-FIGHTING CAPABILITIES ASSESSMENT

The warfare capabilities of USS THORN in this arrangement are identical to those of the arrangement presented in section 3.2 except that the AGS has enhanced capabilities due to the extended magazine capacity. Since the war fighting enhancements due to the AGS are not considered for this report, the resulting M-rating for this arrangement is identical to that for the second configuration described. This rating analysis is shown in Table 7. There is only a minor degradation of the overall war-fighting capabilities of the ship as a result of this conversion option

| Table 7 -- Option 3 - Mount 62 aft with extended magazine | | | | |
|--|---------|--------------|--|---|
| This readiness comparison is prepared using Ships Operational Readiness and Training System (SORTS) guidelines establishing materiel readiness levels WRT warfare area. The warfare areas included are: SUW - Surface Warfare, ASW - Anti-Submarine Warfare, AAW - Anti-Air Warfare, MIW - Mine Warfare, AMW - Amphibious Warfare, MOB - Mobility, STR - Strike Warfare, NAV - Navigation and Safety. The overall M-Rating is color coded with the accepted USN method for brief reporting of readiness: RED -- M-4, YELLOW -- M-2 or 3, GREEN -- M-1. | | | | |
| Warfare Area | Current | W/Conversion | Comments | Overall |
| SUW | M1 | M1 | Although experiencing some degradation due to the loss of Mount 52, majority of SUW readiness is retained with Harpoon ASCM launchers. |  |
| ASW | M1 | M1 | |  |
| AAW | M1 | M3/M1 | Potential degradation of unit self defense with elimination of NSSMS can be corrected with ESSMS in VLS. |   |
| MIW | M1 | M1 | |  |
| AMW | M1 | M1 | 400 rounds of AGS LRLAP. |  |
| MOB | M1 | M2 | Slightly degraded by loss of aft kingpost at Frame 434. |  |
| STR | M1 | M1 | |  |
| NAV | M1 | M1 | |  |
| Overall Rating | | | |  |

3.3.2 – WEIGHT AND STABILITY ANALYSIS

The displacement of USS THORN as a result of this conversion is increased by approximately 303LT. Table 8 shows a summary of the weight additions and subtractions used to balance the new ship arrangement. The weight added is similar to that shown in section 3.2, but also includes the structural components of the main deck extension constructed for the expanded magazine. The details of the individual component weights and centers used to develop this balance are presented in [Appendix D](#) in the form of an accounting spreadsheet tracking each component of the overall AGS system. The removed weight is identical to the weight accounting for option two.

As a result of the above-mentioned weight accounting, the total displacement of USS THORN is increased by 303LT to approximately 9044LT total. The ship’s mean draft is therefore increased by approximately 6 inches. The resulting change in trim will be 2.58 feet by the stern. This trim is slightly more than can be corrected by removing the 153.6LT of ballast added to the aft portion of the ship as part of the VLS installation modifications. The significant weight increase, due to the 12 additional

pallets of ammunition and the added “shed” structure, and the trim issues introduced limit the feasibility of this option.

| Table 8 -- Option 3 - Mount 61 aft with expanded magazine | | | | |
|--|----------------------------|---------------|--------------|----------------|
| ADDED WEIGHTS | | | | |
| Component | | Weight (LT) | VCG | LCG |
| Core Gun System | AGS Gun Assembly | 78.64 | 46 | -185.5 |
| | Ammo Handling System | 133.27 | 24.75 | -198.5 |
| | Coolin Skid | 1.29 | 18 | -211.5 |
| | | 213.20 | 32.55 | -193.78 |
| | Side Shell Plate | 11.12 | 36.80 | -223.50 |
| | Aft Bulkhead | 3.40 | 36.80 | -241.50 |
| Aft Structural Addition | Deck Plate | 12.04 | 42.00 | -223.50 |
| | Stiffener Allowance | 6.64 | - | - |
| | | 33.19 | 39.16 | -225.80 |
| Ammo | | 125.00 | 28 | -213.26 |
| TOTAL ADDED | | 371.39 | 31.61 | -203.20 |
| REMOVED WEIGHTS | | | | |
| 5in/54cal Gun System | MT 52 Drum & Foundation | 2.24 | 30.4 | -223.92 |
| | MT 52 Gun Assembly | 22.35 | 37.27 | -223.92 |
| | 5in Ammo | 27.47 | 20.43 | -226.89 |
| | | 52.06 | 28.09 | -225.49 |
| | Launcher Assy. | 4.45 | 46 | -185.5 |
| | Missiles in Launcher Assy. | 1.61 | 48 | -185.5 |
| NSSMS Assy. | Missiles in Mag. | 9.09 | 44.93 | -143.8 |
| | | 15.15 | 45.57 | -160.48 |
| TOTAL REMOVED | | 67.21 | 32.03 | -210.83 |
| TOTAL CHANGE IN WEIGHTS | | 304.18 | 31.51 | -201.51 |
| CHANGE IN TRIM | | | | |
| Baseline Displacement | 8741 LTON | | | |
| Altered Disp. | 9045.18 LTON | | | |
| Baseline Draft | 20.5 ft | | | |
| TPI | 51.55 LTON/in | | | |
| Altered Draft | 20.99 ft | | | |
| LCG | -42.5 ft | | | |
| MT1" | 1565 ft-LTON | | | |
| Change in Draft | 0.49 ft | | | |
| Change in Trim | 30.91 in | | By the Stern | |
| | 2.58 ft | | | |

3.4 – FINAL BASELINE CONCEPT DESIGN

From the results of the trade-off studies conducted, option two, the aft AGS mount alternative with the 304 round magazine was chosen as the “best” alternative for this application due to the retention of more major war-fighting capabilities while minimizing cost and impact on the ship and its crew. The forward mount alternative (option 1) was eliminated due to the loss of the Vertical Launch System. Retaining the VLS is a very attractive proposition to maintain a well-rounded war-fighting platform. The aft mount with the extended magazine (option 3) is shown to lead to both weight and trim concerns.

In addition, the relative costs of the three options must be considered. All three options involve the installation of the gun, the rails and automated magazine systems, and at least one ammunition strike-down elevator. The first option would include the construction costs for re-building the decks in the former VLS space. It also requires the installation of two strike-down elevators, one on either side of the transverse watertight bulkhead separating the magazine spaces.

Both of the aft options only require one additional strike-down elevator to be built since the existing elevator just aft of frame 464 can be re-used for moving ammunition between the secondary magazine and the gun mount. The third option involves the additional construction costs of building the main

deck extension for the expanded magazine. Therefore, from a qualitative perspective, the second option is also the lowest cost option, in alignment with the stated design philosophy.

For warfare capability, feasibility, and cost considerations, the second option is identified as the “best” option of those analyzed. Further details of the arrangements, system interfaces, and behaviors of the converted ship for this option are presented in Chapter 4 of this report.

4.0 – FEASIBILITY STUDY AND ASSESSMENT

4.1 – DESIGN DEFINITION

The chosen design alternative from Chapter 3 was used to complete a more detailed, feasibility-level study of the installation of the AGS on USS THORN. Assessment of the structural integrity, stability characteristics, electrical and auxiliary system impacts, and overall arrangement modifications of the converted ship were completed and are described below.

4.1.1 – PRINCIPAL SHIP CHARACTERISTICS SUMMARY

Although the modified USS THORN remains essentially similar in principal characteristics to a baseline Spruance-class destroyer, the major differences are listed in Table 9. There is a slight increase in both displacement and draft as a result of the conversion. In addition, a small trim by the stern is introduced, that can be corrected with the removal of lead ballast in the aft portion of the ship. The most obvious modification to the platform is the addition of the AGS mount and its ammunition.

| <u>Table 9 - Principal Ship Characteristics of modified USS THORN</u> | |
|--|------------|
| Displacement | 8978LT |
| Average Draft | 21ft 4.2in |
| Trim | 1.39ft Aft |
| AGS Location | Frame 440 |
| Rounds of Ammunition | 304 |

4.1.2 – ARRANGEMENT

The placement of the AGS on USS THORN was accomplished with a conscious effort to minimize the impact on the existing ship's arrangement. In this manner, transverse watertight bulkheads are unaltered, and existing deck layouts are used (with slight modifications) to the greatest extent possible. Additionally, the existing aft 5-inch ammunition-handling elevator is retained for use in the automated ammunition handling system of the AGS.

4.1.2.1 – Mission Payload/Layout

The AGS trunion ring and mount are installed in the modified USS THORN at frame 440. In this location, the AGS mount replaces the existing NATO Sea Sparrow Missile (NSSM) launcher. The associated ammunition magazine and automated ammunition handling system extend below decks into five watertight compartments:

1. 1-426-0 - displacing the Deck Gear Storeroom #3 (1-434-0), the NSSMS Equipment Room (1-448-0), and the aft connected replenishment (CONREP) kingpost.

2. 2-426-0 - displacing the Flammable Liquids Storeroom (2-426-0), and the Physical Fitness Room (2-436-0).
3. 2-464-0 - displacing the Ship's Stores Room (2-464-01), the Mount 52 Loader Drum (2-482-0), the Crew Baggage Storeroom (2-494-1), and the Hobby Shop (2-494-0).
4. 3-426-0 - displacing the Ship's Clothing Storeroom and Issue (3-426-0) and the Chemical Warfare Storeroom (3-446-0).
5. 3-464-0 - displacing the Mount 52 Ammunition Pallet Staging Room (3-464-01), the Mount 52 5in. Projectile Magazine (3-482-0), and the Mount 52 Powder Magazine (3-494-0).

Many of the spaces displaced by the installation of the AGS ammunition handling system and magazine are no longer necessary as a result of the conversion and have no impact on the overall arrangement of the modified USS THORN. These include the spaces associated with the NSSMS and Mount 52. Other spaces can be absorbed into other existing spaces elsewhere in the ship. For example, the Flammable Liquids Storeroom can be combined with the Paint Mixing and Issue room to consolidate the two functions in the modified ship.

4.1.2.2 – Inboard Profile

The placement of the AGS on USS THORN is illustrated in Figure 1. The location of the AGS and its associated magazine and ammunition handling spaces are highlighted in the top portion of the figure. A detailed diagram of the ammunition magazine, automated ammunition handling system and ammunition pallet transfer path between the two magazine sections is provided in the lower portion of Figure 1.

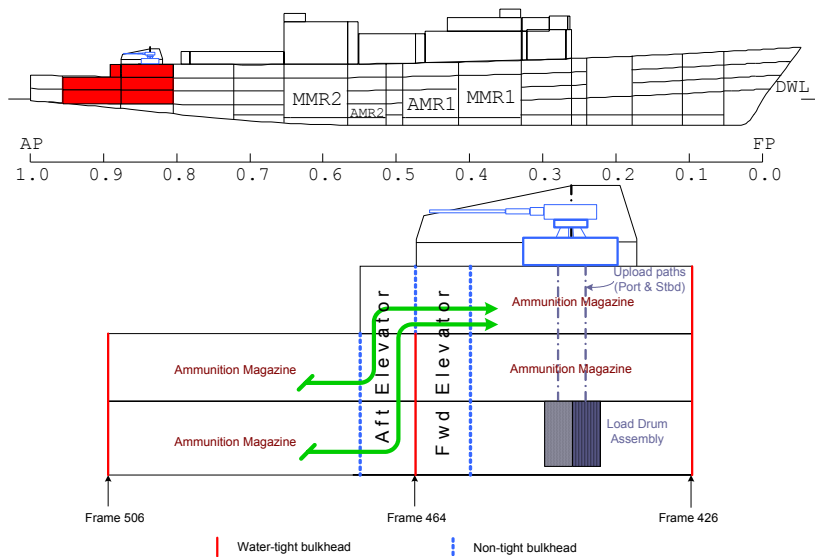

Figure 1 -- Inboard Profile and Ammunition Flow Path

4.1.2.3 – Deck Plans

The detailed arrangements of the five below-decks AGS spaces, including the ammunition handling track and the ammunition pallet layouts, are included in Figures 2, 3, and 4. Figure 2 shows the

arrangement of the main deck, including the locations of both ammunition strike-down elevators. The download and upload hoists of the AGS mount are delineated by the rectangular-shaped area at frame 440. The bulkhead at frame 464 (represented by the dashed line) is non-tight, containing the pass-through doors between the two ammunition strike-down elevators. With this pass-through design, both the primary and the secondary ammunition magazines may be re-loaded from the vertical replenishment area on the main deck where Mount 52 was removed. The elevator aft of frame 464 is also used to hoist ammunition from the aft magazines on the first and second platforms (shown in Figures 3 and 4) to the main deck for use in the AGS.

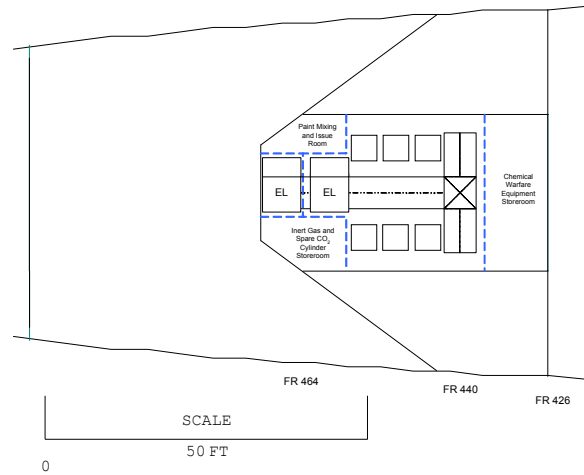

Figure 2 -- Main Deck Magazine Layout

Figure 3 shows the magazine arrangements on the first platform. The magazine space forward of the transverse watertight bulkhead at frame 464 is automated to allow direct ammunition loading into the AGS upload paths. Ammunition pallets from the aft magazines are loaded into the aft elevator, hoisted to the main deck, and enter the upload path from the pass-through at frame 464.

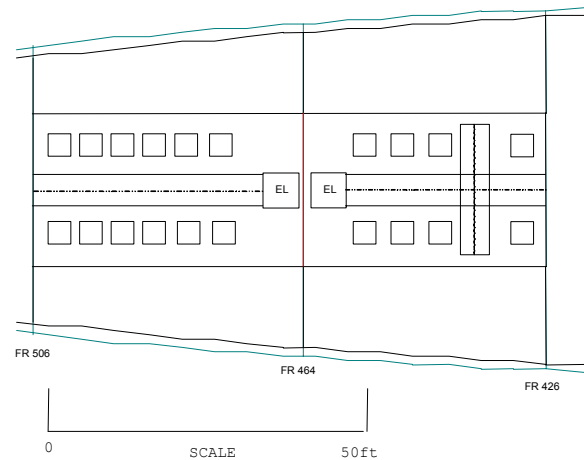

Figure 3 -- First Platform Magazine Layout

Figure 4 shows the magazine arrangements on the second platform. The aft magazine continues onto this level aft of frame 464. Again, ammunition pallets from this magazine are hoisted to the main

deck for entry into the AGS upload path. The two load drum assemblies reside on the second platform forward of frame 464. These ram assemblies receive the ammunition from the magazines and upload the rounds to the gun mount. Two assemblies exist, one port and one starboard, to facilitate clear passage down the centerline of each magazine level for the automated ammunition handling carts.

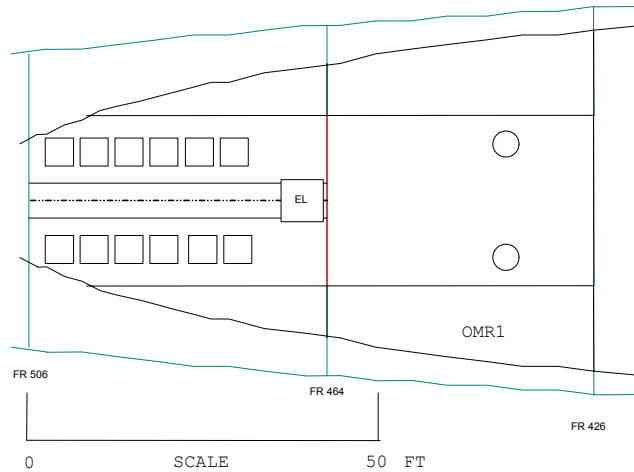

Figure 4 -- Second Platform Magazine Layout

4.1.3 –ELECTRICAL AND AUXILIARIES

4.1.3.1 – Electrical Power and Distribution

Since much of the AGS system is still in the development stages, the electrical powering requirements of the system can only be approximately estimated. The manufacturers of the gun system estimate that the peak load of the system in operation will be approximately 800kW. Hence, the electrical load analysis of installing the AGS on USS THORN is based on this estimate.

Further, there are many possible power distribution configurations with respect to the AGS that will require further development by the gun system manufacturer. For purposes of this feasibility study, the AGS was analyzed with a direct feed of shipboard 450V(AC), 60Hz, 3-phase power. To determine the existing electrical load of USS THORN, two sources were consulted: the Joint NGSS/UDLP feasibility study and the Chief Engineer of USS THORN. In light of the uncertainty regarding the AGS required loads, the more conservative of the two electrical loads was used for the purposes of this analysis.

The maximum generation capacity of USS THORN is 3600kW, 90% of two paralleled 2000kW generators with a third 2000kW generator as a backup. All loads, either added or removed, including the AGS system, were calculated for battle conditions on a 10°-Celsius day using a battle demand factor. A 10°-Celsius day represents the worst case loading for the generation system.

Table 10 represents the electrical load analysis of the modified USS THORN. The most conservative baseline battle condition load was taken to be 2743kW, and the final electrical load of the modified USS THORN was estimated to be 3462kW. This altered load can be accommodated by the current electrical generation system, but at a drastic reduction in the electrical load margin.

| Table 10 -- Electrical Load Breakdown | | |
|--|------------------|------------------|
| ADDED ELECTRICAL LOADS | | |
| Component | Cruise Load (kW) | Battle Load (kW) |
| Core Gun System | 800 | 800 |
| TOTAL ADDED | 800 | 800 |
| REMOVED ELECTRICAL LOADS | | |
| 5in/54cal Gun System | 36.6 | 50.2 |
| NSSMS Missile Assy. | 31.1 | 31.1 |
| TOTAL REMOVED | 67.7 | 81.3 |
| TOTAL CHANGE IN ELECTRICAL LOAD | 732 | 719 |
| ELECTRICAL LOAD DETAILS | | |
| Generation Capacity | | 3600 |
| Baseline Load | | 2743 |
| Altered Load | | 3462 |
| Baseline Electrical Load Margin | | 857 |
| Altered Electrical Load Margin | | 138 |

With this reduced electrical load margin in mind, the recommended power distribution configuration of the AGS is illustrated in Figure 5. This configuration requires the installation of one 400A breaker on L/C 31 and one 800A breaker on 2SB for primary power and one 400A and 800A breaker on L/C 42 for back-up power. Such a configuration makes it possible to split the ship's electrical plant. A majority of ship's systems can then be powered from generators one and three on the forward bus, and the AGS can be isolated on the aft bus, powered by number two generator. Such a configuration may provide the most stable power conditions.

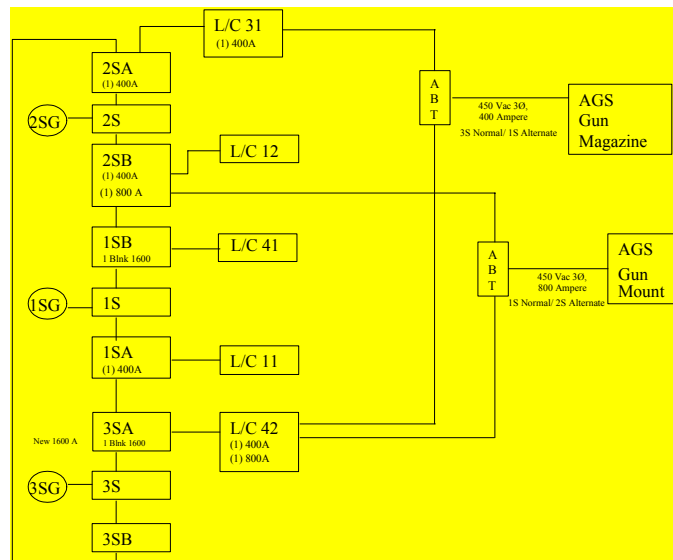

Figure 5 -- Electrical Distribution Connections

4.1.3.2 – Fire Main

USS THORN fire main system consists of six electrically driven fire pumps, supplying seawater through risers to a primary main located on the damage control deck. Each pump is capable of supplying 1100gpm of seawater to the fire main at 150psi. The main distribution loop is capable of being segregated

into three independent sections, each serviced by two pumps. Under normal operations, the segregation points are opened to form a single main loop. Seawater is supplied to damage control equipment and other systems from this primary loop.

| Table 11 -- Fire Main System Requirements | |
|--|-------------|
| ADDED FIRE MAIN REQUIREMENTS | |
| Component | Flow (gpm) |
| AGS Mag. Sprinkling | 3947 |
| AGS Secondary Cooling | 285 |
| TOTAL ADDED | 4232 |
| REMOVED FIRE MAIN REQUIREMENTS | |
| 5in/54cal Projectile Mag | 280 |
| 5in/54cal Powder Mag | 150 |
| 5in/54cal Loader Drum Room | 561 |
| 5in/54cal Pallet Staging Room | 353 |
| NSSMS Missile Mag. | 450 |
| TOTAL REMOVED | 1794 |
| TOTAL CHANGE IN FIRE MAIN REQUIREMENTS | 2438 |

The AGS requires magazine sprinkling for fire suppression. Table 11 illustrates the impact of the AGS installation on the fire main system of the modified USS THORN. Although the existing equipment can accommodate this large net increase in demand on the fire main system in a single loop configuration, it represents a large increase in demand on the two fire pumps associated with the aft fire main section in the segregated loop configuration. Therefore, in the event of a magazine sprinkler light-off, the main fire main loop must be opened to provide adequate flow and pressure throughout the system. This doctrine change should be incorporated into the ship's damage control procedures to prevent system failure.

4.1.3.3 – Chilled Water

USS THORN's chilled water system consists of three 150-ton air conditioning plants, three expansion tanks, three 540gpm chilled water pumps, and the associated supply and return piping to vital and non-vital users. Air conditioning plants numbers 1 and 2, along with their associated pumps and expansion tanks, are located in Auxiliary Machinery Room No. 1 (5-220-0-E). Air conditioning plant number 3 is located in Pump Room No. 2 and Air Conditioning and Chilled Water Machinery Room (3-398-0-Q). Each air conditioning plant is operated as an independent plant with a cross-connect capability. The air conditioning plants make use of a centrifugal-type compressor to supply chilled water at approximately 44 degrees F to fan coils, cooling coils, gravity coils, electronic cooling water heat exchangers, hydraulic oil coolers, and condenser filters.

| Table 12 -- Chilled Water System Requirements | |
|--|-------------|
| ADDED CHILLED WATER REQUIREMENTS | |
| Component | Flow (gpm) |
| AGS Assy. | 88 |
| TOTAL ADDED | 88 |
| REMOVED CHILLED WATER REQUIREMENTS | |
| 5in/54cal Projectile Mag | 2 |
| 5in/54cal Powder Mag | 1.5 |
| 5in/54cal Loader Drum Room | 45 |
| NSSMS Missile Mag. | 3 |
| TOTAL REMOVED | 51.5 |
| TOTAL CHANGE IN CHILLED WATER REQUIREMENTS | 37 |

Installation of the AGS on the modified USS THORN would have a large impact on the chilled water system. Table 12 shows the overall impact of AGS on the chilled water system. The additional draw on the chilled water system is within the capacity of the installed system. Strenuous conditions such as extreme warm weather operations will require close monitoring of the chilled water system to ensure proper operations.

4.1.4 – STRUCTURAL DESIGN

The structural arrangement of the modified USS THORN remains identical to the baseline configuration. Since the details of the ship's scantlings are classified, a representative amidships section was used to model USS THORN using the POSSE program for structural analysis. Through a detailed analysis of the bending moments produced at the amidships section, the existing design is seen to be sufficient to accommodate the inclusion of the AGS on USS THORN. While it is believed that the model constructed in POSSE is close to the actual ship conditions, there is some amount of uncertainty with this analysis. Since the model in POSSE was believed to be approximately correct, all analysis performed in POSSE was completed using the original, unmodified model before the AGS installation. The analysis was then repeated for the modified models for all cases studied so that relative changes could be determined.

4.1.4.1 – Strength Curves

Through a comparison of the structural characteristics of the modified USS THORN with the baseline configuration, the bending moments are seen to change insignificantly, well within the structural limits of the ship. Detailed computations can be seen in [Appendix E](#).

4.1.5 – WEIGHTS, STABILITY AND MARGINS

Since the exact weights and weight distribution of the Navy's POSSE files for USS THORN are classified, a representative POSSE model of the ship's weight and distribution was determined from unclassified sources. These sources include ASSET program "match runs" from the original Spruance-class baseline ship and the CG-52 Ticonderoga class cruiser, and, most influentially, the actual draft of USS THORN. The combination of this information yielded a POSSE modeled full load displacement of USS THORN at approximately 8741LT. From this model, POSSE was used to add point loads for the AGS modification. Minimum operating conditions were also modeled per the specifications of DDS 079-1. In POSSE the seawater-compensated fuel tanks at the minimum operating condition were modeled as full with a liquid having a specific gravity weighted for 1/3 fuel and 2/3 seawater. While it is believed that the model constructed in POSSE is close to the actual ship conditions, there is some amount of uncertainty with this analysis. Since the model in POSSE was believed to be approximately correct, all analysis performed in POSSE was completed using the original, unmodified model before the AGS installation. The analysis was then repeated for the modified models for all cases studied so that relative changes could be determined.

4.1.5.1 – Full Load

As detailed in [Appendix E](#), the full load displacement of the modified USS THORN is approximately 8977LT, a net change of 236LT.

4.1.5.1.1 – Weight Summary

[Appendix C](#) summarizes the added weights associated with the AGS as well as the removed weights of the corresponding displaced systems. This change in displacement and weight distribution results in a change in draft of approximately 2.8in and a change in trim of 1.93ft. The resulting trim is approximately 1.93ft by the stern.

4.1.5.1.2 – Intact and Damaged Stability

As shown in [Appendix E](#), the intact and damaged stability of the modified USS THORN is essentially unchanged from the baseline configuration. All requirements delineated in DDS 079-1 are met.

4.1.7.2 – Minimum Operating

As detailed in [Appendix F](#), the minimum operating displacement of the modified USS THORN is 8916LT, a net change of -61LT from the full load case, and 175LT greater than the baseline displacement.

4.1.5.2.1 – Weight Summary

[Appendix F](#) summarizes the change in weights associated with the minimum operating condition. This change in displacement and weight distribution results in a change in draft of approximately -2in from the full load condition, a change of less than 1in from the baseline condition, and a change in trim of .72ft by the stern from the full load condition, to become 2.11ft by the stern.

4.1.5.2.2 – Intact and Damaged Stability

As shown in [Appendix E](#), the intact and damaged stability of the modified USS THORN is essentially unchanged from the baseline configuration. All requirements delineated in DDS 079-1 are met.

4.1.6 – SURVIVABILITY

By retaining the configuration of watertight transverse bulkheads in the region of the AGS and magazine it can be seen that the modified USS THORN meets damage and flooding requirements in accordance with DDS 079-1. Figure 6 displays the floodable length curve of the modified USS THORN. As the figure shows, 15% of the length of the ship may be damaged without crossing the 75% permeability curve.

The calculation of these curves reflects the permeability of the AGS magazine spaces calculated in [Appendix G](#). The removal of the bulkhead at frame 464 was considered and was found to be unfeasible based on floodable length considerations.

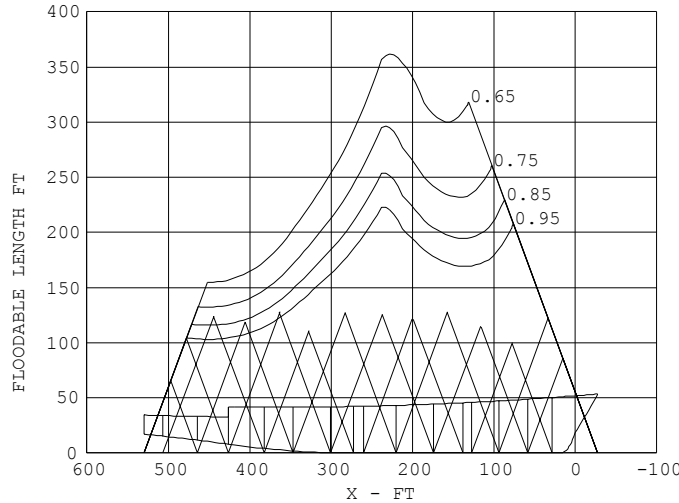

Figure 6 -- Floodable Length Curves

4.2 – PERFORMANCE ANALYSIS (MISSION/OPERATION SCENARIOS)

Analysis of the design of the modified USS THORN shows that the overall mission readiness of the platform is largely unaffected by the installation of the AGS.

4.2.1 – MISSION

As seen in [Appendix C](#), and referenced in Chapter 2, only the AAW self-defense capability of the baseline USS THORN is impacted by the installation of the AGS. It is possible to retain the AAW capabilities of USS THORN if the NSSMS is modified to fire from the VLS system. Although the NSSM was removed in this study, the associated fire control systems were retained to utilize the VLS launch option. The readiness of all other mission areas is retained.

4.2.2 – SEAKEEPING

As seen in [Appendix H](#), the modified USS THORN retains very similar seakeeping characteristics to the unmodified arrangement. The motions experienced at the AGS mount on the modified USS THORN are essentially the same as those experienced at the NSSM launcher in the baseline configuration.

4.2.3 – UNDERWAY REPLENISHMENT

With the removal of the aft retractable kingpost all connected replenishment (CONREP) must be conducted from the amidships stations or the forward kingpost. For purposes of reloading the AGS

magazines with ammunition pallets, vertical replenishment would be the preferred method of UNREP. Owing to the large size and weight of AGS ammunition pallets, and the immediate proximity of the aft VERTREP platform to the AGS magazine this method should be the primary method of reloading at sea.

4.3 – COST

The rough order of magnitude (ROM) cost estimated for the modification of USS THORN to include AGS was completed using a parametric, weight-based cost estimator (included in [Appendix I](#)). This cost estimate does not include the cost associated with the purchase of the AGS-related equipment, but only the installation of that equipment, and the removal of existing equipment onboard USS THORN.

The cost-estimating tool used weight data, broken up by Ship's Weight Breakdown System (SWBS) groups, and parametrically derived per-weight costs associated with each SWBS group to determine the overall cost of this conversion. Weights of removed and added systems were classified into the appropriate SWBS group and entered into the cost model. All physical equipment associated with the AGS (mount, ammo handling system, etc.), as well as the physical equipment associated with mount 52 and the NSSM launcher, were considered structural weight (SWBS group 1) for purposes of this estimation. All electronic and fire control system weight was categorized as SWBS group 4, command and surveillance. The separate cooling skid associated with the AGS was considered SWBS group 5, auxiliary systems. The LRLAP ammo rounds, 5in/54 ammo rounds, and NSSM rounds were categorized as SWBS group 7, armament.

4.3.1 – TOTAL ESTIMATED COST

This weight based ROM cost estimate indicates that the conversion of USS THORN to include the AGS will cost approximately \$83.8 million. This estimated cost, however, does not include acquisition and development of the AGS, only its installation.

5.0 -- DESIGN CONCLUSIONS

5.1 – SUMMARY OF FINAL CONCEPT DESIGN

Installation of the AGS in USS THORN can be accomplished while retaining most of the baseline capabilities of the platform. The outcome of the analysis of alternatives indicated that option two, aft placement of AGS mount at frame 440, as the preferred alternative. Among the reasons for its selection were the 304 round capacity of its magazine, similar to that proposed on the DD(X), the retention of more major war-fighting capabilities, and the minimization of cost and baseline ship impact.

5.2 – FINAL CONCEPT DESIGN ASSESSMENT AND CONCLUSIONS

This configuration results in degradation of the AAW self-defense capability of the modified USS THORN, with the loss of the NSSMS, but with the full preservation of the baseline strike and anti-submarine capabilities. Further development could possibly preserve even the AAW capability with the integration of the Enhanced Sea Sparrow Missile System (ESSMS), inserting the NSSM into the VLS.

The modified USS THORN exhibits structural characteristics largely unaffected by the installation of AGS. Electrical and auxiliary systems are seen to be capable of accommodating the gun system, although doctrine and arrangements modifications may be necessary for smooth operation of the AGS. The electrical system experiences an increase of 719kW under battle conditions. The fire main system exhibits an increased demand of 2438gpm with the installation of the AGS. The chilled water system experiences an increase in demand of 37gpm.

Stability and seakeeping characteristics of the modified USS THORN are seen to differ only slightly from the baseline configuration. Further, all requirements of AAO-AA-SPN-010/Gen-Spec, DDS 100-1, 2, 4, 5, 6, 7, DDS 079-1 and DDS 079-2 are met by the modified USS THORN.

5.3 – AREAS OF FURTHER INVESTIGATION

Although this study indicates that installation of the AGS on USS THORN is feasible, there remain issues of technical and design development that require further attention. Among these is the development of the vertical launched Sea Sparrow, proposed for the LPD-17 project, to retain the full capability of the NSSMS on a modified USS THORN. Further, a more in-depth investigation of electrical and auxiliaries arrangements would be necessary to work out issues of AGS system requirements and system interface needs. This would also include a more rigorous arrangements study, including a ship-check visit to the installation platform to develop details of AGS space arrangement. Such a visit would also serve to solidify a few estimated ship characteristics, including the full load displacement used in this and other AGS conversion studies.

LIST OF REFERENCES

1. www.globaldefense.com, 21 JAN 03.
2. SORTS Manual, NWP 3-1-1.
3. DD(X) Program: Advanced Gun System (AGS) Backfit Technical Report. 15 NOV 02.
4. LT Daniel Arthur, Chief Engineer, USS THORN (DD-988).

UNCLASSIFIED

MISSION NEED STATEMENT
FOR
INSTALLATION OF THE ADVANCED GUN SYSTEM ON SPRUANCE CLASS
DESTROYERS

1. DEFENSE PLANNING GUIDANCE ELEMENT

a. This Mission Need Statement (MNS) provides requirements for conversion of a DD-963 class destroyer to include the Advanced Gun System. The multi-mission capabilities of the Spruance class Destroyer will be maintained to the greatest extent possible while maintaining a balanced warship. Although many war-fighting areas may be degraded as a result of the installation, the overall ship system will be enhanced to include advanced gunfire support and gun weapon capabilities. The mission capabilities must be fully interoperable with other naval, interagency, joint and allied forces.

b. This MNS should guide Spruance Advanced Gun System (AGS) conversion design, research, development and installation program decisions, service and joint doctrine, and cooperative efforts with U.S. allies.

2. MISSION AND THREAT ANALYSIS

a. Mission. The general mission of this converted ship is to conduct gunfire support missions including long-range gunfire missions in addition to many of the missions of an unmodified Spruance class destroyer. More specifically, the mission is to carry the war to the enemy through offensive operations by being able to launch and support precision guided self-propelled projectiles and to provide firepower support for amphibious and other ground forces while maintaining battlespace awareness and defense against theater missile, air, surface, and sub-surface threats.

b. Objectives. The Spruance Conversion including AGS must be a low-cost conversion alternative to add the full capabilities of the AGS to the central capabilities of the Spruance Destroyer. Minimizing hull and bulkhead modification and redesign are central to achieving a low cost conversion.

c. Capabilities. Since the converted Destroyer will remain a viable ship of the line, as many of the central capabilities of the Spruance Destroyer as possible will be preserved while providing full space, electrical load, and weight considerations for the AGS.

3. POTENTIAL MATERIEL ALTERNATIVES

- (1) Replacement of the aft 5"/54 caliber gun and NATO Sea Sparrow Missile system with the AGS system
- (2) Removal of the forward VLS bank and replacement with AGS. This would involve removal of the 5"/54 caliber mount to allow additional space for the AGS support systems and swing circle.

5. CONSTRAINTS

a. Key Boundary Conditions.

(1) Architecture – Locations and arrangements for the AGS fire control system and related communications infrastructure must be developed, in addition to the locations, structural support, and ship services support for the mount itself and its associated magazines.

(2) Design – Consideration should be given for modular insertion of the gun and magazine systems to the greatest extent possible. Minimal rework of the AGS structure itself will allow optimal test conditions for the AGS in the arrangement that it will be used on DD(X).

b. Operational Constraints.

(1) The Spruance AGS Conversion must remain fully functional and operational in all environments. The converted platform will remain a viable, deployable ship of the line and therefore needs to present good seakeeping, performance, and self-defense characteristics and capabilities. If possible, helicopter landing and operational capabilities, in addition to as many other warfare capabilities as possible will be retained.

(3) All ship and combat system elements must make use of standard subsystems and meet required development practices. The Spruance AGS Conversion must be fully integrated with other U.S. Navy, Marine Corps, joint and allied forces, and other agencies in combined, coordinated operations.

APPENDIX B – OPTION 1 DETAILS

| Option 1 - Mount 61 forward, replacing MT51 and VLS | | | | |
|--|-------------------------|----------------|--------------|---------------|
| ADDED WEIGHTS | | | | |
| Component | | Weight (LT) | VCG | LCG |
| Core Gun System Deck-over VLS Ammo | AGS Gun Assembly | 78.64 | 49.5 | 187.2 |
| | Ammo Handling System | 128.34 | 25 | 170.5 |
| | Cooling Skid | 1.29 | 18 | 170.5 |
| | | 208.27 | 34.21 | 176.81 |
| | | 30 | 33.21 | 159.78 |
| | | 100.00 | 33.6 | 171.3 |
| TOTAL ADDED | | 338.27 | 33.94 | 173.67 |
| REMOVED WEIGHTS | | | | |
| 5in/54cal Gun System | MT 51 Drum & Foundation | 2.24 | 42.37 | 195.08 |
| | MT 51 Gun Assembly | 22.35 | 50.16 | 194.92 |
| | 5in. Ammo | 28.08 | 22.22 | 187.91 |
| | | 52.67 | 34.93 | 191.19 |
| VLS Missile Assy. | VLS & TWCS Systems | 275.56 | 29.92 | 150.77 |
| | Missiles | 165.9 | 32.96 | 152.74 |
| | | 441.46 | 31.06 | 151.51 |
| TOTAL REMOVED | | 494.13 | 31.47 | 155.74 |
| TOTAL CHANGE IN WEIGHTS | | -155.86 | 26.13 | 116.83 |
| CHANGE IN TRIM | | | | |
| Baseline Displacement | 8741 LTON | | | |
| Altered Disp. | 8585.14 LTON | | | |
| Baseline Draft | 20.5 ft | | | |
| TPI | 51.55 LTON/in | | | |
| Altered Draft | 20.25 ft | | | |
| b | -42.5 ft | | | |
| MT1" | 1565 ft-LTON | | | |
| Change in Draft | -0.25 ft | | | |
| Change in Trim | 15.87 in | | By the Stern | |
| | 1.32 ft | | | |

Ammunition Pallet LCG Computation for Option 1

| Number of Pallets | Weight (LTON) | Location (frame number) | Moment (ft-LTON) | | | | |
|-------------------|---------------|-------------------------|------------------|--------------|--|----------|--|
| 2 | 5 | 63 | 315 | 1-58-0 | | | |
| 2 | 5 | 68 | 340 | | | | |
| 2 | 5 | 73 | 365 | | | | |
| 2 | 5 | 84 | 420 | | | | |
| 2 | 5 | 89 | 445 | | | | |
| 2 | 5 | 101 | 505 | | | | |
| 2 | 5 | 106 | 530 | | | | |
| 2 | 5 | 111 | 555 | | | | |
| 2 | 5 | 116 | 580 | | | | |
| 2 | 5 | 121 | 605 | | | | |
| 2 | 5 | 63 | 315 | 1-94-0 | | | |
| 2 | 5 | 68 | 340 | | | | |
| 2 | 5 | 73 | 365 | | | | |
| 2 | 5 | 84 | 420 | | | | |
| 2 | 5 | 89 | 445 | | | | |
| 2 | 5 | 101 | 505 | | | | |
| 2 | 5 | 106 | 530 | | | | |
| 2 | 5 | 111 | 555 | | | | |
| 2 | 5 | 116 | 580 | | | | |
| 2 | 5 | 121 | 605 | | | | |
| Total Pallets | | Total Weight | | Total Moment | | LCG (ft) | |
| 40 | | 100 | | 9320 | | 93.2 | |

OPTION 1 - MAGAZINE WEIGHT DATA

| Magazine, AGS | Element or Assembly Name | Weight | Quantity | Total Weight | Quantity | Contribution to System Weight |
|---|---|--------|----------|----------------|----------|-------------------------------|
| Kit, Storage Location Hardware | | | | 126,492 | 1 | 126,492 |
| | Bracket Assembly, High Track, Duel Pallet Supporting | 1,212 | 28 | 33,936 | | |
| | Structure, Dual Supporting | 1,012 | 1 | 1,012 | | |
| | Attaching Hardware | 200 | 1 | 200 | | |
| | Bracket Assembly, High Track Right Pallet Supporting | 1,167 | 10 | 11,670 | | |
| | Structure, High Track, Right Supporting | 1,012 | 1 | 1,012 | | |
| | Attaching Hardware | 155 | 1 | 155 | | |
| | Bracket Assembly, High Track, Left Pallet Supporting | 1,167 | 10 | 11,670 | | |
| | Bracket Assembly, Low Track, Duel Pallet Supporting | 1,285 | 28 | 35,980 | | |
| | Structure, Dual Supporting | 1,012 | 1 | 1,012 | | |
| | Attaching Hardware | 273 | 1 | 273 | | |
| | Bracket Assembly, Low Track, Right Pallet Supporting | 1,240 | 10 | 12,400 | | |
| | Bracket Assembly, Low Track, Left Pallet Supporting | 1,240 | 10 | 12,400 | | |
| | Structure, Low Track Left Supporting | 1,012 | 1 | 1,012 | | |
| | Attaching Hardware | 228 | 1 | 228 | | |
| | Pallet Retention Hardware, High Track | 106 | 38 | 4,028 | | |
| | Pallet Retention Hardware, Low Track | 116 | 38 | 4,408 | | |
| Electrical Enclosures | | | | 9,658 | 1 | 9,658 |
| | 1st Platform Port Equipment Enclosure | 1,074 | 1 | 1,074 | | |
| | 1st Platform Starboard Equipment Enclosure | 1,074 | 1 | 1,074 | | |
| | Centerline Equipment Enclosure | 765 | 1 | 765 | | |
| | 2nd Platform Port Equipment Enclosure | 1,526 | 1 | 1,526 | | |
| | 2nd Platform Starboard Equipment Enclosure | 1,526 | 1 | 1,526 | | |
| | 3rd Deck Equipment Enclosure | 1,973 | 1 | 1,973 | | |
| | Hold Port Equipment Enclosure | | | | | |
| | Hold Starboard Equipment Enclosure | | | | | |
| | DAP Enclosures | 220 | 1 | 220 | | |
| | Magazine PDP | 1,500 | 1 | 1,500 | | |
| Cabling and Clamping | | | | 11,317 | 1 | 11,317 |
| | Cables | 10,703 | 1 | 10,703 | | |
| | Cable Clamps | 214 | 1 | 214 | | |
| | Junction boxes | 400 | 1 | 400 | | |
| Pallet Transfer Mechanism (FR 58 to 94) | | | | 7,991 | 2 | 15,982 |
| | Roller-Screw Drive System (432 inch) At 5.23 lbs/in. | 2,258 | 1 | 2,258 | | |
| | Cart, Pallet Transfer | 5,733 | 1 | 5,733 | | |
| | Cart Structure | 3,665 | 1 | 3,665 | | |
| | Pallet Retention Activation Hdw | 95 | 1 | 95 | | |
| | Cart Latching Hdw | 92 | 1 | 92 | | |
| | Pallet Stowage Location Engagement Mechanism | 100 | 1 | 100 | | |
| | Motor Controller | 441 | 1 | 441 | | |
| | Pallet Transfer Chain Drive System | 335 | 4 | 1,340 | | |
| | Motor | 51 | 1 | 51 | | |
| | Gearbox | 134 | 1 | 134 | | |
| | Chain Drive Assy | 150 | 1 | 150 | | |
| Pallet Transfer Mechanism (FR 94 to 127) | | | | 7,804 | 2 | 15,608 |
| | Roller-Screw Drive System (396 inch) At 5.23 lbs/in. | 2,071 | 1 | 2,071 | | |
| | Cart, Pallet Transfer | 5,733 | 1 | 5,733 | | |
| | Cart Structure | 3,665 | 1 | 3,665 | | |
| | Pallet Retention Activation Hdw | 95 | 1 | 95 | | |
| | Cart Latching Hdw | 92 | 1 | 92 | | |
| | Pallet Stowage Location Engagement Mechanism | 100 | 1 | 100 | | |
| | Motor Controller | 441 | 1 | 441 | | |
| | Pallet Transfer Chain Drive System | 335 | 4 | 1,340 | | |
| | Motor | 51 | 1 | 51 | | |
| | Gearbox | 134 | 1 | 134 | | |
| | Chain Drive Assy | 150 | 1 | 150 | | |
| Pallet Unloading Table | | | | 6,012 | 2 | 12,024 |
| | Fore/ Aft Drive Assy | 333 | 1 | 333 | | |
| | Motor & Bracket | 178 | 1 | 178 | | |
| | Gearbox | 64 | 1 | 64 | | |
| | Roller-Screw & Hardware | 91 | 1 | 91 | | |
| | Latch Mechanism | 109 | 1 | 109 | | |
| | Fore/ Aft Rails | 434 | 1 | 434 | | |
| | Table Structure | 3,000 | 1 | 3,000 | | |
| | Tracks & Hardware | 1,234 | 1 | 1,234 | | |
| | Pallet Athwartship Drive Assy | 298 | 2 | 596 | | |
| | Motor | 107 | 1 | 107 | | |
| | Gearbox | 97 | 1 | 97 | | |
| | Roller-Screw & Hardware | 94 | 1 | 94 | | |
| | Pallet Transfer Pin Hardware | 215 | 1 | 215 | | |
| | Pallet Lock Hardware | 91 | 1 | 91 | | |
| Down Load Hoist | | | | 1,560 | 2 | 3,120 |
| | Tube & Chain Guide | 839 | 1 | 839 | | |
| | Chain & Pawl Assy | 147 | 1 | 147 | | |
| | Ammunition Release Mechanism | 38 | 1 | 38 | | |
| | Drive Assy | 536 | 1 | 536 | | |
| | Motor & Gearbox | 480 | 1 | 480 | | |
| | Sprocket & Housing Assy | 56 | 1 | 56 | | |
| Load Drum | | | | 3,444 | 2 | 6,888 |
| | Rotating Structure | | | 2,404 | | |
| | Clip | 824 | 2 | 1,648 | | |
| | Support Structure & Bearing | 756 | 1 | 756 | | |
| | Stationary Structure | 1,002 | 1 | 1,040 | | |
| | Upper Structure | 193 | 1 | 193 | | |
| | Lower Structure | 708 | 1 | 708 | | |
| | Latch Assy | 63 | 1 | 63 | | |
| | Snubber Actuating Assy | 38 | 2 | 76 | | |
| | Drive Assy | | | | | |
| | Motor & Coupling | 26 | 1 | 26 | | |
| | Gearbox | 169 | 1 | 169 | | |
| Lower Hoist, Port | | | | 3,491 | 1 | 3,491 |
| | Tube & Chain Guide Assy | 1,788 | 1 | 1,788 | | |
| | Chain & Pawl Assy | 581 | 1 | 581 | | |
| | Drive Assy | 561 | 2 | 1,122 | | |
| | Motor & Gearbox | 264 | 1 | 264 | | |
| | Sprocket & Housing Assy | 297 | 1 | 297 | | |
| Lower Hoist, Starboard | | | | 3,491 | 1 | 3,491 |
| | Tube & Chain Guide Assy | 1,788 | 1 | 1,788 | | |
| | Chain & Pawl Assy | 581 | 1 | 581 | | |
| | Drive Assy | 561 | 2 | 1,122 | | |
| | Motor & Gearbox | 264 | 1 | 264 | | |
| | Sprocket & Housing Assy | 297 | 1 | 297 | | |
| Upper Shuttle | | | | 10,308 | 1 | 10,308 |
| | Clip Transfer Mechanism | 1,760 | 1 | 1,760 | | |
| | Tracks | 683 | 1 | 683 | | |
| | Transfer Drive Components | 1,077 | 1 | 1,077 | | |
| | Clip Transfer Mechanism | 551 | 1 | 551 | | |
| | Motor and Gearbox | 526 | 1 | 526 | | |
| | Turntable Assy, Starboard | 4,274 | 1 | 4,274 | | |

Option 1 - Main Deck Arrangement

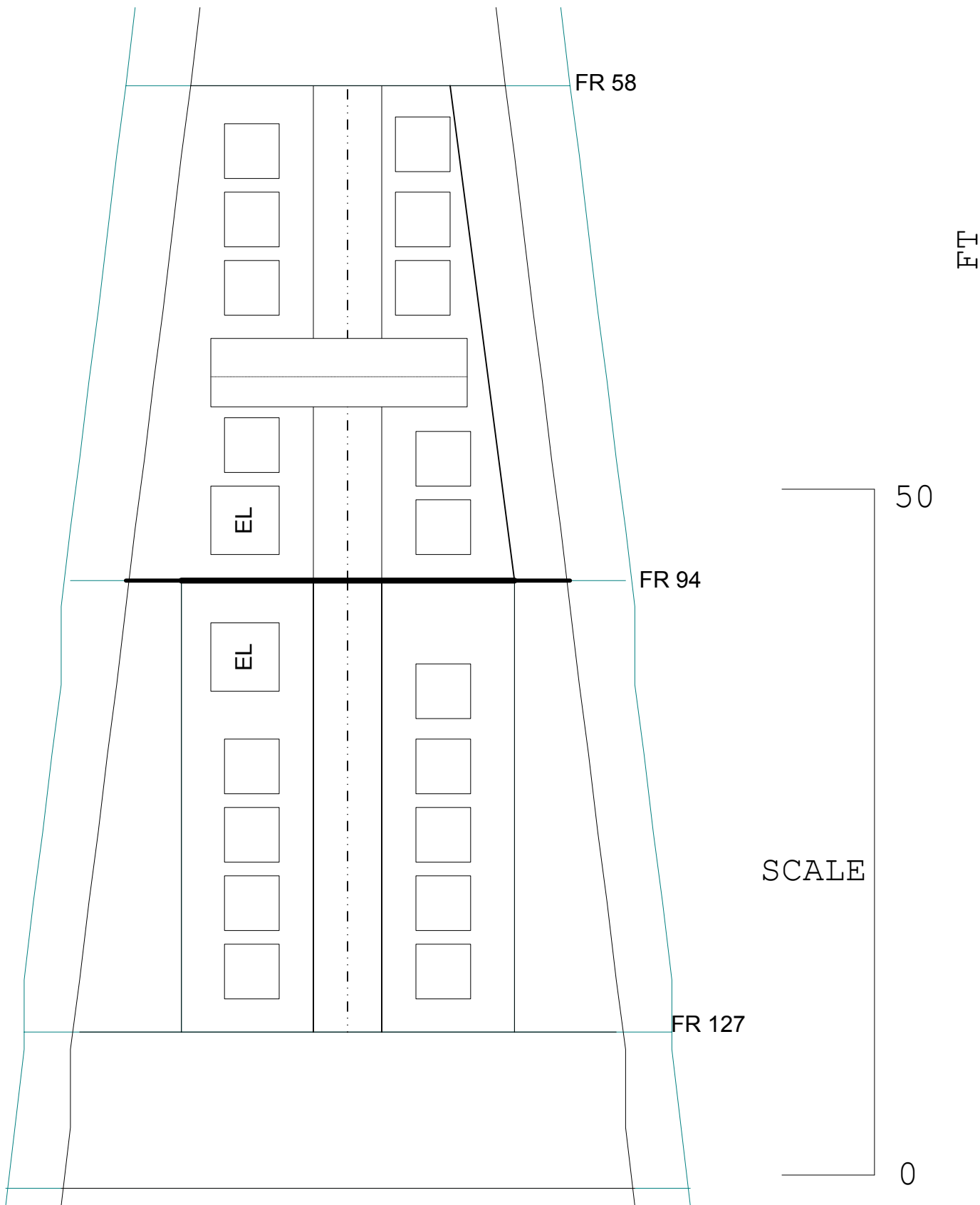

Option 2 - First Platform
Arrangement

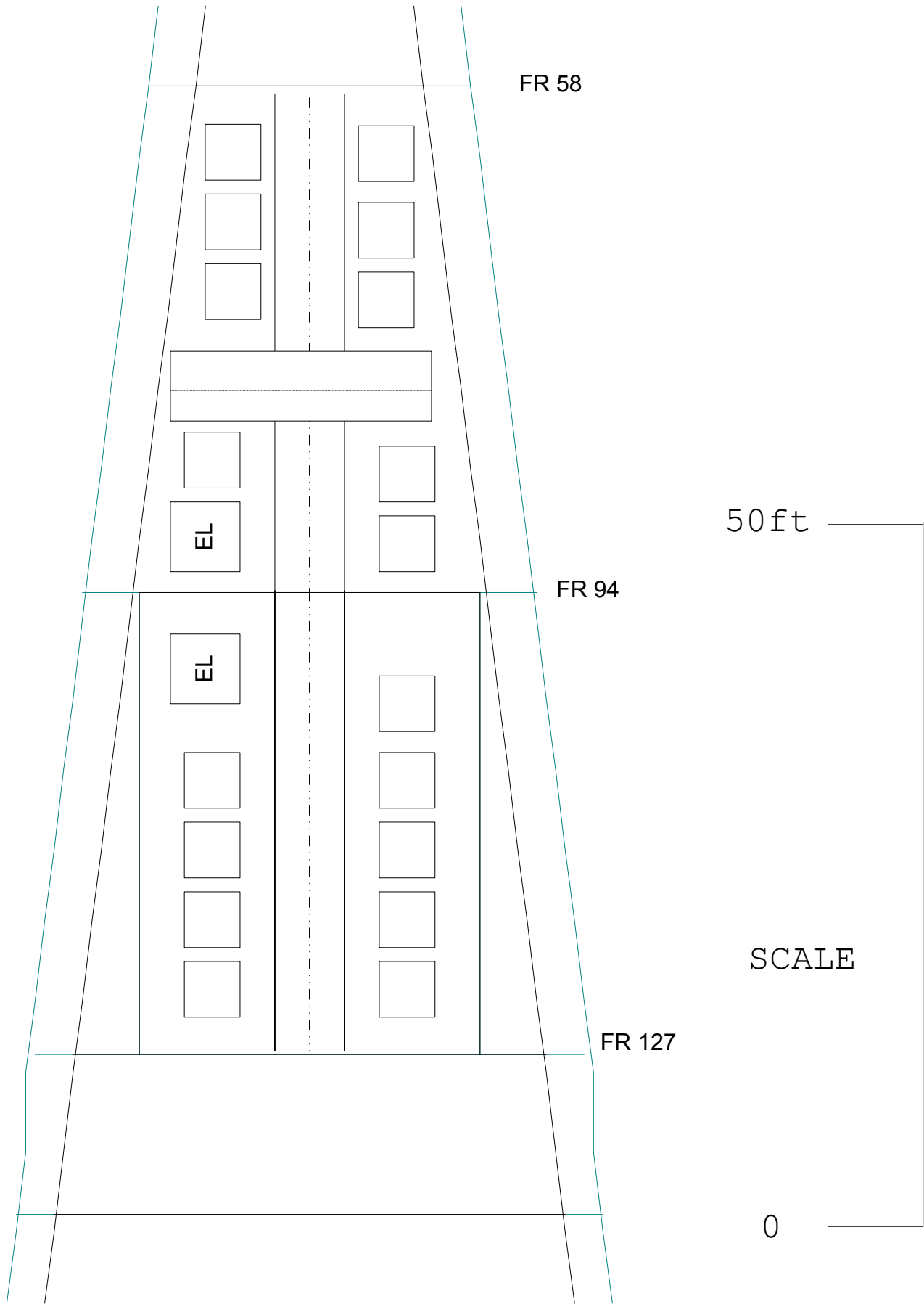

APPENDIX C – OPTION 2 DETAILS

Option 2 - Mount 61 aft, replacing MT52 and NSSM

| ADDED WEIGHTS | | | | |
|--------------------------------|----------------------------|---------------|--------------|----------------|
| Component | | Weight (LT) | VCG | LCG |
| Core Gun System Ammo | AGS Gun Assembly | 78.64 | 46 | -175.5 |
| | Ammo Handling System | 129.15 | 24.75 | -198.5 |
| | Cooling Skid | 1.29 | 18 | -211.5 |
| | | 209.08 | 32.70 | -189.93 |
| | | 95.00 | 24.75 | -209.55263 |
| TOTAL ADDED | | 304.08 | 30.22 | -196.06 |
| REMOVED WEIGHTS | | | | |
| 5in/54cal Gun System | MT 52 Drum & Foundation | 2.24 | 30.4 | -223.92 |
| | MT 52 Gun Assembly | 22.35 | 37.27 | -223.92 |
| | 5in. Ammo | 27.47 | 20.43 | -226.89 |
| | | 52.06 | 28.09 | -225.49 |
| | Launcher Assy. | 4.45 | 46 | -185.5 |
| | Missiles in Launcher Assy. | 1.61 | 48 | -185.5 |
| NSSMS Assy. | Missiles in Mag. | 9.09 | 44.93 | -143.8 |
| | | 15.15 | 45.57 | -160.48 |
| TOTAL REMOVED | | 67.21 | 32.03 | -210.83 |
| TOTAL CHANGE IN WEIGHTS | | 236.87 | 29.70 | -191.87 |
| CHANGE IN TRIM | | | | |
| Baseline Displacement | 8741 LTON | | | |
| Altered Disp. | 8977.87 LTON | | | |
| Baseline Draft | 20.5 ft | | | |
| TPI | 51.55 LTON/in | | | |
| Altered Draft | 20.88 ft | | | |
| b | -42.5 ft | | | |
| MT1" | 1565 ft-LTON | | | |
| Change in Draft | 0.38 ft | | | |
| Change in Trim | 22.61 in | By the Stern | | |
| | 1.88 ft | | | |

Ammunition Pallet LCG Computation for Option 2

| Number of Pallets | Weight (LTON) | Location (frame number) | Moment (ft-LTON) | |
|----------------------|---------------------|-------------------------|------------------|---------|
| 2 | 5 | 445 | 2225 | 1-426 |
| 2 | 5 | 451 | 2255 | |
| 2 | 5 | 455 | 2275 | |
| 2 | 5 | 431 | 2155 | 2-426-0 |
| 2 | 5 | 445 | 2225 | |
| 2 | 5 | 451 | 2255 | |
| 2 | 5 | 455 | 2275 | |
| 2 | 5 | 477 | 2385 | 2-464-0 |
| 2 | 5 | 482 | 2410 | |
| 2 | 5 | 487 | 2435 | |
| 2 | 5 | 492 | 2460 | |
| 2 | 5 | 497 | 2485 | |
| 2 | 5 | 502 | 2510 | |
| 2 | 5 | 477 | 2385 | 3-464-0 |
| 2 | 5 | 482 | 2410 | |
| 2 | 5 | 487 | 2435 | |
| 2 | 5 | 492 | 2460 | |
| 2 | 5 | 497 | 2485 | |
| 2 | 5 | 502 | 2510 | |
| Total Pallets | Total Weight | Total Moment | LCG (ft) | |
| 38 | 95 | 45035 | 474.0526316 | |

OPTION 2 - MAGAZINE WEIGHT DATA

| Lvl | Lvl | Lvl | Lvl | Lvl | Element or Assembly Name | Weight | Quantity | Total Weight | Quantity | Contribution to System Weight |
|-----|-----|-----|-----|-----|--|--------|----------|----------------|----------|-------------------------------|
| | | | | | Magazine, AGS | | | | | |
| | | | | | Kit, Storage Location Hardware | | | 126,492 | 1 | 126,492 |
| | | | | | Bracket Assembly, High Track, Dual Pallet Supporting | 1,212 | 28 | 33,936 | | |
| | | | | | Structure, Dual Supporting | 1,012 | 1 | 1,012 | | |
| | | | | | Attaching Hardware | 200 | 1 | 200 | | |
| | | | | | Bracket Assembly, High Track Right Pallet Supporting | 1,167 | 10 | 11,670 | | |
| | | | | | Structure, High Track, Right Supporting | 1,012 | 1 | 1,012 | | |
| | | | | | Attaching Hardware | 155 | 1 | 155 | | |
| | | | | | Bracket Assembly, High Track, Left Pallet Supporting | 1,167 | 10 | 11,670 | | |
| | | | | | Bracket Assembly, Low Track, Dual Pallet Supporting | 1,285 | 28 | 35,980 | | |
| | | | | | Structure, Dual Supporting | 1,012 | 1 | 1,012 | | |
| | | | | | Attaching Hardware | 273 | 1 | 273 | | |
| | | | | | Bracket Assembly, Low Track, Right Pallet Supporting | 1,240 | 10 | 12,400 | | |
| | | | | | Bracket Assembly, Low Track, Left Pallet Supporting | 1,240 | 10 | 12,400 | | |
| | | | | | Structure, Low Track Left Supporting | 1,012 | 1 | 1,012 | | |
| | | | | | Attaching Hardware | 228 | 1 | 228 | | |
| | | | | | Pallet Retention Hardware, High Track | 106 | 38 | 4,028 | | |
| | | | | | Pallet Retention Hardware, Low Track | 116 | 38 | 4,408 | | |
| | | | | | Electrical Enclosures | | | 9,658 | 1 | 9,658 |
| | | | | | 1st Platform Port Equipment Enclosure | 1,074 | 1 | 1,074 | | |
| | | | | | 1st Platform Starboard Equipment Enclosure | 1,074 | 1 | 1,074 | | |
| | | | | | Centerline Equipment Enclosure | 765 | 1 | 765 | | |
| | | | | | 2nd Platform Port Equipment Enclosure | 1,526 | 1 | 1,526 | | |
| | | | | | 2nd Platform Starboard Equipment Enclosure | 1,526 | 1 | 1,526 | | |
| | | | | | 3rd Deck Equipment Enclosure | 1,973 | 1 | 1,973 | | |
| | | | | | Hold Port Equipment Enclosure | | | | | |
| | | | | | Hold Starboard Equipment Enclosure | | | | | |
| | | | | | DAP Enclosures | 220 | 1 | 220 | | |
| | | | | | Magazine PDP | 1,500 | 1 | 1,500 | | |
| | | | | | Cabling and Clamping | | | 11,317 | 1 | 11,317 |
| | | | | | Cables | 10,703 | 1 | 10,703 | | |
| | | | | | Cable Clamps | 214 | 1 | 214 | | |
| | | | | | Junction boxes | 400 | 1 | 400 | | |
| | | | | | Pallet Transfer Mechanism (FR 440 to 464) | | | 7,239 | 1 | 7,239 |
| | | | | | Roller-Screw Drive System (288 inch) | 1,506 | 1 | 1,506 | | |
| | | | | | At 5.23 lbs/in. | | | | | |
| | | | | | Cart, Pallet Transfer | 5,733 | 1 | 5,733 | | |
| | | | | | Cart Structure | 3,665 | 1 | 3,665 | | |
| | | | | | Pallet Retention Activation Hdw | 95 | 1 | 95 | | |
| | | | | | Cart Latching Hdw | 92 | 1 | 92 | | |
| | | | | | Pallet Stowage Location Engagement Mechanism | 100 | 1 | 100 | | |
| | | | | | Motor Controller | 441 | 1 | 441 | | |
| | | | | | Pallet Transfer Chain Drive System | 335 | 4 | 1,340 | | |
| | | | | | Motor | 51 | 1 | 51 | | |
| | | | | | Gearbox | 134 | 1 | 134 | | |
| | | | | | Chain Drive Assy | 150 | 1 | 150 | | |
| | | | | | Pallet Transfer Mechanism (FR 426 to 464) | | | 8,118 | 1 | 8,118 |
| | | | | | Roller-Screw Drive System (456 inch) | 2,385 | 1 | 2,385 | | |
| | | | | | At 5.23 lbs/in. | | | | | |
| | | | | | Cart, Pallet Transfer | 5,733 | 1 | 5,733 | | |
| | | | | | Cart Structure | 3,665 | 1 | 3,665 | | |
| | | | | | Pallet Retention Activation Hdw | 95 | 1 | 95 | | |
| | | | | | Cart Latching Hdw | 92 | 1 | 92 | | |
| | | | | | Pallet Stowage Location Engagement Mechanism | 100 | 1 | 100 | | |
| | | | | | Motor Controller | 441 | 1 | 441 | | |
| | | | | | Pallet Transfer Chain Drive System | 335 | 4 | 1,340 | | |
| | | | | | Motor | 51 | 1 | 51 | | |
| | | | | | Gearbox | 134 | 1 | 134 | | |
| | | | | | Chain Drive Assy | 150 | 1 | 150 | | |
| | | | | | Pallet Transfer Mechanism (FR 464 to 506) | | | 8,369 | 2 | 16,738 |
| | | | | | Roller-Screw Drive System (504 inch) | 2,636 | 1 | 2,636 | | |
| | | | | | At 5.23 lbs/in. | | | | | |
| | | | | | Cart, Pallet Transfer | 5,733 | 1 | 5,733 | | |
| | | | | | Cart Structure | 3,665 | 1 | 3,665 | | |
| | | | | | Pallet Retention Activation Hdw | 95 | 1 | 95 | | |
| | | | | | Cart Latching Hdw | 92 | 1 | 92 | | |
| | | | | | Pallet Stowage Location Engagement Mechanism | 100 | 1 | 100 | | |
| | | | | | Motor Controller | 441 | 1 | 441 | | |
| | | | | | Pallet Transfer Chain Drive System | 335 | 4 | 1,340 | | |
| | | | | | Motor | 51 | 1 | 51 | | |
| | | | | | Gearbox | 134 | 1 | 134 | | |
| | | | | | Chain Drive Assy | 150 | 1 | 150 | | |
| | | | | | Pallet Unloading Table | | | 6,012 | 2 | 12,024 |
| | | | | | Fore/ Aft Drive Assy | 333 | 1 | 333 | | |
| | | | | | Motor & Bracket | 178 | 1 | 178 | | |
| | | | | | Gearbox | 64 | 1 | 64 | | |
| | | | | | Roller-Screw & Hardware | 91 | 1 | 91 | | |
| | | | | | Latch Mechanism | 109 | 1 | 109 | | |
| | | | | | Fore/ Aft Rails | 434 | 1 | 434 | | |
| | | | | | Table Structure | 3,000 | 1 | 3,000 | | |
| | | | | | Tracks & Hardware | 1,234 | 1 | 1,234 | | |
| | | | | | Pallet Athwartship Drive Assy | 298 | 2 | 596 | | |
| | | | | | Motor | 107 | 1 | 107 | | |
| | | | | | Gearbox | 97 | 1 | 97 | | |
| | | | | | Roller-Screw & Hardware | 94 | 1 | 94 | | |
| | | | | | Pallet Transfer Pin Hardware | 215 | 1 | 215 | | |
| | | | | | Pallet Lock Hardware | 91 | 1 | 91 | | |
| | | | | | Down Load Hoist | | | 1,560 | 2 | 3,120 |
| | | | | | Tube & Chain Guide | 839 | 1 | 839 | | |
| | | | | | Chain & Pawl Assy | 147 | 1 | 147 | | |
| | | | | | Ammunition Release Mechanism | 38 | 1 | 38 | | |
| | | | | | Drive Assy | 536 | 1 | 536 | | |
| | | | | | Motor & Gearbox | 480 | 1 | 480 | | |
| | | | | | Sprocket & Housing Assy | 56 | 1 | 56 | | |
| | | | | | Load Drum | | | 3,444 | 2 | 6,888 |
| | | | | | Rotating Structure | | | 2,404 | | |
| | | | | | Clip | 824 | 2 | 1,648 | | |
| | | | | | Support Structure & Bearing | 756 | 1 | 756 | | |
| | | | | | Stationary Structure | 1,002 | 1 | 1,002 | | |
| | | | | | Upper Structure | 193 | 1 | 193 | | |
| | | | | | Lower Structure | 708 | 1 | 708 | | |
| | | | | | Latch Assy | 63 | 1 | 63 | | |
| | | | | | Snubber Actuating Assy | 38 | 2 | 76 | | |
| | | | | | Drive Assy | - | 1 | - | | |
| | | | | | Motor & Coupling | 26 | 1 | 26 | | |
| | | | | | Gearbox | 169 | 1 | 169 | | |
| | | | | | Lower Hoist, Port | | | 3,491 | 1 | 3,491 |
| | | | | | Tube & Chain Guide Assy | 1,788 | 1 | 1,788 | | |
| | | | | | Chain & Pawl Assy | 581 | 1 | 581 | | |
| | | | | | Drive Assy | 561 | 2 | 1,122 | | |
| | | | | | Motor & Gearbox | 264 | 1 | 264 | | |
| | | | | | Sprocket & Housing Assy | 297 | 1 | 297 | | |
| | | | | | Lower Hoist, Starboard | | | 3,491 | 1 | 3,491 |

APPENDIX D – OPTION 3 DETAILS

Option 3 - Mount 61 aft, replacing MT52 and NSSM with Extended Mag.

| ADDED WEIGHTS | | | | |
|---------------------------------|----------------------------|---------------|--------------|----------------|
| Component | | Weight (LT) | VCG | LCG |
| Core Gun System | AGS Gun Assembly | 78.64 | 46 | -185.5 |
| | Ammo Handling System | 132.88 | 24.75 | -198.5 |
| | Cooling Skid | 1.29 | 18 | -211.5 |
| | | 212.81 | 32.56 | -193.77 |
| | Side Shell Plate | 11.12 | 36.80 | -223.50 |
| | Aft Bulkhead | 3.40 | 36.80 | -241.50 |
| | Deck Plate | 12.04 | 42.00 | -223.50 |
| Aft Structural Addition Ammo | Stiffener Allowance | 6.64 | - | - |
| | | 33.19 | 39.16 | -225.80 |
| | | 125.00 | 28 | -213.26 |
| TOTAL ADDED | | 371.00 | 31.61 | -203.21 |
| REMOVED WEIGHTS | | | | |
| 5in/54cal Gun System | MT 52 Drum & Foundation | 2.24 | 30.4 | -223.92 |
| | MT 52 Gun Assembly | 22.35 | 37.27 | -223.92 |
| | 5in. Ammo | 27.47 | 20.43 | -226.89 |
| | | 52.06 | 28.09 | -225.49 |
| | Launcher Assy. | 4.45 | 46 | -185.5 |
| | Missiles in Launcher Assy. | 1.61 | 48 | -185.5 |
| NSSMS Assy. | Missiles in Mag. | 9.09 | 44.93 | -143.8 |
| | | 15.15 | 45.57 | -160.48 |
| TOTAL REMOVED | | 67.21 | 32.03 | -210.83 |
| TOTAL CHANGE IN WEIGHTS | | 303.79 | 31.52 | -201.52 |
| CHANGE IN TRIM | | | | |
| Baseline Displacement | 8741 LTON | | | |
| Altered Disp. | 9044.79 LTON | | | |
| Baseline Draft | 20.5 ft | | | |
| TPI | 51.55 LTON/in | | | |
| Altered Draft | 20.99 ft | | | |
| b | -42.5 ft | | | |
| MT1" | 1565 ft-LTON | | | |
| Change in Draft | 0.49 ft | | | |
| Change in Trim | 30.87 in | | By the Stern | |
| | 2.57 ft | | | |

Ammunition Pallet LCG Computation for Option 3

| Number of Pallets | Weight (LTON) | Location (frame number) | Moment (ft-LTON) | |
|----------------------|---------------------|-------------------------|------------------|---------|
| 2 | 5 | 445 | 2225 | 1-426 |
| 2 | 5 | 451 | 2255 | |
| 2 | 5 | 455 | 2275 | |
| 2 | 5 | 477 | 2385 | 1-464-0 |
| 2 | 5 | 482 | 2410 | |
| 2 | 5 | 487 | 2435 | |
| 2 | 5 | 492 | 2460 | |
| 2 | 5 | 497 | 2485 | |
| 2 | 5 | 502 | 2510 | |
| 2 | 5 | 431 | 2155 | 2-426-0 |
| 2 | 5 | 445 | 2225 | |
| 2 | 5 | 451 | 2255 | |
| 2 | 5 | 455 | 2275 | |
| 2 | 5 | 477 | 2385 | 2-464-0 |
| 2 | 5 | 482 | 2410 | |
| 2 | 5 | 487 | 2435 | |
| 2 | 5 | 492 | 2460 | |
| 2 | 5 | 497 | 2485 | |
| 2 | 5 | 502 | 2510 | |
| 2 | 5 | 477 | 2385 | 3-464-0 |
| 2 | 5 | 482 | 2410 | |
| 2 | 5 | 487 | 2435 | |
| 2 | 5 | 492 | 2460 | |
| 2 | 5 | 497 | 2485 | |
| 2 | 5 | 502 | 2510 | |
| Total Pallets | Total Weight | Total Moment | LCG (ft) | |
| 50 | 125 | 59720 | 477.76 | |

OPTION 3 - MAGAZINE WEIGHT DATA

| Lvl | Lvl | Lvl | Lvl | Lvl | Element or Assembly Name | Weight | Quantity | Total Weight | Quantity | Contribution to System Weight |
|--|-----|-----|-----|-----|--|--------|----------|----------------|----------|-------------------------------|
| Magazine, AGS | | | | | | | | | | |
| Kit, Storage Location Hardware | | | | | | | | 126,492 | 1 | 126,492 |
| | | | | | Bracket Assembly, High Track, Duel Pallet Supporting | 1,212 | 28 | 33,936 | | |
| | | | | | [Structure, Dual Supporting | 1,012 | 1 | 1,012 | | |
| | | | | | [Attaching Hardware] | 200 | 1 | 200 | | |
| | | | | | Bracket Assembly, High Track Right Pallet Supporting | 1,167 | 10 | 11,670 | | |
| | | | | | [Structure, High Track, Right Supporting | 1,012 | 1 | 1,012 | | |
| | | | | | [Attaching Hardware] | 155 | 1 | 155 | | |
| | | | | | Bracket Assembly, High Track, Left Pallet Supporting | 1,167 | 10 | 11,670 | | |
| | | | | | Bracket Assembly, Low Track, Duel Pallet Supporting | 1,285 | 28 | 35,980 | | |
| | | | | | [Structure, Dual Supporting | 1,012 | 1 | 1,012 | | |
| | | | | | [Attaching Hardware] | 273 | 1 | 273 | | |
| | | | | | Bracket Assembly, Low Track, Right Pallet Supporting | 1,240 | 10 | 12,400 | | |
| | | | | | Bracket Assembly, Low Track, Left Pallet Supporting | 1,240 | 10 | 12,400 | | |
| | | | | | [Structure, Low Track, Left Supporting | 1,012 | 1 | 1,012 | | |
| | | | | | [Attaching Hardware] | 228 | 1 | 228 | | |
| | | | | | Pallet Retention Hardware, High Track | 106 | 38 | 4,028 | | |
| | | | | | Pallet Retention Hardware, Low Track | 116 | 38 | 4,408 | | |
| Electrical Enclosures | | | | | | | | 9,658 | 1 | 9,658 |
| | | | | | 1st Platform Port Equipment Enclosure | 1,074 | 1 | 1,074 | | |
| | | | | | 1st Platform Starboard Equipment Enclosure | 1,074 | 1 | 1,074 | | |
| | | | | | Centerline Equipment Enclosure | 765 | 1 | 765 | | |
| | | | | | 2nd Platform Port Equipment Enclosure | 1,526 | 1 | 1,526 | | |
| | | | | | 2nd Platform Starboard Equipment Enclosure | 1,526 | 1 | 1,526 | | |
| | | | | | 3rd Deck Equipment Enclosure | 1,973 | 1 | 1,973 | | |
| | | | | | Hold Port Equipment Enclosure | | | | | |
| | | | | | Hold Starboard Equipment Enclosure | | | | | |
| | | | | | DAP Enclosures | 220 | 1 | 220 | | |
| | | | | | Magazine PDP | 1,500 | 1 | 1,500 | | |
| Cabling and Clamping | | | | | | | | 11,317 | 1 | 11,317 |
| | | | | | Cables | 10,703 | 1 | 10,703 | | |
| | | | | | Cable Clamps | 214 | 1 | 214 | | |
| | | | | | Junction boxes | 400 | 1 | 400 | | |
| Pallet Transfer Mechanism (FR 440 to 464) | | | | | | | | 7,239 | 1 | 7,239 |
| | | | | | Roller-Screw Drive System (288 inch) | 1,506 | 1 | 1,506 | | |
| | | | | | [At 5.23 lbs/in. | | | | | |
| | | | | | Cart, Pallet Transfer | 5,733 | 1 | 5,733 | | |
| | | | | | [Cart Structure | 3,665 | 1 | 3,665 | | |
| | | | | | [Pallet Retention Activation Hdw | 95 | 1 | 95 | | |
| | | | | | [Cart Latching Hdw | 92 | 1 | 92 | | |
| | | | | | [Pallet Stowage Location Engagement Mechanism | 100 | 1 | 100 | | |
| | | | | | [Motor Controller | 441 | 1 | 441 | | |
| | | | | | [Pallet Transfer Chain Drive System | 335 | 4 | 1,340 | | |
| | | | | | [Motor | 51 | 1 | 51 | | |
| | | | | | [Gearbox | 134 | 1 | 134 | | |
| | | | | | [Chain Drive Assy | 150 | 1 | 150 | | |
| Pallet Transfer Mechanism (FR 426 to 464) | | | | | | | | 8,118 | 1 | 8,118 |
| | | | | | Roller-Screw Drive System (456 inch) | 2,385 | 1 | 2,385 | | |
| | | | | | [At 5.23 lbs/in. | 2,869 | 1 | 2,869 | | |
| | | | | | Cart, Pallet Transfer | 5,733 | 1 | 5,733 | | |
| | | | | | [Cart Structure | 3,665 | 1 | 3,665 | | |
| | | | | | [Pallet Retention Activation Hdw | 95 | 1 | 95 | | |
| | | | | | [Cart Latching Hdw | 92 | 1 | 92 | | |
| | | | | | [Pallet Stowage Location Engagement Mechanism | 100 | 1 | 100 | | |
| | | | | | [Motor Controller | 441 | 1 | 441 | | |
| | | | | | [Pallet Transfer Chain Drive System | 335 | 4 | 1,340 | | |
| | | | | | [Motor | 51 | 1 | 51 | | |
| | | | | | [Gearbox | 134 | 1 | 134 | | |
| | | | | | [Chain Drive Assy | 150 | 1 | 150 | | |
| Pallet Transfer Mechanism (FR 464 to 506) | | | | | | | | 8,369 | 3 | 25,107 |
| | | | | | Roller-Screw Drive System (504 inch) | 2,636 | 1 | 2,636 | | |
| | | | | | [At 5.23 lbs/in. | | | | | |
| | | | | | Cart, Pallet Transfer | 5,733 | 1 | 5,733 | | |
| | | | | | [Cart Structure | 3,665 | 1 | 3,665 | | |
| | | | | | [Pallet Retention Activation Hdw | 95 | 1 | 95 | | |
| | | | | | [Cart Latching Hdw | 92 | 1 | 92 | | |
| | | | | | [Pallet Stowage Location Engagement Mechanism | 100 | 1 | 100 | | |
| | | | | | [Motor Controller | 441 | 1 | 441 | | |
| | | | | | [Pallet Transfer Chain Drive System | 335 | 4 | 1,340 | | |
| | | | | | [Motor | 51 | 1 | 51 | | |
| | | | | | [Gearbox | 134 | 1 | 134 | | |
| | | | | | [Chain Drive Assy | 150 | 1 | 150 | | |
| Pallet Unloading Table | | | | | | | | 6,012 | 2 | 12,024 |
| | | | | | Fore/ Aft Drive Assy | 333 | 1 | 333 | | |
| | | | | | [Motor & Bracket | 178 | 1 | 178 | | |
| | | | | | [Gearbox] | 64 | 1 | 64 | | |
| | | | | | [Roller-Screw & Hardware | 91 | 1 | 91 | | |
| | | | | | Latch Mechanism | 109 | 1 | 109 | | |
| | | | | | Fore/ Aft Rails | 434 | 1 | 434 | | |
| | | | | | Table Structure | 3,000 | 1 | 3,000 | | |
| | | | | | Tracks & Hardware | 1,234 | 1 | 1,234 | | |
| | | | | | Pallet Athwartship Drive Assy | 298 | 2 | 596 | | |
| | | | | | [Motor | 107 | 1 | 107 | | |
| | | | | | [Gearbox | 97 | 1 | 97 | | |
| | | | | | [Roller-Screw & Hardware | 94 | 1 | 94 | | |
| | | | | | Pallet Transfer Pin Hardware | 215 | 1 | 215 | | |
| | | | | | Pallet Lock Hardware | 91 | 1 | 91 | | |
| Down Load Hoist | | | | | | | | 1,560 | 2 | 3,120 |
| | | | | | Tube & Chain Guide | 839 | 1 | 839 | | |
| | | | | | Chain & Pawl Assy | 147 | 1 | 147 | | |
| | | | | | Ammunition Release Mechanism | 38 | 1 | 38 | | |
| | | | | | Drive Assy | 536 | 1 | 536 | | |
| | | | | | [Motor & Gearbox | 480 | 1 | 480 | | |
| | | | | | [Sprocket & Housing Assy | 56 | 1 | 56 | | |
| Load Drum | | | | | | | | 3,444 | 2 | 6,888 |
| | | | | | Rotating Structure | | | 2,404 | | |
| | | | | | [Clip | 824 | 2 | 1,648 | | |
| | | | | | [Support Structure & Bearing | 756 | 1 | 756 | | |
| | | | | | Stationary Structure | 1,002 | 1 | 1,040 | | |
| | | | | | [Upper Structure | 193 | 1 | 193 | | |
| | | | | | [Lower Structure | 708 | 1 | 708 | | |
| | | | | | [Latch Assy | 63 | 1 | 63 | | |
| | | | | | [Snubber Actuating Assy | 38 | 2 | 76 | | |
| | | | | | Drive Assy | | | - | | |
| | | | | | [Motor & Coupling | 26 | 1 | 26 | | |
| | | | | | [Gearbox | 169 | 1 | 169 | | |
| Lower Hoist, Port | | | | | | | | 3,491 | 1 | 3,491 |
| | | | | | Tube & Chain Guide Assy | 1,788 | 1 | 1,788 | | |

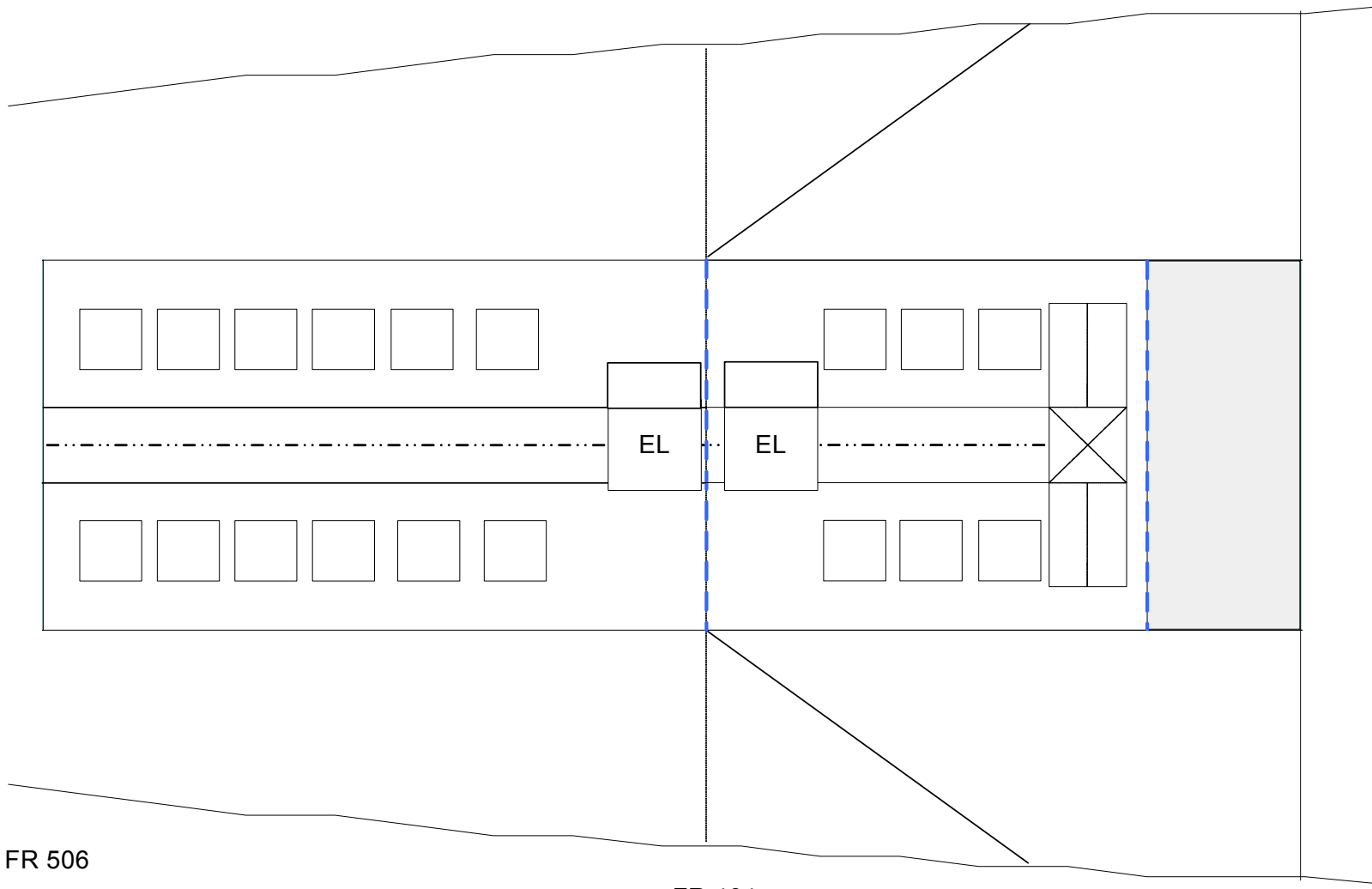

FR 506

FR 464

FR 426



APPENDIX E – STRUCTURAL ANALYSIS

Structural Analysis, Full Load, Stillwater

Unmodified

| SHEAR & LONGITUDINAL BENDING STRESS SUMMARY | | | | | | |
|---|----------------|---------------------|--------------------|------------------|-----------|-----|
| LOCATION ft-FP | SHEAR FORCES | | MOMENT ft-LTons | BENDING MOMENTS | | |
| | SHEAR LTons | SHEAR STRESS ksi | | DK STRESS ksi | KL ksi | |
| 58.00A | -292 | | 8,987H | | | |
| 94.00A | -443 | | 22,401H | | | |
| 138.00A | -531 | | 43,936H | | | |
| 174.00A | -601 | | 63,259H | | | |
| 220.00A | -309 | | 84,940H | | | |
| 250.00A | -253 | -0.67 | 93,591H | 11.37 | -9.13 | FWD |
| 260.00A | -147 | | 95,637H | | | |
| 264.50A | -159 | -0.40 | 96,329H | 11.80 | -8.96 | MS |
| 290.00A | -7 | -0.02 | 98,931H | 12.02 | -9.12 | AFT |
| 290.60A | 0 | | 98,933H | | | Mx |
| 300.00A | 104 | | 98,480H | | | |
| 346.00A | 586 | | 82,282H | | | |
| 382.00A | 706 | | 57,012H | | | |
| 426.00A | 566 | | 29,052H | | | |
| 464.00A | 397 | | 10,999H | | | |
| Maximum Shear Stress at FWD: | | | -0.67 ksi | | | |
| Maximum Deck Bending Stress at AFT: | | | 12.02 ksi | | | |
| Maximum Keel Bending Stress at FWD: | | | -9.13 ksi | | | |

Modified

| SHEAR & LONGITUDINAL BENDING STRESS SUMMARY | | | | | | |
|---|----------------|---------------------|--------------------|------------------|------------------|-----|
| LOCATION ft-FP | SHEAR FORCES | | MOMENT ft-LTons | BENDING MOMENTS | | |
| | SHEAR LTons | SHEAR STRESS ksi | | DK STRESS ksi | KL STRESS ksi | |
| 58.00A | -299 | | 9,140H | | | |
| 94.00A | -459 | | 22,956H | | | |
| 138.00A | -557 | | 45,412H | | | |
| 174.00A | -632 | | 65,778H | | | |
| 220.00A | -340 | | 88,949H | | | |
| 250.00A | -279 | -0.74 | 98,478H | 11.97 | -9.60 | FWD |
| 260.00A | -170 | | 100,767H | | | |
| 264.50A | -180 | -0.46 | 101,558H | 12.44 | -9.45 | MS |
| 290.00A | -17 | -0.04 | 104,566H | 12.70 | -9.64 | AFT |
| 291.44A | 0 | | 104,580H | | | Mx |
| 300.00A | 100 | | 104,190H | | | |
| 346.00A | 612 | | 87,532H | | | |
| 382.00A | 765 | | 60,748H | | | |
| 426.00A | 671 | | 29,221H | | | |
| 464.00A | 359 | | 8,390H | | | |
| Maximum Shear Stress at FWD: | | | -0.74 ksi | | | |
| Maximum Deck Bending Stress at AFT: | | | 12.70 ksi | | | |
| Maximum Keel Bending Stress at AFT: | | | -9.64 ksi | | | |

Structural Analysis, Full Load, Hogging

Unmodified

SHEAR & LONGITUDINAL BENDING STRESS SUMMARY
(Wave with Height = 25.3ft -- Hogging Position)

| LOCATION ft-FP | SHEAR FORCES | | MOMENT ft-LTons | BENDING MOMENTS | | |
|-------------------|----------------|---------------------|--------------------|------------------|------------------|-----|
| | SHEAR LTons | SHEAR STRESS ksi | | DK STRESS ksi | KL STRESS ksi | |
| 58.00A | -490 | | 13,245H | | | |
| 94.00A | -903 | | 38,129H | | | |
| 138.00A | -1,333 | | 87,802H | | | |
| 174.00A | -1,547 | | 139,113H | | | |
| 220.00A | -1,064 | | 201,838H | | | |
| 250.00A | -657 | -1.74 | 228,363H | 27.75 | -22.27 | FWD |
| 260.00A | -406 | | 233,836H | | | |
| 264.50A | -351 | -0.89 | 235,554H | 28.85 | -21.91 | MS |
| 281.10A | -3 | -0.01 | 238,784H | 29.09 | -22.09 | Mx |
| 290.00A | 188 | 0.48 | 237,857H | 28.89 | -21.94 | AFT |
| 300.00A | 443 | | 234,754H | | | |
| 346.00A | 1,423 | | 190,234H | | | |
| 382.00A | 1,665 | | 131,896H | | | |
| 426.00A | 1,346 | | 64,385H | | | |
| 464.00A | 833 | | 23,032H | | | |

Maximum Shear Stress at FWD: -1.74 ksi
 Maximum Deck Bending Stress at Mx: 29.09 ksi
 Maximum Keel Bending Stress at FWD: -22.27 ksi

Modified

SHEAR & LONGITUDINAL BENDING STRESS SUMMARY
(Wave with Height = 25.3ft -- Hogging Position)

| LOCATION ft-FP | SHEAR FORCES | | MOMENT ft-LTons | BENDING MOMENTS | | |
|-------------------|----------------|---------------------|--------------------|------------------|------------------|-----|
| | SHEAR LTons | SHEAR STRESS ksi | | DK STRESS ksi | KL STRESS ksi | |
| 58.00A | -496 | | 13,390H | | | |
| 94.00A | -920 | | 38,675H | | | |
| 138.00A | -1,373 | | 89,580H | | | |
| 174.00A | -1,604 | | 142,640H | | | |
| 220.00A | -1,133 | | 208,342H | | | |
| 250.00A | -722 | -1.91 | 236,914H | 28.79 | -23.11 | FWD |
| 260.00A | -468 | | 243,023H | | | |
| 264.50A | -410 | -1.04 | 245,016H | 30.01 | -22.79 | MS |
| 283.05A | -2 | -0.00 | 249,191H | 30.33 | -23.04 | Mx |
| 290.00A | 143 | 0.36 | 248,665H | 30.20 | -22.93 | AFT |
| 300.00A | 406 | | 245,967H | | | |
| 346.00A | 1,439 | | 202,016H | | | |
| 382.00A | 1,736 | | 142,152H | | | |
| 426.00A | 1,500 | | 69,743H | | | |
| 464.00A | 869 | | 23,200H | | | |

Maximum Shear Stress at FWD: -1.91 ksi
 Maximum Deck Bending Stress at Mx: 30.33 ksi
 Maximum Keel Bending Stress at FWD: -23.11 ksi

Structural Analysis, Minimum Operating, Stillwater

Unmodified

SHEAR & LONGITUDINAL BENDING STRESS SUMMARY

| SHEAR FORCES | | BENDING MOMENTS | | | |
|--------------|-------|-----------------|----------|-----------|-----------|
| LOCATION | SHEAR | SHEAR STRESS | MOMENT | DK STRESS | KL STRESS |
| ft-FP | LTons | ksi | ft-LTons | ksi | ksi |
| 58.00A | -297 | | 9,100H | | |
| 94.00A | -461 | | 22,912H | | |
| 138.00A | -545 | | 45,557H | | |
| 174.00A | -644 | | 65,791H | | |
| 220.00A | -374 | | 89,962H | | |
| 250.00A | -206 | -0.54 | 98,580H | 11.98 | -9.61 |
| 260.00A | -107 | | 100,185H | | |
| 264.50A | -125 | -0.32 | 100,709H | 12.33 | -9.37 |
| 286.21A | -3 | -0.01 | 102,709H | 12.49 | -9.48 |
| 290.00A | 35 | 0.09 | 102,649H | 12.47 | -9.47 |
| 300.00A | 141 | | 101,807H | | |
| 346.00A | 606 | | 84,330H | | |
| 382.00A | 748 | | 58,231H | | |
| 426.00A | 580 | | 29,115H | | |
| 464.00A | 396 | | 10,864H | | |

Maximum Shear Stress at FWD: -0.54 ksi
 Maximum Deck Bending Stress at Mx: 12.49 ksi
 Maximum Keel Bending Stress at FWD: -9.61 ksi

Modified

SHEAR & LONGITUDINAL BENDING STRESS SUMMARY

| SHEAR FORCES | | BENDING MOMENTS | | | |
|--------------|-------|-----------------|----------|-----------|-----------|
| LOCATION | SHEAR | SHEAR STRESS | MOMENT | DK STRESS | KL STRESS |
| ft-FP | LTons | ksi | ft-LTons | ksi | ksi |
| 58.00A | -305 | | 9,250H | | |
| 94.00A | -476 | | 23,461H | | |
| 138.00A | -570 | | 47,020H | | |
| 174.00A | -675 | | 68,293H | | |
| 220.00A | -406 | | 93,952H | | |
| 250.00A | -231 | -0.61 | 103,446H | 12.57 | -10.09 |
| 260.00A | -129 | | 105,294H | | |
| 264.50A | -146 | -0.37 | 105,918H | 12.97 | -9.85 |
| 287.67A | -1 | -0.00 | 108,293H | 13.16 | -9.99 |
| 290.00A | 25 | 0.06 | 108,265H | 13.15 | -9.98 |
| 300.00A | 136 | | 107,498H | | |
| 346.00A | 632 | | 89,564H | | |
| 382.00A | 807 | | 61,955H | | |
| 426.00A | 685 | | 29,276H | | |
| 464.00A | 358 | | 8,251H | | |

Maximum Shear Stress at FWD: -0.61 ksi
 Maximum Deck Bending Stress at Mx: 13.16 ksi
 Maximum Keel Bending Stress at FWD: -10.09 ksi

Structural Analysis, Minimum Operating, Hogging

Unmodified

SHEAR & LONGITUDINAL BENDING STRESS SUMMARY
(Wave with Height = 25.3ft -- Hogging Position)

| SHEAR FORCES | | BENDING MOMENTS | | | |
|--------------|--------|-----------------|----------|-----------|-----------|
| LOCATION | SHEAR | SHEAR STRESS | MOMENT | DK STRESS | KL STRESS |
| ft-FP | LTons | ksi | ft-LTons | ksi | ksi |
| 58.00A | -494 | | 13,356H | | |
| 94.00A | -917 | | 38,553H | | |
| 138.00A | -1,344 | | 89,180H | | |
| 174.00A | -1,589 | | 141,328H | | |
| 220.00A | -1,133 | | 206,584H | | |
| 250.00A | -613 | -1.62 | 233,183H | 28.34 | -22.74 |
| 260.00A | -370 | | 238,260H | | |
| 264.50A | -321 | -0.82 | 239,832H | 29.37 | -22.31 |
| 279.52A | -31 | -0.08 | 242,755H | 29.58 | -22.47 |
| 290.00A | 224 | 0.57 | 241,599H | 29.34 | -22.28 |
| 300.00A | 474 | | 238,155H | | |
| 346.00A | 1,440 | | 192,566H | | |
| 382.00A | 1,705 | | 133,500H | | |
| 426.00A | 1,362 | | 64,822H | | |
| 464.00A | 838 | | 23,111H | | |

Maximum Shear Stress at FWD: -1.62 ksi
 Maximum Deck Bending Stress at Mx: 29.58 ksi
 Maximum Keel Bending Stress at FWD: -22.74 ksi

Modified

SHEAR & LONGITUDINAL BENDING STRESS SUMMARY
(Wave with Height = 25.3ft -- Hogging Position)

| SHEAR FORCES | | BENDING MOMENTS | | | |
|--------------|--------|-----------------|----------|-----------|-----------|
| LOCATION | SHEAR | SHEAR STRESS | MOMENT | DK STRESS | KL STRESS |
| ft-FP | LTons | ksi | ft-LTons | ksi | ksi |
| 58.00A | -497 | | 13,399H | | |
| 94.00A | -931 | | 38,870H | | |
| 138.00A | -1,380 | | 90,581H | | |
| 174.00A | -1,644 | | 144,386H | | |
| 220.00A | -1,201 | | 212,563H | | |
| 250.00A | -679 | -1.80 | 241,213H | 29.32 | -23.52 |
| 260.00A | -433 | | 246,933H | | |
| 264.50A | -382 | -0.97 | 248,783H | 30.47 | -23.14 |
| 281.90A | -21 | -0.05 | 252,650H | 30.77 | -23.36 |
| 290.00A | 178 | 0.45 | 251,930H | 30.60 | -23.23 |
| 300.00A | 436 | | 248,909H | | |
| 346.00A | 1,452 | | 203,994H | | |
| 382.00A | 1,773 | | 143,503H | | |
| 426.00A | 1,513 | | 70,057H | | |
| 464.00A | 871 | | 23,259H | | |

Maximum Shear Stress at FWD: -1.80 ksi
 Maximum Deck Bending Stress at Mx: 30.77 ksi
 Maximum Keel Bending Stress at FWD: -23.52 ksi

APPENDIX F – STABILITY ANALYSIS

Intact Stability, Full Load Condition

Weight Report unmodified

VESSEL DISPLACEMENT AND CENTER'S OF GRAVITY

| ITEM | WEIGHT LTons | KG ft | LCG ft-FP | TCG ft | FSmom ft-Ltons |
|--------------|-----------------|----------|--------------|-----------|-------------------|
| Light Ship | 6,421 | 26.00 | 269.00A | 0.00 | |
| Constant | 0 | 0.00 | 264.50A | 0.00 | 0 |
| Misc. Cargo | 427 | 24.03 | 330.41A | 0.00 | 0 |
| Misc. Weight | 0 | 0.00 | 264.50A | 0.00 | 0 |
| Diesel Oil | 1,802 | 8.19 | 299.92A | 0.00 | 0 |
| Fresh Water | 91 | 11.25 | 278.57A | 0.00 | 0 |
| <hr/> | | | | | |
| TOTALS | 8,741 | 22.08 | 278.48A | 0.00 | 0 |

Weight Report modified

VESSEL DISPLACEMENT AND CENTER'S OF GRAVITY

| ITEM | WEIGHT LTons | KG ft | LCG ft-FP | TCG ft | FSmom ft-LTons |
|--------------|-----------------|----------|--------------|-----------|-------------------|
| Light Ship | 6,421 | 26.00 | 269.00A | 0.00 | |
| Constant | 0 | 0.00 | 264.50A | 0.00 | 0 |
| Misc. Cargo | 427 | 24.03 | 330.41A | 0.00 | 0 |
| Misc. Weight | 237 | 29.70 | 456.37A | 0.00 | 0 |
| Diesel Oil | 1,802 | 8.19 | 299.92A | 0.00 | 0 |
| Fresh Water | 91 | 11.25 | 278.57A | 0.00 | 0 |
| <hr/> | | | | | |
| TOTALS | 8,978 | 22.28 | 283.17A | 0.00 | 0 |

Trim report unmodified

STABILITY CALCULATION
KMT 26.78 ft
KG 22.08 ft
GMt 4.70 ft
FSc 0.00 ft
GMt Corrected 4.70 ft
Prop. Immersion 164 %
List 0.00 deg
DRAFTS
F.P. 21ft- 4.5in (6.51m)
M.S. 21ft- 1.5in (6.44m)
A.P. 20ft-10.5in (6.36m)

TRIM CALCULATION
LCF Draft 21.09 ft
LCB (even keel) 279.56 ft-AFT
LCF 307.15 ft-AFT
MTlin 1,598 ft-LT/in
Trim 0.49 ft-FWD

Trim report modified

STABILITY CALCULATION
KMT 26.71 ft
KG 22.28 ft
GMt 4.43 ft
FSc 0.00 ft
GMt Corrected 4.43 ft
Prop. Immersion 171 %
List 0.00 deg
DRAFTS
F.P. 20ft- 8.2in (6.30m)
M.S. 21ft- 4.3in (6.51m)
A.P. 22ft- 0.4in (6.71m)

TRIM CALCULATION
LCF Draft 21.46 ft
LCB (even keel) 280.28 ft-AFT
LCF 307.04 ft-AFT
MTlin 1,607 ft-LT/in
Trim 1.35 ft-AFT

Unmodified

BEAM WIND with ROLLING STABILITY EVALUATION
(per U.S. Navy DDS079-1)

| | Available | Required | | |
|-----------------------|---------------|---------------------|---|-------------|
| Wind Heeling Arm Lw | 1.10 ft | | | |
| Maximum Righting Arm | 4.38 ft | 1.83 ft | | |
| Capsizing Area A2 | 26.6 ft-deg | | | |
| Righting Area A1 | 110.9 ft-deg | 37.3 ft-deg | | |
| Wind Pressure Factor= | 0.0035 | Displacement | = | 8,741 LTons |
| Wind Pressure = | 0.0156 LT/ft2 | GMT (corrected) | = | 4.70 ft |
| Wind Velocity = | 100 knots | Mean Draft | = | 21.13 ft |
| Projected Sail Area = | 20669.4 ft2 | Roll Angle | = | 25.0 deg |
| Vertical Arm = | 42.07 ft ABL | | | |
| Heeling Arm at 0 deg= | 1.16 ft | Angle at Intercept= | = | 60.0 deg |
| Wind Heel Arm Lw = | 1.10 ft | Maximum GZ | = | 4.38 ft |
| Wind Heel Angle = | 13.5 deg | Angle at Max. GZ | = | 55.1 deg |

Modified

BEAM WIND with ROLLING STABILITY EVALUATION
(per U.S. Navy DDS079-1)

| | Available | Required | | |
|-----------------------|---------------|---------------------|---|-------------|
| Wind Heeling Arm Lw | 1.06 ft | | | |
| Maximum Righting Arm | 4.20 ft | 1.77 ft | | |
| Capsizing Area A2 | 25.4 ft-deg | | | |
| Righting Area A1 | 106.9 ft-deg | 35.6 ft-deg | | |
| Wind Pressure Factor= | 0.0035 | Displacement | = | 8,978 LTons |
| Wind Pressure = | 0.0156 LT/ft2 | GMT (corrected) | = | 4.43 ft |
| Wind Velocity = | 100 knots | Mean Draft | = | 21.36 ft |
| Projected Sail Area = | 20547.4 ft2 | Roll Angle | = | 25.0 deg |
| Vertical Arm = | 42.19 ft ABL | | | |
| Heeling Arm at 0 deg= | 1.13 ft | Angle at Intercept= | = | 60.0 deg |
| Wind Heel Arm Lw = | 1.06 ft | Maximum GZ | = | 4.20 ft |
| Wind Heel Angle = | 13.7 deg | Angle at Max. GZ | = | 53.9 deg |

UnmodifiedEFFECT on STABILITY of HIGH SPEED TURNING
(per U.S. Navy DDS079-1)

| | Available | Required | | |
|-----------------------|--------------|---------------------|-------------|--|
| Angle of Heel | 9.9 deg | 15.0 deg | | |
| Heeling Arm Lc | 0.81 ft | | | |
| Maximum Righting Arm | 4.38 ft | 1.34 ft | | |
| Total Righting Area | 152.2 ft-deg | | | |
| Reserve Righting Area | 115.7 ft-deg | 60.9 ft-deg | | |
| Ship Speed in Turn = | 30.0 knots | Displacement = | 8,741 LTons | |
| Turn Circle Radius = | 1122 ft | VCG = | 22.08 ft | |
| Heeling Arm at 0 deg= | 0.82 ft | Mean Draft = | 21.13 ft | |
| Angle at Max. GZ = | 55.1 deg | Positive GZ Range = | 60.0 deg | |
| Angle at Intercept = | 60.0 deg | | | |

ModifiedEFFECT on STABILITY of HIGH SPEED TURNING
(per U.S. Navy DDS079-1)

| | Available | Required | | |
|-----------------------|--------------|---------------------|-------------|--|
| Angle of Heel | 10.5 deg | 15.0 deg | | |
| Heeling Arm Lc | 0.81 ft | | | |
| Maximum Righting Arm | 4.20 ft | 1.35 ft | | |
| Total Righting Area | 146.7 ft-deg | | | |
| Reserve Righting Area | 110.2 ft-deg | 58.7 ft-deg | | |
| Ship Speed in Turn = | 30.0 knots | Displacement = | 8,978 LTons | |
| Turn Circle Radius = | 1122 ft | VCG = | 22.28 ft | |
| Heeling Arm at 0 deg= | 0.82 ft | Mean Draft = | 21.36 ft | |
| Angle at Max. GZ = | 53.9 deg | Positive GZ Range = | 60.0 deg | |
| Angle at Intercept = | 60.0 deg | | | |

Unmodified

CROWDING of PERSONNEL TO ONE SIDE
(per U.S. Navy DDS079-1)
Available Required

| | | | | |
|-----------------------|--------------|---------------------|-------------|--|
| Angle of Heel | 0.9 deg | 15.0 deg | | |
| Heeling Arm Lc | 0.07 ft | | | |
| Maximum Righting Arm | 4.38 ft | 0.12 ft | | |
| Total Righting Area | 152.2 ft-deg | | | |
| Reserve Righting Area | 148.5 ft-deg | 60.9 ft-deg | | |
| Weight of Personnel = | 31 LTons | Displacement = | 8,741 Ltons | |
| TCG of Personnel = | 21.00 ft-CL | GMT (corrected) = | 4.70 ft | |
| Heeling Arm at 0 deg= | 0.07 ft | | | |
| Angle at Max. GZ = | 55.1 deg | Positive GZ Range = | 60.0 deg | |
| Angle at Intercept = | 60.0 deg | | | |

Modified

CROWDING of PERSONNEL TO ONE SIDE
(per U.S. Navy DDS079-1)
Available Required

| | | | | |
|-----------------------|--------------|---------------------|-------------|--|
| Angle of Heel | 0.9 deg | 15.0 deg | | |
| Heeling Arm Lc | 0.07 ft | | | |
| Maximum Righting Arm | 4.20 ft | 0.12 ft | | |
| Total Righting Area | 146.7 ft-deg | | | |
| Reserve Righting Area | 143.1 ft-deg | 58.7 ft-deg | | |
| Weight of Personnel = | 31 LTons | Displacement = | 8,978 Ltons | |
| TCG of Personnel = | 21.00 ft-CL | GMT (corrected) = | 4.43 ft | |
| Heeling Arm at 0 deg= | 0.07 ft | | | |
| Angle at Max. GZ = | 53.9 deg | Positive GZ Range = | 60.0 deg | |
| Angle at Intercept = | 60.0 deg | | | |

Unmodified

ICING CONDITION -- BEAM WIND/ROLL STABILITY EVALUATION
(per U.S. Navy DDS079-1)

| | Available | Required | |
|-----------------------|---------------|---------------------|---------------|
| Wind Heeling Arm Lw | 1.05 ft | | |
| Maximum Righting Arm | 3.89 ft | 1.74 ft | |
| Capsizing Area A2 | 23.6 ft-deg | | |
| Righting Area A1 | 97.0 ft-deg | 33.1 ft-deg | |
| <hr/> | | | |
| Wind Pressure Factor= | 0.0035 | Displacement | = 9,004 LTons |
| Wind Pressure = | 0.0156 LT/ft2 | GMt (corrected) | = 4.04 ft |
| Projected Sail Area = | 20423.2 ft2 | Roll Angle | = 25.0 deg |
| Vertical Arm = | 42.32 ft ABL | | |
| Heeling Arm at 0 deg= | 1.12 ft | Angle at Intercept= | 60.0 deg |
| Wind Heel Arm Lw = | 1.05 ft | Maximum GZ | = 3.89 ft |
| Wind Heel Angle = | 14.7 deg | Angle at Max. GZ | = 53.0 deg |
| Weight of Ice = | 262 LTons | Ice Thickness | = 6.0 in |
| Density of Ice = | 39.500 ft3/LT | Ice Surface Area | = 20736.0 ft2 |
| KG of Ice = | 42.00 ft | | |

Modified

ICING CONDITION -- BEAM WIND/ROLL STABILITY EVALUATION
(per U.S. Navy DDS079-1)

| | Available | Required | |
|-----------------------|---------------|---------------------|---------------|
| Wind Heeling Arm Lw | 1.01 ft | | |
| Maximum Righting Arm | 3.73 ft | 1.68 ft | |
| Capsizing Area A2 | 22.6 ft-deg | | |
| Righting Area A1 | 93.3 ft-deg | 31.6 ft-deg | |
| <hr/> | | | |
| Wind Pressure Factor= | 0.0035 | Displacement | = 9,241 LTons |
| Wind Pressure = | 0.0156 LT/ft2 | GMt (corrected) | = 3.80 ft |
| Projected Sail Area = | 20300.9 ft2 | Roll Angle | = 25.0 deg |
| Vertical Arm = | 42.44 ft ABL | | |
| Heeling Arm at 0 deg= | 1.08 ft | Angle at Intercept= | 60.0 deg |
| Wind Heel Arm Lw = | 1.01 ft | Maximum GZ | = 3.73 ft |
| Wind Heel Angle = | 14.9 deg | Angle at Max. GZ | = 52.1 deg |
| Weight of Ice = | 262 LTons | Ice Thickness | = 6.0 in |
| Density of Ice = | 39.500 ft3/LT | Ice Surface Area | = 20736.0 ft2 |
| KG of Ice = | 42.00 ft | | |

Intact Stability, Minimum Operating Condition

Weight report unmodified

VESSEL DISPLACEMENT AND CENTER'S OF GRAVITY

| ITEM | WEIGHT LTons | KG ft | LCG ft-FP | TCG ft | Fsmom ft-LTons |
|--------------|-----------------|----------|--------------|-----------|-------------------|
| Light Ship | 6,421 | 26.00 | 269.00A | 0.00 | |
| Constant | 0 | 0.00 | 264.50A | 0.00 | 0 |
| Misc. Cargo | 265 | 22.12 | 384.72A | 0.00 | 0 |
| Misc. Weight | 0 | 0.00 | 264.50A | 0.00 | 0 |
| Diesel Oil | 1,944 | 8.17 | 299.64A | 0.00 | 0 |
| Fresh Water | 30 | 11.25 | 278.57A | 0.00 | 106 |
| TOTALS | 8,660 | 21.83 | 279.45A | 0.00 | 106 |

Weight report modified

VESSEL DISPLACEMENT AND CENTER'S OF GRAVITY

| ITEM | WEIGHT LTons | KG ft | LCG ft-FP | TCG ft | Fsmom ft-LTons |
|--------------|-----------------|----------|--------------|-----------|-------------------|
| Light Ship | 6,421 | 26.00 | 269.00A | 0.00 | |
| Constant | 0 | 0.00 | 264.50A | 0.00 | 0 |
| Misc. Cargo | 265 | 22.12 | 384.72A | 0.00 | 0 |
| Misc. Weight | 237 | 29.70 | 456.37A | 0.00 | 0 |
| Diesel Oil | 1,944 | 8.17 | 299.64A | 0.00 | 0 |
| Fresh Water | 30 | 11.25 | 278.57A | 0.00 | 106 |
| TOTALS | 8,897 | 22.04 | 284.16A | 0.00 | 106 |

Trim report unmodified

STABILITY CALCULATION

KMt 26.80 ft
KG 21.83 ft
GMt 4.97 ft
FSc 0.01 ft
GMt Corrected 4.96 ft
Prop. Immersion 165 %
List 0.00 deg

DRAFTS

F.P. 20ft-10.9in (6.37m)
M.S. 20ft-11.4in (6.39m)
A.P. 20ft-11.8in (6.40m)

TRIM CALCULATION

LCF Draft 20.95 ft
LCB (even keel) 279.29 ft-AFT
LCF 307.17 ft-AFT
MTlin 1,595 ft-LT/in
Trim 0.07 ft-AFT

Trim report modified

STABILITY CALCULATION

KMt 26.73 ft
KG 22.04 ft
GMt 4.69 ft
FSc 0.01 ft
GMt Corrected 4.68 ft
Prop. Immersion 171 %
List 0.00 deg

DRAFTS

F.P. 20ft- 2.7in (6.17m)
M.S. 21ft- 2.2in (6.46m)
A.P. 22ft- 1.6in (6.75m)

TRIM CALCULATION

LCF Draft 21.33 ft
LCB (even keel) 280.04 ft-AFT
LCF 307.09 ft-AFT
MTlin 1,604 ft-LT/in
Trim 1.90 ft-AFT

Unmodified

BEAM WIND with ROLLING STABILITY EVALUATION
(per U.S. Navy DDS079-1)

| | Available | Required | |
|-----------------------|---------------|---------------------|---------------|
| Wind Heeling Arm Lw | 1.12 ft | | |
| Maximum Righting Arm | 4.59 ft | 1.87 ft | |
| Capsizing Area A2 | 27.9 ft-deg | | |
| Righting Area A1 | 116.7 ft-deg | 39.1 ft-deg | |
| <hr/> | | | |
| Wind Pressure Factor= | 0.0035 | Displacement | = 8,660 LTons |
| Wind Pressure = | 0.0156 LT/ft2 | GMT (corrected) | = 4.96 ft |
| Wind Velocity = | 100 knots | Mean Draft | = 20.95 ft |
| Projected Sail Area = | 20763.0 ft2 | Roll Angle | = 25.0 deg |
| Vertical Arm = | 41.97 ft ABL | | |
| Heeling Arm at 0 deg= | 1.18 ft | Angle at Intercept= | 60.0 deg |
| Wind Heel Arm Lw = | 1.12 ft | Maximum GZ | = 4.59 ft |
| Wind Heel Angle = | 13.0 deg | Angle at Max. GZ | = 56.3 deg |

Modified

BEAM WIND with ROLLING STABILITY EVALUATION
(per U.S. Navy DDS079-1)

| | Available | Required | |
|-----------------------|---------------|---------------------|---------------|
| Wind Heeling Arm Lw | 1.08 ft | | |
| Maximum Righting Arm | 4.39 ft | 1.80 ft | |
| Capsizing Area A2 | 26.6 ft-deg | | |
| Righting Area A1 | 112.6 ft-deg | 37.2 ft-deg | |
| <hr/> | | | |
| Wind Pressure Factor= | 0.0035 | Displacement | = 8,897 LTons |
| Wind Pressure = | 0.0156 LT/ft2 | GMT (corrected) | = 4.68 ft |
| Wind Velocity = | 100 knots | Mean Draft | = 21.18 ft |
| Projected Sail Area = | 20640.0 ft2 | Roll Angle | = 25.0 deg |
| Vertical Arm = | 42.10 ft ABL | | |
| Heeling Arm at 0 deg= | 1.14 ft | Angle at Intercept= | 60.0 deg |
| Wind Heel Arm Lw = | 1.08 ft | Maximum GZ | = 4.39 ft |
| Wind Heel Angle = | 13.2 deg | Angle at Max. GZ | = 54.7 deg |

Unmodified

CROWDING of PERSONNEL TO ONE SIDE
(per U.S. Navy DDS079-1)
Available Required

| | | |
|-----------------------|--------------|-------------|
| Angle of Heel | 0.9 deg | 15.0 deg |
| Heeling Arm Lc | 0.08 ft | |
| Maximum Righting Arm | 4.59 ft | 0.13 ft |
| Total Righting Area | 158.9 ft-deg | |
| Reserve Righting Area | 155.2 ft-deg | 63.6 ft-deg |

| | | | |
|-----------------------|-------------|---------------------|-------------|
| Weight of Personnel = | 31 LTons | Displacement = | 8,660 Ltoms |
| TCG of Personnel = | 21.00 ft-CL | GMT (corrected) = | 4.96 ft |
| Heeling Arm at 0 deg= | 0.08 ft | | |
| Angle at Max. GZ = | 56.3 deg | Positive GZ Range = | 60.0 deg |
| Angle at Intercept = | 60.0 deg | | |

Modified

CROWDING of PERSONNEL TO ONE SIDE
(per U.S. Navy DDS079-1)
Available Required

| | | |
|-----------------------|--------------|-------------|
| Angle of Heel | 0.9 deg | 15.0 deg |
| Heeling Arm Lc | 0.07 ft | |
| Maximum Righting Arm | 4.39 ft | 0.12 ft |
| Total Righting Area | 153.2 ft-deg | |
| Reserve Righting Area | 149.6 ft-deg | 61.3 ft-deg |

| | | | |
|--------------------------|-------------|---------------------|----------|
| Weight of Personnel = | 31 LTons | Displacement = | 8,897 |
| LTons TCG of Personnel = | 21.00 ft-CL | GMT (corrected) = | 4.68 |
| ft Heeling Arm at 0 deg= | 0.07 ft | | |
| Angle at Max. GZ = | 54.7 deg | Positive GZ Range = | 60.0 deg |
| Angle at Intercept= | 60.0 deg | | |

Unmodified

EFFECT on STABILITY of HIGH SPEED TURNING
(per U.S. Navy DDS079-1)
Available Required

| | | | | |
|-----------------------|--------------|---------------------|-------------|--|
| Angle of Heel | 9.3 deg | 15.0 deg | | |
| Heeling Arm Lc | 0.80 ft | | | |
| Maximum Righting Arm | 4.59 ft | 1.33 ft | | |
| Total Righting Area | 158.9 ft-deg | | | |
| Reserve Righting Area | 122.7 ft-deg | 63.6 ft-deg | | |
| Ship Speed in Turn = | 30.0 knots | Displacement = | 8,660 LTons | |
| Turn Circle Radius = | 1122 ft | VCG = | 21.83 ft | |
| Heeling Arm at 0 deg= | 0.81 ft | Mean Draft = | 20.95 ft | |
| Angle at Max. GZ = | 56.3 deg | Positive GZ Range = | 60.0 deg | |
| Angle at Intercept = | 60.0 deg | | | |

Modified

EFFECT on STABILITY of HIGH SPEED TURNING
(per U.S. Navy DDS079-1)
Available Required

| | | | | |
|-----------------------|--------------|---------------------|-------------|--|
| Angle of Heel | 9.9 deg | 15.0 deg | | |
| Heeling Arm Lc | 0.80 ft | | | |
| Maximum Righting Arm | 4.39 ft | 1.33 ft | | |
| Total Righting Area | 153.2 ft-deg | | | |
| Reserve Righting Area | 116.9 ft-deg | 61.3 ft-deg | | |
| Ship Speed in Turn = | 30.0 knots | Displacement = | 8,897 LTons | |
| Turn Circle Radius = | 1122 ft | VCG = | 22.04 ft | |
| Heeling Arm at 0 deg= | 0.81 ft | Mean Draft = | 21.18 ft | |
| Angle at Max. GZ = | 54.7 deg | Positive GZ Range = | 60.0 deg | |
| Angle at Intercept= | 60.0 deg | | | |

Unmodified

ICING CONDITION -- BEAM WIND/ROLL STABILITY EVALUATION
(per U.S. Navy DDS079-1)

Available

Required

| | | | |
|-----------------------|---------------|---------------------|---------------|
| Wind Heeling Arm Lw | 1.06 ft | | |
| Maximum Righting Arm | 4.08 ft | 1.77 ft | |
| Capsizing Area A2 | 24.8 ft-deg | | |
| Righting Area A1 | 102.5 ft-deg | 34.7 ft-deg | |
| Wind Pressure Factor= | 0.0035 | Displacement | = 8,922 LTons |
| Wind Pressure = | 0.0156 LT/ft2 | GMt (corrected) | = 4.29 ft |
| Projected Sail Area = | 20515.6 ft2 | Roll Angle | = 25.0 deg |
| Vertical Arm = | 42.22 ft ABL | | |
| Heeling Arm at 0 deg= | 1.13 ft | Angle at Intercept= | 60.0 deg |
| Wind Heel Arm Lw = | 1.06 ft | Maximum GZ | = 4.08 ft |
| Wind Heel Angle = | 14.1 deg | Angle at Max. GZ | = 53.7 deg |
| Weight of Ice = | 262 LTons | Ice Thickness | = 6.0 in |
| Density of Ice = | 39.500 ft3/LT | Ice Surface Area | = 20736.0 ft2 |
| KG of Ice = | 42.00 ft | | |

Modified

ICING CONDITION -- BEAM WIND/ROLL STABILITY EVALUATION
(per U.S. Navy DDS079-1)

Available

Required

| | | | |
|-----------------------|---------------|---------------------|---------------|
| Wind Heeling Arm Lw | 1.03 ft | | |
| Maximum Righting Arm | 3.91 ft | 1.72 ft | |
| Capsizing Area A2 | 23.6 ft-deg | | |
| Righting Area A1 | 98.7 ft-deg | 33.1 ft-deg | |
| Wind Pressure Factor= | 0.0035 | Displacement | = 9,159 LTons |
| Wind Pressure = | 0.0156 LT/ft2 | GMt (corrected) | = 4.04 ft |
| Projected Sail Area = | 20393.6 ft2 | Roll Angle | = 25.0 deg |
| Vertical Arm = | 42.35 ft ABL | | |
| Heeling Arm at 0 deg= | 1.10 ft | Angle at Intercept= | 60.0 deg |
| Wind Heel Arm Lw = | 1.03 ft | Maximum GZ | = 3.91 ft |
| Wind Heel Angle = | 14.4 deg | Angle at Max. GZ | = 52.7 deg |
| Weight of Ice = | 262 LTons | Ice Thickness | = 6.0 in |
| Density of Ice = | 39.500 ft3/LT | Ice Surface Area | = 20736.0 ft2 |
| KG of Ice = | 42.00 ft | | |

Damaged Stability, Flooding to Frame 94

Unmodified

DAMAGED STABILITY DRAFT/GZ SUMMARY --

| HEEL degrees | RIGHTING ARM ft | DRAFT AFT ft | DRAFT FWD ft | FLOODED WATER LTons |
|-----------------|--------------------|-----------------|-----------------|------------------------|
| 0.0 | 0.00 | 18.65 | 26.82 | 667 |
| 10.0S | 0.87 | 18.47 | 26.89 | 670 |
| 20.0S | 1.77 | 17.83 | 27.12 | 679 |
| 30.0S | 2.79 | 16.58 | 27.34 | 689 |
| 45.0S | 4.37 | 12.87 | 27.42 | 720 |
| 60.0S | 4.40 | 5.49 | 29.73 | 893 |
| 70.0S | 3.83 | -4.28 | 33.72 | 1,045 |
| 80.0S | 2.91 | -34.04 | 47.70 | 1,232 |

At Equilibrium:

Static Heel Angle 0.0 deg
 Draft at A.P. 18.65 ft
 Draft at F.P. 26.82 ft
 Flooded Water 667 LTons
 Disp. of Remaining Intact Hull 8,677 Ltons

Modified

DAMAGED STABILITY DRAFT/GZ SUMMARY --

| HEEL degrees | RIGHTING ARM ft | DRAFT AFT ft | DRAFT FWD ft | FLOODED WATER LTons |
|-----------------|--------------------|-----------------|-----------------|------------------------|
| 0.0 | 0.00 | 19.90 | 25.93 | 643 |
| 10.0S | 0.84 | 19.79 | 25.95 | 645 |
| 20.0S | 1.73 | 19.29 | 26.08 | 650 |
| 30.0S | 2.74 | 18.19 | 26.22 | 658 |
| 45.0S | 4.28 | 15.03 | 25.96 | 673 |
| 60.0S | 4.23 | 9.11 | 27.32 | 817 |
| 70.0S | 3.58 | 0.91 | 30.30 | 958 |
| 80.0S | 2.69 | -22.01 | 39.48 | 1,120 |

At Equilibrium:

Static Heel Angle 0.0 deg
 Draft at A.P. 19.90 ft
 Draft at F.P. 25.93 ft
 Flooded Water 643 LTons
 Disp. of Remaining Intact Hull 8,914 Ltons

Damaged Stability, Flooding from Frame 28 to 138

Unmodified

DAMAGED STABILITY DRAFT/GZ SUMMARY --

| HEEL degrees | RIGHTING ARM ft | DRAFT AFT ft | DRAFT FWD ft | FLOODED WATER LTons |
|-----------------|--------------------|-----------------|-----------------|------------------------|
| 0.0 | 0.00 | 16.72 | 32.23 | 1,601 |
| 10.0S | 0.87 | 16.42 | 32.43 | 1,616 |
| 20.0S | 1.81 | 15.62 | 32.85 | 1,653 |
| 30.0S | 2.90 | 14.20 | 33.33 | 1,717 |
| 45.0S | 4.18 | 9.66 | 35.65 | 1,925 |
| 60.0S | 4.17 | 1.51 | 40.65 | 2,076 |
| 70.0S | 3.66 | -8.86 | 47.48 | 2,129 |
| 80.0S | 2.79 | -40.66 | 70.18 | 2,187 |

At Equilibrium:

Static Heel Angle 0.0 deg
 Draft at A.P. 16.72 ft
 Draft at F.P. 32.23 ft
 Flooded Water 1601 LTons
 Disp. of Remaining Intact Hull 8,741 Lttons

Modified

DAMAGED STABILITY DRAFT/GZ SUMMARY --

| HEEL degrees | RIGHTING ARM ft | DRAFT AFT ft | DRAFT FWD ft | FLOODED WATER LTons |
|-----------------|--------------------|-----------------|-----------------|------------------------|
| 0.0 | 0.00 | 18.07 | 31.17 | 1,552 |
| 10.0S | 0.86 | 17.85 | 31.30 | 1,562 |
| 20.0S | 1.77 | 17.19 | 31.63 | 1,593 |
| 30.0S | 2.86 | 15.93 | 32.01 | 1,646 |
| 45.0S | 4.10 | 11.85 | 34.07 | 1,852 |
| 60.0S | 3.96 | 4.93 | 38.49 | 2,014 |
| 70.0S | 3.40 | -3.56 | 44.10 | 2,062 |
| 80.0S | 2.55 | -28.63 | 61.87 | 2,096 |

At Equilibrium:

Static Heel Angle 0.0 deg
 Draft at A.P. 18.07 ft
 Draft at F.P. 31.17 ft
 Flooded Water 1552 LTons
 Disp. of Remaining Intact Hull 8,773 Lttons

Damaged Stability, Flooding from Frame 58 to 174

Unmodified

DAMAGED STABILITY DRAFT/GZ SUMMARY --

| HEEL degrees | RIGHTING ARM ft | DRAFT AFT ft | DRAFT FWD ft | FLOODED WATER LTons |
|-----------------|--------------------|-----------------|-----------------|------------------------|
| 0.0 | 0.00 | 16.22 | 35.03 | 2,466 |
| 10.0S | 0.84 | 15.93 | 35.24 | 2,487 |
| 20.0S | 1.75 | 15.14 | 35.69 | 2,545 |
| 30.0S | 2.80 | 13.75 | 36.24 | 2,644 |
| 45.0S | 4.05 | 9.77 | 38.11 | 2,725 |
| 60.0S | 4.04 | 2.77 | 42.19 | 2,719 |
| 70.0S | 3.51 | -6.11 | 48.00 | 2,673 |
| 80.0S | 2.63 | -32.95 | 66.64 | 2,612 |

At Equilibrium:

Static Heel Angle 0.0 deg
 Draft at A.P. 16.22 ft
 Draft at F.P. 35.03 ft
 Flooded Water 2466 LTons
 Disp. of Remaining Intact Hull 8,291 Lttons

Modified

DAMAGED STABILITY DRAFT/GZ SUMMARY --

| HEEL degrees | RIGHTING ARM ft | DRAFT AFT ft | DRAFT FWD ft | FLOODED WATER LTons |
|-----------------|--------------------|-----------------|-----------------|------------------------|
| 0.0 | 0.00 | 17.56 | 34.02 | 2,414 |
| 10.0S | 0.82 | 17.33 | 34.18 | 2,432 |
| 20.0S | 1.71 | 16.66 | 34.55 | 2,483 |
| 30.0S | 2.74 | 15.40 | 35.05 | 2,579 |
| 45.0S | 3.92 | 11.80 | 36.82 | 2,680 |
| 60.0S | 3.79 | 6.04 | 40.30 | 2,676 |
| 70.0S | 3.18 | -1.38 | 45.23 | 2,628 |
| 80.0S | 2.35 | -21.88 | 59.95 | 2,550 |

At Equilibrium:

Static Heel Angle 0.0 deg
 Draft at A.P. 17.56 ft
 Draft at F.P. 34.02 ft
 Flooded Water 2414 LTons
 Disp. of Remaining Intact Hull 8,528 Lttons

Damaged Stability, Flooding from Frame 94 to 220

Unmodified

DAMAGED STABILITY DRAFT/GZ SUMMARY --

| HEEL degrees | RIGHTING ARM ft | DRAFT AFT ft | DRAFT FWD ft | FLOODED WATER LTons |
|-----------------|--------------------|-----------------|-----------------|------------------------|
| 0.0 | 0.00 | 16.55 | 39.10 | 3,810 |
| 10.0S | 0.88 | 16.32 | 39.20 | 3,828 |
| 20.0S | 1.84 | 15.74 | 39.36 | 3,876 |
| 30.0S | 2.96 | 14.70 | 39.47 | 3,877 |
| 45.0S | 4.18 | 11.53 | 40.98 | 3,769 |
| 60.0S | 4.09 | 6.23 | 44.83 | 3,607 |
| 70.0S | 3.50 | -0.79 | 50.77 | 3,473 |
| 80.0S | 2.72 | -20.52 | 69.34 | 3,330 |

At Equilibrium:

Static Heel Angle 0.0 deg
 Draft at A.P. 16.55 ft
 Draft at F.P. 39.10 ft
 Flooded Water 3810 LTons
 Disp. of Remaining Intact Hull 8,741 Lttons

Modified

DAMAGED STABILITY DRAFT/GZ SUMMARY --

| HEEL degrees | RIGHTING ARM ft | DRAFT AFT ft | DRAFT FWD ft | FLOODED WATER LTons |
|-----------------|--------------------|-----------------|-----------------|------------------------|
| 0.0 | 0.00 | 17.76 | 38.35 | 3,787 |
| 10.0S | 0.86 | 17.58 | 38.43 | 3,804 |
| 20.0S | 1.78 | 17.08 | 38.56 | 3,851 |
| 30.0S | 2.88 | 16.15 | 38.64 | 3,858 |
| 45.0S | 4.01 | 13.47 | 39.95 | 3,757 |
| 60.0S | 3.82 | 9.43 | 43.18 | 3,595 |
| 70.0S | 3.21 | 4.21 | 48.24 | 3,460 |
| 80.0S | 2.43 | -9.93 | 63.90 | 3,314 |

At Equilibrium:

Static Heel Angle 0.0 deg
 Draft at A.P. 17.76 ft
 Draft at F.P. 38.35 ft
 Flooded Water 3787 LTons
 Disp. of Remaining Intact Hull 8,488 Lttons

Damaged Stability, Flooding from Frame 138 to 260

Unmodified

DAMAGED STABILITY DRAFT/GZ SUMMARY --

| HEEL degrees | RIGHTING ARM ft | DRAFT AFT ft | DRAFT FWD ft | FLOODED WATER LTons |
|-----------------|--------------------|-----------------|-----------------|------------------------|
| 0.0 | 0.00 | 19.18 | 37.37 | 4,215 |
| 10.0S | 0.88 | 19.09 | 37.34 | 4,217 |
| 20.0S | 1.84 | 18.74 | 37.23 | 4,219 |
| 30.0S | 2.95 | 17.97 | 37.00 | 4,180 |
| 45.0S | 4.03 | 15.88 | 37.47 | 3,984 |
| 60.0S | 3.83 | 12.95 | 39.33 | 3,751 |
| 70.0S | 3.30 | 9.18 | 42.75 | 3,599 |
| 80.0S | 2.64 | -1.45 | 54.52 | 3,464 |

At Equilibrium:

Static Heel Angle 0.0 deg
 Draft at A.P. 19.18 ft
 Draft at F.P. 37.37 ft
 Flooded Water 4215 LTons
 Disp. of Remaining Intact Hull 8,290 Ltons

Modified

DAMAGED STABILITY DRAFT/GZ SUMMARY --

| HEEL degrees | RIGHTING ARM ft | DRAFT AFT ft | DRAFT FWD ft | FLOODED WATER LTons |
|-----------------|--------------------|-----------------|-----------------|------------------------|
| 0.0 | 0.00 | 20.29 | 36.83 | 4,231 |
| 10.0S | 0.85 | 20.24 | 36.78 | 4,232 |
| 20.0S | 1.78 | 19.97 | 36.63 | 4,236 |
| 30.0S | 2.87 | 19.33 | 36.36 | 4,198 |
| 45.0S | 3.84 | 17.83 | 36.62 | 4,009 |
| 60.0S | 3.56 | 16.11 | 38.11 | 3,784 |
| 70.0S | 3.01 | 14.05 | 40.96 | 3,636 |
| 80.0S | 2.34 | 8.15 | 51.12 | 3,502 |

At Equilibrium:

Static Heel Angle 0.0 deg
 Draft at A.P. 20.29 ft
 Draft at F.P. 36.83 ft
 Flooded Water 4231 LTons
 Disp. of Remaining Intact Hull 8,527 Ltons

Damaged Stability, Flooding from Frame 174 to 300

Unmodified

DAMAGED STABILITY DRAFT/GZ SUMMARY --

| HEEL degrees | RIGHTING ARM ft | DRAFT AFT ft | DRAFT FWD ft | FLOODED WATER LTons |
|-----------------|--------------------|-----------------|-----------------|------------------------|
| 0.0 | 0.00 | 21.83 | 35.56 | 4,700 |
| 10.0S | 0.84 | 21.80 | 35.47 | 4,694 |
| 20.0S | 1.78 | 21.61 | 35.21 | 4,669 |
| 30.0S | 2.83 | 21.10 | 34.77 | 4,603 |
| 45.0S | 3.68 | 20.12 | 34.60 | 4,371 |
| 60.0S | 3.43 | 19.30 | 35.53 | 4,134 |
| 70.0S | 2.98 | 18.47 | 37.77 | 3,997 |
| 80.0S | 2.45 | 16.19 | 45.94 | 3,881 |

At Equilibrium:

Static Heel Angle 0.0 deg
 Draft at A.P. 21.83 ft
 Draft at F.P. 35.56 ft
 Flooded Water 4700 LTons
 Disp. of Remaining Intact Hull 8,256 Ltons

Modified

DAMAGED STABILITY DRAFT/GZ SUMMARY --

| HEEL degrees | RIGHTING ARM ft | DRAFT AFT ft | DRAFT FWD ft | FLOODED WATER LTons |
|-----------------|--------------------|-----------------|-----------------|------------------------|
| 0.0 | 0.00 | 22.96 | 35.09 | 4,748 |
| 10.0S | 0.80 | 22.94 | 35.00 | 4,743 |
| 20.0S | 1.72 | 22.80 | 34.72 | 4,720 |
| 30.0S | 2.74 | 22.48 | 34.21 | 4,657 |
| 45.0S | 3.46 | 22.20 | 33.83 | 4,435 |
| 60.0S | 3.16 | 22.71 | 34.39 | 4,207 |
| 70.0S | 2.70 | 23.74 | 36.12 | 4,074 |
| 80.0S | 2.17 | 26.93 | 42.55 | 3,958 |

At Equilibrium:

Static Heel Angle 0.0 deg
 Draft at A.P. 22.96 ft
 Draft at F.P. 35.09 ft
 Flooded Water 4748 LTons
 Disp. of Remaining Intact Hull 8,493 Ltons

Damaged Stability, Flooding from Frame 220 to 346

Unmodified

DAMAGED STABILITY DRAFT/GZ SUMMARY --

| HEEL degrees | RIGHTING ARM ft | DRAFT AFT ft | DRAFT FWD ft | FLOODED WATER LTons |
|-----------------|--------------------|-----------------|-----------------|------------------------|
| 0.0 | 0.00 | 25.70 | 30.58 | 4,726 |
| 10.0S | 0.72 | 25.68 | 30.50 | 4,718 |
| 20.0S | 1.57 | 25.60 | 30.23 | 4,690 |
| 30.0S | 2.49 | 25.64 | 29.53 | 4,644 |
| 45.0S | 3.16 | 26.41 | 28.39 | 4,480 |
| 60.0S | 2.97 | 28.84 | 27.48 | 4,312 |
| 70.0S | 2.62 | 32.57 | 27.11 | 4,221 |
| 80.0S | 2.23 | 43.64 | 27.25 | 4,146 |

At Equilibrium:

Static Heel Angle 0.0 deg
 Draft at A.P. 25.70 ft
 Draft at F.P. 30.58 ft
 Flooded Water 4726 LTons
 Disp. of Remaining Intact Hull 8,741 Lttons

Modified

DAMAGED STABILITY DRAFT/GZ SUMMARY --

| HEEL degrees | RIGHTING ARM ft | DRAFT AFT ft | DRAFT FWD ft | FLOODED WATER LTons |
|-----------------|--------------------|-----------------|-----------------|------------------------|
| 0.0 | 0.00 | 26.92 | 30.12 | 4,812 |
| 10.0S | 0.70 | 26.90 | 30.03 | 4,804 |
| 20.0S | 1.50 | 26.90 | 29.72 | 4,781 |
| 30.0S | 2.37 | 27.20 | 28.91 | 4,745 |
| 45.0S | 2.91 | 28.81 | 27.55 | 4,594 |
| 60.0S | 2.68 | 32.75 | 26.24 | 4,435 |
| 70.0S | 2.34 | 38.59 | 25.33 | 4,348 |
| 80.0S | 1.98 | 55.70 | 24.04 | 4,275 |

At Equilibrium:

Static Heel Angle 0.0 deg
 Draft at A.P. 26.92 ft
 Draft at F.P. 30.12 ft
 Flooded Water 4812 LTons
 Disp. of Remaining Intact Hull 8,482 Lttons

Damaged Stability, Flooding from Frame 260 to 382

Unmodified

DAMAGED STABILITY DRAFT/GZ SUMMARY --

| HEEL degrees | RIGHTING ARM ft | DRAFT AFT ft | DRAFT FWD ft | FLOODED WATER LTons |
|-----------------|--------------------|-----------------|-----------------|------------------------|
| 0.0 | 0.00 | 27.81 | 25.80 | 4,292 |
| 10.0S | 0.59 | 27.78 | 25.74 | 4,285 |
| 20.0S | 1.27 | 27.82 | 25.47 | 4,273 |
| 30.0S | 2.02 | 28.22 | 24.70 | 4,279 |
| 45.0S | 2.70 | 29.96 | 22.85 | 4,213 |
| 60.0S | 2.56 | 34.14 | 20.44 | 4,127 |
| 70.0S | 2.26 | 40.38 | 17.67 | 4,079 |
| 80.0S | 1.95 | 58.32 | 11.29 | 4,040 |

At Equilibrium:

Static Heel Angle 0.0 deg
 Draft at A.P. 27.81 ft
 Draft at F.P. 25.80 ft
 Flooded Water 4292 LTons
 Disp. of Remaining Intact Hull 8,741 Lttons

Modified

DAMAGED STABILITY DRAFT/GZ SUMMARY --

| HEEL degrees | RIGHTING ARM ft | DRAFT AFT ft | DRAFT FWD ft | FLOODED WATER LTons |
|-----------------|--------------------|-----------------|-----------------|------------------------|
| 0.0 | 0.00 | 29.16 | 25.26 | 4,407 |
| 10.0S | 0.58 | 29.13 | 25.20 | 4,400 |
| 20.0S | 1.17 | 29.36 | 24.84 | 4,403 |
| 30.0S | 1.88 | 30.05 | 23.94 | 4,425 |
| 45.0S | 2.44 | 32.74 | 21.80 | 4,369 |
| 60.0S | 2.27 | 38.64 | 18.91 | 4,291 |
| 70.0S | 1.98 | 47.28 | 15.51 | 4,245 |
| 80.0S | 1.71 | 72.12 | 7.33 | 4,208 |

At Equilibrium:

Static Heel Angle 0.0 deg
 Draft at A.P. 29.16 ft
 Draft at F.P. 25.26 ft
 Flooded Water 4407 LTons
 Disp. of Remaining Intact Hull 8,377 Lttons

Damaged Stability, Flooding from Frame 300 to 426

Unmodified

DAMAGED STABILITY DRAFT/GZ SUMMARY --

| HEEL degrees | RIGHTING ARM ft | DRAFT AFT ft | DRAFT FWD ft | FLOODED WATER LTons |
|-----------------|--------------------|-----------------|-----------------|------------------------|
| 0.0 | 0.00 | 28.01 | 22.00 | 3,419 |
| 10.0S | 0.46 | 27.98 | 21.96 | 3,416 |
| 20.0S | 1.01 | 28.02 | 21.72 | 3,417 |
| 30.0S | 1.64 | 28.53 | 20.95 | 3,468 |
| 45.0S | 2.42 | 30.31 | 18.67 | 3,499 |
| 60.0S | 2.31 | 34.57 | 15.14 | 3,497 |
| 70.0S | 2.00 | 40.96 | 10.63 | 3,497 |
| 80.0S | 1.67 | 59.38 | -1.23 | 3,495 |

At Equilibrium:

Static Heel Angle 0.0 deg
 Draft at A.P. 28.01 ft
 Draft at F.P. 22.00 ft
 Flooded Water 3419 LTons
 Disp. of Remaining Intact Hull 8,061 Lttons

Modified

DAMAGED STABILITY DRAFT/GZ SUMMARY --

| HEEL degrees | RIGHTING ARM ft | DRAFT AFT ft | DRAFT FWD ft | FLOODED WATER LTons |
|-----------------|--------------------|-----------------|-----------------|------------------------|
| 0.0 | 0.00 | 29.55 | 21.30 | 3,564 |
| 10.0S | 0.45 | 29.52 | 21.26 | 3,561 |
| 20.0S | 0.91 | 29.82 | 20.89 | 3,584 |
| 30.0S | 1.49 | 30.70 | 19.93 | 3,659 |
| 45.0S | 2.15 | 33.56 | 17.26 | 3,696 |
| 60.0S | 2.02 | 39.82 | 13.09 | 3,698 |
| 70.0S | 1.73 | 48.89 | 7.84 | 3,696 |
| 80.0S | 1.42 | 75.36 | -6.62 | 3,695 |

At Equilibrium:

Static Heel Angle 0.0 deg
 Draft at A.P. 29.55 ft
 Draft at F.P. 21.30 ft
 Flooded Water 3564 LTons
 Disp. of Remaining Intact Hull 8,298 Lttons

Damaged Stability, Flooding from Frame 346 to 464

Unmodified

DAMAGED STABILITY DRAFT/GZ SUMMARY --

| HEEL degrees | RIGHTING ARM ft | DRAFT AFT ft | DRAFT FWD ft | FLOODED WATER LTons |
|-----------------|--------------------|-----------------|-----------------|------------------------|
| 0.0 | 0.00 | 25.53 | 20.07 | 2,095 |
| 10.0S | 0.38 | 25.50 | 20.03 | 2,095 |
| 20.0S | 0.90 | 25.35 | 19.90 | 2,093 |
| 30.0S | 1.53 | 25.15 | 19.50 | 2,105 |
| 45.0S | 2.50 | 24.90 | 17.66 | 2,152 |
| 60.0S | 2.48 | 25.67 | 14.14 | 2,194 |
| 70.0S | 2.12 | 27.20 | 9.53 | 2,220 |
| 80.0S | 1.69 | 31.96 | -3.25 | 2,245 |

At Equilibrium:

Static Heel Angle 0.0 deg
 Draft at A.P. 25.53 ft
 Draft at F.P. 20.07 ft
 Flooded Water 2095 LTons
 Disp. of Remaining Intact Hull 7,961 Lttons

Modified

DAMAGED STABILITY DRAFT/GZ SUMMARY --

| HEEL degrees | RIGHTING ARM ft | DRAFT AFT ft | DRAFT FWD ft | FLOODED WATER LTons |
|-----------------|--------------------|-----------------|-----------------|------------------------|
| 0.0 | 0.00 | 27.23 | 19.17 | 2,247 |
| 10.0S | 0.36 | 27.21 | 19.12 | 2,247 |
| 20.0S | 0.85 | 27.16 | 18.95 | 2,248 |
| 30.0S | 1.43 | 27.41 | 18.28 | 2,286 |
| 45.0S | 2.31 | 28.26 | 15.99 | 2,338 |
| 60.0S | 2.22 | 31.03 | 11.77 | 2,376 |
| 70.0S | 1.87 | 35.23 | 6.33 | 2,397 |
| 80.0S | 1.42 | 48.17 | -9.54 | 2,422 |

At Equilibrium:

Static Heel Angle 0.0 deg
 Draft at A.P. 27.23 ft
 Draft at F.P. 19.17 ft
 Flooded Water 2247 LTons
 Disp. of Remaining Intact Hull 8,198 Lttons

Damaged Stability, Flooding from Frame 382 to 506

Unmodified

DAMAGED STABILITY DRAFT/GZ SUMMARY --

| HEEL degrees | RIGHTING ARM ft | DRAFT AFT ft | DRAFT FWD ft | FLOODED WATER LTons |
|-----------------|--------------------|-----------------|-----------------|------------------------|
| 0.0 | 0.00 | 26.29 | 18.48 | 1,814 |
| 10.0S | 0.36 | 26.28 | 18.43 | 1,816 |
| 20.0S | 0.87 | 26.17 | 18.28 | 1,819 |
| 30.0S | 1.56 | 25.96 | 17.86 | 1,809 |
| 45.0S | 2.71 | 25.48 | 16.05 | 1,804 |
| 60.0S | 2.79 | 26.17 | 12.13 | 1,831 |
| 70.0S | 2.48 | 27.60 | 6.98 | 1,851 |
| 80.0S | 2.03 | 32.66 | -8.22 | 1,877 |

At Equilibrium:

Static Heel Angle 0.0 deg
 Draft at A.P. 26.29 ft
 Draft at F.P. 18.48 ft
 Flooded Water 1814 LTons
 Disp. of Remaining Intact Hull 8,105 Lttons

Modified

DAMAGED STABILITY DRAFT/GZ SUMMARY --

| HEEL degrees | RIGHTING ARM ft | DRAFT AFT ft | DRAFT FWD ft | FLOODED WATER LTons |
|-----------------|--------------------|-----------------|-----------------|------------------------|
| 0.0 | 0.00 | 28.47 | 17.19 | 2,041 |
| 10.0S | 0.34 | 28.46 | 17.14 | 2,043 |
| 20.0S | 0.83 | 28.43 | 16.95 | 2,034 |
| 30.0S | 1.49 | 28.61 | 16.29 | 2,027 |
| 45.0S | 2.53 | 29.25 | 13.99 | 2,010 |
| 60.0S | 2.55 | 32.06 | 9.30 | 2,025 |
| 70.0S | 2.23 | 36.38 | 3.13 | 2,038 |
| 80.0S | 1.76 | 50.35 | -15.76 | 2,062 |

At Equilibrium:

Static Heel Angle 0.0 deg
 Draft at A.P. 28.47 ft
 Draft at F.P. 17.19 ft
 Flooded Water 2041 LTons
 Disp. of Remaining Intact Hull 8,342 Lttons

Damaged Stability, Flooding from Frame 426 aft

Unmodified

| DAMAGED STABILITY DRAFT/GZ SUMMARY | | | | |
|------------------------------------|--------------|-----------|-----------|---------------|
| HEEL | RIGHTING ARM | DRAFT AFT | DRAFT FWD | FLOODED WATER |
| degrees | ft | ft | ft | Ltons |
| 0.0 | 0.00 | 25.54 | 18.35 | 1,145 |
| 10.0S | 0.49 | 25.52 | 18.29 | 1,148 |
| 20.0S | 1.11 | 25.42 | 18.13 | 1,157 |
| 30.0S | 1.95 | 24.97 | 17.85 | 1,134 |
| 45.0S | 3.32 | 23.67 | 16.37 | 1,096 |
| 60.0S | 3.52 | 22.90 | 12.80 | 1,101 |
| 70.0S | 3.22 | 22.35 | 8.01 | 1,110 |
| 80.0S | 2.75 | 21.56 | -6.05 | 1,124 |

At Equilibrium:

Static Heel Angle 0.0 deg
 Draft at A.P. 25.54 ft
 Draft at F.P. 18.35 ft
 Flooded Water 1145 Ltons
 Disp. of Remaining Intact Hull 8,463 Ltons

Modified

| DAMAGED STABILITY DRAFT/GZ SUMMARY | | | | |
|------------------------------------|--------------|-----------|-----------|---------------|
| HEEL | RIGHTING ARM | DRAFT AFT | DRAFT FWD | FLOODED WATER |
| degrees | ft | ft | ft | Ltons |
| 0.0 | 0.00 | 27.80 | 16.89 | 1,357 |
| 10.0S | 0.46 | 27.79 | 16.83 | 1,360 |
| 20.0S | 1.08 | 27.66 | 16.70 | 1,345 |
| 30.0S | 1.90 | 27.45 | 16.28 | 1,297 |
| 45.0S | 3.17 | 27.07 | 14.41 | 1,238 |
| 60.0S | 3.30 | 28.17 | 10.12 | 1,233 |
| 70.0S | 2.98 | 30.15 | 4.42 | 1,236 |
| 80.0S | 2.49 | 37.27 | -13.03 | 1,247 |

At Equilibrium:

Static Heel Angle 0.0 deg
 Draft at A.P. 27.80 ft
 Draft at F.P. 16.89 ft
 Flooded Water 1357 Ltons
 Disp. of Remaining Intact Hull 8,700 Ltons

APPENDIX G – PERMEABILITY

AGS MAGAZINE PERMEABILITY CALCULATION

| Space Volumes (ft ³) | | Ammo Pallet Volumes (116.7ft ³ each) | | Equipment Volumes | |
|--|--------|---|----------------|-------------------|----------------|
| Space | Volume | Number | Volume | Equipment Weight | Equipment Vol. |
| 1-426-0 | 7106 | 6 | 700.2 | 129.54 | 1679.22 |
| 2-426-0 | 7340 | 8 | 933.6 | | |
| 2-464-0 | 7749 | 12 | 1400.4 | | |
| 3-464-0 | 8208 | 12 | 1400.4 | | |
| Total Compartment Volume | | | 30403 | | |
| Total Ammo & Equipment Volume | | | 6113.82 | | |
| Total Magazine Permeability | | | 0.80 | | |

APPENDIX H -- SEAKEEPING

Spreadsheet for computation of significant motions of Baseline USS Thorn based on SWAN output.

$h_{1/3} = 3$ m
 $\mu = 150$ deg

U = 7.73 m/s

Distance from LCF (positive)= 43.54 m

| T (sec) | w_w (rad/sec) | P.M. | | RAO M3 (m/m) | RAO M5 (deg/m) | $S_z(w_e)$ (m ² -sec) | $S_\theta(w_e)$ (deg ² -sec) | w_w Diff (rad/sec) | Trap | Trap | RAO VM (m/m) | $S_{vm}(w_e)$ (m ² -sec) | Trap | | |
|------------|--------------------|-------------------------------------|-------------------------------------|-----------------|-------------------|-------------------------------------|--|-------------------------|-----------------------|----------------------------|-----------------|--|------------------------------|-------------|--------|
| | | $S_z(w_w)$ (m ² -sec) | $S_z(w_e)$ (m ² -sec) | | | | | | Product $S_z(w_e)$ | Product $S_\theta(w_e)$ | | | Product $w^2 S_{vm}(w_e)$ | | |
| 3 | 2.0944 | 0.0190 | 0.004921 | 0.0040 | 0.0030 | 0.0000 | 0.0000 | | | | 0.00628 | 1.94E-07 | | | |
| 5 | 1.2566 | 0.2167 | 0.079816 | 0.0170 | 0.0130 | 0.0000 | 0.0000 | 0.8378 | 0.0000 | 0.0000 | 0.026879 | 5.77E-05 | 0.0000 | | |
| 7 | 0.8976 | 0.7895 | 0.354769 | 0.1760 | 0.1070 | 0.0110 | 0.0041 | 0.3590 | 0.0020 | 0.0007 | 0.257311 | 0.023489 | 0.0034 | | |
| 9 | 0.6981 | 1.1135 | 0.5701 | 0.2350 | 0.0560 | 0.0315 | 0.0018 | 0.1995 | 0.0042 | 0.0006 | 0.277555 | 0.043919 | 0.0033 | | |
| 11 | 0.5712 | 0.5158 | 0.289811 | 0.5980 | 0.3430 | 0.1036 | 0.0341 | 0.1269 | 0.0086 | 0.0023 | 0.858651 | 0.213672 | 0.0053 | | |
| | | | | | | | | | $m_0 =$ | 0.0062 | 0.0013 | | | $m_0 =$ | 0.0067 |
| | | | | | | | | | $z(1/3) =$ | 0.16 | m | | | $vm(1/3) =$ | 0.16 |
| | | | | | | | | | $\theta(1/3) =$ | 0.07 | deg | | | | 0.54 |

U = 7.73 m/s

| T (sec) | w_w (rad/sec) | P.M. | | RAO M4 (deg/m) | $S_\theta(w_e)$ (deg ² -sec) | w_w Diff (rad/sec) | Trap |
|------------|--------------------|-------------------------------------|-------------------------------------|-------------------|--|-------------------------|----------------------------|
| | | $S_z(w_w)$ (m ² -sec) | $S_z(w_e)$ (m ² -sec) | | | | Product $S_\theta(w_e)$ |
| 3 | 2.0944 | 0.0190 | 0.004921 | 0.0090 | 0.0000 | | |
| 5 | 1.2566 | 0.2167 | 0.079816 | 0.0310 | 0.0001 | 0.8378 | 0.0000 |
| 7 | 0.8976 | 0.7895 | 0.354769 | 0.2530 | 0.0227 | 0.3590 | 0.0041 |
| 9 | 0.6981 | 1.1135 | 0.5701 | 2.1120 | 2.5430 | 0.1995 | 0.2559 |
| 11 | 0.5712 | 0.5158 | 0.289811 | 7.2300 | 15.1492 | 0.1269 | 1.1229 |
| | | | | | | $m_0 =$ | 1.3829 |
| | | | | | | $\theta(1/3) =$ | 2.35 deg |

Spreadsheet for computation of significant motions of AGS modified USS Thorn based on SWAN output.

$h_{1/3} = 3$ m
 $\mu = 150$ deg

U = 7.73 m/s

Distance from LCF (positive)= 43.54 m

| T (sec) | w_w (rad/sec) | P.M. | | RAO M3 (m/m) | RAO M5 (deg/m) | $S_z(w_e)$ (m ² -sec) | $S_\theta(w_e)$ (deg ² -sec) | w_w Diff (rad/sec) | Trap | Trap | RAO VM (m/m) | $S_{vm}(w_e)$ (m ² -sec) | Trap | | |
|------------|--------------------|---------|----------|-----------------|-------------------|-------------------------------------|--|-------------------------|-----------------|--------|-----------------|--|--------|-------------|--------|
| | | Product | Product | | | | | | Product | | | | | | |
| 3 | 2.0944 | 0.0190 | 0.004921 | 0.0040 | 0.0040 | 0.0000 | 0.0000 | | | | 0.00704 | 2.44E-07 | | | |
| 5 | 1.2566 | 0.2167 | 0.079816 | 0.0170 | 0.0120 | 0.0000 | 0.0000 | 0.8378 | 0.0000 | 0.0000 | 0.026119 | 5.45E-05 | 0.0000 | | |
| 7 | 0.8976 | 0.7895 | 0.354769 | 0.1780 | 0.1040 | 0.0112 | 0.0038 | 0.3590 | 0.0020 | 0.0007 | 0.257031 | 0.023438 | 0.0034 | | |
| 9 | 0.6981 | 1.1135 | 0.5701 | 0.2280 | 0.0480 | 0.0296 | 0.0013 | 0.1995 | 0.0041 | 0.0005 | 0.264476 | 0.039877 | 0.0031 | | |
| 11 | 0.5712 | 0.5158 | 0.289811 | 0.5800 | 0.3180 | 0.0975 | 0.0293 | 0.1269 | 0.0081 | 0.0019 | 0.821653 | 0.195655 | 0.0049 | | |
| | | | | | | | | | $m_0 =$ | 0.0142 | 0.0032 | | | $m_0 =$ | 0.0114 |
| | | | | | | | | | $z(1/3) =$ | 0.24 | m | | | $vm(1/3) =$ | 0.21 |
| | | | | | | | | | $\theta(1/3) =$ | 0.11 | deg | | | | 0.70 |

U = 7.73 m/s

| T (sec) | w_w (rad/sec) | P.M. | | RAO M4 (deg/m) | $S_\theta(w_e)$ (deg ² -sec) | w_w Diff (rad/sec) | Trap |
|------------|--------------------|-------------------------------------|-------------------------------------|-------------------|--|-------------------------|----------|
| | | $S_z(w_w)$ (m ² -sec) | $S_z(w_e)$ (m ² -sec) | | | | Product |
| 3 | 2.0944 | 0.0190 | 0.004921 | 0.0090 | 0.0000 | | |
| 5 | 1.2566 | 0.2167 | 0.079816 | 0.0300 | 0.0001 | 0.8378 | 0.0000 |
| 7 | 0.8976 | 0.7895 | 0.354769 | 0.2420 | 0.0208 | 0.3590 | 0.0037 |
| 8 | 0.7854 | 1.0612 | 0.512108 | 1.9820 | 2.0117 | 0.1122 | 0.1140 |
| 9 | 0.6981 | 1.1135 | 0.5701 | 6.7330 | 25.8445 | 0.0873 | 1.2155 |
| | | | | | | $m_0 =$ | 1.3333 |
| | | | | | | $\theta(1/3) =$ | 2.31 deg |

APPENDIX I – COST ANALYSIS

| Description | Variable | Value | Units | Input/Calc/ Constant | Equation/Source |
|---------------------------------------|----------|-------|-------|-------------------------|-----------------|
| WEIGHT | | | | | |
| <u>Structure (100)</u> | | | | | |
| Total Structural Weight | WT1 | 246.8 | lton | Input | |
| <u>Propulsion (200)</u> | | | | | |
| PIBRAKE | WBM | 0.0 | HP | Input | P _i |
| Total Propulsion Plant Weight | WT2 | 0.0 | lton | Input | |
| <u>Electrical Plant (300)</u> | | | | | |
| Total Electrical Plant Weight | WT3 | 0.0 | lton | Input | |
| <u>Command and Surveillance (400)</u> | | | | | |
| Gyro/IC/Navigation (420,430) | WIC | 0.0 | lton | Input | W _{IC} |
| Total Command and Surveillance | WT4 | 0.0 | lton | Input | |
| <u>Auxiliary Systems (500)</u> | | | | | |
| Total Auxiliary Systems Weight | WT5 | 1.3 | lton | Input | |
| <u>Outfit and Furnishings (600)</u> | | | | | |
| Total Outfit and Furnishings Weight | WT6 | 0.0 | lton | Input | |
| <u>Armament (700)</u> | | | | | |
| Total Armament Weight | WT7 | 133.2 | lton | Input | |
| Future Growth Weight Margin | WM24 | 0 | lton | Input | |
| Margined Lightship Weight | WLS | 236 | lton | Input | |
| Average Deck Height | HDK | 8.5 | | Input | |
| | WF20 | 0 | | Input | |
| | WF23 | 0 | | Input | |
| | NHELO | 0 | | Input | |

| Description | Variable | Value | Units | Input/Calc/ Constant | Equation/Source |
|--|----------|------------|------------|-------------------------|--|
| VERY SIMPLIFIED COST MODEL (Lead Ship End Cost Only) | | | | | |
| <u>Additional Characteristics</u> | | | | | |
| Ship Service Life | LS | 30 | years | | |
| Initial Operational Capability | YIOC | 2005 | year | | |
| Total Ship Acquisition | NS | 1 | ships | | |
| Production Rate | RP | 1 | ships/year | | |
| <u>Inflation</u> | | | | | |
| Base Year | YB | 1999 | | | |
| Average Inflation Rate | RI | 3.00043977 | | | |
| Inflation Factor | FI | 1.703 | | | |
| <u>Lead Ship Cost - Shipbuilder Portion</u> | | | | | |
| <i>SWBS Costs: (See Table 5 for KN factors)</i> | | | | | |
| Structure | KN1 | 0.55 | | | |
| | CL1D | 2.23479197 | M\$ | | |
| Propulsion | KN2 | 1.2 | | | |
| | CL2D | 0 | M\$ | | |
| Electric | KN3 | 1 | | | |
| | CL3D | 0 | M\$ | | |
| Command, Control, Surveillance (less payload GFM cost) | KN4 | 2 | | | |
| | CL4D | 0 | M\$ | | |
| Auxiliary | KN5 | 1.5 | | | |
| | CL5D | 0.29566828 | M\$ | | |
| Outfit | KN6 | 1 | | | |
| | CL6D | 0 | M\$ | | |
| Armament (less payload GFM cost) | KN7 | 1.13333333 | | | |
| | CL7D | 2.02066453 | M\$ | | |
| Margin Cost | CLM | 0 | M\$ | | |
| Integration/Engineering (Lead ship includes detail design engineering costs for class) | KN8 | 10 | | | |
| | CL8D | 1.79784156 | M\$ | | |
| Ship Assembly and Support (Lead ship includes all tooling, jigs, special facilities for class) | KN9 | 2 | | | |
| | CL9D | 0.9627763 | M\$ | | |
| Total Lead Ship Construction Cost (BCC) | CLCC | 7.31174263 | M\$ | | |
| Profit Factor | FPROFIT | 0.1 | | | |
| Profit | CLP | 0.73117426 | M\$ | | |
| Lead Ship Price | PL | 8.0429169 | | | |
| Change Order Factor | COF | 0.12 | | | |
| Change Orders | CLCORD | 0.96515003 | M\$ | | |
| Total Shipbuilder Portion | CSB | 9.00806693 | M\$ | | |
| <u>Lead Ship Cost - Government Portion</u> | | | | | |
| Other Support Factor | OSF | 0.025 | | | |
| Other Support | CLOTH | 0.20107292 | M\$ | | |
| Program Manager's Growth Factor | PMGF | 0.1 | | | |
| Program Manager's Growth | CLPMG | 0.80429169 | M\$ | | |
| Weight of Costed Military Payload | WMP | 133.17 | lton | | WT4+WT7+WF20-WIC-WF23 |
| Combat System GFE CER | CSCER | 0.32107302 | M\$/lton | Input | |
| Helo cost | HC | 18.71 | M\$ | | |
| Ordinance and Electrical GFE (Military Payload GFE) | CLMPG | 72.7970247 | M\$ | | |
| HM&E GFE Factor | HMEGFEF | 0.03 | | Input | |
| HM&E GFE (Boats, IC) | CLHMEG | 0.24128751 | M\$ | | |
| Outfitting Cost Factor | OCF | 0.04 | | Input | |
| Outfitting Cost | CLOUT | 0.32171668 | M\$ | | |
| Total Government Cost | CLGOV | 74.3653934 | M\$ | | |
| Total End Cost | CLEND | 83.3734604 | M\$ | | Must always be less than SCN appropriation |
| Total Lead Ship Acquisition Cost | | | | | |
| Post Delivery Cost (PSA) Factor | PSACF | 0.05 | | | |
| PSA Cost | PSAC | 0.40214584 | M\$ | | |
| Total Lead Ship Acquisition Cost | TLSAC | 83.7756062 | M\$ | | |