

# Introduction to Transportation Systems

---

**PART III:**  
**TRAVELER**  
**TRANSPORTATION**

# **Chapter 28:**

# **Urban Public Transportation**

# Urban Public Transportation

- ◆ Introduction
  - ◆ LOS
  - ◆ Services
  - ◆ History
  - ◆ Costs
  - ◆ Temporal Peaking and its Implications
- ◆ Characteristics of the Industry
- ◆ A Model of Investment and Maintenance
- ◆ Service Design
- ◆ ITS
- ◆ Fares and Financial Viability
- ◆ Conclusion

# LOS Variables for Urban Travelers

Let us review our level-of-service variables for travelers.

- ☞ Travel time
- ☞ Reliability
- ☞ Cost
- ☞ Waiting time
- ☞ Comfort
- ☞ Safety
- ☞ Security

are all examples of level-of-service variables that are relevant to any traveler transportation mode.

# How Public Transportation Measures Up

- ◆ Comfort in a crowded rush-hour subway car is not high
- ◆ One has to wait for service depending on the service frequency of the mode one is considering
- ◆ Travel time may be greater or less than that of an automobile, depending on the circumstances
- ◆ How about self-image?

CLASS DISCUSSION

# Some Other LOS Variables

- ◆ Security
- ◆ Availability of service
- ◆ Safety
- ◆ Accessibility to service

# Types of Urban Public Transportation Service

- ◆ Conventional Bus
- ◆ Para-Transit
- ◆ Demand-Responsive Service
- ◆ Rail Systems
- ◆ Subways
- ◆ Commuter Rail
- ◆ Intermodal Services



# Life-Cycle Costs

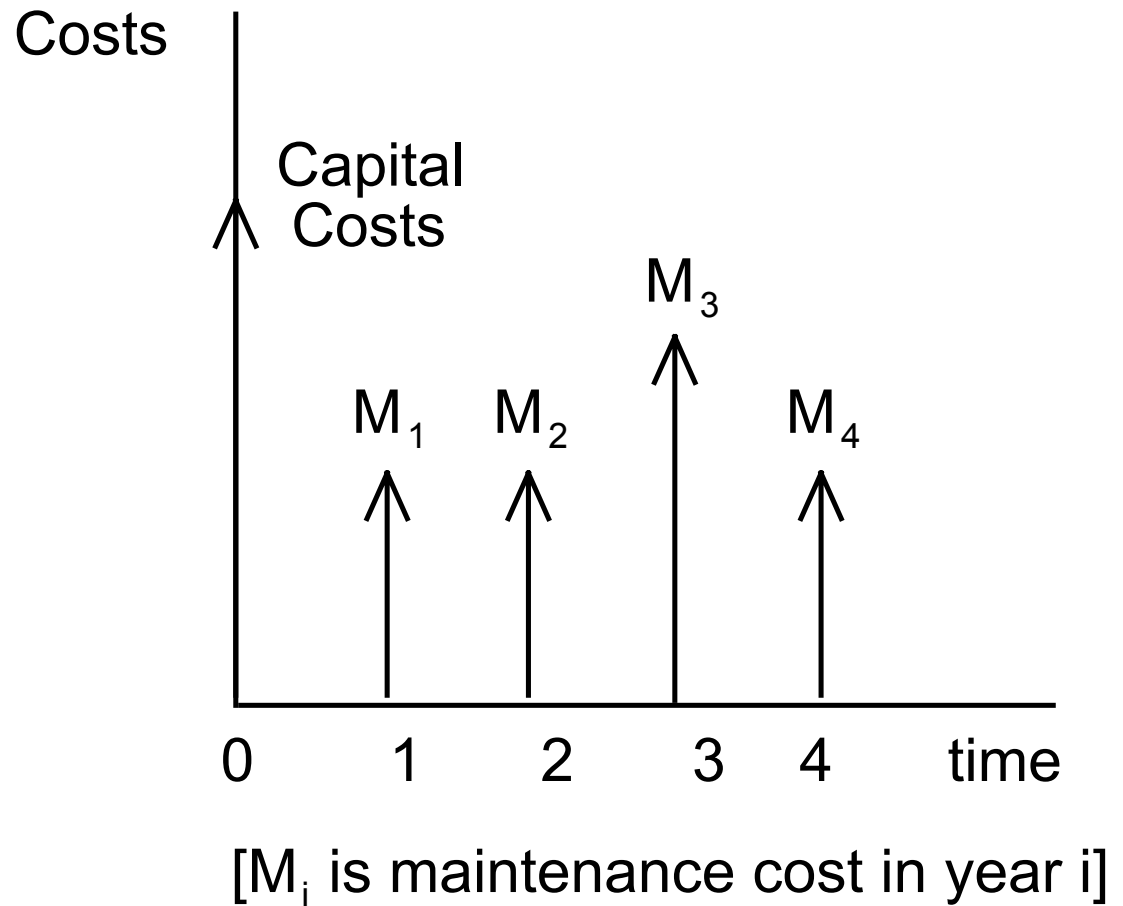

Figure 28.2

$$DCF = C_c + \sum_{n=1}^{\infty} \frac{M_n}{(1+i)^n}$$

where  $C_c$  is the capital cost and  $i$  is an interest rate or “discount rate” that reflects the time-value of money as well as a risk factor.

## Maintenance Costs

=  $f$  ( Quality of initial construction, current state of infrastructure, wear-and-tear caused by traffic)

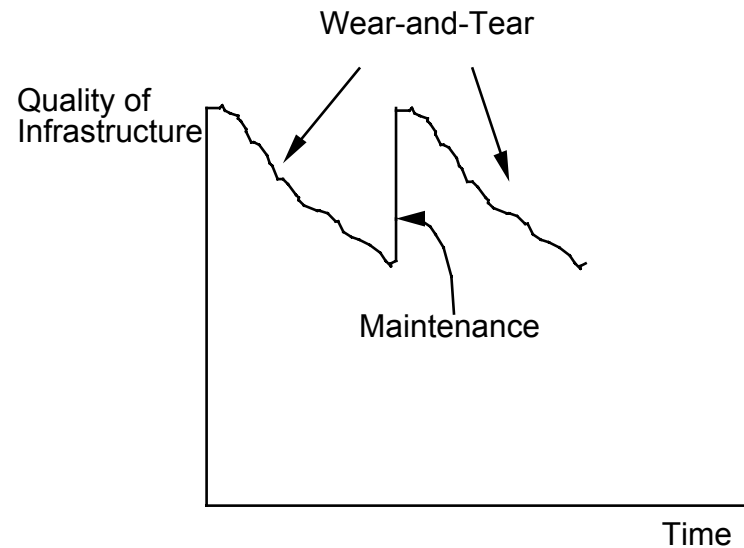
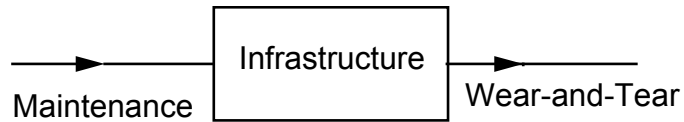

Figure 28.3

# Benefits of Maintenance as a Function of Infrastructure Quality

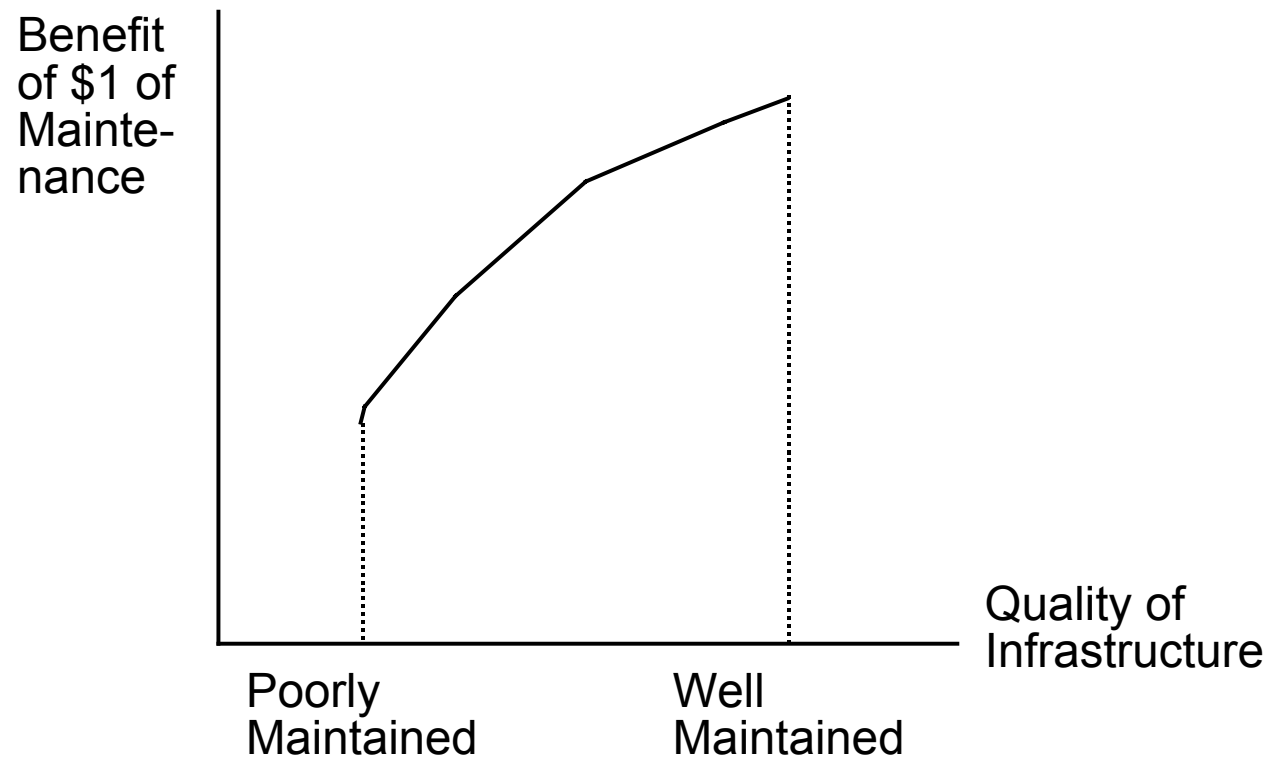

Figure 28.4

# The Impact of Delaying Maintenance

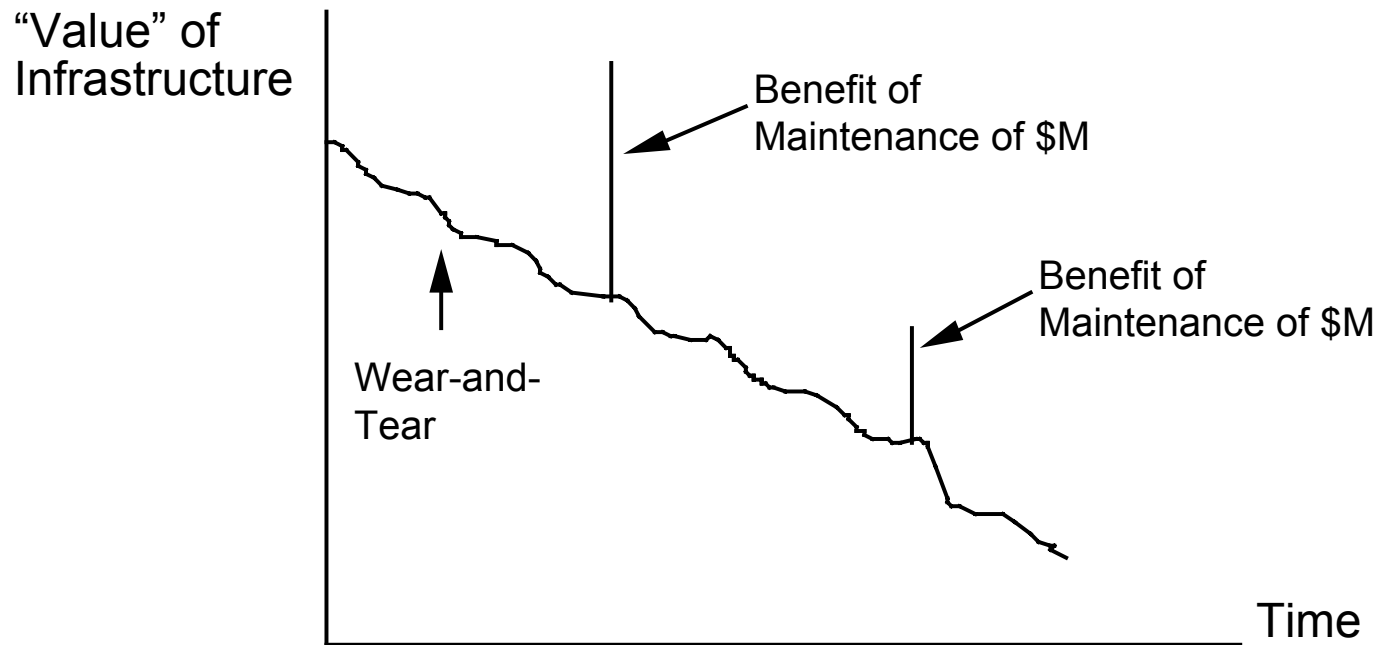

Figure 28.5

# Wear-and-Tear as a Function of Infrastructure Quality

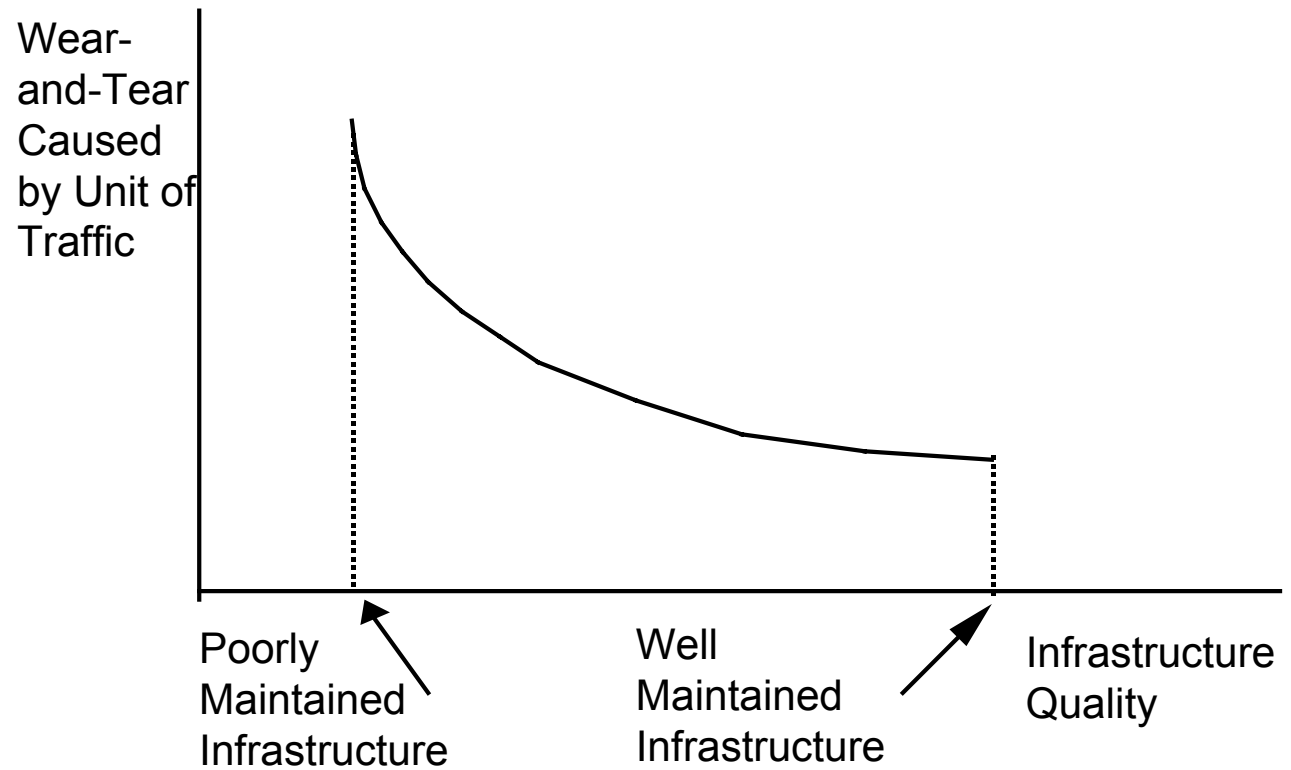

Figure 28.6

# LOS as a Function of Quality of Infrastructure



Figure 28.7

# The “Vicious Cycle”

- ◆ The quality of our infrastructure deteriorates, level-of-service deteriorates, and considering the equilibrium framework, traffic volumes will deteriorate.
- ◆ So revenue goes down and there are even fewer dollars to spend to improve our infrastructure by counterbalancing the effects of wear-and-tear through maintenance.



# The Vehicle Cycle

The basic equation for sizing a fleet is as follows:

$$NVEH = \frac{VC}{HEADWAY}$$

where *NVEH* is number of vehicles in the fleet; *VC* is the vehicle cycle on this route -- the time it takes the vehicle to traverse the entire route; and *HEADWAY* is the scheduled time between consecutive vehicles.

Alternatively,

$$NVEH = FREQUENCY \ VC$$

where *FREQUENCY* is the number of vehicles per unit of time passing a point on the route.

# Vehicle Cycle

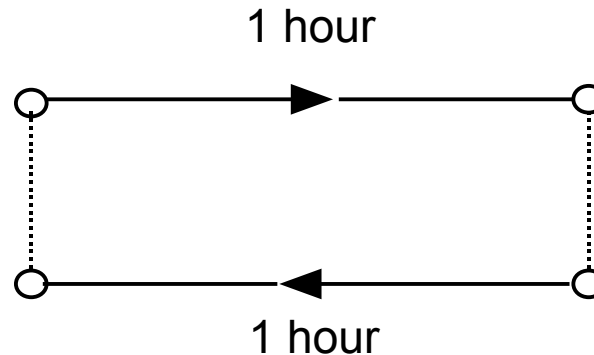

Suppose we want a service frequency of four vehicles per hour.

- ◆ How many vehicles do we need?
- ◆ How would you reduce the number of vehicles needed?

## CLASS DISCUSSION

# Control Strategies for Rail System

- ◆ Holding Trains
- ◆ Station-Skipping

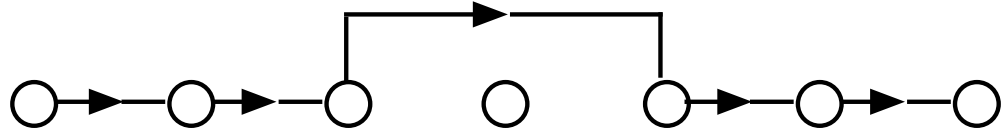

- ◆ Short-Turning

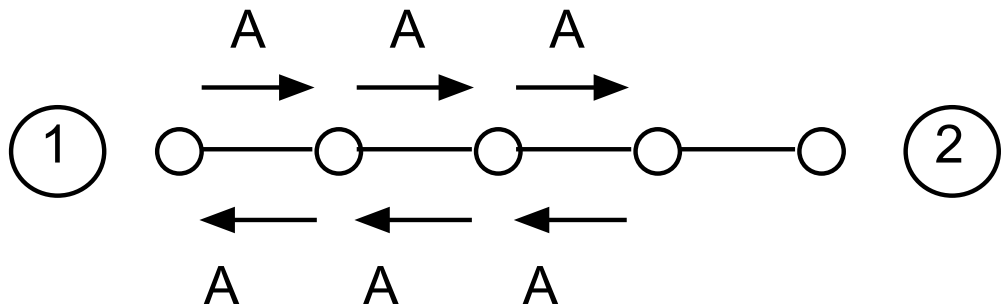

# ITS -- Public Transportation Applications

- ◆ The ITS concept, described in Chapter 24, can be applied to public transportation. These applications, known collectively as Advanced Public Transportation Systems (APTS), include such technologies as automatic vehicle location and automatic passenger counters, which can provide the basis for more efficient fleet management systems, both in fixed rail and bus systems.

# Traveler Information through ITS

## Intermodal Transfers

There are operating strategies that would allow transit systems to operate more effectively. These strategies are *information-driven* and ITS technologies can be a boon to the transit industry both in improving operations and service and in providing timely information to travelers. The latter in and of itself could be an important market initiative for the public transportation industry.

# Fares, Ridership and Finance

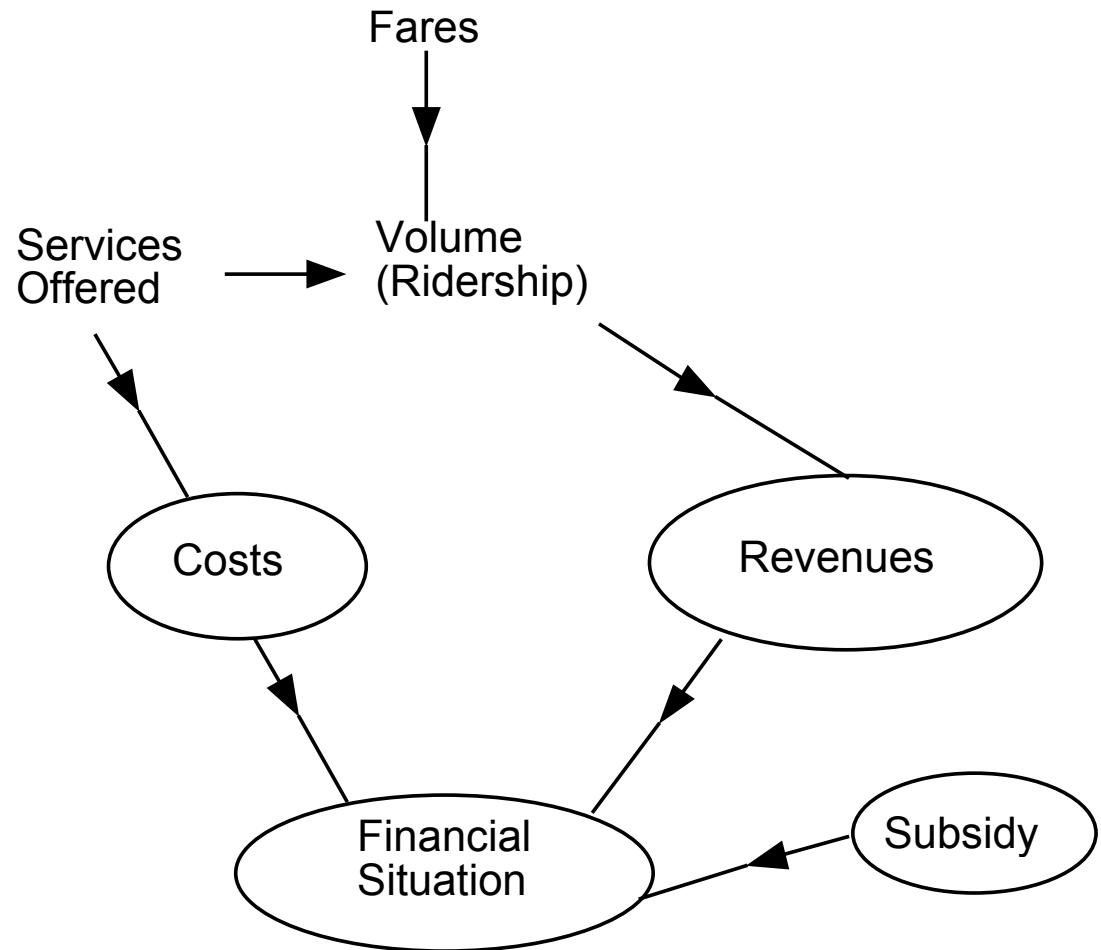
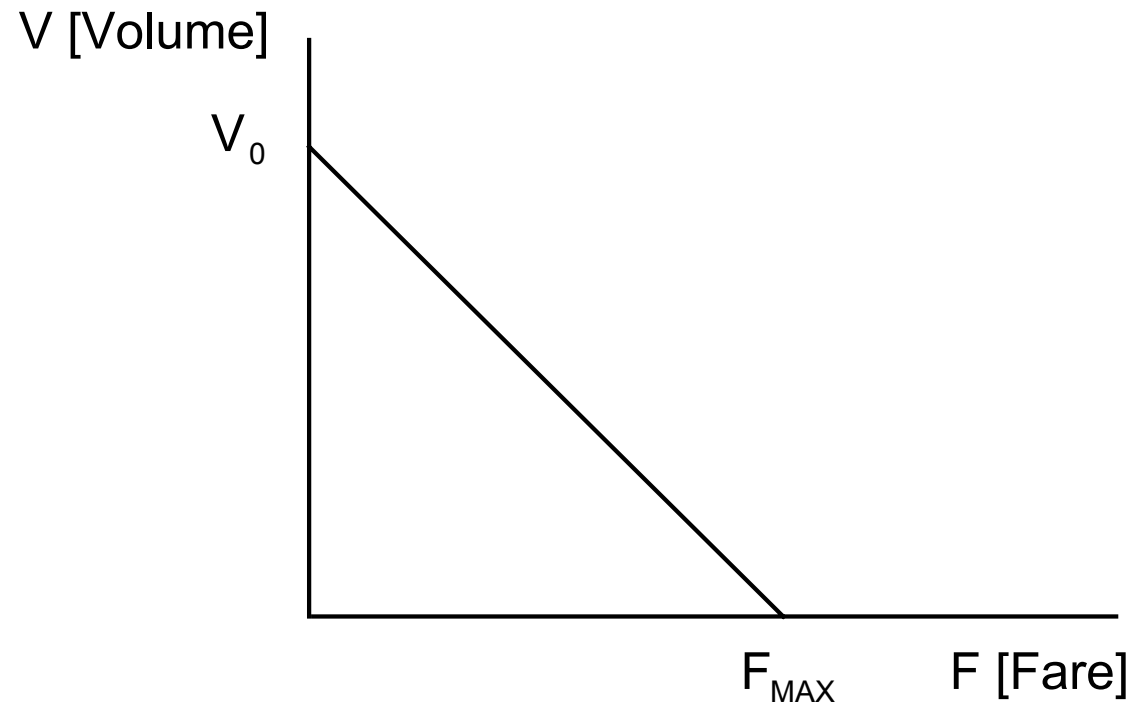

Figure 28.12

# Linear Demand Function



$$(F_{opt} = F_{max}/2)$$

Figure 28.13

# Parabolic Demand Function

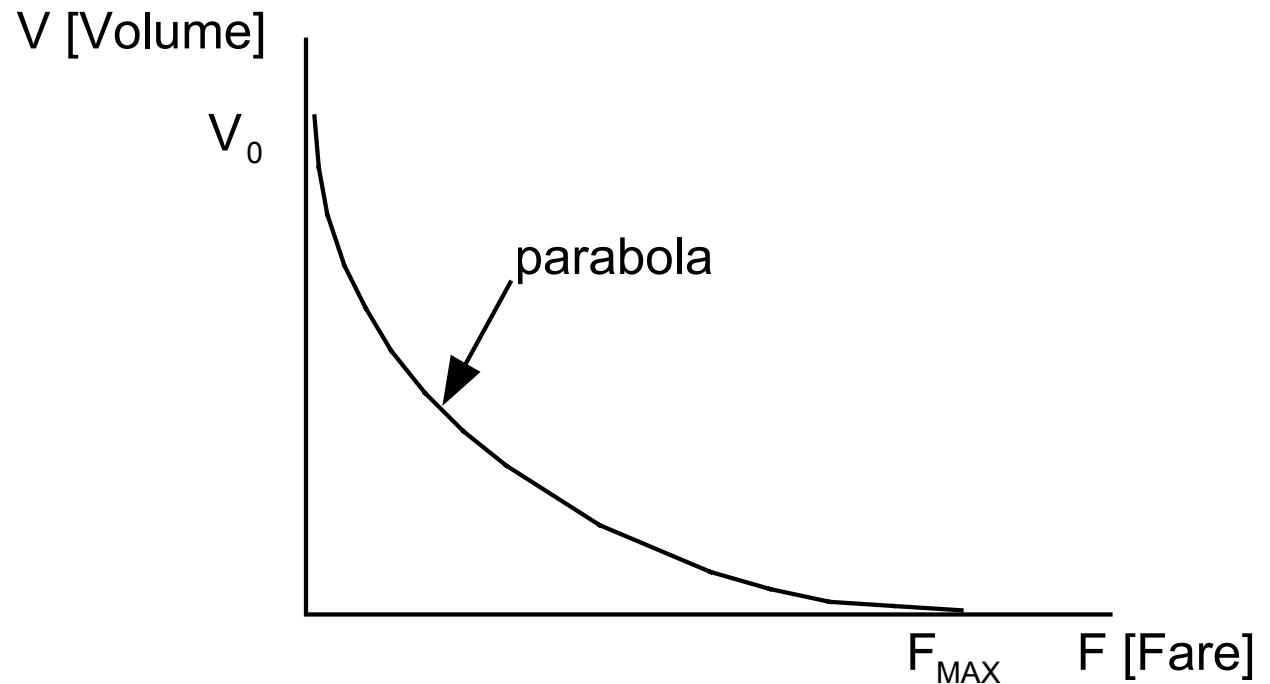

$$(F_{opt} = F_{max}/3)$$

Figure 28.14



# “Inelastic” Demand Function

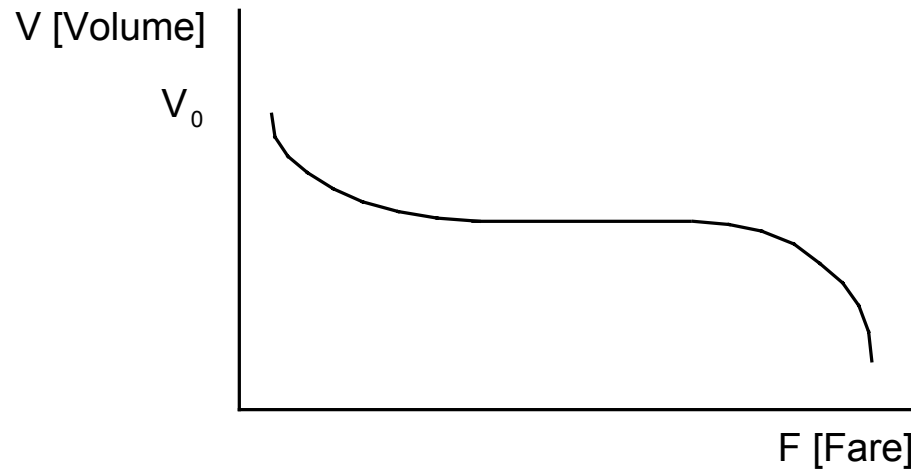

The horizontal line would reflect little or no change in demand (inelastic demand) as a function of fare for some range of fares. So why not simply raise fares and hence revenue?

- ◆ Equity
- ◆ Air Quality
- ◆ Congestion on highways