



APPROACHES TO ENHANCE DRIVER SITUATIONAL ASSESSMENT AIDS

Eric M. Jones and R. John Hansman

Report No. ICAT-2007-3
September 2007

***MIT International Center for Air Transportation
Department of Aeronautics & Astronautics
Massachusetts Institute of Technology
Cambridge, MA 02139 USA***

This Page Left Intentionally Blank

Approaches to Enhance Driver Situational Assessment Aids

by

Eric M. Jones and R. John Hansman, Jr.

Abstract

Collision warning systems encounter a fundamental trade-off between providing the driver more time in which to respond and alerting the driver unnecessarily. The probability that a driver successfully avoids a hazard increases as the driver is provided more time and distance in which to identify the hazard and execute the most effective response. However, alerting the driver at earlier, more conservative thresholds increases the probability that the alerts are unnecessary, either because sensor error has falsely identified a hazard or because the environment has changed such that a hazard is no longer a threat. Frequent unnecessary alerts degrade alert effectiveness by reducing trust in the system. The human-factors issues pertaining to a forward collision warning system (FCWS) were analyzed using an Integrated Human-Centered Systems approach, from which two design features were proposed: multi-stage alerting, which alerts the driver at a conservative early threshold, in addition to a more serious late threshold; and directional alerting, which provides the driver information regarding the location of the hazard that prompted the alert activation. Alerting the driver earlier increases the probability of a successful response by conditioning the driver to respond more effectively if and when evasive action is necessary. Directional alerting decreases the amount of time required to identify the hazard, while promoting trust in the system by informing the driver of the cause of the alert activation. The proposed design features were incorporated into three FCWS configurations, and an experiment was conducted in which drivers were equipped with the systems and placed in situations in which a collision would occur if they did not respond. Drivers who were equipped with multi-stage and directional alerting were more effective at avoiding hazardous situations than drivers who were not provided early alerting. Drivers with early alerting tended to respond earlier and more consistently, which promoted more successful responses. Subjective feedback indicates that drivers experienced high levels of acceptance, confidence, and trust in multi-stage and directional alerting.

This document is based on the thesis of Eric M. Jones, which was submitted to the Department of Aeronautics and Astronautics at the Massachusetts Institute of Technology in partial fulfillment of the requirements for the degree of Master of Science in Aeronautics and Astronautics.

This Page Left Intentionally Blank

Acknowledgements

This work was funded by a grant provided through the Ford-MIT Alliance. Louis Tijerina, Dev Kochhar, and Jeffrey Rupp acted as technical sponsors and provided generous amounts of support, feedback, and assistance.

A portion of this research was performed at the Research and Innovation center at Ford Motor Company, Dearborn. The authors would like to thank everyone within the Active Safety Department and Advanced Vehicle Technology building 5 for their kind hospitality and valuable insight.

This Page Left Intentionally Blank

Table of Contents

Abstract	3
Acknowledgements	5
Table of Contents	7
List of Figures	9
List of Tables	13
1. Introduction	15
2. Methodology	18
2.1. Integrated Human-Centered Systems Approach	18
2.2. System Model	19
2.3. Information Requirements	23
2.4. Kinematic Assessment	25
2.4.1. Example: Stopped Object on a Highway	28
2.4.2. Time-to-Collision Alerting Thresholds	31
2.4.3. The System Operating Characteristic Curve	33
2.5. Proposed Design Features	35
2.5.1. Multiple-Stage Alerting	35
2.5.2. Directional Alerting	37
3. Experimentation	39
3.1. Hypotheses	40
3.2. Experimental Design	41
3.3. FCWS Configurations	42
3.3.1. Alerting Displays	42
3.3.2. Alerting Thresholds	44
3.4. Simulated Environment	44
3.4.1. Simulated Vehicle and Driving Environment	44
3.4.2. Controlled FCWS Activations	45
3.5. Participants	48
3.6. Experimental Procedure	48
3.6.1. Training Session	48
3.6.2. Testing Sessions	49
3.6.3. Secondary Tasks	50
3.6.4. Follow-up Briefing	52
3.7. Apparatus	52
4. Results and Discussion	54
4.1. Effectiveness	54
4.2. Response Times and Behavior	64
4.2.1. Velocity Profiles	67
4.2.2. Relative Velocity vs. Range Profiles	69
4.3. The Naïve Response	71
4.4. Secondary Task Performance	73
4.4.1. Map-Reading	73
4.4.2. Police Officer Identification	74
4.4.3. Maintaining Speed	75
4.5. Response to Unnecessary Alert Activations	75
4.6. Subjective Responses	78

<u>5. Conclusions</u>	85
<u>6. References</u>	88
<u>Appendix A: Treatment Summary</u>	91
<u>Testing Scenario Treatments</u>	91
<u>Training Scenario Treatments</u>	92
<u>Appendix B: Threat Event Illustrations</u>	93
<u>Training Scenario Threat Event</u>	93
<u>Testing Scenario Threat Events</u>	93
<u>Appendix C: Subject Demographics</u>	98

List of Figures

Figure 2-1: General FCWS closed loop feedback process.	20
Figure 2-2: Detailed FCWS closed loop feedback process.	21
Figure 2-3: Examples of intent states; all describe ways in which the system dynamics can change.	24
Figure 2-4: An example state-space representation of collision avoidance (braking to stop).	26
Figure 2-5: An example state-space representation of collision avoidance (steering to avoid).	26
Figure 2-6: An example state-space representation, including a notional alerting threshold.	27
Figure 2-7: A simplified representation of an example steering response.	29
Figure 2-8: Example: braking maneuvering limits for response times of 1.5, 3.0, and 6.0 seconds.	30
Figure 2-9: Example: steering maneuver limits for response times of 1.5, 3.0, and 6.0 seconds.	30
Figure 2-10: Example braking maneuver limits and corresponding notional alerting thresholds.	32
Figure 2-11: Example steering maneuver limits and corresponding notional alerting thresholds.	32
Figure 2-12: An example SOC curve.	33
Figure 2-13: Various degrees of system benefit as expressed by the SOC curve.	34
Figure 2-14: An SOC curve representation of the benefits of multi-stage alerting.	36
Figure 2-15: An example implementation of a multi-stage alerting configuration.	36
Figure 2-16: An example implementation of multi-stage directional alerting (1 of 3); locational stimulus highlights objects in the environment (diamond and octagon on windshield).	38
Figure 2-17: An example implementation of multi-stage directional alerting (2 of 3).	38
Figure 2-18: An example implementation of multi-stage directional alerting (3 of 3).	39
Figure 3-1: The experimental design: 1 fixed factor across 4 levels, representing 4 treatments.	41
Figure 3-2: The late alert display (without the audio).	43
Figure 3-3: The Early Non-Directional system configuration with (right) and without the late alert.	43
Figure 3-4: The Early Directional system configuration with (right) and without the late alert.	43
Figure 3-5: TE2 example illustration: Oncoming vehicle turns left in front of the driver.	47
Figure 3-6: TE6 example illustration: With an accident in the left-hand lane, an ambulance crosses the road from the right.	47
Figure 3-7: An example of a map used for the map-reading task [44].	51
Figure 3-8: The driving simulator.	53

Figure 3-9: The positions of the subject and investigator.	53
Figure 4-1: Relative velocity at impact for collisions that occurred during TE2.	58
Figure 4-2: Relative velocity at impact for collisions that occurred during TE4.	58
Figure 4-3: Minimum range with respect to the target vehicle.	63
Figure 4-4: Response times with respect to the target vehicle.	66
Figure 4-5: Velocity profile for TE2 (key to the right).	68
Figure 4-6: Velocity profile for TE4.	68
Figure 4-7: Relative velocity vs. range plot for TE2.	70
Figure 4-8: Relative velocity vs. range plot for TE4.	70
Figure 4-9: Relative velocity vs. range plot for TE8.	71
Figure 4-10: Relative velocity vs. range plot for the training scenario threat event (naïve response).	73
Figure 4-11: Map-reading task completion times.	74
Figure 4-12: Example: accelerator input during unnecessary alert activations; first exposure to the Early Directional FCWS (1 of 2).	76
Figure 4-13: Example: accelerator input during unnecessary alert activations; first exposure to the Early Directional FCWS (2 of 2).	76
Figure 4-14: Example: accelerator input during unnecessary alert activations; first exposure to the Early Non-Directional FCWS (1 of 2).	77
Figure 4-15: Example: accelerator input during unnecessary alert activations; first exposure to the Early Non-Directional FCWS (2 of 2).	77
Figure 4-16: Subjective rating of the usefulness of early alerting.	78
Figure 4-17: Percentages of subjects who thought early alerting was useful, not useful, or were unsure.	79
Figure 4-18: Subjective confidence ratings for each of the alerting systems.	80
Figure 4-19: Percentage of subjects who were confident in the Early Directional system configuration, not confident, or were unsure.	80
Figure 4-20: Percentage of subjects who were confident in the Early Non-Directional system configuration, not confident, or were unsure.	81
Figure 4-21: Percentage of subjects who were confident in the Late Alerting Only system configuration, not confident, or were unsure.	82
Figure 4-22: Percentage of subjects' system configuration preferences.	82
Figure 4-23: Percentage of subjects who would prefer to own a FCWS, would not prefer to own one, or were unsure.	83
Figure 4-24: Percentage of subjects' system configuration preferences of those who would prefer to own a FCWS.	84
Figure B-1: Training Threat Event: a lead vehicle pulls off the road to uncover a stopped vehicle in the driver's lane.	93
Figure B-2: Threat Event 1: Construction blocking the driver's lane.	93
Figure B-3: Threat Event 2: Oncoming vehicle turning left in front of the driver.	94
Figure B-4: Threat Event 3: Initially stopped vehicle pulls into the driver's lane.	94
Figure B-5: Threat Event 4: A police officer chases another vehicle across the road.	95

Figure B-6: Threat Event 5: A cyclist enters the driver's lane.	95
Figure B-7: Threat Event 6: With an accident in the left-hand lane, an ambulance crosses the road from the right.	96
Figure B-8: Threat Event 7: An initially stopped vehicle makes a right-hand turn into the driver's lane.	96
Figure B-9: Threat Event 8: A lead vehicle decelerates because of slow-moving traffic up ahead.	97
Figure C-1: Subject gender distribution.	98
Figure C-2: Subject age distribution.	98
Figure C-3: Subject driving experience distribution.	98

This Page Left Intentionally Blank

List of Tables

Table 2-1: Alerting threshold TTC values for 1.5, 3.0, and 6.0 second response times for evasive braking and steering maneuvers for an assumed maximum initial speed of 60 mph.	31
Table 4-1: Threat event outcome summary (key below).	56
Table 4-2: Target vehicle collisions for each system configuration.	57
Table 4-3: Late alert threshold crossings, with respect to the target vehicle.	59
Table 4-4: Collision avoidance effectiveness, with respect to the target vehicle.	60
Table 4-5: Target and non-target collisions, as a percentage of the total number of hazards.	60
Table 4-6: Late alert threshold crossings for each system configuration, as a percentage of the total number of target and non-target hazards.	61
Table 4-7: Collision avoidance effectiveness, with respect to target and non-target hazards.	61
Table 4-8: Late alert threshold crossings (given early alert threshold crossings), necessary early alerts, and system effectiveness.	62
Table 4-9: Early responses, with respect to the target vehicle.	64
Table 4-10: Undefined response times.	65
Table 4-11: Type of first response during the threat events, expressed as percentage of the total number of responses.	66
Table 4-12: Training scenario threat event outcomes (naïve response) (key to the right).	72
Table 4-13: Number of correct police officer identifications.	75
Table 4-14: Unnecessary early alert activations.	77
Table A-1: Testing scenario treatment order (key below).	91
Table A-2: Training scenario treatment order (key below).	92

This Page Left Intentionally Blank

1. Introduction

Each year, approximately 40 thousand people in the United States lose their lives because of automobile accidents, an average that has remained steady for decades despite technological advances in motor vehicle safety [1, 2]. Passive safety systems such as seat belts and air bags effectively reduce the severity of injuries that result from collisions, but they are limited to mitigating the aftermath of dangerous situations that may have already injured the driver. To reduce the number of motor vehicle collisions, injuries, and fatalities, research efforts have been developing *active safety systems* that aim to prevent accidents from occurring altogether.

Current active safety systems focus predominantly on driver warnings and vehicle control; for example, electronic stability systems and anti-lock brakes that prevent the driver from losing control of the vehicle during a turning or braking maneuver. Warning lights mounted on mirrors can indicate the presence of a vehicle in a blind spot, and *lane departure warnings* can alert the driver if an unintentional lane change is detected. There are also systems that control the vehicle automatically, such as *adaptive cruise control* which monitors and adjusts speed to match the traffic in the driver's lane and *collision mitigation by braking* which reduces vehicle speed when a collision appears imminent. Unlike automated systems and simple warnings, *collision warning systems* operate concurrently with the driver to provide alerts that support awareness and assessment of potential hazards in order to avoid undesirable incidents [3].

Over 1.8 million rear-end collisions were reported in 2005, comprising the largest segment of crashes (29.6%) as well as the most common crash that exclusively damages property (30.4%) [1]. In addition to being the most frequent and most costly type of accident, rear-end collisions are also the most preventable, assuming that the driver ultimately has control of the vehicle's speed and trajectory. The frequency and preventability of these collisions suggests that a collision warning system that alerts the driver to hazards in front of the vehicle will provide the greatest opportunity for reducing the number of accidents. Estimates claim such a system could eliminate 37% to 74% of rear-end collisions [4], but there is an even greater opportunity for reducing the accident rate when considering other situations in which a driver may inadvertently control his or her vehicle into another object, vehicle, or person.

A *forward collision warning system* (FCWS) is a collision warning system that focuses solely on the environment in front of the driver's vehicle. An *alerting threshold* is a set of criteria that defines when the FCWS will issue an alert, which is typically based on the system *state*, or the "complete set of parameters that define the dynamics of a hazard situation" [5]. For the purposes of this thesis, a *hazard* is defined as anything in the environment with which the driver's vehicle will collide if the velocities of the vehicle and of the hazard were to remain constant at any point in time. A hazard in the forward environment includes anything that can intersect the vehicle's forward trajectory, such as static objects into which the vehicle can be driven, as well as moving hazards that may enter the vehicle's path.

Conservative alerting thresholds alert the driver well in advance of a collision, which increases the likelihood of a successful outcome. However, increasing the amount of time or distance between the driver's vehicle and the hazard increases the probability that the alert is *unnecessary*. An unnecessary, or nuisance, alert does not change the driver's awareness; i.e., the probability that the driver successfully avoids the hazard is independent from having received the alert [5]. Sensor performance degrades at increased range, which decreases the accuracy with which hazards are detected. For example, an inaccurate detection of a roadside hazard could incorrectly indicate that it is in the driver's lane. The surrounding environment also changes rapidly, and predictions of state at conservative thresholds are frequently incorrect because the environment evolves such that the relative dynamic states between the vehicle and the hazard do not warrant an alert activation. For example, the driver may pass a stationary object along the side of the road while turning, which will not present a hazard if the vehicle continues to turn; but during the fraction of a second in which the vehicle is pointed towards the object, a simple collision warning algorithm would determine the vehicle's instantaneous forward trajectory, calculate a potential collision, and activate unnecessarily. The object would have been avoided if the alert had not been issued; however, a collision would have occurred if the vehicle had maintained that trajectory. On the other hand, if the object was a moving vehicle in the opposite lane, the system would have to infer what the other vehicle was going to do in the future. Even if the states of the environment are measured perfectly, there will be situations in which the FCWS will unnecessarily alert the driver because of the uncertainty that permeates the external environment and the activity other vehicles.

Frequent unnecessary alerts will degrade the driver's trust in the system (this is sometimes referred to as the *cry-wolf* effect), but setting the threshold too close to an impending collision will reduce alert effectiveness by decreasing the available time and distance in which to respond. The frequency of nuisance alerts may annoy the driver to the point of distraction, particularly if the FCWS interface is invasive. Driving incorporates many cognitively intensive tasks, and a mistimed alarm (especially an unnecessary one) may exacerbate a dangerous situation by increasing the driver's cognitive workload. Similarly, alerting at an inopportune time may incite evasive behavior that could cascade into a more serious situation. Consideration of these human factors issues indicates a delicate, temporal balance of information that contributes to the overall success of a collision warning system. The goal of this thesis is to examine the system from a human-centered perspective in order to design and evaluate situational assessment aids that enhance the effectiveness of a FCWS.

The success of an alert is largely dependent on the driver's *response time*, i.e., the amount of time needed to assess the situation and, if necessary, perform an evasive maneuver. Supporting the driver's awareness of the environment and providing more time to make an assessment will increase the probability that the driver will respond quickly and effectively. However, there is a fundamental tradeoff between providing the driver more time in which to react, and alerting the driver unnecessarily. Conservative alerting thresholds provide the driver more time and distance in which to make an assessment, but alerting farther in advance increases the probability that the alert will not be necessary. Unnecessary alerts decrease the driver's trust in the system, which increases reaction time by provoking skeptical behavior that compels the driver to verify that the cause of the alert is reason for concern. Response time increases if the driver must identify a hazard that lacks salience, especially if the driver is initially distracted and has not been monitoring changes in the environment.

Two situational assessment aids are proposed to enhance the effectiveness of a collision warning system: *multi-stage alerting*, which alerts the driver at an earlier, conservative threshold in addition to a more serious late alert; and *directional alerting*, which provides the driver information regarding the location of the hazard that prompted the alert activation. The probability that a hazard is successfully avoided increases as the driver's response time decreases. Providing the driver more time in which to respond increases this probability as well, because the driver has more time in

which to choose the most appropriate response. Multi-stage alerting alerts the driver at earlier, more conservative thresholds, thereby informing a potentially distracted or unaware driver that there is hazard that may require further attention if the situation becomes progressively more dangerous. This advanced notice conditions the driver to respond more effectively if the hazard becomes more serious, because more time is provided to formulate a response. Even if the conservative alert is unnecessary, the driver will be more tolerant of the increased frequency of nuisance alerts if he or she understands why they were provided. Directional alerting maintains trust in the system by directing the driver's attention to the hazard that caused the alert to activate. Directional alerting also decreases response time by increasing hazard salience, which decreases the amount of time needed to identify the hazard.

An experiment was conducted to examine the potential benefits of multi-stage and directional alerting. Basic multiple threshold and directional alerting displays were emulated within a driving simulator, and assembled to form collision warning system configurations with multi-stage and directional alerting. Test subjects were equipped with various system configurations, and asked to drive through scenarios in which they were presented with hazardous events that would result in a collision if no response was made. The events were engineered to incorporate similar dynamics, but appeared to the driver in various forms to allay suspicion and preserve his or her candid response. Driver performance within the testing scenarios was then analyzed to examine differences amongst the collision warning system configurations.

2. Methodology

2.1. Integrated Human-Centered Systems Approach

The Integrated Human-Centered Systems (IHCS) approach is a tool that combines human factors and systems engineering concepts in order to “evaluate allocation of capability and responsibility between the human and other components of the information systems...” while simultaneously considering the environment in which the system operates [6]. The basic steps of the IHCS approach are as follows:

1. Model the system and operator(s) as a closed-loop feedback process.
2. Determine the information that the operator requires to perform the task.

-
3. Use the information requirements to determine the display/automation requirements.
 4. Develop prototype systems.
 5. Perform simulation evaluations.
 6. Integrated simulation testing.
 7. System evaluation.
 8. Field development phase.

The thesis will focus on steps 1 through 5 as applied to the design of a FCWS. Simulated testing was performed, but the design concepts have not been introduced into a field setting.

Previously, the IHCS approach has been used to evaluate aeronautical applications that involve complex flows of information amidst human operators, such as air traffic management and aircraft collision avoidance systems [6]. The automotive domain is similar in that the driver must navigate the vehicle safely through a hazardous, rapidly changing environment. There are differences, however, which put the driving environment at a disadvantage. The density of motor vehicles on a roadway is higher than that of aircraft within airspace. This proximity increases the speed with which a seemingly harmless situation can propagate into a hazardous one. The design of a FCWS must account for the dynamic constraints imposed by this proximity. For example, a situation will degrade more rapidly when a hazard is closer to the driver, which increases the risk of response time exceeding the amount of time that is available before a collision occurs. This supports the need to decrease the driver's response time, or alert the driver earlier, in order to ensure a successful avoidance.

2.2. System Model

The FCWS generalized system model is comprised of blocks that correspond to system elements and arrows that represent directional flows of either sensory or control information (Figure 2-1).

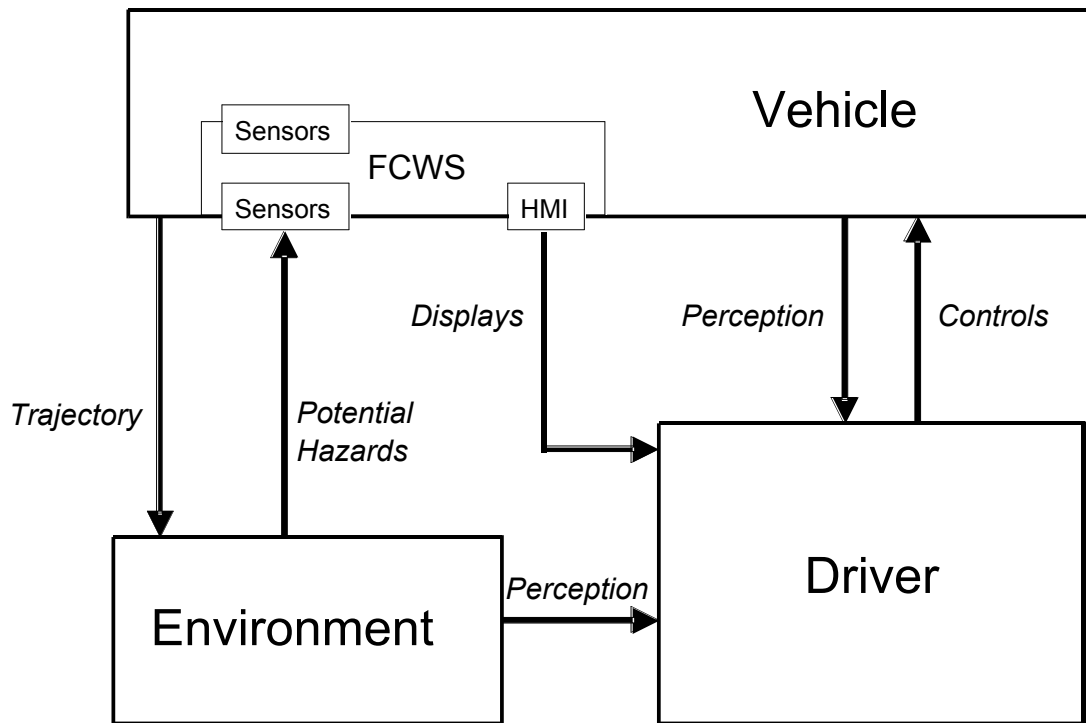

Figure 2-1: General FCWS closed loop feedback process.

The three main components are defined as the *driver*, the driver's *vehicle*, and the surrounding *environment* (a similar model is seen in [7]). The FCWS is contained within the vehicle, and is equipped with sensors that measure the state of the environment, as well as a human-machine interface (HMI) that displays information to the driver. The driver perceives information from the environment, the FCWS interface, and the vehicle. The vehicle is controlled by the driver and information from the environment is processed through the FCWS sensors. In Figure 2-2, the general model is expanded to include a finer resolution of internal processes.

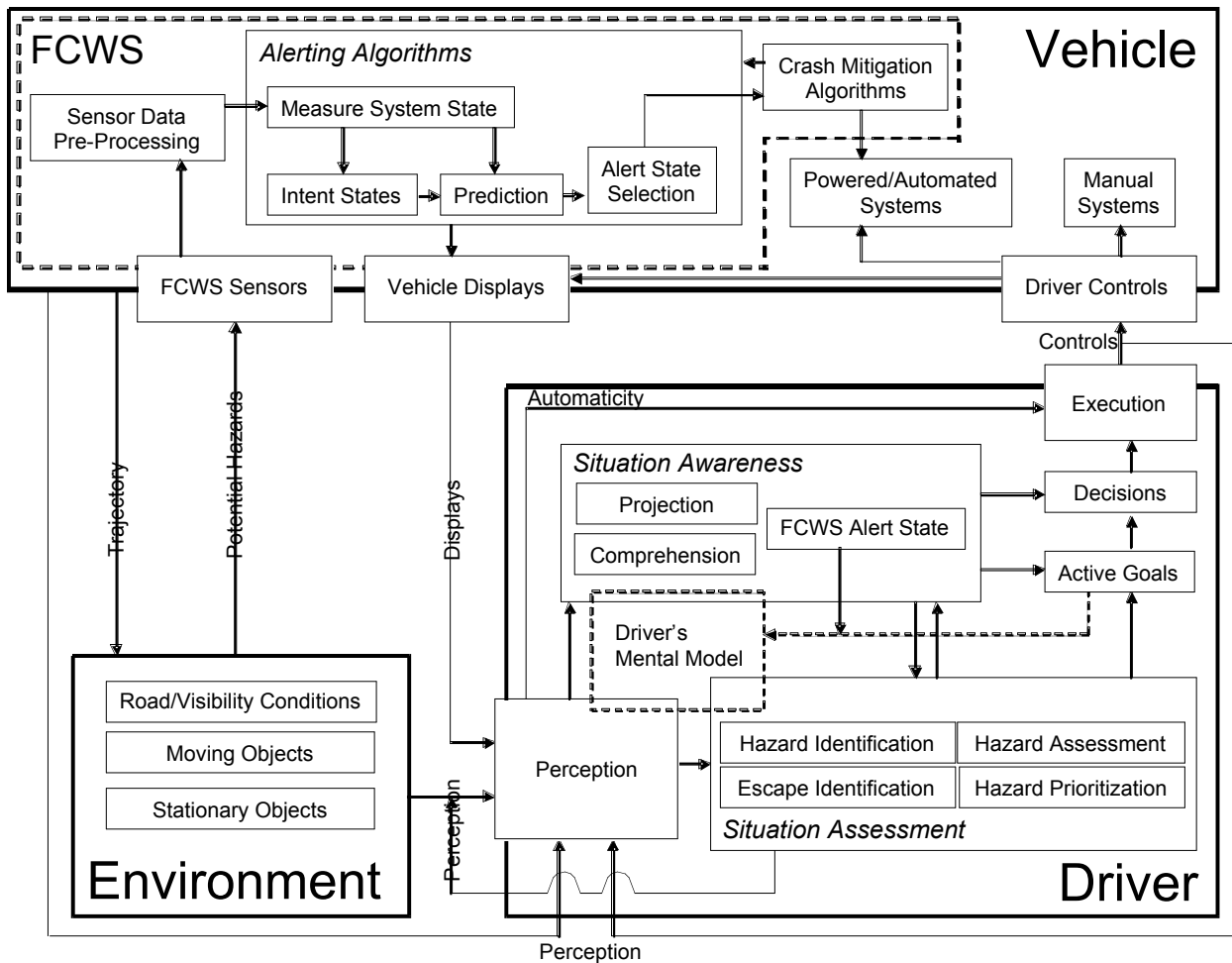

Figure 2-2: Detailed FCWS closed loop feedback process.

The driver's internal model is constructed with emphasis on the processes that reflect the integrated FCWS: the driver's awareness of the states of other system elements (*situation awareness*), and the assessment of potential hazards identified by the collision warning system (*situation assessment*). Situation awareness (SA), according to [8], is the "the perception of the elements in the environment ..., the comprehension of their meaning and the projection of their status in the near future" [9, 10]. SA is a diffuse information seeking process that influences decisions and active goals with knowledge of the current system states and how those states are changing. For example, as highlighted in the model, the driver must be aware of the state of the FCWS alerts. On the other hand, situation assessment is a directed information seeking process—upon receiving an alert, the driver verifies that a hazard exists, assesses the seriousness of the hazard, and, if necessary, identifies a potential escape maneuver. If

the FCWS issues more than one alert, the driver will have to prioritize his or her attention assuming that multiple hazards cannot be neutralized simultaneously.

The driver perceives information from a variety of sources, including sensory information from the environment and the in-vehicle displays, as well as feedback from control actions and the movement the vehicle. The driver's assessments can influence how information is perceived from the environment, such as where the driver is choosing to focus his or her attention. This assessment can also impact the awareness of perceived stimuli. Awareness and assessment both feed into the driver's active goals (which describe what the driving is currently planning to do), subsequently influencing his or her mental model. The mental model underlies all the cognitive processes, and encompasses the expectancies and schemata with which perceived information is interpreted and decisions are assessed. Active goals and SA influence decisions, which lead to the execution of those decisions. Automaticity refers to immediate, instinctual responses to stimuli that bypass the driver's cognitive processes [9].

The state of the environment is expressed within general categories that emphasize the position of the road and the states of objects both on and off the roadway. Road and visibility conditions may affect the vehicle's ability to stop (icy roads) or see vehicles up ahead (blind turns and hills). Hazards could be moving, such as other vehicles or pedestrians, or they could be stopped. Stopped hazards can have the potential to move (parked cars, standing pedestrians), or they could remain stationary (signs, road structures such as highway overpasses). The states of these environmental elements are perceived by the driver and the FCWS sensors, and continually change in relation to the vehicle's trajectory.

The information received by vehicle's FCWS sensors must first be pre-processed before it can be used by the alerting algorithms. The algorithms must determine the current state of the system, and then predict how those states will change. If the current state and/or prediction have crossed an alerting threshold, the alert state is then selected. In future implementations, the vehicle may be equipped with automated crash mitigation systems. Information from the alerting algorithms is displayed through the FCWS interface such as the alert state, current system state, and algorithm predictions. The vehicle displays provide the driver with feedback regarding control actions as well.

2.3. Information Requirements

With the system model specified, further examination reveals information that is required by the driver in order to use the FCWS effectively. Likewise, the collision warning system requires certain knowledge of the system state in order to alert the driver. By understanding the informational needs of both the driver and the FCWS, new opportunities for enhancing driver support are identified.

As the respective states of the driver, vehicle, and environment change, there are signals and processes that communicate the future state of each element. These *intent states* (Figure 2-3) do not necessarily communicate the dynamic states (position, velocity, and acceleration), but rather target states, intended trajectories, and destinations. For example, brake lights may indicate that a lead vehicle is intending to decrease its current speed, but they do not communicate the magnitude of deceleration. Additional intent states that the driver may associate with other vehicles include changes in relative position (range rate, azimuth change rate) and actions that convey an intended path (heading change rate, turn signals). Likewise, the driver's vehicle conveys this information to other vehicles as well. There are also situations in which the environment can indicate intended changes in the dynamic states of other vehicles, such as road signs and signals, the speed and position of surrounding vehicles, and other elements which influence the flow of traffic.

Intended trajectories can be inferred from the driver's control actions (activating turn signals before changing lanes), while biometric data can indicate physiological states (such as fatigue or stress) and driver awareness (head position and movement). The intent states of the vehicle are communicated to the driver through the vehicle displays. In a future FCWS implementation, advanced communication systems may make this information available to other vehicles, as well as intelligent highway systems.

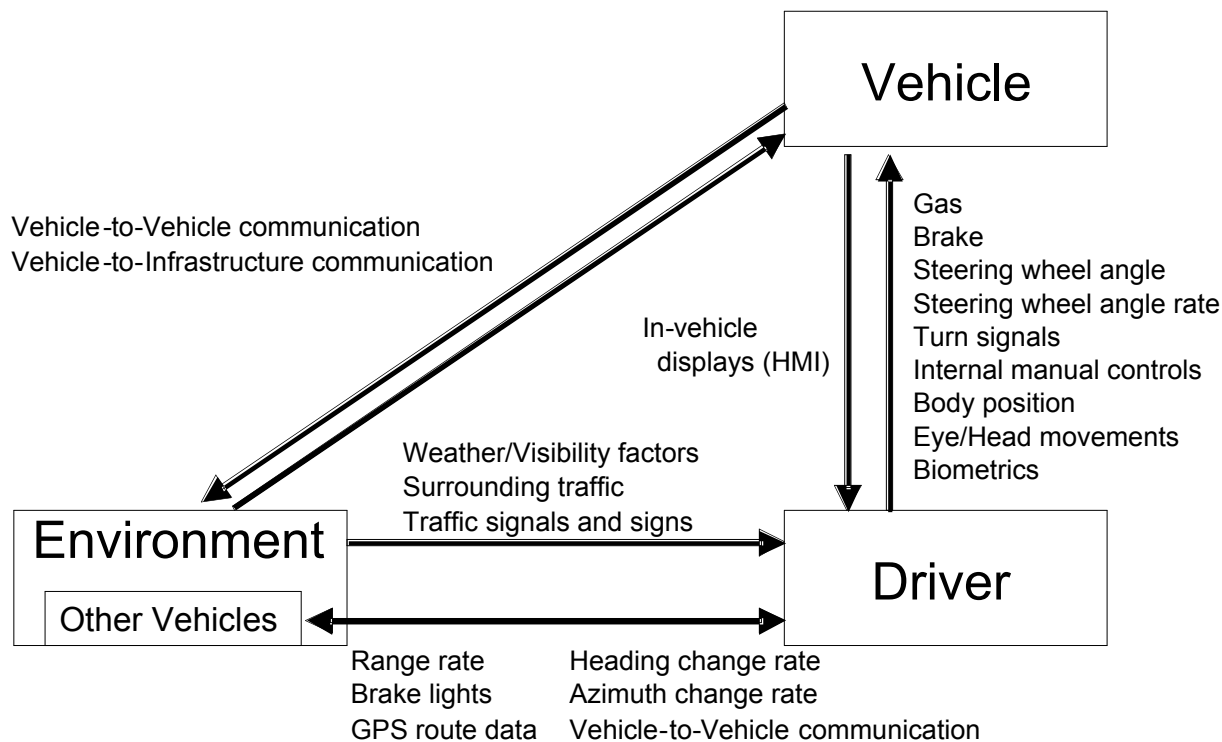

Figure 2-3: Examples of intent states; all describe ways in which the system dynamics can change.

For a system to warn the driver of potential hazards, it must be able to accurately detect those hazards within the environment. Sophisticated sensing technologies have existed for decades, but it was not until recently that these sensors have been made accessible to automobiles. Researchers have been exploring the potential applications of radar ([11-16]) and image-based systems ([17-19]) for object detection and identification. There are also technologies that rely on thermal imaging, particularly for detecting pedestrians or wild animals [20-22]. Vehicle and pedestrian detection is also being attempted through laserscanning [23-25]. Some of the more robust systems, however, are combined sensor suites [26, 27]. Selecting sensors and evaluating their effectiveness within an operating environment is beyond the scope of this thesis; however, given these observed technological trends, and for the purposes of this study, certain information is assumed to be available.

In order to help the driver avoid objects that could potentially intersect his or her path, these sensors must be able to detect the dynamic states of objects in the environment. Current position relative to the driver's vehicle is defined by range and azimuthal angle, while speed and acceleration vectors are derived from these values as they change over time. In a real-world implementation, the accuracy of these values

decreases as the distance to the hazard increases. Attempting to detect hazards at farther ranges will increase the number of false-positive identifications. False-positive alerts are unnecessary because no hazard is present in the environment. Regardless of what the driver chooses to do, no collision will occur with the cause of the alert activation.

When the FCWS issues an alert, the driver needs to understand what the alert is suggesting and the reason this suggestion was made. The alert stimulus must first be perceived through the interface, as well as information regarding the corresponding state. For example, the state of the alert could be binary (on or off), or it could consist of multiple thresholds which correspond to a range of system states. In either case, the driver needs to understand the circumstances that caused the alerting system to activate. The driver is typically monitoring the environment for hazards, and must therefore integrate this new information into the ongoing driving process. The driver may have already been aware of the hazard, in which case the alert is redundant, or the hazard was not detected by the driver, in which case the driver must decide whether or not the source of the alert must be verified. If the driver trusts the system, then it may not be necessary to understand why the alert was issued; otherwise, the driver must then identify the location of the hazard by visually scanning the environment or by using information provided through the FCWS display. If necessary, an evasive course of action is chosen and executed, after which the driver recovers from the incident.

2.4. Kinematic Assessment

The display/automation requirements must account for the dynamic constraints of the system elements. Time is a limiting factor when alerting the driver: if collisions are to be avoided, alerts must be provided early enough for the driver to respond appropriately. The state-space representation proposed by [5] more clearly illustrates this concept (Figures 2-4, 2-5).

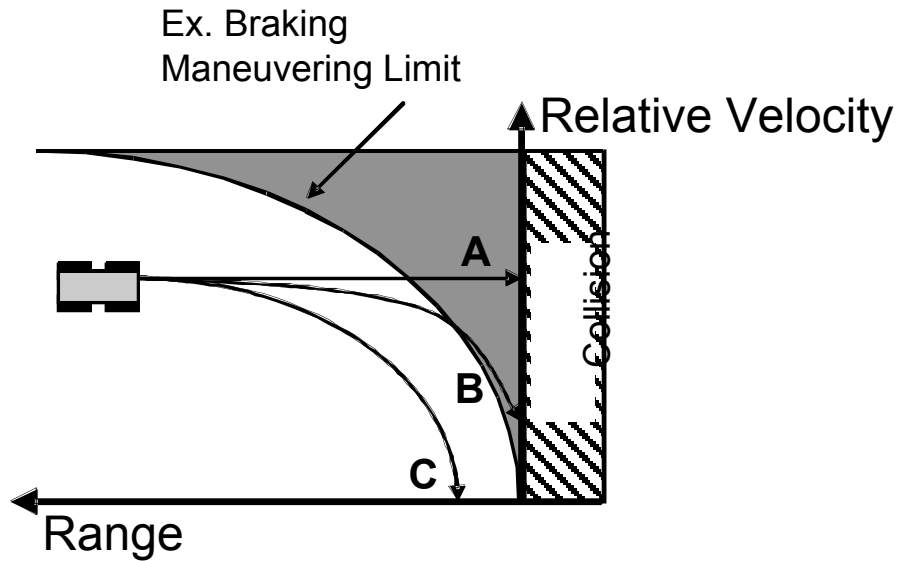

Figure 2-4: An example state-space representation of collision avoidance (braking to stop).

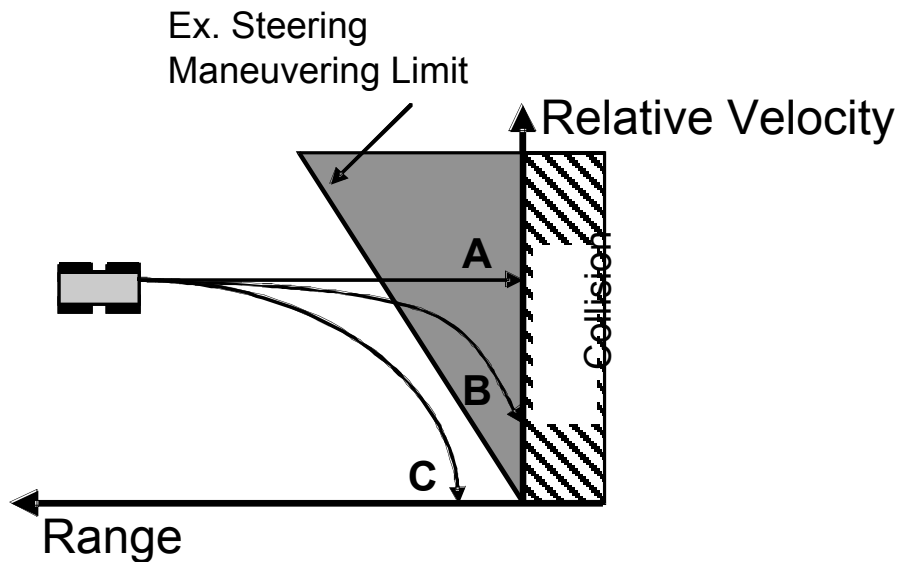

Figure 2-5: An example state-space representation of collision avoidance (steering to avoid).

Each axis corresponds to a variable that describes a relative dynamic state of the system, such as range (distance from the hazard) or relative velocity (range rate of change). The vehicle state is represented as a location within the *state-space* defined by these two variables, and *state trajectories* describe the vehicle's change in location over time. The *hazard space* is a region in which, if entered, a collision will occur—in this case, when range equals 0. The *maneuvering limit* is a region in which, if entered, the vehicle will

unavoidably cross into the hazard space (trajectories A and B). For example, a vehicle that does not begin braking or turning at a sufficient range will ultimately collide with the hazard depending on their respective inertial constraints. Relative velocity at impact and the severity of the collision may be reduced, but an accident will still occur (trajectory B). The inertial constraints and the chosen evasive maneuver will dictate the shape of the boundary: in Figure 2-4, stopping distance is proportional to the square of the relative velocity, thus forming the parabolic curve; in Figure 2-5, assuming that the amount of time to make an evasive steering maneuver is constant, the distance over which the maneuver is performed increases linearly with speed. A driver whose evasive maneuver does not surpass the maneuver limit will successfully avoid the hazard (trajectory C). *Successful avoidance* is defined as the moment when relative velocity reaches zero before a collision has occurred. At this point, range is no longer decreasing and an infinite amount of time remains before a collision.

Alerting thresholds and the maneuvering limit are defined similarly, in that both specify a boundary that describes a particular set of dynamic states (Figure 2-6). Because the alert is designed to help the driver avoid collisions, the threshold is set so that the driver will be alerted prior to reaching the maneuver limit—how much prior is a design issue. For the FCWS, timely alerts must be available for all manner of potential forward collisions, from the most typical, to the most (reasonably) extreme.

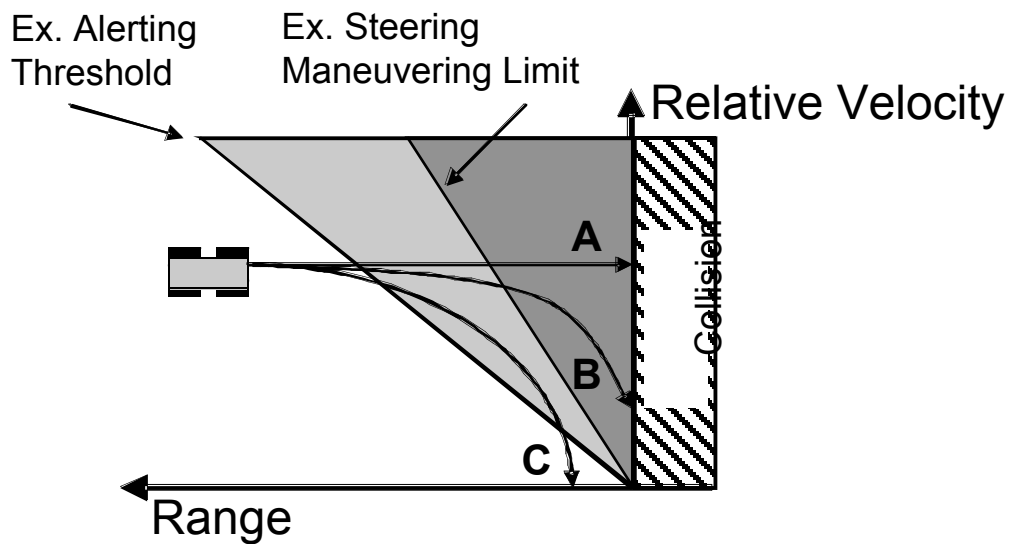

Figure 2-6: An example state-space representation, including a notional alerting threshold.

2.4.1. Example: Stopped Object on a Highway

Consider a stopped object on a highway, such as another vehicle or piece of debris. Assume that the driver's vehicle is traveling at 60 mph (88 ft./sec.) and can decelerate at 0.8 g's (25.8 ft./sec.²). Assume that there is no opportunity to steer around the hazard, and the driver is forced to come to a complete stop. Equations 1 through 3 are derived from simple kinematics:

$$t_{\text{stop}} = \frac{v_{\text{initial}}}{a} \quad (1)$$

$$d_{\text{stop}} = \frac{v_{\text{initial}}^2}{2 \cdot a} \quad (2)$$

$$d_{\text{maneuver}} = v_{\text{initial}} \cdot t_{\text{reaction}} + d_{\text{stop}} \quad (3)$$

According to Equation 1, the driver will decelerate to a stop in 3.4 seconds (t_{stop}). This is the maneuvering limit—if the driver begins braking when a collision will occur in less than 3.4 seconds, there will not be enough time to stop and avoid the accident. The alerting threshold must also provide the driver enough time to assess and respond to the alert prior to performing the stop. The time required to make an assessment is not known, but as mentioned in Chapter 1, the reaction time is influenced by trust in the FCWS, driver distractions, and the salience of the hazard. Assuming the driver makes a rapid assessment, response time is assumed to be 1.5 seconds (t_{reaction}) [28]. If lack of trust prompts the driver to verify the hazard, response time will increase with this assessment. Likewise, if the hazard is not salient, the driver will require more time to identify the hazard. The best-case scenario already shows that the evasive maneuver will take 4.9 seconds and a distance of 284 feet (with an additional 88 feet added for every second needed to assess the alert, according to Equation 3).

Now, instead of decelerating to a stop, suppose the driver imparts a lateral acceleration of 0.5 g's (16.1 ft./sec.²) and steers around the hazard. If the hazard is approximately the size of another vehicle, assume that the driver must move laterally 10 feet to avoid an accident. Figure 2-7 shows a simplified representation of the steering response.

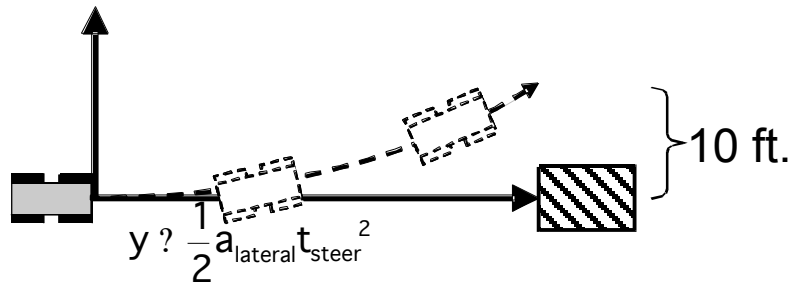

Figure 2-7: A simplified representation of an example steering response.

The y-axis corresponds to the vehicle's lateral position and the x-axis corresponds to the range, both with respect to the hazard. The lateral maneuver will require 1.1 seconds, and in that time, the driver will have traveled 97 feet closer to the hazard (assuming forward velocity is constant). Assuming a response time of 1.5 seconds, the lateral maneuver will take 2.6 seconds and 229 feet, saving both time and distance when compared to the stopping maneuver. Steering around the hazard is a better option because it can be completed faster, but it is only effective if necessary space is available. Alerting earlier provides more time in which to assess a situation, which supports the awareness of the surrounding environment and assists the driver in choosing the best evasive maneuver.

This example scenario is not comprehensive but illustrative of the limits to which the FCWS must be designed. Drivers may, in fact, respond more mildly than the assumed acceleration and deceleration values of these examples. Reaction time will also vary, and instead of 1.5 seconds, a distracted, unaware, or skeptical driver could take as long as 3 or 6 seconds to respond. Figures 2-8 and 2-9 illustrate the maneuver limits for avoiding a stopped object by braking and by steering, assuming a deceleration of 0.8 g's and a lateral acceleration of 0.5 g's.

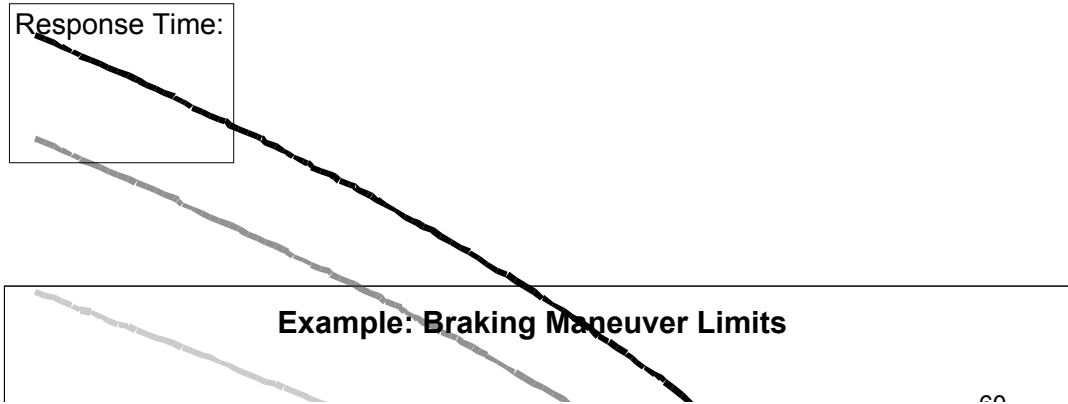

Figure 2-8: Example: braking maneuvering limits for response times of 1.5, 3.0, and 6.0 seconds.

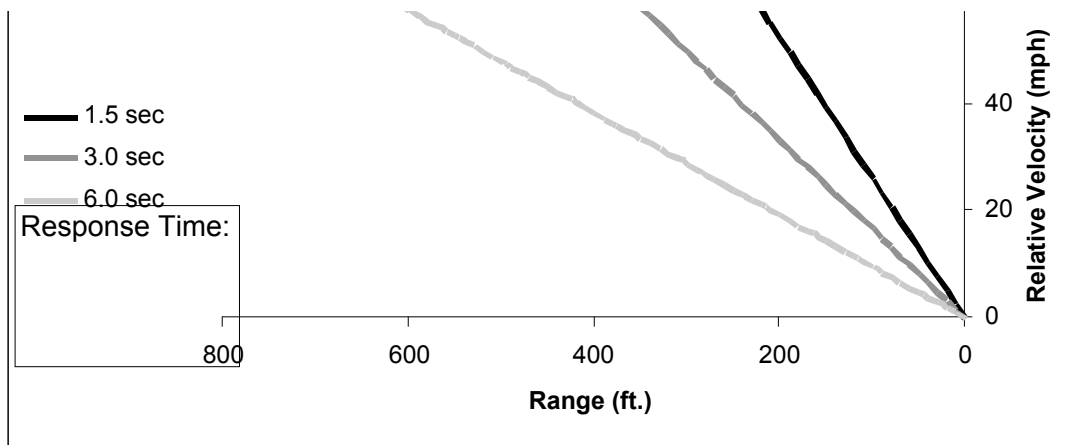

Figure 2-9: Example: steering maneuver limits for response times of 1.5, 3.0, and 6.0 seconds.

To avoid an accident, a driver who responds in 3 seconds, as opposed to 1.5 seconds, would need to be alerted 420 feet from the hazard to avoid a collision (an increase of 130 feet). The steering response limit increases similarly with a 3 second reaction (365 feet as opposed to 230 feet). A reaction time of 6 seconds or more further increases the required alert distance, which will increase the number of unnecessary alerts. Decreasing the driver's response time allows the thresholds to be set closer to the hazard.

2.4.2. Time-to-Collision Alerting Thresholds

If the vehicle's current trajectory will intercept a hazard, the time-to-collision (TTC) value represents the amount of time before a collision will occur, given the current dynamic states of both the vehicle and the hazard (Equation 4).

$$TTC = \frac{\Delta \text{Distance}}{\Delta \text{Velocity}} = \frac{D_{\text{Driver}} - D_{\text{Hazard}}}{V_{\text{Driver}} - V_{\text{Hazard}}} = \frac{\text{Range}}{\text{Relative Velocity}} \quad (4)$$

This relationship between range and relative velocity is also equivalent to the slope between any point on the state trajectory and the origin as represented in the state-space diagram. Referring to the example of a stopped object on a highway, Table 2-1 describes the TTC values at which the driver would need to be alerted, assuming response times of 1.5, 3.0, and 6.0 seconds. Figures 2-10 and 2-11 display these notional thresholds in reference to the maneuvering limits on the state-space representation.

Table 2-1: Alerting threshold TTC values for 1.5, 3.0, and 6.0 second response times for evasive braking and steering maneuvers for an assumed maximum initial speed of 60 mph.

Maneuver:	Response Time:		
	1.5 sec	3.0 sec	6.0 sec
Braking to stop (0.8 g deceleration)	3.2	4.8	7.2
Steering to avoid (0.5 g lateral acceleration)	2.6	4.1	7.1

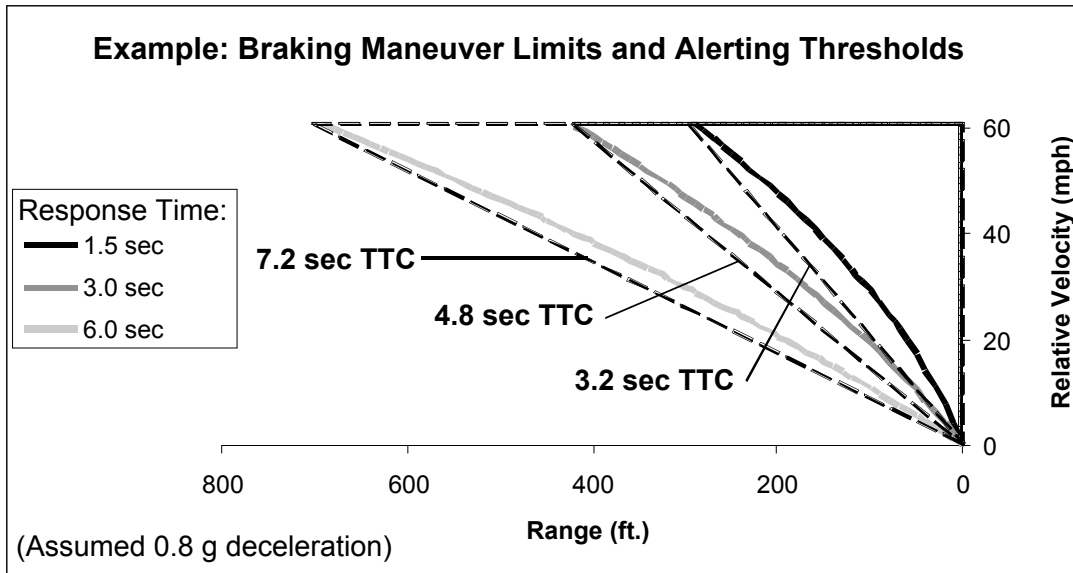

Figure 2-10: Example braking maneuver limits and corresponding notional alerting thresholds.

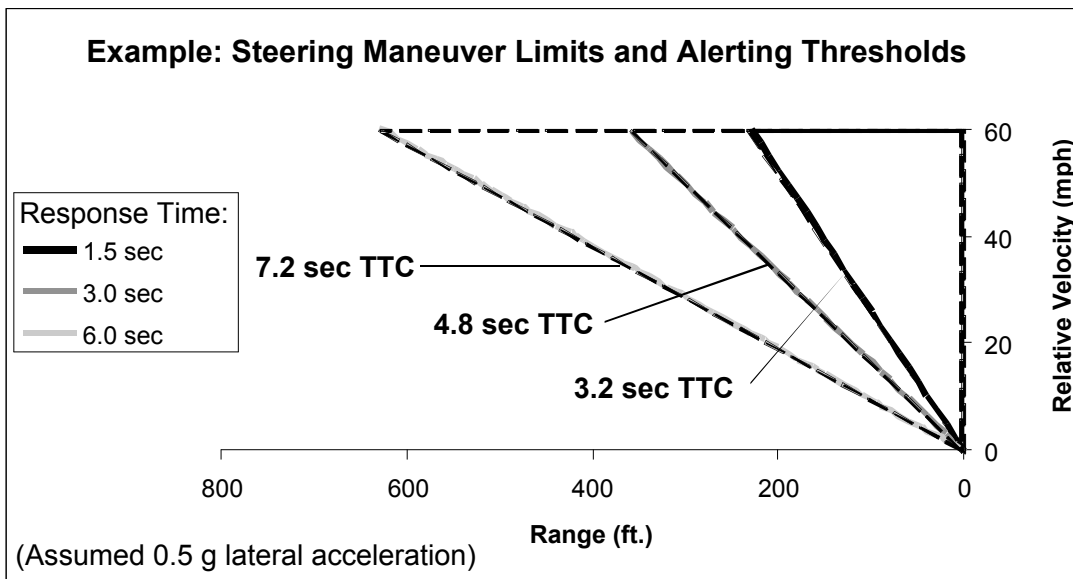

Figure 2-11: Example steering maneuver limits and corresponding notional alerting thresholds.

The uncertainty in the future system state causes false hazard identifications at impractically distant TTC values. Considering the proximity of motor vehicles on a roadway, as well as the speed with which speed and trajectory can change, alerting at high TTC thresholds will cause frequent unnecessary alert activations. If the driver's response time is decreased, a successful maneuver will not depend on an alerting threshold that causes an unacceptable frequency of unnecessary alerts.

2.4.3. The System Operating Characteristic Curve

This fundamental tradeoff between providing the driver more time in which to respond and alerting the driver unnecessarily is formalized in an analytical model called the System Operating Characteristic (SOC) curve [5, 29]. The SOC curve is constructed much like a Receiver Operator Characteristic (ROC) curve in signal detection theory in that for any time at which an alert is issued, the curve simultaneously represents the probabilities that the alert is both successful (signal) and unnecessary (noise). The curve is constructed by plotting the probabilities of multiple alert thresholds at various times or distances from the hazard (Figure 2-12). SOC curves are more comprehensive than ROC curves, however, because they encapsulate all components of the system that influence performance, such as the sensors, prediction algorithms, and operator reaction. For a FCWS, the system would also include the driver's perception of the alert, the assessment of the potential hazard, and the subsequent evasive maneuver.

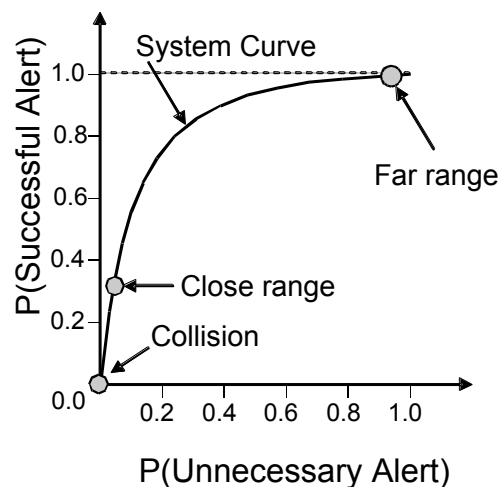

Figure 2-12: An example SOC curve.

As the alerting threshold is set farther away from the driver, the probability that an alert is unnecessary increases because the hazard will likely be avoided had the alert not been provided. On the other hand, an unnecessary alert is also considered successful because, by definition, no collision occurs. However, as the threshold is placed closer to the driver, the probability of a successful outcome decreases because the driver has less time and distance in which to assess the alert and avoid the hazard.

At close thresholds, the alerting system is confident that the driver is about to unwittingly collide with another vehicle or object, but the driver has not been given adequate time to respond appropriately.

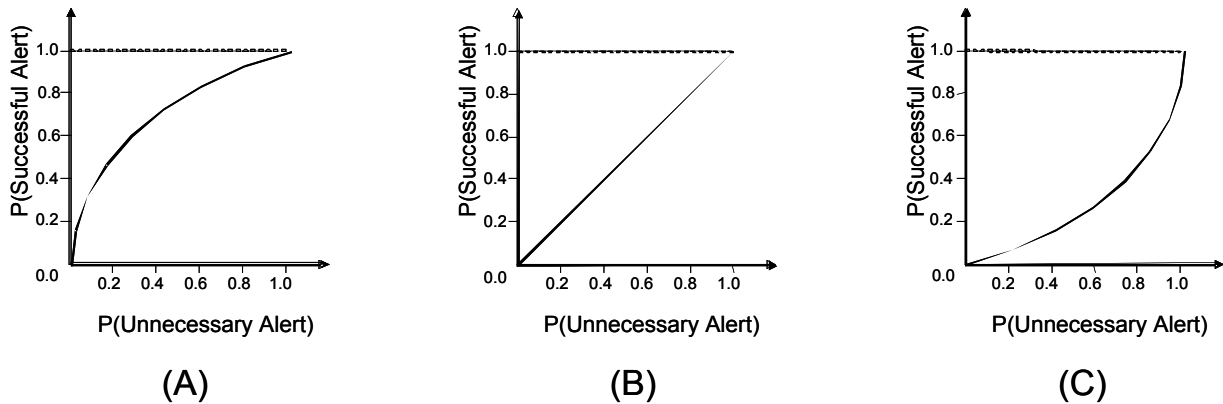

Figure 2-13: Various degrees of system benefit as expressed by the SOC curve.

An ideal system will operate in the upper left-hand corner, where all alerts are 100% necessary and successful. Curves that are closer to this point represent systems that are more effective than those with curves that are farther away. For example, consider Figure 2-13: (A) shows a positive system benefit (the probability of influencing a successful response is greater than probability that the alert is not useful); (B) shows a neutral performance (an alert is just as likely to be successful as it is unnecessary); and (C) shows a negative system benefit (the driver is more likely to avoid an accident without the system). The SOC curves are not static, and can change based on environmental conditions, the driver's acceptance of the system, and other factors that influence the effectiveness of the FCWS. A system that quickly annoys the driver with an excess number of false alerts will lose the driver's trust, and may shift to reflect a more neutral curve as the driver chooses to ignore the warnings. Likewise, a system may represent a negative system benefit if it distracts the driver during a critical maneuver and, in fact, causes an accident.

From these representations of system behavior, the placement of the alerting thresholds is chosen based on the costs both of a missed detection and of an unnecessary alert. For example, the cost of a missed detection could be considered the increased probability that a collision will occur, whereas the cost of an unnecessary alert could be the reduced system effectiveness resulting from the driver's loss of trust. The

slope of the SOC curve is equivalent to the ratio of these costs, with the optimal point of notification where the two costs are equal. If the costs are quantifiable, this point occurs when the slope of the curve is equal to 1 (Equation 5) [5]. This is consistent with the SOC representation: if the cost of a collision is infinity (missed detections are to be avoided at all costs and the cost of an unnecessary alert is negligible), an alerting threshold for a beneficial system (Figure 2-13.A) will be placed as far to the right as possible, where the slope of the curve is horizontally asymptotic. More time in which to react is, in most cases, beneficial, but the high frequency of unnecessary alerts will begin shifting the curve to resemble Figure 2-13.B. The constant slope indicates that at this level of performance, it does not matter when the driver is alerted since collisions are just as likely to be avoided with or without the system. If the FCWS then begins to exhibit a negative benefit (Figure 2-13.C), the driver should not be alerted because this would risk causing an accident.

$$\frac{C(\text{unnecessary alert})}{C(\text{missed detection})} = 1 \quad (5)$$

2.5. Proposed Design Features

2.5.1. Multi-Stage Alerting

A multi-stage alerting configuration that alerts the driver at earlier, more conservative thresholds will provide more time in which to respond and increase the probability of a successful maneuver. Given the SOC curve in Figure 2-14.A, it is not probable that a system will successfully alert the driver when sufficient evidence indicates that a collision is about to occur. If the system were to, instead, issue an earlier, minimally obtrusive alert when the likelihood of a collision is still low, but possible, the driver will be conditioned to respond more quickly (for example, within 1.5 seconds) and appropriately if and when evasive action is necessary. An earlier threshold does not alert the driver when the situation requires a last-second response; instead, knowing that a crash is possible, the driver may reduce speed, turn slightly, or perform a similar low-level maneuver. Evasive maneuvers of greater magnitude decrease the probability of a successful response because the driver is more likely to lose control of the vehicle or lose awareness of obstacles in the surrounding environment. The conditioning of the driver at an earlier threshold ensures an, earlier,

controlled, appropriate response that increases the probability that the alert is successful, and shifts the SOC curve closer to the ideal operating point (Figure 2-14.B).

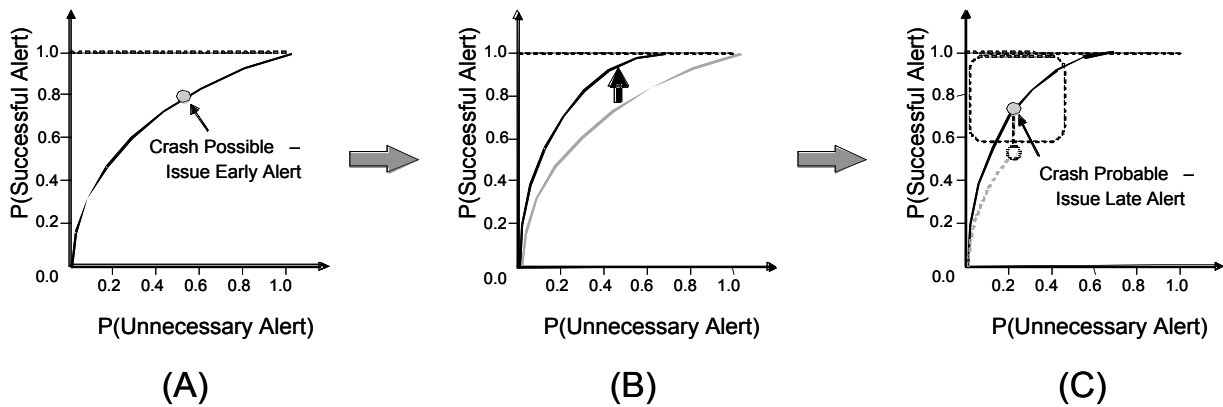

Figure 2-14: An SOC curve representation of the benefits of multi-stage alerting.

If the situation continues to pose an imminent threat, the system can issue a more serious alert in a region that maintains a desired probability of success as well as the desired confidence that the alert is necessary (indicated by the box in Figure 2-14.C). Had no conditioning occurred, and the system remained on the original curve, the probability that the driver would have successfully avoided the hazard would be significantly decreased. If only the late alert is issued, it is not certain the driver will be able to respond quickly enough to avoid a collision, especially if he or she is distracted or momentarily skeptical that a response is necessary.

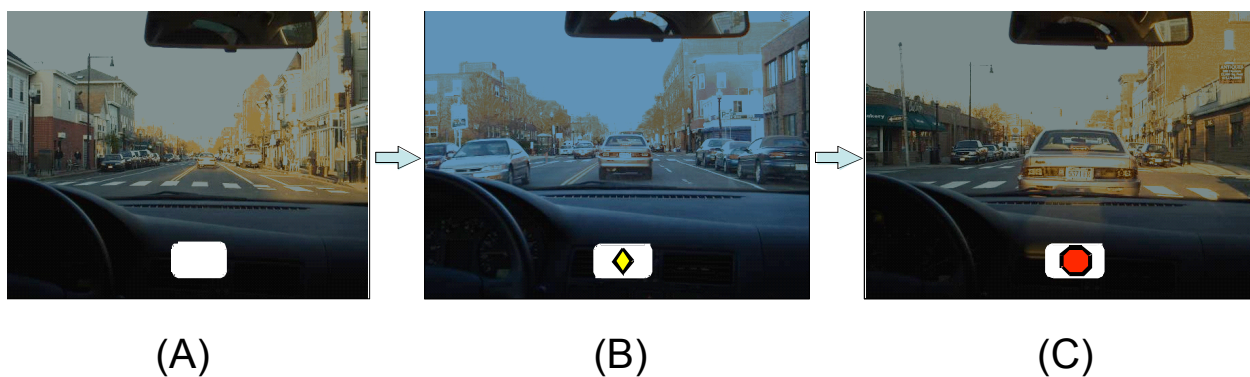

Figure 2-15: An example implementation of a multi-stage alerting configuration.

A multi-stage FCWS configuration will not be consistently beneficial if the driver cannot tolerate the increased frequency of unnecessary alerts. The early alert is not intended to prompt an immediate evasive maneuver, therefore the alerting interface

should not imply as such. An obnoxious stimulus will annoy and distract the driver if frequent alerts are not necessary. A less obtrusive, advisory alert will mitigate this problem. Figure 2-15 demonstrates an example implementation of a multi-stage alerting system with an in-dash display. In (A), the TTC value with respect to the lead vehicle has not crossed the early threshold, and no alert is currently displayed. As the lead vehicle slows down, an advisory alert activates, informing the driver that a crash is possible (B). As the lead vehicle stops, and the TTC value decreases, the late alert activates, indicating that an immediate response is necessary to avoid a collision (C). The late alert is designed to be much more visually conspicuous, and for example, could be accompanied by an audio alert.

2.5.2. Directional Alerting

A system that alerts earlier and more often is also more likely to be accepted if the driver understands why the alert is issued, even if it is unnecessary. Directional alerting directs the driver's attention to the location of the hazard that caused the alert activation, which promotes trust in the FCWS by showing the driver the motivation for the system's judgments (Figures 2-16 – 2-18). Explicitly pointing to the hazard's locations also decreases the amount of time that is required to scan and verify the cause of the alert. For example, with earlier alerting thresholds, there may be situations in which the hazard is not obvious to the driver, either because it is too far away or the changes in the environment are too subtle to notice. This ambiguity can be exaggerated by lack of awareness [30], which would result in longer assessment times. By indicating the location of the hazard via the alerting display, ambiguity is more quickly resolved.



Figure 2-16: An example implementation of multi-stage directional alerting (1 of 3); locational stimulus highlights objects in the environment (diamond and octagon on windshield).

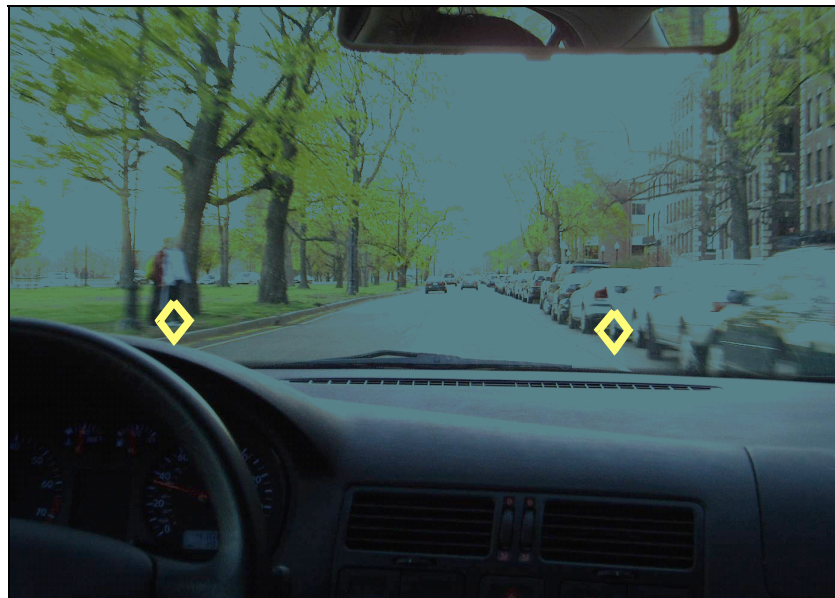

Figure 2-17: An example implementation of multi-stage directional alerting (2 of 3).



Figure 2-18: An example implementation of multi-stage directional alerting (3 of 3).

Earlier alerting also provides an ancillary benefit: it confirms the system is working. The probability that any particular driver will have an accident is fairly low for any given trip. Although it is fortunate that collisions and the events leading up to collisions are infrequent from an individual driver's point of view, this does not provide many opportunities to truly benefit from the FCWS or develop an understanding of how it works. Anti-lock brakes encounter similar problems: they lie dormant until absolutely needed, denying drivers the frequent exposure that would otherwise build this understanding. Directional alerting mitigates the undesired driver reactions that would otherwise make frequent exposure detrimental and transforms an ambiguous notification into an advantageous situation assessment aid. For instance, assume an oncoming vehicle steers into the driver's lane while passing another vehicle. The FCWS identifies the oncoming vehicle as a hazard for the few seconds it remains in front of the driver. The subsequent alert is technically unnecessary, because no collision occurs after the vehicle completes the pass; however, the alert is useful in maintaining the driver's awareness of the environment, and if the situation had become more dangerous, an aware driver would be conditioned to respond more effectively.

3. Experimentation

Several collision alerting displays were emulated within a driving simulator and combined to form FCWS configurations that incorporated directional and multi-stage

alerting. Subjects were then equipped with the various systems, and asked to complete test scenarios which placed them in multiple hazardous situations that would result in a collision if no response was made. All hazardous events were designed to present the driver with similar event dynamics to allow comparison across different events during which different system configurations were in effect. Subjects were asked to follow several objectives in priority order that emphasized the primary goal of collision avoidance. Controlled driver distractions were introduced through secondary tasks, as well as with the design of visual elements within the driving environment. Subjective data was collected after the testing was completed.

A pilot study was conducted prior to this experiment, through which the alerting displays, alerting thresholds, driving environment, hazardous situations, and experimental protocol were improved and refined. The pilot study results indicated several promising trends in support of multi-stage and directional alerting. These results motivated the main experiment, and were ultimately reproduced with more statistical power. Although integral to the design of the main experiment, the pilot study will not be discussed in this thesis.

3.1. Hypotheses

Three hypotheses were tested:

- H₁: When drivers are alerted to potential collisions, they will respond more effectively than when they are not alerted.
- H₂: When drivers are provided earlier alerts, in addition to late alerts, they will respond more effectively than when they receive only late alerts.
- H₃: When drivers are provided directional early alerts, they will respond more effectively than when they receive non-directional early alerts.

The first hypothesis pertains to the absolute benefit of alerting vs. no-alerting, and the second two hypotheses address the proposed designed features of multi-stage and directional alerting.

3.2. Experimental Design

The study is designed to examine a single fixed factor (the FCWS configuration) across four levels (Figure 3-1). Each subject was exposed to all of the FCWS configurations, and each configuration was active for two consecutive threat events. The experiment was designed as a repeated measures study, and therefore the order of treatments was randomized, as was their assignment to the subjects (see Appendix A for a summary of the treatments).

Alerting System Configuration:	
No Alerting	T1
Late Alerting Only	T2
Early Non-Directional + Late Alerting	T3
Early Directional + Late Alerting	T4

Figure 3-1: The experimental design: 1 fixed factor across 4 levels, representing 4 treatments.

There are numerous variables whose values were recorded at each time step within the simulator. Variables that pertained to the driver's vehicle include distance driven, velocity, brake input, accelerator input, yaw rate, steering wheel angle, steering wheel angle rate, and number of collisions. There were variables that indicated the current threat event in which the data was being recorded as well as the alerting system configuration that was currently in effect. The on/off states of the early and late alerts were also tracked, regardless of the alerting system configuration. Even though not all the systems displayed late and/or early alerts to the driver, the simulator still recorded the times at which the alerting thresholds were crossed. When the thresholds were crossed, additional data was saved that identified the unique vehicle ID number, the range between the hazard and the driver's vehicle, relative velocity, and the TTC value. From this information, the dependent variables that were analyzed include:

- Hazardous event outcome.

-
- Percentage of collisions given hazards.
 - Percentage of successful outcomes given late alerts.
 - Response times.
 - Response behavior.
 - Secondary task performance.
 - Responses to unnecessary alert activations.
 - Subjective responses targeting trust, acceptability, and confidence in the FCWS.

3.3. FCWS Configurations

3.3.1. Alerting Displays

Three FCWS alerting displays were emulated within the driving simulator: a late alert, a non-directional early alert, and a directional early alert. Directional alerting is only implemented for the early alerting threshold because it is assumed that by the time the late alert activates, the hazard will be immediately apparent and the driver will not need assistance in identifying its location. The late alert display consists of a yellow bar that appears across the length of the dashboard as well as an audio file that has been previously designed for an automotive collision warning application (Figure 3-2). The non-directional early alert is represented as a fixed yellow frame above the dashboard (Figure 3-3). This icon does not move, and functions similarly to a light turning on or off when the early alert threshold is crossed. The directional early alert is similar to the non-directional display, except that the frame overlays the hazard that caused the alert and continuously changes position to remain fixed on the hazard (Figure 3-4). The alerting displays were combined to form three alerting system configurations: *Late Alerting Only* (the least amount of support), *Early Non-Directional* plus the late alert, and *Early Directional* plus the late alert (the highest amount of support). There was a null configuration as well, in which no alerting was provided (*No Alerting*). The hazardous situations were exclusively designed to involve vehicles (including cyclists); therefore, the FCWS was not set to monitor pedestrians and miscellaneous objects. The system configurations were also not intended to issue multiple, simultaneous alerts, but the testing did not require this capability.



Figure 3-2: The late alert display (without the audio).

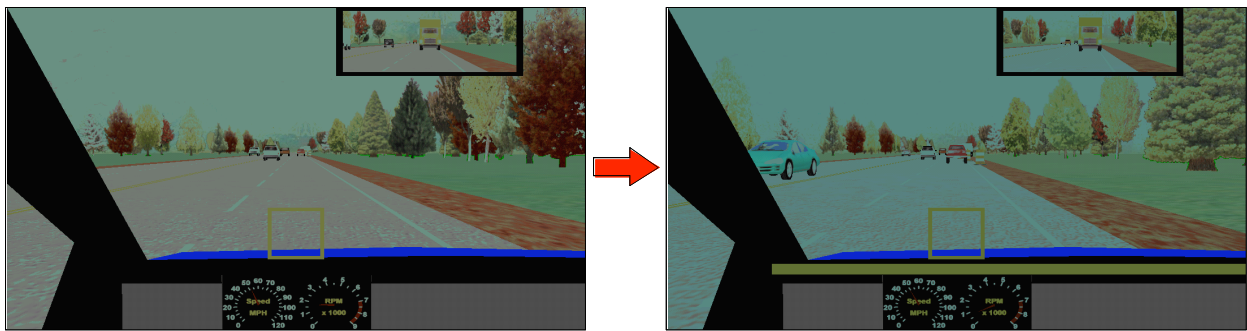

Figure 3-3: The Early Non-Directional system configuration with (right) and without the late alert.

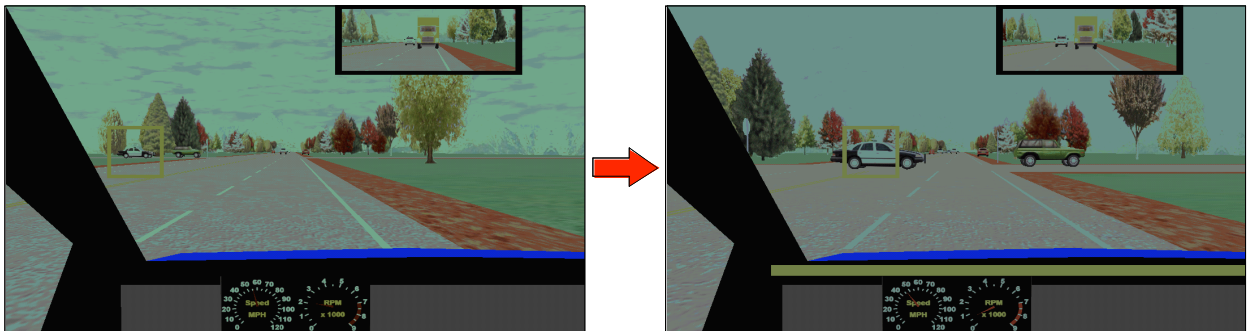

Figure 3-4: The Early Directional system configuration with (right) and without the late alert.

3.3.2. Alerting Thresholds

The alerting thresholds are defined by TTC values (see Section 2.4.2). Although simplified, studies have demonstrated the effectiveness of this threshold criterion [31]. TTC successfully captures the ways in which the situation dynamics change as both the speed of the driver's vehicle and the hazard vary, as opposed to alerting at an absolute distance from the hazard. There are more sophisticated alerting algorithms, but many are based on variant forms of TTC [32-36]. Previous studies have implemented a semi-continuous alerting scheme [37, 38], but the study is specifically designed to examine a change in performance that may result from conditioning the driver with a single conservative, early alert. Therefore, the FCWS configurations employ two thresholds: an early alert set farther from an impending collision and a late alert which is set closer. The late alert threshold is defined as the moment at which action is necessary, after which a collision will occur if the driver does not respond shortly thereafter.

The alerting threshold TTC values were set according to the example in the kinematic analysis (Section 2.4). The late alert threshold was set to 2.4 seconds TTC, which is consistent with the amount of time required to perform an evasive maneuver that includes both braking and steering, assuming an immediate response at 60 mph. The early alert threshold was set to 5.4 seconds TTC, midway between the necessary TTC thresholds assuming a response time between 1.5 and 6.0 seconds.

The algorithms that were constructed from these thresholds continuously examined the positions of the driver's vehicle and of various hazards in the environment and calculated the amount of time that remained until the two positions intersected, i.e., the TTC value. If this value fell below 5.4 seconds TTC, the early alert display would activate (if the assigned system configuration incorporated an early alert). Likewise, if the value fell below 2.4 seconds TTC, the late alert display would turn on (if applicable).

3.4. Simulated Environment

3.4.1. Simulated Vehicle and Driving Environment

The subjects were provided a simulated blue compact passenger vehicle with which to complete the testing. The vehicle could decelerate at a maximum of 0.8 g's, and accelerate at a maximum of 0.35 g's. The maximum speed was 65 mph, and the

transmission was automatic. Subjects were provided a rear-view mirror, an analog tachometer, and an analog speedometer, but no secondary driving controls such as turn-signals.

All driving occurred on a simulated four-lane, high-speed rural road with 12 foot lane widths and no median. The driver was asked to maintain a speed between 55 and 60 mph throughout the testing and training. For simplicity, the scenarios assumed ideal visibility and road conditions; no artificial fog was added and vehicle dynamics were not adjusted to simulate wet or icy roads. Scenery elements included trees and speed limit signs, but no buildings or pedestrians. A continuous stream of oncoming traffic was placed on the opposite side of the road, and surrounding traffic was positioned around the driver. There were cross-roads with two-way stop signs, at which stopped vehicles were randomly placed. Stationary vehicles and moving cyclists were positioned randomly along the shoulders of both sides of the road. The driver always had the right-of-way and was never required to stop. There were no traffic lights or other road elements that required the driver to slow down. The driver was occasionally required to change lanes at certain locations within the scenario, and was informed when to do so.

3.4.2. Controlled FCWS Activations

Each testing scenario was designed to place the driver in hazardous situations that would result in a collision if the driver did not respond. These *threat events* concluded with an accident only if the driver was not aware of the potential collision, or if the driver's response was not sufficient in avoiding the hazard. The timing of these events is not trivial. Comparisons amongst the collision warning systems would be difficult if not all subjects were exposed to the systems they were provided. If the driver never crosses the early alerting threshold, the early alert will never activate. The situation cannot be so mild and transparent that the resultant conservative behavior never produces the desired system activations; on the other hand, the situation cannot be designed so that it induces an artificial, unavoidable collision. Also, the dynamics of the event must allow the driver to cross the early alert threshold with enough time to perform an evasive response before crossing the late threshold.

It is not possible to present the driver with one threat event multiple times without severely biasing the driver's response during the subsequent, identical events. However, it is not always cost effective to conduct a study in which data is only collected from a single response to one threat event. To maximize the amount of data, while maintaining the validity of the findings, the driver was exposed to several unique threat events that were designed to exhibit similar event dynamics. For example, every threat event introduced a hazard that was visible when the early alert threshold was crossed (if not before), and remained visible until a collision occurred or was avoided. The events were also designed such that when the early alert threshold was crossed, the driver had 5.4 seconds to respond before a collision would occur. The consistency of the threat event dynamics allows comparisons of driver behavior among the events, while the uniqueness of each event permits multiple exposures and promotes a more statistically powerful analysis.

The threat events were selected based on concurrent studies, past research, and an analysis of plausibility [39-41]. To maintain consistency, all events occurred on straight sections of roadway and did not extend into any curves. The distances at which the threat events were activated were consistent for all the subjects. If the subject did collide with the hazard, there was no immediate feedback and the scenario continued without stopping to allow the subject to complete the testing. The following threat events (TE's) were included (see Appendix B for a compilation of illustrations):

TE1: Construction blocks the driver's lane, uncovered by a lead vehicle.

TE2: An oncoming vehicle turns left in front of the driver, blocking the lane.

TE3: A vehicle on the side of the road, initially stopped, pulls into the driver's lane.

TE4: A police officer chases another vehicle across the driver's lane from the left.

TE5: A slow-moving cyclist enters the driver's lane from the right-side of the road.

TE6: With an accident scene in the left-hand lane, an ambulance crosses the driver's lane from the right.

TE7: A vehicle, sitting at an intersection and hidden by a larger vehicle, makes a right-hand turn into the driver's lane, cutting off the driver.

TE8: A lead vehicle decelerates because of slow moving traffic further up the road.

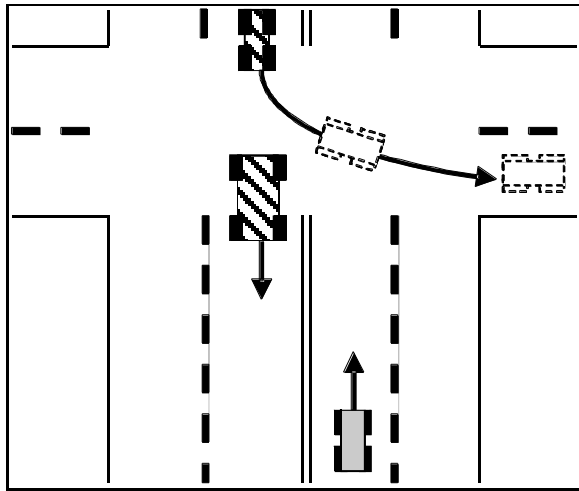

Figure 3-5: TE2 example illustration: Oncoming vehicle turns left in front of the driver.

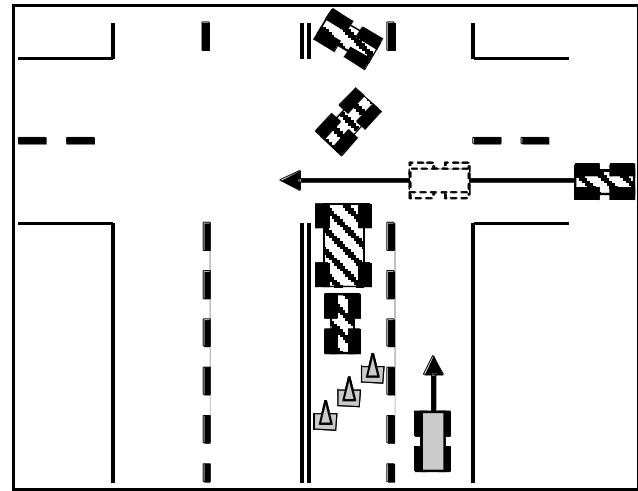

Figure 3-6: TE6 example illustration: With an accident in the left-hand lane, an ambulance crosses the road from the right.

The threat events were designed to allow within-subject comparisons amongst the FCWS configurations, although particular events may elicit unique driver behavior that is not seen during the other events. The eight threat events were evenly grouped into four categories based on their dynamics: *Non-Moving Obstruction* (TE1, TE2); *Moving Obstruction, Initially Stopped* (TE3, TE7); *Moving Obstruction, Initially Moving* (TE5, TE8); and *Lane Crossing* (TE4, TE6). Within each category, driver behavior was examined between the subjects for each of the systems configurations.

Unnecessary system activations were programmed into the simulator to offset a response bias that drivers may have if they only received alerts when a collision was about to occur. The subjects were told before the testing that the system may activate in the absence of a threat. These nuisance alerts were only provided for the early alerting displays, and not for the late alert. Two unnecessary activations were included, one for each of the early alerting system configurations. Both activations were ambiguous false-positives, and did not alert the driver to any particular hazard. All unnecessary alert activations occurred during curved sections of roadway. When the Early Non-Directional alerting display was in effect, the icon appeared on the screen, while the Early Directional system's frame highlighted a fixed location on the side of the road. The first unnecessary activation was always provided in between the two threat events for which the first early alerting system configuration was in effect. The second false

positive was always given before the two threat events for which the second early alerting system configuration was in effect.

3.5. Participants

Twenty-four graduate and undergraduate students at the Massachusetts Institute of Technology voluntarily participated in the study, 16 male and 8 female. The average age was between 25 and 26, while the minimum and maximum ages were 19 and 33 respectively. On average, the subjects had between 8 and 9 years of driving experience, with a standard deviation of approximately 4 years. All subjects specified that the majority of their driving, as well as their most recent driving experiences, were on the right side of the road (see Appendix C for demographic visualizations). The validity of the study depended upon each subject having no prior knowledge regarding the experiment—those who had witnessed previous testing sessions or had been shown explicit examples of the scenarios during development were not asked to participate. There are 24 permutations of the four FCWS configurations; therefore, the study was counterbalanced across 24 subjects.

3.6. Experimental Procedure

Each one hour session included an introductory briefing, a 10 minute training scenario, two 10 minute testing scenarios, and a follow-up briefing. During the introduction, participants were first asked to sign a consent form that explained the purpose of the study and their rights as test subjects. The subjects familiarized themselves with the positions of the driving controls, which were adjusted until comfortable. They were then explained the tasks they were expected to complete during the course of the testing, as well as the objectives they needed to maintain while completing them.

3.6.1. Training Session

The purpose of the training session was to familiarize the subject both with the control of the simulated vehicle and the environment in which the subject would be driving. Each subject was exposed to all of the alerting system configurations during

threat events that were designed specifically for the training scenario (a lead vehicle pulls off the road to uncover a stopped vehicle in the driver's lane). This exposure promoted a more realistic integration of the alerting system since drivers will be aware of the FCWS with which their vehicles are equipped. However, this prior experience eliminates the naïve response that probes the driver's natural, instinctual reaction to the alerting display. To preserve this response, the subjects were not initially informed that they were provided an alerting system until after experiencing the first threat event during the training. Afterwards, the alerting configurations were explained, and the driver was exposed to the same threat event four additional times (repeating the system that was active during the initial exposure, in addition to the other three systems). The Late Alerting Only system configuration did not display an early alert, and the No Alerting configuration did not display anything, but both were included for completeness and to give the driver a sense of the differences among the systems. If the driver responded before the late alert threshold was crossed, he or she was asked to artificially induce a late alert before the training session was finished. The naïve exposure was counterbalanced among the three FCWS configurations, and did not include the No Alerting configuration. The subsequent order of exposure to the other systems was randomized and counterbalanced (Appendix A).

The training protocol was designed such that the subjects came to a complete stop at least once within the scenario. The purpose of these stops was to provide the driver an opportunity to experience both the deceleration of the vehicle and the sensitivity of the brakes. The stops were also meant to screen for subjects who may have been prone to simulator sickness, and unable to have completed the entire testing session. Other driving simulation studies have used this technique to identify subjects who may have not previously had the opportunity to discover their susceptibility to an otherwise latent sensitivity [42].

3.6.2. Testing Sessions

Each testing scenario included two threat events per FCWS configuration. Only one alerting system was active at any point in time, and the driver was informed as to which system was currently in effect by pre-recorded audio prompts that played at

specific distances within the simulator. The sequence of threat events was consistent for each subject.

Subjects were asked to follow several objectives in priority order during the testing. A sheet containing the following list was placed in front of the driver and was visible throughout the session (“1” being the highest priority):

1. Do not crash into another vehicle or object.
2. Stay on the road.
3. Stay in designated lane, unless instructed otherwise.
4. Maintain designated speed (do not get a ticket).
5. Identify police officers.
6. Complete the map-reading task.

Subjects who asked how they should respond to avoid a potential collision were referred to the priority list, and the number one priority was emphasized. The list was provided as a guideline, and subjects were not penalized for adhering to the priorities in an alternate order.

3.6.3. Secondary Tasks

The alerting system configurations are not thought to improve performance when the driver is focused on the road in anticipation of potential collisions; therefore, the subjects were asked to complete secondary tasks that divided their attention and forced them to break visual contact with the roadway. Subjects were asked to complete two continuous secondary tasks, *maintaining speed* and *police officer identification*, and one periodic task, *map-reading* [43]. During the testing sessions, the maximum speed limit was 60 mph, and the minimum speed limit was 55 mph. Police officers were placed throughout the testing scenarios, and subjects were told that if they were traveling above or below the designated speed limits when they encountered a police officer, they would be penalized with a ticket. Enforcing a narrow range of speed helped maintain consistency among the dynamics of the threat events and aided the scenario development (particularly in the placement of surrounding traffic). Police officers could be behind or in front of the driver, stopped or moving, on either side of the road. The subjects were asked to press any of the buttons on the steering wheel when they saw a police officer. The presses were recorded within the simulation, indicating the

moment at which the officer had been seen. Subjects had the opportunity to practice this during the training session.

The map-reading task involved identifying two fictional locations on a paper map and relaying the relative orientation between them (Figure 3-7). The instructions were delivered periodically throughout the testing by pre-recorded audio files that played at specific distances down the road. The prompt would say: “Your task is: using the paper map, determine the relative orientation between CITY X and CITY Y. Please begin now.” When the prompt finished, the map would be placed next to the subject, at which point he or she was free to pick it up or reposition it. The subject had to recall the names from the prompt, find those locations on the map, and then respond, for example, “CITY X is northwest of CITY Y” or “CITY Y is southeast of CITY X.” The subject chose from the eight cardinal directions, and by convention, the top of the map was north. When the subject responded, the task completion time was recorded manually in the driving simulator data collection. Subjects had the opportunity to practice the map-reading task during the training session.

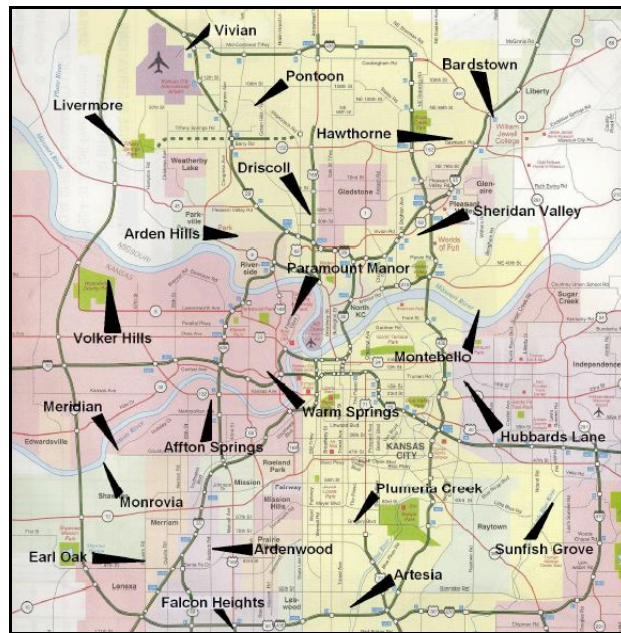

Figure 3-7: An example of a map used for the map-reading task [44].

The driver was prompted to complete 12 map-reading tasks, six during each of the two test scenarios. The tasks were divided among six maps, with two tasks pertaining to each map [44]. No two tasks were less than 45 to 60 seconds apart. Half of the map reading tasks was asked when the scenario was designed to warrant a FCWS

activation (during threat events and unnecessary activations); the remaining half was asked when no activation was planned. This was intended to offset any suspicion the driver may have regarding an impending threat event. This was also meant to offset the changes in behavior that are seen when someone is faced with an additional task while driving, which could bias the driver's response.

3.6.4. Follow-up Briefing

Upon completing the two test scenarios, subjects were then asked a series of questions designed to probe acceptance, trust, and confidence among the systems. The survey questions were as follows:

- Which system (if any) did you prefer?
- Would you want to own a vehicle with one of these alerting systems? If so, which one?
- What would you change (if anything) about any of the systems?
- Please respond: The early alerts were:

1	2	3	4	5
Not at all Useful	Not Useful	Neutral	Useful	Very Useful
- How certain/uncertain are you that the Early Non-Directional system will help you avoid a potential collision?

1	2	3	4	5
Very Uncertain	Uncertain	Neutral	Certain	Very Certain
- How certain/uncertain are you that the Early Directional system will help you avoid a potential collision? (same scale as above)
- How certain/uncertain are you that the Late Alerting Only system will help you avoid a potential collision? (same scale as above)
- Additional comments?

3.7. Apparatus

The study was conducted using Systems Technology Inc. STISIM Drive simulation software. The training and testing scenarios were created using the STISIM Scenario Definition Language, and the FCWS configurations were emulated using the open module capabilities of the software. The driving controls consisted of a Logitech

G25 racing wheel and pedal set. An IBM Thinkpad T42 laptop computer was used to run the simulation, and external speakers placed in front of the driver amplified the accompanying audio. The simulation was viewed on a widescreen LCD monitor that was positioned at the subject's eye level (Figures 3-8, 3-9).

Driving in a simulator is unlike driving on a real road, although different configurations of equipment can simulate a real-world driving environment with varying degrees of fidelity. Typically, computer-generated graphics displays diminish visual cues that would otherwise be useful in a real-world setting. For example, brake light activations are simulated by changing color, but they do not change in luminosity. Subjects may have difficulty in detecting this visual cue, because color changes are less salient than changes in brightness. Field of view can be limited as well, especially if the simulator is not equipped with multiple displays. There is also a lack of inertial feedback that, among other effects, potentially changes driving behavior or causes simulator sickness. Despite these differences between the simulated environment and the real-world, there is a fundamental assumption that the relative differences in performance among the simulated FCWS configurations are sufficiently equivalent to the differences that would be observed in the real world.



Figure 3-8: The driving simulator.



Figure 3-9: The positions of the subject and investigator.

4. Results and Discussion

The analysis of the experiment examines several quantitative dependent variables that pertain to the overall effectiveness of the FCWS configurations. The number of collisions and the number of late alert threshold crossings are direct indications of the subjects' ability to avoid undesirable incidents. The responses to the threat events are also analyzed, including the time at which a response is made, the closest point of approach, and, for those who did collide, the relative velocity between the two vehicles at impact. Secondary task performance was also examined, including the number of police officers identified, the map-reading task completion times, and an analysis of speed.

Qualitative data was examined as well, including the nature of the subjects' responses for both the threat events and unnecessary alert activations, as described by the vehicle control actions. These actions are represented graphically in terms of vehicle velocity, as well as plots of relative velocity vs. range. Subjective comments were collected after the testing to probe drivers' trust and confidence in multi-stage and directional alerting. The subjective data was both quantitative (questions answered with a Likert scale), and qualitative (subjective comments and opinions).

4.1. Effectiveness

The purpose of a collision warning system is to help drivers avoid undesirable incidents; therefore, the system's effectiveness is ultimately measured by its ability to do so. For the purposes of this analysis, *effectiveness* is defined as the number of undesirable outcomes that were avoided, given the number of hazardous situations in which drivers had to respond to avoid such outcomes; for example, the percentage of collisions that were avoided given that the driver crossed the late alert threshold (Equation 6). Another example is the number of times drivers avoided crossing the late alert threshold, given that they encountered a hazard and crossed the early alert threshold (Equation 7). The late alert threshold is defined as the point at which action is necessary to avoid a collision, and therefore some FCWS configurations may support the driver at this critical moment better than others.

$$\text{Effectiveness}_{\text{Collision Avoidance}} = 1 - \frac{\# \text{ of Collisions}}{\# \text{ of Late Alert Threshold Crossings}} \quad (6)$$

$$\text{Effectiveness}_{\text{Late Crossing Avoidance}} = 1 - \frac{\# \text{ of Late Alert Threshold Crossings}}{\# \text{ of Early Alert Threshold Crossings}} \quad (7)$$

Although collisions could occur with other vehicles and cyclists, each threat event was designed to present the driver with a single hazard with which the driver would collide if no response was made. The intentional hazard within each event is referred to as the *target vehicle*. If the subject did not attempt to avoid the target vehicle, he or she would experience the same progression for all of the events: the early alert threshold would be crossed, then the late alert threshold would be crossed, and finally a collision would occur. The threat event *outcome*, or the extent to which the driver progressed into the event, is a direct indication of the alerting systems' effectiveness. Drivers who are provided multi-stage and directional alerting are expected to respond sooner, avoiding collisions and late alert threshold crossings more effectively than drivers whose awareness is not supported with late, or no alerting.

Table 4-1 displays the outcomes of each threat event (labeled TE1 through TE8) for every subject (labeled S01 through S24), organized by alerting system configuration. There were 24 subjects and 8 threat events for a total of 192 samples, with 48 samples for each system configuration. Within each threat event category, there were 48 samples, with 12 samples for each configuration. Collisions with the target vehicle are displayed, as well as late and early alert threshold crossings. The times at which these thresholds were crossed were recorded for every FCWS configuration, regardless of whether or not the alert was displayed. The number of collisions (i.e., instances when the range between the hazard and the driver's vehicle is equal to zero) is recorded within the simulator; however, there was one subject who came within one foot of the hazard and 0.01 seconds from colliding. In this analysis, this was considered a collision. There were also subjects who responded early in the event such that the early alert threshold was never crossed.

Table 4-1: Threat event outcome summary (key below).

	Non-Moving Obstruction		Moving Obstruction, Initially Stopped		Moving Obstruction, Initially Moving		Lane Crossing	
	TE1	TE2	TE3	TE7	TE5	TE8	TE4	TE6
No Alerting	S04	S04	S01	S03	S02	S03	S01	S02
	S08	S08	S05	S10	S09	S10	S05	S09
	S15	S15	S06	S12	S13	S12	S06	S13
	S16	S16	S07	S14	S17	S14	S07	S17
	S19	S19	S11	S21	S20	S21	S11	S20
	S23	S23	S18	S24	S22	S24	S18	S22
Late Alerting Only	S02	S02	S08	S01	S06	S01	S08	S06
	S03	S03	S09	S04	S10	S04	S09	S10
	S07	S07	S21	S05	S12	S05	S21	S12
	S11	S11	S22	S13	S16	S13	S22	S16
	S14	S14	S23	S15	S18	S15	S23	S18
	S17	S17	S24	S20	S19	S20	S24	S19
Early Non-Directional + Late Alerting	S01	S01	S02	S07	S04	S07	S02	S04
	S06	S06	S03	S08	S05	S08	S03	S05
	S12	S12	S10	S09	S11	S09	S10	S11
	S13	S13	S15	S17	S14	S17	S15	S14
	S21	S21	S16	S18	S23	S18	S16	S23
	S22	S22	S20	S19	S24	S19	S20	S24
Early Directional + Late Alerting	S05	S05	S04	S02	S01	S02	S04	S01
	S09	S09	S12	S06	S03	S06	S12	S03
	S10	S10	S13	S11	S07	S11	S13	S07
	S18	S18	S14	S16	S08	S16	S14	S08
	S20	S20	S17	S22	S15	S22	S17	S15
	S24	S24	S19	S23	S21	S23	S19	S21

Outcome Key (with respect to the target vehicle):

- = collision
- = late alert threshold crossing
- (white) = early alert threshold crossing
- = no threshold crossings

All of the collisions occurred during two threat events: TE2, in which an oncoming vehicle turns left in front of the driver, and TE4, in which a police officer chases another vehicle across the driver’s lane from the left. Within TE2, one collision occurred with each of the four FCWS configurations. Within TE4, one collision occurred with each of the No Alerting, Late Alerting Only, and Early Non-Directional configurations. Table 4-2 displays the total number times subjects collided with the target vehicle. Of the 24 subjects, no one collided with a target vehicle more than once. Drivers who were equipped with the Early Directional system experienced fewer collisions, but pairwise t-tests do not indicate significant differences among the totals (p-value > 0.1).

Table 4-2: Target vehicle collisions for each system configuration.

FCWS Configuration	Collisions	Events	%
No Alerting	2	48	4%
Late Alerting Only	3	48	6%
Early Non-Directional	2	48	4%
Early Directional	1	48	2%

For those threat events that resulted in an accident, the relative velocity at impact was recorded. For TE2, there are no distinct differences among the system configurations (Figure 4-1). The values for TE4 display a more pronounced trend, in that the relative velocity at impact decreases as the amount of driver support increases, signifying more successful responses (Figure 4-2, each column represents one collision). Although a collision does occur, a lower relative velocity will, in many cases, be less damaging than a greater difference in speed. For this threat event, there were no collisions with the Early Directional system configuration, which is consistent with the trend and the hypotheses: as drivers' awareness is supported through multi-stage and directional alerting, drivers perform more effective evasive maneuvers. In particular, TE4 introduced an off-axis hazard that was not initially on the roadway in front of the driver. Directional alerting directed attention to the hazard before it reached the driver's lane, and provided more time in which to respond most effectively.

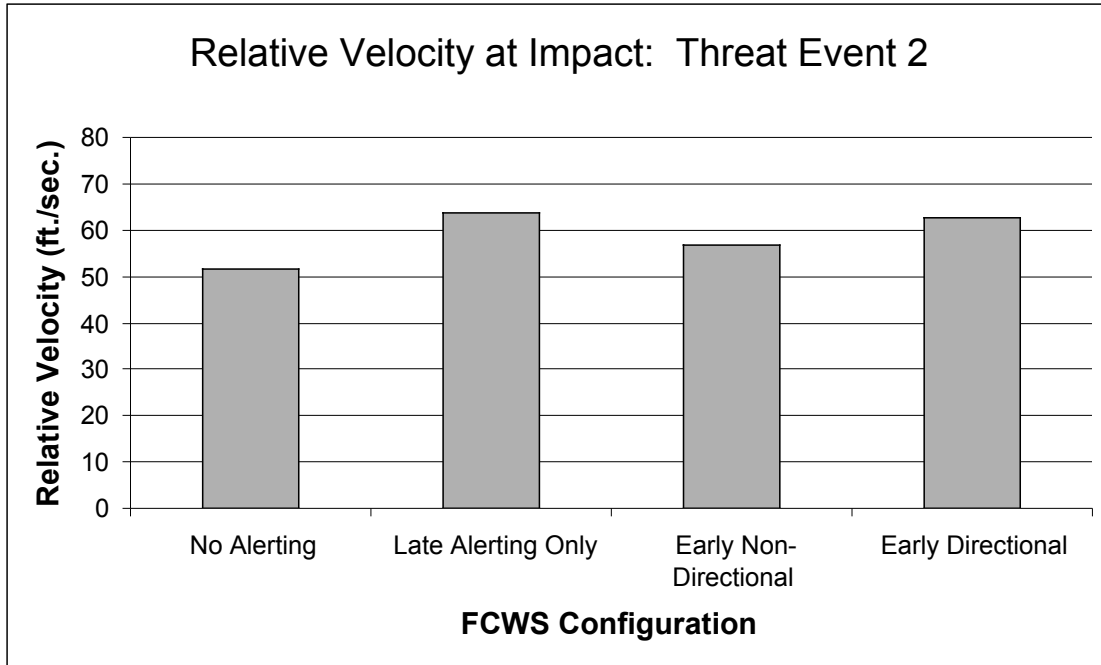

Figure 4-1: Relative velocity at impact for collisions that occurred during TE2.

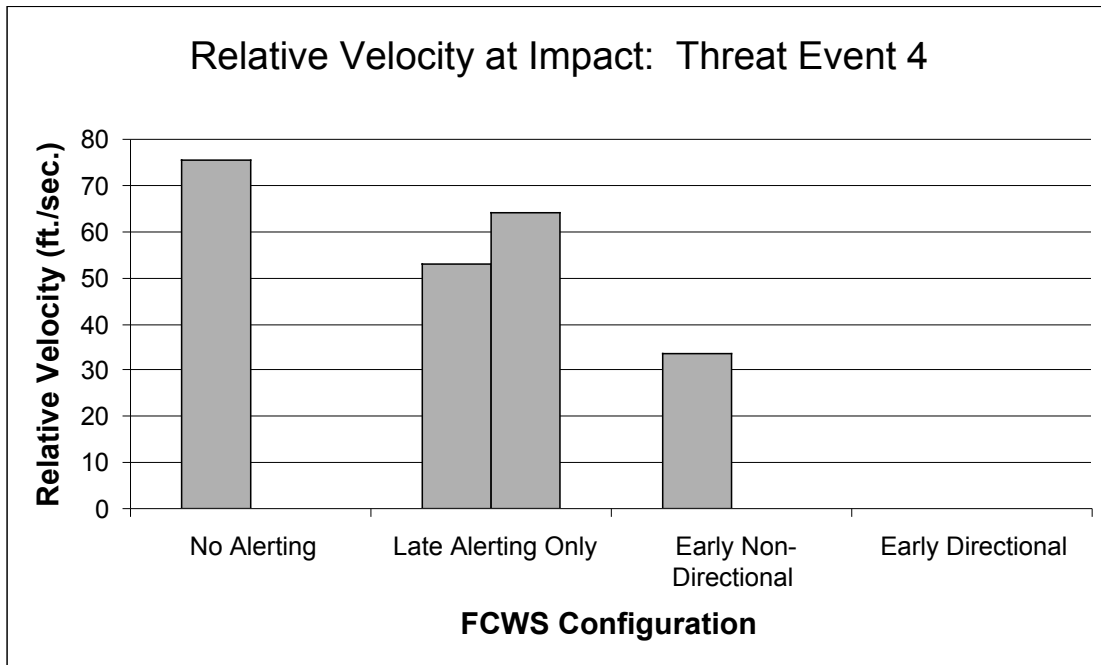

Figure 4-2: Relative velocity at impact for collisions that occurred during TE4.

An effective FCWS can assist in avoiding collisions by helping the driver avoid dangerous situations in which a collision could occur, such as late alert threshold crossings. Table 4-3 contains the number of threat events in which the late alert threshold was crossed with respect to the target vehicle (including those events that resulted in collisions). When subjects were not provided an alerting system, the late alert threshold was crossed during approximately half of the events. With only late alerting, late alerts were issued during more than half of the events. With the addition of multi-stage alerting, the Early Non-Directional system exhibited a slight decrease in number of late alert crossings, possibly indicating an increase in driver awareness. However, when drivers were provided both directional and multi-stage alerting, only 25% of the threat events resulted in late alert threshold crossings. Pairwise T-tests indicate a significant difference in the number of late alert threshold crossings for the Early Directional system when compared to each of the other system configurations (p-values < 0.05).

Table 4-3: Late alert threshold crossings, with respect to the target vehicle.

FCWS Configuration	Late Threshold Crossings	Events	%
No Alerting	22	48	46%
Late Alerting Only	23	48	58%
Early Non-Directional	20	48	42%
Early Directional	12	48	25%

The collision avoidance effectiveness of each system configuration was calculated using Equation 6. Referring to the values in Table 4-4, the four configurations exhibited relatively consistent findings. This may imply that the late alert threshold was set too close to the hazard, making a successful response equally probable either with or without an alert. Drivers may not benefit from an alert if the short amount of time in which they have to respond sufficiently limits the degrees of freedom of the response. Another possible explanation is that the subjects were primed to respond quickly to the hazard, which may be a consequence of unintentionally salient hazardous situations.

Table 4-4: Collision avoidance effectiveness, with respect to the target vehicle.

FCWS Configuration	Collisions	Late Crossings	Effectiveness
No Alerting	2	22	91%
Late Alerting Only	3	23	87%
Early Non-Directional	2	20	90%
Early Directional	1	12	92%

In addition to the eight manufactured threat events, subjects experienced numerous *non-target* hazards elsewhere within the testing. The frequency of these potential collisions was not controlled but could occur throughout the scenario, depending on the subjects' driving. Five subjects experienced non-target collisions during TE8 (a lead vehicle decelerates because of slow moving traffic up ahead). Non-target collisions occurred exclusively during this threat event, possibly because this was the longest of the eight events and because of the proximity of decelerating, surrounding traffic. One of the five subjects, who was not provided any alerting for this event, collided with two vehicles. The remaining drivers, who did have directional and/or multi-stage alerting, each collided once. Of the collisions that did not coincide with a threat event, three occurred when the No Alerting configuration was in effect, and one occurred when the driver was using the Early Non-Directional system. Throughout the testing, subjects appear to have more collisions when they are not provided a FCWS. Table 4-5 contains the total number of target and non-target collisions for each FCWS configuration, as well as the total number of target and non-target hazards. Subjects without alerting appear to collide more than subjects who are equipped with an alerting system (highlighted). It is predicted that these trends will become more exaggerated if more data were collected.

Table 4-5: Target and non-target collisions, as a percentage of the total number of hazards.

FCWS Configuration	Collisions	Hazards	%
No Alerting	8	136	7%
Late Alerting Only	3	125	2%
Early Non-Directional	4	143	4%
Early Directional	2	126	2%

Table 4-6 contains the total number of late alert threshold crossings with respect to target and non-target hazards. Here, the highest of percentage of late alert threshold crossings is seen when drivers are not provided alerts. Similar performance is seen with the Late Alerting Only and Early Non-Directional systems. The lowest percentage of late alert crossings is seen with the Early Directional system (highlighted); again, supporting the hypothesis that drivers with directional alerting are more aware, and able to avoid potentially hazardous situations more effectively.

Table 4-6: Late alert threshold crossings for each system configuration, as a percentage of the total number of target and non-target hazards.

FCWS Configuration	Late Threshold Crossings	Hazards	%
No Alerting	55	136	40%
Late Alerting Only	48	125	38%
Early Non-Directional	53	143	37%
Early Directional	27	126	21%

Equation 6 was used to calculate the collision avoidance effectiveness of each system configuration. Table 4-7 contains the system effectiveness values with respect to target and non-target hazards. The observed trends are similar to the effectiveness values with respect to the target vehicle, in that the three configurations that provide alerting all support a similar ability to avoid collisions. However, the effectiveness of the No Alerting configuration decreased with the increased number of collisions (highlighted). Again, if more data were collected, effectiveness is expected to continue decreasing.

Table 4-7: Collision avoidance effectiveness, with respect to target and non-target hazards.

FCWS Configuration	Collisions	Late Crossings	Effectiveness
No Alerting	8	55	85%
Late Alerting Only	3	48	94%
Early Non-Directional	4	53	92%
Early Directional	2	27	93%

Any alert that precedes a collision is *necessary*, even though it is unsuccessful. If a collision does not occur, an alert is considered *necessary* if a hazard is present (not a false-positive system activation), and the driver performs a measurable response to avoid the hazard (such as an accelerator release, steering, or braking maneuver). The assumption is that if no response was made, the relative dynamics that triggered the alert would have remained constant, and a collision would have occurred. Of the situations in which the driver needed to respond, some drivers responded before crossing the late alert threshold while some did not: these drivers were placed in a situation that required a response, but an action was delayed until necessary. A response could have been delayed purposefully, or the drivers could have been unaware of how rapidly the situation was evolving. There were situations in which the dynamics of the situation caused an immediate late alert activation—this analysis only considers those events that began in the early alert threshold crossings, and progressed to a late alert threshold crossing.

Table 4-8 contains a summary of the number of late alert threshold crossings, given a necessary early alert threshold crossing preceded it, as well as the total number of necessary alerts. Equation 7 is used to calculate the effectiveness of the FCWS configurations' abilities to assist the driver in avoiding the late alert threshold. The No Alerting and Late Alerting Only system configurations are shown in grey because the driver was not provided any indication that the early alert threshold was crossed. This analysis only refers to the necessary early alerts that were shown to the driver. These configurations are included for illustrative purposes: the Early Non-Directional system is similarly effective at helping drivers avoid hazardous situations as the system configurations that provide only late alerting or no alerting. The Early Directional system was the most effective (highlighted), supporting the hypothesis that directional alerting increases awareness and promotes more effective responses.

Table 4-8: Late alert threshold crossings (given early alert threshold crossings), necessary early alerts, and system effectiveness.

FCWS Configuration	Late Crossings	Necessary Alerts	Effectiveness
No Alerting	39	100	61%
Late Alerting Only	34	99	66%
Early Non-Directional	38	111	66%

Early Directional	18	92	80%
-------------------	----	----	-----

The effectiveness of the Early Directional FCWS is also seen when examining the minimum range with respect to the target vehicle. Drivers who were provided directional alerting were able to maintaining farther, and safer, distances from hazards by performing earlier, more effective evasive maneuvers. Referring to the plot in Figure 4-3, a range of zero indicates a collision. The black line in the middle of the box represents the median, while the edges correspond to the 25th and 75th percentiles. The ends of the whiskers are the maximum and minimum values that are not statistical outliers. The outliers indicate values whose distance from the nearest quartile is greater than 1.5 times the interquartile range.

Minimum Range with Respect to the Target Vehicle

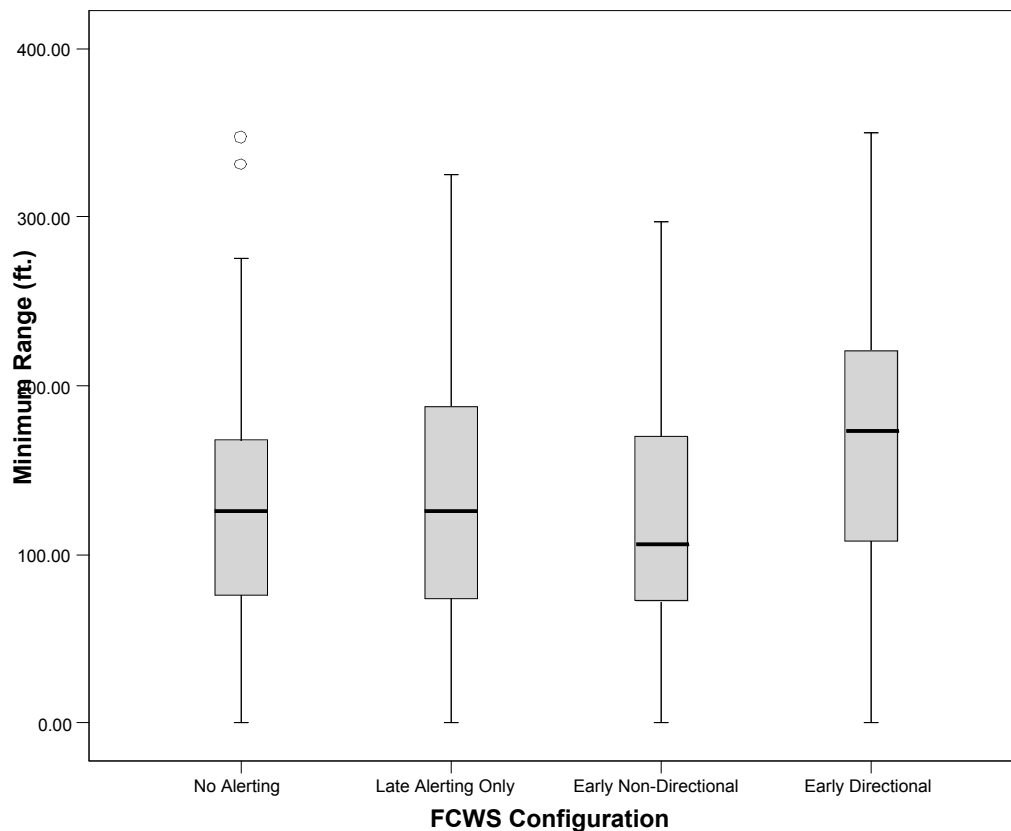

Figure 4-3: Minimum range with respect to the target vehicle.

The majority of driver responses progressed past the early alert threshold, but there were ten instances in which the driver either deliberately or inadvertently

performed an *early response*, which neutralized the hazard before crossing the early alert threshold (Table 4-9). However, had the subject not responded, the event would have progressed, and the thresholds would have been crossed. Seven of these early responses occurred during TE2 (vehicle turns left in front of the driver). The dynamics of this particular event were not as consistent as those of the other events, which may have contributed to this behavior. The remaining three early responses occurred during the events in which stopped vehicles on the side of the road pull into the driver's lane. Subjects may have been suspicious and primed to respond to these situations, even though the hazards were initially visually obscured by other vehicles.

Table 4-9: Early responses, with respect to the target vehicle.

FCWS Configuration	Early Responses
No Alerting	3
Late Alerting Only	2
Early Non-Directional	1
Early Directional	4

4.2. Response Times and Behavior

In this analysis, a *response* is defined by one of three actions, or combinations of these actions:

- Accelerator release (accelerator input decreases to 0)
- Aggressive braking (sustained brake input)
- Aggressive steering (steering wheel angle rate exceeds 0.4 radians/sec.)

Response time refers to the TTC value, with respect to a hazard, at which the response was made. The first response within each threat event is examined. TTC values provide a time-scale that is relative to each particular scenario, thereby providing a consistent reference for comparison amongst the system configurations. However, because of simulator limitations, TTC values were not recorded until they were within the alerting threshold. This means that any response that occurred before the early alert threshold was crossed, does not have an associated response time (the time could be anywhere between 5.41 seconds TTC to infinity, and is considered *undefined*). Similarly, response time is undefined if the response is made at anytime the TTC value exceeds 5.4

seconds TTC—even after an initial threshold crossing. Table 4-10 contains the number of undefined responses that occurred with each system configuration.

Table 4-10: Undefined response times.

FCWS Configuration	Undefined Response Times	Events
No Alerting	8	48
Late Alerting Only	8	48
Early Non-Directional	3	48
Early Directional	7	48

Figure 4-4 displays the response times with respect to the target vehicles. Drivers with multi-stage and directional alerting tended to respond at earlier TTC values than drivers who do not have this support. With more opportunity to consider appropriate evasive maneuvers, earlier response times increase the probability that the response is successful. There is also less variation among the response times of drivers who have directional and multi-stage alerting. Less variation among the responses may imply system effectiveness for more people with a wider range of driving styles and abilities.

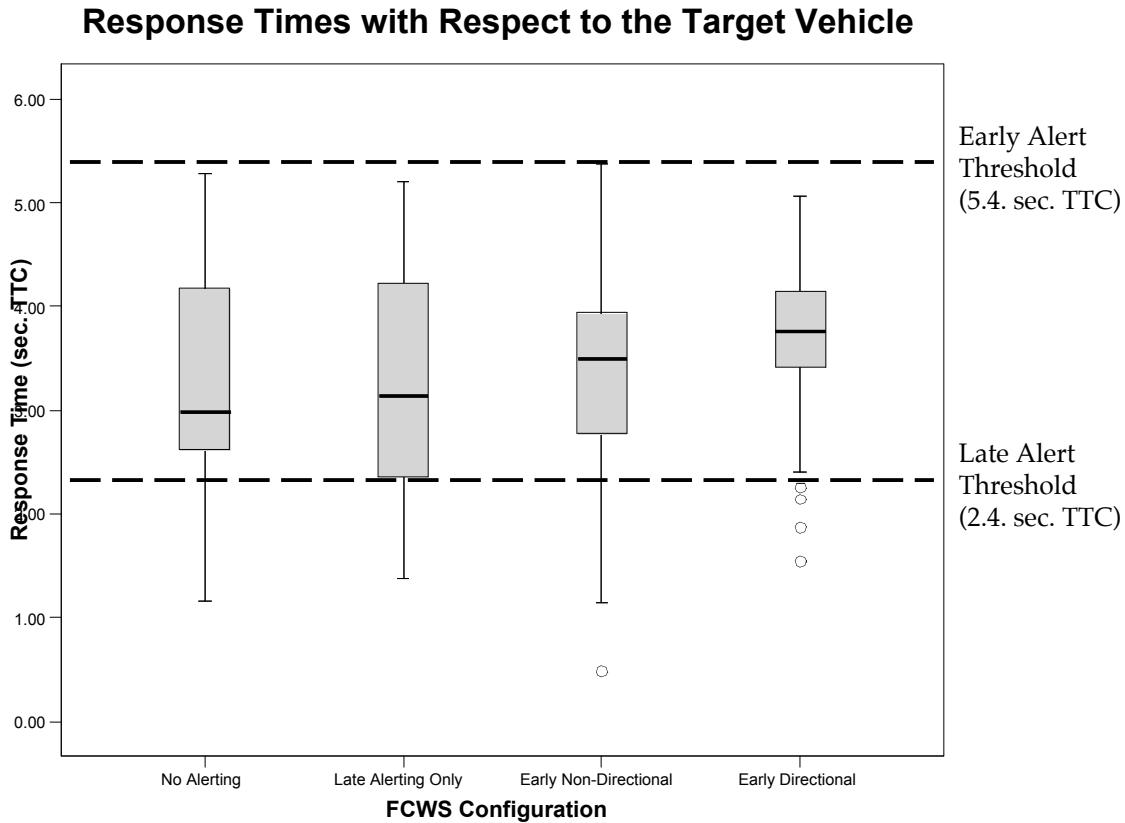

Figure 4-4: Response times with respect to the target vehicle.

The type of response during the threat events was also examined; Table 4-11 contains the percentage of drivers whose first response was steering, releasing the accelerator (no braking), or braking. For all the FCWS configurations, subjects tended to release the accelerator most frequently as a first response. Few subjects first responded by aggressively braking, but rather the majority tended to wait until farther into the event before performing a more committing action. This delay suggests that drivers are inclined to assess a hazardous situation before responding, indicating an opportunity to aid the driver through directional and multi-stage alerting. As seen previously, these alerting systems are not detrimental, but are effective in assisting the driver in supporting a successful assessment.

Table 4-11: Type of first response during the threat events, expressed as percentage of the total number of responses.

FCWS Configuration	Steering	Accelerator Release	Brake	Events
--------------------	----------	---------------------	-------	--------

No Alerting	44%	46%	10%	48
Late Alerting Only	44%	48%	8%	48
Early Non-Directional	38%	52%	10%	48
Early Directional	38%	50%	12%	48

4.2.1. Velocity Profiles

A velocity profile displays response behavior as a function of time, as expressed through the vehicle's velocity. This analysis includes profiles of the two threat events in which collisions occurred: TE2 (Figure 4-5), and TE4 (Figure 4-6). Time is referenced to the beginning of the event, when data recording began. Lines of equal slope correspond to drivers who slowed down at maximum deceleration. Collisions are indicated by thicker lines, and the point at which the collision occurred is labeled on the profile. Lines that do not decrease in velocity, but do not result in collisions, correspond to drivers who steered to avoid the hazard.

All drivers who collided with the target vehicle appeared to brake at maximum deceleration. The onset of an ineffective response typically began later than more successful responses, and without steering to avoid the hazard, the collision could not be avoided. This suggests that the driver was not aware of what needed to be done to avoid the hazard, but if the response had been made earlier, they may have successfully evaded the vehicle.

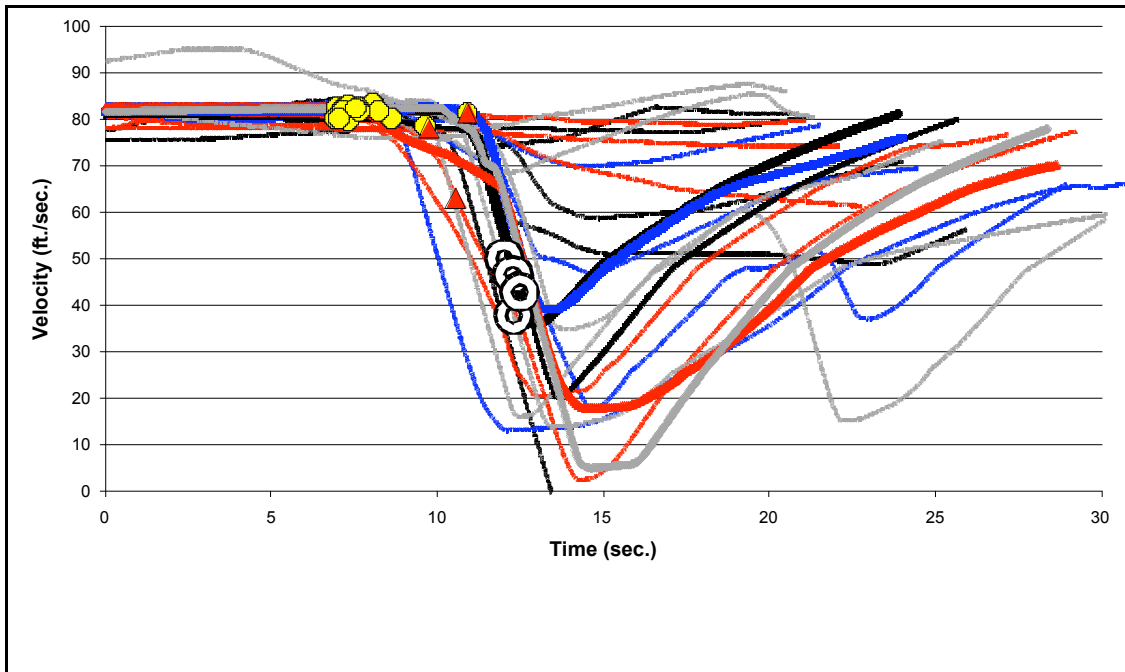

Figure 4-5: Velocity profile for TE2 (key to the right).

- - No Alerting
- - Late Alerting Only
- - Early Non-Directional
- - Early Directional
- - Early Threshold Crossing
- ▲ - Late Threshold Crossing
- ⊙ - Collision

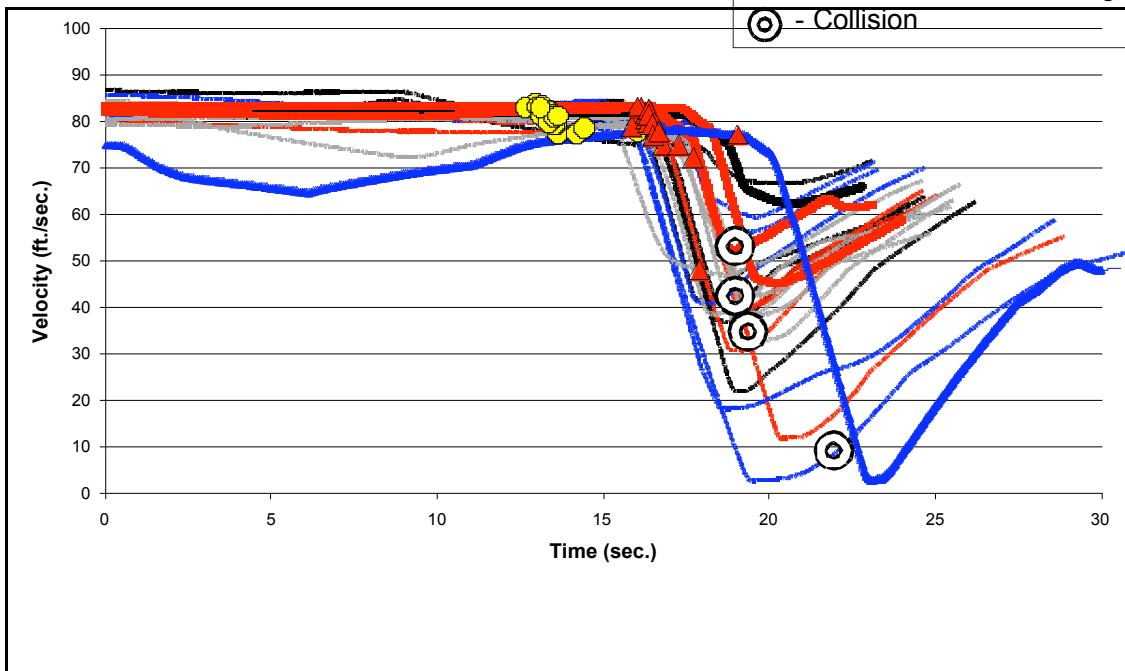

Figure 4-6: Velocity profile for TE4.

4.2.2. Relative Velocity vs. Range Profiles

In addition to the velocity profiles, response behavior can be visualized on plots of relative velocity vs. range. This representation corresponds directly with the state-space diagrams used in the kinematic analysis in Chapter 2. Again, the two threat events in which collisions occurred are included (Figures 4-7, 4-8). Lines that intersect the y-axis correspond to collisions (range equal to zero). Discontinuous lines indicate times when the target vehicle was initially avoided, but the driver responded such that the alerting threshold was crossed multiple times. After reducing relative velocity to zero (intersecting the x-axis), the driver is assumed to have responded successfully.

For TE4, subjects who used the Early Non-Directional and Early Directional system configurations were able to neutralize the hazard at farther ranges than those who used the Late Alerting Only or No Alerting system configurations. Subjects who collided with the hazard appear to have begun braking, but the onset of the response was not performed early enough to be successful.

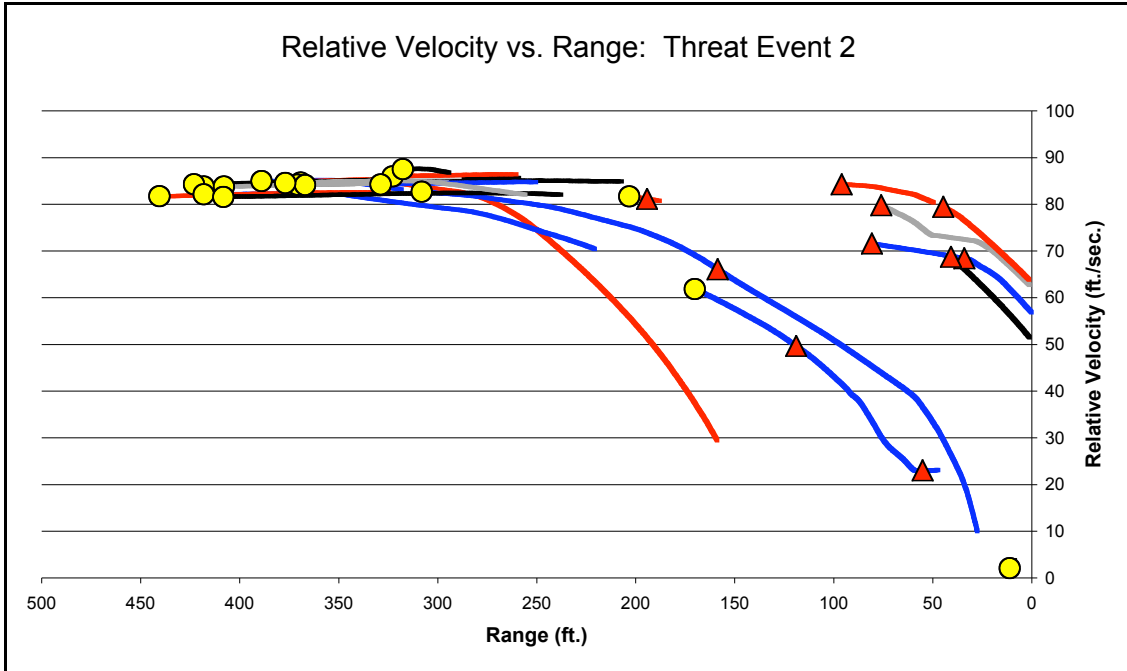

Figure 4-7: Relative velocity vs. range plot for TE2.

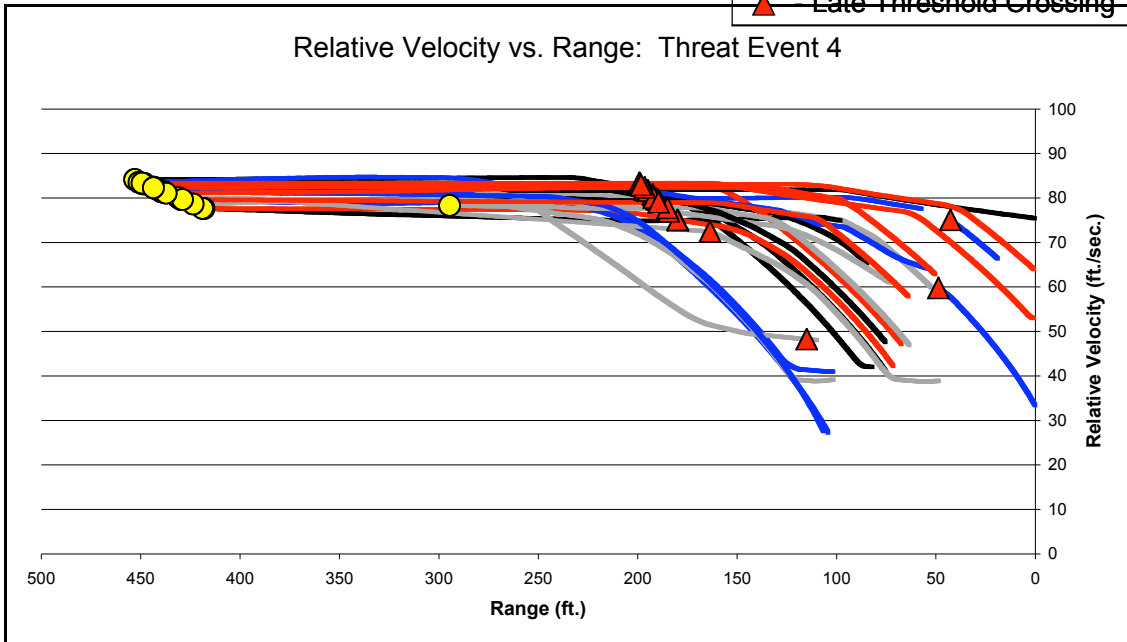
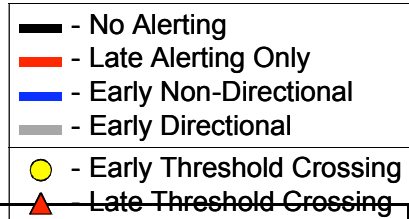

Figure 4-8: Relative velocity vs. range plot for TE4.

The plot for TE8 (lead vehicle decelerates because of traffic up ahead) shows a much more pronounced trend in driver behavior: Subjects who were provided early

alerting consistently responded farther away from the hazard than those who were provided late, or no alerting. There is a clear division among the responses, and of those subjects who slowed down after receiving an early alert, none crossed the late alert threshold. The impoverished visual cues in the simulator inhibit driver estimations of speed and deceleration, especially at a distance; but this is similar to many real-world situations in which visibility is reduced, or hazards are too far away to accurately perceive and assess the relative dynamic state. There is a clear benefit of alerting the driver earlier when the hazard is distant and ambiguous.

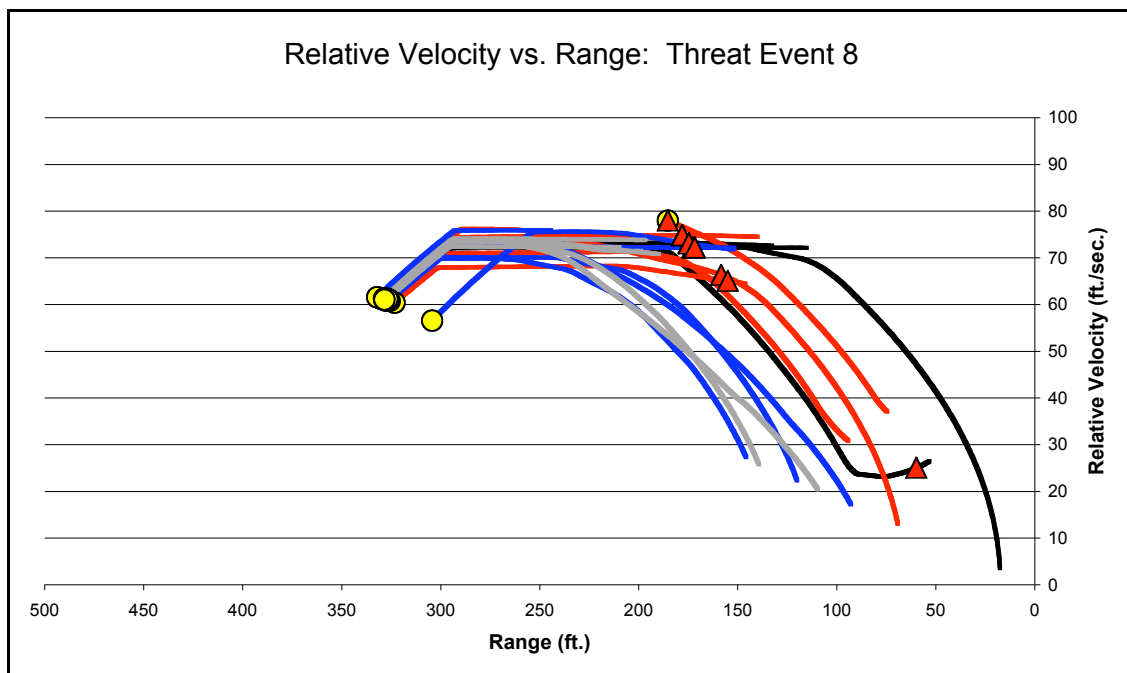
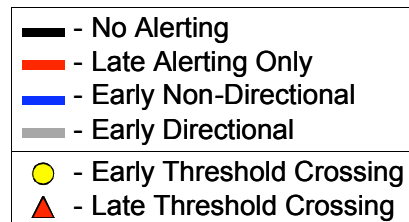

Figure 4-9: Relative velocity vs. range plot for TE8.



4.3. The Naïve Response

The training scenario was designed to capture drivers' naïve responses to a hazard, before they were provided any knowledge regarding the FCWS (Table 4-12). All subjects crossed the early alert threshold, and most crossed the late alert threshold as well. There were only three target vehicle collisions, both with the early alerting

systems. There were also two non-target collisions, one with the Late Alerting Only system, and the other with the Early Directional configuration. Driver responses were not significantly varied across the different systems, but it is important to note that these findings, which consist of eight samples across three levels, are not statistically powerful.

Table 4-12: Training scenario threat event outcomes (naïve response) (key to the right).

	Naïve Response	Outcome Key (with respect to the target vehicle):
Late Alerting Only	S02	= collision = late alert threshold crossing (white) = early alert threshold crossing = no threshold crossings
	S03	
	S04	
	S09	
	S10	
	S16	
	S19	
	S22	
Early Non-Directional + Late Alerting	S05	
	S08	
	S12	
	S13	
	S14	
	S17	
	S20	
	S23	
Early Directional + Late Alerting	S01	
	S06	
	S07	
	S11	
	S15	
	S18	
	S21	
	S24	

On the other hand, the plot of relative velocity vs. range reveals that subjects who were provided early alerting, without knowing that it was provided, tended to respond later than those who were only provided late alerting. In every training scenario threat event, the lead vehicle suddenly drove off the road and revealed the stopped vehicle at the moment when the driver crossed the early alerting threshold. At this point, the hazard was apparent, and subjects who were not simultaneously provided an early alert tended to steer into the next lane to avoid an accident. However, subjects who did receive an early alert not only tended to brake, but did not brake as effectively as drivers who were only provided late alerting. This may indicate

an initial confusion with the alert, which ultimately decreased system effectiveness. This supports the fact that an early alerting system should be familiar, and integrated into the driving task much like any other tool available to the driver. A FCWS that alerts earlier and more often promotes this familiarity and will increase effectiveness.

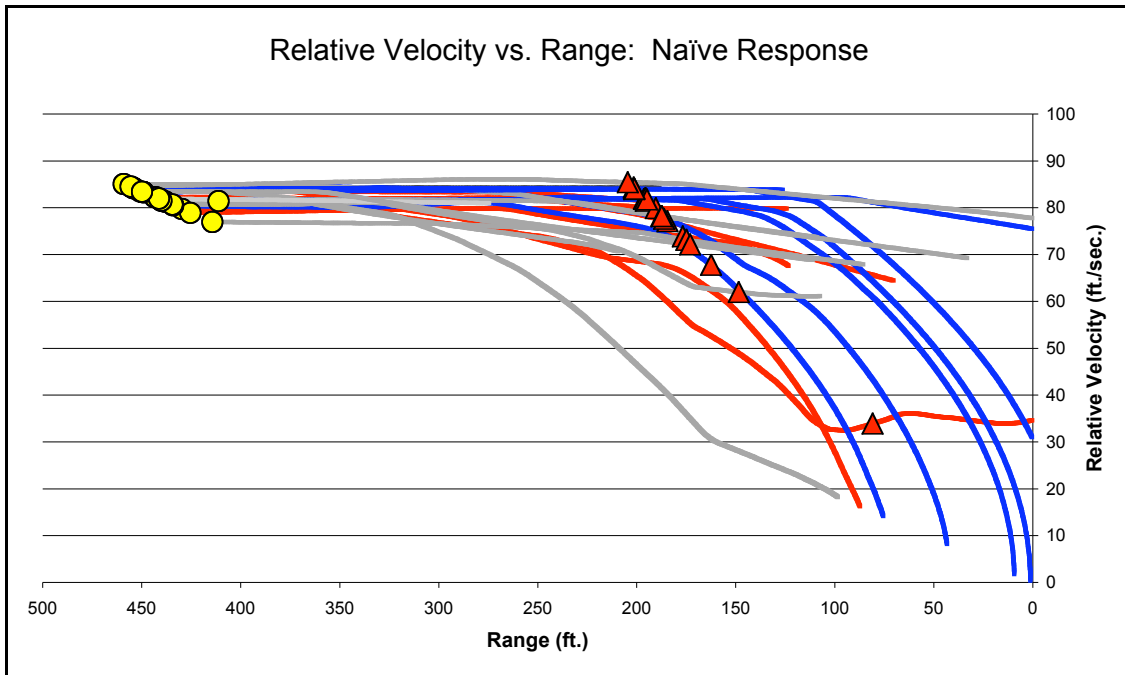

Figure 4-10: Relative velocity vs. range plot for the training scenario threat event (naïve response).

4.4. Secondary Task Performance

4.4.1. Map-Reading

Map-reading task completion times did not vary significantly across the different system configurations (Figure 4-11, outliers removed); however, the tasks were effective at artificially inducing driver distractions. Many subjects commented on the difficulty of maintaining his or her position in the designated lane while looking away from the road. Most subjects were able to complete all of the tasks, unless they ran out of time, which occurred approximately two to five times during each system configuration (out of a total of 72 tasks). The tasks were intended to provide consistent, controlled distractions, but there were possible confounds: for example, subjects for whom English is a second language had difficulty with some of the city names (e.g.

“Wyndham” and “Galena”), and several subjects recognized the real-world topography underlying the fictional cities.

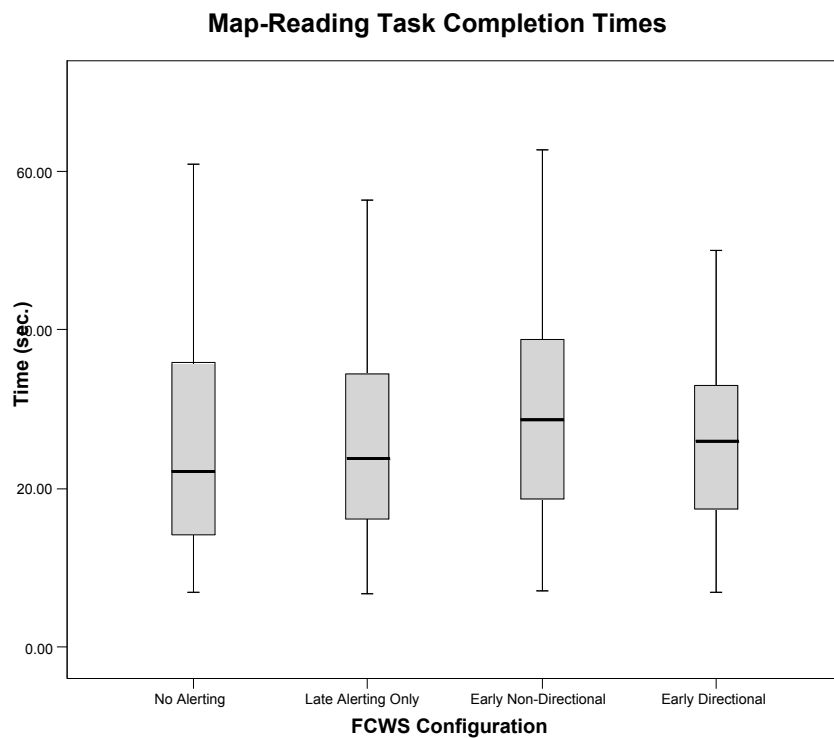

Figure 4-11: Map-reading task completion times.

4.4.2. Police Officer Identification

Differences in the number of police officers that subjects were able to correctly identify may suggest differences in the awareness subjects may have had of other vehicles in the environment. The number of correct police officer identifications was similar across the systems, although subjects using the Early Directional system identified the highest number, more than half (highlighted in Table 4-13). There were two subjects who did not identify any police officers; both were using the Late Alerting Only system. Subjects were able to identify at least one officer with all the other system configurations.

The amount of time the driver took to identify the officer is not analyzed because it was not possible to guarantee that every police officer was visible at the same time for every subject, and it is not possible to determine if, at that point, the officers were visible. The instantiations of the police officers were controlled, but they could have been visually occluded by surrounding traffic.

Table 4-13: Number of correct police officer identifications.

FCWS Configuration	Correct Identifications	Total # of P.O.'s	%
No Alerting	71	144	49%
Late Alerting Only	68	144	47%
Early Non-Directional	71	144	49%
Early Directional	82	144	57%

4.4.3. Maintaining Speed

Subjects were told they would be penalized if the vehicle's speed was below 55 mph or above 60 mph, but the subjects' average speed during the testing was between 50 mph and 55 mph. The needle of the simulated speedometer displayed speeds that were 1 mph to 3 mph higher than the speed recorded in the simulator, which could account for this shift below the requested speed. Maximum speeds ranged between 60 mph to the vehicle's maximum speed of 65 mph.

4.5. Response to Unnecessary Alert Activations

Driver responses to the unnecessary alert activations were not significantly varied. These observations only include subjects who were provided an early alerting system, since the Late Alerting Only and No Alerting configurations did not unnecessarily activate at the early alert threshold. The alerts were set to turn on and turn off at specified distances, and therefore the duration of the activation was dependent upon the vehicle's speed. This duration was between 3.01 seconds and 4.01 seconds for all subjects.

Most subjects released the accelerator when they were presented an unnecessary alert, while some braked and some performed no response. Figures 4-12 through 4-15 display examples of accelerator input profiles for the durations of both unnecessary activations. It was initially assumed that the first response would indicate the most confusion, while the second would show a response of less magnitude (indicating less confusion). Here, it appears that within these examples, the Early Directional system incites a more cautious response, regardless of whether or not directional alerting was provided during the first or second activation. This could be because the driver trusted

that the alert was going to direct attention to a hazard, and slowed down in anticipation of a dangerous situation. Drivers who were not provided directional alerting did not respond as strongly to the unnecessary activation, possibly because the false-positive alerts were expected, or because they quickly scanned the environment and determined that there was no hazard. Directional alerting could be detrimental if false-positive activations are frequent. The driver's attention could be directed unnecessarily from a more important task, or the driver may lose trust in the system if the directional alert cannot identify any particular hazard.

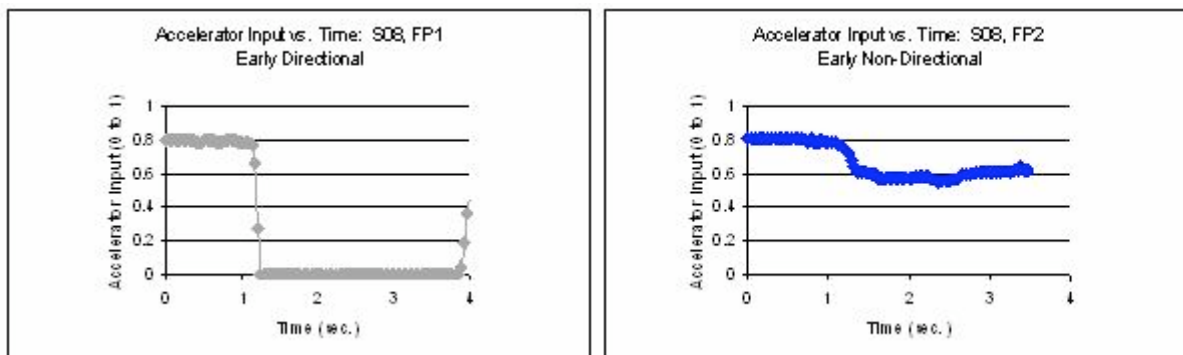

Figure 4-12: Example: accelerator input during unnecessary alert activations; first exposure to the Early Directional FCWS (1 of 2).

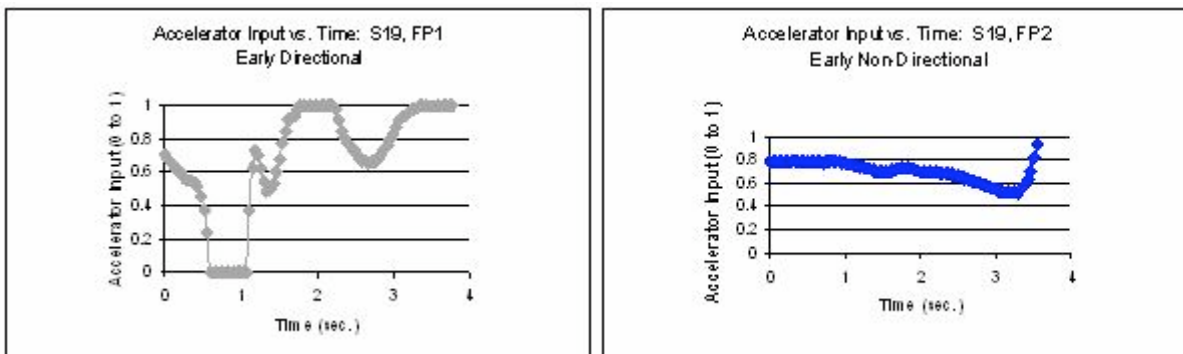

Figure 4-13: Example: accelerator input during unnecessary alert activations; first exposure to the Early Directional FCWS (2 of 2).

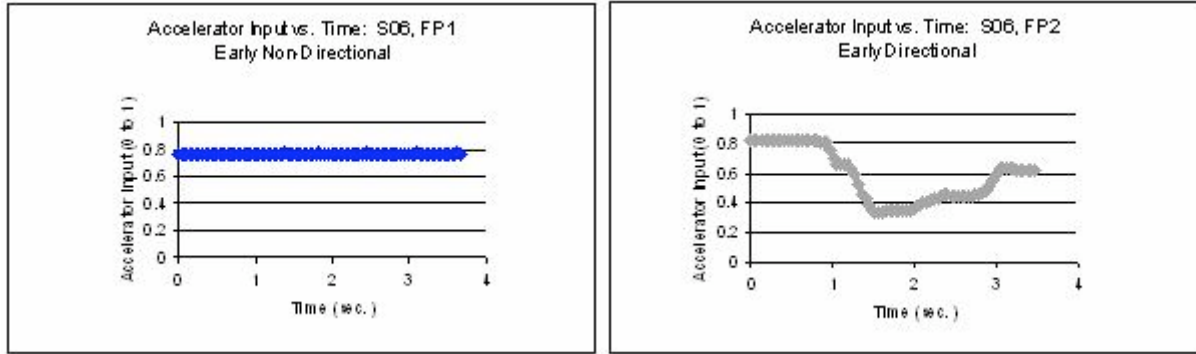

Figure 4-14: Example: accelerator input during unnecessary alert activations; first exposure to the Early Non-Directional FCWS (1 of 2).

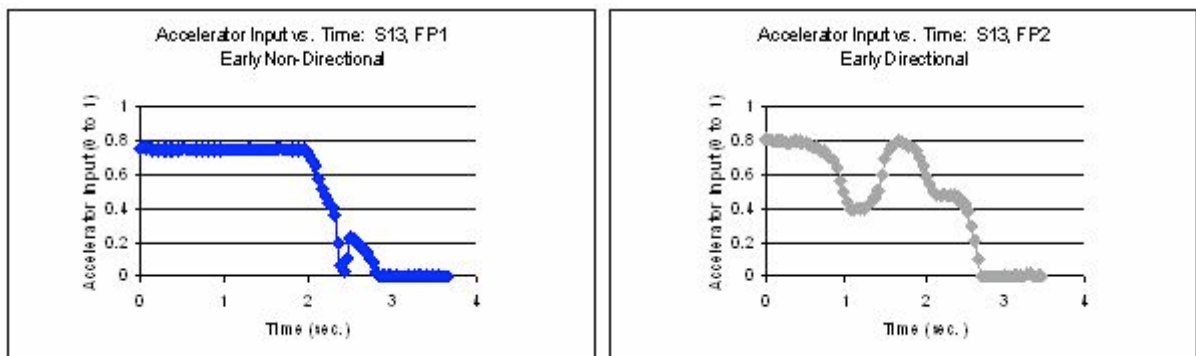

Figure 4-15: Example: accelerator input during unnecessary alert activations; first exposure to the Early Non-Directional FCWS (2 of 2).

Unnecessary alerts are not contained to the prearranged false-positive system activations. If the driver crosses the early alert threshold with respect to a non-target vehicle, and avoids a collision without performing any measurable response, the early alert is considered unnecessary (Table 4-14). This occurred frequently with the cyclists on the side of the road (as well as with other stopped and moving vehicles)—as the subject would steer back towards the road, the alerting system would activate because of the cyclist, but then deactivate as the turn continued towards the designated lane. Despite the fact that drivers using the early alerting systems were subject to extraneous stimuli, both during these unnecessary alerts and during the controlled false-positive activations, the subjective responses indicate that most saw them as useful, if not preferred over systems that did not provide early alerting.

Table 4-14: Unnecessary early alert activations.

FCWS Configuration	Unnecessary Alerts
--------------------	--------------------

Early Non-Directional	32
Early Directional	34

4.6. Subjective Responses

In general, subjects preferred multi-stage and directional alerting to the Late Alerting Only and No Alerting system configurations. When asked to rate the usefulness of early alerting, 75% of the subjects preferred a multi-stage FCWS that alerted at earlier thresholds (Figures 4-16, 4-17). In particular, drivers felt as if they received the most benefit when they were distracted with the map-reading task. There were concerns with the frequency of unnecessary alerts, especially during high-density traffic situations; however, some subjects thought that unnecessary activations were still helpful, because they helped maintain vigilance, while others were forgiving of the alerts, because they expected false-positives. Those who did not find early alerting to be useful generally were intolerant of the rate at which the early alert activated, whether necessary or unnecessary. Some subjects also felt complacent when alerting was provided, and they found themselves paying more attention to the roadway during the No Alerting configuration when they knew that no early alerting system was actively assisting them. These negative responses raise applicable concerns, but they reflect a minority opinion.

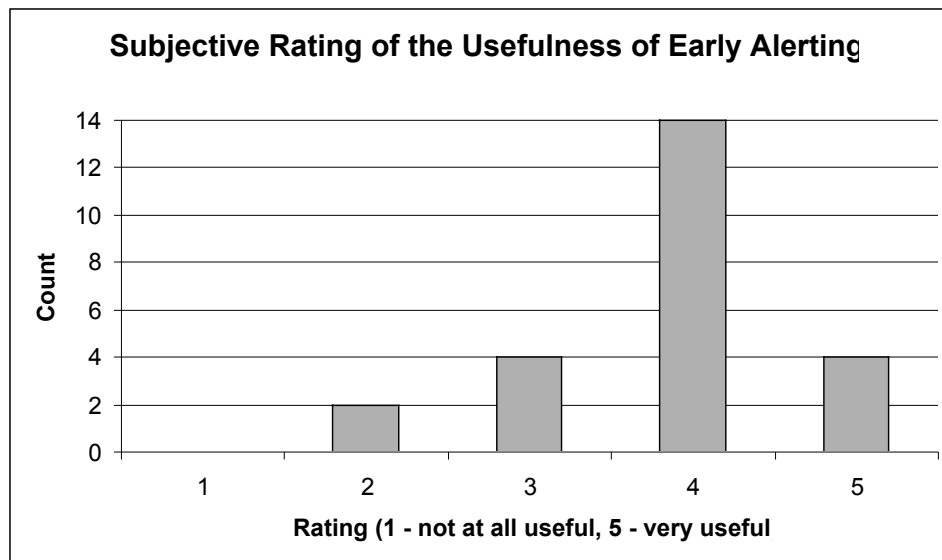

Figure 4-16: Subjective rating of the usefulness of early alerting.

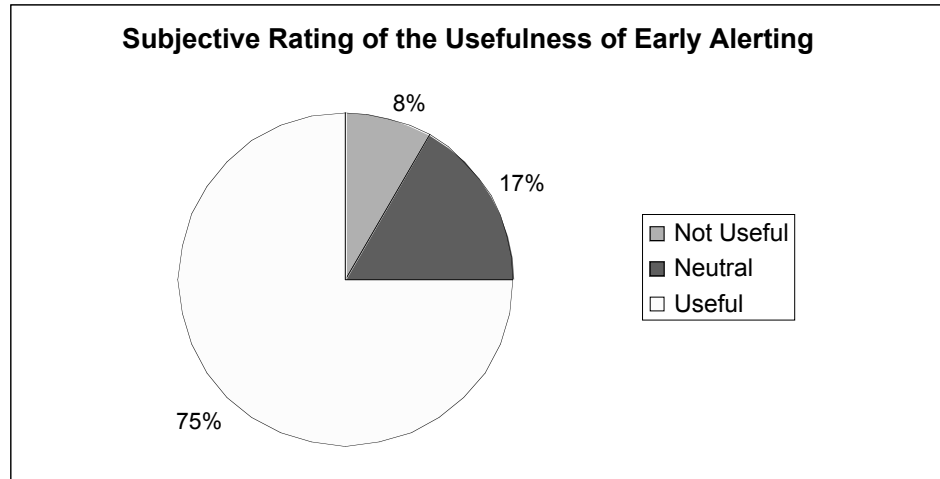

Figure 4-17: Percentages of subjects who thought early alerting was useful, not useful, or were unsure.

Subjects were asked how certain or uncertain they would be that the different alerting systems would help them avoid a collision if they were to enter a hazardous situation. Most expressed confidence in the two early alerting system configurations, while many were not confident that the Late Alerting Only system would be beneficial (Figure 4-18). Of the early alerting systems, subjects were most confident in the Early Directional system configuration (Figure 4-19). They appreciated being shown “exactly where the problem is,” and having the advanced notice to avoid the hazard without having to perform a last-second emergency maneuver. Most found the directional alerting easy to understand and use, and thought that it was particularly beneficial during those threat events in which the hazard was approaching the main roadway from the side.

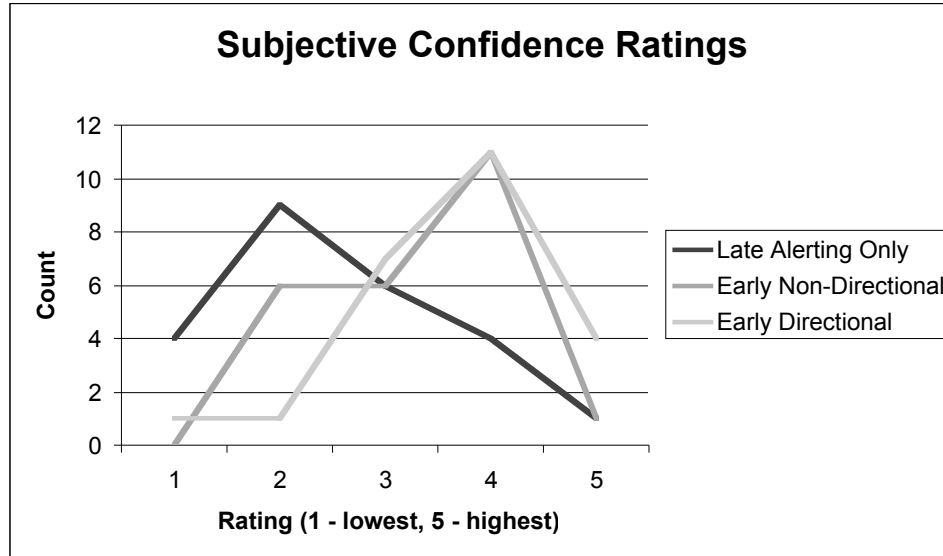

Figure 4-18: Subjective confidence ratings for each of the alerting systems.

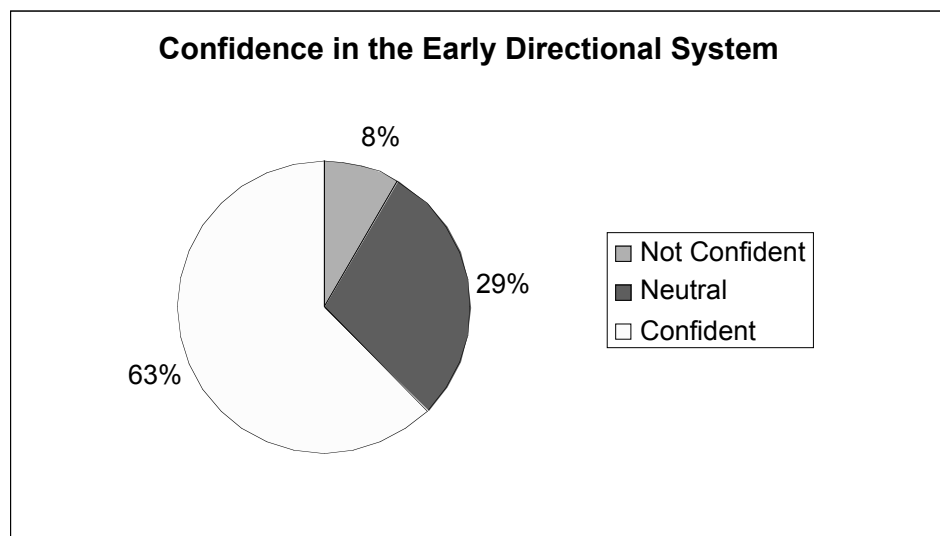

Figure 4-19: Percentage of subjects who were confident in the Early Directional system configuration, not confident, or were unsure.

The Early Non-Directional alerting system provided advanced notice as well, but subjects acknowledged that it took time to discover the hazard (Figure 4-20). However, some felt as if the non-directional alert was sufficient in identifying hazards, and that the directional alert was confusing. These subjects either preferred to search for the hazard without assistance, or they thought that directional alerting was unnecessary because the hazards were obvious. There is the possibility of a directional alert distracting the driver during a critical situation, but most accepted the additional

assistance. One of the reasons directional alerting appealed to several subjects, was because the drivers were able to understand what caused the alert activation. As predicted, this supported their trust in the system.

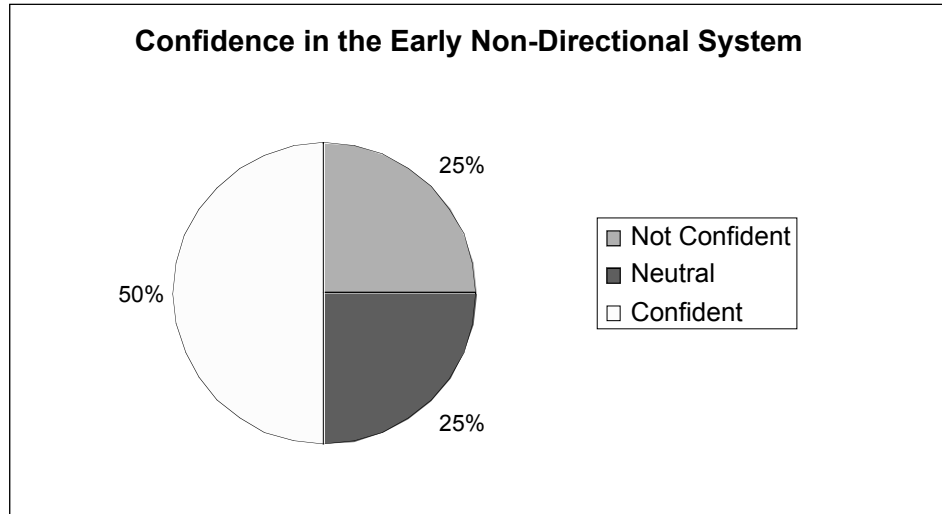

Figure 4-20: Percentage of subjects who were confident in the Early Non-Directional system configuration, not confident, or were unsure.

Subjects were generally not confident that a single late alert would be beneficial (Figure 4-21), but they did feel as if the late alert was more useful in combination with an early alert. Many, however, disliked the intrusiveness of the late alert display. They described the audible alert as “frantic,” “upsetting,” and generally undesirable. Some did acknowledge that, while unpleasant, the late alert was an effective last-second warning; however, the invasive stimulus invoked a near-zero tolerance for unnecessary activations. Subjects tolerated, and preferred, frequent early alerts partly because they were unobtrusive, unlike the late alert.

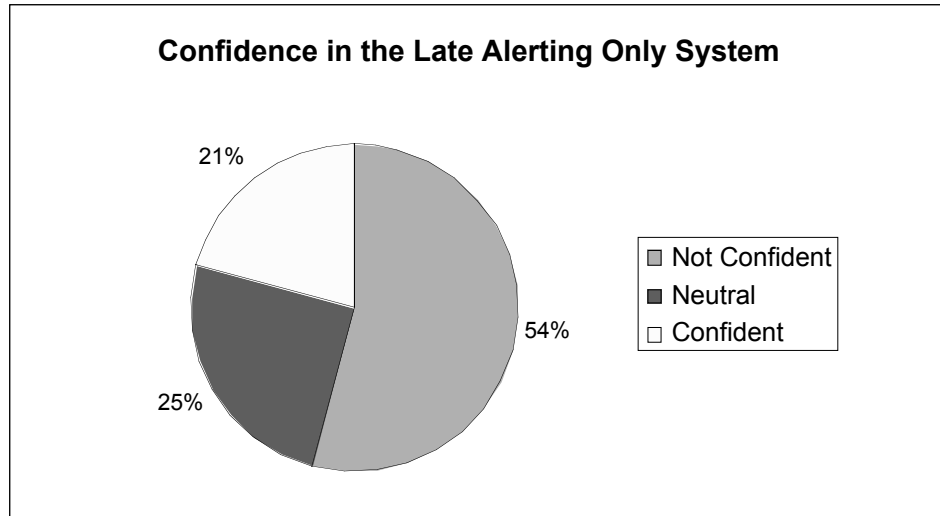

Figure 4-21: Percentage of subjects who were confident in the Late Alerting Only system configuration, not confident, or were unsure.

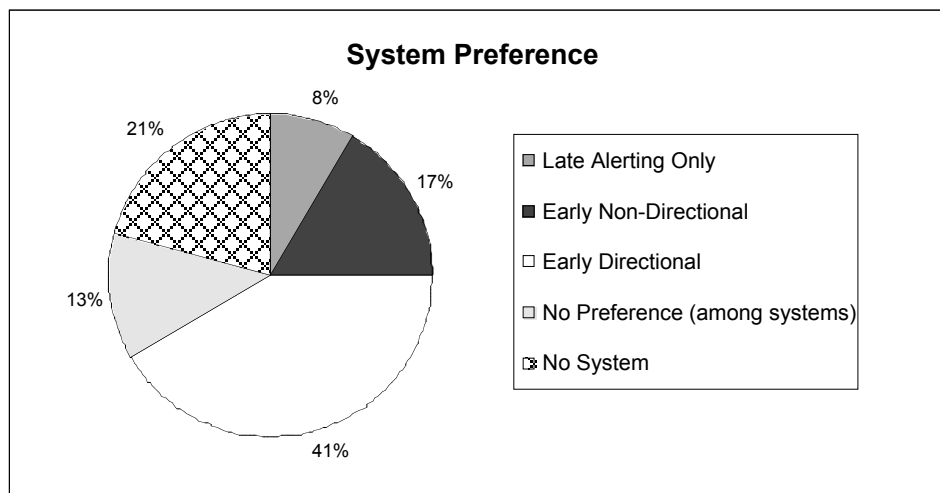

Figure 4-22: Percentage of subjects' system configuration preferences.

When asked which system they preferred, most indicated the Early Directional alerting system (Figure 4-22). More subjects preferred the Early Non-Directional system to the Late Alerting Only system, but 13% preferred each of the three systems equally. Approximately one fifth of the subject did not prefer any alerting system. When asked if they would prefer to own a vehicle with a FCWS, the most common concern was cost. Many expressed interest in the system, but were not sure if they could commit to the technology (Figure 4-23). Some said that the system would need to be more “accurate” or “reliable,” and not activate unnecessarily too often. Alert tolerance can vary among different people (and at different times), therefore incorporating the ability to customize

the alert thresholds may increase acceptance. However, providing the ability to make personal adjustments could possibly undermine the effectiveness of the system. The subjects acknowledged that it would take time to learn to use the system effectively, and that the nature of the implementation would influence the decision. Several subjects also said that if the FCWS had been proven to be effective, they would be more inclined to purchase a vehicle that was equipped with an alerting system.

Of the 62% of subjects who would prefer to own a FCWS-equipped vehicle, 40% had no preference among the systems (Figure 4-24). Of the remaining subjects, most would prefer the Early Directional system, followed by Early Non-Directional, and lastly Late Alerting Only.

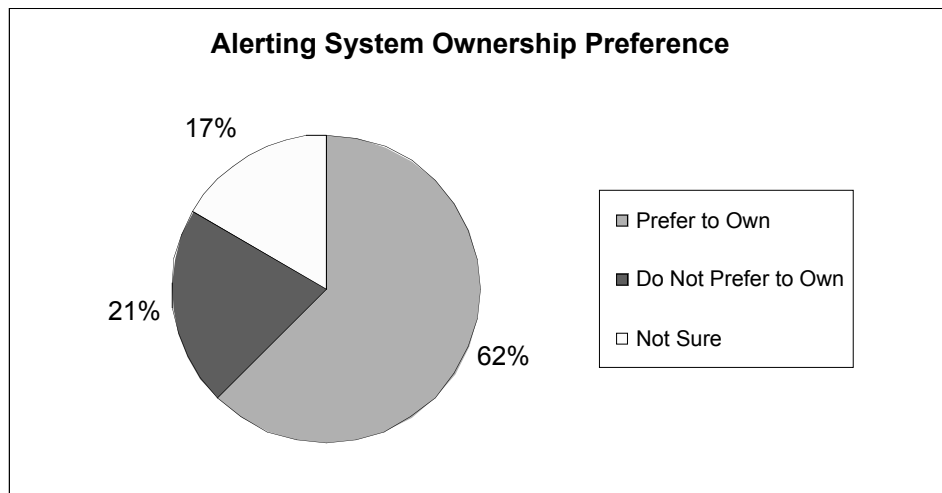

Figure 4-23: Percentage of subjects who would prefer to own a FCWS, would not prefer to own one, or were unsure.

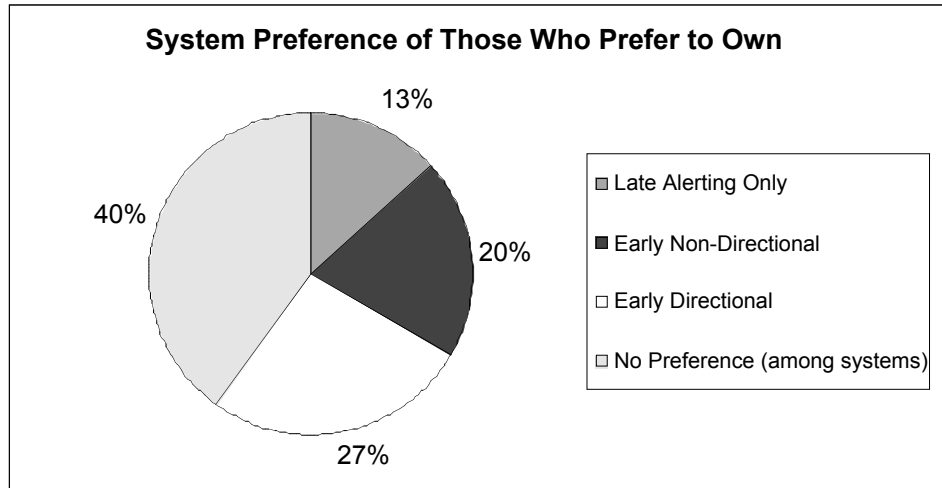

Figure 4-24: Percentage of subjects' system configuration preferences of those who would prefer to own a FCWS.

Despite an overall acceptance of multi-stage and directional alerting, the subjects had several suggestions for improvements. For example, providing additional information with the alerts may assist the driver in performing the most appropriate response. Assuming that the extra information does not saturate the driver's cognitive workload, drivers may benefit if they knew more specifically which threat the algorithms were predicting (e.g., "lead vehicle deceleration" or "possible lane incursion"). Similarly, incorporating predictive elements with the early alert displays may support the driver's projection of the future dynamic state of the hazard. Some suggested adding an audio tone to the early alert to direct attention back to the road if the driver was distracted and looking elsewhere. There were concerns with the displays as well, and their potential to visually distract the driver. One subject suggested using "current points of focus," such as the speedometer, instead of implementing an additional display.

5. Conclusions

A FCWS that alerts the driver to hazards in front of the vehicle provides the greatest opportunity for preventing collisions that would otherwise result in injury or death. This potential benefit, however, can only be achieved if the FCWS can ensure that the driver effectively interprets an alert with enough time to avoid a potential collision. There is a fundamental trade-off between providing the driver more time in which to respond, and alerting the driver unnecessarily. The probability of a successful response increases when the driver has more time and distance in which to identify the hazard and execute the most appropriate maneuver. However, alerting the driver at earlier, more conservative thresholds increases the probability that the alerts are unnecessary, either because sensor error has falsely identified a hazard or because the environment has changed such that the hazard is no longer a threat. Frequent unnecessary alerts degrade alert effectiveness by reducing trust in the system, but setting alert thresholds too close to the hazard risks an unsuccessful response.

The human-factors issues pertaining to a FCWS were analyzed using an Integrated Human-Centered Systems (IHCS) approach, from which two design features were proposed: multi-stage alerting, which alerts the driver at an earlier, conservative threshold, in addition to a more serious, late threshold; and directional alerting, which provides the driver information regarding the location of the hazard that prompted the alert activation. Alerting the driver earlier increases the probability of a successful response by conditioning the driver to respond more effectively if and when evasive action is necessary. Directional alerting decreases the amount of time required to identify the hazard, while promoting trust in the system by informing the driver of the cause of the alert activation. The proposed design features were incorporated into four FCWS configurations: one that provided no alerting, one that provided only a single late alert, and two that provided early alerts in addition to the late alerts. The two early alerting systems were divided into two categories, one of which provided non-directional early alerting and the other which provided directional early alerting. An experiment was conducted in which subjects were equipped with the various configurations and placed in unique situations that were designed to result in a collision if they did not respond effectively. Driver response behavior was analyzed for each of the alerting system configurations.

Drivers who were equipped with multi-stage and directional alerting avoided hazardous situations more effectively than drivers who were not provided early alerting. When equipped with directional alerting, subjects were consistently able to avoid more collisions and more late alert threshold crossings. Subjects with directional alerting tended to maintain farther distances from hazards, which increased the probability that the responses were successful. When a collision did occur with a hazard that was not initially on the road in front of the driver, the relative velocity at impact was highest when subjects were not alerted and lowest when subjects were alerted early. During this event, no collision occurred with directional alerting, which indicates that specifically directing the driver's attention to hazards beyond the immediate forward environment promotes the most effective response.

The TTC values at which the subjects first responded tended to be farther from the hazard for subjects using the early directional alerting system. Also, there was less variability among the response times for the early alerting systems, which may suggest system effectiveness across a wider range of driving abilities. When subjects responded, most chose to release the accelerator as opposed to a more committing maneuver such as steering or braking. Milder responses (such as releasing the accelerator) require more time to perform, but they decrease the probability that a driver will lose control or inadvertently cause another accident while performing an evasive maneuver. Multi-stage alerting enables milder responses, because the alerts provide more time in which to perform the maneuver.

As seen in the velocity profiles, subjects who experienced collisions attempted to slow down at maximum deceleration, but the onset of the response was later than other more effective maneuvers. Without steering to avoid the hazard, a collision was unavoidable. The driver may have been unaware of what was required to avoid a collision, but had the response been made earlier the maneuver may have been successful. This behavior is reflected in the plots of relative velocity vs. range. These plots also indicate a clear distinction between drivers who were and were not provided early alerting during the event in which a lead vehicle decelerates because of traffic up ahead. Drivers who were alerted earlier began braking farther from the hazard, more effectively avoiding both collisions and late alert threshold crossings.

When subjects were exposed to the FCWS, without prior knowledge that their vehicle would be equipped with an alerting system, the early alerting systems were

least effective. When subjects were unfamiliar with the alerting stimulus, the braking response was delayed, possibly indicating lack of awareness or confusion. This supports the case for a system that alerts earlier and more frequently: by consistently exposing the driver to the alerting stimulus, drivers will develop an understanding of the system and how it works. Familiarity promotes trust, which enhances alert effectiveness.

During the pre-determined unnecessary system activations, drivers who were using the Early Directional system displayed more cautious responses, regardless of whether or not the directional alerting false-positive was shown first or second during the testing scenario. The system was designed to direct the driver's attention to the location of a hazard, and therefore subjects were responding appropriately, expecting to see a cause for concern. Frequent activations in the absence of a threat could degrade the driver's trust in the system, but the majority of subjective responses do not indicate dissatisfaction or annoyance.

There were numerous occasions when the early alerting systems activated unnecessarily, but drivers indicated a high level of acceptance, confidence, and trust in multi-stage and directional alerting. Three-quarters of the subjects thought that the early alerts were useful, and although some were concerned with the frequency of unnecessary activations, the majority of subjects preferred the additional support. Drivers were most confident in the system that would provide directional and multi-stage alerting, followed by non-directional multi-stage alerting and late alerting only.

Given the generous amounts of positive feedback, and the observations of driver response behavior, a FCWS that incorporates directional and multi-stage alerting will effectively assist drivers in identifying, assessing, and avoiding hazardous situations, thereby reducing the number of collisions, and actively supporting driver safety.

6. References

- [1] NCSA, "Traffic Safety Facts 2005: A Compilation of Motor Vehicle Crash Data from the Fatality Analysis Reporting System and the General Estimates System.," NHTSA, NCSA, DOT, Washington, DC DOT HS 810 631, 2005.
- [2] NCSA, "Estimates of Motor Vehicle Traffic Crash Fatalities and People Injured: 2006," NHTSA, Washington, DC, online presentation DOT HS 810 755, May 25 2007.
- [3] J. K. Kuchar, "Collision alerting system evaluation methodology for ground vehicles," presented at Transportation Sensors and Controls: Collision Avoidance, Traffic Management, and ITS, 1997.
- [4] P. L. Zador, S. A. Krawchuk, and R. B. Voas, "Final Report -- Automotive Collision Avoidance System (ACAS) Program," NHTSA, Washington, DC DOT HS 809 080, August 2000.
- [5] J. K. Kuchar, "A Unified Methodology for the Evaluation of Hazard Alerting Systems," in *MIT International Center for Air Transportation, Department of Aeronautics & Astronautics*, vol. Ph.D. Cambridge, MA: Massachusetts Institute of Technology, 1995, pp. 167.
- [6] R. J. Hansman, J. K. Kuchar, J. P. Clarke, S. Vakil, R. Barhydt, and A. Pritchett, "Integrated human centered systems approach to the development of advanced cockpit and air traffic management systems," 1997.
- [7] R. M. Clarke, M. J. Goodman, M. Perel, and R. R. Knipling, "Driver Performance and IVHS Collision Avoidance Systems: A Search for Design-Relevant Measurement Protocols," presented at ITS America Annual Meeting, Washington, DC, 1994.
- [8] M. R. Endsley, *Automation and Situation Awareness*. Mahwah, New Jersey: Lawrence Erlbaum, 1996.
- [9] M. R. Endsley, "Theoretical Underpinnings of Situation Awareness: A Critical Review," in *Situation Awareness Analysis and Measurement*, M. R. Endsley and D. J. Garland, Eds. Mahwah, NJ: Lawrence Erlbaum Associates, 2000, pp. 24.
- [10] M. R. Endsley, "Design and evaluation for situation awareness enhancement," presented at Human Factors Society 32nd Annual Meeting, Santa Monica, CA, 1988.
- [11] A. C. Stein, R. A. Solomon, and D. A. Zeidman, "Field evaluation of the Rader Control Systems (RCS) Radar Anti-Collision Warning System," D. o. T. NHTSA, Ed.: Systems Technology, Inc., 1992, pp. 81.
- [12] R. Ervin, S. Bogard, and P. Fancher, "Considering Radar Detection of Vehicles in a String for Gaining Situation Awareness of a Propagating Conflict," presented at Transportation Research Board 80th Annual Meeting, Washington, DC, 2001.
- [13] F. Kruse, F. Folster, M. Ahrholdt, H. Rohling, M.-M. Meinecke, and T.-B. To, "Target Classification Based on Near-Distance Radar Sensors," presented at Intelligent Vehicles Symposium, University of Parma, Italy, 2004.
- [14] U. Meis and R. Schneider, "Radar Image Acquisition and Interpretation for Automotive Applications," presented at Intelligent Vehicles Symposium, Columbus, Ohio, 2003.
- [15] W. Nagy and J. Wilhelm, "System and Parametric Tradeoffs of Forward Looking Automotive Radar Systems," presented at National Radar Conference, Ann Arbor, Michigan, 1996.

-
- [16] M. Skutek, M. Mekhail, and G. Wanielik, "A PreCrash System based on Radar for Automotive Applications," presented at Intelligent Vehicles Symposium, Columbus, Ohio, 2003.
- [17] B. Ulmer, "VITA - An Autonomous Road Vehicle (ARV) for Collision Avoidance in Traffic," presented at IEEE Intelligent Vehicles Symposium, 1992.
- [18] E. Dagan, O. Mano, G. P. Stein, and A. Shashua, "Forward Collision Warning with a Single Camera," presented at Intelligent Vehicles Symposium, University of Parma, Italy, 2004.
- [19] B. Ulmer, "VITA II - Active Collision Avoidance in Real Traffic," presented at Intelligent Vehicles '94 Symposium, Paris, France, 1994.
- [20] A. Broggi, A. Fascioli, M. Carletti, T. Graf, and M. Meinecke, "A Multi-resolution Approach for Infrared Vision-based Pedestrian Detection," presented at Intelligent Vehicles Symposium, University of Parma, Italy, 2004.
- [21] D. T. Linzmeier, M. Mekhail, D. Vogt, R. Prasanna, and K. C. J. Dietmayer, "Probabilistic Signal Interpretation Methods for a Thermopile Pedestrian Detection System," presented at Intelligent Vehicles Symposium, Las Vegas, Nevada, 2005.
- [22] Raytheon, "NightDriver Thermal Imaging Camera and HUD Development Program for Collision Avoidance Applications - Final Report," Raytheon Commercial Infrared, Dallas, TX DOT-HS-809-163, June 2000.
- [23] K. C. Fuerstenberg, D. T. Linzmeier, and K. C. J. Dietmayer, "Pedestrian Recognition and Tracking of Vehicles using a vehicles based Multilayer Laserscanner," presented at World Congress and Exhibition on Intelligent Transport Systems and Services, Madrid, Spain, 2003.
- [24] K. C. Fuerstenberg and J. Scholz, "Reliable Pedestrian Detection using Laserscanners," presented at Intelligent Vehicles Symposium, Las Vegas, Nevada, 2005.
- [25] R. Labayrade, C. Royere, and D. Aubert, "A Collision Mitigation System using Laser Scanner and Stereovision Fusion and its Assessment," presented at Intelligent Vehicles Symposium, Las Vegas, Nevada, 2005.
- [26] B. Alefs, D. Schreiber, and M. Clabian, "Hypothesis based vehicle detection for increased simplicity in multi-sensor ACC," presented at Intelligent Vehicles Symposium, Las Vegas, Nevada, 2005.
- [27] A. Amditis, A. Polychronopoulos, N. Floudas, and L. Andreone, "Fusion of infrared vision and radar for estimating the lateral dynamics of obstacles," *Information Fusion*, vol. 6, pp. 129–141, 2004.
- [28] S. Y. Sohn and R. Stepleman, "Meta-analysis on total braking time," *Ergonomics*, vol. 41, pp. 1129-1140, 1998.
- [29] J. K. Kuchar, "Managing Uncertainty in Decision-Aiding and Alerting System Design," presented at 6th CNS/ATM Conference, Taipei, Taiwan, 2001.
- [30] R. A. Rensink, J. K. O'Regan, and J. J. Clark, "To See or Not to See: The Need for Attention to Perceive Changes in Scenes," *Psychological Science*, vol. 8, pp. 368-373, 1997.
- [31] R. v. d. Horst and J. Hogema, "Time-to-Collision and Collision Avoidance Systems," presented at 6th ICTCT Workshop, Salzburg, 1993.
- [32] L. Yang, J. H. Yang, E. Feron, and V. Kulkarni, "Development of a Performance-Based Approach for a Rear-End Collision Warning and Avoidance System for Automobiles," presented at IEEE Intelligent Vehicles Symposium, Columbus, OH, 2003.

-
- [33] J. Hillenbrand, K. Kroschel, and V. Schmid, "Situation Assessment Algorithm for a Collision Prevention Assistant," presented at Intelligent Vehicles Symposium, Las Vegas, Nevada, 2005.
- [34] A. Burgett and R. J. M. Jr., "A New Paradigm for Rear-end Crash Prevention Driving Performance," NHTSA, Washington, DC SAE 2001-01-0463, March 2001.
- [35] A. L. Burgett, A. Carter, R. J. Miller, W. G. Najim, and D. L. Smith, "A Collision Warning Algorithm for Rear-End Collisions," presented at 16th International Technical Conference on Enhanced Safety of Vehicles, Washington, DC, 1998.
- [36] T. L. Brown, J. D. Lee, and D. V. McGehee, "Human performance models and rear-end collision avoidance algorithms," *Human Factors*, vol. 43, pp. 462-482, 2001.
- [37] T. A. Dingus, D. V. McGehee, N. Manakkal, S. K. Jahns, C. Carney, and J. M. Hankey, "Human Factors Field Evaluation of Automotive Headway Maintenance/Collision Warning Devices," *Human Factors*, vol. 39, pp. 216-229, 1997.
- [38] J. L. Campbell, C. M. Richard, J. L. Brown, and M. McCallum, "Crash Warning System Interfaces: Human Factors Insights and Lessons Learned," NHTSA, Washington, DC DOT HS 810 697, January 2007.
- [39] "44 Crashes," General Motors Corporation; NAO Engineering, Safety and Restraints Center, Crash Avoidance Department, Detroit, Michigan, v 3.0 January 1997.
- [40] W. G. Najm and J. D. Smith, "Development of Crash Imminent Test Scenarios for Integrated Vehicle-Based Safety Systems (IVBSS)," NHTSA, Washington, DC DOT VNTSC-NHTSA-07-01, DOT HS 810 757., April 2007.
- [41] R. C. Curry, J. A. Greenberg, and R. J. Kiefer, "NADS versus CAMP Closed-Course Comparison Examining "Last-Second" Braking and Steering Maneuvers Under Various Kinematic Conditions," Crash Avoidance Metrics Partnership, Farmington Hills, MI DOT HS 809 925, August 2005.
- [42] E. Stern, V. Barth, W. Durfee, M. Rosen, T. Rosenthal, E. Schold-Davis, C. Schaffer, J. Wachtel, M. Watson, and J. Zola, "A Protocol for Avoiding Driving Simulator Sickness," presented at 2006 STISIM Users Conference, MIT AgeLab, Cambridge, MA, 2006.
- [43] L. Angell, J. Auflick, P. A. Austria, D. Kochhar, L. Tijerina, W. Biever, T. Diptiman, J. Hogsett, and S. Kiger, "Driver Workload Metrics Project: Final Report," NHTSA, Washington, DC DOT HS 810 635, November 2006.
- [44] L. Angell, J. Auflick, P. A. Austria, D. Kochhar, L. Tijerina, W. Biever, T. Diptiman, J. Hogsett, and S. Kiger, "Driver Workload Metrics Project: Final Report - Appendices," NHTSA, Washington, DC DOT HS 810 635, November 2006.

Appendix A: Treatment Summary

Testing Scenario Treatments

Table A-1: Testing scenario treatment order (key below).

Subject	Testing Treatments							
1	T3	T3	T1	T1	T4	T4	T2	T2
2	T2	T2	T3	T3	T1	T1	T4	T4
3	T2	T2	T3	T3	T4	T4	T1	T1
4	T1	T1	T4	T4	T3	T3	T2	T2
5	T4	T4	T1	T1	T3	T3	T2	T2
6	T3	T3	T1	T1	T2	T2	T4	T4
7	T2	T2	T1	T1	T4	T4	T3	T3
8	T1	T1	T2	T2	T4	T4	T3	T3
9	T4	T4	T2	T2	T1	T1	T3	T3
10	T4	T4	T3	T3	T2	T2	T1	T1
11	T2	T2	T1	T1	T3	T3	T4	T4
12	T3	T3	T4	T4	T2	T2	T1	T1
13	T3	T3	T4	T4	T1	T1	T2	T2
14	T2	T2	T4	T4	T3	T3	T1	T1
15	T1	T1	T3	T3	T4	T4	T2	T2
16	T1	T1	T3	T3	T2	T2	T4	T4
17	T2	T2	T4	T4	T1	T1	T3	T3
18	T4	T4	T1	T1	T2	T2	T3	T3
19	T1	T1	T4	T4	T2	T2	T3	T3
20	T4	T4	T3	T3	T1	T1	T2	T2
21	T3	T3	T2	T2	T4	T4	T1	T1
22	T3	T3	T2	T2	T1	T1	T4	T4
23	T1	T1	T2	T2	T3	T3	T4	T4
24	T4	T4	T2	T2	T3	T3	T1	T1
	TE1	TE2	TE3	TE4	TE5	TE6	TE7	TE8

FCWS Configuration Key:

- T1: No Alerting
- T2: Late Alerting Only
- T3: Early Non-Directional + Late Alerting
- T4: Early Directional + Late Alerting

Training Scenario Treatments

Table A-2: Training scenario treatment order (key below).

Subject	Training Treatments				
1	T4	T4	T2	T1	T3
2	T2	T2	T1	T4	T3
3	T2	T2	T3	T1	T4
4	T2	T2	T3	T4	T1
5	T3	T3	T4	T1	T2
6	T4	T4	T3	T2	T1
7	T4	T4	T2	T3	T1
8	T3	T3	T4	T1	T2
9	T2	T2	T4	T1	T3
10	T2	T2	T4	T3	T1
11	T4	T4	T1	T2	T3
12	T3	T3	T1	T2	T4
13	T3	T3	T2	T4	T1
14	T3	T3	T2	T1	T4
15	T4	T4	T3	T2	T1
16	T2	T2	T1	T3	T4
17	T3	T3	T2	T1	T4
18	T4	T4	T2	T3	T1
19	T2	T2	T1	T3	T4
20	T3	T3	T1	T4	T2
21	T4	T4	T1	T3	T2
22	T2	T2	T1	T4	T3
23	T3	T3	T4	T2	T1
24	T4	T4	T3	T1	T2
	Naïve	TE	TE	TE	TE

FCWS Configuration Key:

- T1: No Alerting
- T2: Late Alerting Only
- T3: Early Non-Directional + Late Alerting
- T4: Early Directional + Late Alerting

Appendix B: Threat Event Illustrations

Training Scenario Threat Event

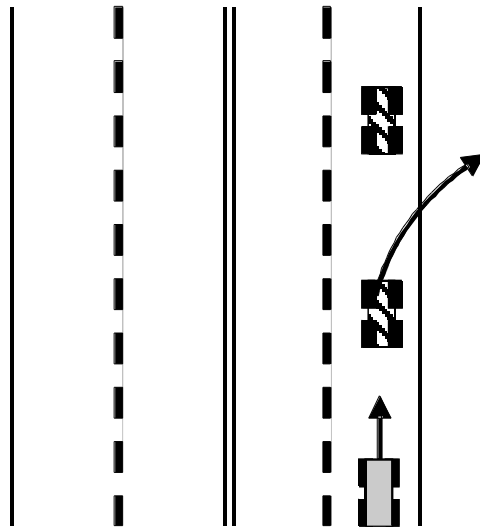

Figure B-1: Training Threat Event: a lead vehicle pulls off the road to uncover a stopped vehicle in the driver's lane.

Testing Scenario Threat Events

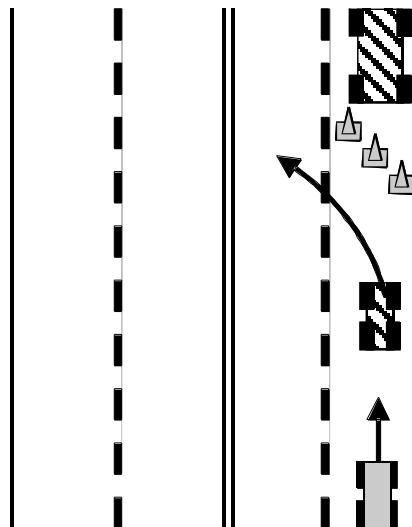

Figure B-2: Threat Event 1: Construction blocking the driver's lane.

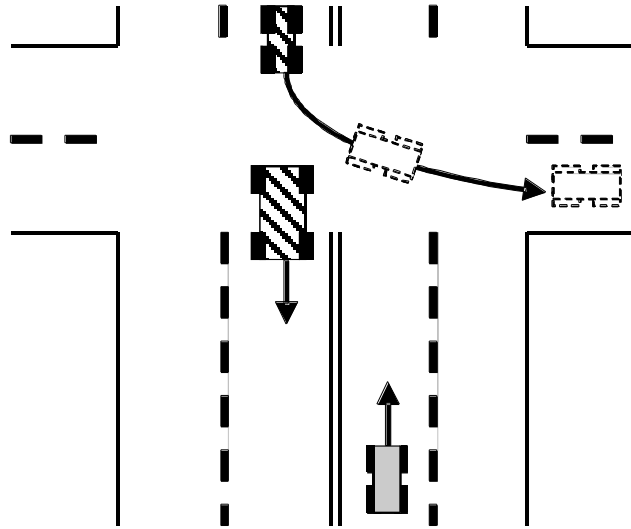

Figure B-3: Threat Event 2: Oncoming vehicle turning left in front of the driver.

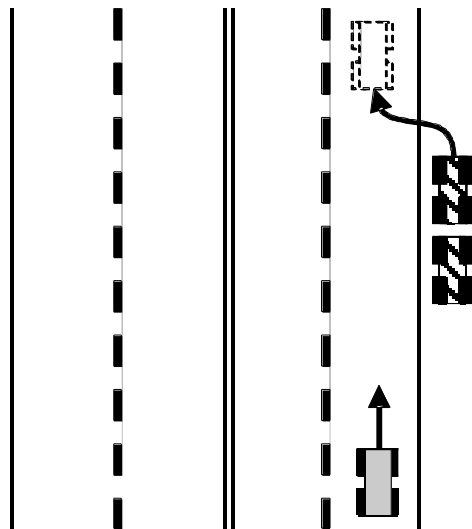

Figure B-4: Threat Event 3: Initially stopped vehicle pulls into the driver's lane.

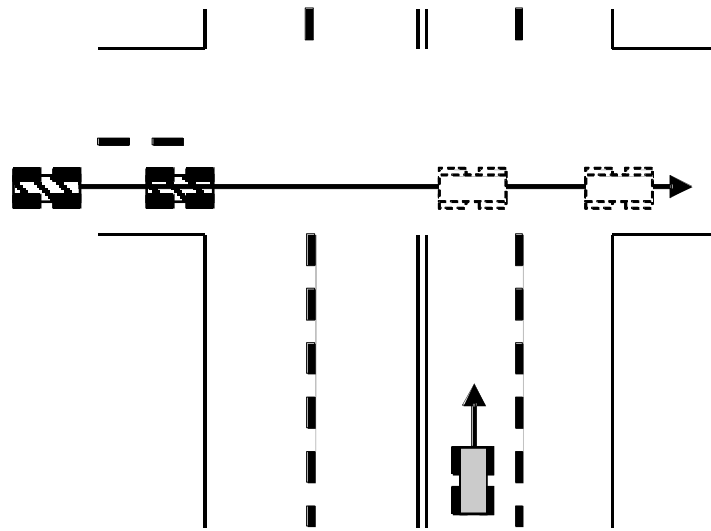

Figure B-5: Threat Event 4: A police officer chases another vehicle across the road.

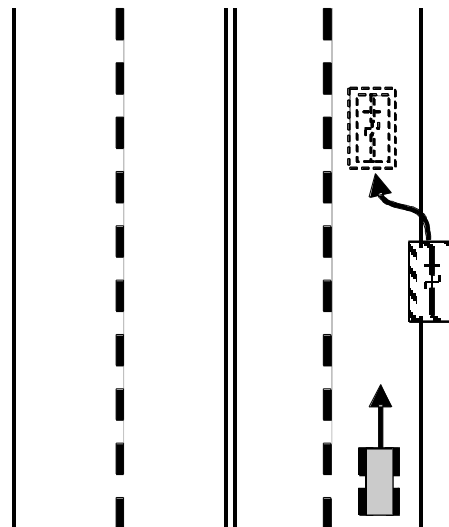

Figure B-6: Threat Event 5: A cyclist enters the driver's lane.

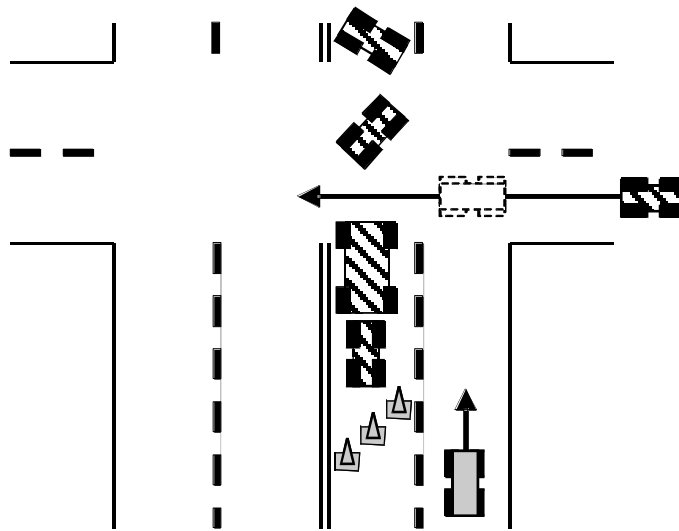

Figure B-7: Threat Event 6: With an accident in the left-hand lane, an ambulance crosses the road from the right.

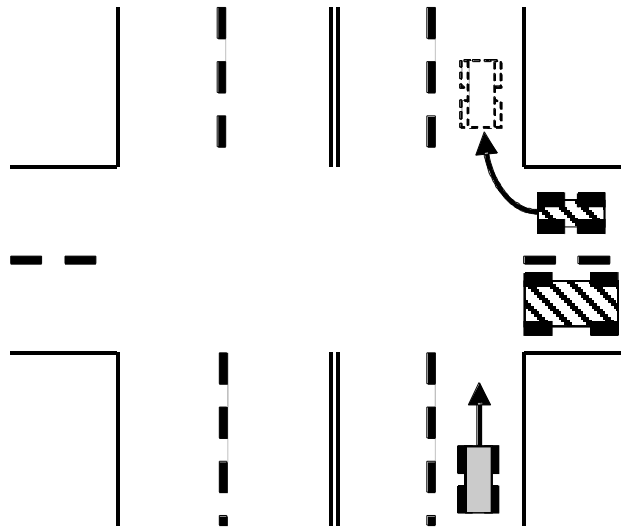

Figure B-8: Threat Event 7: An initially stopped vehicle makes a right-hand turn into the driver's lane.

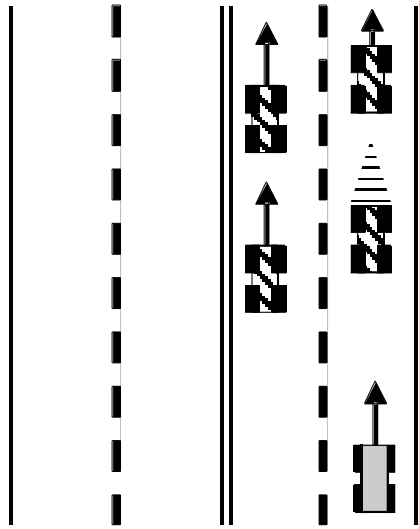

Figure B-9: Threat Event 8: A lead vehicle decelerates because of slow-moving traffic up ahead.

Appendix C: Subject Demographics

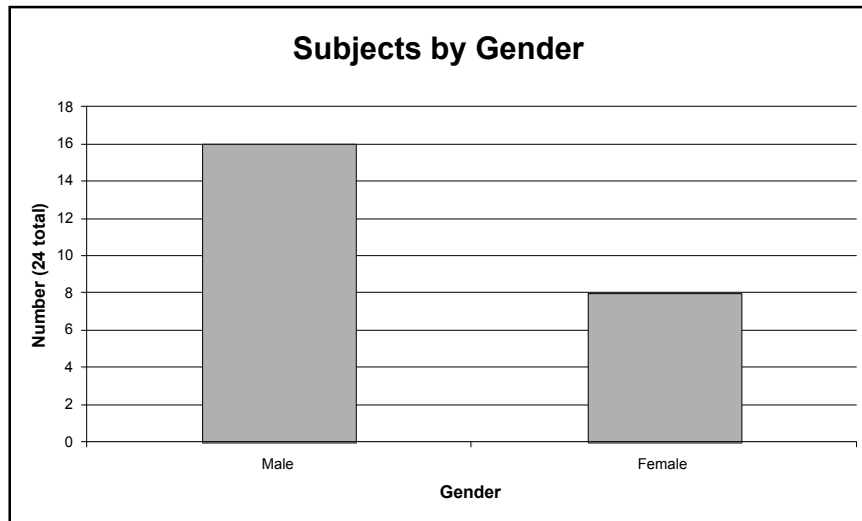

Figure C-1: Subject gender distribution.

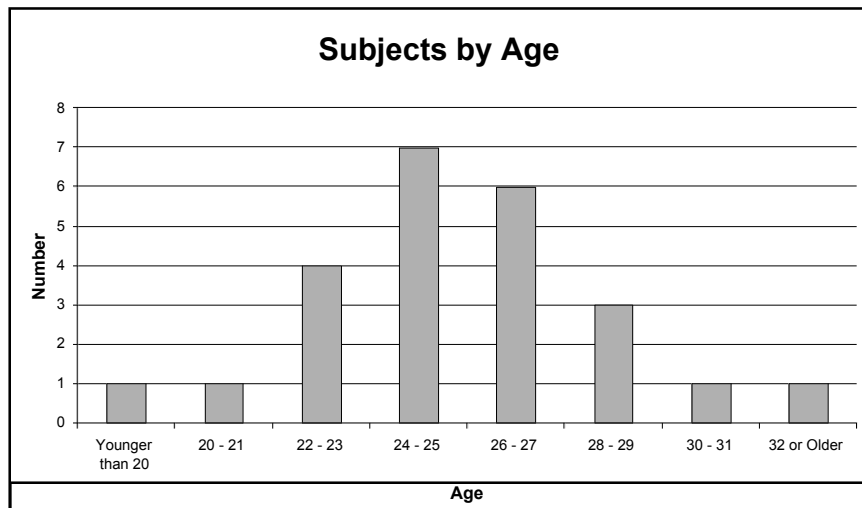

Figure C-2: Subject age distribution.

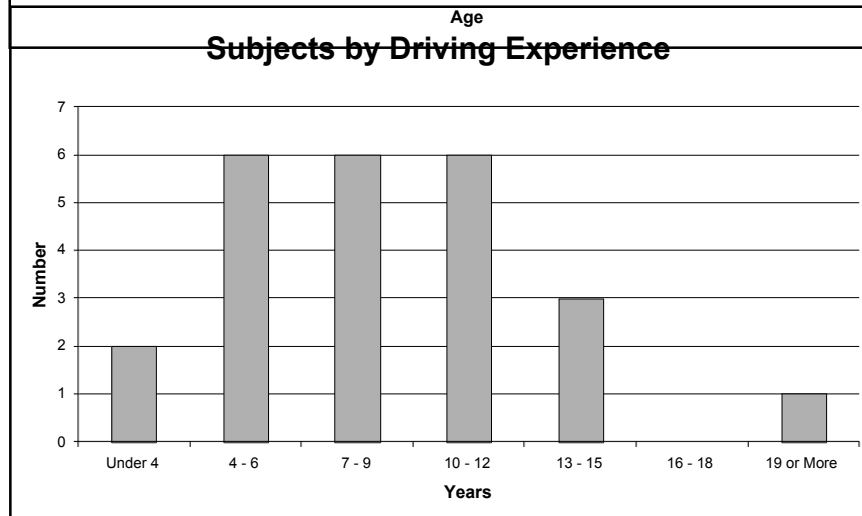

Figure C-3: Subject driving experience distribution.