

# Digital Materials for Digital Fabrication

by

George A. Popescu

**SUBMITTED TO THE PROGRAM IN MEDIA ARTS AND SCIENCES,  
SCHOOL OF ARCHITECTURE AND PLANNING IN PARTIAL  
FULFILLEMENT OF THE REQUIREMENTS FOR THE DEGREE OF**

**Master of Science**

**AT THE  
MASSACHUSETTS INSTITUTE OF TECHNOLOGY  
SEMPTEMBER 2007**

**© Massachusetts Institute of Technology, 2007  
All Rights Reserved**

Signature of Author:  
George A. Popescu  
Media Arts and Sciences



Thesis Advisor:  
Professor Neil Gershenfeld  
Director Center for Bits and Atoms  
Professor of Media Arts and Sciences



Accepted by:  
Prof. Deb Roy  
Chairperson  
Departmental Committee on Graduate Students



**ARCHIVES**

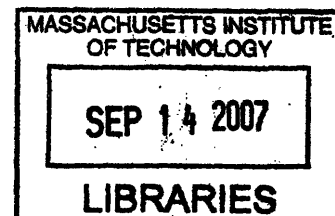

# Digital Materials for Digital Fabrication

by

George A. Popescu

Submitted to the Department of Media Arts and Sciences, School Architecture and Planning on August 20st, 2007 in partial fulfillment of the requirements for the degree of Master of Science

## Abstract

This thesis introduces digital materials by analogy with digital computation and digital communications. Traditional fabrication techniques include pick-and-place, roll-to-roll, molding, patterning and more. Current research in fabrication includes algorithmic assembly [3], programmed assembly[9], self-assembly[1,2], assembly by folding [4] as well as guided self-assembly [2]. While these research areas are studying means of fabrication, here we introduce the study of the digital materials they assemble. Moreover we present a new type of three-dimensional digital printer for use with functional digital materials. Most importantly, the digital materials are shown to be tuneable; the code describing a digital material allows one to predict and adjust the properties of the material itself.

In the same way digital communications and computation are discrete in the code space, digital fabrication is discrete in the physical space. Just as digital communications enabled cheap long-distance communications and digital computation enabled cheap,universal and efficient computers, digital fabrication enables cheap, efficient and universal fabrication. Building digitally will reduce the complexity of the assembler and can produce a wider variety of objects for a smaller cost.

Thesis Supervisor: Professor Neil Gershenfeld

Title: MIT Media Laboratory

# Digital Materials for Digital Fabrication

by

George A. Popescu



Thesis Advisor:

  
Professor Neil Gershenfeld  
Director, Center for Bits and Atoms  
Professor of Media Arts and Sciences

Thesis Reader:

  
Professor Joseph Jacobson  
Associate Professor of Media Arts and Sciences  
MIT Media Laboratory

Thesis Reader:

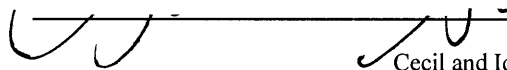
  
Professor Larry Sass  
Cecil and Ida Green Career Development Professor  
Assistant Professor  
Director: Digital Design Fabrication Group  
Massachusetts Institute of Technology

## Table of Contents

Abstract .....	2	GIK size scaling.....	28
Thank you .....	5	Complexity of GIK structures.....	29
Introduction.....	7	Methods.....	30
Background.....	8	Tera-structures.....	31
A. Digital Materials.....	13	B. Digital Printer.....	31
Definition of digital.....	13	1. Theory.....	31
Definition of digital material.....	15	Introduction.....	31
Multimaterial.....	16	Introduction.....	32
Type of connections.....	17	A simple machine is a cheap	
GIK introduction.....	17	machine.....	32
Description of the press-fit bond....	17	Vertical GIK.....	33
Analogy atom/bond/crystal with		Assembling Strategy.....	34
digital materials.....	19	Design principles.....	35
GIK structure reliability tool.....	20	The head.....	36
Error tolerance.....	21	GIK Feeder.....	38
Error reduction.....	22	Reconnection reliability.....	39
Error detection.....	23	2. Prototyping.....	41
Mechanical tuneability.....	24	Requirements.....	41
Isotropy by void.....	24	Calculations.....	42
Compression by void and		Design.....	43
alternate materials .....	24	Actuation .....	45
Tension tuneability.....	25	Future Work.....	47
Electrical tuneability.....	27	Conclusion.....	48
Orthogonal properties and tuneability		References.....	50
.....	28	Appendix.....	52

## Thank you

I would like to thank **Professor Neil Gershenfeld** for his guidance, for teaching me how to do research and for giving me the ideal means and environment to conduct scientific research. During the 21 months I worked with him I found out that I can learn infinitely more about computer science, electrical engineering, mechanical engineering, material science, hands on fabrication, machine tools, mathematics, physics, biology, all kind of chemistries, social engineering, computer networks, web-programming and research group organization. The most important lesson I will remember is that time is the most valuable resource I have.

I would like to thank **Jean Chang**, a senior in MIT's Mechanical Engineering department. as an UROP (Undergraduate Research Opportunity Program) student she highly contributed to the fabrication of the GIK assembler prototype.

I would like to thank **Professors Joe Jacobson and Larry Sass** for their guidance and suggestions.

I would like to thank **Professor Alexander Slocum** for his contagious mechanical engineering excitement and for allowing me to try to learn mechanical engineering in 3 months.

I would like to thank **Ara Knaian** for filling in for a Post-Doc position in all the domains above mentioned.

I would like to thank **Amy Sun** and all the past and present student in the Physics and Media group for their encouragements and help.

I would like to thank **Tushar Mahale** for his contributions and discussion to materials part of this thesis.

I would like to thank **Kathleen McCarthy** for supporting me during all this time while finishing my master thesis and for her help and encouragements.

And last but not least I would like to thank **Emalie Parkhurst** for all her help to applying to this program, for her encouragements and support.

## Introduction

Many research groups conduct research on fabrication. Eric Winfree et al. [3] described algorithmic assembly in which the structure to be built is built step by step where each step is a step in a computation. In his example of the construction of the Sierpinski triangle line by line, each line in the structure is in the same time structural but the information provided in that line is used to build the next line. Saul Griffith et al. [18] described self-replicating machines based on a template. The highly complex tiles of self-replicating machines are able to read the states of the tiles around them and make decisions.

I am going to study not these assembly processes but the materials in common to all of them. I will base study on recognizing their fundamental digital character, analogous, to the study of digital communications and computation by Nyquist, Shannon [16,17], Von Neumann, Winograd [2] and others.

Until now, commercial rapid prototyping techniques, including stereo lithography, fused deposition, powder/binder or melted metal, were using analog fabrication techniques. In addition the conventional three-dimensional printing processes are material-dependent, and are irreversible. Commercial free-form fabrication printers build by putting together small quantities of no more than a few expensive materials. In order to make high-resolution objects they need to be very precise and therefore cost between tens and hundreds of thousands of dollars and are operated by skilled technicians. On the other hand young children build 3-dimensional structures out of LEGO with their hands. LEGO structures are cheap, quick and easy to make, reversible and most importantly they are more precise than the kids who build them. However, they are big and are only made out of ABS plastic. Digital materials bring reversibility, simplicity, low cost and speed to free form fabrication in addition to a larger material set.

In the same way digital communications and computation are discrete in the code space, digital materials are discrete in the physical space. Digital material parts are able to do

very simple computation for error-tolerance and error-reduction. Digital structures-made out of digital materials-need to be assemble by a machine which contains the extra amount of computation needed to build the final structure. The code describing a digital material allows one to predict and adjust the properties of the material itself.

Therefore, unlike native materials which have properties that are not tunable, digital material can be built to have the properties ( mechanical, optical, electric, etc. ) one wants. Digital materials, as show in this thesis, are also active materials. Digital materials demonstrate error tolerance, error reduction and error detection which enable them to be used for cost and time effective additive free-form fabrication. Using additive assembly of digital materials demonstrates a better theoretical complexity per unit cost and time then existing fabrication techniques.

Traditional machine tools are moving in 3 dimension a tool tip which is cutting continuous amounts of material. This is an analog machine doing analog fabrication which we can also call analog/analog. In comparison to these machines we can imagine a machine which will do roll-to-roll placement of discrete electronic chips. Such a machine would be doing analog placement of digital parts and would be analog/digital fabrication. And finally the machine described in this thesis will digitally place digital materials and would therefore be a digital/digital fabrication process.

## ***Background***

Conventional three-dimensional printing processes are generally material-dependent and irreversible. Typically, conventional three-dimensional digital printers use continuous materials, with the digital specification being imposed by external logic. Conventional 3-dimensional fabrication is either additive or subtractive. Additive three-dimensional printers, such as those offered by Stratsys or Zcorp, work by depositing and/or bonding amorphous materials together in a way that results in a three-dimensional structure. Subtractive three-dimensional fabrication, such as with lathes or CNC milling machines, works by removing material from a block of bulk material. These techniques use complex control systems in order to precisely position the working tool in order to accurately build



the desired object. The substrates, typically powders and binders for additive processes, or blocks of raw material for subtractive processes, define the material and surface properties of the final product, but not its shape.

Existing Freeform Fabrication is mainly Analog Additive 3D Printing, as most existing assemblers build structures by dispensing small amounts of one or two different materials as droplets of very precise size and in very precise location. Most existing commercial free-form fabrication printers build by putting together small quantities of no more than a few expensive materials. In order to make high-resolution objects, they need to be very precise, and therefore they cost between tens and hundreds of thousands of dollars and must be operated by skilled technicians.

Existing technology in this field typically employs one of several processes. In one method, a component is constructed by depositing a first layer of a fluent porous material or porous solid. Next, a binder material is deposited to selected regions to produce a layer of material. A second method consists of incorporating a movable dispensing head provided with a supply of material which solidifies at a predetermined temperature or when exposed to light or UV light. Instead of dispensing drops, other apparatuses place a filament at the desired position then heat it to convert a portion of the filament to a flowable fluid that is solidified in that position. A third approach comprises fabricating a three-dimensional object from individual layers of fabrication material having a predetermined configuration. Successive layers are stacked in a predetermined sequence and fixed together to form the object. Refinements include producing parts from two distinct classes of materials, where the first class of material forms a three-dimensional shape defined by the interface of the first class of material and the second class of material.

Solid Freeform Fabrication (SFF) technologies depend on the use of computers to generate cross-sectional patterns representing the layers of the object being formed, and generally require the associated use of a computer and computer-aided design and manufacture (CAD/CAM) software. In general, these techniques rely on the provision of a digital representation of the object to be formed. The digital representation of the object

is reduced or "sliced" to a series of cross-sectional layers that can be overlaid to form the object as a whole. The stereolithography apparatus (SLA) or other apparatus for carrying out the fabrication of the object then utilizes the cross-sectional representations of the object for building the object on a layer-by-layer basis by, for example, determining the path of the laser beam in an SLA or the configuration of the mask to be used to selectively expose UV light to photosensitive liquids.

For example, in U.S. Pat. No. 6,623,687 (Gervasi et al.), Solid Freeform Fabrication or rapid prototyping techniques are used for quickly making complex or simple three-dimensional objects. In general, SFF processes enable rapid and accurate fabrication of three-dimensional objects which otherwise could be produced only by lengthy molding and machining processes. SFF techniques are, generally speaking, additive processes whereby the object to be formed is fabricated by reducing a model or representation of the object's ultimate configuration into a series of planar cross-sections and subsequently recompiling the cross-sections to reconstruct the object.

Stereolithography is one of several known SFF techniques. In this process, using an SLA, an ultraviolet laser beam selectively scans a reservoir of a photosensitive liquid along a predetermined path. Upon the laser beam being exposed to the portions of the liquid lying in the beam's path, the exposed portions of the liquid cure or solidify through polymerization. Examples of stereolithographic methods and equipment are disclosed in U.S. Pat. No. 5,256,340 (Allison).

Another known SFF process utilizes Cubital's Solider system. This process utilizes a photo-mask that represents the image of the particular layer of the object to be produced. The mask is positioned over a layer of photosensitive liquid. Selective solidification of the layer occurs upon exposure of ultraviolet light through the mask. Unsolidified resin is drained from the partially composed object leaving the desired configuration of surfaces and cavities. The cavities of the object are then filled with a liquid material having a relatively low melting point, such as wax. Upon solidification of the wax, the uppermost layer of the object is made uniform, such as by planing or milling. Then a new layer of the photocurable liquid is positioned on the surface. Another mask is created and the

process is repeated. Upon completion of production, the wax is melted and poured from the object to expose the configuration of the object. The object may comprise a plurality of interconnected, internal cavities or may be hollow.

Another known SFF techniques is plasma deposition, whereby plasma is deposited along a predetermined path and permitted to solidify to build an object on a layer by layer basis. One such additive technique is known as Laser Engineered Net Shaping (LENS) technology developed by Optomec, Inc., located in Albuquerque, New Mexico. The Optomec Directed Materials Deposition process uses a high power laser focused onto a substrate to melt the substrate surface. Metal powder is then blown into the melt pool to increase its volume. Subsequent scanning of the substrate relative to the laser beam provides a means to deposit thin metal lines on the substrate surface. With the addition of computer control, the Optomec system deposits the metal lines to form patterns on the substrate surface. Finally, this patterning method is coupled with the ability to interpret 3D CAD designs and allows those patterns to represent a series of slices through the part from the CAD system. Using this method, a component can be fabricated directly from a CAD solid model one layer at a time until the entire object is realized. The result is fully dense metal parts with dimensional accuracy.

Another way of making complex 3D objects is folding, as is seen, for example, in proteins, RNA, DNA, and other naturally occurring molecules [3,4]. The principle of this technique is that the sequence of the elements assembled determines how they will fold into the final, 3D object. The folding process does not require machines, but the parts required are very complex. Similarly, assembly of 2D or 3D objects using pick- and place mechanisms uses the precise location of the tool, as well as the shape properties of the components to determine the shape of the object to be built, thus still requiring complex control systems.

Stratasys FDM systems use a wide variety of production thermoplastics, including ABS, PC (polycarbonates), PPSF (polyphenylsulfones) and blends to manufacture real parts. For sacrificial support Stratasys FDM systems use WaterWorks and BASS breakaway support material.

Z Corp. 3D Printers use a powder-binder technology invented at and patented by the Massachusetts Institute of Technology to create parts directly from digital data. First, the 3D Printer spreads a thin layer of powder. Second, an ink-jet print head prints a binder in the cross-section of the part being created. Next, the build piston drops down, making room for the next layer, and the process is repeated. Once the part is finished, it is surrounded and supported by loose powder, which is then shaken loose from the finished part.

Other types of three-dimensional fabrication technologies involve structures built out of many discrete parts, in order to enable Avogadro-scale engineering and nano-fabrication of complex systems. These techniques include algorithmic assembly, programmed assembly, self-assembly, programmable self-assembly, and error correction self assembly. Digital materials are related to these technologies, as many fabrication techniques, including these, can build and use digital materials. Digital materials can be seen as a higher level of abstraction, as they are composed of elementary discrete parts which themselves are made of some material. Digital materials are fully described by the nature of the part they are made out of and the nature of the connections they can form.

## A. Digital Materials

### Definition of digital

Digital systems are digital because they are discrete and because they demonstrate some sort of threshold behavior: if an exterior noise source is of amplitude below this threshold digital systems can be made arbitrarily precise. To show an example of threshold theorem I will introduce the concept of reliable computation in the presence of noise using majority voting as presented by professor J. Jacobson [19].

If we assume we have a infinite number of independent computers that compute the binary result of a program result with an error probability  $p$ . Then to compute the result of a program we can ask an odd number to compute to compute it. Each computer will answer the right answer with probability  $1-p$  and the wrong answer with probability  $p$ .

Because the computers are binary (any discrete set of values will also do of course) we can take a majority voting of their results. If we take a majority voting between 3 computers we will have the wrong result with probability:

- case all computers are wrong:  $p^3$
- case 2 computers are wrong  $3(1-p)p^2$

Therefore probability  $P$  of being wrong is  $P = p^3 + 3(1-p)p^2$  which is about  $3p^2$

If we want  $3p^2 < p$  we need  $p < 1/3$ .

Now lets assume we want arbitrarily low error rate with the same computers and we create the following scheme:

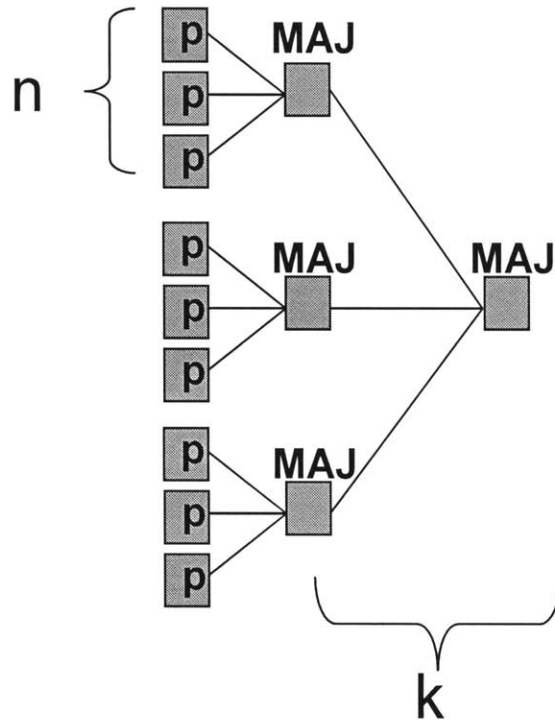

Figure 1: Generalized majority voting scheme ([19])

In the general case, if we have  $k$  levels of voting among  $n$  pairs at each level we have the following equation giving the probability  $P$  for the circuit in illustration 1 to make an error:

$$P = \sum_{m=(n+1)/2}^n \binom{n}{m} p^m (1-p)^{(n-m)} \quad (1)$$

Which gives the following simplification:

$$P_k \approx 3^{-(2^k-1)} p^{2^k} \quad (2)$$

And if we want for the voting circuit to be effective we obtain the following necessary condition which translates into  $p < 1/3$ :

$$P_k = 3^{-(2^k-1)} p^{2^k} < p \quad (3)$$

Therefore:

- if  $p < 1/3$  by building a majority voting circuit as in illustration 1 we can reduce the error exponentially
- if  $p > 1/3$  such a reduction will not work

This is an example of threshold theorem in the case of majority voting for circuits which worked because the circuits were binary. One can therefore ask: what would happen if instead of having a discrete code space we had a discrete physical space? Of course atoms are such an example. But what if we had a discrete physical space at macroscopic level?

## **Definition of digital material**

A digital material is a material made out of components with the following properties:

- the set of all the components used in a digital material is finite (i.e. discrete parts).
- the set of the all joints the components of a digital material can form is finite (i.e. discrete joints).
- the assembly process has complete control over the placement of each component ( i.e. explicit placement).

These properties should remind the reader of the discrete properties of digital electronics where the electrical signals can only take a finite number of values. Because the cement in a cement/brick wall isn't discrete, a cement/brick wall isn't a digital material. In the same way an object built in a 3D printer using fused deposition modeling (FDM) isn't digital. While all drops are discrete, any two of them can be assembled in an infinite number of different positions and form a continuous set of joints. In the case of a brick wall the bricks are discrete parts but their placement is not discrete.

Examples of new research in fabrication techniques are algorithmic assembly [3], programmed assembly [4] and self-assembly[1]. The demand for Avogadro-scale engineering, i.e. processes that will assemble about  $10^{23}$  parts, is driving the research on these fabrication techniques. Digital materials are related to these researches on fabrication as many fabrication techniques, including the above mentioned ones, can use digital materials.

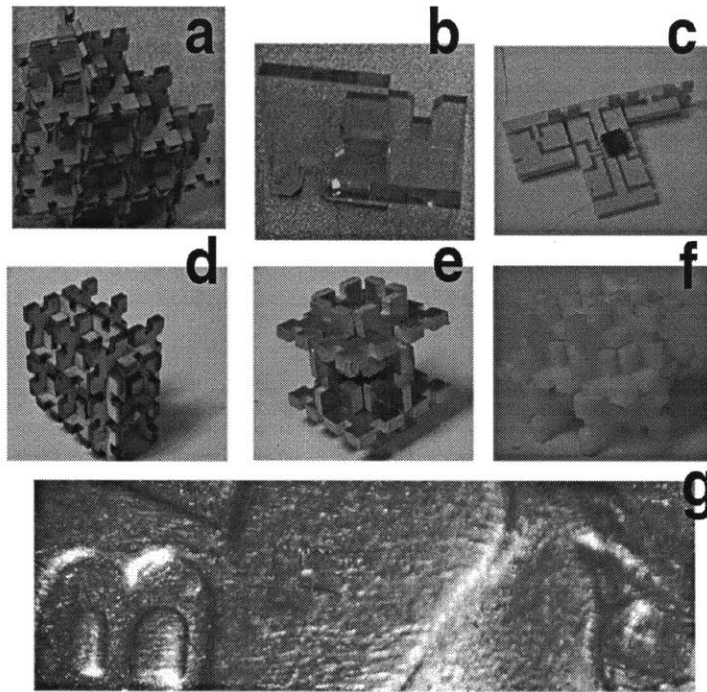

*Figure 2: Pictures of GIK bricks made out of different materials, from a to g: cardboard, plexiglass, aluminum and fiberglass, plywood, aluminum, delrin and kapton.*

## Multimaterial

Digital materials can be seen as a higher level of abstraction as they are composed of elementary discrete parts which themselves are made of some material ( i.e. metal, wood, plastic polymer ...). Digital materials are fully described by the nature of the part they are made out of and the nature of the connections they can form.

One can see in Figure 2 examples of digital materials composed of elementary bricks made out of cardboard, acrylic, fiber glass polymer, aluminum, Delrin, plywood and Clapton. Bricks of different materials can also be alternated as seen in Figure 2.



## Type of connections

The purpose of this work isn't connection taxonomy. I will describe one type of connection that can be used to form reversible digital material: press-fit connections.

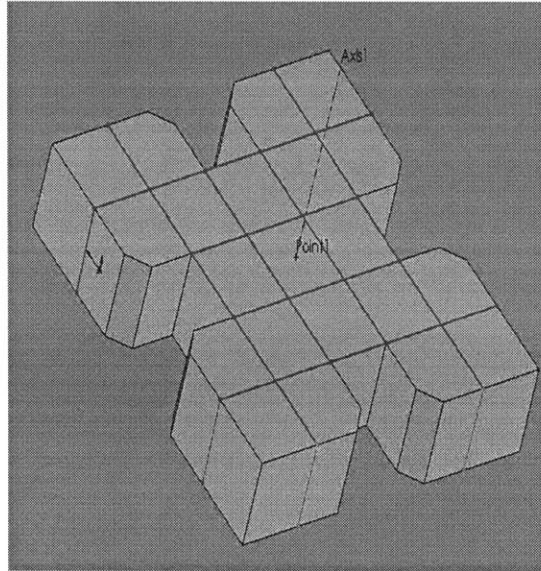

Figure 3: The schematic drawing of 1 square GIK brick.

## GIK introduction

GIK, initially Grace Gershenfeld's Invention Kit, subsequently the Great Invention Kit, is an example of digital material built by press-fitting together elementary components. GIK bricks (see Fig.1) can be cut in 2-dimensions which makes them very easy to make at any scale (Fig. 17). They can be press fit together to form space filling voxels that can be connected and disconnected at make the construction reversible.

## Description of the press-fit bond

A set of GIK parts with slot sizes between 92 mils and 104 mils was cut and the force necessary to separate-by-pulling 2 GIK parts was measured. As seen in Figure 14 the amount of force to break a GIK link varies linearly with the size of the slot. This linear spring-type behavior signifies that GIK's press fit connection strength follows within some domain the equation  $f = kx$ . If  $x$  is the GIK slot width, then the contact surface  $S$

between two GIK bricks is  $S = x^2$ . If  $k = YS$  where Y is the material's Young modulus then the force needed to pull apart two GIK bricks within the spring domain is  $f = Yx^3$ . In addition, as seen in Figure 5 and very much like DNA molecules, due to a stick-slip behavior, the amount of force needed to disconnect a given number of GIK parts simultaneously grows faster-than-linear.

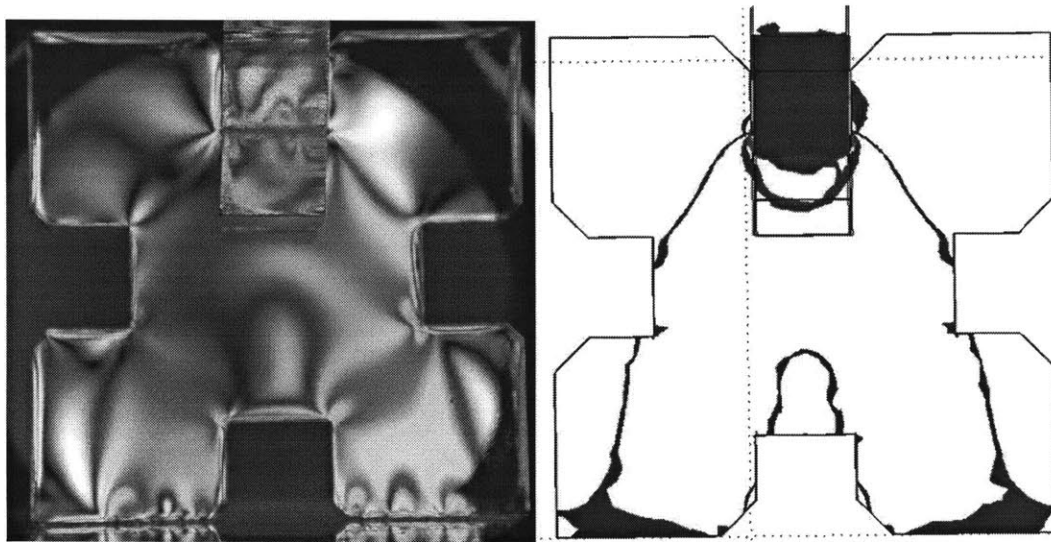

*Figure 4: The measured (left) and calculated (right) stress pattern in a GIK brick loaded on the top.*

Two transparent acrylic GIK parts 1cm thick were made and compressed using the Instron material testing machine with a force of 500N. The acrylic parts were illuminated with white light through a polarizing lens. The resulting interior stress pattern was photographed using a Nikon 995 digital camera through an orthogonal polarizing lens. The resulting photograph was compared to the simulated stress pattern obtained using FEMLAB version 3.1 finite element simulation software. The results can be seen in Figure 4 a) and b). I can therefore estimate the maximum amount of force a GIK piece can withstand in compression before rupture as a function of the material it is composed of. I can also predict the rupture points which were verified experimentally.

## Analogy atom/bond/crystal with digital materials

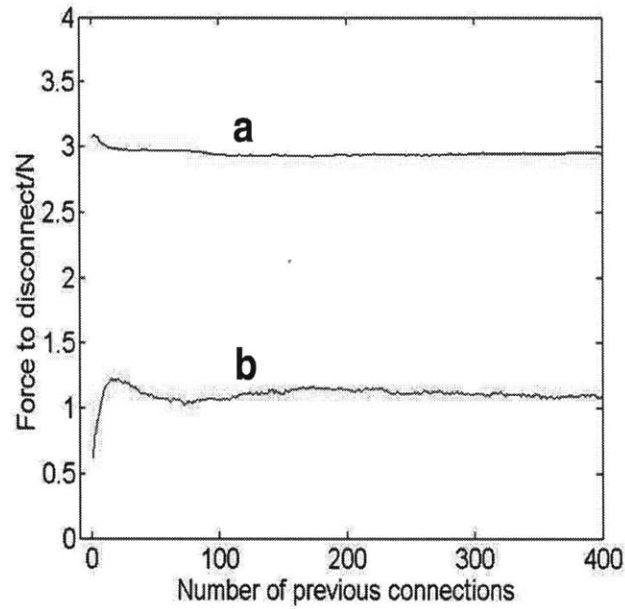

Figure 5: The variation of the force necessary to disconnect 2 GIK bricks as you connect and disconnect the 2 same bricks

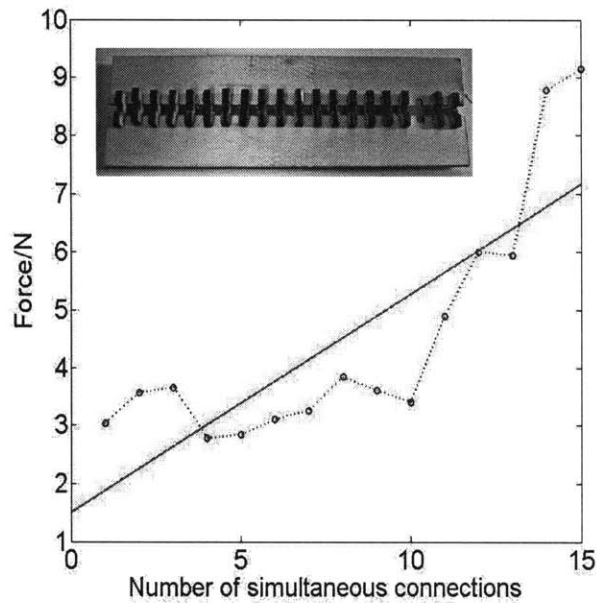

Figure 6: The force necessary to simultaneously separate a number of GIK bricks as a function of the number of GIK bricks that need to be separated.

As shown in Figure 5 the force needed to disconnect and connect two GIK bricks only slightly vary with the number of previous connections which implies that a GIK connection is truly reversible. Assuming a GIK is an atom, a connection would be an atomic-bond. A GIK structure can then be identified as a crystal. The properties of a GIK structure can therefore be tuned by:

- void, i.e. leaving holes in the structure by not putting in bricks during the construction
- varying materials, i.e. alternating the materials the GIK structure is made out of
- geometry, i.e. varying the type of crystalline geometry in the structure by using GIK bricks based on triangles, hexagons ....

### **GIK structure reliability tool**

Unlike native existing materials, one can build the digital material of his choice by manipulating one by one the conceptual-atoms the digital material is made out of. I developed the following rules for GIK structures:

Each brick in the GIK material is represented by 3 discrete coordinates  $x,y,z$  taking values in the set of integers. I arbitrarily set one GIK brick to have the coordinates  $1,0,0$ .

The following rules suffice to describe a complete GIK structure:

- each brick is connected to exactly 4 neighbors
- a brick referenced by  $x,y,z$  coordinates can make only local connections to the bricks  $(x-1,y,z),(x+1,y,z),(x,y+1,z),(x,y-1,z),(x,y,z+1)$  or  $(x,y,z-1)$ . To simplify notations I will say that a GIK piece connected to the  $x+1,y,z$  and  $x-1,y,z$  bricks makes  $x$  connections. Respectively the same for  $y$  connections and  $z$  connections. Therefore a brick makes either  $x,y$  connections,  $x,z$  connections or  $y,z$  connections.
- I can use the following rules to determine which connections brick  $(x,y,z)$  makes:
  - if  $x$  is odd it will make either  $x,z$  or  $y,z$  connections
  - if  $x$  is even it will make either  $x,y$  or  $y,z$  connections

- if y is odd it will make either x,y or y,z connections
- if y is even it will make either x,y or x,z connections
- if z is odd it will make either x,y or x,z connections
- if z is even it will make either x,z or y,z connections

The coordinates of each brick are either consistent following these rules or introduce a contradiction. For example brick (0,0,0) can't make connections and therefore doesn't exist. Brick (1,0,0) makes an x,z connection. To obtain a real GIK structure it is sufficient to remove from the complete (x,y,z) integer space the bricks who's coordinates violate the rules.

A Matlab program (See Appendix 1) was developed using these rules to design GIK structures in order to test some of their properties before building them.

As you can see in the Appendix 1:

- if we remove  $\frac{1}{2}$  the parts the structure collapses.
- if we remove  $\frac{1}{3}$  of the parts
- if we remove  $\frac{1}{4}$  of the parts
- if we remove  $\frac{1}{2}$  of the parts in 1 direction,  $\frac{1}{3}$  in a second direction and  $\frac{1}{4}$  in the 3<sup>rd</sup> direction then we obtain the structure showed in illustration 9

## **Error tolerance**

GIK structures are built using a pick and place mechanism. If the assembling mechanism is ideal and has an infinite accuracy it can drop the GIK parts in the designated positions. However actual mechanisms have a limited precision. As it can be seen in Figure 7 a chamfer of angle  $\alpha$  and width  $w$  will roughly allow for a misalignment of  $\pm w$  and  $\pm \alpha$  degrees tilt.

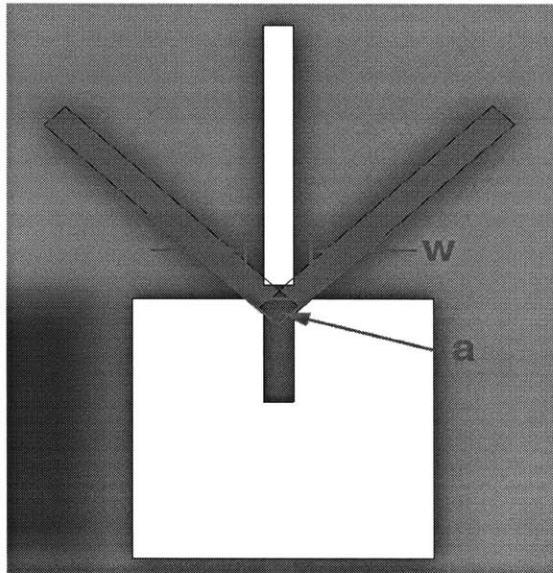

*Figure 7: Drawing explaining how error tolerance can allow 2 GIK bricks to connect even if they aren't perfectly aligned.*

### **Error reduction**

When a structure is built out of GIK each part you add to the structure is adding geometrical constraints to it and therefore is limiting the free movement of each piece. I measured the amount of free movement as a function of the number of rows in a GIK structure as seen in Fig. 8. I used laser cut Delrin GIK parts. By adding more constraints along the x direction (1, 2 and 4 rows) one is forcing the x position of all the parts to be closer to 0. If I note  $X_n$ , the position along the x axis of the nth piece in the structure made out of k rows, then one can see that X goes down with k, and that  $X_{(n+1)} - X_n$  stays relatively constant. I can generalize this to y and z axes by symmetry. This property of digital materials can be referred to as error reduction.

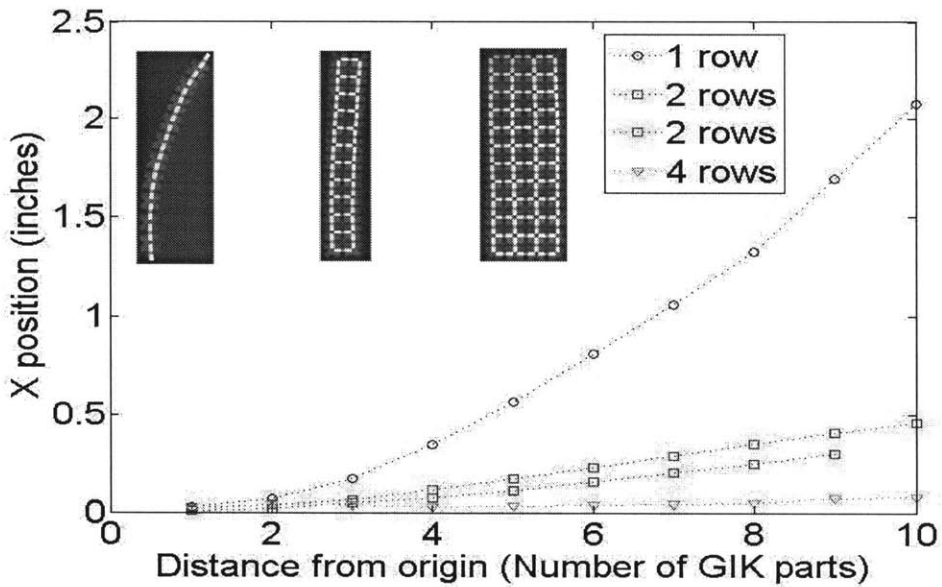

Figure 8: Experimental measurement of the error reduction as the size of the GIK structure increases from 1 row to 2 rows to 4 rows. 2 different measurement for the 2 row case was plotted to demonstrate the measurement precision.

### Error detection

As seen in Figure 1, an ideal square GIK tile can be decomposed in 21 identical cubes of size  $s$ . An ideal square GIK brick is of size  $5s$ . I am using a manufacturing process to make GIK parts of size  $5s$ , supposedly all the same. Processing limitations inherent to a manufacturing technique will produce random errors in the size of the GIK brick. Let the size of a manufactured brick be defined by a random variable  $S$ . I call such a manufacturing process *unbiased* if and only if the random variable  $S$  describing the size of each object has a Gaussian distribution of expectation (i.e. average)  $E(S)=5s$  and the size  $S$  of two different parts are uncorrelated. Let's call  $s^2$  the variance of  $S$ .

This variance,  $s^2$ , can also be seen as the manufacturing process precision. If one builds a mono-dimensional GIK structure with  $n$  GIK square bricks, then the size of the resulting structure will be a random variable  $R$ .  $R$  is the sum of the size of each brick and is therefore has an expected value,  $E(R) = 5ns$  and of variance:  $Var(R)=ns^2$

$\sqrt{ns}$  is then the standard deviation of R.

Let's assume is  $\sqrt{ns}$  smaller than 5s. If  $S_{Final}$ , the measured size of the resulting structure, verifies:

$$|S_{Final} - 5ns| > 2\sqrt{ns} \quad (4)$$

then there is 95% probability that there was at least one error in the structure. One can measure  $S_{Final}$  as the structure is being built and proceed to error correction as soon as an error rises.

## **Mechanical tuneability**

### ***Isotropy by void***

In order to understand how holes can be introduced in a GIK structure while still leaving a sturdy structure a mathematical model to describe GIK structures was built and structures were simulated. The simulation showed that removing 1 brick out of 2 in the x direction, 1 out of 3 in the y direction and 1 out of 4 in the z direction will leave a stable structure. A structure of 8 by 8 by 8 GIK parts was built and a force-compression diagram was acquired for each x,y and z direction using the Instron material testing machine. As it can be seen in Figure 9 the compression modulus is different in each direction. The material's compression Young modulus is the highest in the z direction  $E_z = 3.9 MPa$ , lower in the y direction  $E_y = 2.2 MPa$  and lowest in the x direction,  $E_x = 0.82 MPa$ . (Further study would be necessary to correlate the number of voids in the structure to the value of the Young modulus.) This obviously enables to engineer digital materials to be anisotropic or isotropic as desired.

### ***Compression by void and alternate materials***

A set of digital materials were fabricated in order to demonstrate compression modulus tuneability by void and by alternation of materials. Digital materials were built for which I removed 0% of the parts, 25%, 50%, and 75%. As seen in the compression-force diagram in Figure 11 the compression Young modulus increases when more parts are present. Also as seen in Figure 14 there is a linear relationship between the number of parts present in the structure and the compression modulus of the digital material.



A second set of seven digital material structures was fabricated where the ratio of plywood parts to aluminum parts in the structure was varied from 100% to 0% in 16.6% steps. As seen in the compression-force diagram in Figure 10 the resulting compression modulus increases with the number of aluminum parts in the structure. Figure 12, obtained by plotting the intersection of vertical lines with the experimental curves in Figure 10, shows the amount of force needed to compress a composite structure for a given length (bottom-up, from 0.1 mm to 0.5mm) as a function of aluminum-plywood composition. A percolation threshold, also visible in Figure 12, seems to exist between 66% and 83% curves. This threshold is due to the fact that once a given percentage of parts are aluminum an aluminum path between the top surface of the material and the bottom surface appears which makes the structure much harder.

### ***Tension tuneability***

The described previously and as seen in Figure 13 the amount of force to break a GIK link varies linearly with the size of the slot. Also as described previously the amount of force needed to disconnect a given number of GIK parts simultaneously grows faster-than-linear. One can therefore use the slot width and the number of links broken simultaneously to tune the amount of force needed to break apart a GIK structure in tension.

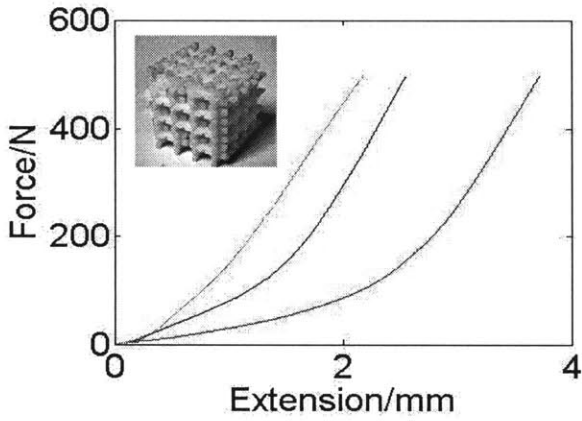

Figure 9: Isotropy tuneability: different Young moduli in different directions.

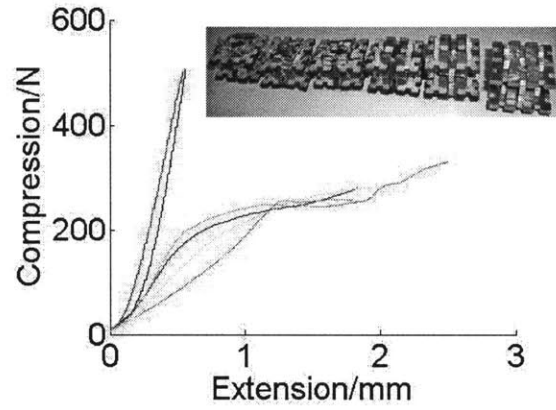

Figure 10: Mixed material tuneability: by varying the ratios of plywood and aluminum the Young modulus is varied.

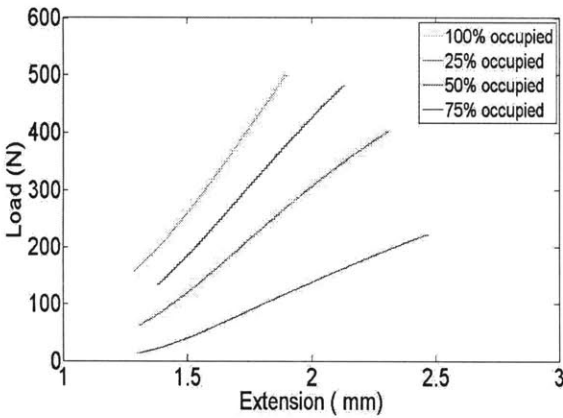

Figure 11: Tuneability by void: by varying the ration of occupied sites to empty sites in a GIK structure the Young modulus is varied.

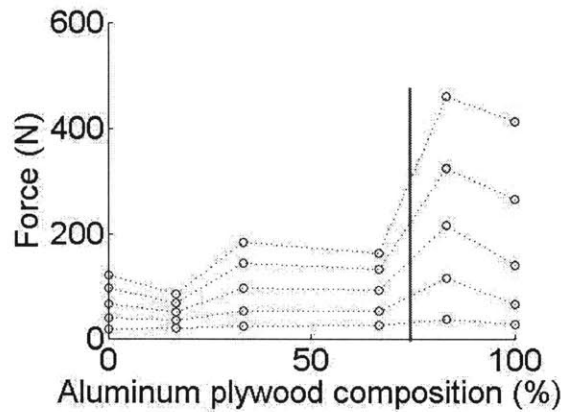

Figure 12: Mixed material tuneability: demonstration of the non linearity of mixed material tuneability.

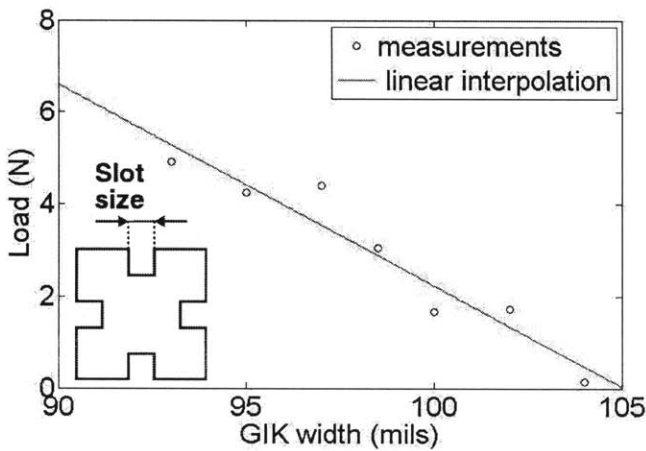

Figure 13: Tension tuneability: variation of the slot size in a GIK brick that can linearly vary the force necessary to disengage 2 GIK bricks,

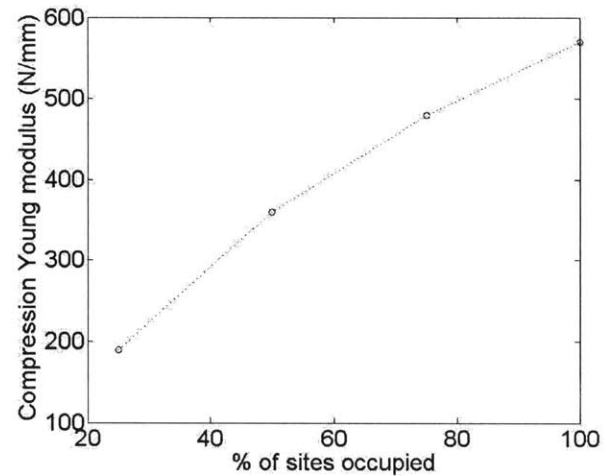

Figure 14: Data extracted from illustration 11: Demonstration of the relationship between the Young modulus and the percentage of sites occupied.

## Electrical tuneability

Figure 15 shows a Schottky diode built by press fitting together three parts: Copper, N-doped Silicon and Lead. The Copper/N-Silicon press fit junction creates a Schottky diode ( barrier height 0.35 eV). The Lead/Silicon junction creates an ohmic contact (barrier height -0.05 eV) that allows for easy measurement of the diode's characteristics.

As seen in Figure 16 the instantaneous forward current when polarized with an instantaneous voltage of 4V is 0.4 mA for the press-fit diode and 0.6 mA for the commercial LED. A typical value for a commercial Schottky diode is 4 A at 0.5V. This difference is due to the low Cu-Si barrier height ( 0.35eV) and to the press-fit diode's internal resistance of 100 kOhms on average which is due to the rough-surface electrical contacts and the presence of native oxides in the contacts. Schottky diodes and resistors are sufficient to build a complete logic family. It was therefore demonstrated that one can build electrical active structures using only additive digital materials.

In addition, by using alternate materials (different optical refractive index, different sound refractive index, ...) it is straightforward to build sound and optical active materials, i.e. photonic crystals and sonic crystals.

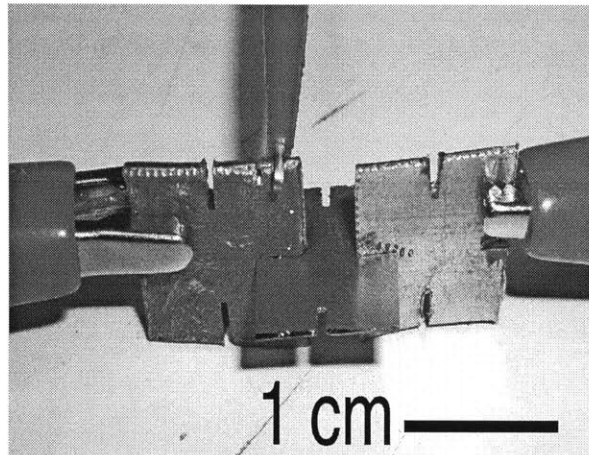

*Figure 15: GIK diode: 3 GIK parts assembled to form a diode. Left: lead for a ohmic contact to the diode. Middle: N-dopped Si. Right: copper.*

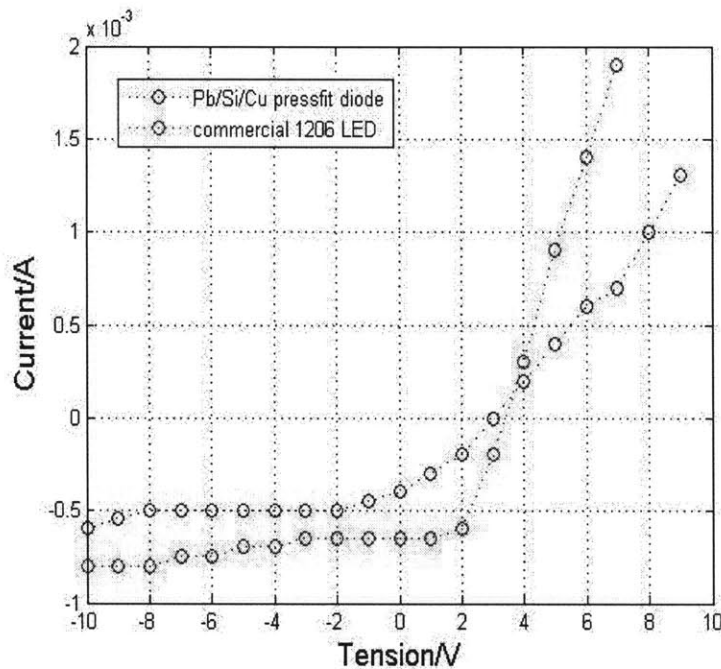

Figure 16: Current voltage characteristic for the GIK diode compared to a commercial Light Emitting Diode.

### Orthogonal properties and tuneability

Some material properties are nearly orthogonal. However attention must be paid to which tuneability method is used to independently vary two orthogonal properties. For example tuning mechanical and electrical properties by using a void method for both will not decouple the properties (ref: holes in metal sheet). One needs to use two orthogonal methods to independently tune orthogonal properties.

### GIK size scaling

The behavior of press fit digital materials are explained by the material's elasticity and Coulomb's friction laws. Press fit digital materials can therefore be built at any length scale where these laws are valid, roughly from micrometer to meter scale as seen in Figure 17.

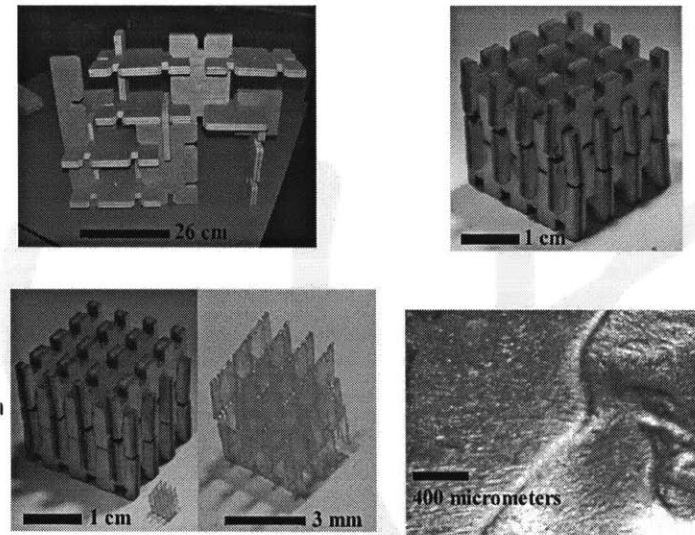

*Figure 17: GIK structures at 4 different scales. In usual reading order: 1 m shelf, 1 cm structure, a 3 mm structure and a 400 micron structure.*

### **Complexity of GIK structures**

I can use the metric  $C = \frac{V \log(M)}{e}$  [19] to measure the amount of complexity that can be built using a given fabrication process. In this metric V is the total volume of the resulting object, M is the total number of different objects that can be built within the given volume and e is the error rate of the fabrication process. C is the resulting complexity.

Using this metric I compare the complexity present of different structures. The table 18 was presented in class MAS960 by Prof. Joseph Jacobson and was augmented by the calculations for GIK structure. As seen in this table, additive assembly of digital materials is theoretically able to build more complex structures for a lower cost than most existing fabrication techniques.

	Genome (Natural)	Gene Synthesizer	Semi- conductor Chip	TFT	DVD-5	Existing GIK technology	Realistic GIK assembler
Design Rule Smallest Dimension (microns)	0.0003	0.0003	0.1	2	0.5	17780	1
Number of Types of Elements	4	4	8	8	2	10	10
Error Rate	1.E-08	1.E-02	1.E-09	2.E-07	1.E-09	1.00E-02	1.00E-02
Volume of resulting artifact (Cubic Microns)	6.E+01	NA	7.E+09	1.E+11	7.E+12	4.91E+03	2.00E+16
Fabrication Time(seconds)	4.E+03	3.E+04	9.E+04	7.E+02	3	4.E+03	4.E+03
Fabrication Cost (\$)	1.E-07	3.E+01	1.E+00	1.E+01	3.E-02	26.27090278	100
Complexity	1.E+08	1.E+02	2.E+09	1.E+07	7.E+08	4.91E+05	2.00E+18
Complexity Per Unit Volume of artifact (um <sup>3</sup> )	2.E+06	NA	3.E-01	1.E-04	1.E-04	1.00E+02	1.00E+02
Complexity Per Unit Time	4.E+04	5.E-03	2.E+04	1.E+04	2.E+08	1.E+02	6.E+14
Complexity Per Unit Cost	1.E+15	5.E+00	2.E+09	9.E+05	2.E+10	1.87E+04	2.00E+16

*Figure 18: Table of Fabrication Complexity, first presented by Professor Joseph Jacobson and augmented for comparison with digital fabrication data.*

## **Methods**

Plywood and Delrin GIK parts used in the measurements were cut on a commercially available Universal laser cutter. Aluminum GIK parts were cut on a commercially available Waterjet cutter. The materials used for constructions were white birch plywood of thickness 95 mils +/- 5 mils, Delrin of thickness 64 mils +/- 1 mil and aluminum 2024 of thickness 101 mils +/- 2 mils. The material testing machine was a commercial Instron 4411 (time resolution: 5ms, force resolution: 0.01 N and position resolution: 0.01 mm). GIK structures were assembled by hand with the help of a rubber mallet when necessary. Compression and extension force-displacement diagrams were recorded. GIK material behaves differently in compression and in extension and I will therefore always differentiate the compression Young modulus from the extension Young modulus. The tension in the current-tension characteristic diagram of the press-fit Schottky diode was measured using a digital oscilloscope Tektronix TDS 3052 (Input impedance 1 MOhm, 13 pF). The current in the current-voltage characteristic diagram was measured by adding a 2 kOhm resistor in series with the diode and by measuring the voltage across the resistor using the same oscilloscope.

The N-doped silicon GIK used for the Schottky diode presented in this paper was cut from a N/ Phosphorus doped wafer of Resistivity 1-20 ohm-cm and thickness 525 micrometers +/- 25 micrometers using a Buehler diamond wafering blade on a commercial ISOMET 1000 wafer cutting machine. The copper GIK used for the Schottky diode was also cut on the same machine in the same conditions from 0.047" thick stock copper. The lead GIK used for the Schottky diode was also cut on the same machine using 0.085" thick lead sheet purchased from McMaster-Carr.

## **Tera-structures**

The structures described in this section were assembled by hand with tweezers and when needed the parts were hammered in place ( for example the aluminum structures or the 30cm big GIK parts in Figure 17). In order to build a digital structure thousands to tens of thousands of parts need to be assembled in reasonable times and with reasonable precision which only a machine can do. However there are some basic constraints: to be able to build a 10 cubic centimeter structure with 10 micrometer large parts I need to assemble about 10 to power 12 parts or 1 Terra-part, Terra begin 1000 Giga of course.

In order to assemble 1 Tera-parts in, lets say, 1 hour, you need to assemble 2 Giga-parts per second. This is not possible with serial fabrication. I therefore worked on describing an assembler theoretical model and I built a prototype as it is described in the following section.

## **B. Digital Printer**

### ***1.Theory***

#### **Introduction**

I am presenting a printer that builds functional three-dimensional structures by reversible assembly of a discrete set of components, "digital materials". This approach uses the components rather than a control system to impose the spatial and functional constraints. Printing can be performed as a parallel rather than a linear process. The printing process

is reversible for re-use of the pieces or for error correction at any point in the object's life. Error detection, error-reduction and error-tolerance during assembly allows for reliable, high throughput printing.

## **Introduction**

The paper "Digital material for digital printing" [20] presents a digital material that can be used to 3-D print functional free-form structures. In the present paper I am describing the technical architecture of a possible printer that can do the assembly. While this assembler will be designed to use vertical GIK, a version of digital material similar to GIK [20], one should be able to modify it to assemble any digital material. Vertical GIK, as presented in Figure 19, has the same properties as GIK, is forming the same press fit links as GIK, but can only be assembled vertically. Therefore a vertical GIK structure is formed (as shown in Figure 1) by rotating each layer in respect to the last one by 90 degrees in order to brace two lines together.

## **A simple machine is a cheap machine**

Because the present machine will assemble a digital material which is error-tolerant and error-reducing, its metrology will be very simple. As shown in Figures 19 and 20, in order to assemble a GIK structure the assembler only has to press the parts together vertically. It is therefore a 2.5 axes assembler. It's x and y precision has to be at worse the chamfer dimension  $\epsilon$  (as presented in [20]). The chamfer size  $\epsilon$  being typically about 1/20 of the size of a vertical GIK brick the printer needs a x-y precision of about 1 micrometer in order to assemble 20 micrometer big vertical GIK. This can also be described as: half the intelligence is in the bricks and half the intelligence in the machine. And who says simple machine also says cheap machine.



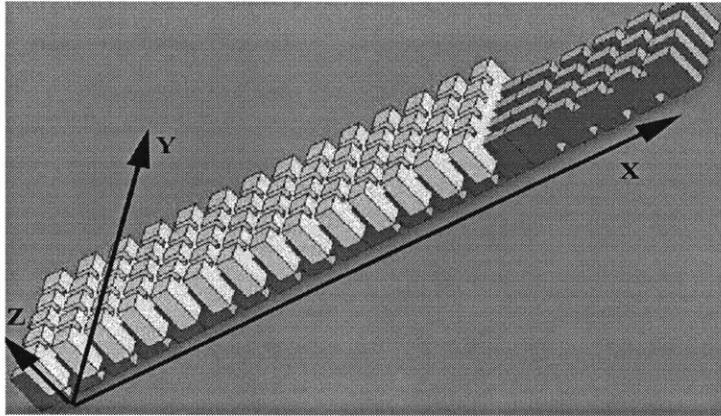

Figure 19: Vertical GIK bricks forming an incomplete 2 layer vertical GIK structure. One can notice the 90 degree rotation between layers for bracing.

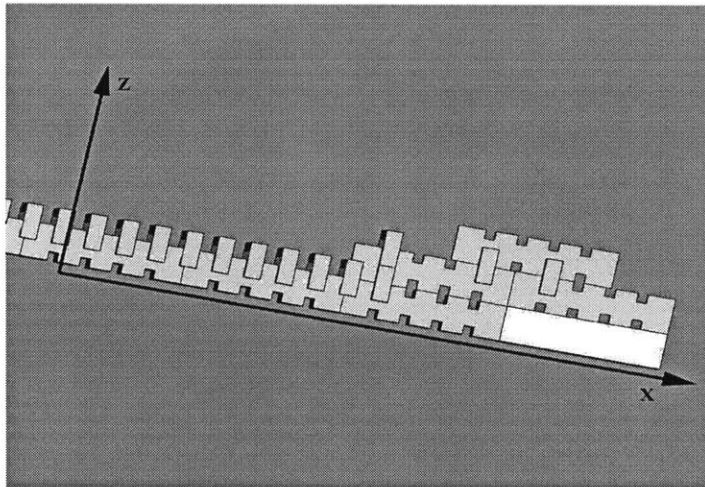

Figure 20: Vertical GIK (gray) and Blank (white) parts forming an overhang structure. One can notice that Blank and vertical GIK are the same size and that Blank and vertical GIK don't form any links.

## Vertical GIK

As shown in Figure 20, the assembler will use Blank parts to create overhangs or as place holders. The Blank parts are unable to create links with GIK parts but are the same dimension as a GIK part. Once the structure will be built one can discard the Blanks parts by shaking the resulting structure.

If a GIK part is 20 micrometer big, in order to build a 10 cubic cm structure one would need about 100 billion parts. In order to build such a structure in a reasonable amount of time (1 day) the assembler has to add about 1 million parts a second. This can only be done if the assembler is adding the 1 million parts simultaneously (in parallel).

### Assembling Strategy

A GIK structure is composed of layers of GIK. Each GIK layer is composed of GIK lines. The main idea guiding the assembler's architecture is that the assembler is always adding lines of constant length, one entire line at a time. However each line is composed of GIK only in the positions where it is supposed to add a GIK to the structure and of Blank parts otherwise. This way the structure to be built is encoded in the temporal sequence of parts that the assembler is adding.

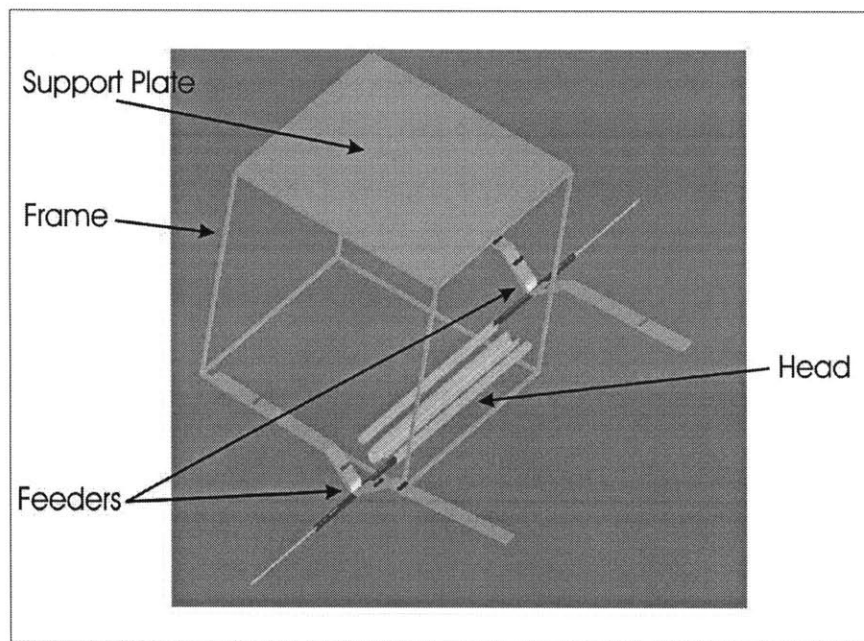
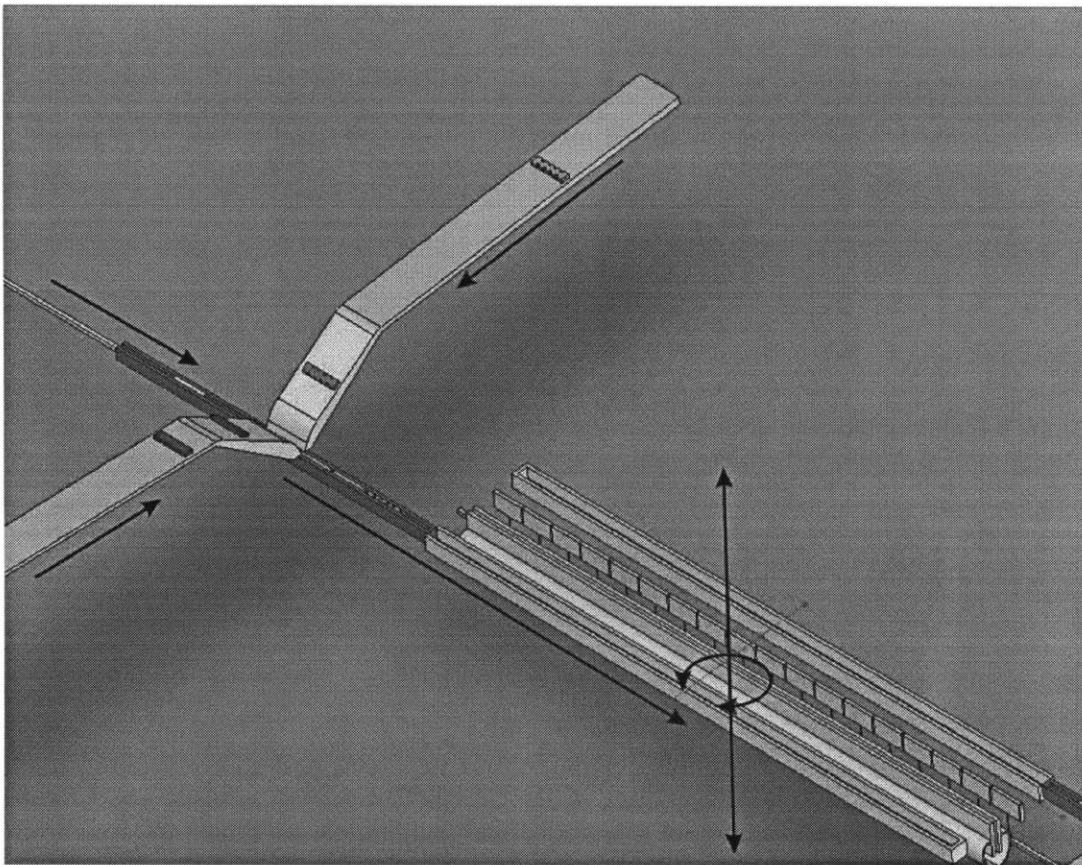

*Figure 21: Schematic overview of a digital assembler. The digital assembler consists of a support plate which provides support for the first layer of vertical GIK and holds the object to be assembled, one or more assembly heads (yellow), and 2 feeders for each head, all of which are held together on a frame.*

## Design principles

The Digital Assembler (Figure 21), a synchronized state machine, is composed of different subunits. The different subunits are: assembler head, parts feeder, the machine frame and the controller. In this proposed version of the assembler, the head consist of four “blades” that move in a linear direction as a unit, assembling GIK line by line (see Figure 22).

The feeder provides the GIK parts to the head in an ordered manner, one line at a time. The machine frame is the rigid cage all the machine functions are assembled upon. The control unit is controlling the actuators and synchronizing the different parts of the machine.



*Figure 22: The feeder is pushing in the building blade of the head the line to be added. A second feeder (not represented) is feeding the second building blade.*

## The head

As mentioned earlier, the head consists of 4 blades and each blade has a different function: they do printing, error detection and error correction (Figure 23).

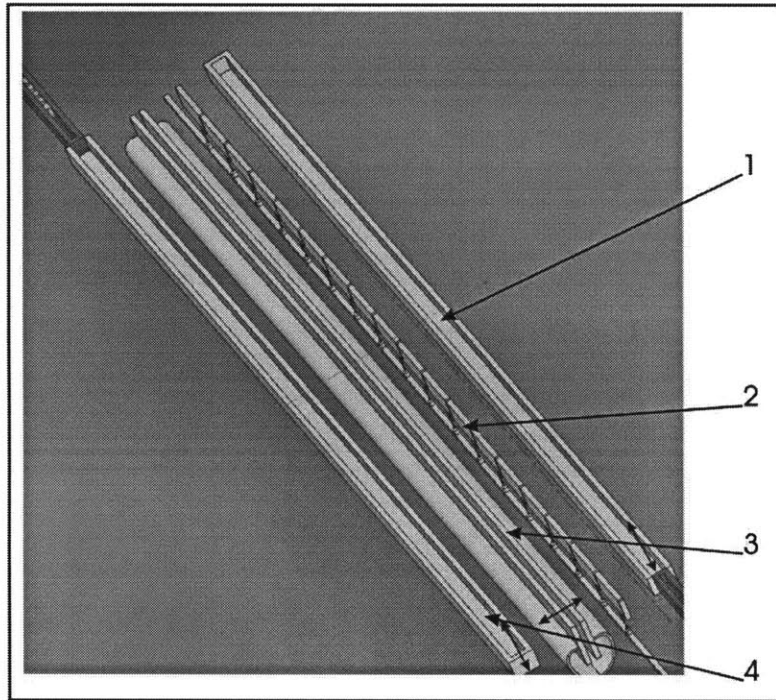

*Figure 23: The assembler head is composed of 4 blades. 1: building blade, 2: error detection blade, 3: line removing blade 4: line rebuilding blade. In construction mode the blades 3 and 4 only work if an error was detected. In disassembly mode, only blade 3 functions.*

The first blade in the assembler's head adds GIK. The second blade recognizes errors. The third blade removes those errors, and the fourth blade fills in GIK where the third blade had removed GIK due to errors. This method reduces the number of errors by one order of magnitude relative to not having error detection at all. Eventually, several of these head units could work in parallel.

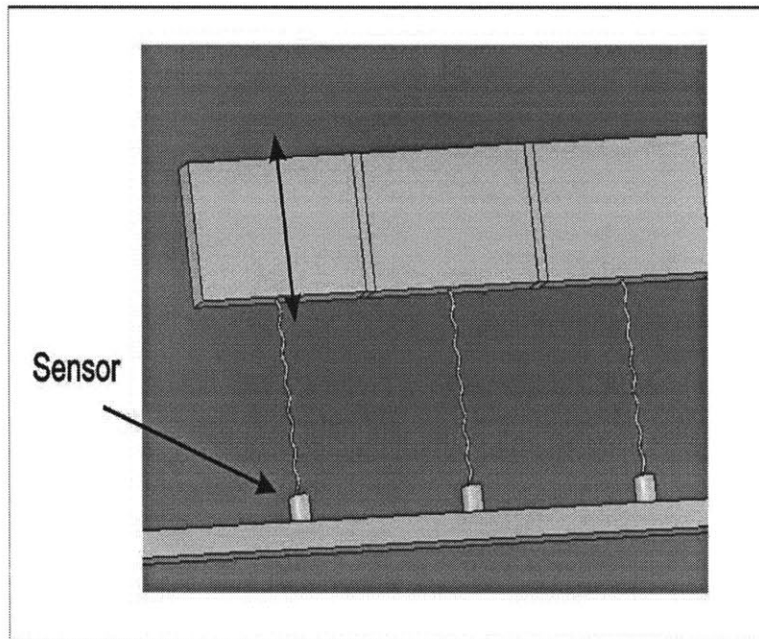

*Figure 24: The error detection blade is composed of a touch pad which is able to move up and down and a sensor which is sensing how much pressure is applied against each touch pad. An error is detected if there is a too high pressure difference between 2 adjacent pads.*

The second blade is represented in Figure 5. The blade is formed of the same number of position sensors as there are GIK pieces in a line. Each position sensor has a “touch pad” and sensor which is feeling how much pressure is applied against the “touch pad”. If this blade is pushed against a GIK line with errors, it will feel a difference in pressure between 2 adjacent sensors, and will therefore detect an error. The blades 1, 3 and 4 can be seen in Figure 23. The blades 1 and 4 are building by pressing down a new line. The 3rd blade in Fig. 23 is removing GIK parts if an error occurred. The 3rd blade is removing one row at a time by clamping it and pulling it out.

The order in which the feeder supplies the GIK to the assembler determines which structure the digital printer is building. An important issue is to find at least one sequence of parts which, when assembled, will build the structure the user wants.

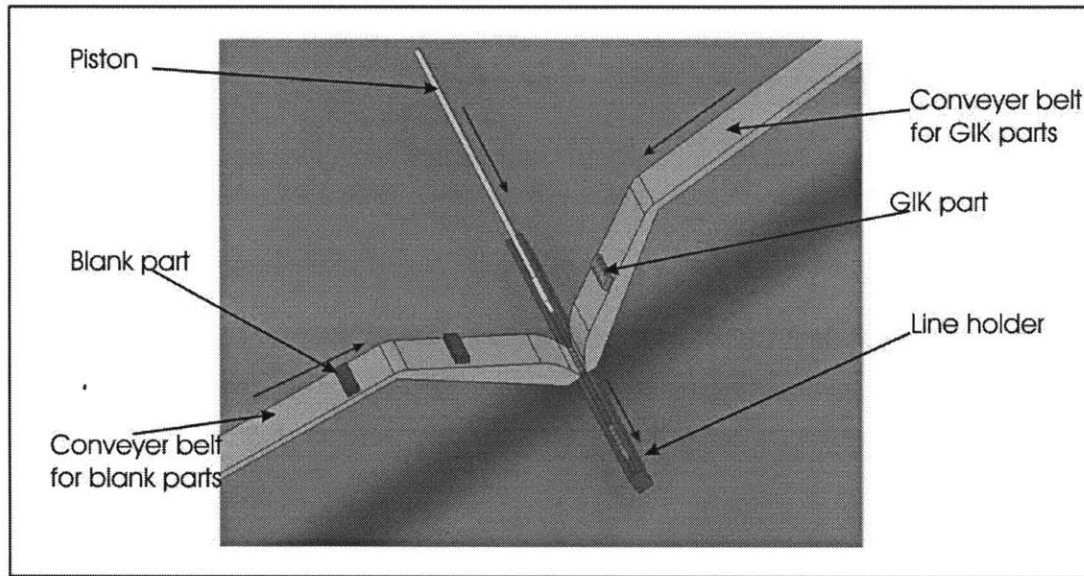

*Figure 25: Scheme of a feeder formed by 2 conveyer belts, one for vertical GIK one for Blanks. If more than 2 parts are needed more conveyer belts can be added. The parts are deposited in a line holder (dark gray) and a piston pushed the parts in the head when the line is built.*

### **GIK Feeder**

There are different ways to implement a GIK parts feeder. In order for the machine to work at high speed, any feeder has to be able to feed one entire line to the head in the same amount of time the head takes to add one line. Figure 6 shows one possible implementation of the feeder. In this implementation, the feeder has a continuous supply of GIK and Blank parts arriving on 2 separate conveyer belts (Blank in red, GIK in green). The feeder moves the line holder (dark gray) while it is either actuating the GIK line or the Blank line. This way a legal line made out of GIK and Blank parts is formed. Once the line is ready the piston (white) is pushing the entire line into the assembler's head while making sure all the parts are in contact. If the parts are packed together appropriately they will face the slot to which they will connect.

So far, I built by hand stable GIK structure at different scales as shown in [17]. For practical reasons, the first assembler to be built will assemble GIK at the centimeter scale. However I want to force myself to use only technology that can be easily adapted to future machines that will assemble micrometer big GIK parts.

Given that GIK connections are reversible, GIK structures can be changed and partially or totally recycled. In this case the assembler can use only the disassembly blade and disassemble line by line the GIK structure. The discarded parts can therefore be recycled.

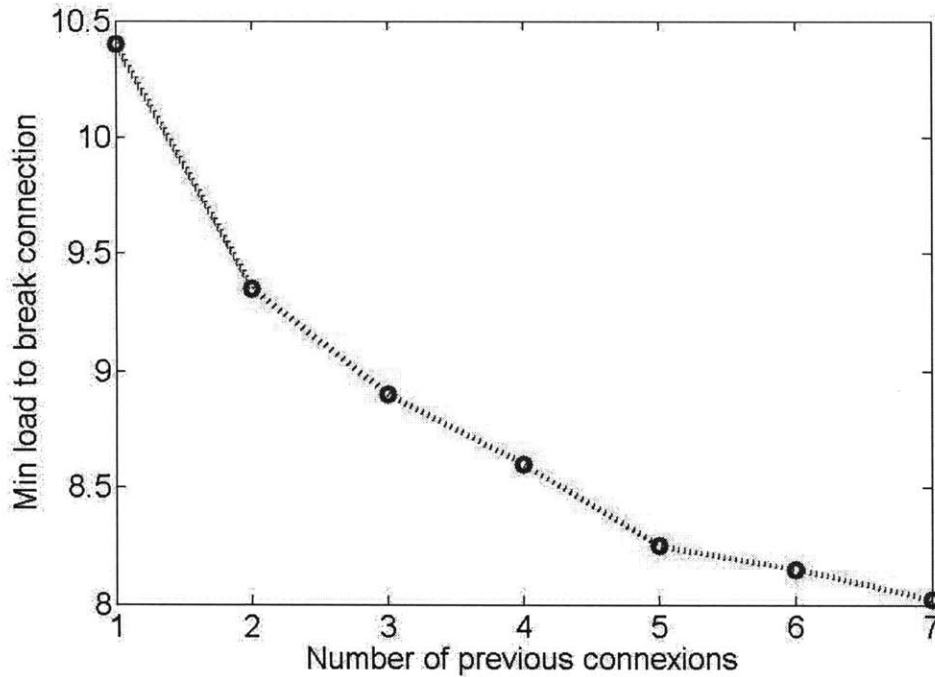

*Figure 26: Minimum load to break a connection as a function of the number of previous connections the 2 parts previously made. The more you connect two parts together and the easier it is to disconnect them. However the lower limit seems to be within 30% of the initial value which is acceptable.*

### **Reconnection reliability**

Parts are connected and disconnected, one can assume that the links get weaker and weaker. The link strength versus number of connections was measured experimentally. GIK parts were cut out of 0.1 inch +/- 5 mils white birch plywood on a commercial laser cutter. The parts were connected by hand and installed in an Instron 4411 commercial material testing machine. The parts were connected and disconnected at constant speed of 1mm per minute and the load necessary to maintain constant speed was recorded. I considered that the maximum load recorded during the disconnection part of the cycle is

an indication of the link strength. As shown in Fig 26, the link strength decreases with the number of previous connections. However the lower limit seems to be within about 30% of the initial value which is satisfactory.

I presented a simple, rapid, reversible, and highly versatile printer for assembling three-dimensional digital structures. The printer achieves these qualities by employing parts that are digital in nature, and that can be made out of various materials among which are functional materials. Digital printing of digital materials, as presented in this paper, is a cheap and simple solution for 3-D printing of functional materials for free-form fabrication.



## 2. Prototyping

A prototype was built during the first semester of 2007 with the active collaboration of Jean Chang.

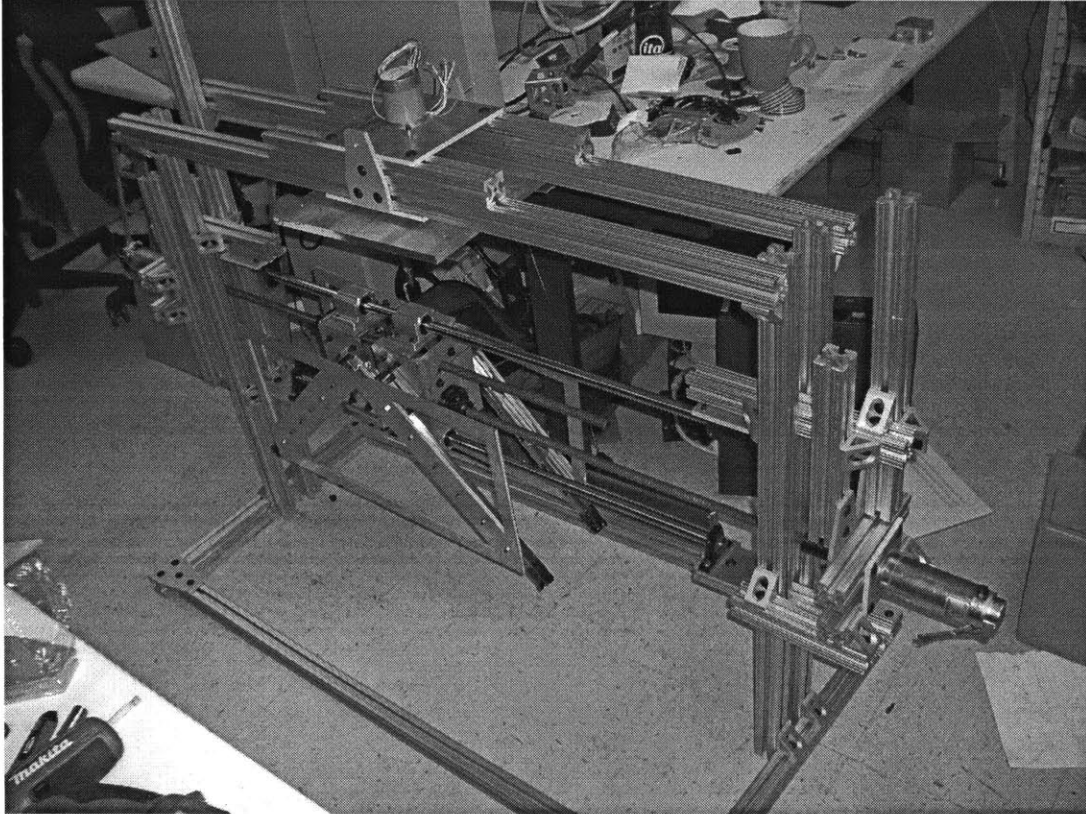

Figure 27: Picture of the GIK assembler prototype.

### Requirements

The following requirements were used:

- Speed: 1 foot per second = 0.30 m/s
- Precision x ,z: 0.05 inches
- lift a 20 kg head by 1 foot
- be able to build a 1 cubic foot GIK structure

- use the GIK in Figure 19
- press fit the parts in the head with 200N to add them in the structure

## Calculations

The following calculations follow:

If I use a 0.2-inch-lead ball screw and given that 1 step is 1.8 degrees this implies that a precision of 0.001 inches which is more than satisfactory.

If I require 12 inches per second in linear speed, given that the machine moves linearly by 0.2 inches per turn this speed translates in 60 rps or 3600 rpm. Therefore a rotational speed of 3600 rpm should be used.

Torque is defined in the equation:

$$\text{Power} = \text{torque} \times \text{angular speed}$$

where:

$$\text{Power} = \text{Energy}/\text{time}$$

and where the energy to lift a weight by 1 foot is  $\text{mass} * g * \text{height}$ .

In our case I estimate the weight to be lifted (head + GIK parts) to be:

$$m = 20 \text{ kg}$$

$$g = 10 \text{ m/s/s}$$

$$h = 1 \text{ foot} = 0.30 \text{ m}$$

$$t = 1 \text{ sec}$$

$$\text{Power} = 20 * 10 * 0.3 / 1 = 60 \text{ watts} = 0.06 \text{ kW}$$

Therefore the machine will spend 60 watts if I don't include friction to move the head up and down.

To calculate the torque needed:

$$\text{Torque} = 30000 * \text{power} / \pi / \text{rpm} = 30000 * 0.06 / 3600 / 3.14 = 0.159 \text{ Nm} = 0.117 \text{ (ft pounds)} = 22.46400 \text{ inch ounce}$$

If I include 20% friction loss we have 26.95 inch ounce.

I can use this number to size the motor needed for this application.

However:

To reduce the speed at which the ball screws had to turn (3000 rpms), I built the machine using a 0.5 inch lead ball screw which gives a speed of 1200 rpm, number which I can use to size the motor needed for the application.

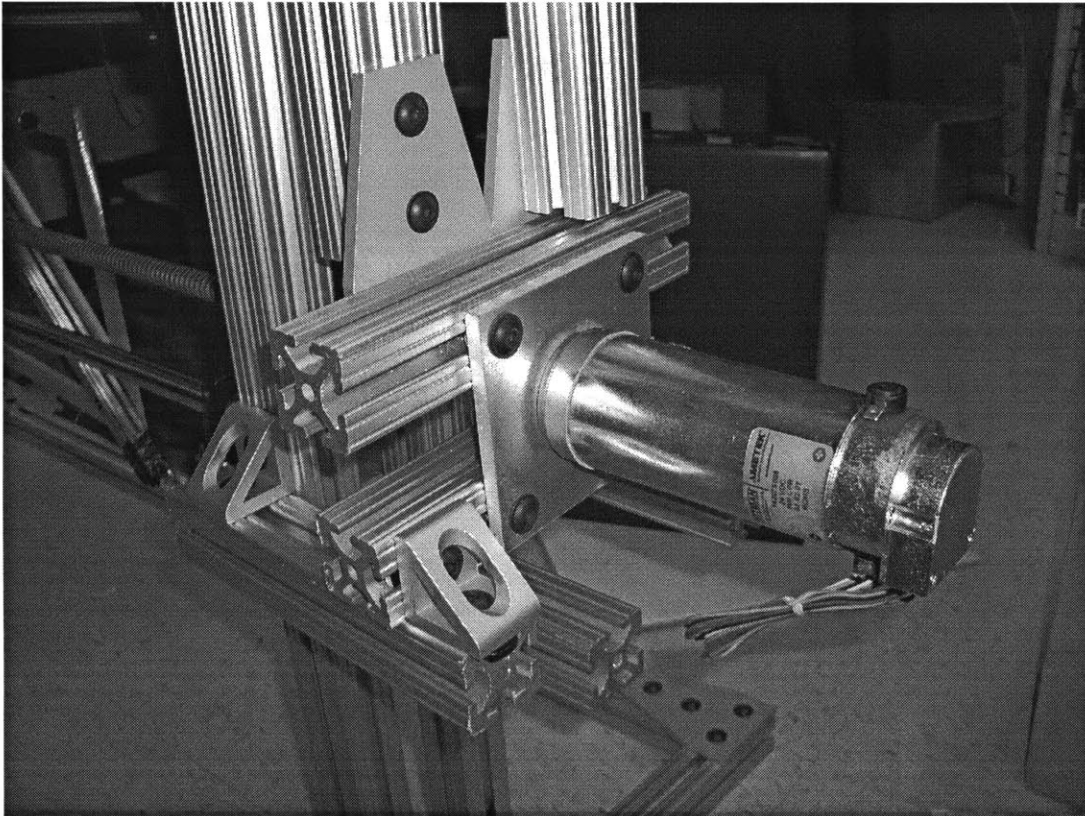

*Figure 28: Picture of the electrical motors used on the prototype and the way it is mounted.*

## **Design**

The rails are mounted at 90 degrees and at 45% to the ball screws perpendicular plane. This angle allows us to use both motors simultaneously for any movement. I am using 2 rails to guide the head support plates. I am using ball screws to translate motor rotational movement into linear movement.

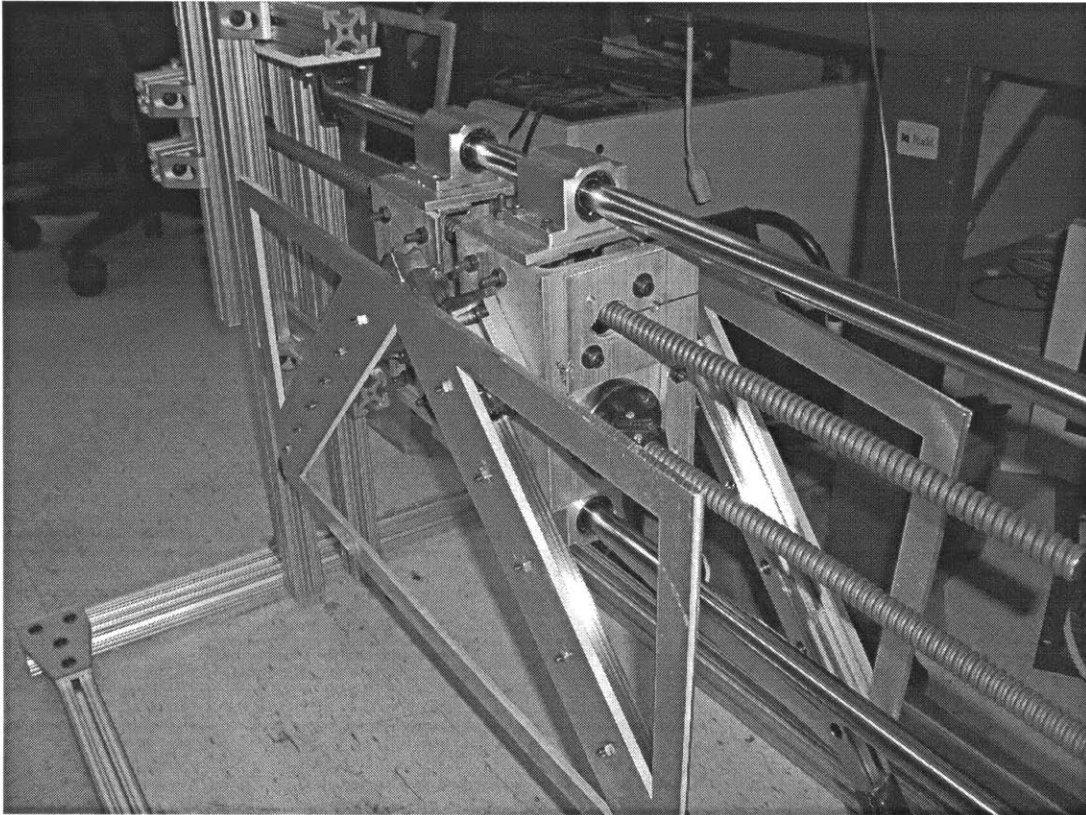

*Figure 29: Picture of the prototype's ball screws on which are mounted the 2 guide blocks, to which are attached the support plates.*

Deflection rod rails:

Young modulus: 190 GPa

Moment of inertia:  $1/12 M/ L^2=0.5467$

$M= d*\pi*r^2xL$

$L= 24''$

$D=7\ 800$

$R=0.5*2.54*0.01$

$L=24*2.51*0.01$

$Pi=3.14$

Load =  $20\text{kg}*10\text{N/Kg}=200\text{N}$

Dynamic Load Capacity— This value, expressed as PV (pressure x velocity), should not exceed 40,000 for ceramic-lined bearings or 20,000 (10,000 for 6396K, 6676K, 2570K, and 8639T) for other lined bearings. To check if a given bearing will handle your load and speed, calculate PV value for your application. Static load is the load on a bearing when it's not in motion. Velocity is the rate at which the load will travel; it should not exceed 1000 fpm for ceramic-lined bearings or 300 fpm (140 fpm for 6396K) for lined bearings.

Static load: 40 lbs

Bearing length 2"

Shaft diameter: 0.75

Velocity: 60 fpm

Total: 1600

## **Actuation**

Different actuation methods were considered.

1. The first method was stepper motors which will also give a good idea of the position of the head while moving. However they are expensive and they are unable to exert static forces.
2. The second method was stepper motors with solenoids. However solenoids add to the cost and they need very high currents to be actuated.
3. Third idea was brushless DC motors with circular encoders for position feedback. Current monitoring would be used to measure the force the static force they can apply.

For the frame I chose to use 80/20, the industrial erector set because it is very modular, allows for position adjustment and is readily available. 80/20 did provide enough modularity which allowed us to compensate the misalignments between the motor shaft and the ball screw, the coupler I chose being too rigid to compensate.

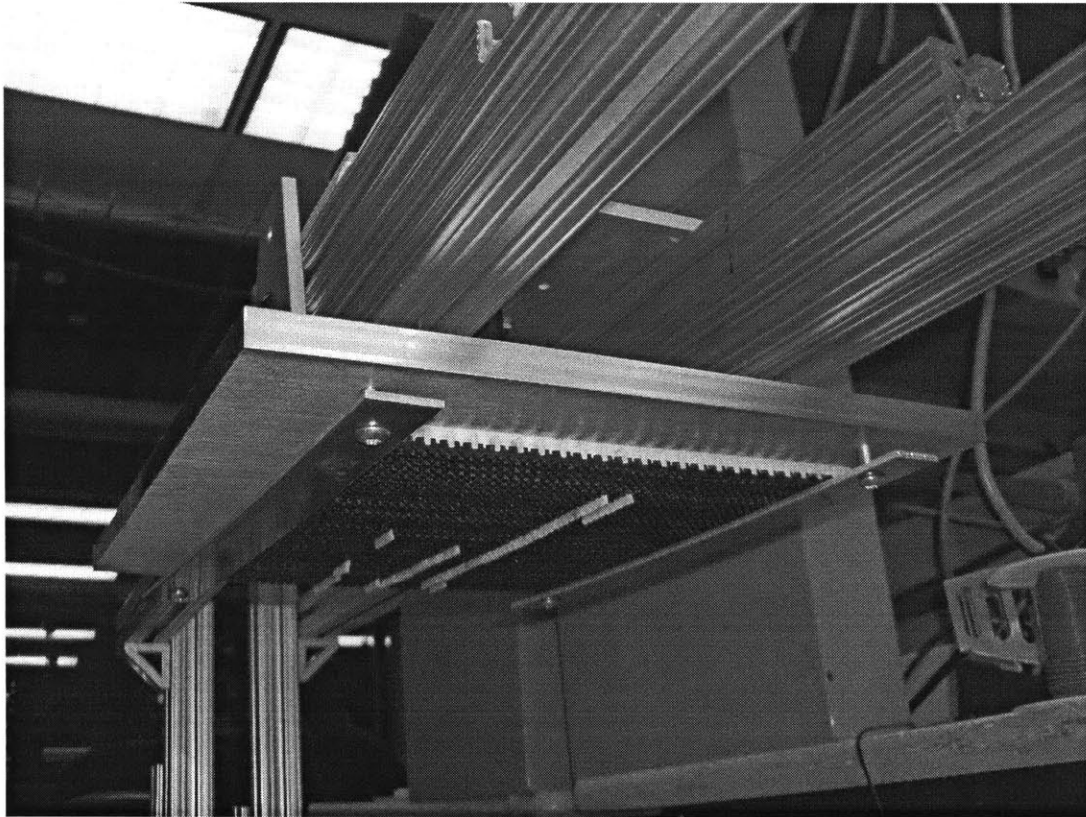

*Figure 30: Picture of the support plate to which is attached the GIK 1 st layer. This first layer plays the role of the green plates for LEGO.*

The support plate was build out of  $\frac{1}{2}$  inch aluminum for rigidity. On top of it were screwed 2 parallel plates which were holding down the first plane of the GIK structure on top of which the structure is to be built.

The support plate can rotate 90 degree as it is mounted on 2 thrust bearings and it's shaft is directly actuated by a stepper motor mounted to the frame. Mounting the support plate on the 2-inch-in-diameter shaft was done using 3 screws perfectly aligned on a circle on a lathe. Using 4 screws would have over-constrained the coupling and would have added to the stress which could have been a possible failure point. The stepper motor shaft was coupled to a .5 inch shaft which was coupled to the 2" shaft with a transversal pin.

## Future Work

As expected the first prototype is not perfect. However, this first prototype is an extremely valuable input for the next project which will be the building of a second prototype including all the steps in future work.

- Couplers: The DC-motor to ball-screw couplers were chosen to be flat rigid steel couplers. The couplers are coupling (see FIG 28) the DC motor shaft to the ball-screws directly. This ended up being a design issue as the ball-screws don't have enough surface to provide enough friction. Therefore at the smallest misalignment the coupling comes apart. A proper coupling to a ball screw is 200\$ each.
- Ball screw support: The other end of the ball screws is free standing ( the ball screw is cantilevering). This was also a choice because a ball-screw end mount is 200\$ each. The result is that the deflection of the ball screw is too important and the ball screw vibrates significantly during movement.
- Better part alignment: all the parts were misaligned which added to the friction the DC motors had to fight to move the GIK printer head up and down. Also due to this, at each ball-screw revolution, the ball screw itself is vibrating with the amplitude of the misalignment and given the operating speed ( 1200 rpms) this is making the entire machine vibrate dangerously.
- Feeder: no feeders were developed for this machine. Feeders will have to be built that will allow us to feed the machine head.
- Encoders: the signal coming from the encoders was not used. This will provide good feedback on the machine head position.
- Size: the machine size and weight are too large. The machine size and weight needs to be reduced.
- Head size: the head was designed to work with only 1 size of GIK parts. The head needs to be able to handle different head size.
- The machine was designed to add 12 inches of GIK in 10 seconds. To be competitive and build the structure in reasonable times the assembler should be able to add 1 line to the structure in 1/10<sup>th</sup> of a second

- Exponential fabrication: to be competitive the assembler should be able to add lines to more than 1 plane in parallel then to be able to add planes one after the next one.
- Disassembly: the assembler is not able to disassemble structures.

The study of the GIK digital material shows that it is a viable material for 3D printing, therefore future work should focus on the assembler.

## Conclusion

I presented in this thesis my work on the material science of digital material followed by the description of a theoretical model and a working prototype of the digital assembler. I propose printing of micron-size digital material as the next technology for 3-D printing of free-from structures of functional materials. In the body of this thesis I demonstrated:

- multimaterial GIK bricks made out of 8 different materials
- multiscale GIK bricks of sizes spanning 4 orders of magnitude
- error reduction that increasing the number of rows in the structure the position error will go from above-linear to linear in structure length.
- error tolerance: GIK bricks with a chamfer of angle  $\alpha$  and width  $w$  which will roughly allow for a misalignment of  $\pm w$  and  $\pm \alpha$  degrees tilt.
- error detection: the calculations that will enable the detection of an error in the construction in of a GIK structure.
- active materials as GIK Si-Cu-Pb diode structure with a non linear voltage-current curve.
- isotropy by void as I showed a structure of 8 by 8 by 8 GIK parts with different compression Young modulus in 3 different directions: x,y and z.
- compression tuning by varying the portion of GIK to holes in a GIK structure I can vary the compression Young modulus in the GIK structure by more than 10%.
- compression tuning: by varying the portion of plywood GIK parts to aluminum GIK parts in a structure can vary the compression Young modulus



- tension tuneability: the amount of force needed to separate 2 GIK parts can vary by more than 10% by varying the size of the GIK slot.
- I demonstrated a theoretical description as well as a GIK printer prototype that will allow to assemble GIK structures.

In this thesis I described a new kind of fabrication which is fundamentally different from any existing analog fabrication techniques, commercial or not.

The next Digital Assembler prototypes will be faster, cheaper and will be able to do error detection as well as error correction by means of disassembly of digital structures. The short term application of digital fabrication is to allow an individual in an average home environment to build a nearly infinite number of different objects for a very reasonable cost. The long term application of digital fabrication is to enable more people to make more interesting things easily.

## References

- [1] George M. Whitesides, Bartosz Grzybowski, Self-Assembly at All Scales, *Science* 29 March 2002, Vol. 295. no. 5564, pp. 2418 – 2421
- [2] Saul Griffith, *Growing Machines*, Ph.D Thesis, September 2004, Massachusetts Institute of Technology
- [3] Paul W.K. Rothmund, Nick Papadakis, Erik Winfree, Algorithmic Self-Assembly of DNA Sierpinski Triangles, *PLoS Biology* 2 (12) e424, 2004
- [4] Paul W. K. Rothmund, Folding DNA to create nanoscale shapes and patterns, *Nature* 440, 297-302
- [5] George A. Popescu, Patrik Kuntzler, Neil Gershenfeld, Digital printing of digital materials, Digital Fabrication Conference, Denver, CO September 2006
- [6] Neil Gershenfeld, Patrik Kuntzler, George A. Popescu, Digital assembler for digital materials, Pending Provisional Patent, Assignee MIT
- [7] Digital Communications, Digital Computation Reliable Computation in the Presence of Noise, S. Winograd and J.D. Cowan, December 1963 ISBN-10: 0-262-23008-9
- [8] Algorithmic Self-Assembly of DNA Sierpinski Triangles, Paul W. K. Rothmund, Nick Papadakis, Erik Winfree, *PLoS Biol* 2(12): e424
- [9] Programmed Assembly of DNA functionalized quantum dot. Mirkin, R. L. and al., *Journal of the American Chemical Society* 121:3535, 8122-8123, American Chemical Society, 1999.
- [10] Self-Assembly at All Scales, George M. Whitesides,\* Bartosz Grzybowski, *Science* 29 March 2002: Vol. 295. no. 5564, pp. 2418 - 2421
- [11] Schottky diode logic family (Patent number: 4798979 )
- [12] *Photonic Crystals: Towards Nanoscale Photonic Devices* By J.-M (Jean-Michel) Lourtioz, Published 2005 Springer, ISBN 354024431X
- [13] Locally Resonant Sonic Materials ,Liu, Z. Zhang, X. Mao, Y. Zhu, Y. Y. Yang, Z. Chan, C. T. Sheng, P., *Science -New York then Washington-*, 2000, ISSU 5485, pages 1734-1736
- [14] The complexity table and metric presented in this thesis, to the best of the author's knowledge. were the sole idea and were first calculated by Prof. Joseph Jacobson and

were presented to the author during two classes ( Physics for Information Technologies and How to Make something that makes almost anything) during the author's curriculum at Massachusetts Institute of Technology

[15] Prof. Neil Gershenfeld's presentation at the 2<sup>nd</sup> Digital Fabrication Symposium, CSIR, June 29<sup>th</sup> 2006, South-Africa.

[16] H. Nyquist, "Certain topics in telegraph transmission theory", Trans. AIEE, vol. 47, pp. 617-644, Apr. 1928 Reprint as classic paper in: Proc. IEEE, Vol. 90, No. 2, Feb 2002

[17] C. E. Shannon, "Communication in the presence of noise", Proc. Institute of Radio Engineers, vol. 37, no.1, pp. 10-21, Jan. 1949. Reprint as classic paper in: Proc. IEEE, Vol. 86, No. 2, (Feb 1998)

[18] Saul Griffith, Dan Goldwater, JosephM. Jacobson, Self-replication from random parts, Nature, Vol 437,29 September 2005

[19] Prof. Joseph M. Jacobson's presentation during the MIT class MAS762 during the spring of 2006. Presentation available at:

[http://fab.cba.mit.edu/classes/MIT/862.06/classes/4\\_10/jacobson.ppt](http://fab.cba.mit.edu/classes/MIT/862.06/classes/4_10/jacobson.ppt)

[20] George A. Popescu, Patrik Kuntzler, Neil Gershenfeld, Digital material for digital printing, Digital Fabrication Conference, Denver, CO September 2006

The work presented in this thesis was funded by MIT's Center for Bits and Atoms (CCR-0122419)

## Appendix

### Addendum 1: standup.m

This software is a GIK structure design software. It calculates the completed structure and upon being given the parts to remove it's calculating if the resulting structure is expected to stand up or to fall in a very simplistic method.

These lines describe the GIK structure topology:

```
% create structure
% We need a 3D structure with tiles connected to 4 other tiles.
nbx=8;
nby=8;
nbz=8;
%f=2;
%there is a 1 in the structure is there is a tile in position x,y,z
structure=ones(nbx,nby,nbz);
structure1=zeros(nbx,nby,nbz);
% x=1 (x,z) or (y,z)
% x=2 (x,y) or (y,z)
% y=1 (x,y) or (y,z)
% y=2 (x,y) or (x,z)
% z=1 (x,y) or (x,z)
% z=2 (x,z) or (y,z)

for x = [1:1:nbx];
for y = [1:1:nby];
for z = [1:1:nbz];
    conn=[0,0,0];
    if rem(x,2)==1
        conn(1)=conn(1)+1;
        conn(3)=conn(3)+1;
    else
        conn(2)=conn(2)+1;
        conn(3)=conn(3)+1;
    end
    if rem(y,2)==1
        conn(2)=conn(2)+1;
        conn(3)=conn(3)+1;
    else
        conn(2)=conn(2)+1;
        conn(1)=conn(1)+1;
    end
    if rem(z,2)==1
        conn(2)=conn(2)+1;
        conn(1)=conn(1)+1;
    else
        conn(1)=conn(1)+1;
        conn(3)=conn(3)+1;
    end

    if max(conn)<3
```

```

        structure(x,y,z)=0;
    end

end
end
end

% the connections go like this:
%101 is connected with 001,201,100,102
%201 is connected with 101 301 211 2-11
%211 is connected with 201 221 212 210

% remove tiles
fx=2;fy=3;fz=4;

x=[1:fx:nbx];
y=[2:fy:nby];
z=[1:fz:nbz];
structure(x,y,z)=0;

%connected or not?
for a=[1:nbx]
    L=bwlabel(reshape(structure(a,:,:),nby,nbz),4);
    if max(max(L))>1
        % the structure collapses if at least one vertical plane is made
        % out of 2 portions.
        stringtodisp=['collapse with a frequency of ' num2str(fx) ' '
num2str(fy) ' ' num2str(fz) ]
        disp(stringtodisp)
    else
        disp('Structure will stand up')
    end
end

end

```

### Program outputs:

#### Case 1:

```

% remove tiles
fx=2;fy=2;fz=2;

```

Result 1:

```
>> collapse with a frequency of 2 2 2
```

#### Case 2:

```

% remove tiles
fx=2;fy=3;fz=4;

```

Result2: >>Structure will stand up