

## MIT Open Access Articles

*From duality to determinants for  $q$ -TASEP and ASEP*

The MIT Faculty has made this article openly available. **Please share** how this access benefits you. Your story matters.

**Citation:** Borodin, Alexei, Ivan Corwin, and Tomohiro Sasamoto. "From Duality to Determinants for  $q$ -TASEP and ASEP." *The Annals of Probability* 42, no. 6 (November 2014): 2314–2382. © 2014 Institute of Mathematical Statistics

**As Published:** <http://dx.doi.org/10.1214/13-AOP868>

**Publisher:** Institute of Mathematical Statistics

**Persistent URL:** <http://hdl.handle.net/1721.1/92807>

**Version:** Final published version: final published article, as it appeared in a journal, conference proceedings, or other formally published context

**Terms of Use:** Article is made available in accordance with the publisher's policy and may be subject to US copyright law. Please refer to the publisher's site for terms of use.



## FROM DUALITY TO DETERMINANTS FOR $q$ -TASEP AND ASEP

BY ALEXEI BORODIN<sup>1</sup>, IVAN CORWIN<sup>2</sup> AND TOMOHIRO SASAMOTO<sup>3</sup>

*Massachusetts Institute of Technology and Institute for Information Transmission Problems, Columbia University, Clay Mathematics Institute and Massachusetts Institute of Technology, and Chiba University*

We prove duality relations for two interacting particle systems: the  $q$ -deformed totally asymmetric simple exclusion process ( $q$ -TASEP) and the asymmetric simple exclusion process (ASEP). Expectations of the duality functionals correspond to certain joint moments of particle locations or integrated currents, respectively. Duality implies that they solve systems of ODEs. These systems are integrable and for particular step and half-stationary initial data we use a nested contour integral ansatz to provide explicit formulas for the systems' solutions, and hence also the moments.

We form Laplace transform-like generating functions of these moments and via residue calculus we compute two different types of Fredholm determinant formulas for such generating functions. For ASEP, the first type of formula is new and readily lends itself to asymptotic analysis (as necessary to reprove GUE Tracy–Widom distribution fluctuations for ASEP), while the second type of formula is recognizable as closely related to Tracy and Widom's ASEP formula [*Comm. Math. Phys.* **279** (2008) 815–844, *J. Stat. Phys.* **132** (2008) 291–300, *Comm. Math. Phys.* **290** (2009) 129–154, *J. Stat. Phys.* **140** (2010) 619–634]. For  $q$ -TASEP, both formulas coincide with those computed via Borodin and Corwin's Macdonald processes [*Probab. Theory Related Fields* (2014) **158** 225–400].

Both  $q$ -TASEP and ASEP have limit transitions to the free energy of the continuum directed polymer, the logarithm of the solution of the stochastic heat equation or the Hopf–Cole solution to the Kardar–Parisi–Zhang equation. Thus,  $q$ -TASEP and ASEP are integrable discretizations of these continuum objects; the systems of ODEs associated to their dualities are deformed discrete quantum delta Bose gases; and the procedure through which we pass from expectations of their duality functionals to characterizing generating functions is a rigorous version of the replica trick in physics.

---

Received August 2012; revised March 2013.

<sup>1</sup>Supported in part by NSF Grant DMS-10-56390.

<sup>2</sup>Supported in part by NSF PIRE Grant OISE-07-30136 and DMS-12-08998 as well as by Microsoft Research through the Schramm Memorial Fellowship, and by the Clay Mathematics Institute.

<sup>3</sup>Supported by KAKENHI (22740054).

*MSC2010 subject classifications.* 82C22, 82B23, 60H15.

*Key words and phrases.* Interacting particle systems, Kardar–Parisi–Zhang universality class, Markov duality, asymmetric simple exclusion process.

## CONTENTS

1. Introduction . . . . .	2315
2. Duality and the nested contour integral ansatz for $q$ -TASEP . . . . .	2320
3. A general scheme from nested contour integrals to Fredholm determinants . . . . .	2329
4. Duality and the nested contour integral ansatz for ASEP . . . . .	2337
5. From nested contour integrals to Fredholm determinants for ASEP . . . . .	2357
Appendix A: Semidiscrete directed polymers . . . . .	2365
Appendix B: Combinatorics . . . . .	2372
Appendix C: Uniqueness of systems of ODEs . . . . .	2375
Appendix D: GUE Tracy–Widom asymptotics for ASEP . . . . .	2377
Acknowledgements . . . . .	2380
References . . . . .	2380

**1. Introduction.** One-dimensional driven diffusive systems play an important role in both physics and mathematics (see, e.g., [14, 24, 36]). As physical models they are used to study mass transport, traffic flow, queueing behavior, driven lattice gases, and turbulence. Their integrated current defines height functions which model one-dimensional interface growth. In certain cases, they can be mapped into models for directed polymers in random media and propagation of mass in a disordered environment. The particle systems provide efficient means to implement simulations of these various types of systems and, in some rare cases, yield themselves to exact and rigorous mathematical analysis.

This article is concerned with two interacting particle systems— $q$ -TASEP with general particle jump rate parameters, and ASEP with general bond jump rate parameters—which contain rich mathematical structure. Presently, we seek to shed light on structure which exists in parallel for both of these systems. We demonstrate duality relations (see Definition 2.1) for both of these systems directly from their Markovian dynamics:  $q$ -TASEP is dual to a totally asymmetric zero range process TAZRP (Theorem 2.2) whereas ASEP is self-dual (Theorems 4.1 and 4.2). A consequence of duality is that expectations of a large class of natural observables of these systems evolve according to systems of ODEs.

For  $q$ -TASEP, the duality result is, to our knowledge, new. When all particle jump rate parameters are equal, dynamics of  $q$ -TASEP can be encoded via a quantum integrable system in terms of  $q$ -Bosons [6, 33]. For ASEP with all bond jump rate parameters equal, the ASEP self-duality was observed by Schütz [34] (see Remark 4.4) via a spin chain representation of ASEP (which is related to the XXZ model—a well-studied quantum integrable system). Our results apply for general rates and proceed directly via the Markov dynamics.

The most surprising observation of this article is that, for certain initial data called *step* and *half stationary*, we are able to explicitly solve the systems of ODEs for  $q$ -TASEP and ASEP in terms of simple nested-contour integrals. For  $q$ -TASEP, this works for the full generality of particle jump rate parameters, whereas for ASEP we must assume all bond jump rate parameters to be equal at this stage and

henceforth. For  $q$ -TASEP, the integral representations of the solution can also be obtained via the formalism of Macdonald processes [9, 11], while for ASEP we were guided by analogy and results of [19].

Let us state the simplest versions of these formulas, focusing just on step initial data in which initially half of the lattice is entirely empty and the other half entirely full (see Definitions 2.9 and 4.12). We also informally introduce the dynamics of  $q$ -TASEP and ASEP.

The  $q$ -TASEP is a continuous time Markov process  $\vec{x}(t)$ . Particles occupy sites of  $\mathbb{Z}$  and the location of particle  $i$  at time  $t$  is written as  $x_i(t)$  and particles are ordered so that  $x_i(t) > x_j(t)$  for  $i < j$ . The rate at which the value of  $x_i(t)$  increase by one (i.e., the particle jumps right by one) is  $a_i(1 - q^{x_{i-1}(t) - x_i(t) - 1})$ ; all jumps occur independently of each other according to exponential clocks. Here,  $q \in [0, 1)$  represents the strength of the repulsion particle  $x_i$  feels from particle  $x_{i-1}$ . For the purpose of this introduction, we restrict to  $a_i \equiv 1$  and consider only step initial data where particles start at every negative integer location and nowhere else [i.e., for  $i \geq 1, x_i(0) = -i$ ]. The following result appears as Corollary 2.12.

**THEOREM 1.1.** *Consider  $q$ -TASEP with step initial data and particle jump rate parameters  $a_i \equiv 1$ . Then for any  $k \geq 1$  and  $n_1 \geq n_2 \geq \dots \geq n_k > 0$ ,*

$$\mathbb{E} \left[ \prod_{j=1}^k q^{x_{n_j}(t) + n_j} \right] = \frac{(-1)^k q^{k(k-1)/2}}{(2\pi i)^k} \int \dots \int \prod_{1 \leq A < B \leq k} \frac{z_A - z_B}{z_A - qz_B} \prod_{j=1}^k (1 - z_j)^{-n_j} e^{(q-1)tz_j} \frac{dz_j}{z_j},$$

where the integration contour for  $z_A$  contains  $\{qz_B\}_{B>A}$  and 1 but not 0.

The ASEP (occupation process) is a continuous time Markov process  $\eta(t) = \{\eta_x(t)\}_{x \in \mathbb{Z}}$ . The  $\eta_x(t)$  are called occupation variables and are 1 or 0 based on whether there is a particle or hole at  $x$  at time  $t$ . The dynamics of this process is specified by nonnegative real numbers  $p \leq q$  (normalized by  $p + q = 1$ ) and uniformly bounded (from infinity and zero) rate parameters  $\{a_x\}_{x \in \mathbb{Z}}$ . For each pair of neighboring sites  $(y, y + 1)$ , the following exchanges happen in continuous time:

$$\begin{aligned} \eta &\mapsto \eta^{y,y+1} && \text{at rate } a_y p && \text{if } (\eta_y, \eta_{y+1}) = (1, 0), \\ \eta &\mapsto \eta^{y,y+1} && \text{at rate } a_y q && \text{if } (\eta_y, \eta_{y+1}) = (0, 1), \end{aligned}$$

where  $\eta^{y,y+1}$  denotes the state in which the value of the occupation variables at site  $y$  and  $y + 1$  are switched, and all other variables remain unchanged. All exchanges occur independently of each other according to exponential clocks. For the purpose of this introduction, we restrict to  $a_x \equiv 1$  and consider only step initial

data<sup>4</sup> where  $\eta_x(0) = \mathbf{1}_{x \geq 1}$ . Assume  $0 < p < q$  and let  $\tau = p/q < 1$ . Finally, let  $N_x(t) = \sum_{y \leq x} \eta_y(t)$  record the number of particles to the left of position  $x + 1$  at time  $t$ .

The following result on ASEP appears as Theorem 4.20.

**THEOREM 1.2.** *Consider ASEP with step initial data and all bond rate parameters  $a_x \equiv 1$ . Then for all  $n \geq 1$  and  $x \in \mathbb{Z}$ ,*

$$\begin{aligned} \mathbb{E}[\tau^{nN_x(t)}] &= \tau^{n(n-1)/2} \frac{1}{(2\pi i)^n} \\ &\times \int \cdots \int \prod_{1 \leq A < B \leq n} \frac{z_A - z_B}{z_A - \tau z_B} \\ &\times \prod_{i=1}^n \exp\left[-\frac{z_i(p-q)^2}{(z_i+1)(p+qz_i)}t\right] \left(\frac{1+z_i}{1+z_i/\tau}\right)^x \frac{dz_i}{z_i}, \end{aligned}$$

where the integration contour for  $z_A$  includes  $0, -\tau$  but does not include  $-1$ , or  $\{\tau z_B\}_{B>A}$  (see Figure 5 for an illustration of such contours).

These expectations contain sufficient information to uniquely characterize the distribution of the location of a given collection of particles (after the system has evolved for some time) in each of these systems. Focusing on a single  $x_n(t)$  or  $N_x(t)$  distribution, we can concisely characterize this via generating functions of suitable expectations. There are two types of generating functions we consider—both related to  $q$ -deformed (or for ASEP  $\tau$ -deformed) Laplace transform introduced by Hahn [17] in 1949.

These generating functions are naturally suggested from the nested structure of the contour integral formulas for these expectations. There are two ways to deform the nested contour integrals so all contours coincide. Accounting for the residues encountered during these deformations, we are led to two types of formulas for expectations: those involving partition-indexed sums of contour integrals and those involving sums of contour integrals indexed by natural numbers.

Using the partition-indexed formulas, we prove that the first generating function is equal to a Fredholm determinant which we call *Mellin–Barnes* type. The following result is contained in Theorem 5.3.

**THEOREM 1.3.** *Consider ASEP with step initial data and all bond rate parameters  $a_x \equiv 1$ . Then for all  $x \in \mathbb{Z}$  and  $\zeta \in \mathbb{C} \setminus \mathbb{R}_+$ ,*

$$\mathbb{E}\left[\frac{1}{(\zeta \tau^{N_x(t)}; \tau)_\infty}\right] = \det(I + K_\zeta^{\text{ASEP}}),$$

---

<sup>4</sup>Observe that the step initial data for  $q$ -TASEP involves particles to the left of the origin, whereas for ASEP it involves particles to the right of the origin. We decided to keep these conventions to be consistent with previous works on the subject.

where  $(a; \tau)_\infty = (1 - a)(1 - \tau a) \cdots$ , and where the  $L^2$  space on which  $K_\zeta^{\text{ASEP}}$  acts can be found in the statement of Theorem 5.3. The operator  $K_\zeta$  is defined in terms of its integral kernel

$$K_\zeta^{\text{ASEP}}(w, w') = \frac{1}{2\pi i} \int_{D_{R,d}} \Gamma(-s)\Gamma(1+s)(-\zeta)^s \frac{f_w(x, t)}{f_{\tau^s w}(x, t)} \frac{1}{w' - \tau^s w} ds.$$

(The contour  $D_{R,d}$  is specified in the statement of Theorem 5.3.) The function  $f_z(x, t)$  is given by

$$f_z(x, t) = \exp\left[(q - p)t \frac{\tau}{z + \tau}\right] \left(\frac{\tau}{z + \tau}\right)^x.$$

This type of formula lends itself to rigorous asymptotic analysis. For ASEP, this formula is new and in Appendix D we sketch how it can be used to recover Tracy and Widom’s celebrated fluctuation result [40] which states that

$$(1) \quad \lim_{t \rightarrow \infty} \mathbb{P}\left(\frac{N_0(t/\gamma) - (t/4)}{t^{1/3}} \geq -r\right) = F_{\text{GUE}}(2^{4/3}r).$$

Here,  $\gamma = q - p$  is assumed to be strictly positive and  $F_{\text{GUE}}$  is the GUE Tracy–Widom distribution. The case when  $\gamma = 1$  ( $q = 1$  and  $p = 0$ ) was proved earlier by Johansson [21]. Theorem 1.3 also allows to access (under a certain weakly asymmetric scaling) the narrow wedge KPZ equation one point formula [1, 32].

For  $q$ -TASEP, such a Mellin–Barnes type formula was obtained from the theory of Macdonald processes [9], Theorem 4.1.40. It should be possible to use this Fredholm determinant to prove cube-root GUE Tracy–Widom fluctuations for the current past the origin in  $q$ -TASEP. This has not yet been done, though in an stationary version of the TAZRP associated to  $q$ -TASEP gaps, the cube-root fluctuation scale is shown in [3] (via a different approach). In [9, 10], the  $q$ -TASEP Mellin–Barnes-type Fredholm determinant formula is used (via a limit transition) to write the Laplace transform of the O’Connell–Yor semidiscrete polymer partition function [29]. Then [9, 10] perform rigorous asymptotic analysis to show cube-root GUE Tracy–Widom free energy fluctuations as well as to provide a second rigorous derivation of the narrow wedge KPZ equation formula (first rigorously derived in [1]). From the perspective of asymptotics, this second approach is a little less involved than that of [1].

On the other hand, using the formulas of the second type (i.e., deforming contours in Theorems 1.1 and 1.2 differently), we prove that the second generating function is equal to a Fredholm determinant which we call *Cauchy* type. The ASEP Fredholm determinant Tracy and Widom derived in [38, 39] is also of this type (and in fact, after inverting the  $e_\tau$ -Laplace transform we recover the same formula as in [38, 39]). Asymptotic analysis of this type of determinant is not as straightforward as the Mellin–Barnes type. In [40], Tracy and Widom employ a significant amount of post-processing to turn this type of formula into one for which

they could perform asymptotic analysis. The final formula still involves a complicated term related to the Ramanujan summation formula (as observed in [32]). One should note that while we do recover (among other formulas) the Tracy–Widom ASEP Fredholm determinant formula, our approach via duality is entirely different, our contour integral ansatz is not a version of the coordinate Bethe ansatz and, along the way, we gain access to other information about ASEP, like joint moment formulas. The Cauchy-type Fredholm determinant formula for  $q$ -TASEP was also first derived in [9] via Macdonald processes.

In short, by utilizing duality for  $q$ -TASEP and ASEP, we are able to provide a short and direct route from Markov dynamics to Fredholm determinant formulas characterizing single particle location or single integrated current distributions.

Both  $q$ -TASEP and ASEP are integrable discretizations of the KPZ equation. As stochastic processes, they converge to the Hopf–Cole solution to the KPZ equation [1, 5, 27]. The systems of ODEs associated with their duality appear (though no exact results to this effect have yet been proved) to have limit transitions to the attractive quantum delta Bose gas which describes the evolution of joint moments of the stochastic heat equation (whose logarithm is the KPZ equation and which describes the partition function for the continuum random polymer).

An advanced version of the popular physics polymer replica trick attempts to recover the Laplace transform of the one point distribution of the solution to the stochastic heat equation in terms of its moments (see Section A.4). However, the moments grow far too quickly to characterize this distribution, and hence drawing conclusions from them is mathematically unjustifiable and in any case, risky. Nevertheless, Dotsenko [15] and Calabrese, Le Doussal and Rosso [12] were eventually able to use this trick to recover the exact formulas of [1, 32].

It was then natural to consider a discrete analog of this replica approach. The fact that duality gives a useful tool for computing the moments for ASEP was first noted in [19]. By combining this observation with some of the calculational techniques developed in [9], in the present paper we provide a unified and complete scheme to study both  $q$ -TASEP and ASEP. Given the results of our work, the nonrigorous replica trick manipulations can be seen as shadows of the rigorous duality to determinant approach developed presently. That is to say that by going to a suitable discrete approximation we are able to rigorously recover analogs of Laplace transforms from moments and then in the limit transition these converge to formulas for the stochastic heat equation’s Laplace transform. The replica trick has proved computationally useful (see, e.g., [20]), thus providing additional motivation for the present work.

The limit transition of  $q$ -TASEP to the O’Connell–Yor semidiscrete directed polymer [29] (and associated semidiscrete stochastic heat equation) is explored in Appendix A. Under that limit transition, duality becomes the replica approach and the duality system of ODEs become a semidiscrete version of the delta Bose gas. The nested contour integral ansatz provides means to succinctly compute the solution to the Bose gas. The Fredholm determinants for  $q$ -TASEP limit to Fredholm determinants for the Laplace transform of the polymer partition function.

While a variety of probabilistic systems arise as degenerations of Macdonald processes, ASEP is not known to be one of them. For ASEP, it is not known what, if anything, replaces this additional integrable structure endowed to  $q$ -TASEP from its connection to symmetric functions. However, it is compelling that both  $q$ -TASEP and ASEP have duality relations and that the associated systems of ODEs can both be solved via a nested contour integral ansatz. This leads one to ask whether  $q$ -TASEP and ASEP can be unified via a theory even higher than Macdonald processes. Spohn [37] has coined the term *stochastic integrability* to describe stochastic processes which display a great deal of integrable structure. Perhaps, so as to avoid confusion with stochastic integrals, a more appropriate name for the present area of study is *integrable stochastic particle systems*. Both  $q$ -TASEP and ASEP are clear examples of such systems and the contributions of this work provide an additional layer to that integrability. An upcoming work [8] introduces two discrete time variants of  $q$ -TASEP and shows how the methods and ideas of the present paper extend to the study of these systems as well.

**1.1. Outline.** The paper is organized as follows. In Section 2, we prove duality for  $q$ -TASEP and explicitly solve the associated systems of ODEs via a nested contour integral ansatz. In Section 3, we provide a general scheme to go from such nested contour integral formulas to two types of Fredholm determinants and in Section 3.3 we apply this to  $q$ -TASEP in order to prove Theorem 1.1. In Section 4, we prove duality and nested contour integral formulas for ASEP. In Section 5, we explain the passage from Theorems 1.2–1.3. Appendix A deals with a degeneration of  $q$ -TASEP to a semidiscrete directed polymer. Appendix B collects necessary combinatorial facts. Appendix C proves a uniqueness result for the system of ODEs associated with ASEP duality. Appendix D provides critical point analysis of the Fredholm determinant in Theorem 1.3, as necessary to obtain (1).

**1.2. Notations.** We fix a few notations used throughout this paper. The imaginary unit  $\iota = \sqrt{-1}$ . The indicator function of an event  $E$  is denoted by either  $\delta_E$  or  $\mathbf{1}_E$ . We write  $a_x \equiv 1$  if  $a_x = 1$  for all  $x$ . All contours we consider are simple, smooth, closed and counterclockwise oriented (unless otherwise specified). For a contour  $C$ , we write  $\alpha C$  as the dilation of  $C$  by a factor of  $\alpha > 0$ . When we write that the integration contour for  $z_A$  contains  $\{qz_B\}_{B>A}$ , we mean that the contour contains the image of the  $z_B$  contour dilated by  $q$ . Containment is strict so that if  $C$  contains a point  $\alpha$ , then  $C$  separates  $\alpha$  from infinity and the distance from  $C$  to  $\alpha$  is strictly positive.

**2. Duality and the nested contour integral ansatz for  $q$ -TASEP.** The  $q$ -deformed totally asymmetric simple exclusion process ( $q$ -TASEP) is a continuous time, discrete space interacting particle system  $\vec{x}(t)$ . Particles occupy sites of  $\mathbb{Z}$  and the location of particle  $i$  at time  $t$  is written as  $x_i(t)$  and particles are ordered so that  $x_i(t) > x_j(t)$  for  $i < j$ . The rate at which the value of  $x_i(t)$  increase by one



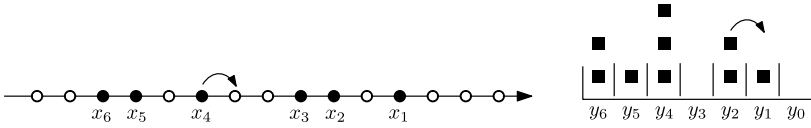

FIG. 1. Left:  $q$ -TASEP with six particles. The indicated jump of  $x_4$  occurs at rate  $a_4(1 - q^2)$  since the gap  $x_3 - x_4 - 1 = 2$ . Right: The dual TAZRP with sites  $\{0, 1, \dots, 6\}$ . The indicated jump occurs at rate  $a_2(1 - q^2)$  since  $y_2 = 2$ .

(i.e., the particle jumps right by one) is  $a_i(1 - q^{x_{i-1}(t) - x_i(t) - 1})$ ; all jumps occur independently of each other according to exponential clocks. Here,  $q \in [0, 1)$ ,  $a_i > 0$  is particle  $i$ 's jump rate parameter,  $x_{i-1}(t) - x_i(t) - 1$  is the number of empty sites to its right (before particle  $x_{i-1}$ ) and all jumps occur independently of each other (see left-hand side of Figure 1). We will use  $\mathbb{E}^x$  and  $\mathbb{P}^x$  to denote expectation and probability (resp.) of the Markov dynamics with initial data  $x$ . When the initial data is itself random, we write  $\mathbb{E}$  and  $\mathbb{P}$  to denote expectation and probability (resp.) of the Markov dynamics as well as the initial data. We also use  $\mathbb{E}$  and  $\mathbb{P}$  when the initial data is otherwise specified.

We presently focus on  $q$ -TASEP with  $N$  particles  $x_1 > x_2 > \dots > x_N$ . However, to ease the statement of results we include a virtual particle  $x_0(t) \equiv \infty$  and define our state space as

$$X^N = \{\vec{x} = (x_0, x_1, \dots, x_N) \in \{\infty\} \times \mathbb{Z}^N : \infty = x_0 > x_1 > \dots > x_N\}.$$

In this case, the dynamics are easily seen to be well defined. Observe that the evolution of the right-most  $M \leq N$  particles performs  $q$ -TASEP with  $M$  particles (i.e., particles are unaffected by those to their left). On account of this, it is easy to extend the dynamics to an infinite number of particles labeled  $x_1 > x_2 > \dots$  (i.e., there is a right-most particle). When studying these infinite systems, it is generally enough to study related finite systems.

For  $q$ -TASEP with  $N$  particles, the generator of  $\vec{x}(t)$  acts on functions  $f : X^N \rightarrow \mathbb{R}$  and is given by

$$(2) \quad (L^{q\text{-TASEP}} f)(\vec{x}) = \sum_{i=1}^N a_i(1 - q^{x_{i-1} - x_i - 1})(f(\vec{x}_i^+) - f(\vec{x})),$$

where  $\vec{x}_i^+$  indicates to increase the value of  $x_i$  by one. Note that one may also write down a generator in terms of occupation variables and (as in [9]) show that for any initial data  $q$ -TASEP is, in fact, well defined.

The totally asymmetric zero range process (TAZRP) on an interval  $\{0, 1, \dots, N\}$  with site-dependent rate functions  $g_i : \mathbb{Z}_{\geq 0} \rightarrow [0, \infty)$  [with  $g_i(0) \equiv 0$  fixed] is a Markov process  $\vec{y}(t)$  with state space

$$Y^N = (\mathbb{Z}_{\geq 0})^{\{0, 1, \dots, N\}}.$$

The dynamics of TAZRP are given as follows: for each  $i \in \{1, \dots, N\}$ ,  $y_i(t)$  decreases by one and  $y_{i-1}(t)$  increase by one (simultaneously) in continuous time at rate given by  $g_i(y_i(t))$ ; for different  $i$ 's these changes occur independently (see

right-hand side of Figure 1). Note that no particles leave site 0. The rate functions we consider are given by  $g_i(k) = a_i(1 - q^k)$ . When all  $a_i \equiv 1$ , this model was first introduced in [33] and further studied in [30].

The generator of  $\vec{y}(t)$  acts on functions  $h : Y^N \rightarrow \mathbb{R}$  and is given by

$$(3) \quad (L^{q\text{-TAZRP}}h)(\vec{y}) = \sum_{i=1}^N a_i(1 - q^{y_i})(h(\vec{y}^{i,i-1}) - h(\vec{y})),$$

where  $\vec{y}^{i,i-1}$  indicates to decrease  $y_i$  by one and increase  $y_{i-1}$  by one.

Observe that the gaps  $\tilde{y}_i(t) = x_i(t) - x_{i+1}(t) - 1$  of  $q$ -TASEP evolve according to a TAZRP, but with boundary conditions that  $\tilde{y}_0(t) \equiv \tilde{y}_N(t) \equiv \infty$  for all  $t \in \mathbb{R}_+$ . Our work will not draw on this obvious coupling. Rather, our statement of duality will provide a different relationship between  $\vec{x}(t)$  and an independent  $\vec{y}(t)$ .

2.1. *Duality.* Recall the general definition of duality given in Definition 3.1 of [24].

DEFINITION 2.1. Suppose  $x(t)$  and  $y(t)$  are independent Markov processes with state spaces  $X$  and  $Y$ , respectively, and let  $H(x, y)$  be a bounded measurable function on  $X \times Y$ . The processes  $x(t)$  and  $y(t)$  are said to be *dual* to one another with respect to  $H$  if

$$(4) \quad \mathbb{E}^x[H(x(t), y)] = \mathbb{E}^y[H(x, y(t))]$$

for all  $x \in X$  and  $y \in Y$ . Here  $\mathbb{E}^x$  refers to the process  $x(t)$  started with  $x(0) = x$  (likewise for  $y$ ).

THEOREM 2.2. The  $q$ -TASEP  $\vec{x}(t)$  with state space  $X^N$  and particle jump rate parameters  $a_i > 0$ , and the TAZRP  $\vec{y}(t)$  with state space  $Y^N$  and rate functions  $g_i(k) = a_i(1 - q^k)$  are dual with respect to

$$H(\vec{x}, \vec{y}) = \prod_{i=0}^N q^{(x_i+i)y_i}.$$

REMARK 2.3. The definition of  $H(\vec{x}, \vec{y})$  means that  $H = 0$  if  $y_0 > 0$  and  $H(\vec{x}, \vec{y}) = \prod_{i=1}^N q^{(x_i+i)y_i}$  if  $y_0 = 0$ .

Before proving Theorem 2.2, we define the following system of ODEs.

DEFINITION 2.4. We say that  $h(t; \vec{y}) : \mathbb{R}_+ \times Y^N \rightarrow \mathbb{R}$  solves the *true evolution equation* with initial data  $h_0(\vec{y})$  if:

(1) For all  $\vec{y} \in Y^N$  and  $t \in \mathbb{R}_+$ ,

$$\frac{d}{dt}h(t; \vec{y}) = L^{q\text{-TAZRP}}h(t; \vec{y});$$

- (2) For all  $\vec{y} \in Y^N$  such that  $y_0 > 0$ ,  $h(t; \vec{y}) \equiv 0$  for all  $t \in \mathbb{R}_+$ ;
- (3) For all  $\vec{y} \in Y^N$ ,  $h(0; \vec{y}) = h_0(\vec{y})$ .

REMARK 2.5. The existence and uniqueness of global solutions to the true evolution equation in Definition 2.4 is assured since it reduces to a finite system of linear ODEs, from which the result follows from standard methods [13].

PROOF OF THEOREM 2.2. We claim first that for  $\vec{x}$  and  $\vec{y}$  fixed,

$$(5) \quad L^{q\text{-TASEP}} H(\vec{x}, \vec{y}) = L^{q\text{-TAZRP}} H(\vec{x}, \vec{y}),$$

where in the above expression, the generator on the left acts in the  $x$  variables and the generator on the right in the  $y$  variables.

To prove the claim is easy. Observe that

$$\begin{aligned} L^{q\text{-TASEP}} H(\vec{x}, \vec{y}) &= \sum_{i=1}^N a_i (1 - q^{x_{i-1} - x_i - 1}) \left( (q^{y_i} - 1) \prod_{j=0}^N q^{(x_j + j)y_j} \right) \\ &= \sum_{i=1}^N a_i (1 - q^{y_i}) (H(\vec{x}, \vec{y}^{i,i-1}) - H(\vec{x}, \vec{y})) \\ &= L^{q\text{-TAZRP}} H(\vec{x}, \vec{y}). \end{aligned}$$

Given the claim we may now check that  $\mathbb{E}^{\vec{x}}[H(\vec{x}(t), \vec{y})]$  and  $\mathbb{E}^{\vec{y}}[H(\vec{x}, \vec{y}(t))]$  both satisfy the true evolution equation given in Definition 2.4. By the uniqueness of Remark 2.5, this implies the desired equality to complete our proof. That  $\mathbb{E}^{\vec{y}}[H(\vec{x}, \vec{y}(t))]$  satisfies this evolution equation follows from the definition of the generator of  $\vec{y}(t)$ .

On the other hand,

$$\begin{aligned} \frac{d}{dt} \mathbb{E}^{\vec{x}}[H(\vec{x}(t), \vec{y})] &= L^{q\text{-TASEP}} \mathbb{E}^{\vec{x}}[H(\vec{x}(t), \vec{y})] \\ &= \mathbb{E}^{\vec{x}}[L^{q\text{-TASEP}} H(\vec{x}(t), \vec{y})] \\ &= \mathbb{E}^{\vec{x}}[L^{q\text{-TAZRP}} H(\vec{x}(t), \vec{y})] \\ &= L^{q\text{-TAZRP}} \mathbb{E}^{\vec{x}}[H(\vec{x}(t), \vec{y})]. \end{aligned}$$

The equality of the first line is from the definition of the generator of  $\vec{x}(t)$ ; the equality between the first and second lines is from the commutativity of the generator with the Markov semigroup; the equality between the second and third lines is from applying equality (5) to the expression inside the expectation; the final equality is from the fact that the generator  $L^{q\text{-TAZRP}}$  now acts on the  $\vec{y}$  coordinate and the expectation acts on the  $\vec{x}$  coordinate. This shows that  $\mathbb{E}^{\vec{x}}[H(\vec{x}(t), \vec{y})]$  solves the system of ODEs in the true evolution equation (checking the boundary condition and initial data is easy).  $\square$

2.2. *Systems of ODEs.* As a result of duality, we provide three different systems of ODEs to characterize  $\mathbb{E}^{\vec{x}}[H(\vec{x}(t), \vec{y})]$ . It is convenient to introduce an alternative way to write a TAZRP state  $\vec{y} \in Y^N$ . For a state with  $k$  particles, we may instead list the ordered particle locations  $\vec{n}$  as below.

DEFINITION 2.6. For  $k \geq 1$ , define

$$W_{>0}^k = \{\vec{n} = (n_1, n_2, \dots, n_k) \in (\mathbb{Z}_{>0})^k : N \geq n_1 \geq n_2 \geq \dots \geq n_k \geq 0\}.$$

For  $\vec{y} \in Y^N$  with  $\sum_{i=0}^N y_i = k$ , we may associate a vector  $\vec{n} = \vec{n}(y) \in W_{>0}^k$  which records the ordered locations of particles in  $\vec{y}$ . That is to say, for  $i \in \{0, \dots, N\}$ , the vector  $\vec{n}(y)$  is specified by  $|\{n_j : n_j = i\}| = y_i$ . Likewise, to a vector  $\vec{n} \in W_{>0}^k$  we may associate  $\vec{y} = \vec{y}(\vec{n}) \in Y^N$  by the same relationship  $y_i = |\{n_j : n_j = i\}|$ . For instance, if  $N = 3$ ,  $y_1 = 2$ ,  $y_2 = 0$  and  $y_3 = 1$  then  $k = 3$ ,  $n_1 = 3$  and  $n_2 = n_3 = 1$ . A vector  $\vec{n}$  naturally splits into clusters, which are maximal groupings of consecutive equal valued elements. For instance, if  $\vec{n} = (4, 4, 2, 1)$ , we would say there are three clusters with the cluster of 4 containing two elements, and the clusters of 2 and 1 containing only one elements each.

Also, define the difference operator  $\nabla f(n) = f(n - 1) - f(n)$ . For a function  $f(\vec{n})$ ,  $\nabla_i$  acts as  $\nabla$  on the  $n_i$  variable. Finally, let  $\vec{n}_i^- = (n_1, \dots, n_i - 1, \dots, n_k)$ .

PROPOSITION 2.7. Let  $\vec{x} \in X^N$  and  $\vec{x}(t)$  be the  $q$ -TASEP started from  $\vec{x}(0) = \vec{x}$ .

(A) True evolution equation: If  $h(t; \vec{y}) : \mathbb{R}_+ \times Y^N \rightarrow \mathbb{R}$  solves the system of ODEs given in Definition 2.4 with initial data  $h_0(\vec{y}) = H(\vec{x}, \vec{y})$ , then for all  $\vec{y} \in Y^N$ ,  $\mathbb{E}^{\vec{x}}[H(\vec{x}(t), \vec{y})] = h(t; \vec{y})$ .

(B) Free evolution equation with  $k - 1$  boundary conditions: If  $u : \mathbb{R}_+ \times (\mathbb{Z}_{\geq 0})^k \rightarrow \mathbb{R}$  solves:

(1) For all  $\vec{n} \in (\mathbb{Z}_{\geq 0})^k$  and  $t \in \mathbb{R}_+$ ,

$$\frac{d}{dt}u(t; \vec{n}) = (1 - q) \sum_{i=1}^k a_{n_i} \nabla_i u(t; \vec{n});$$

(2) For all  $\vec{n} \in (\mathbb{Z}_{\geq 0})^k$  such that for some  $i \in \{1, \dots, k - 1\}$ ,  $n_i = n_{i+1}$ ,

$$\nabla_i u(t; \vec{n}) = q \nabla_{i+1} u(t; \vec{n});$$

(3) For all  $\vec{n} \in (\mathbb{Z}_{>0})^k$  such that  $n_k = 0$ ,  $u(t; \vec{n}) \equiv 0$  for all  $t \in \mathbb{R}_+$ ;

(4) For all  $\vec{n} \in W_{>0}^k$ ,  $u(0; \vec{n}) = H(\vec{x}, \vec{y}(\vec{n}))$ .

Then for all  $\vec{y} \in Y^N$  such that  $k = \sum_{i=1}^N y_i$ ,  $\mathbb{E}^{\vec{x}}[H(\vec{x}(t), \vec{y})] = u(t; \vec{n}(\vec{y}))$ .

(C) Schrödinger equation with Bosonic Hamiltonian: If  $v : \mathbb{R}_+ \times (\mathbb{Z}_{\geq 0})^k \rightarrow \mathbb{R}$  solves:

(1) For all  $\vec{n} \in (\mathbb{Z}_{\geq 0})^k$  and  $t \in \mathbb{R}_+$ ,

$$\frac{d}{dt}v(t; \vec{n}) = \mathcal{H}v(t; \vec{n}),$$

$$\mathcal{H} = (1 - q) \left[ \sum_{i=1}^k a_{n_i} \nabla_i + (1 - q^{-1}) \sum_{i < j}^k \delta_{n_i = n_j} q^{j-i} a_{n_i} \nabla_i \right];$$

(2) For all permutations of indices  $\sigma \in S_k$ ,  $v(t; \sigma \vec{n}) = v(t; \vec{n})$ ;

(3) For all  $\vec{n} \in (\mathbb{Z}_{\geq 0})^k$  such that  $n_k = 0$ ,  $v(t; \vec{n}) \equiv 0$  for all  $t \in \mathbb{R}_+$ ;

(4) For all  $\vec{n} \in W_{>0}^k$ ,  $v(0; \vec{n}) = H(\vec{x}, \vec{y}(\vec{n}))$ .

Then for all  $\vec{y} \in Y^N$  such that  $k = \sum_{i=1}^N y_i$ ,  $\mathbb{E}^{\vec{x}}[H(\vec{x}(t), \vec{y})] = v(t; \vec{n}(\vec{y}))$ .

REMARK 2.8. The existence and uniqueness of global solutions to (A) is explained in Remark 2.5. This then implies the existence of solutions in (C). It is not clear, a priori, that there exist solutions to (B). As we see in the proof of (B), the combination of the four conditions in (B) implies that restricted to  $\vec{n} \in W_{>0}^k$ ,  $u(t; \vec{n}) = h(t; \vec{y}(\vec{n}))$  for all  $t \in \mathbb{R}_+$ . However, it is not clear that there exists a suitable extension of  $u$  outside the physical region  $W_{>0}^k$  which satisfies the four conditions. Note that (B) should be considered as an advanced version of the method of images. Finally, though the above results are written for deterministic  $\vec{x}$  (i.e., deterministic initial data) by linearity one can average over random  $\vec{x}$  and achieve the same stated results with  $\mathbb{E}^{\vec{x}}[H(\vec{x}(t), \vec{y})]$  replaced by its average over  $\vec{x}$ , written as  $\mathbb{E}[H(\vec{x}(t), \vec{y})]$ , and the initial data for the ODEs likewise replaced by  $\mathbb{E}[H(\vec{x}, \vec{y})]$ .

PROOF OF PROPOSITION 2.7. Call the three conditions contained in Definition 2.4 (A.1), (A.2) and (A.3). Part (A) follows from Theorem 2.2 since it implies that

$$\frac{d}{dt} \mathbb{E}^{\vec{x}}[H(\vec{x}(t), \vec{y})] = L^{q\text{-TAZRP}} \mathbb{E}^{\vec{x}}[H(\vec{x}(t), \vec{y})],$$

which matches (A.1). Along with this, the value of  $\mathbb{E}^{\vec{x}}[H(\vec{x}(t), \vec{y})]$  is uniquely characterized by the initial data and the fact that (due to the definition of  $H$ )  $\mathbb{E}^{\vec{x}}[H(\vec{x}(t), \vec{y})] = 0$  for all  $\vec{y} \in Y^N$  with  $y_0 > 0$ . Conditions (A.3) and (A.2), respectively, match these properties, and hence (A) follows.

Part (B) follows by showing that if the four conditions for  $u$  given in (B) hold, then it implies that  $u(t; \vec{n}(\vec{y}))$  satisfies part (A), and hence that  $u(t; \vec{n}(\vec{y})) = h(t; \vec{y})$ . Thus, we must show that (B) implies (A). Going between  $\vec{y}$  and  $\vec{n}$  notation, the initial data (A.3) and (B.4) match, as do the conditions (A.2) and (B.3). To check the system of ODEs (A.1), recall that the size of the cluster of elements of  $\vec{n}$  equal to  $i$  equals  $y_i$ . Consider the cluster of elements equal to  $N : n_1 = n_2 = \dots = n_{y_N}$  (every other cluster works similarly). In order to prove (A.1), it suffices to show that

$$(6) \quad (1 - q) \sum_{i=1}^{y_N} a_N \nabla_i u(t; \vec{n}) = a_N (1 - q^{y_N}) \nabla_{y_N} u(t; \vec{n}).$$

This is because  $\nabla_{y_N} u(t; \vec{n}) = u(t; \vec{n}(y^{N, N-1})) - u(t; \vec{n}(y))$ . Summing these terms over all clusters yields  $L^{q\text{-TAZRP}} u(t; \vec{n}(\vec{y}))$ , and hence (A.1) follows. But (B.2) implies  $\nabla_i u(t; \vec{n}) = q^{y_N-i} \nabla_{y_N} u(t; \vec{n})$  for  $i = 1, \dots, y_N$ , which implies (6).

Part (C) also follows by showing that the combination of the four conditions for  $v$  imply that  $v(t; \vec{n}(\vec{y}))$  satisfies (A), and hence  $v(t; \vec{n}(\vec{y})) = h(t; \vec{y})$ . As in (B), the initial data (A.3) and (C.4) match, as do the conditions (A.2) and (C.3). Also as in (B), it suffices to consider the cluster of  $N$ . The portion of the Hamiltonian  $H$  corresponding to this cluster is

$$(1 - q) \left[ \sum_{i=1}^{y_N} a_N \nabla_i + (1 - q^{-1}) \sum_{i < j}^{y_N} q^{j-i} a_N \nabla_i \right] = (1 - q) a_N \sum_{i=1}^{y_N} q^{y_N-i} \nabla_i,$$

where the equality follows from summing the factors involving each  $\nabla_i$ . Due to the symmetry (C.2),  $\nabla_i v(t; \vec{n}) = \nabla_{y_N} v(t; \vec{n})$  for all  $i \in \{1, \dots, y_N\}$ . Hence, the sum in  $i$  can be performed, yielding  $a_N(1 - q^{y_N}) \nabla_{y_N}$ . This is the same as in (6), and hence (C) follows as well.  $\square$

2.3. *Nested contour ansatz solution.* It is not a priori clear how one might explicitly solve the systems of ODEs in Proposition 2.7. Presently, we show how this can be done for two distinguished types of initial data.

DEFINITION 2.9. For  $q$ -TASEP, *step* initial data corresponds with  $x_i(0) = -i$  for  $i \geq 1$ .

For  $\alpha \in [0, 1)$ , we say a random variable  $X$  is  $q$ -Geometric distributed with parameter  $\alpha$  [written  $X \sim q \text{ Geo}(\alpha)$ ] if

$$\mathbb{P}(X = k) = (\alpha; q)_\infty \frac{\alpha^k}{(q; q)_k},$$

where  $(a; q)_n = (1 - a)(1 - aq)(1 - aq^2) \cdots (1 - aq^{n-1})$  and  $(a; q)_\infty = (1 - a)(1 - aq)(1 - aq^2) \cdots$ . *Half stationary* initial data for  $q$ -TASEP corresponds with random initial locations for particles  $x_i$  for  $i \geq 1$  given as follows: let  $X_i \sim q \text{ Geo}(\alpha/a_i)$  for  $i \geq 1$  be independent; then set  $x_1(0) = -1 - X_1$  and, for  $i > 1$ ,  $x_i = x_{i-1} - 1 - X_i$ . The result is that the gaps between consecutive particles  $i$  and  $i + 1$  are distributed as  $q$ -Geometric with parameter  $\alpha/a_i$  and are independent. When  $\alpha = 0$ , the step initial data is recovered (regardless of the  $a_i$ ).

REMARK 2.10. When  $a_i \equiv 1$ , the translation invariant measure on particle configurations in  $\mathbb{Z}$  with independent  $q \text{ Geo}(\alpha)$  distributed distances between neighbors is an invariant or stationary measure<sup>5</sup> for  $q$ -TASEP, cf. [9]. This explains the usage of the term half stationary (and likewise for ASEP).

---

<sup>5</sup>Within the probability literature, the term equilibrium is sometimes also used to describe such a measure, though to avoid confusion with the physical means of equilibrium statistical mechanics, we avoid this term.

**THEOREM 2.11.** Fix  $q \in (0, 1)$ ,  $a_i > 0$  for  $i \geq 1$  and let  $\vec{n} = (n_1, \dots, n_k)$ . The system of ODEs given in Proposition 2.7(B) is solved by the following formulas:

(1) For step initial data,

$$(7) \quad u(t; \vec{n}) = \frac{(-1)^k q^{k(k-1)/2}}{(2\pi t)^k} \times \int \cdots \int \prod_{1 \leq A < B \leq k} \frac{z_A - z_B}{z_A - qz_B} \prod_{j=1}^k \left( \prod_{m=1}^{n_j} \frac{a_m}{a_m - z_j} \right) e^{(q-1)tz_j} \frac{dz_j}{z_j},$$

where the integration contour for  $z_A$  contains  $\{qz_B\}_{B>A}$  and all  $a_m$ 's but not 0.

(2) For half stationary initial data with parameter  $\alpha > 0$  [such that  $\alpha q^{-k} < a_m$  for all  $1 \leq m \leq \max_i(n_i)$ ],

$$(8) \quad u(t; \vec{n}) = \frac{(-1)^k q^{k(k-1)/2}}{(2\pi t)^k} \times \int \cdots \int \prod_{1 \leq A < B \leq k} \frac{z_A - z_B}{z_A - qz_B} \times \prod_{j=1}^k \left( \prod_{m=1}^{n_j} \frac{a_m}{a_m - z_j} \right) e^{(q-1)tz_j} \frac{dz_j}{z_j - \alpha/q},$$

where the integration contour for  $z_A$  contains  $\{qz_B\}_{B>A}$  and all  $a_m$ 's but not  $\alpha/q$ .

On account of Proposition 2.7 and the uniqueness of solutions restricted to  $\vec{n} \in W_{>0}^k$  (see Remark 2.8), the above formulas when restricted to  $\vec{n} \in W_{>0}^k$  immediately yield the following (we will only state it for step initial data, though a similar statement holds for half stationary).

**COROLLARY 2.12.** For  $q$ -TASEP with step initial data and  $\vec{n} \in W_{>0}^k$ ,

$$(9) \quad \mathbb{E} \left[ \prod_{j=1}^k q^{x_{n_j} + n_j} \right] = \frac{(-1)^k q^{k(k-1)/2}}{(2\pi t)^k} \times \int \cdots \int \prod_{1 \leq A < B \leq k} \frac{z_A - z_B}{z_A - qz_B} \prod_{j=1}^k \left( \prod_{m=1}^{n_j} \frac{a_m}{a_m - z_j} \right) e^{(q-1)tz_j} \frac{dz_j}{z_j},$$

where the integration contour for  $z_A$  contains  $\{qz_B\}_{B>A}$  and all  $a_m$ 's but not 0.

**PROOF OF THEOREM 2.11.** We need to prove that  $u(t; \vec{n})$  as defined in (7) satisfies the four conditions of Proposition 2.7(B).

Condition (B.1) is satisfied by linearity and the fact that

$$\left[ \frac{d}{dt} - (1 - q)a_{n_i} \nabla_i \right] \left( \left( \prod_{m=1}^{n_i} \frac{a_m}{a_m - z} \right) e^{(q-1)tz} \right) = 0.$$

Condition (B.2) relies on the Vandermonde-like factors as well as the nested choice of contours. Without loss of generality, assume that  $n_1 = n_2$ . We wish to show that

$$(10) \quad [\nabla_1 - q\nabla_2]u(t; \vec{n}) = 0.$$

Applying  $\nabla_1 - q\nabla_2$  to the integrand in (7) brings down a factor of  $-a_{n_1}^{-1}(z_1 - qz_2)$ . We must show that the integral of this new integrand is zero. This new factor cancels the denominator  $(z_1 - qz_2)$  in

$$(11) \quad \prod_{1 \leq A < B \leq k} \frac{z_A - z_B}{z_A - qz_B}.$$

On account of this, we may deform the contours for  $z_1$  and  $z_2$  to be the same without encountering any poles. The term  $z_1 - z_2$  in the numerator of (11) remains, and hence we can write

$$u(t; \vec{n}) = \iint (z_1 - z_2)G(z_1)G(z_2) dz_1 dz_2,$$

where  $G(z)$  involves the integrals in  $z_3, \dots, z_k$ . Since the two contours are identical, this integral is clearly zero, proving (B.2).

Condition (B.3) follows from simple residue calculus. When  $n_k = 0$ , there are no poles in the  $z_k$  integral at  $\{a_m\}_{m=1}^{n_k}$ . Therefore, by Cauchy’s theorem the integral is zero.

Condition (B.4) likewise follows from residue calculus. Let us first consider the step initial data case of Theorem 2.11. This corresponds to initial data in (B.4) given by

$$u(0; \vec{n}) = H(x; \vec{y}(\vec{n})) = 1$$

for all  $\vec{n} \in W_{>0}^k$ . Now consider (7) with  $t = 0$ . The  $z_1$  contour can be expanded to infinity. The only pole encountered is at  $z_1 = 0$  [ $z_1 = \infty$  is not a pole because of the decay coming from  $a_m/(a_m - z_j)$ ]. Because we pass it from the outside, the contribution of the residue is  $-q^{-(k-1)}$  times the same integral but with every term involving  $z_1$  removed. Repeating this procedure for  $z_2$  leads to  $-q^{-(k-2)}$  and so on. Therefore, the integral can be evaluated and canceling terms we are left with it equal to 1 exactly as desired.

Now consider the half stationary initial data case of Theorem 2.11. (B.1)–(B.3) follow in the same way as for the step initial data. We claim that this corresponds to initial data in (B.4) given by

$$(12) \quad u(0; \vec{n}) = \mathbb{E}[H(\vec{x}; \vec{y}(\vec{n}))] = \prod_{i=1}^k \prod_{m=n_{i+1}+1}^{n_i} \prod_{j=1}^i \frac{a_m}{a_m - \alpha/q^j}.$$

Showing this requires a calculation.



LEMMA 2.13. *Fix  $r \geq 1$ . If  $X$  is a  $q$ -Geometric random variable with parameter  $\alpha \in [0, 1)$  then*

$$\mathbb{E}[q^{-rX}] = \prod_{i=1}^r \frac{1}{1 - \alpha/q^i},$$

so long as  $\alpha q^{-r} < 1$ ; and otherwise the expectation is infinite.

PROOF. Using the  $q$ -Binomial theorem (see Section B.1), we may calculate

$$\mathbb{E}[q^{-rX}] = (\alpha; q)_\infty \sum_{k=0}^\infty \frac{(\alpha/q^r)^k}{(q; q)_k} = \frac{(\alpha; q)_\infty}{(\alpha/q^r; q)_\infty},$$

which after canceling terms is exactly as desired.  $\square$

Recall that under half stationary initial data, the locations  $\{x_i(0)\}$  are defined in terms of  $q$ -Geometric random variables  $\{X_j\}$ . Using this, we have

$$\prod_{i=1}^k q^{x_{n_i}(0)+n_i} = \prod_{i=1}^k q^{-\sum_{m=1}^{n_i} X_m} = \prod_{i=1}^k \prod_{m=n_{i+1}+1}^{n_i} q^{-iX_m}.$$

Since the  $X$ 's are independent, we can evaluate individually the expectation of  $q^{-iX_m}$  using the above lemma, and we immediately find the right-hand side of (12).

Now consider (8) with  $t = 0$ . As in the step initial data case, we successively peel off the contours and evaluate the effect via residue calculus. When we expand  $z_1$  to infinity, we now only encounter a pole at  $z_1 = \alpha/q$  (which becomes zero when  $\alpha = 0$  recovering the step initial data). Evaluating this residue, we find

$$\begin{aligned} u(0; \vec{n}) &= \prod_{m=1}^{n_1} \frac{a_m}{a_m - \alpha/q} \frac{(-1)^{k-1} q^{((k-1)(k-2))/2}}{(2\pi i)^{k-1}} \\ &\times \int \cdots \int \prod_{2 \leq A < B \leq k} \frac{z_A - z_B}{z_A - qz_B} \prod_{j=2}^k \left( \prod_{m=1}^{n_j} \frac{a_m}{a_m - z_j} \right) \frac{dz_j}{z_j - \alpha/q^2}. \end{aligned}$$

Expanding  $z_2$  the pole is now at  $z_2 = \alpha/q^2$  and a similar formula results from evaluating the residue. Repeating this procedure shows that  $u(0; \vec{n})$  is given by the right-hand side of (12) as desired.  $\square$

**3. A general scheme from nested contour integrals to Fredholm determinants.** The output of Theorem 2.11 and Corollary 2.12 is that for step and half stationary initial data we have relatively simple formulas for a large class of expectations. In principle, these expectations should characterize the joint distribution of the locations of any fixed collection of particles  $x_{n_1}(t), \dots, x_{n_\ell}(t)$  in  $q$ -TASEP.

One may hope to achieve this via certain generating functions. However, the challenge is to find expressions for these generating functions which have clear asymptotic limits (in time and particle labels). For this, we focus here only on the distribution of a single particle  $x_n(t)$ . Applying Corollary 2.12 with  $n_i \equiv n$  yields a nested contour integral formula for  $\mathbb{E}[q^{kx_n(t)}]$ .

There are two ways to deform this type of nested contour integrals so that all contours coincide. After accounting for the residues encountered during these deformations, we are led to two types of formulas for expectations: those involving partition-indexed sums of contour integrals and those involving single row-indexed sums of contour integrals. By taking suitable generating functions of these indexed sums of contour integrals, we are led to two types of Fredholm determinants. All of these manipulations are quite general and can be done purely formally. Given some analytic estimates, these manipulations turn into numerical equalities as is the case for  $q$ -TASEP.

We record these manipulations (and conditions for them to hold as numerical equalities) as well as their consequences without proofs, since they can be found in Section 3.2 of [9]. We do this for completeness and also because when we turn to consider ASEP, the same manipulations will be used. When we apply this to  $q$ -TASEP, we will only consider step initial data. If we consider half stationary for any  $\alpha > 0$  fixed, then when  $k$  gets so large that  $\alpha > q^k$ , the expectation  $\mathbb{E}[q^{kx_n(t)}]$  is infinite. Thus, when forming a generating function from these  $q$ -moments, we are forced to take  $\alpha = 0$ , which corresponds to the step initial data.

Before going into these manipulations, the reader may want to quickly browse Section B.1 where we record some useful  $q$ -deformations as well as briefly review Fredholm determinants.

3.1. *Mellin–Barnes type determinants.* The below proposition describes the result of deforming the contours of a general nested contour integral formula in such a way that all of the poles corresponding to  $z_A = qz_B$  for  $A < B$  are encountered. The residues associated with these poles group into clusters, and hence the resulting formula is naturally indexed by partitions  $\lambda = (\lambda_1 \geq \lambda_2 \geq \dots \geq 0)$ . Notationally, we write  $\lambda \vdash k$  if  $\sum_i \lambda_i = k$ ,  $\lambda = 1^{m_1}2^{m_2} \dots$  if  $i$  appears  $m_i$  times in  $\lambda$  (for all  $i \geq 1$ ), and  $\ell(\lambda) = \sum_i m_i$  for the number of nonzero elements of  $\lambda$ .

DEFINITION 3.1. For a meromorphic function  $f(z)$  and  $k \geq 1$  set  $\mathbb{A}$  to be a fixed set of poles of  $f$  (not including 0) and assume that  $q^m \mathbb{A}$  is disjoint from  $\mathbb{A}$  for all  $m \geq 1$ . Define

$$(13) \quad \mu_k = \frac{(-1)^k q^{k(k-1)/2}}{(2\pi i)^k} \int \dots \int \prod_{1 \leq A < B \leq k} \frac{z_A - z_B}{z_A - qz_B} \prod_{i=1}^k f(z_i) \frac{dz_i}{z_i},$$

where the integration contour for  $z_A$  contains  $\{qz_B\}_{B>A}$ , the fixed set of poles  $\mathbb{A}$  of  $f(z)$  but not 0 or any other poles.

PROPOSITION 3.2. We have that for  $\mu_k$  as in Definition 3.1,

$$\begin{aligned}
 \mu_k = k_q! \sum_{\substack{\lambda \vdash k \\ \lambda = 1^{m_1} 2^{m_2} \dots}} \frac{1}{m_1! m_2! \dots} \frac{(1-q)^k}{(2\pi i)^{\ell(\lambda)}} \\
 (14) \quad \times \int \dots \int \det \left[ \frac{1}{w_i q^{\lambda_i} - w_j} \right]_{i,j=1}^{\ell(\lambda)} \\
 \times \prod_{j=1}^{\ell(\lambda)} f(w_j) f(qw_j) \dots f(q^{\lambda_j-1} w_j) dw_j,
 \end{aligned}$$

where the integration contour for  $w_j$  contains the same fixed set of poles  $\mathbb{A}$  of  $f$  and no other poles.

PROOF. This is proved in [9] as Proposition 3.2.1 via residue calculus.  $\square$

As a quick example, consider  $f(z)$  which has a pole at  $z = 1$ . Then the  $z_k$ -contour is a small circle around 1, the  $z_{k-1}$ -contour goes around 1 and  $q$ , and so on until the  $z_1$ -contour encircles  $\{1, q, \dots, q^{k-1}\}$  (this is illustrated for  $k = 3$  in Figure 2). All the  $w$  contours are small circles around 1 and can be chosen to be the same.

We form a generating function of the  $\mu_k$  and identify the result as a Fredholm determinant.

PROPOSITION 3.3. Consider  $\mu_k$  as in equation (14) defined with respect to the same set of poles  $\mathbb{A}$  of  $f(w)$  for  $k = 1, 2, \dots$  and set  $C_{\mathbb{A}}$  to be a closed contour which contains  $\mathbb{A}$  and no other poles of  $f(w)/w$ . Then the following formal equality holds:

$$\sum_{k \geq 0} \mu_k \frac{\zeta^k}{k_q!} = \det(I + K_{\zeta}^1),$$

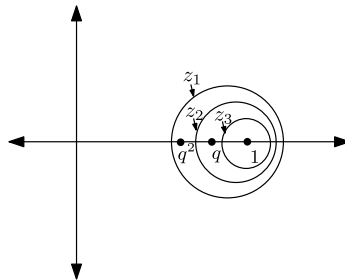

FIG. 2. Possible contours when  $k = 3$  for the  $z_j$  contour integrals in Proposition 3.2.

where  $\det(I + K_\zeta^1)$  is the formal Fredholm determinant expansion of  $K_\zeta^1 : L^2(\mathbb{Z}_{>0} \times C_\mathbb{A}) \rightarrow L^2(\mathbb{Z}_{>0} \times C_\mathbb{A})$  defined in terms of its integral kernel

$$K_\zeta^1(n_1, w_1; n_2; w_2) = \frac{(1 - q)^{n_1} \zeta^{n_1} f(w_1) f(qw_1) \cdots f(q^{n_1-1} w_1)}{q^{n_1} w_1 - w_2}.$$

The above identity is formal, but also holds numerically if the following is true: for all  $w, w' \in C_\mathbb{A}$  and  $n \geq 1$ ,  $|q^n w - w'|^{-1}$  is uniformly bounded from zero; and there exists a positive constant  $M$  such that for all  $w \in C_\mathbb{A}$  and all  $n \geq 0$ ,  $|f(q^n w)| \leq M$  and  $|(1 - q)\zeta| < M^{-1}$ .

PROOF. This is proved in [9], Proposition 3.2.8. The proof amounts to reordering the sums defining  $\mu_k$  and recognizing a Fredholm determinant.  $\square$

We may replace the space  $L^2(\mathbb{Z}_{>0} \times C_\mathbb{A})$  by  $L^2(C_\mathbb{A})$  via the following Mellin–Barnes representation.

LEMMA 3.4. For all functions  $f$  which satisfy the conditions below, we have the identity that for  $\zeta \in \{\zeta : |\zeta| < 1, \zeta \notin \mathbb{R}_+\}$ :

$$(15) \quad \sum_{n=1}^\infty f(q^n) \zeta^n = \frac{1}{2\pi i} \int_{C_{1,2,\dots}} \Gamma(-s) \Gamma(1 + s) (-\zeta)^s f(q^s) ds,$$

where the infinite contour  $C_{1,2,\dots}$  is a negatively oriented contour which encloses  $1, 2, \dots$  and no poles of  $f(q^s)$  (e.g.,  $C_{1,2,\dots} = \frac{1}{2} + i\mathbb{R}$  oriented from  $\frac{1}{2} - i\infty$  to  $\frac{1}{2} + i\infty$ ), and  $z^s$  is defined with respect to a branch cut along  $z \in \mathbb{R}^-$ . For the above equality to be valid, the left-hand side must converge, and the right-hand side integral must be able to be approximated by integrals over a sequence of finite contours  $C_k$  which enclose the poles at  $1, 2, \dots, k$  and which partly coincide with  $C_{1,2,\dots}$  in such a way that the integral along the symmetric difference of the contours  $C_{1,2,\dots}$  and  $C_k$  goes to zero as  $k$  goes to infinity.

PROOF. The identity follows from  $\text{Res}_{s=k} \Gamma(-s) \Gamma(1 + s) = (-1)^{k+1}$ .  $\square$

DEFINITION 3.5. The infinite contour  $D_{R,d}$  is defined as follows.  $D_{R,d}$  goes by straight lines from  $R - i\infty$ , to  $R - id$ , to  $1/2 - id$ , to  $1/2 + id$ , to  $R + id$ , to  $R + i\infty$ . See Figure 3 for an illustration. The finite contour  $D_{R,d;k}$  is defined as follows. Let  $p, \bar{p}$  be the points [let  $\text{Im}(p) > 0$ ] at which the circle of radius  $k + 1/2$ , centered at 0, intersects  $D_{R,d}$ . Then  $D_{R,d;k}$  is the union of the portion of  $D_{R,d}$  inside the circle with reversed orientation, with the arc from  $\bar{p}$  to  $p$  (oriented counterclockwise).

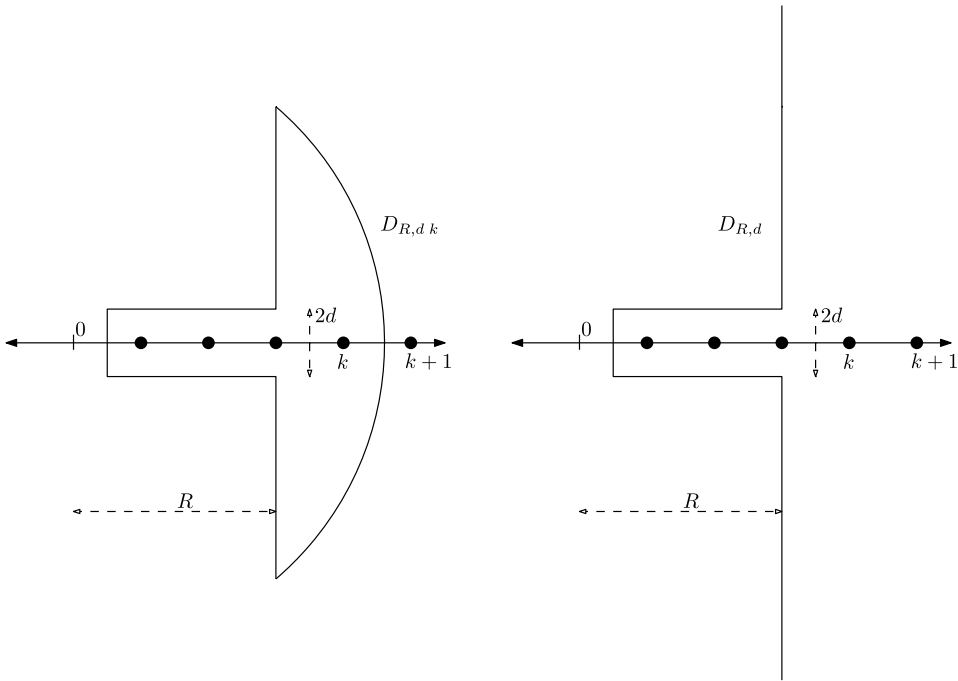

FIG. 3. Left: The contour  $D_{R,d;k}$ ; Right: The contour  $D_{R,d}$ .

PROPOSITION 3.6. Assume  $f(w) = g(w)/g(qw)$  for some function  $g$ . Then the following formal equality holds:

$$\det(I + K_\zeta^1) = \det(I + K_\zeta^2),$$

where  $\det(I + K_\zeta^1)$  is given in Proposition 3.3 and where  $\det(I + K_\zeta^2)$  is the formal Fredholm determinant expansion of  $K_\zeta^2 : L^2(C_\mathbb{A}) \rightarrow L^2(C_\mathbb{A})$ . The operator  $K_\zeta^2$  is defined in terms of its integral kernel

$$K_\zeta^2(w, w') = \frac{1}{2\pi i} \int_{C_{1,2,\dots}} \Gamma(-s)\Gamma(1+s)(-1-q)\zeta^s \frac{g(w)}{g(q^s w)} \frac{1}{q^s w - w'} ds.$$

The above identity holds numerically if  $\det(I + K_\zeta^1)$  is a convergent Fredholm expansion and if  $C_{1,2,\dots}$  is chosen as  $D_{R,d}$  with  $d > 0$  and  $R > 0$  such that

$$\inf_{\substack{w, w' \in C_\mathbb{A} \\ k \in \mathbb{Z}_{>0}, s \in D_{R,d;k}}} |q^s w - w'| > 0 \quad \text{and} \quad \sup_{\substack{w, w' \in C_\mathbb{A} \\ k \in \mathbb{Z}_{>0}, s \in D_{R,d;k}}} \left| \frac{g(w)}{g(q^s w)} \right| < \infty.$$

In that case the function  $\zeta \mapsto \det(I + K_\zeta^2)$  is analytic for all  $\zeta \notin \mathbb{R}_+$ .

PROOF. This result can readily be extracted from the proof of [9] Theorem 3.2.11. In fact, the strong analytic bounds which we require can be signif-

icantly relaxed, however, as they will be sufficient for our purposes, we do not explore this.  $\square$

We say that Fredholm determinants similar to  $\det(I + K_\zeta^2)$  are of Mellin–Barnes-type [because (15) is a basic tool for classical Mellin–Barnes integrals].

3.2. *Cauchy-type determinants.* Instead of deforming contours so as to encounter the  $z_A = qz_B$  poles, we may deform our contours to only encounter the pole at 0. The residue calculus becomes easier and the resulting sum of contour integrals is indexed by partitions with just a single row (equivalently by nonnegative integers).

DEFINITION 3.7. For a meromorphic function  $f(z)$  and  $k \geq 1$  set  $\mathbb{A}$  to be a fixed set of poles of  $f$  and assume that  $q^m \mathbb{A}$  is disjoint from  $\mathbb{A}$  for all  $m \geq 1$ . Define

$$(16) \quad \tilde{\mu}_k = \frac{(-1)^k q^{k(k-1)/2}}{(2\pi i)^k} \int \cdots \int \prod_{1 \leq A < B \leq k} \frac{z_A - z_B}{z_A - qz_B} \prod_{i=1}^k f(z_i) \frac{dz_i}{z_i},$$

where the integration contour for  $z_A$  contains  $\{qz_B\}_{B>A}$ , the fixed set of poles  $\mathbb{A}$  of  $f(z)$  and 0, but no other poles.

Notice that  $\mu_k$  and  $\tilde{\mu}_k$  differ only by the inclusion of 0 in the contour for  $\tilde{\mu}_k$ . They can be related via the following.

PROPOSITION 3.8. Assume  $f(0) = 1$ . Then

$$\tilde{\mu}_k = (-1)^k q^{k(k-1)/2} \sum_{j=0}^k \binom{k}{j}_{q^{-1}} (-1)^j q^{-j(j-1)/2} \mu_j.$$

PROOF. This is proved in [9], Proposition 3.2.5.  $\square$

If, for instance, we assume now that  $\mathbb{A}$  contains all poles of  $f$ , then we can deform the contours in (16) to all lie on a single, large circle. The following symmetrization proposition then applies.

PROPOSITION 3.9. If the contours of integration in (16) can be deformed (without passing any poles) to all coincide with a contour  $\tilde{C}_\mathbb{A}$ , then

$$(17) \quad \tilde{\mu}_k = \frac{kq! (1 - q^{-1})^k}{k! (2\pi i)^k} \int_{\tilde{C}_\mathbb{A}} \cdots \int_{\tilde{C}_\mathbb{A}} \det \left[ \frac{1}{w_i q^{-1} - w_j} \right]_{i,j=1}^k \prod_{j=1}^k f(w_j) dw_j.$$

PROOF. This is proved in [9], Proposition 3.2.2.  $\square$

PROPOSITION 3.10. *If the contours of integration in (16) can be deformed (without passing any poles) to all coincide with a contour  $\tilde{C}_{\mathbb{A}}$ , then the following formal identity holds:*

$$\sum_{k \geq 0} \tilde{\mu}_k \frac{\zeta^k}{k_q!} = \det(I + \zeta \tilde{K}^1),$$

where  $\det(I + \tilde{K}^1)$  is the formal Fredholm determinant expansion of  $\tilde{K}^1 : L^2(\tilde{C}_{\mathbb{A}}) \rightarrow L^2(\tilde{C}_{\mathbb{A}})$  defined in terms of its integral kernel

$$\tilde{K}^1(w, w') = (1 - q) \frac{f(w)}{qw' - w}.$$

The above identity is formal, but also holds numerically for  $\zeta$  such that the left-hand side converges absolutely and the right-hand side operator  $\tilde{K}^1$  is trace-class.

PROOF. This is proved in [9], Proposition 3.2.9.  $\square$

REMARK 3.11. By considering the Fredholm series expansion [whose terms are given by (17)], it is clear that since  $f$  arises multiplicatively, it can be paired either with  $w_i$  or  $w_j$  in the Cauchy determinant. As a consequence, it follows that

$$\det(I + \zeta \tilde{K}^1) = \det(I + \zeta \tilde{K}^2),$$

where  $\tilde{K}^2 : L^2(\tilde{C}_{\mathbb{A}}) \rightarrow L^2(\tilde{C}_{\mathbb{A}})$  is defined in terms of its integral kernel

$$\tilde{K}^2(w, w') = (1 - q) \frac{f(w)}{qw - w'}.$$

We call Fredholm determinants of this form *Cauchy type*.

3.3. *Application to  $q$ -TASEP.* The following theorems about  $q$ -TASEP are applications of the manipulations of the previous section. The required estimates necessary to make these numerical equalities are provided in [9].

3.3.1. *Mellin–Barnes-type Fredholm determinant for  $q$ -TASEP.*

THEOREM 3.12. *Fix  $0 < q < 1$  and  $n \geq 1$ . Fix  $0 < \delta < 1$  and  $a_1, \dots, a_n$  such that for all  $i$ ,  $a_i > 0$  and  $|a_i - 1| \leq d$  for some constant  $d < \frac{1-q^\delta}{1+q^\delta}$ . Consider  $q$ -TASEP with step initial data and jump parameters  $a_i$ . Then for all  $t \in \mathbb{R}_+$  and  $\zeta \in \mathbb{C} \setminus \mathbb{R}_+$ , the following characterizes the distribution of  $x_n(t)$ :*

$$(18) \quad \mathbb{E} \left[ \frac{1}{(\zeta q^{x_n(t)}; q)_\infty} \right] = \det(I + K_\zeta^{q\text{-TASEP}}),$$

where  $\det(I + K_\zeta^{q\text{-TASEP}})$  is the Fredholm determinant of  $K_\zeta : L^2(C_a) \rightarrow L^2(C_a)$  for  $C_a$  a positively oriented circle  $|w - 1| = d$ . The operator  $K_\zeta$  is defined in terms of its integral kernel

$$K_\zeta^{q\text{-TASEP}}(w, w') = \frac{1}{2\pi i} \int_{-\iota\infty+\delta}^{\iota\infty+\delta} \Gamma(-s)\Gamma(1+s)(-q^{-n}\zeta)^s \frac{g(w)}{g(q^s w)} \frac{1}{q^s w - w'} ds,$$

where

$$(19) \quad g(w) = \prod_{m=1}^n \frac{1}{(w/a_m; q)_\infty} e^{-tw}.$$

PROOF. This is proved in [9], Theorem 3.2.11. A similar approach is described in its entirety in the proof of Theorem 5.3, for ASEP.  $\square$

The above is an  $e_q$ -Laplace transform and can be inverted via Proposition B.1. Since  $x_n(t)$  is supported on  $\{-n, -n + 1, \dots\}$ , in order to apply Proposition B.1 it is necessary to shift everything by  $n$ . Let  $\hat{f}^q(\zeta) = \det(I + K_\zeta^{q\text{-TASEP}})$  and redefine  $C_m$  to encircle the poles  $\zeta = q^{-M}$  for  $-n \leq M \leq m - n$ . Under these modifications, Proposition B.1 gives  $\mathbb{P}(x_n(t) = m)$ .

### 3.3.2. Cauchy-type Fredholm determinant for $q$ -TASEP.

THEOREM 3.13. Fix  $0 < q < 1$ ,  $n \geq 1$  and  $a_1, \dots, a_n$  such that for all  $i$ ,  $a_i > 0$ . Consider  $q$ -TASEP with step initial data and jump parameters  $a_i > 0$  for all  $i \geq 1$ . Let  $x_n(t)$  be the location of particle  $n$  at time  $t$ . Then for all  $\zeta \in \mathbb{C} \setminus \{q^{-i}\}_{i \in \mathbb{Z}_{\geq 0}}$

$$(20) \quad \mathbb{E} \left[ \frac{1}{(\zeta q^{x_n(t)+n}; q)_\infty} \right] = \frac{\det(I + \zeta \tilde{K}^{q\text{-TASEP}})}{(\zeta; q)_\infty},$$

where  $\det(I + \zeta \tilde{K}^{q\text{-TASEP}})$  is an entire function of  $\zeta$  and is the Fredholm determinant of  $\tilde{K}^{q\text{-TASEP}} : L^2(\tilde{C}_a) \rightarrow L^2(\tilde{C}_a)$  defined in terms of its integral kernel

$$\tilde{K}^{q\text{-TASEP}}(w, w') = \frac{f(w)}{qw' - w}$$

with

$$f(w) = \left( \prod_{m=1}^n \frac{a_m}{a_m - w} \right) \exp\{(q - 1)tw\}$$

and  $\tilde{C}_a$  a star-shaped contour with respect to 0 (i.e., it strictly contains 0 and every ray from 0 crosses  $\tilde{C}_a$  exactly once) contour containing  $a_1, \dots, a_n$ .



PROOF. This is proved in [9], Theorem 3.2.16. A similar approach is described in its entirety in the proof of Theorem 5.5, for ASEP.  $\square$

The above shows that  $\det(I + \zeta \tilde{K}^{q\text{-TASEP}})/(\zeta; q)_\infty$  equals the  $e_q$ -Laplace transform of  $q^{x_n(t)+n}$ .

**4. Duality and the nested contour integral ansatz for ASEP.** The asymmetric simple exclusion process (ASEP) was introduced by Spitzer [35] in 1970 and also arose in biology in the work of MacDonald, Gibbs and Pipkin [26] in 1968. Since then, it has become a central object of study in interacting particle systems and nonequilibrium statistical mechanics.

The ASEP is a continuous time Markov process with state  $\eta(t) = \{\eta_x(t)\}_{x \in \mathbb{Z}} \in \{0, 1\}^{\mathbb{Z}}$  at time  $t \geq 0$ . The  $\eta_x(t)$  are called *occupation variables* and can be thought of as the indicator function for the event that a particle is at site  $x$  at time  $t$ . The dynamics of this process is specified by nonnegative real numbers  $p \leq q$  (normalized by  $p + q = 1$ ) and uniformly bounded (from infinity and zero) rate parameters  $\{a_x\}_{x \in \mathbb{Z}}$ . For each pair of neighboring sites  $(y, y + 1)$ , the following exchanges happen in continuous time:

$$\begin{aligned} \eta &\mapsto \eta^{y,y+1} && \text{at rate } a_y p && \text{if } (\eta_y, \eta_{y+1}) = (1, 0), \\ \eta &\mapsto \eta^{y,y+1} && \text{at rate } a_y q && \text{if } (\eta_y, \eta_{y+1}) = (0, 1), \end{aligned}$$

where  $\eta^{y,y+1}$  denotes the state in which the value of the occupation variables at site  $y$  and  $y + 1$  are switched, and all other variables remain unchanged. All exchanges occur independently of each other according to exponential clocks. These dynamics are called the *ASEP occupation process* and are defined in terms of the generator  $L^{\text{occ}}$  which acts on local functions  $f : \{0, 1\}^{\mathbb{Z}} \rightarrow \mathbb{R}$  by

$$\begin{aligned} (21) \quad &(L^{\text{occ}} f)(\eta) \\ &= \sum_{y \in \mathbb{Z}} a_y [p \eta_y (1 - \eta_{y+1}) + q (1 - \eta_y) \eta_{y+1}] (f(\eta^{y,y+1}) - f(\eta)). \end{aligned}$$

The existence of a Markov process with this generator is shown, for example, in [24].

In terms of particles, the dynamics of ASEP are that each particle attempts, in continuous time, to jump right at rate  $pa_y$  and to the left at rate  $qa_{y-1}$  (presently the particle is at position  $y \in \mathbb{Z}$ ), subject to the exclusion rule that says that jumps are suppressed if the destination site is occupied. We assume  $p \leq q$  (drift to the left) and define  $\gamma := q - p \geq 0$  and  $\tau := p/q \leq 1$ .

The ASEP preserves the number of particles, thus we can consider ASEP with  $k$  particles as a process on the particle locations. Define

$$\tilde{W}^k = \{ \vec{x} = (x_1, x_2, \dots, x_k) \in \mathbb{Z}^k : x_1 < x_2 < \dots < x_k \}$$

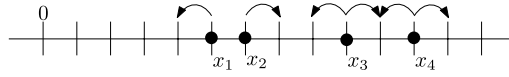

FIG. 4. ASEP with four particles:  $x_1 = 5, x_2 = 6, x_3 = 9$  and  $x_4 = 11$ . The first two particles form a cluster, and the third and fourth form two separate clusters. The arrows represent admissible moves.

and  $\vec{x}_i^\pm = (x_1, \dots, x_{i-1}, x_i \pm 1, x_{i+1}, \dots, x_k)$ . Then  $\vec{x}(t) = (x_1(t) < x_2(t) < \dots < x_k(t)) \in \widetilde{W}^k$  denotes the locations of the  $k$  particles of ASEP at time  $t$ .

In order to describe the generator of ASEP in terms of particle locations, it is convenient to introduce particle cluster notation (see Figure 4). A *cluster* is a collection of particles next to each other:  $x_i = x_{i+1} - 1 = \dots = x_{i+j} - j$ . There is a unique way of dividing the particles  $\vec{x}$  into clusters so that each cluster is separated by a buffer of at least one site: let  $c(\vec{x})$  be the number of such clusters,  $\ell(\vec{x}) = (\ell_1, \dots, \ell_c)$  be the collection of labels of the left-most particles of each cluster, and  $r(\vec{x}) = (r_1, \dots, r_c)$  be the collection of labels for the right-most particles of each cluster. For instance, if  $k = 4$  and  $x_1 = 5, x_2 = 6, x_3 = 9, x_4 = 11$  then  $c(\vec{x}) = 3, \ell(\vec{x}) = (1, 3, 4)$  and  $r(\vec{x}) = (2, 3, 4)$ .

For  $k \geq 1$ , the ASEP particle process generator acts on bounded functions  $f : \widetilde{W}^k \rightarrow \mathbb{R}$  by

$$(L^{\text{part}} f)(\vec{x}) = \sum_{i \in \ell(\vec{x})} a_{x_i-1} p [f(\vec{x}_i^-) - f(\vec{x})] + \sum_{i \in r(\vec{x})} a_{x_i} q [f(\vec{x}_i^+) - f(\vec{x})].$$

We will consider initial configurations for ASEP in which there is at most a finite number of nonzero occupation variables (i.e., particles) to the left of the origin—we call these *left-finite* initial data. When ASEP is initialized with left-finite initial data, its state remains left-finite for all time (simply because it will always have a left-most particle). We will use  $\mathbb{E}^\eta$  and  $\mathbb{P}^\eta$  to denote expectation and probability (resp.) of the Markov dynamics on occupation variables with initial data  $\eta$  (and likewise  $\mathbb{E}^{\vec{x}}$  and  $\mathbb{P}^{\vec{x}}$  for the Markov evolution on particle locations with initial data  $\vec{x}$ ). When the initial data is itself random, we write  $\mathbb{E}$  and  $\mathbb{P}$  to denote expectation and probability (resp.) of the Markov dynamics as well as the initial data. We also use  $\mathbb{E}$  and  $\mathbb{P}$  when the initial data is otherwise specified.

4.1. *Duality.* Recall that  $\tau = p/q \leq 1$  by assumption and define the following functions of a state  $\eta$ :

$$(22) \quad \begin{aligned} N_x(\eta) &= \sum_{y=-\infty}^x \eta_y, & Q_x(\eta) &= \tau^{N_x(\eta)}, \\ \tilde{Q}_x(\eta) &= \frac{Q_x(\eta) - Q_{x-1}(\eta)}{\tau - 1} = \tau^{N_{x-1}(\eta)} \eta_x. \end{aligned}$$

The following result shows that (with general bond rate parameters) the ASEP occupation process and the ASEP particle process with the role of  $p$  and  $q$  reversed, are dual with respect to a given function  $\tilde{H}$ . This is sometimes called self-duality, despite the fact that the processes involved are independent and defined with respect to different state spaces.

**THEOREM 4.1.** *Fix nonnegative real numbers  $p \leq q$  (normalized by  $p + q = 1$ ) and uniformly bounded (from infinity and zero) bond rate parameters  $\{a_x\}_{x \in \mathbb{Z}}$ . For any  $k \geq 1$ , the ASEP occupation process  $\eta(t)$  with state space  $\{0, 1\}^{\mathbb{Z}}$ , and the ASEP particle process  $\vec{x}(t)$  with state space  $\tilde{W}^k$  and the role of  $p$  and  $q$  reversed, are dual with respect to*

$$\tilde{H}(\eta, \vec{x}) = \prod_{i=1}^k \tilde{Q}_{x_i}(\eta).$$

If we restrict to  $a_x \equiv 1$  we can prove another ASEP duality.

**THEOREM 4.2.** *Fix nonnegative real numbers  $p \leq q$  (normalized by  $p + q = 1$ ) and bond rate parameters  $a_x \equiv 1$ . For any  $k \geq 1$ , the ASEP occupation process  $\eta(t)$  with state space  $\{0, 1\}^{\mathbb{Z}}$ , and the ASEP particle process  $\vec{x}(t)$  with state space  $\tilde{W}^k$  and the role of  $p$  and  $q$  reversed, are dual with respect to*

$$H(\eta, \vec{x}) = \prod_{i=1}^k Q_{x_i}(\eta).$$

Recall that the concept of duality is given in Definition 2.1. A few remarks are in order.

**REMARK 4.3.** For  $p < q$ , both forms of duality are trivial for initial data which is not left-finite, since then  $Q_x(\eta) \equiv 0$  and likewise  $\tilde{Q}_x(\eta) \equiv 0$ . By working with a height function, rather than  $N_x(\eta)$  it is likely possible to extend consideration to left-infinite initial data. We do not pursue this here.

**REMARK 4.4.** For the symmetric simple exclusion process ( $p = q = 1/2$ ), the duality from Theorem 4.1 has been known for some time (see [24], Chapter 8, Theorem 1.1). For  $p < q$ , the result of Theorem 4.1 was discovered by Schütz [34] in the late 1990s via a spin chain representation of ASEP (the result was stated for all  $a_x \equiv 1$ , though the proof is easily extended to general  $a_x$ ). The approach used therein to show duality was computationally based on a  $U_q(sl_2)$  symmetry for ASEP [31]. Our proof proceeds directly via the Markov dynamics, without any use of, or reference to, the  $U_q(sl_2)$ . Even though in our applications we quickly set  $a_x \equiv 1$ , it is both useful (in simply the proof) and informative (in showing that duality is weaker than integrability) to prove our result for general  $a_x$ .

The duality of Theorem 4.2 appears to be new. It does not seem possible to extend it to general  $a_x$ . For instance, when  $k = 1$ , as a function of the process  $\eta(t)$ ,  $H(\eta(t), x)$  only changes value when a particle moves across the bond between  $x$  and  $x + 1$ . This only involves the rate  $a_x$ . On the other hand, as a process of  $x(t)$ ,  $H(\eta, x(t))$  changes value when a particle moves across either the bond between  $x - 1$  and  $x$ , or the bond between  $x$  and  $x + 1$ . This involves the rates  $a_{x-1}$  and  $a_x$ . Hence, the two sides can only match when  $a_{x-1} = a_x$ .

REMARK 4.5. Gärtner [16] observed that ASEP respected a microscopic (i.e., particle-level) version of the Hopf–Cole transform (see, e.g., the review [14]). This observation is equivalent to the  $k = 1$ ,  $a_x \equiv 1$  case of the duality given in Theorem 4.2. It says that

$$dQ_x(\eta(t)) = (pQ_{x-1}(\eta(t)) + qQ_{x+1}(\eta(t)) - Q_x(\eta(t))) dt + Q_x(\eta(t)) dM(t),$$

where  $dM(t)$  is an explicit martingale. This is a particular semidiscrete SHE (different than the one coming from  $q$ -TASEP, Definition A.1) with a somewhat involved noise (the martingale is not exactly a discrete space–time white noise). A Feynman–Kac representation for this equation shows that  $Q_x(\eta(t))$  can be thought of as a polymer partition function with respect to an environment defined by the martingale. Therefore, Theorem 4.2 can be thought of as a version of the polymer replica approach (see Section A.2).

The proof of the two duality theorems boils down to two propositions which we now state and prove. After this, we prove the theorems.

PROPOSITION 4.6. Fix nonnegative real numbers  $p \leq q$  (normalized by  $p + q = 1$ ) and uniformly bounded (from infinity and zero) bond rate parameters  $\{a_x\}_{x \in \mathbb{Z}}$ . Then, with  $\eta$ ,  $\vec{x}$ , and  $\tilde{H}(\eta, \vec{x})$  defined in Theorem 4.1,

$$(23) \quad L^{\text{occ}} \tilde{H}(\eta, \vec{x}) = L^{\text{part}} \tilde{H}(\eta, \vec{x}),$$

where the generator  $L^{\text{occ}}$  acts in the  $\eta$  variable and the generator  $L^{\text{part}}$  acts in the  $\vec{x}$  variable.

PROOF. We will first prove the desired result for a single cluster configuration  $\vec{x} = (x, x + 1, \dots, x + \ell)$  and then easily deduce it for general  $\vec{x} \in \tilde{W}^k$ . For the single cluster  $\vec{x}$ , by the definition of  $L^{\text{occ}}$ ,

$$L^{\text{occ}} \tilde{H}(\eta, \vec{x}) = \sum_{i=-1}^{\ell} a_{x+i} A_{x+i}(\eta),$$

where

$$A_y(\eta) = (p\eta_y(1 - \eta_{y+1}) + q(1 - \eta_y)\eta_{y+1})[\tilde{H}(\eta^{y,y+1}, \vec{x}) - \tilde{H}(\eta, \vec{x})].$$

We now compute the  $A_y$ 's explicitly. Recall the notations introduced in (22). There are three different types of  $A_y$  that must be considered: (1)  $A_{x-1}(\eta)$ ; (2)  $A_{x+i}(\eta)$  for  $0 \leq i \leq \ell - 1$ ; (3)  $A_{x+\ell}(\eta)$ .

(1) Consider  $A_{x-1}(\eta)$ . We may rewrite

$$\tilde{H}(\eta, \vec{x}) = \tau^{N_{x-2}(\eta)} \tau^{\eta_{x-1}} \eta_x \prod_{j=1}^{\ell} \tilde{Q}_{x+j}(\eta)$$

and

$$\tilde{H}(\eta^{x-1,x}, \vec{x}) = \tau^{N_{x-2}(\eta)} \tau^{\eta_x} \eta_{x-1} \prod_{j=1}^{\ell} \tilde{Q}_{x+j}(\eta).$$

Thus,

$$\begin{aligned} A_{x-1}(\eta) &= \tau^{N_{x-2}(\eta)} \prod_{j=1}^{\ell} \tilde{Q}_{x+j}(\eta) (p\eta_{x-1}(1 - \eta_x) + q(1 - \eta_{x-1})\eta_x) \\ (24) \quad &\times [\tau^{\eta_x} \eta_{x-1} - \tau^{\eta_{x-1}} \eta_x]. \end{aligned}$$

(2) Consider  $A_{x+i}(\eta)$  for  $0 \leq i \leq \ell - 1$ . We may rewrite

$$\tilde{H}(\eta, \vec{x}) = \tau^{2N_{x+i-1}(\eta) + \eta_{x+i}} \eta_{x+i} \eta_{x+i+1} \prod_{\substack{j=0 \\ j \neq i, i+1}}^{\ell} \tilde{Q}_{x+j}(\eta)$$

and

$$\tilde{H}(\eta^{x+i, x+i+1}, \vec{x}) = \tau^{2N_{x+i-1}(\eta) + \eta_{x+i+1}} \eta_{x+i+1} \eta_{x+i} \prod_{\substack{j=0 \\ j \neq i, i+1}}^{\ell} \tilde{Q}_{x+j}(\eta).$$

Thus,

$$\begin{aligned} (25) \quad A_{x+i}(\eta) &= \tau^{2N_{x+i-1}(\eta)} \left( \prod_{\substack{j=0 \\ j \neq i, i+1}}^{\ell} \tilde{Q}_{x+j}(\eta) \right) \\ (26) \quad &\times (p\eta_{x+i}(1 - \eta_{x+i+1}) + q(1 - \eta_{x+i})\eta_{x+i+1}) \\ &\times [\tau^{\eta_{x+i+1}} - \tau^{\eta_{x+i}}] \eta_{x+i} \eta_{x+i+1}. \end{aligned}$$

(3) Consider  $A_{x+\ell}(\eta)$ . We may rewrite

$$\tilde{H}(\eta, \vec{x}) = \tau^{N_{x+\ell-1}(\eta)} \eta_{x+\ell} \prod_{j=0}^{\ell-1} \tilde{Q}_{x+j}(\eta)$$

and

$$\tilde{H}(\eta^{x+\ell, x+\ell+1}, \vec{x}) = \tau^{N_{x+\ell-1}(\eta)} \eta_{x+\ell+1} \prod_{j=0}^{\ell-1} \tilde{Q}_{x+j}(\eta).$$

Thus,

$$(27) \quad A_{x+\ell}(\eta) = \tau^{N_{x+\ell-1}(\eta)} \left( \prod_{j=0}^{\ell-1} \tilde{Q}_{x+j}(\eta) \right)$$

$$(28) \quad \begin{aligned} &\times (p\eta_{x+\ell}(1 - \eta_{x+\ell+1}) + q(1 - \eta_{x+\ell})\eta_{x+\ell+1}) \\ &\times [\eta_{x+\ell+1} - \eta_{x+\ell}]. \end{aligned}$$

Observe that  $A_{x+i}(\eta) = 0$  for  $0 \leq i \leq \ell - 1$ . To see this, it suffices to consider the four values that the pair  $(\eta_{x+i}, \eta_{x+i+1})$  may take: for  $(0, 0)$  or  $(1, 1)$

$$(p\eta_{x+i}(1 - \eta_{x+i+1}) + q(1 - \eta_{x+i})\eta_{x+i+1})[\tau^{\eta_{x+i}} - \tau^{\eta_{x+i+1}}] = 0$$

and thus (25) = 0; for  $(0, 1)$  or  $(1, 0)$ , the factor  $\eta_{x+i}\eta_{x+i+1} = 0$  and thus (25) = 0 again.

The above observation shows that, in fact,

$$(L^{\text{occ}} f)(\eta) = a_{x-1}A_{x-1}(\eta) + a_{x+\ell}A_{x+\ell}(\eta).$$

In light of equations (24) and (27), we may rewrite

$$A_{x-1}(\eta) = M(\eta)A'_{x-1}(\eta) \quad \text{and} \quad A_{x+\ell}(\eta) = M(\eta)A'_{x+\ell}(\eta),$$

where

$$M(\eta) = \tau^{N_{x-2}(\eta) + N_{x+\ell-1}(\eta)} \prod_{j=1}^{\ell-1} \tilde{Q}_{x+j}(\eta)$$

and

$$A'_{x-1}(\eta) = \eta_{x+\ell}(p\eta_{x-1}(1 - \eta_x) + q(1 - \eta_{x-1})\eta_x)[\tau^{\eta_x}\eta_{x-1} - \tau^{\eta_{x-1}}\eta_x],$$

$$A'_{x+\ell}(\eta) = \tau^{\eta_{x-1}}\eta_x(p\eta_{x+\ell}(1 - \eta_{x+\ell+1}) + q(1 - \eta_{x+\ell})\eta_{x+\ell+1})[\eta_{x+\ell+1} - \eta_{x+\ell}].$$

Now turn to the right-hand side of equation (23). We may also factor  $M(\eta)$  out from that expression

$$\begin{aligned} \text{RHS (23)} = M(\eta) &[a_{x-1}p\eta_{x-1}\eta_{x+\ell} + a_{x+\ell}q\tau^{\eta_{x-1}}\eta_x\tau^{\eta_{x+\ell}}\eta_{x+\ell+1} \\ &- (a_{x-1}q + a_{x+\ell}p)\tau^{\eta_{x-1}}\eta_x\eta_{x+\ell}]. \end{aligned}$$

Therefore, for the single cluster case of the proposition, we are left to prove

$$\begin{aligned} &a_{x-1}A'_{x-1}(\eta) + a_{x+\ell}A'_{x+\ell}(\eta) \\ &= a_{x-1}p\eta_{x-1}\eta_{x+\ell} + a_{x+\ell}q\tau^{\eta_{x-1}}\eta_x\tau^{\eta_{x+\ell}}\eta_{x+\ell+1} \\ &\quad - (a_{x-1}q + a_{x+\ell}p)\tau^{\eta_{x-1}}\eta_x\eta_{x+\ell}. \end{aligned}$$

The above equation is a function of only four occupation variables  $\eta_{x-1}, \eta_x, \eta_{x+\ell}$  and  $\eta_{x+\ell+1}$  and one can systematically check that for all sixteen combinations of values of these variables, the above equation is true. In fact, it is even easier than this since the coefficients of  $a_{x-1}$  and  $a_{x+\ell}$  coincide separately. For instance, we must show that  $A'_{x-1}(\eta) = \eta_{x+\ell}(p\eta_{x-1} - q\tau^{\eta_{x-1}}\eta_x)$ . There are only four cases of  $(\eta_{x-1}, \eta_x)$  that have to be considered and this can be confirmed in one's head [similarly for  $A'_{x+\ell}(\eta)$ ]. This completes the proof of Proposition 4.6 for  $\vec{x}$  with just a single cluster.

For a general  $\vec{x} \in \widetilde{W}^k$  there may be many clusters, each pair separated by at least one empty site. The terms in  $\widetilde{H}(\eta, x)$  factor into clusters and the generator  $L^{\text{occ}}$  acts on each of these clusters according to the above proved single cluster result. This immediately yields the general statement and completes the proof.  $\square$

**PROPOSITION 4.7.** *Fix nonnegative real numbers  $p \leq q$  (normalized by  $p + q = 1$ ) and set all bond rate parameters  $a_x \equiv 1$ . Then, with  $\eta, \vec{x}$ , and  $H(\eta, \vec{x})$  defined in Theorem 4.2,*

$$L^{\text{occ}}H(\eta, \vec{x}) = L^{\text{part}}H(\eta, \vec{x}),$$

where the generator  $L^{\text{occ}}$  acts in the  $\eta$  variable and the generator  $L^{\text{part}}$  acts in the  $\vec{x}$  variable.

**PROOF.** As in the proof of Proposition 4.6, we will first prove the desired result for a single cluster configuration  $\vec{x} = (x, x + 1, \dots, x + \ell)$  and then easily deduce it for general  $\vec{x} \in \widetilde{W}^k$ . For the single cluster  $\vec{x}$ , by the definition of  $L^{\text{occ}}$ ,

$$L^{\text{occ}}H(\eta, \vec{x}) = \sum_{i=0}^{\ell} A_{x+i}(\eta),$$

where

$$A_y(\eta) = (p\eta_y(1 - \eta_{y+1}) + q(1 - \eta_y)\eta_{y+1})[H(\eta^{y,y+1}, \vec{x}) - H(\eta, \vec{x})].$$

By grouping terms, this may be rewritten as

$$\begin{aligned} A_{x+i}(\eta) &= Q_{x+i-1}(\eta) \left( \prod_{\substack{j=0 \\ j \neq i}}^{\ell} Q_{x+j}(\eta) \right) (p\eta_{x+i}(1 - \eta_{x+i+1}) + q\eta_{x+i+1}(1 - \eta_{x+i})) \\ &\quad \times [\tau^{\eta_{x+i+1}} - \tau^{\eta_{x+i}}] \\ &= \prod_{j=0}^{\ell} Q_{x+j-1}(\eta) \prod_{\substack{j=0 \\ j \neq i}}^{\ell} \tau^{\eta_{x+j}} \cdot (p + q\tau^{\eta_{x+i}}\tau^{\eta_{x+i+1}} - \tau^{\eta_{x+i}}). \end{aligned}$$

In order to get the second line above, we utilized the definition of  $Q_{x+i-1}(\eta)$  and separately the fact (which can readily be checked) that for the four possible pairs of values that  $(\eta_{x+i}, \eta_{x+i+1})$  can take

$$\begin{aligned} & (p\eta_{x+i}(1 - \eta_{x+i+1}) + q\eta_{x+i+1}(1 - \eta_{x+i}))[\tau^{\eta_{x+i+1}} - \tau^{\eta_{x+i}}] \\ & = p + q\tau^{\eta_{x+i}}\tau^{\eta_{x+i+1}} - \tau^{\eta_{x+i}}. \end{aligned}$$

Recall that we seek to show

$$\begin{aligned} & \sum_{i=0}^{\ell} A_{x+i}(\eta) \\ & = pQ_{x-1}(\eta) \prod_{j=1}^{\ell} Q_{x+j}(\eta) + qQ_{x+\ell+1}(\eta) \prod_{j=0}^{\ell-1} Q_{x+j}(\eta) - \prod_{j=0}^{\ell} Q_{x+j}(\eta). \end{aligned}$$

Factoring out  $(\prod_{j=0}^{\ell} Q_{x+j-1}(\eta))$  from both sides we are left to prove

$$\begin{aligned} & \left( \sum_{i=0}^{\ell} \prod_{\substack{j=0 \\ j \neq i}}^{\ell} \tau^{\eta_{x+j}} \right) (p + q\tau^{\eta_{x+i}}\tau^{\eta_{x+i+1}} - \tau^{\eta_{x+i}}) \\ (29) \quad & = p \prod_{j=1}^{\ell} \tau^{\eta_{x+j}} + q \prod_{j=0}^{\ell+1} \tau^{\eta_{x+j}} - \prod_{j=0}^{\ell} \tau^{\eta_{x+j}}. \end{aligned}$$

The terms in the left-hand side of the above expression can be grouped as

$$p \prod_{j=1}^{\ell} \tau^{\eta_{x+j}} + \sum_{i=1}^{\ell} \prod_{\substack{j=0 \\ j \neq i}}^{\ell} \tau^{\eta_{x+j}} (p + q\tau^{2\eta_{x+i}} - \tau^{\eta_{x+i}}) + q \prod_{j=0}^{\ell+1} \tau^{\eta_{x+j}} - \prod_{j=0}^{\ell} \tau^{\eta_{x+j}}.$$

We may now utilize the easily checked identity that for  $\eta \in \{0, 1\}$ ,

$$p + q\tau^{2\eta} - \tau^{\eta} = 0,$$

to see that the above expression reduces to the right-hand side of (29), thus completing the proof of Proposition 4.7 for  $\vec{x}$  with just a single cluster.

From a general  $\vec{x} \in \widetilde{W}^k$ , there might be many clusters, each pair separated by at least one empty site. The terms in  $H(\eta, x)$  factor into clusters and the generator  $L^{\text{occ}}$  acts on each of these clusters according to the above proved single cluster result. This immediately yields the general statement and completes the proof.  $\square$

Before giving the proof of Theorem 4.1 we define the following system of ODEs.

DEFINITION 4.8. We say that  $\tilde{h}(t; \vec{x}) : \mathbb{R}_+ \times \widetilde{W}^k \rightarrow \mathbb{R}$  solves the *true evolution equation* with initial data  $\tilde{h}_0(\vec{x})$  if:



(1) For all  $\vec{x} \in \widetilde{W}^k$  and  $t \in \mathbb{R}_+$ ,

$$\frac{d}{dt} \tilde{h}(t; \vec{x}) = L^{\text{part}} \tilde{h}(t; \vec{x});$$

(2) There exist constants  $c, C > 0$  and  $\delta > 0$  such that for all  $\vec{x} \in \widetilde{W}^k, t \in [0, \delta]$

$$|\tilde{h}(t; \vec{x})| \leq C e^{c \|\vec{x}\|_1};$$

(3) As  $t \rightarrow 0, \tilde{h}(t; \vec{x})$  converges pointwise to  $\tilde{h}_0(\vec{x})$ .

PROPOSITION 4.9. Assume that there exists constants  $c, C > 0$  such that for all  $\vec{x} \in \widetilde{W}^k,$

$$(30) \quad |\tilde{h}_0(\vec{x})| \leq C e^{c \|\vec{x}\|_1}.$$

Then there exists a unique solution to the system of ODEs given in Definition 4.8 which is given by

$$(31) \quad \tilde{h}(t; \vec{x}) := \mathbb{E}^{-t; \vec{x}}[h_0(\vec{x}(0))],$$

where the expectation is with respect to the ASEP particle process  $\vec{x}(\cdot)$  started at time  $-t$  in configuration  $\vec{x}$ .

This existence and uniqueness result is proved in Appendix C. We use this result presently in the proof of Theorem 4.1, and also later in the proof of Theorem 4.13. It is in the second application of this result that we fully utilize the weakness of conditions 2 and 3 in Definition 4.8.

PROOF OF THEOREM 4.1. We follow the same approach as in the proof of Theorem 2.2. Our present theorem follows from Proposition 4.6 along with Proposition 4.9. Observe that

$$\begin{aligned} \frac{d}{dt} \mathbb{E}^\eta[\tilde{H}(\eta(t), \vec{x})] &= L^{\text{occ}} \mathbb{E}^\eta[\tilde{H}(\eta(t), \vec{x})] \\ &= \mathbb{E}^\eta[L^{\text{occ}} \tilde{H}(\eta(t), \vec{x})] \\ &= \mathbb{E}^\eta[L^{\text{part}} \tilde{H}(\eta(t), \vec{x})] \\ &= L^{\text{part}} \mathbb{E}^\eta[\tilde{H}(\eta(t), \vec{x})]. \end{aligned}$$

The equality of the first line is from the definition of the generator of  $\eta(t)$ ; the equality between the first and second lines is from the commutativity of the generator with the Markov semigroup; the equality between the second and third lines is from applying Proposition 4.6 to the expression inside the expectation; the final equality is from the fact that the generator  $L^{\text{part}}$  now acts on the  $\vec{x}$  coordinate and the expectation acts on the  $\eta$  coordinate. This shows that, as a function of  $t$  and  $\vec{x},$

$\mathbb{E}^\eta[\tilde{H}(\eta(t), \vec{x})]$  solves the true evolution equation of Definition 4.8 (checking condition 2 is straightforward and condition 3 can be checked as in the proof of Proposition 4.9).

On the other hand, Proposition 4.9 implies that  $\mathbb{E}^\eta[\tilde{H}(\eta, \vec{x}(t))]$  also solves the true evolution equation of Definition 4.8 and that it is the unique such solution. This proves the desired equality to show the claimed duality.  $\square$

**PROOF OF THEOREM 4.2.** This follows exactly as in the proof of Theorem 4.1, with Proposition 4.6 replaced by Proposition 4.7.  $\square$

4.2. *Systems of ODEs.* As a result of duality, we provide two different systems of ODEs to characterize  $\mathbb{E}^\eta[\tilde{H}(\eta(t), \vec{x})]$ . These two systems should be compared to the first two systems of ODEs associated to  $q$ -TASEP duality, given in Proposition 2.7. It is not entirely clear how to formulate a Schrödinger equation with Bosonic Hamiltonian for ASEP due to the *strict* ordering of  $\vec{x} \in \tilde{W}^k$ . This does not, however, pose any significant impediment as we are more concerned with solving the free evolution equation with  $k - 1$  boundary conditions.

We first state the result for the  $\tilde{H}(\eta, \vec{x})$  duality.

**PROPOSITION 4.10.** *Let  $\eta$  be a left-finite occupation configuration in  $\{0, 1\}^{\mathbb{Z}}$  and  $\eta(t)$  be ASEP started from  $\eta(0) = \eta$ .*

(A) True evolution equation: *If  $\tilde{h}(t; \vec{x}) : \mathbb{R}_+ \times \tilde{W}^k \rightarrow \mathbb{R}$  solves the system of ODEs given in Definition 4.8 with initial data  $\tilde{h}_0(\vec{x}) = \tilde{H}(\eta, \vec{x})$ , then for all  $\vec{x} \in \tilde{W}^k$ ,  $\mathbb{E}^\eta[\tilde{H}(\eta(t), \vec{x})] = \tilde{h}(t; \vec{x})$ .*

(B) Free evolution equation with  $k - 1$  boundary conditions: *If  $\tilde{u} : \mathbb{R}_+ \times \mathbb{Z}^k \rightarrow \mathbb{R}$  solves:*

(1) For all  $\vec{x} \in \mathbb{Z}^k$  and  $t \in \mathbb{R}_+$ ,

$$(32) \quad \begin{aligned} & \frac{d}{dt} \tilde{u}(t; \vec{x}) \\ &= \sum_{i=1}^k [a_{x_i-1} p \tilde{u}(t; \vec{x}_i^-) + a_{x_i} q \tilde{u}(t; \vec{x}_i^+) - (a_{x_i-1} q + p a_{x_i}) \tilde{u}(t; \vec{x})]; \end{aligned}$$

(2) For all  $\vec{x} \in \mathbb{Z}^k$  such that for some  $i \in \{1, \dots, k - 1\}$ ,  $x_{i+1} = x_i + 1$ ,

$$(33) \quad p \tilde{u}(t; \vec{x}_{i+1}^-) + q \tilde{u}(t; \vec{x}_i^+) = \tilde{u}(t; \vec{x});$$

(3) There exist constants  $c, C > 0$  and  $\delta > 0$  such that for all  $\vec{x} \in \tilde{W}^k$ ,  $t \in [0, \delta]$

$$|\tilde{u}(t; \vec{x})| \leq C e^{c \|\vec{x}\|_1};$$

(4) For all  $\vec{x} \in \tilde{W}^k$ , as  $t \rightarrow 0$ ,  $\tilde{u}(t; \vec{x}) \rightarrow \tilde{H}(\eta, \vec{x})$ .

Then for all  $\vec{x} \in \tilde{W}^k$ ,  $\mathbb{E}^\eta[\tilde{H}(\eta(t), \vec{x})] = \tilde{u}(t; \vec{x})$ .

PROOF. Part (A) is an immediate consequence of the duality result of Theorem 4.1 along with its proof. Call the three conditions contained in Definition 4.8 (A.1), (A.2) and (A.3).

Part (B) follows by showing that if the four conditions for  $\tilde{u}$  given in (B) hold, then it implies that  $u(t; \vec{x})$  restricted to  $\vec{x} \in \widetilde{W}^k$  actually satisfies conditions (A.1), (A.2) and (A.3). Conditions (B.3) and (B.4) immediately imply conditions (A.2) and (A.3), respectively. It is easy to check that the  $k - 1$  boundary conditions (B.2) along with the free evolution equation (B.1) combine to yield the generator  $L^{\text{part}}$  and hence yield (A.1). Applying part (A), we see that given the conditions of (B), we may conclude that for all  $\vec{x} \in \widetilde{W}^k$ ,  $\mathbb{E}^\eta[\tilde{H}(\eta(t), \vec{x})] = \tilde{u}(t; \vec{x})$ . □

We have an almost identical result and proof associated with the  $H(\eta, \vec{x})$  duality.

PROPOSITION 4.11. *Let  $\eta$  be a left-finite occupation configuration in  $\{0, 1\}^{\mathbb{Z}}$  and  $\eta(t)$  be ASEP started from  $\eta(0) = \eta$ .*

(A) True evolution equation: *If  $h(t; \vec{x}) : \mathbb{R}_+ \times \widetilde{W}^k \rightarrow \mathbb{R}$  solves the system of ODEs given in Definition 4.8 with initial data  $h_0(\vec{x}) = H(\eta, \vec{x})$ , then for all  $\vec{x} \in \widetilde{W}^k$ ,  $\mathbb{E}^\eta[H(\eta(t), \vec{x})] = h(t; \vec{x})$ .*

(B) Free evolution equation with  $k - 1$  boundary conditions: *If  $\tilde{u} : \mathbb{R}_+ \times \mathbb{Z}^k \rightarrow \mathbb{R}$  solves:*

(1) *For all  $\vec{x} \in \mathbb{Z}^k$  and  $t \in \mathbb{R}_+$ ,*

$$\frac{d}{dt}u(t; \vec{x}) = \sum_{i=1}^k [pu(t; \vec{x}_i^-) + qu(t; \vec{x}_i^+) - u(t; \vec{x})];$$

(2) *For all  $\vec{x} \in \mathbb{Z}^k$  such that for some  $i \in \{1, \dots, k - 1\}$ ,  $x_{i+1} = x_i + 1$ ,*

$$pu(t; \vec{x}_{i+1}^-) + qu(t; \vec{x}_i^+) = u(t; \vec{x});$$

(3) *There exist constants  $c, C > 0$  and  $\delta > 0$  such that for all  $\vec{x} \in \widetilde{W}^k$ ,  $t \in [0, \delta]$*

$$|u(t; \vec{x})| \leq Ce^{c\|\vec{x}\|_1};$$

(4) *For all  $\vec{x} \in \widetilde{W}^k$ , as  $t \rightarrow 0$ ,  $u(t; \vec{x}) \rightarrow H(\eta, \vec{x})$ .*

*Then for all  $\vec{x} \in \widetilde{W}^k$ ,  $\mathbb{E}^\eta[H(\eta(t), \vec{x})] = u(t; \vec{x})$ .*

PROOF. Similar to that of Proposition 4.10. □

4.3. *Nested contour integral ansatz.* From now on, we assume that all bond rate parameters  $a_x \equiv 1$ , in which case equation (32) becomes

$$(34) \quad \frac{d}{dt} \tilde{u}(t; \vec{x}) = \sum_{i=1}^k [p\tilde{u}(t; \vec{x}_i^-) + q\tilde{u}(t; \vec{x}_i^+) - \tilde{u}(t; \vec{x})].$$

It is not a priori clear how one might explicitly solve the systems of ODEs in Propositions 4.10 and 4.11. For  $q$ -TASEP, when confronted with the analogous problem of solving the system of ODEs in Proposition 2.7, we appealed to a nested contour integral ansatz which was suggested from the algebraic framework of Macdonald processes (into which  $q$ -TASEP fits).

ASEP, on the other hand, is not known to fit into the Macdonald process framework, nor any similar framework from which solutions to these systems of ODEs would be suggested. Nevertheless, we demonstrate now that we may apply a nested contour integral ansatz. We focus on solving the system of ODEs in Proposition 4.10 for two distinguished types of initial data. Notice that in the below theorem, the contours are not nested, however, they are chosen in a particular manner to avoid poles coming from the denominator  $z_A - \tau z_B$ .

DEFINITION 4.12. For  $\rho \in [0, 1]$  consider an i.i.d. collection  $\{Y_x\}_{x \geq 1}$  of Bernoulli random variables taking value 1 with probability  $\rho$ . Then the *step Bernoulli* initial data for ASEP is given by setting  $\eta_x(0) = 0$  for  $x \leq 0$  and  $\eta_x(0) = Y_x$  for  $x \geq 1$ . When  $\rho = 1$ , this is called *step* initial data and (deterministically)  $\eta_x(0) = \mathbf{1}_{x \geq 1}$ . We also define  $\theta = \rho/(1 - \rho)$ .

Define the function

$$(35) \quad f_z(x, t; \rho) = \exp\left[-\frac{z(p-q)^2}{(1+z)(p+qz)}t\right] \left(\frac{1+z}{1+z/\tau}\right)^{x-1} \frac{1}{\tau+z} \frac{-\tau\theta}{z-\tau\theta}.$$

When  $\rho = 1$  (and hence  $\theta = \infty$ ), the definition of  $f_z(x, t; 1)$  corresponds to the expression above, with the final fraction removed. Also define

$$(36) \quad F_z(x, t; \rho) = \exp\left[-\frac{z(p-q)^2}{(z+1)(p+qz)}t\right] \left(\frac{1+z}{1+z/\tau}\right)^x \frac{-\tau\theta}{z-\tau\theta}$$

and likewise extend to  $\rho = 1$ .

Finally, define an integration contour  $C_{-\tau, -1}$  as a circle around  $-\tau$ , chosen with small enough radius so that  $-1$  is not included, nor is the image of  $C_{-\tau, -1}$  under multiplication by  $\tau$ . It is also important that  $\tau\theta$  and  $0$  are not contained in  $C_{-\tau, -1}$ , but these facts are necessarily true from the definition.

THEOREM 4.13. Fix nonnegative real numbers  $0 < p < q$  (normalized by  $p + q = 1$ ) and set all bond rate parameters  $a_x \equiv 1$ . Consider step Bernoulli initial

data with density  $\rho \in (0, 1]$ . The system of ODEs given in Proposition 4.10(B) is solved by the following formula:

$$(37) \quad \tilde{u}(t; \vec{x}) = \frac{\tau^{k(k-1)/2}}{(2\pi\iota)^k} \int \cdots \int \prod_{1 \leq A < B \leq k} \frac{z_A - z_B}{z_A - \tau z_B} \prod_{i=1}^k f_{z_i}(x_i, t; \rho) dz_i,$$

where the integration contour is given by  $C_{-\tau; -1}$ .

As an immediate corollary of Theorem 4.13 and Proposition 4.10(B) we find formulas for joint moments of the  $\tilde{Q}_x(t)$  defined in (22).

COROLLARY 4.14. Fix  $k \geq 1$ , nonnegative real numbers  $0 < p < q$  (normalized by  $p + q = 1$ ) and set all bond rate parameters  $a_x \equiv 1$ . For step Bernoulli initial data with density  $\rho \in (0, 1]$  and any  $\vec{x} \in \tilde{W}^k$ ,

$$(38) \quad \mathbb{E}[\tilde{Q}_{x_1}(\eta(t)) \cdots \tilde{Q}_{x_k}(\eta(t))] = \frac{\tau^{k(k-1)/2}}{(2\pi\iota)^k} \int \cdots \int \prod_{1 \leq A < B \leq k} \frac{z_A - z_B}{z_A - \tau z_B} \prod_{i=1}^k f_{z_i}(x_i, t; \rho) dz_i,$$

where the integration contour is given by  $C_{-\tau; -1}$ .

REMARK 4.15. The true evolution equation (A) in Proposition 4.10 can alternatively be solved using the Green’s function formula of [38] for the ASEP particle process generator. This results in a rather different expression than we find in (38) since the Green’s function is expressed as a sum of  $k!$ ,  $k$ -fold contour integrals. The equivalence of the expression in (38) to the expression one arrives at using [38] is a result of a nontrivial symmetrization. The single  $k$ -fold contour integral formula we find is essential as it enables us to proceed from duality to the two types (Mellin–Barnes and Cauchy) of Fredholm determinant formulas we find for ASEP.

PROOF OF THEOREM 4.13. We give the proof for step Bernoulli initial data with  $\rho \in (0, 1)$ , and hence  $\theta \in (0, \infty)$ . The modification for the  $\rho = 1$  case is trivial.

We need to prove that  $\tilde{u}(t; \vec{x})$ , as defined in (37), satisfies the four conditions of Proposition 4.10(B).

Condition (B.1) is satisfied by linearity and the fact that

$$\left[ \frac{d}{dt} - \Delta^{p,q} \right] f_z(x, t; \rho) = 0,$$

where  $\Delta^{p,q} g(x) = pg(x - 1) + qg(x + 1) - g(x)$  acts on the  $x$ -variable in  $f_z(x, t; \rho)$ .

Condition (B.2) relies on the Vandermonde factors as well as the choice of contours. Without loss of generality, assume that  $x_2 = x_1 + 1$ . We wish to show that

$$p\tilde{u}(t; \vec{x}_2^-) + q\tilde{u}(t; \vec{x}_1^+) - \tilde{u}(t; \vec{x}) = 0.$$

Thinking of the left-hand side as an operator applied to  $\tilde{u}(t; \vec{x})$ , we compute the effect of this operator on the integrand of (37) and find that it just brings out an extra factor in the integrand [when compared to  $\tilde{u}(t; \vec{x}_2^-)$ ] which is

$$\begin{aligned}
 (39) \quad & p + q \left( \frac{1 + z_1}{1 + z_1/\tau} \right) \left( \frac{1 + z_2}{1 + z_2/\tau} \right) - \left( \frac{1 + z_2}{1 + z_2/\tau} \right) \\
 & = (z_1 - \tau z_2) \frac{(p - q)/\tau}{(1 + z_1/\tau)(1 + z_2/\tau)}.
 \end{aligned}$$

We must show that the integral with this new factor times the integrand in (37) is zero. The factor  $(z_1 - \tau z_2)$  cancels the term corresponding to  $A = 1$  and  $B = 2$  in the denominator of

$$\prod_{1 \leq A < B \leq k} \frac{z_A - z_B}{z_A - \tau z_B}.$$

The term  $(z_1 - z_2)$  in the numerator remains, and the additional terms coming from (39) are symmetric in  $z_1$  and  $z_2$ . Therefore, we can write

$$\tilde{u}(t; \vec{x}) = \iint (z_1 - z_2) G(z_1) G(z_2) dz_1 dz_2,$$

where  $G(z)$  involves the integrals in  $z_3, \dots, z_k$ . Since the contours are identical, this integral is zero, proving (B.2).

Condition (B.3) follows via very soft bounds. Observe that as  $z$  varies along the contour  $C_{-\tau; -1}$ , and as  $t$  varies in  $[0, \delta]$  for any  $\delta$ , it is easy to bound  $|f_z(x, t; \rho)| \leq C e^{c\|x\|_1}$  for some constants  $c, C > 0$ . Since the contours are finite and since the other terms in the integrand defining  $\tilde{u}$  are bounded along  $C_{-\tau; -1}$ ,  $\tilde{u}(t; \vec{x})$  is likewise bounded, thus implying the desired inequality to show condition (B.3).

Condition (B.4) follows from residue calculus. In order to check it, however, we must first determine what initial data corresponds to step Bernoulli ASEP initial data.

LEMMA 4.16. *For step Bernoulli initial data with density parameter  $\rho \in (0, 1]$  and  $\vec{x} \in \tilde{W}^k$ ,*

$$\begin{aligned}
 (40) \quad & \mathbb{E}[\tilde{Q}_{x_1}(\eta(0)) \cdots \tilde{Q}_{x_k}(\eta(0))] \\
 & = \mathbf{1}_{x_1 > 0} \prod_{j=1}^k \rho \tau^{k-j} (\rho \tau^{k-j+1} + 1 - \rho)^{x_j - x_{j-1} - 1}
 \end{aligned}$$

with the convention that  $x_0 = 0$ .

PROOF. From the definition of  $\tilde{Q}_x(\eta)$ , one readily sees that

$$(41) \quad \tilde{Q}_{x_1}(\eta(0)) \cdots \tilde{Q}_{x_k}(\eta(0)) = \prod_{j=1}^k \eta_{x_j} \tau^{(k-j)\eta_{x_j}} \tau^{(k-j+1)(\sum_{y=x_{j-1}+1}^{x_j} \eta_y)}.$$

This expression involves two types of terms:  $\eta_x \tau^{\ell \eta_x}$  and  $\tau^{\ell \eta_x}$ . Observe that

$$\mathbb{E}[\eta_x \tau^{\ell \eta_x}] = \rho \tau^\ell, \quad \mathbb{E}[\tau^{\ell \eta_x}] = \rho \tau^\ell + 1 - \rho.$$

Taking expectations of (41) and using the above formulas, we get the desired result.  $\square$

Thus, in order to show (B.4) we must prove that

$$(42) \quad \lim_{t \rightarrow 0} \tilde{u}(t; \vec{x}) = \mathbf{1}_{x_1 > 0} \prod_{j=1}^k \rho \tau^{k-j} (\rho \tau^{k-j+1} + 1 - \rho)^{x_j - x_{j-1} - 1}.$$

(Note that for  $\rho = 1$  this simply reduces to  $\mathbf{1}_{x_1 > 0} \prod_{j=1}^k \tau^{x_j - 1}$ .) The first observation is that we can take the limit of  $t \rightarrow 0$  inside of the integral defining  $\tilde{u}(t; \vec{x})$ . This is because the integral defining  $\tilde{u}$  is along a finite contour and the integrand is uniformly converging to its  $t = 0$  limiting value along this contour.

When  $t = 0$  the exponential term in the integrand of (37) disappears. If  $x_1 \leq 0$ , then the integrand no longer has a pole at  $z_1 = -\tau$ . Since there are no other poles contained in the  $z_1$  contour, Cauchy’s theorem implies that the integral is zero, hence the condition that  $\tilde{u}(0; \vec{x}) = 0$  is satisfied.

Alternatively, we must consider the case where  $0 < x_1 < x_2 < \dots < x_k$ . We can write  $\tilde{u}(0; \vec{x})$  as

$$(43) \quad \tilde{u}(0; \vec{x}) = \tau^k \tau^{k(k-1)/2} g_\ell(x_1, \dots, x_k),$$

where we define (for  $\ell \geq 1$ ),

$$g_\ell(x_1, \dots, x_k) = \frac{(-1)^k}{(2\pi i)^k} \int \dots \int \prod_{1 \leq A < B \leq k} \frac{z_A - z_B}{z_A - \tau z_B} \times \prod_{i=1}^k \left( \frac{1 + z_i}{1 + z_i/\tau} \right)^{x_i - 1} \frac{1}{\tau + z_i} \frac{\theta}{z_i - \tau^\ell \theta} dz_i.$$

As a convention, when  $k = 0$  we define  $g_\ell \equiv 1$ .

LEMMA 4.17. For  $\ell \geq 1$  and  $0 < x_1 < x_2 < \dots < x_k$ ,

$$g_\ell(x_1, \dots, x_k) = \left( \frac{1 + \tau^\ell \theta}{1 + \tau^{\ell-1} \theta} \right)^{x_k - 1} \frac{\theta}{\tau + \tau^\ell \theta} g_{\ell+1}(x_1, \dots, x_{k-1}).$$

PROOF. The lemma follows from residue calculus. Expand  $z_k$  to infinity. Due to quadratic decay in  $z_k$  at infinity there is no pole. Thus, the integral is equal to  $-1$  times the sum of the residues at  $z_k = \tau^{-1} z_j$  for  $j < k$  and at  $z_k = \tau^\ell \theta$ .

First, consider the residue at  $z_k = \tau^{-1}z_j$  for some  $j < k$ . That residue equals an integral with one fewer variable:

$$\begin{aligned} & \frac{(-1)^{k-1}}{(2\pi i)^{k-1}} \int \cdots \int \prod_{1 \leq A < B \leq k-1} \frac{z_A - z_B}{z_A - \tau z_B} \prod_{i=1}^{k-1} \left( \frac{1 + z_i}{1 + z_i/\tau} \right)^{x_i-1} \frac{1}{\tau + z_i} \frac{dz_i}{z_i - \tau^\ell \theta} \\ & \times \frac{z_j/\tau - z_j}{\tau} \prod_{\substack{i=1 \\ i \neq j}}^{k-1} \frac{z_i - z_j/\tau}{z_i - z_j} \left( \frac{1 + z_j/\tau}{1 + z_j/\tau^2} \right)^{x_k-1} \frac{1}{\tau + z_j/\tau} \frac{1}{z_j/\tau - \tau^\ell \theta}. \end{aligned}$$

This integrand has no pole at  $z_j = -\tau$ . This is because the new factor contains  $(1 + z_j/\tau)^{x_k-1}$  in the numerator and, since  $x_k > x_j$ , this factor cancels the pole coming from the denominator  $(1 + z_j/\tau)^{x_j-1}$ . Since the contour for  $z_j$  was a small circle around  $-\tau$  the fact that this pole is no longer present implies that the entire integral is zero. This shows that the residue at  $z_k = z_j/\tau$  for any  $j < k$  is zero.

The remaining residue to consider is from  $z_k = \tau^\ell \theta$ . One readily checks that evaluating this residue leads to the desired recursion relation between  $g_\ell(x_1, \dots, x_k)$  and  $g_{\ell+1}(x_1, \dots, x_{k-1})$ . Finally, note that when  $k = 1$  the recursion holds under the convention which we adopted that without any arguments,  $g_\ell$  equals 1.  $\square$

We may now conclude the proof of condition (B.4). Iteratively applying Lemma 4.17 leads to

$$g_1(x_1, \dots, x_k) = \prod_{j=1}^k \left( \frac{1 + \tau^j \theta}{1 + \tau^{j-1} \theta} \right)^{x_{k-j+1}-1} \frac{\theta}{\tau + \tau^j \theta}.$$

After some algebra one confirms that plugging this into (43) leads to the desired equation of (42), and hence completes the proof of condition (B.4).  $\square$

**4.4. ASEP moment formula.** We seek to compute an integral formula for the moments of  $Q_x(\eta(t))$ . Even if we were to solve the system of equations in Proposition 4.11(B), this would not suffice since  $\vec{x}$  is restricted to lie in  $\widetilde{W}^k$  (i.e., all  $x_i$  distinct). The extension of that solution outside  $\widetilde{W}^k$  does not have any necessary meaning as an expectation. Instead, the following lemma shows that we may recover the moments of  $Q_x$  from the formula given in Corollary 4.14 for  $\mathbb{E}[\widetilde{Q}_{x_1}(t) \cdots \widetilde{Q}_{x_k}(t)]$ . Theorem 4.20 below gives the final formula for  $\mathbb{E}[(Q_x(\eta))^n]$ .

LEMMA 4.18. *Recalling  $Q_x(\eta)$  and  $\widetilde{Q}_x(\eta)$  defined in (22), we have*

$$(44) \quad (Q_x(\eta))^n = \sum_{k=0}^n \binom{n}{k}_\tau (\tau; \tau)_k (-1)^k \sum_{x_1 < \cdots < x_k \leq x} \widetilde{Q}_{x_1}(\eta) \cdots \widetilde{Q}_{x_k}(\eta),$$

where the empty sum (when  $k = 0$ ) is defined as equal to 1.



PROOF. This lemma can be found as Proposition 3 in [19]. The derivation provided therein utilizes the  $U_q(sl_2)$  symmetry of the spin chain representation of ASEP. We provide an elementary proof.

Recall that  $Q_x(\eta)$  and  $\tilde{Q}_x(\eta)$  are functions of the occupation variables  $\eta$  and if  $\eta$  is not left-finite, then both sides above are zero.

In order to prove the identity, we develop generating functions for both sides and show that they are equal. Multiply both sides of the claimed identity by  $u^n/(\tau; \tau)_n$  and sum over  $n \geq 0$ . The  $\tau$ -binomial theorem (see Section B.1 with  $q$  replaced by  $\tau$ ) implies that the generating function for the left-hand side of (44) can be summed as

$$\sum_{n=0}^{\infty} \frac{u^n}{(\tau; \tau)_n} (Q_x(\eta))^n = \frac{1}{(uQ_x(\eta); \tau)_{\infty}}.$$

For  $|u|$  small enough, this series is convergent and it represents an analytic function of  $u$ .

Turning to the generating function for the right-hand side of (44), if  $|u|$  is sufficiently small, it is justifiable to rearrange the series in  $u$  into

$$\sum_{k=0}^{\infty} \sum_{x_1 < x_2 < \dots < x_k \leq x} (-1)^k u^k \tilde{Q}_{x_1}(\eta) \cdots \tilde{Q}_{x_k}(\eta) \sum_{n \geq k}^{\infty} \frac{u^{n-k}}{(\tau; \tau)_{n-k}}.$$

The summation over  $n \geq k$  can be evaluated as  $1/(u; \tau)_{\infty}$  and factored out. Also, the summation over  $k$  and ordered sets  $x_1 < x_2 < \dots < x_k \leq x$  can be rewritten yielding the right-hand side of (44) equals

$$\frac{\prod_{y \leq x} (1 - u\tilde{Q}_y(\eta))}{(u; \tau)_{\infty}}.$$

The above manipulations are justified as long as  $|u|$  is small enough, due to the fact that all but finitely many of the  $\tilde{Q}_y(\eta)$  are zero.

The proof now reduces to showing that

$$\frac{1}{(uQ_x(\eta); \tau)_{\infty}} = \frac{\prod_{y \leq x} (1 - u\tilde{Q}_y(\eta))}{(u; \tau)_{\infty}}.$$

This, however, is an immediate consequence of the definitions of  $Q_x(\eta)$  and  $\tilde{Q}_y(\eta)$ . To see this, assume that  $\eta_y = 0$  for all  $y \leq x$  except when  $y = n_1, \dots, n_r$ . Then  $Q_x(\eta) = \tau^r$  and the left-hand side can be written as

$$\frac{(1 - u) \cdots (1 - u\tau^{r-1})}{(u; \tau)_{\infty}}.$$

On the other hand, note that  $\tilde{Q}_y(\eta) = 0$  for all  $y \leq x$  except  $\tilde{Q}_{n_i}(\eta) = \tau^{i-1}$ . Thus, the right-hand side can also be rewritten as

$$\frac{(1 - u) \cdots (1 - u\tau^{r-1})}{(u; \tau)_{\infty}},$$

hence completing the proof of the lemma.  $\square$

For step Bernoulli initial data, using Corollary 4.14 and the symmetrization identities contained in Lemma B.2 we can evaluate part of (44) via the following result.

LEMMA 4.19. *For step Bernoulli initial data with  $\rho \in (0, 1]$  and for all  $k \geq 1$ ,*

$$\begin{aligned}
 & (\tau; \tau)_k (-1)^k \sum_{x_1 < \dots < x_k \leq x} \mathbb{E}[\tilde{Q}_{x_1}(\eta(t)) \cdots \tilde{Q}_{x_k}(\eta(t))] \\
 (45) \quad &= \frac{\tau^{k(k-1)/2}}{(2\pi i)^k} \int \cdots \int \prod_{1 \leq A < B \leq k} \frac{z_A - z_B}{z_A - \tau z_B} \prod_{i=1}^k F_{z_i}(x, t; \rho) \frac{dz_i}{z_i},
 \end{aligned}$$

where the contours of integration are all  $C_{-\tau; -1}$ .

PROOF. The starting point for this is the formula provided in Corollary 4.14 for  $\mathbb{E}[\tilde{Q}_{x_1}(\eta) \cdots \tilde{Q}_{x_k}(\eta)]$ . In that formula, set  $\xi_i = (1 + z_i)/(1 + z_i/\tau)$  and note that the contour  $C_{-\tau; -1}$  can be chosen to be a sufficiently small circle around  $-\tau$  so that  $|\xi_i| > 1$  as  $z_i$  varies in  $C_{-\tau; -1}$ . The summation over  $x_1 < \dots < x_k \leq x$  on the left-hand side of (4.19) can be brought into the integrand and is performed by using (here we rely upon  $|\xi_i| > 1$  for convergence)

$$\sum_{x_1 < \dots < x_k \leq x} \prod_{i=1}^k \xi_i^{x_i - 1} = (\xi_1 \cdots \xi_k)^x \prod_{i=1}^k \frac{1}{\xi_i \cdots \xi_i - 1}.$$

After performing the summation as above, we observe that since all contours are the same, we may symmetrize the left-hand side. For the same reason, we may symmetrize the right-hand side integrand in (45). The symmetrization is achieved by using the two combinatorial identities in Lemma B.2—identity (68) is used to symmetrize the left-hand side, while (69) is used to symmetrize the right-hand side. The two resulting symmetrized formulas are identical, thus yielding the proof.  $\square$

We may now prove the following moment formula.

THEOREM 4.20. *Fix nonnegative real numbers  $0 < p < q$  (normalized by  $p + q = 1$ ) and set all bond rate parameters  $a_x \equiv 1$ . Consider step Bernoulli initial data with density  $\rho \in (0, 1]$ . Then for all  $n \geq 1$ ,*

$$\begin{aligned}
 & \mathbb{E}[\tau^{nN_x(\eta(t))}] \\
 (46) \quad &= \mathbb{E}[(Q_x(\eta(t)))^n] \\
 &= \tau^{n(n-1)/2} \frac{1}{(2\pi i)^n} \int \cdots \int \prod_{1 \leq A < B \leq n} \frac{z_A - z_B}{z_A - \tau z_B} \prod_{i=1}^n F_{z_i}(x, t; \rho) \frac{dz_i}{z_i},
 \end{aligned}$$

where the integration contour for  $z_A$  is composed of two disconnected pieces which include  $0, -\tau$  but does not include  $-1, \tau\theta$  or  $\{\tau z_B\}_{B > A}$  (see Figure 5 for an illustration of such contours).

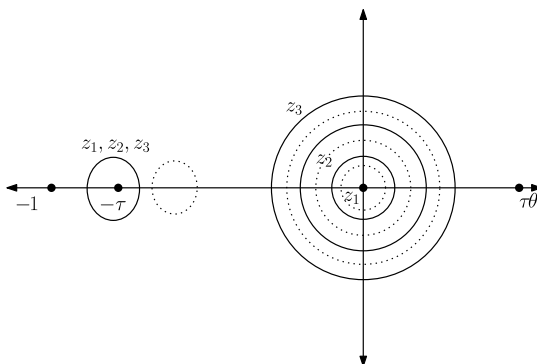

FIG. 5. The contour for  $z_A$  includes  $0, -\tau$  but does not include  $-1, \tau\theta$  or  $\{\tau z_B\}_{B>A}$ . The dotted lines represent the images of the contours under multiplication by  $\tau$ . For instance, observe that the  $z_1$  contour does not include the image under multiplication by  $\tau$  of  $z_2$  or  $z_3$ .

PROOF. The left-most equality of (46) is just by definition. The proof of the second equality relies on the following lemma. For an illustration of the types of contours involved, see Figure 5.

LEMMA 4.21. Fix  $n \geq 1$ . Assume  $f(z)$  is a meromorphic function on  $\mathbb{C}$  which has no poles in a ball around 0 and which has  $f(0) = 1$ . Let  $C^0$  be a small circle centered at 0 and  $C^1$  be another closed contour. Assume that there exists  $r > \tau^{-1}$  such that  $\tau C^1$  is not contained inside  $r^n C^0$ , and such that  $f$  has no poles inside  $r^n C^0$ . Define  $C_i^0 = r^i C^0, C_i^1 = C^1$  and  $C_i = C_i^0 \cup C_i^1$  for  $1 \leq i \leq n$ . Let

$$v_n = \frac{1}{(2\pi i)^n} \int_{C_1} \cdots \int_{C_n} \prod_{1 \leq A < B \leq n} \frac{z_A - z_B}{z_A - \tau z_B} \prod_{i=1}^n f(z_i) \frac{dz_i}{z_i}$$

and

$$\tilde{v}_k = \frac{1}{(2\pi i)^k} \int_{C^1} \cdots \int_{C^1} \prod_{1 \leq A < B \leq k} \frac{z_A - z_B}{z_A - \tau z_B} \prod_{i=1}^k f(z_i) \frac{dz_i}{z_i}$$

with the convention that  $\tilde{v}_0 = 1$ . Then

$$v_n = \sum_{k=0}^n \binom{n}{k}_\tau \tau^{(k(k-1)/2) - (n(n-1)/2)} \tilde{v}_k.$$

PROOF. In order to evaluate the integrals defining  $v_n$  we split them into  $2^n$  integrals indexed by  $S \subset \{1, \dots, n\}$  which determines which integrations are along  $C_i^0$  (all  $z_i$  with  $i \in S$ ) and which are along  $C_i^1$  (all  $z_i$  with  $i \notin S$ ). This shows that

$$v_n = \sum_{k=0}^n \sum_{\substack{S \subset \{1, \dots, n\} \\ |S|=k}} \frac{1}{(2\pi i)^n} \int_{C_1^{\epsilon_1}} \cdots \int_{C_n^{\epsilon_n}} \prod_{1 \leq A < B \leq n} \frac{z_A - z_B}{z_A - \tau z_B} \prod_{i=1}^n f(z_i) \frac{dz_i}{z_i},$$

where  $\varepsilon_i = \mathbf{1}_{i \notin S}$ ,  $1 \leq i \leq n$ . We now claim that for any  $S \subset \{1, \dots, n\}$  with  $|S| = k$ ,

$$(47) \quad \frac{1}{(2\pi i)^n} \int_{C_1^{\varepsilon_1}} \cdots \int_{C_n^{\varepsilon_n}} \prod_{1 \leq A < B \leq n} \frac{z_A - z_B}{z_A - \tau z_B} \prod_{i=1}^n f(z_i) \frac{dz_i}{z_i} = \tau^{-nk + \|S\|} \tilde{v}_{n-k},$$

where we use the notation  $\|S\| = \sum_{i \in S} i$ . Note that  $C_i^{\varepsilon_i}$  is  $C_i^0$  when  $i \in S$  and  $C_i^1$  (and hence  $C^1$ ) when  $i \notin S$ . To prove this claim, label the elements of  $S$  as  $i_1 < i_2 < \dots < i_k$ . By the fact that  $z_{i_1}$  is contained in  $\tau C_j^0$  for all  $j > i_1$ , we may shrink the  $z_{i_1}$  contour to zero without crossing any poles except at  $z_{i_1} = 0$ . The residue at that pole is  $\tau^{-(n-i_1)}$ . Then we may shrink the  $z_{i_2}$  contour to zero with contribution of  $\tau^{-(n-i_2)}$ . Repeating this up to  $z_{i_k}$  yields a factor of

$$\prod_{j=1}^k \tau^{-(n-i_j)} = \tau^{-nk + \|S\|}.$$

The remaining integration variables can be relabeled so as to yield the expression for  $\tilde{v}_{n-k}$ .

By using (47), we find that

$$\begin{aligned} v_n &= \sum_{k=0}^n \sum_{\substack{S \subset \{1, \dots, n\} \\ |S|=k}} \tau^{-nk + \|S\|} \tilde{v}_{n-k} \\ &= \sum_{k=0}^n \tilde{v}_{n-k} \tau^{-nk + (k(k+1)/2)} \sum_{\substack{S \subset \{1, \dots, n\} \\ |S|=k}} \tau^{\|S\| - (k(k+1)/2)} \\ &= \sum_{k=0}^n \tilde{v}_{n-k} \tau^{-nk + (k(k+1)/2)} \binom{n}{k}_\tau \\ &= \sum_{k=0}^n \binom{n}{k}_\tau \tau^{(k(k-1)/2) - (n(n-1)/2)} \tilde{v}_k \end{aligned}$$

as desired. From the first line to second line is by factoring. The second line to third is by (63). The third line to fourth line is via changing  $k$  to  $n - k$ .  $\square$

We return now to the proof of Theorem 4.20. Consider the second equality in (46). By virtue of the conditions imposed on the contours, we may apply Lemma 4.21 with  $f(z) = F_z(x, t; \rho)$  and  $C_i$  chosen to match the contours defined in Theorem 4.20. This shows that

$$(48) \quad \begin{aligned} \text{RHS of (46)} &= \sum_{k=0}^n \binom{n}{k}_\tau \tau^{k(k-1)/2} \frac{1}{(2\pi i)^k} \\ &\quad \times \int \cdots \int \prod_{1 \leq A < B \leq k} \frac{z_A - z_B}{z_A - \tau z_B} \prod_{i=1}^k F_{z_i}(x, t; \rho) \frac{dz_i}{z_i}, \end{aligned}$$

where the integration contours are  $C_{-\tau; -1}$  (which coincide with  $C^1$  from Lemma 4.21). By Lemma 4.19, we rewrite (48) as

$$\text{RHS of (46)} = \sum_{k=0}^n \binom{n}{k}_\tau (\tau; \tau)_k (-1)^k \sum_{x_1 < \dots < x_k \leq x} \tilde{Q}_{x_1} \cdots \tilde{Q}_{x_k},$$

where the empty sum (when  $k = 0$ ) is defined as equal to 1. Lemma 4.18 implies that this expression equals  $\mathbb{E}[(Q_x)^n]$ , proving the theorem.  $\square$

**5. From nested contour integrals to Fredholm determinants for ASEP.**

Using the nested contour integral formula of Theorem 4.20 for  $\mathbb{E}[\tau^{nN_x(\eta(t))}]$  under step-Bernoulli initial data for ASEP, we prove Mellin–Barnes and Cauchy-type Fredholm determinant formulas for the  $e_\tau$ -Laplace transform of  $\tau^{N_x(\eta(t))}$ . This transform characterizes the distribution of  $N_x(\eta(t))$  and is the starting point for asymptotic analysis. The Mellin–Barnes-type formula we discover is new. The Cauchy-type formula is, after inverting the  $e_\tau$ -Laplace transform, equivalent to Tracy and Widom’s ASEP formula for step Bernoulli [41] initial data (see also [38, 39] for step initial data where  $\rho = 1$ ).

The route from the nested contour integral of Theorem 4.20 to the Fredholm determinants is similar to what was outlined in Section 3.1 (for the Mellin–Barnes-type) and Section 3.2 (for the Cauchy-type). There are, however, some differences due to the nature of the nested contours. For  $q$ -TASEP the integration contour for  $z_A$  was on a single connected contour and the set of such contours (as  $A$  varied) was nested so that the  $z_A$  contour contained  $\{qz_B\}_{B>A}$ . For ASEP, the integration contour for  $z_A$  is the union of two contours and the set of such contours (as  $A$  varies) is chosen such that the  $z_A$  contour *does not* contain  $\{qz_B\}_{B>A}$ . This difference in contours necessitates an analogous result to Proposition 3.2 (given below as Proposition 5.2) when developing the Mellin–Barnes-type formula, and an analogous result to Proposition 3.8 (given via the combination of Lemmas 4.18 and 4.19 above) when developing the Cauchy-type formula.

5.1. *Mellin–Barnes-type determinant.*

DEFINITION 5.1. Fix  $\alpha \in \mathbb{C} \setminus \{0\}$  and consider a meromorphic function  $f(z)$  which has a pole at  $\alpha$  but does not have any other poles in an open neighborhood of the line segment connecting  $\alpha$  to 0. For such a function and for any  $k \geq 1$ , define

$$(49) \quad \mu_k = \frac{\tau^{k(k-1)/2}}{(2\pi i)^k} \int \cdots \int \prod_{1 \leq A < B \leq k} \frac{z_A - z_B}{z_A - \tau z_B} \prod_{i=1}^k f(z_i) \frac{dz_i}{z_i},$$

where the integration contour for  $z_A$  contains 0,  $\alpha$  but does not include any other poles of  $f$  or  $\{\tau z_B\}_{B>A}$ . For instance, when  $f$  is as in (36) and  $\alpha = -\tau$ , then the contours illustrated in Figure 5 suffice (for  $k = 3$ ).

PROPOSITION 5.2. We have that for  $\mu_k$  as in Definition 5.1,

$$\begin{aligned}
 \mu_k = k_\tau! & \sum_{\substack{\lambda \vdash k \\ \lambda = 1^{m_1} 2^{m_2} \dots}} \frac{1}{m_1! m_2! \dots} \frac{(1 - \tau)^k}{(2\pi i)^{\ell(\lambda)}} \\
 (50) \quad & \times \int_C \dots \int_C \det \left[ \frac{-1}{w_i \tau^{\lambda_i} - w_j} \right]_{i,j=1}^{\ell(\lambda)} \\
 & \times \prod_{j=1}^{\ell(\lambda)} f(w_j) f(\tau w_j) \dots f(\tau^{\lambda_j - 1} w_j) dw_j,
 \end{aligned}$$

where the integration contour  $C$  for  $w_j$  contains  $0, \alpha$  and no other poles of  $f$ , and it does not intersect its image under multiplication by any positive power of  $\tau$  (see Figure 6).

PROOF. The proof is via residue calculus and follows in the same manner as Proposition 3.2, whose proof is found in [9] as Proposition 3.2.1. Rather than repeating that proof, we just illustrate the  $k = 2$  case.

Consider  $\mu_2$  as in Definition 5.1 with contours like in Figure 5. Initially, the  $z_1$  contour is chosen so as not to contain  $\tau z_2$ . Because the contours include  $\alpha$  and  $0$ , they must be composed of two disjoint closed parts. Around  $\alpha$ , the contours can be the same small circle, but around  $0$ , the  $z_2$  contour must have radius which is at least  $\tau^{-1}$  times that of the  $z_1$  contour. For  $k = 2$ , such a contour is given in Figure 7(A). We may freely (without crossing any poles) deform the  $z_2$  contour to a single circle  $C$  enclosing  $0$  and  $\alpha$  (but no poles of  $f$ ). Such a resulting contour is given in Figure 7(B). The integration in  $z_1$  and  $z_2$  may be taken sequentially, so that for each fixed value of  $z_2$  along its contour of integration, we perform the integral in  $z_1$ . Thinking of  $z_2$  as fixed, we see that the  $z_1$  contour can be deformed to the circle  $C$  by crossing a single pole at  $z_1 = \tau z_2$ . This shown in Figure 7(C) and (D).

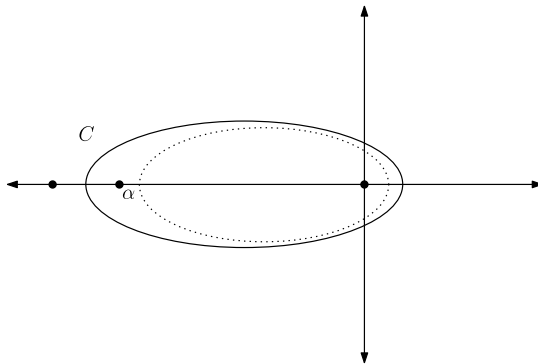

FIG. 6. The contour  $C$  is chosen so as to contain  $0, \alpha$  and no other poles of  $f$  (such as the one indicated with a black dot to the left of  $\alpha$ ).

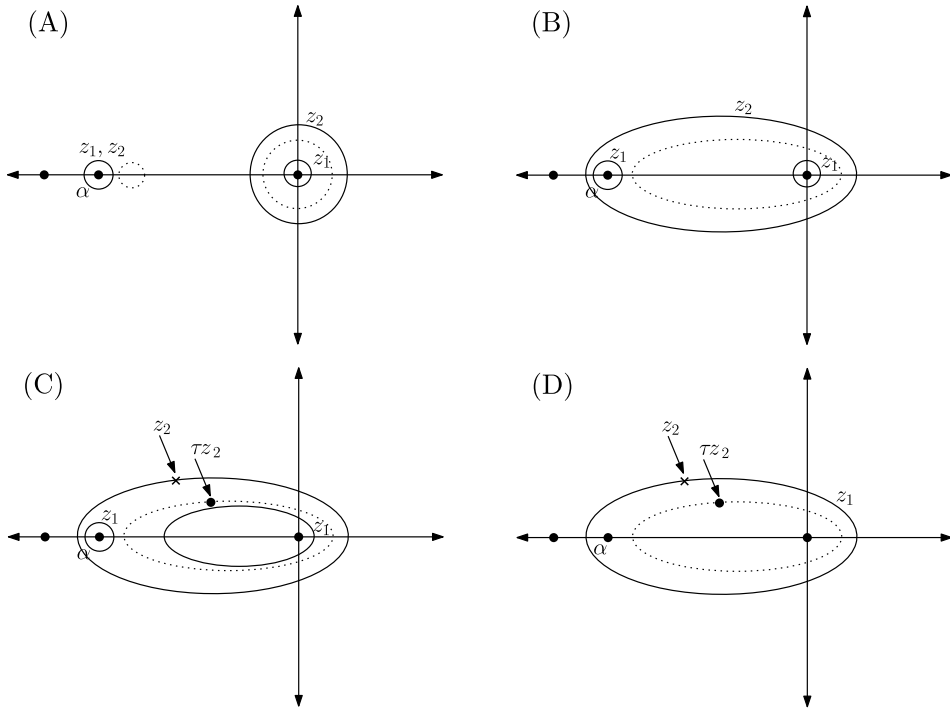

FIG. 7. (A): Both contours contain 0 and  $\alpha$ , but the  $z_1$  contour must not contain  $\tau z_2$  (and neither contour may contain any other poles such as the one indicated by the black dot to the right of  $\alpha$ ). (B) The  $z_2$  contour may freely (without crossing poles) be deformed to a single circle containing 0 and  $\alpha$ . (C) For  $z_2$  fixed along that circle, the  $z_1$  contour can be deformed and only picks a pole when crossing the point  $\tau z_2$ . (D) After crossing that pole, the  $z_1$  contour can be freely deformed to the same contour on which  $z_2$  is integrated.

On account of crossing a pole, we find that  $\mu_2$  can be expressed as

$$\begin{aligned} \mu_2 &= \frac{\tau}{(2\pi i)^2} \int_C \int_C \frac{z_1 - z_2}{z_1 - \tau z_2} f(z_1) f(z_2) \frac{dz_1}{z_1} \frac{dz_2}{z_2} \\ &\quad - \frac{1}{2\pi i} \int_C (\tau - 1) f(\tau z_2) f(z_2) \frac{dz_2}{z_2}. \end{aligned}$$

Observe that there are also two terms contained in the right-hand side of (50)—one term is a single integral and one is a double integral. The single integral term matches exactly while to match the double integral we simply symmetrize the integrand (as can be done since  $z_1$  and  $z_2$  are on the same contour) and find those terms match as well. In general, the partition  $\lambda$  indexes the clustering of residues into chains.  $\square$

Using the above result as well as Proposition 3.3, we find following Fredholm determinant formula for the  $e_\tau$ -Laplace transform of  $Q_x(\eta(t)) = \tau^{N_x(\eta(t))}$ .

**THEOREM 5.3.** *Consider ASEP with  $0 < p < q$  (normalized by  $p + q = 1$ ), all bond rate parameters  $a_x \equiv 1$ , and step Bernoulli initial data with density parameter  $\rho \in (0, 1]$ . Then with notation  $\theta = \frac{\rho}{1-\rho}$  we have that for all  $\zeta \in \mathbb{C} \setminus \mathbb{R}_+$ ,*

$$\mathbb{E}\left[\frac{1}{(\zeta \tau^{N_x(\eta(t))}; \tau)_\infty}\right] = \det(I + K_\zeta^{\text{ASEP}}),$$

where  $\det(I + K_\zeta^{\text{ASEP}})$  is the Fredholm determinant of  $K_\zeta^{\text{ASEP}} : L^2(C_{0,-\tau;-1,\tau\theta}) \rightarrow L^2(C_{0,-\tau;-1,\tau\theta})$ , where  $C_{0,-\tau;-1,\tau\theta}$  a positively oriented contour containing  $0, -\tau$  on its interior and with  $-1$  and  $\tau\theta$  on its exterior. The operator  $K_\zeta$  is defined in terms of its integral kernel

$$K_\zeta^{\text{ASEP}}(w, w') = \frac{1}{2\pi i} \int_{D_{R,d}} \Gamma(-s)\Gamma(1+s)(-\zeta)^s \frac{g_w(x, t; \rho)}{g_{\tau^s w}(x, t; \rho)} \frac{-1}{\tau^s w - w'} ds.$$

The contour  $D_{R,d}$  is given in Definition 3.5 with  $d > 0$  taken to be sufficiently small and  $R > 0$  sufficiently large so that

$$\inf_{\substack{w, w' \in C_{0,-\tau;-1,\tau\theta} \\ s \in D_{R,d}}} |q^s w - w'| > 0 \quad \text{and} \quad \sup_{\substack{w, w' \in C_{0,-\tau;-1,\tau\theta} \\ s \in D_{R,d}}} \left| \frac{g(w)}{g(q^s w)} \right| < \infty.$$

The function  $g_z(x, t; \rho)$ , is given by

$$(51) \quad g_z(x, t; \rho) = \exp\left[(q - p)t \frac{\tau}{z + \tau}\right] \left(\frac{\tau}{z + \tau}\right)^x \frac{1}{(z/(\tau\theta); \tau)_\infty}.$$

**COROLLARY 5.4.** *We have that*

$$\mathbb{P}(N_x(\eta(t)) = m) = \frac{-\tau^m}{2\pi i} \int (\tau^{m+1}\zeta; \tau)_\infty \det(I + K_\zeta^{\text{ASEP}}) d\zeta,$$

where the contour of integration encloses  $\zeta = \tau^{-M}$  for  $0 \leq M \leq m$  and only intersects  $\mathbb{R}_+$  in finitely many points.

**PROOF.** This follows almost immediately from the inversion formula in Proposition B.1. The one small impediment is that our formula for the  $q$ -Laplace transform via the Fredholm determinant  $\det(I + K_\zeta^{\text{ASEP}})$  is not defined for  $\zeta \in \mathbb{R}_+$ . On the other hand, it is easy to see (and explained in the proof of Theorem 5.3) that the function  $f(\zeta)$  defined by  $\zeta \mapsto \mathbb{E}[1/(\zeta \tau^{N_x(\eta(t))}; \tau)_\infty]$  is analytic away from  $\zeta = \tau^{-M}$ , for integers  $M \geq 0$ . Thus  $\mathbb{P}(N_x(\eta(t)) = m)$  can be computed via a contour integral (as specified in the inversion formula) involving  $f(\zeta)$  in the integrand.

On the other hand, we know that  $f(\zeta) = \det(I + K_\zeta^{\text{ASEP}})$  for  $\zeta$  not on  $\mathbb{R}_+$ , and hence  $\det(I + K_\zeta^{\text{ASEP}})$  extends analytically through  $\mathbb{R}_+ \setminus \{\tau^{-M}\}_{M \geq 0}$ . Thus, as long as the integration contour for  $\zeta$  only intersects  $\mathbb{R}_+$ , in finitely many points, we can compute the necessary inversion contour integral with  $f(\zeta)$  replaced by  $\det(I + K_\zeta^{\text{ASEP}})$ .  $\square$



PROOF OF THEOREM 5.3. Theorem 4.20 gives a nested contour integral formula for  $\mathbb{E}[\tau^{kN_x(\eta(t))}]$ . Comparing it with Definition 5.1 we see that  $\mu_k = \mathbb{E}[\tau^{kN_x(\eta(t))}]$  if the contour is chosen as the one in Theorem 4.20 and if  $f(z) = F_z(x, t; \rho)$ . This function can be written as  $f(z) = g(z)/g(\tau z)$  where  $g(z) = g_z(x, t; \rho)$ , is given in (51).

We apply Proposition 5.2, yielding an expression for  $\mu_k$  as in (50). This matches the expression in (14) up to changing  $q$  to  $\tau$  and sign inside the determinant. We may therefore apply Proposition 3.3, followed by Proposition 3.6 (with  $q$  replaced by  $\tau$ ). At a formal level, this shows that

$$(52) \quad \sum_{k \geq 0} \mu_k \frac{\xi^k}{k_\tau!} = \det(I + K_\xi^1) = \det(I + K_\xi^2)$$

the kernels  $K_\xi^1$  and  $K_\xi^2$  defined with respect to  $F_z(x, t; \rho)$  and  $g_z(x, t; \rho)$ , as above. The contour  $C_\mathbb{A}$  in those propositions should be taken to be  $C_{0, -\tau; -1, \tau\theta}$ , as in the hypothesis of Theorem 5.3. In applying Proposition 3.6, the contour  $C_{1, 2, \dots}$  should be chosen to be  $D_{R, d}$  with  $d > 0$  sufficiently small, and  $R > 0$  sufficiently large, and the contours  $C_k, k \geq 1$  should be chosen to be  $D_{R, d; k}$ . From the definition of  $C_{0, -\tau; -1, \tau\theta}$  and  $g_z(x, t; \rho)$ , it is easy to check that as long as  $|\xi|$  is sufficiently small, the criteria for these to be numerical equalities is satisfied.

Since by definition  $N_x(\eta(t)) \geq 0$  and  $\tau < 1$ , it is immediate that  $\tau^{kN_x(\eta(t))} < 1$ . Hence, considering the left-hand side of (52), by choosing  $|\xi|$  small enough it is justifiable to interchange the summation in  $k$  and the expectation. By the  $\tau$ -Binomial theorem (see Section B.1), we find

$$(53) \quad \mathbb{E} \left[ \frac{1}{((1 - \tau)\xi \tau^{N_x(\eta(t))}; \tau)_\infty} \right] = \det(I + K_\xi^2).$$

This equality holds for all  $|\xi|$  sufficiently small. However, the right-hand side is analytic in  $\xi \notin \mathbb{R}_+$  due to Proposition 3.6. From the definition of the left-hand side,

$$\mathbb{E} \left[ \frac{1}{((1 - \tau)\xi \tau^{N_x(\eta(t))}; \tau)_\infty} \right] = \sum_{\ell=0}^\infty \frac{\mathbb{P}(N_x(\eta(t)) = \ell)}{((1 - \tau)\xi \tau^\ell; \tau)_\infty}.$$

For any  $\xi \notin \{(1 - \tau)^{-1} \tau^{-M}\}_{M=0, 1, \dots}$ , within a neighborhood of  $\xi$  the infinite products are uniformly convergent and bounded away from zero. As a result, the series is uniformly convergent in a neighborhood of any such  $\xi$  which implies that its limit is analytic. Therefore, both sides of (53) are analytic for  $\xi \notin \mathbb{R}_+$  and hence by uniqueness of the analytic continuation they are equal on this set.

The desired result for this theorem is achieved by setting  $\xi = (1 - \tau)^{-1} \zeta$  thus completing the proof.  $\square$

5.2. Cauchy-type determinant.

**THEOREM 5.5.** Consider ASEP with  $0 < p < q$  (normalized by  $p + q = 1$ ), all bond rate parameters  $a_x \equiv 1$ , and step Bernoulli initial data with density parameter  $\rho \in (0, 1]$ . Then with notation  $\theta = \frac{\rho}{1-\rho}$  we have that for all  $\zeta \in \mathbb{C}$

$$(54) \quad \mathbb{E} \left[ \frac{1}{(\zeta \tau^{N_x(\eta(t)); \tau})_\infty} \right] = \frac{\det(I - \zeta \tilde{K}^{\text{ASEP}})}{(\zeta; \tau)_\infty},$$

where  $\det(I - \zeta \tilde{K}^{\text{ASEP}})$  is an entire function of  $\zeta$  and is the Fredholm determinant of  $\tilde{K}^{\text{ASEP}} : L^2(C_{-\tau; -1}) \rightarrow L^2(C_{-\tau; -1})$  defined in terms of its integral kernel

$$\tilde{K}^{\text{ASEP}}(w, w') = \frac{F_w(x, t; \rho)}{\tau w - w'}$$

with  $F_w(x, t; \rho)$  defined in (36), and  $C_{-\tau; -1}$  is a circle around  $-\tau$ , chosen with small enough radius so that  $-1$  is not included, and nor is the image of the circle under multiplication by  $\tau$  (see Definition 4.12).

**COROLLARY 5.6.** Consider ASEP with  $0 < p < q$  (normalized by  $p + q = 1$ ), all bond rate parameters  $a_x \equiv 1$ , and step Bernoulli initial data with density parameter  $\rho \in (0, 1]$ . Then

$$(55) \quad \mathbb{P}(N_x(\eta(t)) = m) = -\tau^m \frac{1}{2\pi i} \int \frac{\det(I - \zeta \tilde{K}^{\text{TW-ASEP}})}{(\zeta; \tau)_{m+1}} d\zeta,$$

where the integral is over a contour enclosing  $\zeta = q^{-M}$  for  $0 \leq M \leq m - 1$ . Here,  $\det(I - \zeta \tilde{K}^{\text{TW-ASEP}})$  is the Fredholm determinant of  $\tilde{K}^{\text{TW-ASEP}} : L^2(C_R) \rightarrow L^2(C_R)$  defined in terms of its integral kernel

$$\tilde{K}^{\text{TW-ASEP}}(\xi, \xi') = q \frac{\xi^x e^{\varepsilon(\xi)t}}{p + q\xi\xi' - \xi} \frac{\rho(\xi - \tau)}{\xi - 1 + \rho(1 - \tau)}$$

and  $\varepsilon(\xi) = p\xi^{-1} + q\xi - 1$  and  $C_R$  is a circle around zero of radius  $R$  so large that the denominator  $p + q\xi\xi' - \xi$  and  $\xi - 1 + \rho(1 - \tau)$  are nonzero on and outside the contour. As a function of  $\zeta$ ,  $\det(I - \zeta \tilde{K}^{\text{TW-ASEP}})$  is entire.

**PROOF.** This follows from Theorem 5.5 (after a change of variables) and the  $e_\tau$ -Laplace transform inversion formula in Proposition B.1. The change of variables is

$$\xi = \frac{1 + w}{1 + w/\tau}.$$

Using the equivalences given in Remark B.3, and using the definition of  $\theta = \rho/(1 - \rho)$  we find that

$$f(w) \mapsto e^{\varepsilon(\xi)\xi^x} \frac{\rho(\xi - \tau)}{\xi - 1 + \rho(1 - \tau)}.$$

Similarly, we find

$$\frac{1}{\tau w - w'} \mapsto \frac{(\tau - \xi)(\tau - \xi')}{\tau(1 - \tau)} \frac{q}{(p + q\xi\xi' - \xi)}.$$

The change of variables introduces an additional Jacobian factor into the new kernel which is given by

$$\frac{-\tau(1 - \tau)}{(\tau - \xi)(\tau - \xi')}.$$

Finally, under this change of variables, the contour  $C_{-\tau; -1}$  becomes  $C_R$  as specified in the statement of the corollary, but with clockwise orientation. Changing this to the standard counterclockwise orientation introduces a factor of  $-1$  into the kernel. Combining these calculations, we find

$$\mathbb{E} \left[ \frac{1}{(\zeta \tau^{N_x(\eta(t)); \tau})_\infty} \right] = \frac{\det(I - \zeta \tilde{K}^{\text{TW-ASEP}})}{(\zeta; \tau)_\infty},$$

where  $\tilde{K}^{\text{TW-ASEP}}$  is as in the statement of the corollary.

From Proposition B.1, it follows that

$$\begin{aligned} \mathbb{P}(N_x(\eta(t)) = m) &= -\tau^m \frac{1}{2\pi i} \int (\tau^{m+1} \zeta; \tau)_\infty \frac{\det(I - \zeta \tilde{K}^{\text{TW-ASEP}})}{(\zeta; \tau)_\infty} d\zeta \\ &= -\tau^m \frac{1}{2\pi i} \int \frac{\det(I - \zeta \tilde{K}^{\text{TW-ASEP}})}{(\zeta; \tau)_{m+1}} d\zeta, \end{aligned}$$

where the integral is taken over a contour enclosing  $\zeta = q^{-M}$  for  $0 \leq M \leq m - 1$ , thus proving the corollary.  $\square$

REMARK 5.7. For ASEP with step-Bernoulli initial data, Tracy and Widom [41] (for step initial data see [38, 39]) arrive at a very similar formula which says

$$(56) \quad \mathbb{P}(N_x(\eta(t)) \geq m) = \frac{1}{2\pi i} \int \frac{\det(I - \zeta \tilde{K}^{\text{TW-ASEP}})}{(\zeta; \tau)_m} \frac{d\zeta}{\zeta},$$

where the integral is taken over a contour enclosing  $\zeta = 0$  and  $\zeta = q^{-M}$  for  $0 \leq M \leq m - 1$ . Since  $\mathbb{P}(N_x(\eta(t)) \geq m) - \mathbb{P}(N_x(\eta(t)) \geq m + 1) = \mathbb{P}(N_x(\eta(t)) = m)$ , it is straightforward to go from (56) to (55) since

$$\frac{1}{(\zeta; \tau)_m \zeta} - \frac{1}{(\zeta; \tau)_{m+1} \zeta} = -\tau^m \frac{1}{(\zeta; \tau)_{m+1}}.$$

Going in the reverse direction uses a telescoping sum and would require an a priori confirmation that the right-hand side of (56) goes to zero as  $m$  goes to infinity.

PROOF OF THEOREM 5.5. Let  $\tilde{\mu}_k$  be given as in (16) with  $f(w) = F_w(x, t; \rho)$  defined by (36) and contour  $C_{-\tau; -1}$  as in Definition 4.12. Then Proposition 3.10 and Remark 3.11 imply that

$$(57) \quad \sum_{k \geq 0} \tilde{\mu}_k \frac{\xi^k}{k_\tau!} = \det(I + \xi \tilde{K}),$$

where  $\det(I + \xi \tilde{K})$  is the Fredholm determinant of

$$\tilde{K}(w, w') = (1 - \tau) \frac{f(w)}{\tau w - w'}.$$

We need to check that this is a numerical equality (not just formal). Because the kernel is bounded as  $w$  varies along  $\tilde{C}_{-\tau}$  it follows that  $\tilde{K}$  is trace-class, and hence  $\det(I + \xi \tilde{K})$  is an entire function of  $\xi$ .

In order to see that the left-hand side is uniformly convergent for small enough  $|\xi|$ , we utilize the probabilistic interpretation for  $\tilde{\mu}$ . By combining Lemmas 4.18 and 4.19, we find that

$$\mathbb{E}[\tau^{nN_x(\eta(t))}] = \sum_{k=0}^n \binom{n}{k}_\tau (-1)^k \tilde{\mu}_k.$$

This transformation from  $\tilde{\mu}_k$  to  $\mathbb{E}[\tau^{nN_x(\eta(t))}]$  is upper-triangular, and hence can be inverted. One checks that the inverse is given by

$$(-1)^k \tilde{\mu}_k = (-1)^k \tau^{k(k-1)/2} \sum_{j=0}^k \binom{k}{j}_{\tau^{-1}} \tau^{-j(j-1)/2} (-1)^j \mathbb{E}[\tau^{jN_x(\eta(t))}].$$

By (65), we find

$$\begin{aligned} (-1)^k \tilde{\mu}_k &= (-1)^k \tau^{k(k-1)/2} \mathbb{E}[(1 - \tau^{N_x(\eta(t))}) \dots (1 - \tau^{N_x(\eta(t))-k})] \\ &= \mathbb{E}[(\tau^{N_x(\eta(t))} - 1)(\tau^{N_x(\eta(t))} - \tau) \dots (\tau^{N_x(\eta(t))} - \tau^k)]. \end{aligned}$$

This probabilistic interpretation of  $\tilde{\mu}_k$  implies that  $|\tilde{\mu}_k| \leq 1$ , hence for  $|\xi|$  small enough the series on the left-hand side of (57) is convergent and the equality is numerical.

By replacing  $\xi = -\zeta/(1 - \tau)$  and using the probabilistic interpretation for  $\tilde{\mu}_k$  to justify the exchange of summation and expectation (assuming  $|\zeta|$  small enough) this left-hand side series equals

$$\begin{aligned} \sum_{k \geq 0} \tilde{\mu}_k \frac{(-\zeta/(1 - \tau))^k}{k_\tau!} &= \mathbb{E} \left[ \sum_{k \geq 0} \frac{(\tau^{-N_x(\eta(t))}; \tau)_k}{(\tau; \tau)_k} (\zeta \tau^{N_x(\eta(t))})^k \right] \\ &= \mathbb{E} \left[ \frac{(\zeta; \tau)_\infty}{(\zeta \tau^{N_x(\eta(t))}; \tau)_\infty} \right]. \end{aligned}$$

Since we already wrote down the Fredholm determinant for this expression in (57), this establishes the claimed result of the theorem, for  $|\zeta|$  small enough.

Finally, note that

$$\mathbb{E} \left[ \frac{(\zeta; \tau)_\infty}{(\zeta \tau^{N_x(\eta(t)); \tau)_\infty} \right] = \sum_{k \geq 0} \mathbb{P}(N_x(\eta(t)) = k) (\zeta; \tau)_k.$$

For any  $\zeta \in \mathbb{C}$  and any compact neighborhood  $\Omega$  of  $\zeta$ , it is clear at as  $k \rightarrow \infty$ , the product defining  $(\zeta; \tau)_k$  converges uniformly over  $\Omega$  to a finite limit. This implies that the series is likewise uniformly convergent in that compact neighborhood and, therefore, the series is analytic in a neighborhood of  $\zeta$ . As  $\zeta$  was arbitrary, this implies that the left-hand side of (54) is an entire function of  $\zeta$ . We showed earlier that the right-hand side is entire, therefore, since the two functions of  $\zeta$  are equal for  $|\zeta|$  small enough, by the uniqueness of analytic continuations it follows that the equality holds for all  $\zeta \in \mathbb{C}$ , completing the proof.  $\square$

### APPENDIX A: SEMIDISCRETE DIRECTED POLYMERS

There are three main parameters in  $q$ -TASEP: time  $t$ , particle label  $n$  and the repulsion strength  $q$  (the  $a_i$  are also present, but play a somewhat auxiliary role). On account of this, there are many interesting scaling limits to be explored. We will presently focus on one which involves scaling  $q \rightarrow 1$  and  $t \rightarrow \infty$ , but keeping  $n$  fixed. We show that the limit of  $q$ -TASEP corresponds to a certain semidiscrete version of the multiplicative stochastic heat equation (and hence also the O’Connell–Yor semidiscrete directed polymer partition function [29]). We then introduce the limit of the  $q$ -TASEP free evolution equation with  $k - 1$  boundary conditions and the Schrödinger equation with Bosonic Hamiltonian [Proposition 2.7(B) and (C)] and show how these limits are achieved from the analogous statement for  $q$ -TASEP. Finally, we remark on the fact that taking a limit of the Mellin–Barnes-type Fredholm determinant formula for the  $e_q$ -Laplace transform of  $q$ -TASEP yields a rigorous derivation of an analogous formula for the Laplace transform of the solution to the semidiscrete multiplicative stochastic heat equation.

From this semidiscrete limit, it is possible to take another limit to the fully continuous (space–time) multiplicative stochastic heat equation [1]. The free evolution equation with  $k - 1$  boundary conditions and the Schrödinger equation with Bosonic Hamiltonian limit to the two different formulations of the attractive quantum delta Bose gas.

**DEFINITION A.1.** The semidiscrete multiplicative stochastic heat equation (SHE) with initial data  $z_0$  and drift vector  $\tilde{a} = (\tilde{a}_1, \dots, \tilde{a}_N)$  is the solution to the system of stochastic ODEs

$$dz(\tau, n) = \nabla z(\tau, n) d\tau + z(\tau, n) dB_n, \quad z(0, n) = z_0(n), \quad z(\tau, 0) \equiv 0,$$

where  $(B_1(s), \dots, B_N(s))$  are independent standard Brownian motions such that  $B_i$  has drift  $\tilde{a}_i$ , and we use the notation  $\nabla z(\tau, n) = z(\tau, n - 1) - z(\tau, n)$ .

There is a Feynman–Kac path integral representation for  $z(\tau, n)$ . Let  $\phi$  be a Markov process with state space  $\mathbb{Z}$  which increases by one at rate one (this is a standard Poisson jump process whose generator is the adjoint of  $\nabla$ ). Let  $\mathcal{E}$  denote the expectation with respect to this path measure on  $\phi$ . Define the energy of  $\phi$  as the path integral through the disorder (the white noises given by  $dB_i$ ) along  $\phi$ :

$$E_\tau(\phi) = \int_0^\tau dB_{\phi(s)} ds.$$

Also write:  $E_\tau(\phi)$ : for  $E_\tau(\phi) - \frac{\tau}{2}$ . Then

$$(58) \quad z(\tau, n) = \mathcal{E}^{\phi(\tau)=n} [e^{E_\tau(\phi)} z_0(\phi(0))].$$

This path integral is essentially the O’Connell–Yor semidiscrete directed polymer partition function [29].

**A.1. Semidiscrete limit of  $q$ -TASEP dynamics.** We now show how  $q$ -TASEP rescales to the semidiscrete SHE. We state the result for step initial data and then provide a scaling argument which makes clear the correspondence for general initial data. For the below proposition, let  $C([0, T], \mathbb{R}^N)$  represent the space of functions from  $[0, T]$  to  $\mathbb{R}^N$  endowed with the topology of uniform convergence on compact subsets.

PROPOSITION A.2. Consider  $q$ -TASEP started from step initial data and scaled according to

$$(59) \quad \begin{aligned} q &= e^{-\varepsilon}, & a_i &= e^{-\varepsilon \tilde{a}_i}, & t &= \varepsilon^{-2} \tau, \\ x_n(t) &= \varepsilon^{-2} \tau - (n - 1) \varepsilon^{-1} \log \varepsilon^{-1} - \varepsilon^{-1} F_\varepsilon^n(\tau). \end{aligned}$$

Let  $z_\varepsilon(\tau, n) = \exp(-\frac{3\tau}{2} + F_\varepsilon^n(\tau))$ . Then for any  $N \geq 1, T > 0$ , as  $\varepsilon \rightarrow 0$ , the law of the stochastic process  $\{z_\varepsilon(\tau, n) : \tau \in [0, T], 1 \leq n \leq N\}$  converges in the topology of measures on  $C([0, T], \mathbb{R}^N)$  to a limit given by the law of  $\{z(\tau, n) : \tau \in [0, T], 1 \leq n \leq N\}$  where  $z(\tau, n)$  solves the semidiscrete SHE with drift vector  $\tilde{a} = (\tilde{a}_1, \dots, \tilde{a}_N)$  and initial data  $z_0(n) = \delta_{n=1}$ .

This result is a corollary of [9] Theorem 4.1.26 which deals with a larger two-dimensional extension of  $q$ -TASEP and its limit. That result is not entirely elementary as it relies upon the convergence of  $q$ -Whittaker processes to Whittaker processes [9] as well as the relationship of Whittaker processes to the semidiscrete directed polymer [28]. We will presently provide a purely probabilistic sketch of why this result is true, without making any attempt to fill in the details of rigorous justifications.

It is easy to check the initial data. Observe that via the scalings,  $z_\varepsilon(0, n) = \varepsilon^{n-1} e^{\varepsilon n}$ . Hence, if  $n > 1$  the limit is 0, whereas for  $n = 1$  the limit is 1. This shows

that as  $\varepsilon \rightarrow 0$ ,  $z_\varepsilon(0, n) \rightarrow \delta_{n=1}$ . To achieve a general initial data  $z_0$ , one should scale  $x_n(0)$  so that  $\varepsilon^{n-1}e^{-\varepsilon x_n(0)} \rightarrow z_0(n)$ .

To see how the dynamics behave under scaling, it is easiest to work in terms of  $F_\varepsilon^n(\tau)$ . Observe that

$$\begin{aligned} dF_\varepsilon^n(\tau) &= F_\varepsilon^n(\tau) - F_\varepsilon^n(\tau - d\tau) \\ &= (\varepsilon^{-1}\tau - (n - 1) \log \varepsilon^{-1} - \varepsilon x_n(\varepsilon^{-2}\tau)) \\ &\quad - (\varepsilon^{-1}(\tau - d\tau) - (n - 1) \log \varepsilon^{-1} - \varepsilon x_n(\varepsilon^{-2}\tau - \varepsilon^{-2}d\tau)) \\ &= \varepsilon^{-1}d\tau - \varepsilon(x_n(\varepsilon^{-2}\tau) - x_n(\varepsilon^{-2}\tau - \varepsilon^{-2}d\tau)). \end{aligned}$$

The jump rate for  $q$ -TASEP, in the rescaled variables, is given by

$$a_n(1 - q^{x_{n-1}(t) - x_n(t) - 1}) = 1 - \varepsilon(\tilde{a}_n + e^{F_\varepsilon^{n-1}(\tau) - F_\varepsilon^n(\tau)}) + O(\varepsilon^2).$$

This means that in an increment of time  $\varepsilon^{-2}d\tau$ , we should see that

$$\varepsilon(x_n(\varepsilon^{-2}\tau) - x_n(\varepsilon^{-2}\tau - \varepsilon^{-2}d\tau)) = \varepsilon^{-1} - (\tilde{a}_n + e^{F_\varepsilon^{n-1}(\tau) - F_\varepsilon^n(\tau)})d\tau + dW_n + o(1),$$

where the  $W_n$  are independent Brownian motions which arise from the approximation of a Poisson process by a Brownian motion. Setting  $B_n = \tilde{a}_n - W_n$  (a Brownian motion with drift  $\tilde{a}_n$  now), we find that

$$dF_\varepsilon^n(\tau) = e^{F_\varepsilon^{n-1}(\tau) - F_\varepsilon^n(\tau)} + dB_n + o(1).$$

By Itô’s lemma,

$$d \exp(F_\varepsilon^n(\tau)) = \left(\frac{1}{2} \exp(F_\varepsilon^n(\tau)) + \exp(F_\varepsilon^{n-1}(\tau))\right) d\tau + \exp(F_\varepsilon^n(\tau)) dB_n + o(1)$$

and hence rewriting this in terms of  $z_\varepsilon(\tau, n)$  we have

$$dz_\varepsilon(\tau, n) = \nabla z_\varepsilon(\tau, n) d\tau + z_\varepsilon(\tau, n) dB_n + o(1).$$

As  $\varepsilon \rightarrow 0$ , this equation limits to that for  $z(\tau, n)$  as desired.

**A.2. Semidiscrete limit of  $q$ -TASEP duality.** By utilizing the path integral formulation of  $z(\tau, n)$  given in (58) let us compute expressions for joint moments of  $z(\tau, n)$  for fixed  $\tau$  but different values of  $n$ . For simplicity, we assume below that all  $\tilde{a}_i \equiv 0$ , though the general case is no more difficult. This procedure is sometimes called the *replica approach* (not to be confused with the *replica trick*—see Section A.4) as it involves replication of the path measure.

Observe that

$$\mathbb{E} \left[ \prod_{i=1}^k z(\tau, n_i) \right] = \mathbb{E} \left[ \prod_{i=1}^k \mathcal{E}^{\phi_i(\tau)=n_i} [e^{\cdot E_\tau(\phi_i)} z_0(\phi_i(0))] \right],$$

where the  $\phi_i$ 's are independent copies of the Poisson jump process  $\phi$ . Interchanging the disorder and path expectations, we are left to evaluate the (now inner) expectation

$$\mathbb{E} \left[ \prod_{i=1}^k e^{E_\tau(\phi_i)} \right] = \exp \left( \int_0^\tau \sum_{i < j} \delta_{\phi_i(s)=\phi_j(s)} ds \right).$$

This leads to the final formula

$$(60) \quad \mathbb{E} \left[ \prod_{i=1}^k z(\tau, n_i) \right] = \mathcal{E}^{\phi_1(\tau)=n_1} \dots \mathcal{E}^{\phi_k(\tau)=n_k} \left[ \exp \left( \int_0^\tau \sum_{i < j} \delta_{\phi_i(s)=\phi_j(s)} ds \right) \prod_{i=1}^k z_0(\phi_i(0)) \right].$$

This identity should be thought of as a duality between the semidiscrete SHE and a system of Poisson jump processes energetically rewarded via the sum of their local times. The proof of the above identity follows from the simple fact that for  $X$  distributed as a centered normal random variable with variance  $\sigma^2$ ,

$$\mathbb{E} [ e^{k(X - \sigma^2/2)} ] = e^{\sigma^2 k(k-1)/2}.$$

This implies that it is the Gaussian nature of the noise and not the underlying generator  $\nabla$  which is behind this identity. Therefore, if  $\nabla$  is replaced in Definition A.1 by an arbitrary generator  $L$ , the same identity holds if  $\phi$  is defined via the adjoint generator of  $L$ . For more on these generalities, see Section 6 of [9]. Note that for the continuum SHE, there exist other types of noise for which dualities have been shown (see, e.g., [18]).

Just as for  $q$ -TASEP, (60) implies that the joint moments of  $z$  satisfy systems of ODEs (recall Proposition 2.7). The (A) system follows from (60) directly. We now record the limiting versions of Proposition 2.7(B) and (C).

**PROPOSITION A.3.** *Let  $z(\tau; n)$  be as above with initial data  $z_0(n)$  supported on  $\mathbb{Z}_{>0}$ .*

(B) Free evolution equation with  $k - 1$  boundary conditions: If  $\tilde{u} : \mathbb{R}_+ \times (\mathbb{Z}_{\geq 0})^k \rightarrow \mathbb{R}$  solves:

(1) For all  $\vec{n} \in (\mathbb{Z}_{\geq 0})^k$  and  $\tau \in \mathbb{R}_+$ ,

$$\frac{d}{d\tau} \tilde{u}(\tau; \vec{n}) = \sum_{i=1}^k \nabla_i \tilde{u}(\tau; \vec{n});$$

(2) For all  $\vec{n} \in (\mathbb{Z}_{\geq 0})^k$  such that for some  $i \in \{1, \dots, k - 1\}$ ,  $n_i = n_{i+1}$ ,

$$(\nabla_i - \nabla_{i+1} - 1) \tilde{u}(\tau; \vec{n}) = 0;$$

(3) For all  $\vec{n} \in (\mathbb{Z}_{\geq 0})^k$  such that  $n_k = 0$ ,  $\tilde{u}(\tau; \vec{n}) \equiv 0$  for all  $\tau \in \mathbb{R}_+$ ;

(4) For all  $\vec{n} \in W_{>0}^k$ ,  $\tilde{u}(0; \vec{n}) = \prod_{i=1}^k z_0(n_i)$ .



Then for all  $\vec{n} \in W_{>0}^k$ ,  $\mathbb{E}[\prod_{i=1}^k z(\tau, n_i)] = \tilde{u}(\tau; \vec{n})$ .

(C) Schrödinger equation with Bosonic Hamiltonian: If  $\tilde{v} : \mathbb{R}_+ \times (\mathbb{Z}_{\geq 0})^k$  solves:

(1) For all  $\vec{n} \in (\mathbb{Z}_{\geq 0})^k$  and  $\tau \in \mathbb{R}_+$ ,

$$\frac{d}{d\tau} \tilde{v}(\tau; \vec{n}) = \tilde{H} \tilde{v}(\tau; \vec{n}), \quad \tilde{H} = \left[ \sum_{i=1}^k \nabla_i + \sum_{i < j}^k \delta_{n_i = n_j} \right];$$

(2) For all permutations of indices  $\sigma \in S_k$ ,  $\tilde{v}(\tau; \sigma \vec{n}) = \tilde{v}(\tau; \vec{n})$ ;

(3) For all  $\vec{n} \in (\mathbb{Z}_{\geq 0})^k$  such that  $n_k = 0$ ,  $\tilde{v}(\tau; \vec{n}) \equiv 0$  for all  $\tau \in \mathbb{R}_+$ ;

(4) For all  $\vec{n} \in W_{>0}^k$ ,  $\tilde{v}(0; \vec{n}) = \prod_{i=1}^k z_0(n_i)$ .

Then for all  $\vec{n} \in W_{>0}^k$ ,  $\mathbb{E}[\prod_{i=1}^k z(\tau, n_i)] = \tilde{v}(\tau; \vec{n})$ .

These systems of ODEs can be proved from (60) directly. Instead, we sketch how they arise as limits of the analogous ODEs for  $q$ -TASEP.

Let us first consider (B). Recall that  $u(t; \vec{n}) = \mathbb{E}[\prod_{i=1}^k q^{x_{n_i}(t) + n_i}]$ . Thus, defining

$$\tilde{u}_\varepsilon(\tau, \vec{n}) = \prod_{i=1}^k e^{\varepsilon^{-1}\tau} \varepsilon^{(n_i-1)} u(\varepsilon^{-2}\tau, \vec{n}),$$

we expect (from Section A.1) that

$$\lim_{\varepsilon \rightarrow 0} e^{-(3k\tau)/2} \tilde{u}_\varepsilon(\tau, \vec{n}) = \mathbb{E} \left[ \prod_{i=1}^k z(\tau, n_i) \right].$$

Call this limit  $\tilde{u}(\tau, \vec{n})$ . We now check that  $\tilde{u}$  indeed satisfies conditions (B.1)–(B.4) above. The fact that it satisfies (B.3) and (B.4) is clear. Note that

$$(61) \quad \prod_{i=1}^k e^{\varepsilon^{-1}\tau} \varepsilon^{(n_i-1)} \nabla_i u(\varepsilon^{-2}\tau, \vec{n}) = \varepsilon \tilde{u}_\varepsilon(\tau, \vec{n}_i^-) - \tilde{u}_\varepsilon(\tau, \vec{n}).$$

Using this, it follows by rescaling (B.1) of Proposition 2.7 that

$$\frac{d}{d\tau} \tilde{u}_\varepsilon(\tau, \vec{n}) = k\varepsilon^{-1} \tilde{u}_\varepsilon(\tau, \vec{n}) + \left( \varepsilon^{-1} - \frac{1}{2} \right) \sum_{i=1}^k (\varepsilon \tilde{u}_\varepsilon(\tau, \vec{n}_i^-) - \tilde{u}_\varepsilon(\tau, \vec{n})) + O(\varepsilon).$$

The factor  $\varepsilon^{-1} - \frac{1}{2}$  comes from the expansion of  $\varepsilon^{-2}(1 - q)$ . The above can be rewritten as

$$\frac{d}{d\tau} \tilde{u}_\varepsilon(\tau, \vec{n}) = \sum_{i=1}^k \left( \tilde{u}_\varepsilon(\tau, \vec{n}_i^-) + \frac{1}{2} \tilde{u}_\varepsilon(\tau, \vec{n}) \right) + O(\varepsilon),$$

which in turn implies that

$$\frac{d}{d\tau} e^{-(3k\tau)/2} \tilde{u}_\varepsilon(\tau, \vec{n}) = \sum_{i=1}^k \nabla_i e^{-(3k\tau)/2} \tilde{u}_\varepsilon(\tau, \vec{n}) + O(\varepsilon).$$

This shows that in the  $\varepsilon \rightarrow 0$  limit,  $\tilde{u}$  satisfies (B.1) above.

Using (61) and the expansion  $q = 1 - \varepsilon + O(\varepsilon^2)$ , it follows from (B.2) of Proposition 2.7 that

$$\tilde{u}_\varepsilon(\tau, \vec{n}_i^-) = \tilde{u}_\varepsilon(\tau, \vec{n}_{i+1}^-) + \tilde{u}_\varepsilon(\tau, \vec{n}) + O(\varepsilon).$$

Multiplying by  $e^{-(3k\tau)/2}$  has no effect on this equality, and so in the limit  $\varepsilon \rightarrow 0$ , we find that  $\tilde{u}$  satisfies (B.2).

We now consider (C). Define  $\tilde{v}_\varepsilon$  and  $\tilde{v}$  analogously to  $\tilde{u}_\varepsilon$  and  $\tilde{u}$  above. The fact that  $\tilde{v}$  satisfies (C.2), (C.3) and (C.4) is clear. Using (61) and second-order expansions of  $(1 - q)$  and  $(1 - q^{-1})$ , we find that

$$\frac{d}{d\tau} \tilde{v}_\varepsilon(\tau, \vec{n}) = \sum_{i=1}^k \left( \tilde{v}_\varepsilon(\tau, \vec{n}_i^-) + \frac{1}{2} \tilde{v}_\varepsilon(\tau, \vec{n}) \right) + \sum_{i < j} \delta_{n_i=n_j} \tilde{v}_\varepsilon(\tau, \vec{n}) + O(\varepsilon).$$

Multiplying by  $e^{-(3k\tau)/2}$  and taking  $\varepsilon \rightarrow 0$  leads to (C.1) as desired.

For  $z_0(\vec{n}) = \prod_{i=1}^k \delta_{n_i=1}$  initial data, it is possible to explicitly solve (B) and (C) in Proposition A.3 via nested contour integral formulas which arise as scaling limits (7). In fact, if we change the boundary condition in (B.2) to  $(\nabla_i - \nabla_{i+1} - c)$  for any  $c \in \mathbb{R}$  [or analogously put this  $c$  factor in (C.1) in front of the sum over  $i < j$ ] essentially the same integral formulas work and we find that (B) is solved by

$$(62) \quad \tilde{u}(\tau, \vec{n}) = \frac{e^{-k\tau}}{(2\pi i)^k} \int \cdots \int \prod_{1 \leq A < B \leq k} \frac{w_A - w_B}{w_A - w_B - c} \prod_{j=1}^k \frac{e^{tw_j}}{w_j^{n_j}} dw_j,$$

where the integration contour for  $w_A$  contains 0 and  $\{w_B + c\}_{B > A}$ . These systems of ODEs are semidiscrete versions of the delta Bose gas, and  $c$  plays the role of the coupling constant. This remarkable symmetry between attractive ( $c > 0$ ) and repulsive ( $c < 0$ ) systems is discussed more in Section 6 of [9].

**A.3. Semidiscrete limit of  $q$ -TASEP Fredholm determinant.** Proposition A.2 implies that as  $q \rightarrow 1$ , under proper scaling  $q$ -TASEP converges to the solution of the semidiscrete SHE. From this weak convergence result, it follows that the  $e_q$ -Laplace transform of particle location for  $q$ -TASEP converges to the Laplace transform of the limiting SHE. This Laplace transform completely characterizes the one-point distribution of the solution  $z(\tau, n)$ . The  $q$ -TASEP Mellin–Barnes-type Fredholm determinant formula has a nice scaling limit, and thus yields (we will state it for a zero drift vector) the following.

**THEOREM A.4.** *For  $\tau \in \mathbb{R}_+$ , and  $n \geq 1$ , the solution of the SHE with delta initial data and drift vector  $\tilde{a} = (0, \dots, 0)$  is characterized by (for  $\text{Re } u \geq 0$ ):*

$$\mathbb{E}[e^{-ue^{(3\tau)/2}z(\tau,n)}] = \det(I + K_u),$$

where  $\det(I + K_u)$  is the Fredholm determinant of  $K_u : L^2(C_0) \rightarrow L^2(C_0)$  for  $C_0$  a positively oriented contour containing zero and such that for all  $v, v' \in C_0$ , we have  $|v - v'| < 1/2$ . The operator  $K_u$  is defined in terms of its integral kernel

$$K_u(v, v') = \frac{1}{2\pi i} \int_{-\infty+1/2}^{\infty+1/2} ds \Gamma(-s) \Gamma(1+s) \frac{\Gamma(v)^n}{\Gamma(s+v)^n} \frac{u^s e^{vts+ts^2/2}}{v+s-v'}.$$

PROOF. This is proved in [9], Theorem 5.2.10. An alternative choice of contours is developed in [10], Theorem 1.16. The formula follows from rigorous asymptotic analysis of Theorem 3.12.  $\square$

**A.4. The replica trick.** It is enticing to think that one might be able to compute the Laplace transform formula in Theorem A.4 directly from the explicit formula for  $\mathbb{E}[z(\tau, n)^k]$  [such as the one given by combining (62) with Proposition A.3(B)]. If  $X$  is a suitably nice nonnegative random variable (e.g., if  $X$  were bounded), then for  $u$  with  $\operatorname{Re}(u) > 0$ ,

$$\mathbb{E}[e^{-uX}] = \sum_{k=0}^{\infty} \frac{(-u)^k}{k!} \mathbb{E}[X^k].$$

This identity only makes sense if one can rigorously justify interchanging the summation. Yet worse, if the moments of  $X$  grow too rapidly, the right-hand side might not even be convergent for any value of  $u$  even though the left-hand side would be necessarily finite. This is exactly the case when  $X = e^{(3\tau)/2} z(\tau, n)$ . From (62), one can estimate that for this choice of  $X$ ,  $\mathbb{E}[X^k] \approx e^{c_k k^2}$  where  $c_k > c > 0$  for all  $k$ . This means that, from a mathematical perspective, one cannot use this approach to compute the Laplace transform.

One variation of the so-called replica trick discussed in physics literature is an attempt to sum this divergent series in such a way as to guess the Laplace transform. (In fact, the most typical version of the replica trick asks for less than the Laplace transform, rather just for  $\mathbb{E}[\log z(\tau, n)]$ , and tries to access it from analytically continuing formulas for integer moments to  $k = 0$ .)

This replica trick procedure has been implemented for the continuum SHE (a scaling limit of the semidiscrete SHE) in which the ODEs in Proposition A.3(B) and (C) become two equivalent forms of the attractive quantum delta Bose gas. The moments of the solutions of the continuum SHE grow even faster, like  $e^{c_k k^3}$  for  $c_k > c > 0$ . By diagonalizing the Bosonic Hamiltonian [the limit of (C)] via the Bethe ansatz, [12, 15] both made initial attempts at computing the Laplace transform via the replica trick. These initial attempts yielded a wrong answer. However, very soon afterward, the formula of [1, 32] was posted (with a rigorous proof given in [1]) and [12, 15] showed that their approach was able to recover the correct Laplace transform formula.

APPENDIX B: COMBINATORICS

**B.1. Useful  $q$ -deformations.** We record some  $q$ -deformations of classical functions and transforms. Section 10 of [2] is a good reference for many of these definitions and statements. We assume throughout that  $|q| < 1$ . The classical functions are recovered in the  $q \rightarrow 1$  limit.

The  $q$ -Pochhammer symbol is written as  $(a; q)_n$  and defined via the product (infinite convergent product for  $n = \infty$ )

$$(a; q)_n = (1 - a)(1 - aq)(1 - aq^2) \cdots (1 - aq^{n-1}),$$

$$(a; q)_\infty = (1 - a)(1 - aq)(1 - aq^2) \cdots.$$

There are two different  $q$ -exponential functions which were introduced by Hahn [17] in 1949. The first (which we will use) is denoted  $e_q(x)$  and defined as

$$e_q(x) = \frac{1}{((1 - q)x; q)_\infty},$$

while the second is defined as

$$E_q(x) = (-(1 - q)x; q)_\infty.$$

Both  $e_q(x)$  and  $E_q(x)$  converge to  $e^x$  as  $q \rightarrow 1$ , cf. (64) below. In fact,  $e_q(x)$  converges uniformly to  $e^x$  on  $x \in [-\infty, a]$  for any  $a \in \mathbb{R}$ .

The  $q$ -factorial is written as either  $[n]_q!$  or just  $n_q!$  and is defined as

$$n_q! = \frac{(q; q)_n}{(1 - q)^n} = \frac{(1 - q)(1 - q^2) \cdots (1 - q^n)}{(1 - q)(1 - q) \cdots (1 - q)}.$$

The  $q$ -binomial coefficients are defined in terms of  $q$ -factorials as

$$\binom{n}{k}_q = \frac{n_q!}{k_q!(n - k)_q!} = \frac{(q; q)_n}{(q; q)_k (q; q)_{n-k}}.$$

We also have [22]

$$(63) \quad \binom{n}{k}_q = \sum_{\substack{S \subset \{1, \dots, n\} \\ |S|=k}} q^{\|S\| - (k(k+1)/2)},$$

where

$$\|S\| = \sum_{i \in S} i.$$

The  $q$ -binomial theorem ([2], Theorem 10.2.1) says that for all  $|x| < 1$  and  $|q| < 1$ ,

$$\sum_{k=0}^\infty \frac{(a; q)_k}{(q; q)_k} x^k = \frac{(ax; q)_\infty}{(x; q)_\infty}.$$

Two corollaries of this theorem ([2], Corollary 10.2.2a/b) are that under the same hypothesis on  $x$  and  $q$ ,

$$(64) \quad \sum_{k=0}^{\infty} \frac{x^k}{kq!} = e_q(x), \quad \sum_{k=0}^{\infty} \frac{q^{k(k-1)/2}(-x)^k}{kq!} = E_q(x).$$

For any  $x$  and  $q$ , we also have ([2], Corollary 10.2.2.c)

$$(65) \quad \sum_{k=0}^n \binom{n}{k}_q (-1)^k q^{k(k-1)/2} x^k = (x; q)_n.$$

Define the following transform of a function  $f \in \ell^1(\mathbb{Z}_{\geq 0})$ :

$$(66) \quad \hat{f}^q(\zeta) := \sum_{n \geq 0} \frac{f(n)}{(\zeta q^n; q)_{\infty}},$$

where  $\zeta \in \mathbb{C}$ .

We call this the  $e_q$ -Laplace transform of  $q^X$  since if  $X$  is a random variable taking values in  $\mathbb{Z}_{\geq 0}$  and  $f(n) = \mathbb{P}(X = n)$ ,

$$\hat{f}^q(\zeta) = \mathbb{E} \left[ e_q \left( \frac{\zeta q^X}{1 - q} \right) \right].$$

An inversion formula is given as Proposition 3.1.1 of [9] and can also be found in [4].

**PROPOSITION B.1.** *One may recover the function  $f \in \ell^1(\mathbb{Z}_{\geq 0})$  from its transform  $\hat{f}^q(\zeta)$  with  $\zeta \in \mathbb{C} \setminus \{q^{-k}\}_{k \geq 0}$  via the inversion formula*

$$(67) \quad f(m) = -q^m \frac{1}{2\pi i} \int_{C_m} (q^{m+1}\zeta; q)_{\infty} \hat{f}^q(\zeta) d\zeta,$$

where  $C_m$  is any positively oriented contour which encircles  $\zeta = q^{-M}$  for  $0 \leq M \leq m$ .

**B.2. Symmetrization identities.** We state and prove the following two useful symmetrization identities.

**LEMMA B.2.** *For all  $k \geq 1$*

$$(68) \quad \sum_{\sigma \in S_k} \prod_{1 \leq A < B \leq k} \frac{z_{\sigma(A)} - z_{\sigma(B)}}{z_{\sigma(A)} - \tau z_{\sigma(B)}} = (\tau; \tau)_k \tau^{-k(k-1)/2} z_1 \cdots z_k \det \left[ \frac{1}{z_i - \tau z_j} \right]_{i,j=1}^k.$$

Setting  $\xi_i = \frac{1+z_i}{1+z_i/\tau}$  we also have

$$\begin{aligned}
 (69) \quad & \sum_{\sigma \in S_k} \prod_{1 \leq A < B \leq k} \frac{z_{\sigma(A)} - z_{\sigma(B)}}{z_{\sigma(A)} - \tau z_{\sigma(B)}} \prod_{i=1}^k \frac{1}{\xi_{\sigma(1)} \cdots \xi_{\sigma(i)} - 1} \\
 & = (-1)^k \tau^{-k(k-1)/2} \det \left[ \frac{1}{z_i - \tau z_j} \right]_{i,j=1}^k \prod_{i=1}^k (\tau + z_i).
 \end{aligned}$$

REMARK B.3. Before proving these identities note that for  $\xi_i = \frac{1+z_i}{1+z_i/\tau}$  and  $\tau = p/q$ ,

$$\begin{aligned}
 (70) \quad & \frac{z_i - z_j}{z_i - \tau z_j} = q \frac{\xi_i - \xi_j}{p + q \xi_i \xi_j - \xi_j}, \\
 & -\frac{z_i(p - q)^2}{(z_i + 1)(p + qz_i)} = p \xi_i^{-1} + q \xi_i - 1, \\
 & \tau + z_i = \frac{\tau - 1}{1 - \xi_i/\tau}.
 \end{aligned}$$

PROOF OF LEMMA B.2. The first identity (68) is [25], Chapter III, equation (1.4). The second identity is equivalent to the identity (1.7) in [38]. In order to see this equivalence expand the Cauchy determinant as

$$\det \left[ \frac{1}{z_i - \tau z_j} \right]_{i,j=1}^k = \frac{\tau^{k(k-1)/2}}{z_1 \cdots z_k (1 - \tau)^k} \prod_{1 \leq i \neq j \leq k} \frac{z_i - z_j}{z_i - \tau z_j}.$$

Multiply both sides of the claimed identity by the factor  $\prod_{1 \leq i \neq j \leq k} \frac{z_i - \tau z_j}{z_i - z_j}$ , reducing the identity to

$$\sum_{\sigma \in S_k} \prod_{1 \leq A < B \leq k} \frac{z_{\sigma(B)} - \tau z_{\sigma(A)}}{z_{\sigma(B)} - z_{\sigma(A)}} \prod_{i=1}^k \frac{1}{\xi_{\sigma(1)} \cdots \xi_{\sigma(i)} - 1} = \prod_{i=1}^k \frac{-(\tau + z_i)}{z_i(1 - \tau)}.$$

Noting that  $\frac{-(\tau + z_i)}{z_i(1 - \tau)} = (\xi_i - 1)^{-1}$  and using the relation (70), it remains to prove that

$$\begin{aligned}
 & \sum_{\sigma \in S_k} q^{-k(k-1)/2} \prod_{1 \leq A < B \leq k} \frac{p + q + \xi_{\sigma(B)} \xi_{\sigma(A)} - \xi_{\sigma(A)}}{\xi_{\sigma(B)} - \xi_{\sigma(A)}} \prod_{i=1}^k \frac{1}{\xi_{\sigma(1)} \cdots \xi_{\sigma(i)} - 1} \\
 & = \prod_{i=1}^k (\xi_i - 1)^{-1}.
 \end{aligned}$$

Using the antisymmetry of the Vandermonde determinant, we rewrite the above as

$$\begin{aligned} & \sum_{\sigma \in \mathcal{S}_k} \operatorname{sgn}(\sigma) \prod_{1 \leq A < B \leq k} (p + q\xi_{\sigma(B)}\xi_{\sigma(A)} - \xi_{\sigma(A)}) \prod_{i=1}^k \frac{1}{\xi_{\sigma(1)} \cdots \xi_{\sigma(i)} - 1} \\ &= q^{k(k-1)/2} \frac{\prod_{A < B} (\xi_B - \xi_A)}{\prod_{i=1}^k (\xi_i - 1)}. \end{aligned}$$

The above identity is (1.7) in [38], and the proof is complete.  $\square$

**B.3. Defining a Fredholm determinant.** Fix a Hilbert space  $L^2(X, \mu)$  where  $X$  is a measure space and  $\mu$  is a measure on  $X$ . When  $X = \Gamma$ , a simple smooth contour in  $\mathbb{C}$ , we write  $L^2(\Gamma)$  where  $\mu$  is understood to be the path measure along  $\Gamma$  divided by  $2\pi i$ . When  $X$  is the product of a discrete set  $D$  and a contour  $\Gamma$ ,  $\mu$  is understood to be the product of the counting measure on  $D$  and the path measure along  $\Gamma$  divided by  $2\pi i$ .

Let  $K$  be an *integral operator* acting on  $f(\cdot) \in L^2(X, \mu)$  by  $(Kf)(x) = \int_X K(x, y)f(y) d\mu(y)$ .  $K(x, y)$  is called the *kernel* of  $K$ . A *formal Fredholm determinant expansion* of  $I + K$  is a formal series written as

$$\det(I + K) = 1 + \sum_{n=1}^{\infty} \frac{1}{n!} \int_X \cdots \int_X \det[K(x_i, x_j)]_{i,j=1}^n \prod_{i=1}^n d\mu(x_i).$$

If the above series is absolutely convergent, then we call this a *numerical Fredholm determinant expansion* as it actually takes a numerical value. If  $K$  is a *trace-class* operator (see [23] or [7]), then the expansion is always absolutely convergent, though it is possible to have operators which are not trace-class, for which convergence still holds.

### APPENDIX C: UNIQUENESS OF SYSTEMS OF ODES

We prove the uniqueness result of Proposition 4.9 by a probabilistic approach. It is possible to extend this proof to a more general class of generators, but we do not pursue this here.

**PROOF OF PROPOSITION 4.9.** Let us first demonstrate the existence of one solution to the system of ODEs given in Definition 4.8. Let  $\tilde{h}^1$  denote the proposed solution, equation (31), in the statement of the proposition. The definition of the generator implies that  $\tilde{h}^1$  satisfies condition 1 of Definition 4.8.

To prove that  $\tilde{h}^1$  satisfies conditions 2 and 3 requires an estimate. In time  $t$ , the number of jumps in ASEP is bounded by a Poisson random variable with parameter

given by constant time  $t$ . This means that for some constant  $c' > 0$

$$(71) \quad \mathbb{P}(\|\vec{x}(-t) - \vec{x}\|_1 = n) \leq e^{-c't} \frac{(c't)^n}{n!}.$$

Observe now that

$$\begin{aligned} & |\tilde{h}^1(t; \vec{x}) - \mathbb{P}^{-t; \vec{x}}(\vec{x}(0) = \vec{x})\tilde{h}_0(\vec{x})| \\ & \leq \sum_{n \geq 1} \sum_{\vec{x}': \|\vec{x} - \vec{x}'\| = n} \mathbb{P}^{-t; \vec{x}}(\vec{x}(0) = \vec{x}') |\tilde{h}_0(\vec{x}')| \\ & \leq \sum_{n \geq 1} \sum_{\vec{x}': \|\vec{x} - \vec{x}'\| = n} e^{-c't} \frac{(c't)^n}{n!} C e^{-c\|\vec{x}'\|_1} \\ & \leq \sum_{n \geq 1} (c'')^n e^{-c't} \frac{(c't)^n}{n!} C e^{-c(\max(0, n - \|\vec{x}\|_1))} \\ & \leq e^{c\|\vec{x}\|_1} (e^{c'''t} - 1). \end{aligned}$$

The first inequality follows from the definition of  $\tilde{h}^1$  as an expectation, along with the triangle inequality. For the second inequality, we can use the bounds (30) and (71) to replace  $\mathbb{P}^{-t; \vec{x}}(\vec{x}(0) = \vec{x}') |\tilde{h}_0(\vec{x}')|$  by  $e^{-c't} \frac{(c't)^n}{n!} C e^{-c\|\vec{x}'\|_1}$ . For the third inequality, we observe that  $\|\vec{x}'\|_1 \geq \max(0, n - \|\vec{x}\|_1)$ . Plugging this bound into  $e^{-c\|\vec{x}'\|_1}$ , we find that the summand is now independent of  $\vec{x}'$  and the summation over  $\vec{x}'$  can be replaced by a rough combinatorial bound of  $(c'')^n$  for the number of such  $\vec{x}'$  ( $c''$  is some sufficiently large constant). The fourth equality comes from factoring out  $e^{c\|\vec{x}\|_1}$  from the summation and then bounding the remaining summation in  $n \geq 1$  by the Taylor series for the exponential.

The conclusion of the above line of inequalities is that for some  $c''' > 0$ ,

$$|\tilde{h}^1(t; \vec{x}) - \mathbb{P}^{-t; \vec{x}}(\vec{x}(0) = \vec{x})\tilde{h}_0(\vec{x})| \leq e^{c\|\vec{x}\|_1} (e^{c'''t} - 1).$$

Observe that using the triangle inequality and the exponential bound on  $\tilde{h}_0(\vec{x})$ , the above inequality implies that  $\tilde{h}^1$  satisfies condition 2. Similarly, as  $t \rightarrow 0$ ,  $\mathbb{P}^{-t; \vec{x}}(\vec{x}(0) = \vec{x}) \rightarrow 1$  and  $e^{c\|\vec{x}\|_1} (e^{c'''t} - 1) \rightarrow 0$  we obtain the pointwise convergence (condition 3):

$$\tilde{h}^1(t; \vec{x}) \rightarrow \tilde{h}_0(\vec{x}), \quad t \rightarrow 0.$$

The argument to prove uniqueness is very similar to the argument used to prove condition 3. Assume now that in addition to  $\tilde{h}^1$ , there existed another solution to the true evolution equation which we will denote by  $\tilde{h}^2$ . The idea is to prove that  $g := \tilde{h}^1 - \tilde{h}^2$  must be identically 0. The solution  $g$  has zero initial data.

To prove that  $g \equiv 0$  it suffices to show that for any  $T > 0$  and any  $\vec{x} \in \tilde{W}^k$ ,  $g(t; \vec{x}) = 0$  for all  $t \in [0, T]$ . Since  $\tilde{h}^1$  and  $\tilde{h}^2$  solve the true evolution equation, so



too must their difference  $g$ . Hence, we readily see that for any  $\delta \in (0, T]$ ,

$$\begin{aligned} & \left| g(t; \vec{x}) - \sum_{n=0}^{n(T)} \sum_{\vec{x}': \|\vec{x} - \vec{x}'\|=n} \mathbb{P}^{-t; \vec{x}}(\vec{x}(-\delta) = \vec{x}') g(\delta; \vec{x}') \right| \\ & \leq \sum_{n>n(T)} \sum_{\vec{x}': \|\vec{x} - \vec{x}'\|=n} \mathbb{P}^{-t; \vec{x}}(\vec{x}(-\delta) = \vec{x}') |g(\delta; \vec{x}')| \\ & \leq \sum_{n>n(T)} (c'')^n e^{-c't} \frac{(c't)^n}{n!} C e^{-c(\max(0, n - \|\vec{x}\|_1))}, \end{aligned}$$

where  $n(T)$  is a positive integer which depends on  $T$  and will be specified soon. The above inequalities follow for similar reasons as in the proof of condition 3 for  $\tilde{h}^1$ . Now observe that by choosing  $n(T)$  sufficiently large, the summation in the last line above can be made arbitrarily small. This is due to the fact that  $1/n!$  decays super-exponentially. This means that for any  $\varepsilon > 0$  and any  $T > 0$ , there exists  $n(T)$  such that

$$\left| g(t; \vec{x}) - \sum_{n=0}^{n(T)} \sum_{\vec{x}': \|\vec{x} - \vec{x}'\|=n} \mathbb{P}^{-t; \vec{x}}(\vec{x}(-\delta) = \vec{x}') g(\delta; \vec{x}') \right| \leq \varepsilon.$$

Since the set of  $\vec{x}'$  such that  $\|\vec{x} - \vec{x}'\| = n$  with  $n \in \{0, 1, \dots, n(T)\}$  is a finite set, condition 3 implies that as  $\delta \rightarrow 0$ , each  $g(\delta; \vec{x}') \rightarrow 0$  as well. Choosing  $\delta$  sufficiently small, this implies that

$$|g(t; \vec{x})| \leq 2\varepsilon$$

and since  $\varepsilon$  was arbitrary this implies in fact that  $g(t; \vec{x}) = 0$  for all  $t \in [0, T]$ . This completes the proof of uniqueness.  $\square$

#### APPENDIX D: GUE TRACY–WIDOM ASYMPTOTICS FOR ASEP

We provide a critical point analysis for the long-time asymptotics of our Mellin–Barnes-type Fredholm determinant formula for the  $e_\tau$ -Laplace transform of  $\tau^{N_x(t)}$ . We assume that  $\tau < 1$  is fixed and straightforwardly arrive at the GUE Tracy–Widom limit theorem recorded in (1) and proved first (via an analysis of the Cauchy-type formula) by Tracy and Widom [40]. In order to make this analysis a rigorous one, would need to control the tails of the integrand defining the kernel. Another scaling limit of interest is the weakly asymmetric limit in which  $\tau$  goes to 1 simultaneously with  $t$  going to infinity. Under the correct scaling (as in [1]), our formula should lead to the Laplace transform of the Hopf–Cole solution to the KPZ equation with narrow wedge initial data. We do not pursue these directions presently, but rather remark that it appears that the Mellin–Barnes-type formula is very well suited for such a rigorous asymptotic analysis.

For simplicity, let us consider ASEP with step initial data and fix  $x = 0$ . We seek to study the large  $t$  behavior of  $N_0(\eta(t))$  via its  $e_\tau$ -Laplace transform. Let us recall the formula we have proved in Theorem 5.3:

$$(72) \quad \mathbb{E}[e_\tau(\zeta \tau^{N_x(\eta(t))})] = \det(I - K_\zeta),$$

where  $\det(I - K_\zeta)$  is the Fredholm determinant of the operator  $K_\zeta : L^2(C_{0,-\tau;-1,\tau\theta}) \rightarrow L^2(C_{0,-\tau;-1,\tau\theta})$  defined in terms of its integral kernel

$$K_\zeta(w, w') = \frac{1}{2\pi i} \int_{D_{R,d}} \Gamma(-s)\Gamma(1+s)[-(1-\tau)\zeta]^s \frac{\exp t(\tau/(\tau+w))}{\exp t(\tau/(\tau+\tau^s w))} \frac{ds}{w' - \tau^s w}.$$

As noted in Section B.1,  $e_\tau(z)$  converges uniformly for  $z \in [-\infty, 0]$ . This means that if  $z \rightarrow -\infty$  then  $e_\tau(z) \rightarrow 0$  and if  $z \rightarrow 0$  then  $e_\tau(z) \rightarrow 1$ . On account of this, if we set

$$\zeta = \tau^{-(t/4)+t^{1/3}r}$$

then it follows (cf. [9], Lemma 4.1.39) that

$$\lim_{t \rightarrow \infty} \mathbb{E}[e_\tau(-\zeta \tau^{N_0(\eta(t/\gamma))})] = \lim_{t \rightarrow \infty} \mathbb{P}\left(\frac{N_0(\eta(t/\gamma)) - (t/4)}{t^{1/3}} \geq -r\right),$$

where we have set  $\gamma = q - p$ .

Theorem 5.3 [see equation (72) above] reduces this to a problem in asymptotic analysis. We proceed now without careful estimates and only discuss contours briefly. There are a few estimates which would be necessary to turn this into a rigorous proof. Making the change of variables in (72)  $z = \tau^s w$  and using the fact that  $\Gamma(-s)\Gamma(1+s) = \pi / \sin(-\pi s)$ , we arrive at the following:

$$\lim_{t \rightarrow \infty} \mathbb{P}\left(\frac{N_0(\eta(t/\gamma)) - (t/4)}{t^{1/3}} \geq -r\right) = \lim_{t \rightarrow \infty} \det(I - K'_\zeta),$$

where the kernel is now given by

$$K'_\zeta(w, w') = \frac{1}{2\pi i} \frac{1}{\log \tau} \int \frac{\pi}{\sin(\pi(\log_\tau w - \log_\tau z))} (1-\tau)^{\log_\tau z - \log_\tau w} \times \exp(t[G(z) - G(w)] + t^{1/3} \log \tau r [\log_\tau z - \log_\tau w]) \frac{1}{z - w'} \frac{dz}{z}$$

with

$$G(z) = -\frac{\log z}{4} - \frac{\tau}{\tau + z}.$$

The critical point of  $G(z)$  is readily calculated by solving

$$G'(z) = -\frac{1}{4z} + \frac{\tau}{(\tau + z)^2} = 0.$$

This yields  $z_c = \tau$  as the critical point. Actually, it is a double root of the above equation and accordingly one sees that  $G''(z_c) = 0$ . The fact that the third derivative is nonzero (and the second derivative is) indicates  $t^{1/3}$  scaling. Up to high order terms in  $(z - \tau)$  and  $(w - \tau)$ , we have

$$G(z) - G(w) \approx -\frac{(z - \tau)^3}{48\tau^3} + \frac{(w - \tau)^3}{48\tau^3}.$$

The  $w$  contour can freely be deformed to go through the critical point  $\tau$  and to depart it at angles  $\pm\pi/3$  (oriented with increasing imaginary part). Likewise the  $z$  contour can go through  $\tau - t^{1/3}$  and depart at angles  $\pm 2\pi/3$  (oriented with decreasing imaginary part—as is a consequence of the change of variables). The  $w$  contour needs to cross the negative real axis between  $-1$  and  $-\tau$ . The  $z$  contour must stay inside the  $w$  contour. There is one nuance with the  $z$  curve which is that it keeps wrapping around in a circle (since the imaginary part of  $s$  went from  $-\infty$  to  $\infty$ ). However, with a suitable a priori bound one should be able to show that this  $s$  contour can be made finite at a cost going to 0 as  $t$  goes to infinity.

The above considerations suggest scaling into a window of size  $t^{1/3}$  around the critical point  $\tau$ . Consider the change of variables  $z - \tau = t^{-1/3}\tau\tilde{z}$  and likewise for  $w$  and  $w'$ . This leads to

$$\begin{aligned} \frac{1}{\log \tau} \frac{\pi}{\sin(\pi \log_\tau w - \log_\tau z)} &\approx t^{1/3} \frac{1}{\tilde{w} - \tilde{z}}, \\ t[G(z) - G(w)] &\approx -\frac{z^3}{48} + \frac{w^3}{48}, \\ t^{1/3} \log \tau r(\log_\tau z - \log_\tau w) &\approx r(\tilde{z} - \tilde{w}), \\ (1 - \tau)^{\log_\tau z - \log_\tau w} &\approx 1, \\ \frac{1}{z - w'} &\approx t^{1/3} \frac{\tau^{-1}}{\tilde{z} - \tilde{w}'}, \\ \frac{dz}{z} &\approx t^{-1/3} d\tilde{z}. \end{aligned}$$

Additionally, there is an extra factor of  $\tau^{-1}t^{1/3}$  which is factored into the kernel, due to the Jacobian of the  $w$  and  $w'$  change of variables. Combining all of these factors, we get that the kernel has rescaled to

$$\tilde{K}_r(\tilde{w}, \tilde{w}') = \frac{1}{2\pi i} \int e^{-(\tilde{z}^3/48) + (\tilde{w}^3/48) + r(\tilde{z} - \tilde{w})} \frac{1}{\tilde{w} - \tilde{z}} \frac{d\tilde{z}}{\tilde{z} - \tilde{w}'},$$

where the  $w$  contour is given by two infinite rays departing 1 at angles  $\pm\pi/3$  (oriented with increasing imaginary part) and the  $z$  contour is given by two infinite rays departing 0 at angles  $\pm 2\pi/3$  (oriented with decreasing imaginary part). Recalling  $\tilde{z} = 2^{4/3}z$  and likewise for  $w$  and  $w'$  yields

$$K_r(w, w') = \frac{1}{2\pi i} \int e^{-(z^3/3) + (w^3/3) + 2^{4/3}r(z-w)} \frac{1}{w - z} \frac{dz}{z - w'}.$$

The Fredholm determinant with this kernel is readily shown to be equivalent to the Fredholm determinant of the Airy kernel (see, e.g., Lemma 8.6 of [10]), and hence its Fredholm determinant is equal to  $F_{\text{GUE}}(2^{4/3}r)$ .

This implies that

$$\lim_{t \rightarrow \infty} \mathbb{P} \left( \frac{N_0(t/\gamma) - (t/4)}{t^{1/3}} \geq -r \right) = F_{\text{GUE}}(2^{4/3}r)$$

as we desired to show.

**Acknowledgements.** We wish to thank P. Ferrari, T. Imamura, J. Quastel, C. Tracy and H. Widom for multiple discussions on the subject. Some work on this subject occurred during the Oberwolfach meeting on Stochastic Analysis, the Warwick EPSRC Symposium on Probability, the American Institute of Mathematics workshop on the Kardar–Parisi–Zhang Equation and Universality Class, and the Institute for Mathematical Sciences, NUS, workshop on Polymers and Related Topics.

## REFERENCES

- [1] AMIR, G., CORWIN, I. and QUASTEL, J. (2011). Probability distribution of the free energy of the continuum directed random polymer in  $1 + 1$  dimensions. *Comm. Pure Appl. Math.* **64** 466–537. [MR2796514](#)
- [2] ANDREWS, G. E., ASKEY, R. and ROY, R. (1999). *Special Functions*. Cambridge Univ. Press, Cambridge. [MR1688958](#)
- [3] BALÁZS, M., KOMJÁTHY, J. and SEPPÄLÄINEN, T. (2012). Microscopic concavity and fluctuation bounds in a class of deposition processes. *Ann. Inst. Henri Poincaré Probab. Stat.* **48** 151–187. [MR2919202](#)
- [4] BANGEREZAKO, G. (2007). An introduction to  $q$ -difference equations. Preprint. Available at <http://perso.uclouvain.be/alphonse.magnus/gbang/qbook712.pdf>.
- [5] BERTINI, L. and GIACOMIN, G. (1997). Stochastic Burgers and KPZ equations from particle systems. *Comm. Math. Phys.* **183** 571–607. [MR1462228](#)
- [6] BOGOLIUBOV, N. M., IZERGIN, A. G. and KITANINE, N. A. (1998). Correlation functions for a strongly correlated Boson system. *Nuclear Phys. B* **516** 501–528. [MR1625167](#)
- [7] BORNEMANN, F. (2010). On the numerical evaluation of Fredholm determinants. *Math. Comp.* **79** 871–915. [MR2600548](#)
- [8] BORODIN, A. and CORWIN, I. (2013). Discrete time  $q$ -TASEPs. *Int. Math. Res. Not.* DOI:10.1093/imrn/rnt206.
- [9] BORODIN, A. and CORWIN, I. (2014). Macdonald processes. *Probab. Theory Related Fields* **158** 225–400. [MR3152785](#)
- [10] BORODIN, A., CORWIN, I. and FERRARI, P. (2014). Free energy fluctuations for directed polymers in random media in  $1 + 1$  dimension. *Comm. Pure Appl. Math.* **67** 1129–1214. [MR3207195](#)
- [11] BORODIN, A. and PETROV, L. (2014). Integrable probability: From representation theory to Macdonald processes. *Probab. Surv.* **11** 1–58. [MR3178541](#)
- [12] CALABRESE, P., LE DOUSSAL, P. and ROSSO, A. (2010). Free-energy distribution of the directed polymer at high temperature. *Europhys. Lett.* **90** 20002.
- [13] CODDINGTON, E. A. and LEVINSON, N. (1955). *Theory of Ordinary Differential Equations*. McGraw-Hill, New York. [MR0069338](#)

- [14] CORWIN, I. (2012). The Kardar–Parisi–Zhang equation and universality class. *Random Matrices: Theory Appl.* **1** 1130001, 76. [MR2930377](#)
- [15] DOTSENKO, V. (2010). Bethe ansatz derivation of the Tracy–Widom distribution for one-dimensional directed polymers. *Europhys. Lett.* **90** 20003.
- [16] GÄRTNER, J. (1988). Convergence towards Burgers’ equation and propagation of chaos for weakly asymmetric exclusion processes. *Stochastic Process. Appl.* **27** 233–260. [MR0931030](#)
- [17] HAHN, W. (1949). Beiträge zur Theorie der Heineschen Reihen. Die 24 Integrale der Hypergeometrischen  $q$ -Differenzgleichung. Das  $q$ -Analogon der Laplace-Transformation. *Math. Nachr.* **2** 340–379. [MR0035344](#)
- [18] HOBSON, T. and TRIBE, R. (2005). On the duality between coalescing Brownian particles and the heat equation driven by Fisher–Wright noise. *Electron. Commun. Probab.* **10** 136–145 (electronic). [MR2162813](#)
- [19] IMAMURA, T. and SASAMOTO, T. (2011). Current moments of 1D ASEP by duality. *J. Stat. Phys.* **142** 919–930. [MR2781714](#)
- [20] IMAMURA, T. and SASAMOTO, T. (2012). Exact solution for the stationary Kardar–Parisi–Zhang equation. *Phys. Rev. Lett.* **108** 190603.
- [21] JOHANSSON, K. (2000). Shape fluctuations and random matrices. *Comm. Math. Phys.* **209** 437–476. [MR1737991](#)
- [22] KAC, V. and CHEUNG, P. (2002). *Quantum Calculus*. Springer, New York. [MR1865777](#)
- [23] LAX, P. D. (2002). *Functional Analysis*. Wiley, New York. [MR1892228](#)
- [24] LIGGETT, T. M. (2005). *Interacting Particle Systems*. Springer, Berlin. [MR2108619](#)
- [25] MACDONALD, I. G. (1995). *Symmetric Functions and Hall Polynomials*, 2nd ed. Oxford Univ. Press, New York. [MR1354144](#)
- [26] MACDONALD, J., GIBBS, J. and PIPKIN, A. (1968). Kinetics of biopolymerization on nucleic acid templates. *Biopolymers* **6** 1–25.
- [27] MORENO FLORES, G., REMENIK, D. and QUASTEL, J. Unpublished manuscript.
- [28] O’CONNELL, N. (2012). Directed polymers and the quantum Toda lattice. *Ann. Probab.* **40** 437–458. [MR2952082](#)
- [29] O’CONNELL, N. and YOR, M. (2001). Brownian analogues of Burke’s theorem. *Stochastic Process. Appl.* **96** 285–304.
- [30] POVOLOTSKY, A. M. (2004). Bethe ansatz solution of zero-range process with nonuniform stationary state. *Phys. Rev. E* (3) **69** 061109, 7. [MR2096488](#)
- [31] SANDOW, S. and SCHÜTZ, G. (1994). On  $U_q[\text{SU}(2)]$ -symmetric driven diffusion. *Europhys. Lett.* **26** 7–12. [MR1269168](#)
- [32] SASAMOTO, T. and SPOHN, H. (2010). The crossover regime for the weakly asymmetric simple exclusion process. *J. Stat. Phys.* **140** 209–231. [MR2659278](#)
- [33] SASAMOTO, T. and WADATI, M. (1998). Exact results for one-dimensional totally asymmetric diffusion models. *J. Phys. A* **31** 6057–6071. [MR1633078](#)
- [34] SCHÜTZ, G. M. (1997). Duality relations for asymmetric exclusion processes. *J. Stat. Phys.* **86** 1265–1287. [MR1450767](#)
- [35] SPITZER, F. (1970). Interaction of Markov processes. *Adv. Math.* **5** 246–290. [MR0268959](#)
- [36] SPOHN, H. (1991). *Large Scale Dynamics of Interacting Particles*. Springer, Berlin.
- [37] SPOHN, H. (2012). Stochastic Integrability and the KPZ Equation. *IAMP News Bulletin*.
- [38] TRACY, C. A. and WIDOM, H. (2008). Integral formulas for the asymmetric simple exclusion process. *Comm. Math. Phys.* **279** 815–844. [MR2386729](#)
- [39] TRACY, C. A. and WIDOM, H. (2008). A Fredholm determinant representation in ASEP. *J. Stat. Phys.* **132** 291–300. [MR2415104](#)
- [40] TRACY, C. A. and WIDOM, H. (2009). Asymptotics in ASEP with step initial condition. *Comm. Math. Phys.* **290** 129–154. [MR2520510](#)

- [41] TRACY, C. A. and WIDOM, H. (2010). Formulas for ASEP with two-sided Bernoulli initial condition. *J. Stat. Phys.* **140** 619–634. MR2670733

A. BORODIN  
DEPARTMENT OF MATHEMATICS  
MASSACHUSETTS INSTITUTE OF TECHNOLOGY  
77 MASSACHUSETTS AVENUE  
CAMBRIDGE, MASSACHUSETTS 02139-4307  
USA  
AND  
INSTITUTE FOR INFORMATION  
TRANSMISSION PROBLEMS  
BOLSHOY KARETNY PER. 19  
MOSCOW 127994  
RUSSIA  
E-MAIL: [borodin@math.mit.edu](mailto:borodin@math.mit.edu)

I. CORWIN  
DEPARTMENT OF MATHEMATICS  
COLUMBIA UNIVERSITY  
2990 BROADWAY  
NEW YORK, NEW YORK 10027  
USA  
AND  
CLAY MATHEMATICS INSTITUTE  
10 MEMORIAL BLVD. SUITE 902  
PROVIDENCE, RHODE ISLAND 02903  
USA  
AND  
DEPARTMENT OF MATHEMATICS  
MASSACHUSETTS INSTITUTE OF TECHNOLOGY  
77 MASSACHUSETTS AVENUE  
CAMBRIDGE, MASSACHUSETTS 02139-4307  
USA  
E-MAIL: [ivan.corwin@gmail.com](mailto:ivan.corwin@gmail.com)

T. SASAMOTO  
DEPARTMENT OF MATHEMATICS  
CHIBA UNIVERSITY  
1-33 YAYOI-CHO, INAGE, CHIBA, 263-8522  
JAPAN  
E-MAIL: [sasamoto@math.s.chiba-u.ac.jp](mailto:sasamoto@math.s.chiba-u.ac.jp)