

PFC/RR 84-4

DOE/ET/51013-113  
UC-20 a,f

SPECTRAL MEASUREMENTS OF FLUCTUATING  $\omega_{pe}$  RADIATION  
FROM ALCATOR C TOKAMAK

Rex F. Gandy and Daniel Yates

Plasma Fusion Center  
Massachusetts Institute of Technology  
Cambridge, MA 02139

February 28, 1984

This work was supported by the U.S. Department of Energy Contract No. DE-AC02-78ET51013. Reproduction, translation, publication, use and disposal, in whole or in part by or for the United States government is permitted.

SPECTRAL MEASUREMENTS OF FLUCTUATING  $\omega_{pe}$  RADIATION  
FROM ALCATOR C TOKAMAK

Rex F. Gandy and Daniel H. Yates

February 1984

ABSTRACT

High resolution spectral measurements have been made of the fluctuating electron plasma frequency ( $\omega_{pe}$ ) radiation from Alcator C. Three techniques have been used in making the measurements. Features as narrow as 350 kHz have been observed ( $\Delta f/f \approx 6 \times 10^{-6}$ ), implying that a highly coherent process is responsible for the emission.

## Introduction

Temporal bursts of emission with a frequency near the central electron plasma frequency have been previously observed on Alcator C.<sup>1</sup> Measurement of the spectral width<sup>2</sup> found an unresolved feature with  $\Delta f/f \lesssim 10^{-2}$ . The instrumental resolution for that measurement was approximately 300 MHz. The purpose of the work presented here is to describe higher resolution spectral measurements of this fluctuating emission. Three methods of spectral analysis were used, each successive method having higher resolution. The first method used filter banks to give the spectral characterization. Secondly, a surface acoustic wave (SAW) dispersive delay line gave real-time spectral analysis. Finally, a direct sampling technique was employed. The experimental details and results from each of these techniques will be given, after the common characteristics of the measurements are discussed.

## General Description

The bursting  $\omega_{pe}$  emission is commonly seen during two phases of tokamak operation: (1) plasma current rise, (2) after the introduction of phased RF waves at the lower hybrid frequency. The fluctuating emission during the rise of the plasma current is made possible by the relatively large toroidal electric field. This electric field leads to the formation of energetic, non-thermal electrons which can excite the growth of plasma waves. During lower hybrid (LH) current drive operation,<sup>3</sup> the primary of the ohmic heating system is open-circuited causing the plasma current to inductively decay. Then a pulse of LH power typically sustains the plasma current at a constant value and reduces the loop voltage to zero.

Various diagnostics show that the bulk of the plasma current is being carried by an energetic electron tail.<sup>4</sup> When the LH pulse ends, the inductive decay of the plasma current resumes and a toroidal electric field is reestablished. This electric field, although relatively weak in magnitude, acts upon a preformed tail, and again highly non-thermal electrons are produced. Thereafter this situation resembles the plasma current rise case.

The bursts of emission are seen to have a very rapid rise time, approximately one microsecond. They typically last 5-10 microseconds. The radiation temperature of the emission at its peak is at least an order of magnitude above the thermal electron blackbody level.

All observations described here were made with the 61 GHz radiometer<sup>5</sup> shown in figure 1. A horn collects the radiation which then passes through a 61 GHz high-pass waveguide filter. This filter provides image rejection by attenuating the lower sideband produced in mixer M1. A Gunn diode operating at 61 GHz serves as the local oscillator. The typical intermediate frequency (IF) range of 100 to 1500 MHz corresponds to a microwave frequency range from 61.1 to 62.5 GHz. The IF signal is then amplified, and the spectral measurements are performed through analysis of the IF signal.

#### Filter Bank Method

The filter bank method is illustrated in figure 2. A broadband detector (30-1000 GHz) is used to monitor the presence of any fluctuating emission. One of two bandpass filter bank systems is employed. In case 1, a 10-500 MHz bandpass filter,  $F_{bp}$ , is used. After a 4-way power

division, filters F1-F4 separate the spectrum into four adjacent 100 MHz wide channels. Features were observed on each channel F2 and F3 alone, indicating unresolved spectral components narrower than 100 MHz. In case 2,  $F_{bp}$  is a 100-200 MHz bandpass filter. Bandpass filters F1-F4 form four 25 MHz-wide adjacent channels from 100-200 MHz. The results of the case 2 study (see figure 3) showed the presence of emission with spectral features narrower than 25 MHz. It should be noted that the 61 GHz high-pass waveguide filter was not available for the filter bank studies. The waveguide filter was in place for all other studies.

#### SAW Dispersive Delay Line Technique

In order to reduce the resolution below 25 MHz, a SAW dispersive delay line was used to make real-time spectral measurements of the fluctuating  $\omega_{pe}$  emission. A similar method has been used previously to measure the spectral width of far-infrared laser pulses.<sup>6</sup> A block diagram of the experimental set-up is shown in figure 4. The basic use of the device is the following: (1) a narrow time slice (100 nsec in this case) of the IF burst is introduced at the input of the device, (2) surface acoustic waves are generated by an inter-digital transducer at the input, (3) grooves of variable spacing reflect waves with wavelength corresponding to the inter-groove spacing, (4) a mirror image set of grooves reflect the acoustic waves to the output transducer, (5) since the waves all travel at the same group velocity, different frequencies emerge from the device with a time delay proportional to the total distance traveled and thus to the initial frequency.

A SAW delay line can be characterized by its dispersion bandwidth

( $\Delta f$ ) and dispersion time ( $\Delta\tau$ ). Relevant SAW device parameters are given in table 1. The frequency resolution of the device is given by  $(\Delta f / \Delta\tau)^{1/2}$ . This gives a theoretical frequency resolution of 10 MHz. In practice, an experimental resolution of 13 MHz was measured by sampling a fixed frequency source. The SAW output is given by:

$$\text{(eqn. 1) } O(t) \sim \int_0^{t-\tau_d} d\alpha f(\alpha) h(t-\alpha),$$

where

$f(t)$  = input waveform

$h(t) = p(t) \cos \{2\pi f_s (t-\tau_d) + \beta (t-\tau_d)^2\}$

$$p(t) = \begin{cases} 1 & \tau_d < t < \tau_d + \Delta\tau \\ 0 & \tau_d > t > \tau_d + \Delta\tau \end{cases}$$

and  $f_s$  = starting frequency,  $\tau_d$  = initial delay,  $\beta \equiv \frac{\pi \Delta f}{\Delta\tau}$ .

The SAW output approximates a Fourier transform for a certain range of input pulse widths. Analysis of the SAW transfer function (eqn. 1) shows that a good approximation to a Fourier transform is found for

$$\frac{2}{\Delta f} < \tau_p < \frac{\Delta\tau}{\Delta f}^{1/2} \quad \text{where } \tau_p \text{ is the input pulse width.}$$

A typical experimental result is presented in figure 5. The spectral line displayed in figure 5 has a FWHM of 13 MHz, the instrumental resolution. Almost all features observed from the SAW system were unresolved, and several types of spectra were seen (i.e. singlets, doublets, and multiple-peaked).

#### Direct Sampling Technique

The third method of frequency analysis with still higher resolution

consists of a double-mixer, direct sampling approach (see figure 6). Here a single sideband (due to the high-pass 61 GHz waveguide filter) with an IF frequency between 400-1500 MHz passes from mixer M1 through filter  $F_B$  (435-465 MHz bandpass). The signal is then split in a power divider, with one output being used to trigger the logic and clock circuitry. The emission burst is sampled for 5 microseconds at a rate of 32.768 MHz. The other output of the power divider is introduced into a second mixer M2 which operates with a local oscillator frequency of 435 MHz. This value of local oscillator frequency is chosen so that only the upper sideband of mixer M2 is unattenuated. The output of M2 is then low-pass filtered through  $F_L$  (12 MHz cutoff). Therefore, at the input of the A/D converter the microwave frequency range 61.435-61.447 GHz has been transposed to DC-12 MHz. The data is then Fourier transformed to obtain the autopower spectrum. The system has a frequency resolution of approximately 200 kHz limited by the duration of the emission. The system is capable of recording 50 bursts during a single plasma shot.

Typical spectra are shown in figures 7a and 7b. In figure 7a a relatively wide feature is shown (FWHM=700 kHz). One of the narrowest observed features is shown in figure 7b (FWHM=420 kHz). Another interesting feature is a frequency shift during certain bursts. This shift can be seen on the raw data (figure 8a) and on the transformed spectrum (figure 8b).

### Conclusions

Several techniques of spectral analysis have been used to study fluctuating  $\omega_{pe}$  emission from Alcator C. The presence of non-thermal

electron distribution is a necessary condition for this emission. Features as narrow as 350 kHz have been observed. The narrow spectral width suggests that a coherent, laser-like process exists in the plasma. In this case a cavity must exist in which the waves can be suitably amplified. The processes behind the amplification and trapping of the waves are not presently understood. Future work will be aimed at refining the measurement and exploring the cause of the emission.

#### Acknowledgements

The authors would like to thank Paul Woskoboinikow and Bill Mulligan for the use of use of the SAW delay line. We would also like to thank Ian Hutchinson, Ron Parker, Miklos Porkolab, and Steve Wolfe for support and encouragement.



REFERENCES

1. I. H. Hutchinson and S. E. Kissel, Phys. of Fluids 23, p. 1698, (1980).
2. I. H. Hutchinson and S. E. Kissel, Phys. of Fluids 26, p. 310, (1983).
3. M. Porkolab, et al., "Lower Hybrid Current Drive and Heating Experiments up the 1 MW Level in Alcator C," proceedings of the Fifth Topical Conference on Radio Frequency Plasma Heating, Madison, Wisconsin, 1983. And, M. Porkolab, et al., 9th Int. Conf. Plas. Res. and Contr. Nucl. Fus. Res., Baltimore, U.S.A., 1982, IAEA-CN-41/C-4
4. S. Texter, et al., "Plasma X-Ray Emission in the 20-500 keV Range During LH Current Drive on Alcator", Bull. Amer. Phys. Soc., 28, 1162, (1983).
5. D. H. Yates, B. S. Thesis MIT, (1983).
6. H. R. Fetterman, P. E. Tannenwald, C. D. Parker, J. Melngailis, R. C. Williamson, P. Woskoboinkow, H. C. Praddaude and W. J. Mulligan, Appl. Phys. Lett., 34(2), p.123, (Jan.1979).

Figure Captions

- Figure 1. Block diagram of 61 GHz radiometer.
- Figure 2. Block diagram of filter-bank detection system.
- Figure 3. Data from case 2 filter-bank detection system.  
Numbers inside graph indicate magnitude of signal(A.U.).  
Single burst on channel F3 indicates spectral feature having width < 25MHz.
- Figure 4. SAW spectral analysis system.
- Figure 5. Data from SAW spectral analysis system.
- Figure 6. Direct sampling method block diagram.
- Figure 7a. Data from direct sampling method. Well-resolved feature with FWHM=700 kHz.
- Figure 7b. Data from direct sampling method. Very narrow feature with FWHM=420 kHz.
- Figure 8a. Raw data from a burst with a time-varying frequency.
- Figure 8b. Transformed Fourier power spectrum of signal shown in figure 8a.

TABLE 1

DISPERSION BAND: 850 - 1150 MHz

DISPERSION BANDWIDTH:  $\Delta f = 300$  MHz

DISPERSION TIME:  $\Delta \tau = 6$   $\mu$ s

INITIAL DELAY:  $\tau_d = 4.8$   $\mu$ s

TIME - BANDWIDTH PRODUCT:  $\Delta \tau \Delta f = 1800$

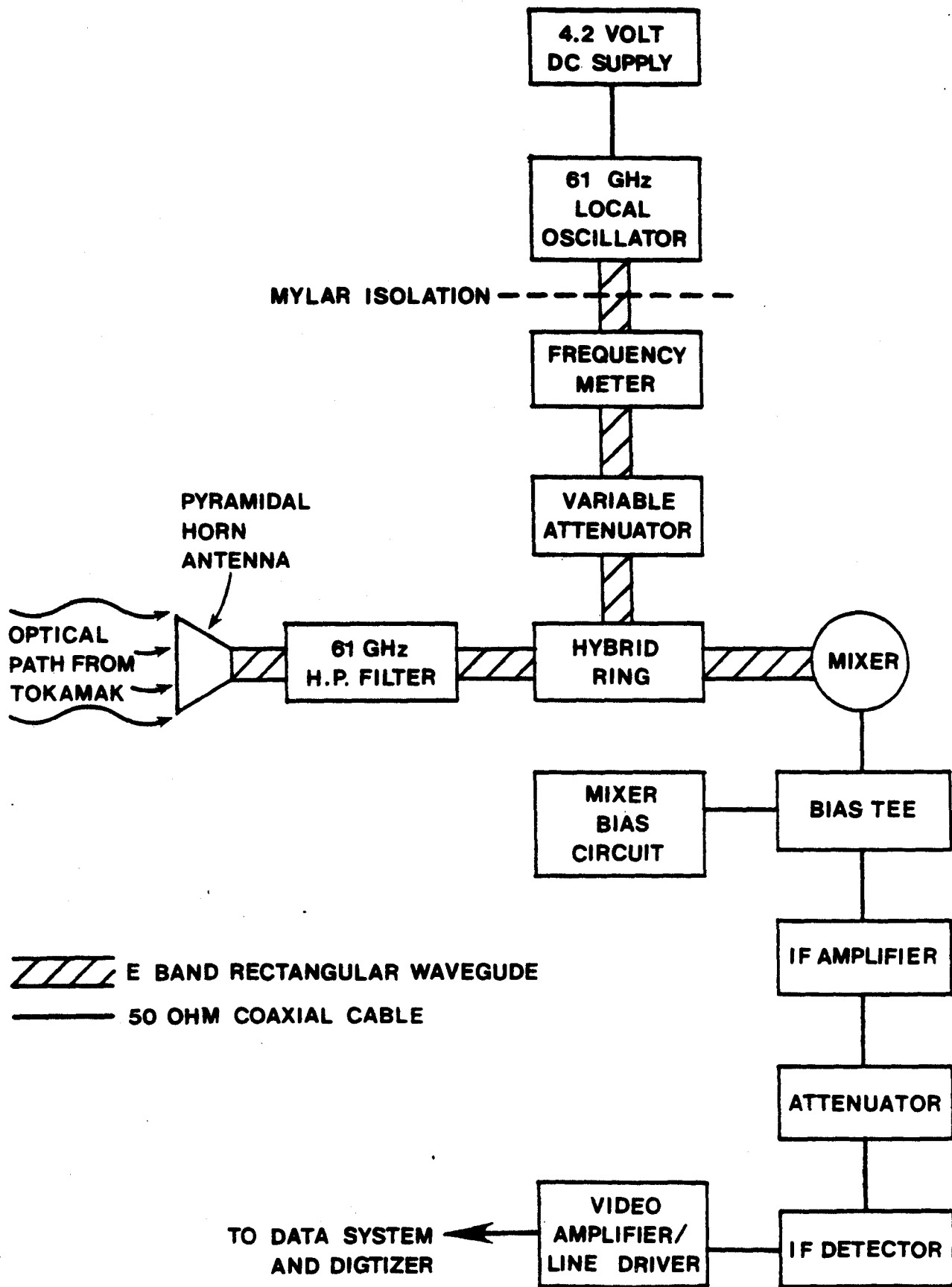
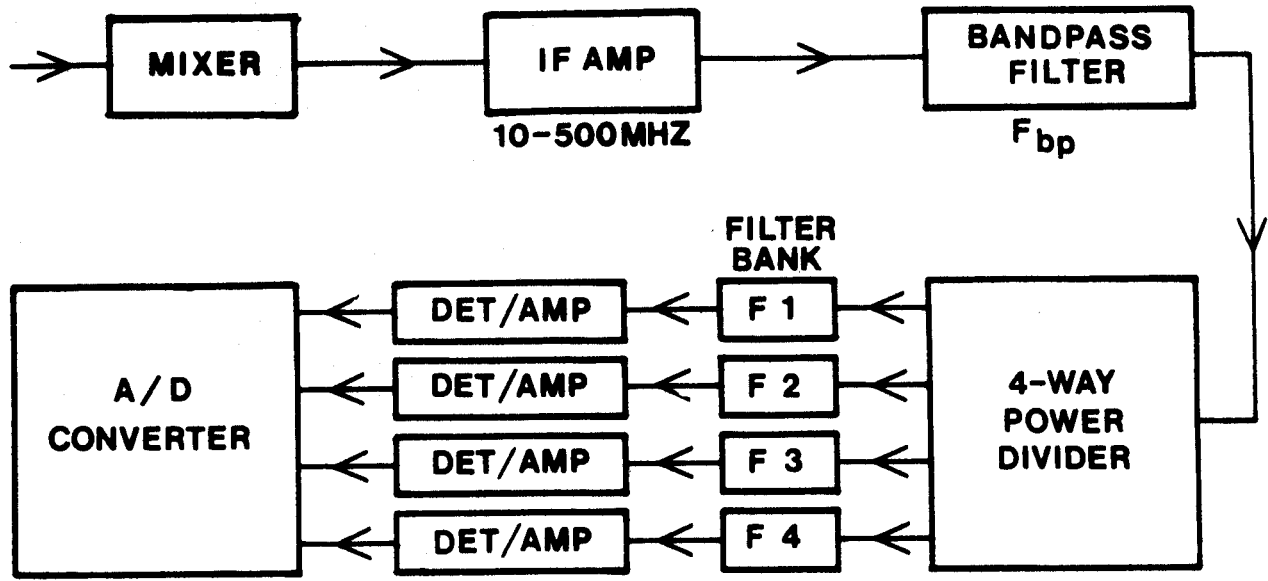

FIGURE 1 Block diagram of 61 GHz radiometer.

# SPECTRAL ANALYSIS OF FLUCTUATING EMISSION



## Case 1

$F_{bp} = 10-500 \text{ MHz}$

Filters F1-F4 3-Pole  
100 MHz Bandwidth

Center Frequencies (MHz)

F1 = 150  
F2 = 250  
F3 = 350  
F4 = 450

## Case 2

$F_{bp} = 100-200 \text{ MHz}$

Filters F1-F4 4-Pole  
25 MHz Bandwidth

Center Frequencies (MHz)

F1 = 112.5  
F2 = 137.5  
F3 = 162.5  
F4 = 187.5

FIGURE 2 Block diagram of filter-bank detection system.

May 17/83 .054

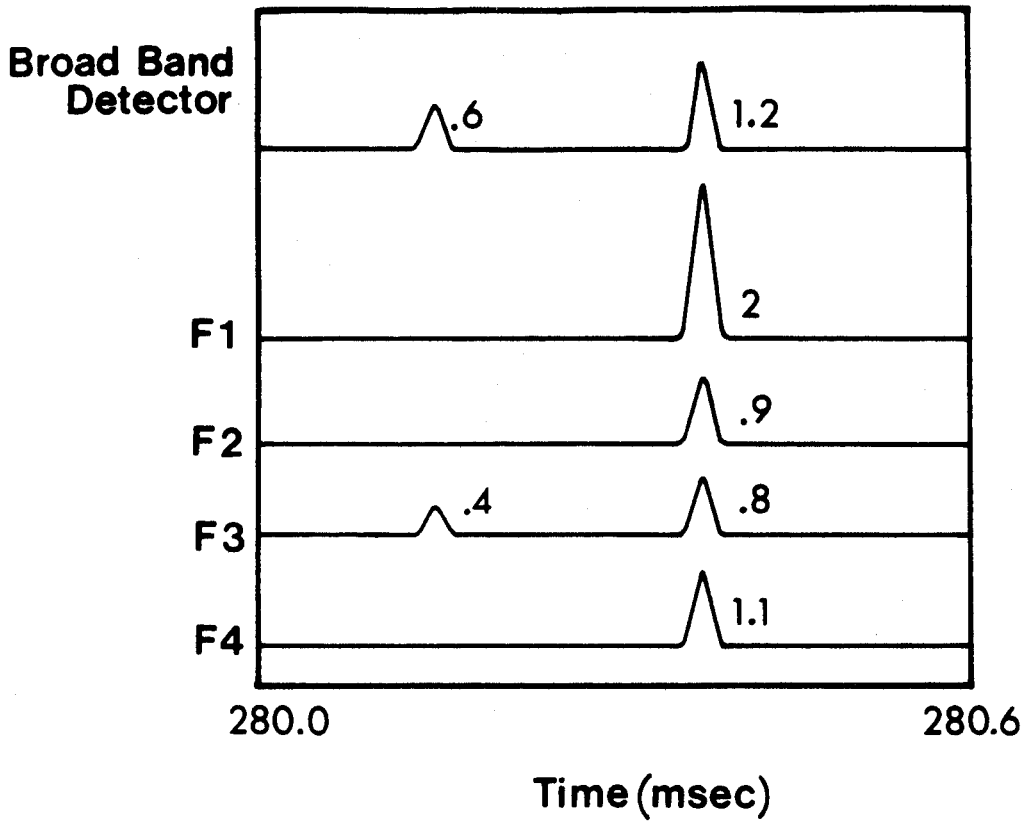

8269

FIGURE 3 Data from case 2 filter-bank detection system. Numbers inside graph indicate magnitude of signal(A.U.). Single burst on channel F3 indicates spectral feature having width < 25MHz.

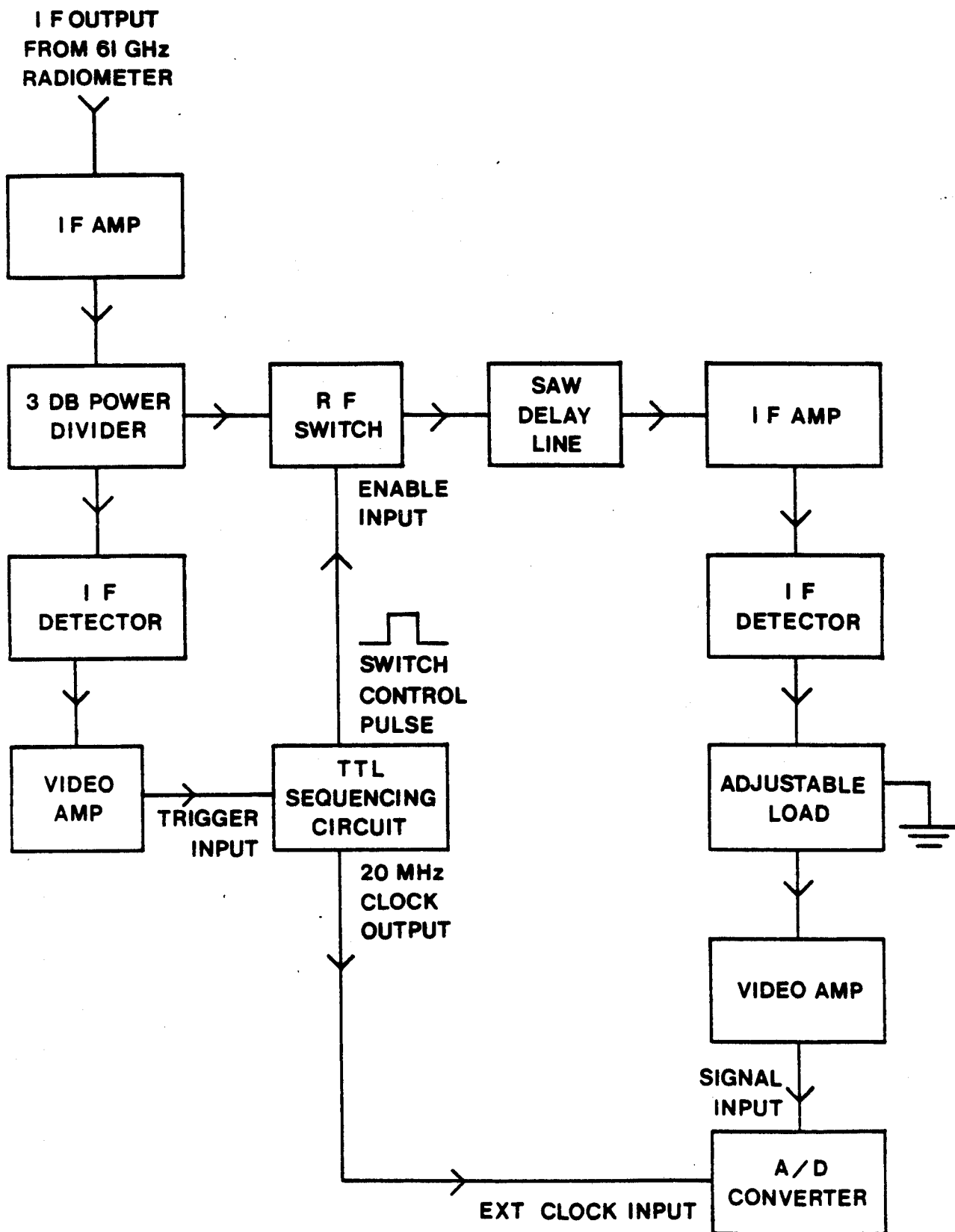

FIGURE 4 SAW spectral analysis system.

31 Jan. 84

No 13

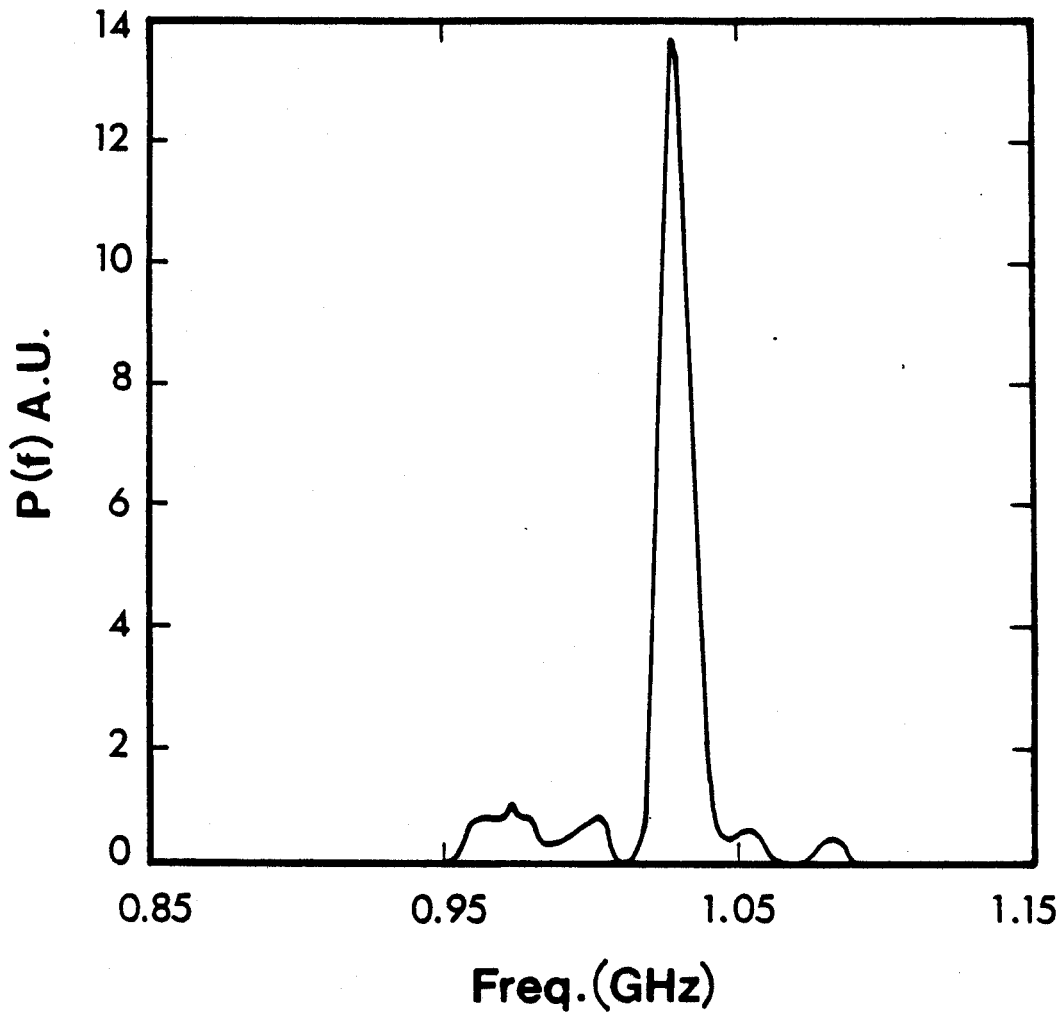

FIGURE 5 Data from SAW spectral analysis system.

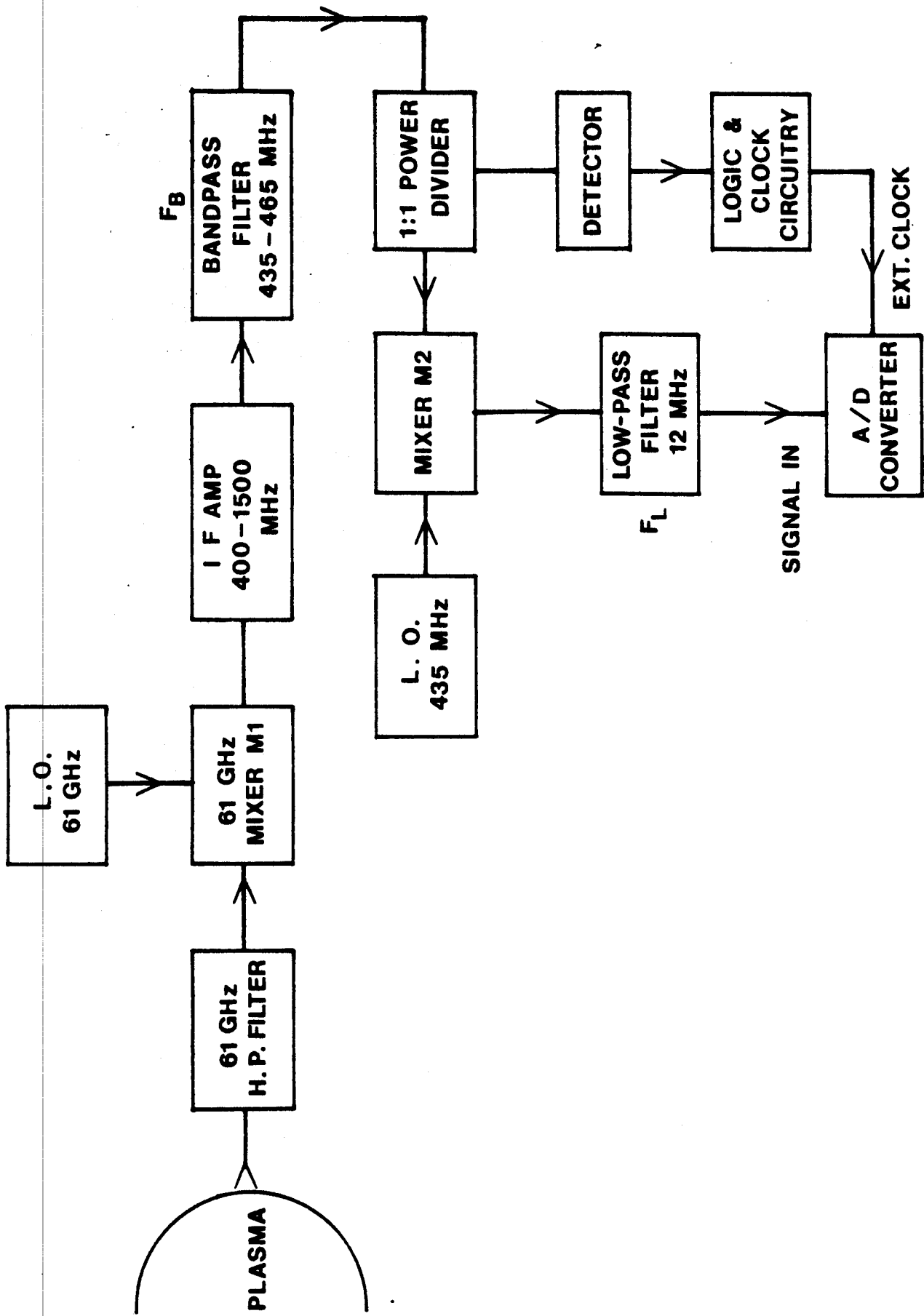

FIGURE 6 Direct sampling method block diagram.



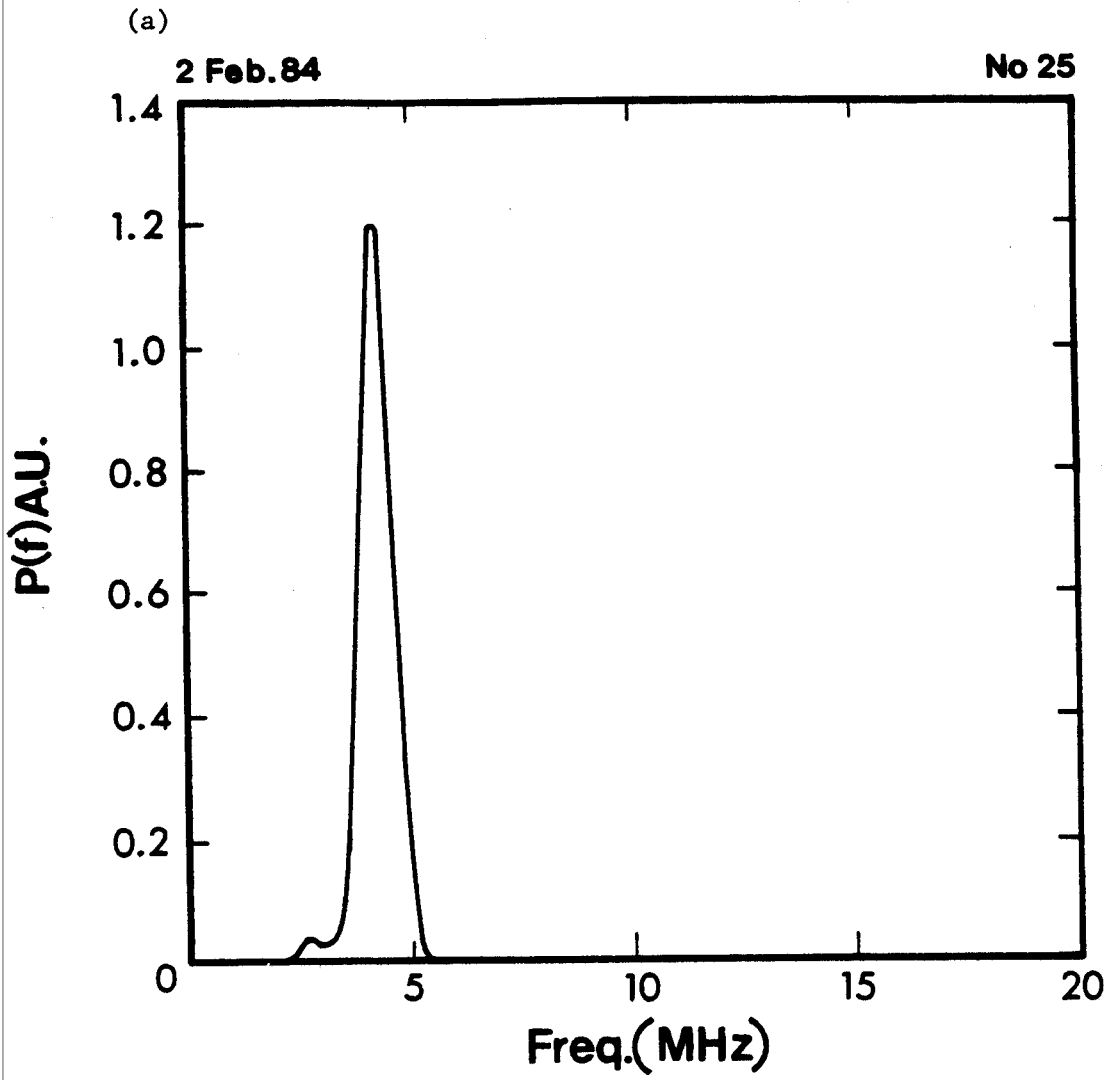

FIGURE 7a Data from direct sampling method. Well-resolved feature with FWHM=700 kHz.

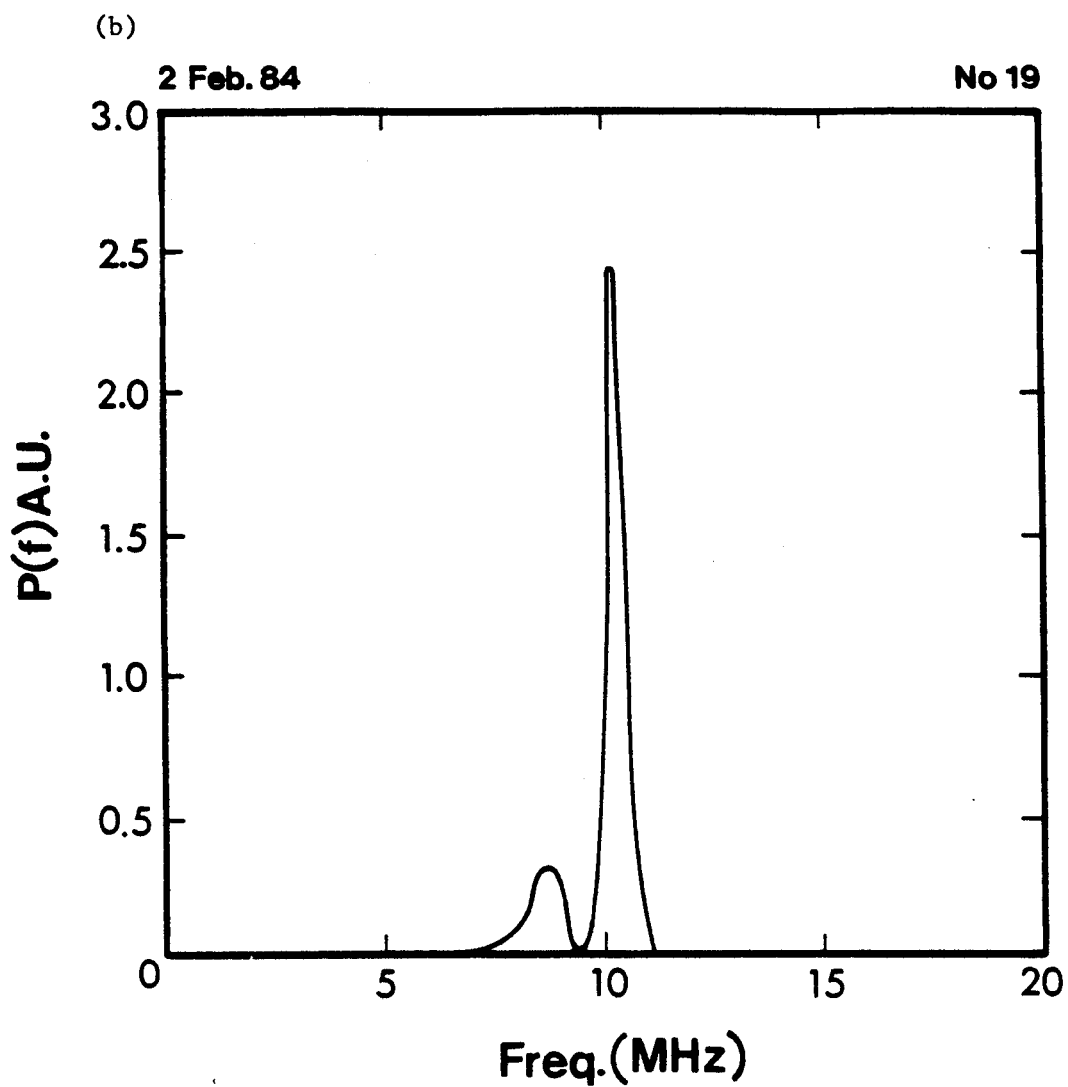

FIGURE 7b Data from direct sampling method. Very narrow feature with FWHM=420 kHz.

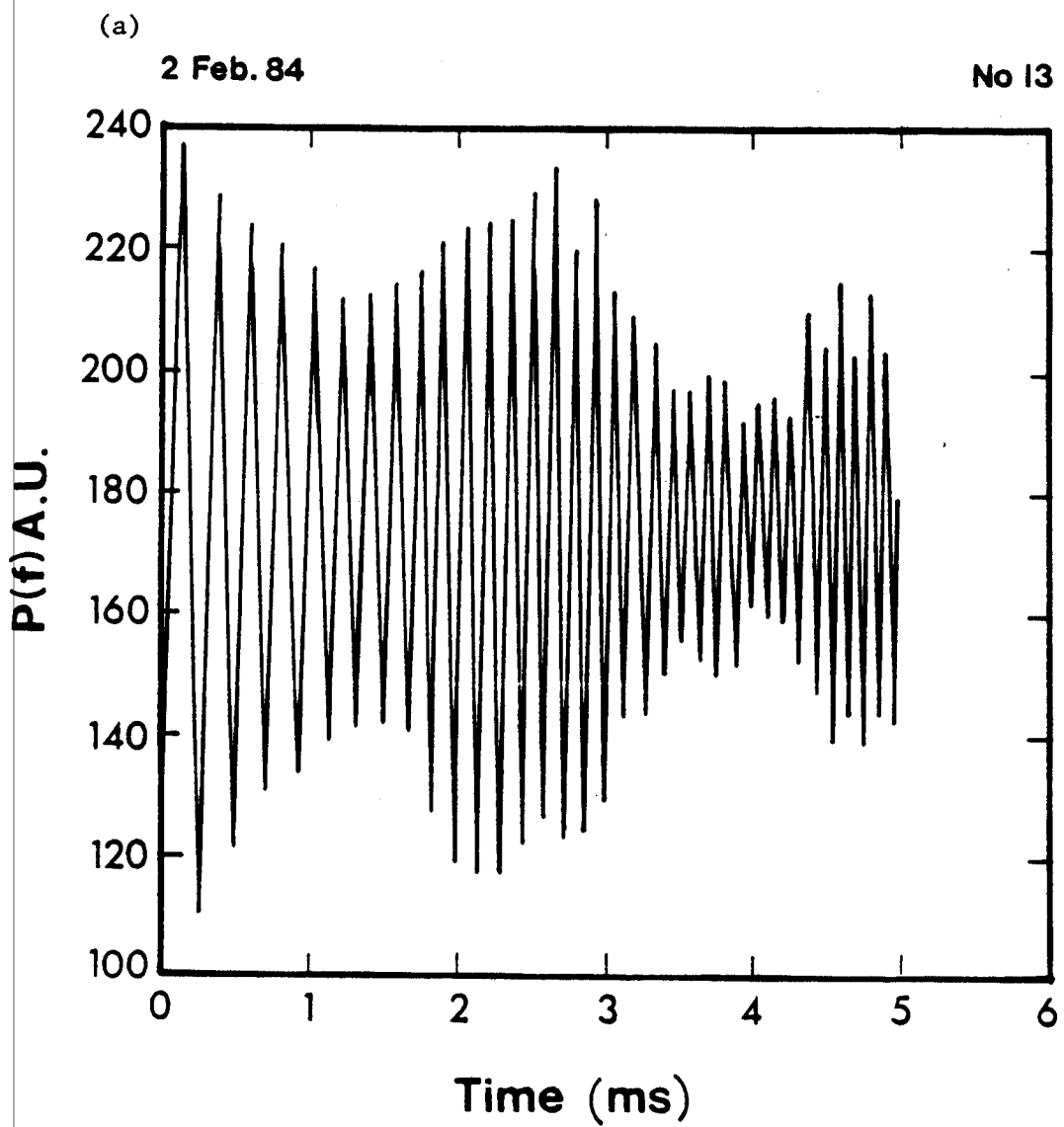

FIGURE 8a Raw data from a burst with a time-varying frequency.

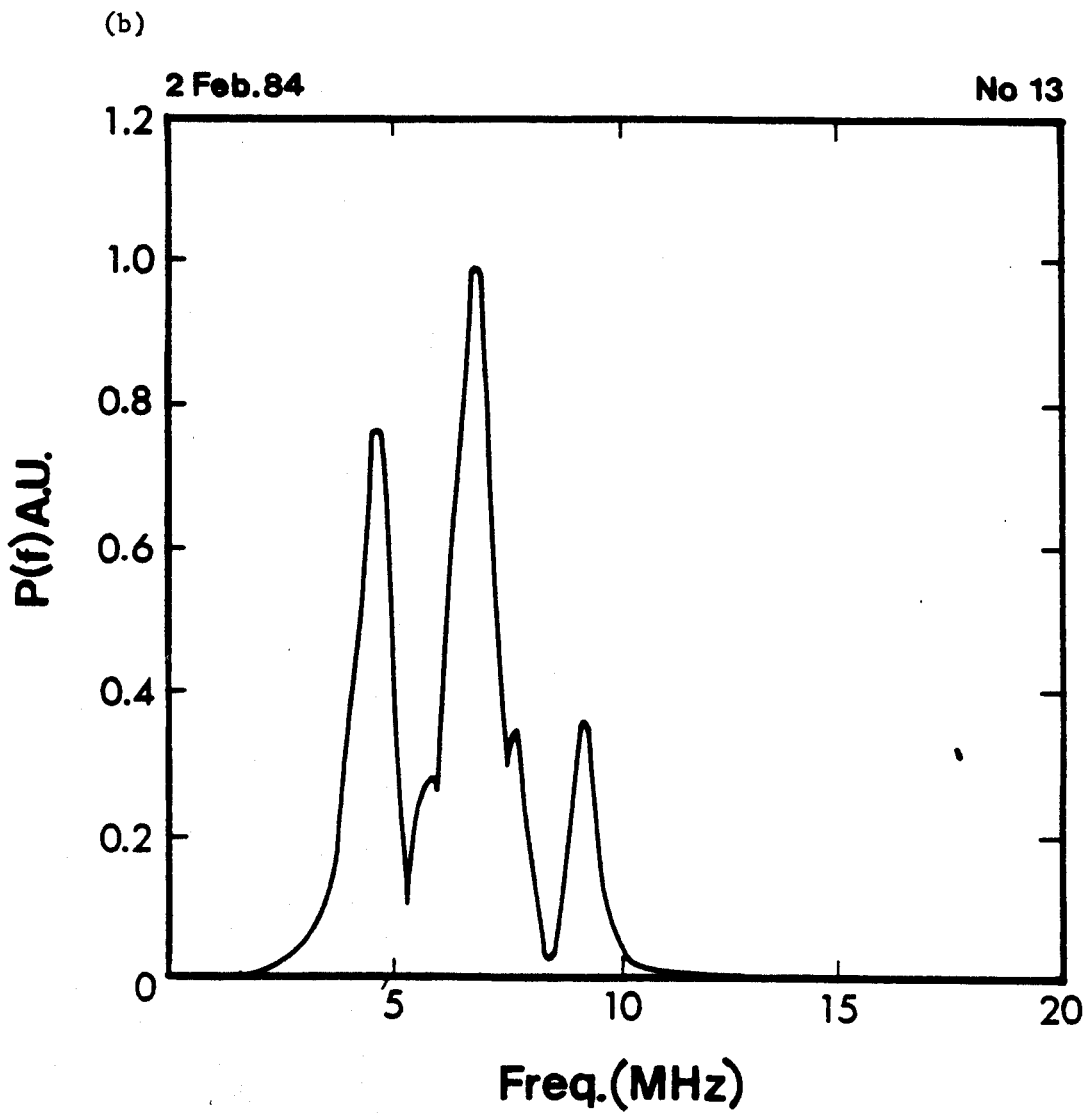

FIGURE 8b Transformed Fourier power spectrum of signal shown in figure 8a.