

MIT Open Access Articles

Inactivation of Bacteria by Electric Current in the Presence of Carbon Nanotubes Embedded Within a Polymeric Membrane

The MIT Faculty has made this article openly available. **Please share** how this access benefits you. Your story matters.

Citation: Zhu, Anna, Harris K. Liu, Feng Long, Erzhen Su, and Alexander M. Klibanov. "Inactivation of Bacteria by Electric Current in the Presence of Carbon Nanotubes Embedded Within a Polymeric Membrane." *Applied Biochemistry and Biotechnology* 175, no. 2 (October 24, 2014): 666–676.

As Published: <http://dx.doi.org/10.1007/s12010-014-1318-z>

Publisher: Springer US

Persistent URL: <http://hdl.handle.net/1721.1/106969>

Version: Author's final manuscript: final author's manuscript post peer review, without publisher's formatting or copy editing

Terms of use: Creative Commons Attribution-Noncommercial-Share Alike



Inactivation of bacteria by electric current in the presence of carbon nanotubes embedded within a polymeric membrane

Anna Zhu^a, Harris K. Liu^a, Feng Long^c, Erzhen Su^{a,d}, and Alexander M. Klibanov^{a,b}

Departments of ^aChemistry and ^bBiological Engineering, Massachusetts Institute of Technology, Cambridge, MA 02139, U.S.A.; ^cSchool of Environment and Natural Resources, Renmin University of China, Beijing 100875, China; ^dEnzyme and Fermentation Technology Laboratory, College of Light Industry Science and Engineering, Nanjing Forestry University, Nanjing 210037, China

Abstract

Uniform conductive composite membranes were prepared using a phase inversion method by blending carboxyl-functionalized multi-walled carbon nanotubes (CNTs) with a polysulfone polymer. At 6% of the embedded CNTs, the membrane pore size measured by transmission electron microscopy (TEM) was approximately 50 nm. Electric current in the presence of the composite membranes markedly inactivated the model pathogenic bacteria *E. coli* and *S. aureus*, with the extent of bacterial inactivation rising when the current was increased. Over 99.999% inactivation of both bacteria was observed in deionized water after 40 min at 5 mA direct current (DC); importantly, no appreciable inactivation occurred in the absence of either the electric field or the CNTs within the membranes under otherwise the same conditions. A much lower, although still pronounced, inactivation was seen with alternating current (AC) in a 25 mM NaCl aqueous solution.

Keywords: carbon nanotubes; conductive composite membrane; *E. coli*; *S. aureus*; electric field; water disinfection

Introduction

Inadequate water sanitation, especially bacterial contamination, causes severe health problems in the developing world, even in regions considered water-rich [1]. Drawbacks of conventional water disinfection include toxic byproducts, high energy consumption and cost, and sluggishness [2]. Therefore, new efficient and affordable water disinfection methods are needed.

Membrane technologies, such as ultrafiltration and reverse osmosis, are widely used for the wastewater treatment due to their cost-efficiency, low energy demand, and benign environmental impact. Among means to improve membrane performance, carbon nanotubes (CNTs) [3] are particularly noteworthy due to their unique properties, including electric conductivity, thermal stability, and tensile strength [4, 5]. For example, CNTs were added to polymeric materials to enhance their performance [6-13] and also applied to improve the flux and anti-biofouling characteristics of ultra- and nano-filtration membranes [14-21].

Recently, conductive capabilities of CNT composite membranes have been integrated into filtration processes to inactivate microbes [22, 23] and reduce biofouling [24-26]. For example, CNTs were deposited onto a polyethersulfone membrane and a polyamide thin film was formed on their surface by interfacial polymerization [24-25]. The resultant sandwich-like membranes, with CNTs acting as the conductive layer and polyamide film as the salt-rejecting layer, were capable of preventing bacterial biofilm formation when an alternating electric potential was applied. Likewise, a CNT filter deposited onto a polymeric membrane inactivated *E. coli* and MS2 bacteriophage when direct current (DC) was applied [22, 23, 26].

Since CNTs in the previous studies were simply deposited onto the membrane surface by filtration, they easily separated and disassembled from the membrane, especially during water treatment with its prolonged periods of turbulence. To address this drawback, in the present work we have prepared composite membranes with CNTs uniformly embedded throughout by phase inversion method and found them capable of avidly inactivating both Gram-negative and Gram-positive bacteria when electric current was applied.

Materials and Methods

Fabrication of conductive composite membranes

The composite membranes were fabricated using functionalized multi-walled CNTs (also referred to as f-MWCNTs herein) and polysulfone (PSF, MW of 84 kDa) with *N,N*-dimethylformamide (DMF) as a solvent (all from Sigma-Aldrich). The f-MWCNTs were > 8% carboxyl-functionalized and had an average diameter of 9.5 nm and length of 1.5 μ m. The composite membrane fabrication process was the same as with the plain polymeric membranes but with the additional step of incorporating f-MWCNTs. Namely, 3.0 g of polysulfone was dissolved in 17 g of DMF and 75-450 mg f-MWCNTs was added, followed by vigorous stirring for at least 48 h at room temperature to uniformly disperse the CNTs; consequently, a 2.5-15% (w/w, compared to PSF) f-MWCNTs/PSF composite membrane casting solution was formed and cast onto a glass plate with a casting knife. Following

evaporation of the solvent for about 30 s, the resultant composite membrane was placed into a Milli-Q water bath for 30 min to complete the phase inversion process and remove the residual solvent. The membrane was then stored in deionized water until use.

Culturing and quantifying bacteria

Bacterial concentrations were determined by the plate count agar method [27]. To measure the concentration of *Escherichia coli* (Genetic Stock Center, CGSC4401), a 0.1-mL water sample containing the bacteria was spread onto an agar plate and cultured at 37°C. The agar culture medium was prepared with sterilized LB medium containing 1.5% tryptone, 0.5% yeast extract, 1.0% NaCl, and 1.5% agar (all from Becton Dickinson). *Staphylococcus aureus* (ATCC, 25923) cells were quantified the same way except that agar culture medium was prepared with sterilized YBD medium containing 1.0% peptone (Becton Dickinson), 0.8% beef extract (Sigma-Aldrich), 0.3% yeast extract, 0.5% NaCl, 0.5% D-glucose (Mallinckrodt Baker), and 1.5% agar.

Instrumentation

The instrumentation designed and employed by us for bacterial inactivation experiments is illustrated in Figure 1. The f-MWCNTs/PSF composite membrane, acting as an electrode, was fixed in the reactor and electrically connected via copper plates and wires to the DC (or AC) electric power supply. A 40 mm × 20 mm stainless-steel plate was placed in the aqueous medium opposite to the composite membrane, acting as a counter-electrode. The effective membrane surface was approximately 10.2 cm² and the distance between the two electrodes was about 2.5 cm.

In DC experiments, the power supply, EPS601, was capable of a maximum voltage of 600 V and current up to 400 mA. In AC experiments, the municipal AC power supply (the dotted dash lines in Fig. 1) was employed; R is an external resistor of 3.5 kΩ, which was used for adjusting the voltage.

To evaluate the electric current's effects on bacteria, three control experiments were always performed: (1) a polysulfone membrane with no power supply (Control # 1); (2) a f-MWCNTs/polysulfone composite membrane with no power supply (Control # 2); and (3) a plain polysulfone membrane with power supply (Control # 3). Because plain polysulfone membranes have a very high electrical resistance and hence cannot afford the same current as the composite membranes, we used the highest voltage for Controls # 3: 600 V in DC experiments and 120 V in AC experiments.

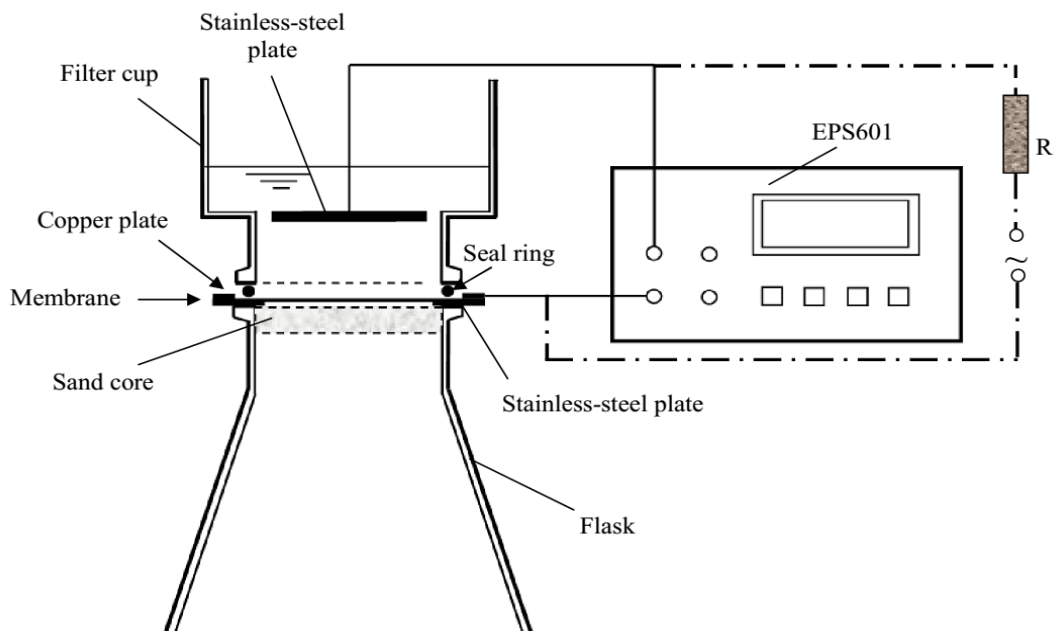

Figure 1. Schematic of experimental equipment used in this work.

Bacterial inactivation experiments

E. coli and *S. aureus* at initial concentrations of 1.5 to 2.5×10^7 CFU/mL were used in our studies herein. In deionized water experiments, some bacterial colonies were picked up with an inoculating loop from the agar plate on which they were cultured in advance and dispersed in 10 mL of water; the resultant bacterial suspension was then poured into a 250-mL volumetric flask, and water was added to scale. In salt solution experiments, extra 25 mL of 250 mM NaCl solution in deionized water was added to the volumetric flask. In both cases, 60 mL of the bacterial cell suspension thus formed was poured into the conductive membrane reactor and then supplied with a DC or an AC. Periodically, 0.1-mL aliquots were withdrawn, diluted 10 to 10^4 times, and assayed for the live bacteria titer as outlined above.

Results and Discussion

Characterization of f-MWCNTs/polysulfone composite membranes

Composite membranes with different f-MWCNT concentrations (2.5%, 4.0%, 6.0%, 8.0%, 10%, 12%, and 15% (all by weight)) were fabricated by us. The surface morphologies of both plain polysulfone membrane and composite

membranes containing 2.5%, 6.0%, and 10.0% CNTs were examined by scanning electron microscopy (SEM). As seen in Figure 2, the size of most surface pores in these four membranes is 1-3 μm and the thickness of each membrane is approximately 100 μm . Figs. 2e and 2f reveal that the membrane surfaces are much more compact than the inner layers and that the latter have a sponge-like structure. The composite membrane containing 10% of CNTs was brittle with flaws observed on its surface. Consistent with the SEM data, at CNT concentrations above 8%, the composite membranes were fragile and easily torn upon use.

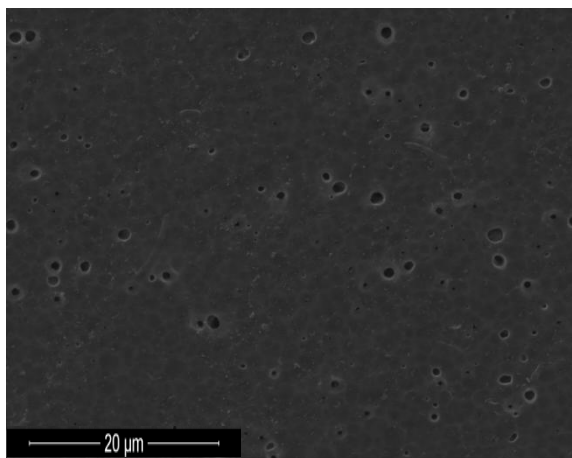

(a)

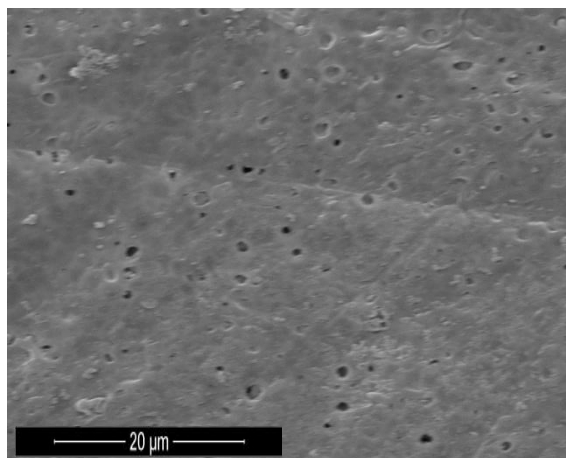

(b)

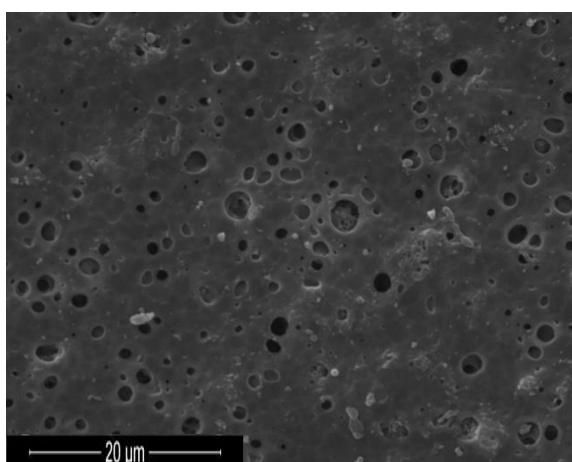

(c)

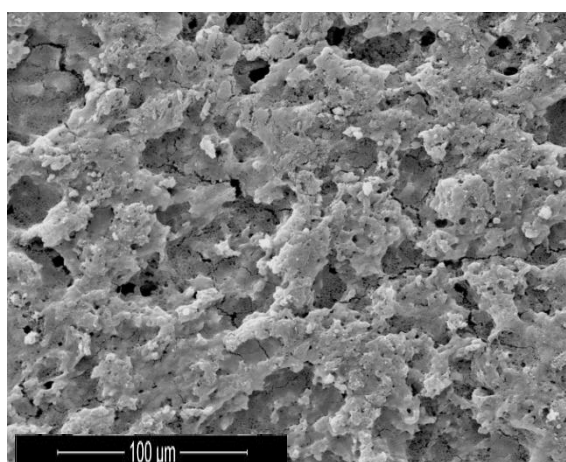

(d)

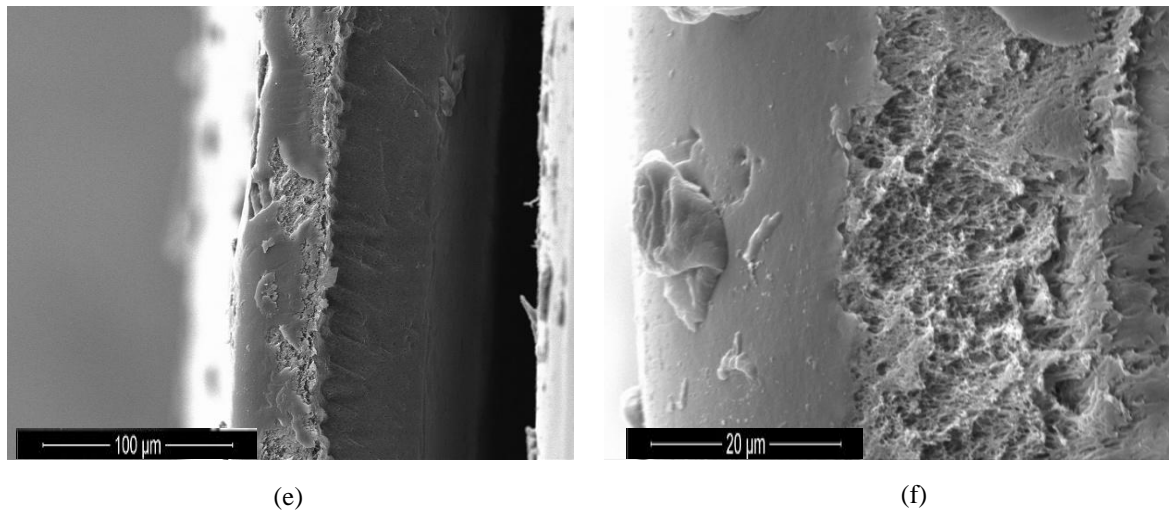
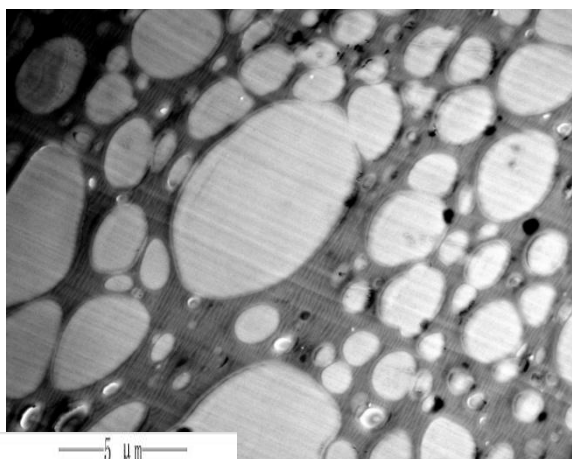

Figure 2. Scanning electron microscopic (SEM) images of plain polysulfone and f-MWCNT/polysulfone composite membranes: the surface of a plain polysulfone membrane (a), as well as that of a composite membrane with CNT concentrations (w/w) of 2.5% (b), 6.0% (c), and 10.0% (d); separately depicted are cross-section images of a plain polysulfone membrane magnified 1,000 times (e) or 5,000 times (f).

Figure 3 depicts the TEM images of the side of plain polysulfone and of f-MWCNTs/polysulfone composite membranes. In the former, one can see many bubbles of 1-5 μm in size, most of which are separated from each other and seem not to traverse the entire membrane; interspersed among those are some pores (the dark holes) with diameters of less than 1 μm . The bubbles are presumably the elements of the sponge construction, and the pores are the water passageways. A similar sponge morphology, although not as regular, is observed in the images of the composite membranes. There are also some pores in the composite membranes, but they are smaller, about 50 nm, resembling those recently described by Maphutha *et al.* [13]. Most of the CNTs are well dispersed in the polysulfone membrane matrix. Although bigger, 1-3 μm pores were detected on the membranes' upper surface by SEM, only small pores were found on the lower surface; bubbles and small pores were also found within the membrane body by TEM. Therefore, the big pores observed on the upper surface are not necessarily penetrating the membrane, but may have larger diameter openings on the upper surface and smaller diameter openings within the membrane body and/or on the lower surface. Note that the smaller the pores, the more bacteria are retained by the membrane and

subsequently killed by electric current. On the other hand, the smaller the pores, the slower the flux through the membrane is. Therefore, an appropriate balance is required.



(a)

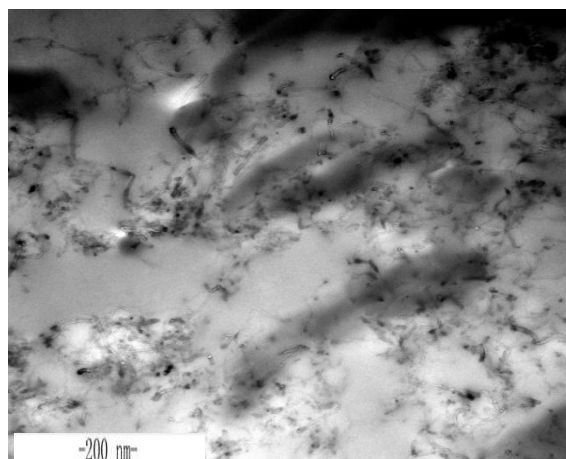

(c)

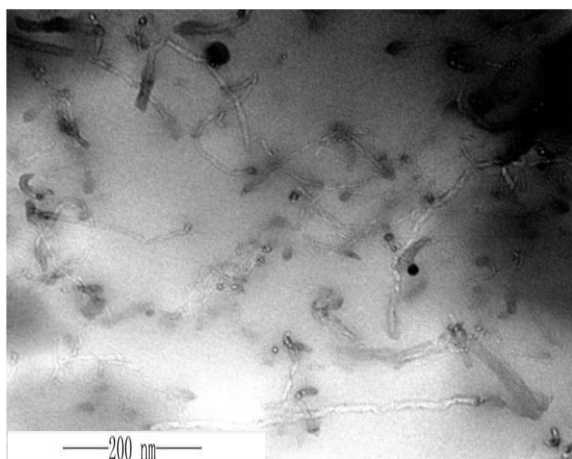

(b)

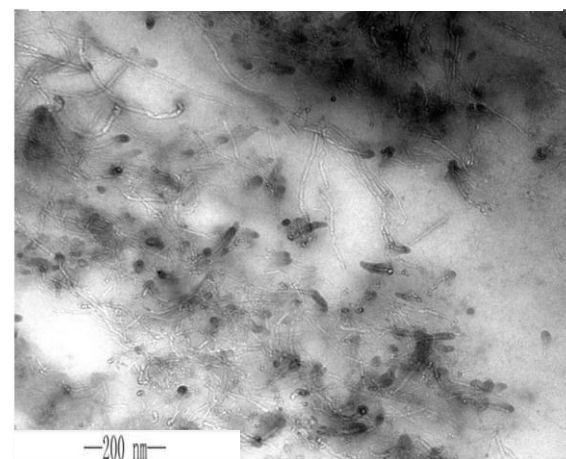

(d)

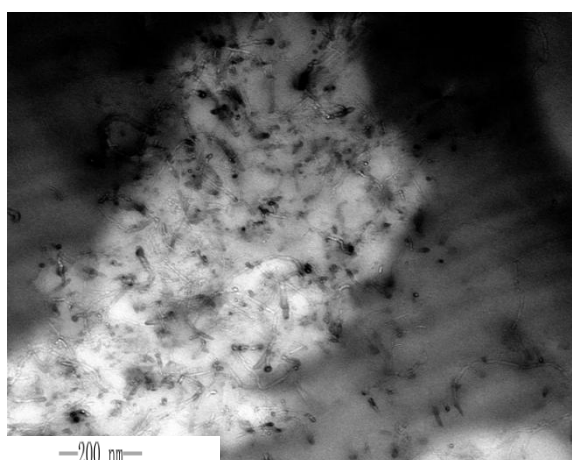

(e)

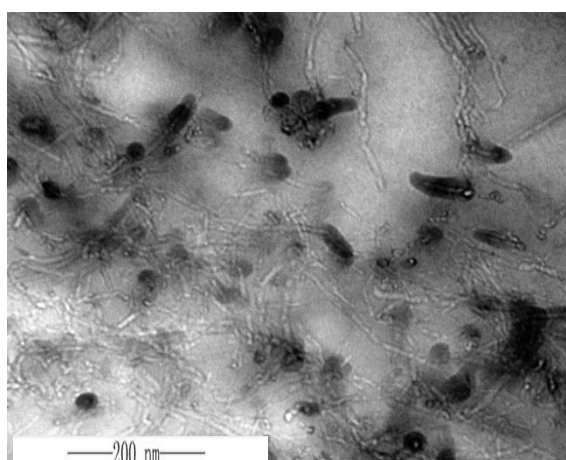

(f)

Figure 3. Transmission electron microscopic (TEM) images of plain polysulfone and f-MWCNT/polysulfone composite

membranes: the side view of a plain polysulfone membrane magnified 7,000 times (a) and of composite membranes with a CNT concentration of 6.0% magnified 8,000 times (b), 2.5% magnified 20,000 times (c), 6.0% magnified 120,000 times (d), 10% magnified 120,000 times (e), and 6.0% magnified 200,000 times (f).

The electrical conductivity of the f-MWCNT/polysulfone composite membranes, measured using an ANNOVA multimeter, was found to improve with increasing the concentration of the CNTs. For example, without CNTs, the electrical resistance was above 40 M Ω (exceeding the measurement limit), while the conductivities were about 0.07 and 0.1 S/m at 2.5 and 6.0% CNT concentrations, respectively. However, at CNT concentrations exceeding 8%, the membranes' tensile strength also dropped. Therefore, the composite membrane with a 6.0% CNT concentration was chosen for all subsequent experiments.

Inactivation of *E. coli* and *S. aureus* by a direct current (DC) in the presence of composite membranes

Initial inactivation experiments were conducted on *E. coli* and *S. aureus* in deionized water and in 25 mM NaCl aqueous solution under different DC conditions. Electrolysis of NaCl apparently occurred in the salt solution experiments as evidenced by pH substantially increasing with time, especially when the current exceeded 10 mA. To avoid this complication and associated possible artifacts, only bacterial inactivation in deionized water was examined in all further DC studies.

Figures 4 and 5, respectively, depict the time dependence of C/C_0 , in which C_0 is the initial *E. coli* or *S. aureus* concentration and C is that at certain time periods during the experiments. As seen in the figures, there was no appreciable inactivation of either bacteria for up to at least one hour in the three control experiments, namely no electric current with either a plain polysulfone or the 6% f-MWCNT/polysulfone composite membranes (Controls # 1 and 2, respectively) or up to a 600 V DC applied in conjunction with the plain polysulfone membrane (no CNTs; Control # 3). In stark contrast, both kinds of bacteria were inactivated when electric current was applied in the presence of the composite membranes; moreover, the stronger the current the greater was the degree of inactivation (Figs. 4 and 5). These observations point to the critical role of the membrane-embedded CNTs in killing bacteria using DC.

In the case of *E. coli*, half of the bacteria were killed in less than 5 min at a 2 mA DC current (Fig. 4). When the current was raised to 3 mA (the energy input of approximately 0.5 W·h), over 99.999% of the bacteria were killed within 20 min. As seen in Fig. 4, the time courses of *E. coli* inactivation under these conditions are satisfactorily approximated by first-order kinetics (all three correlation coefficients exceeded 0.92).

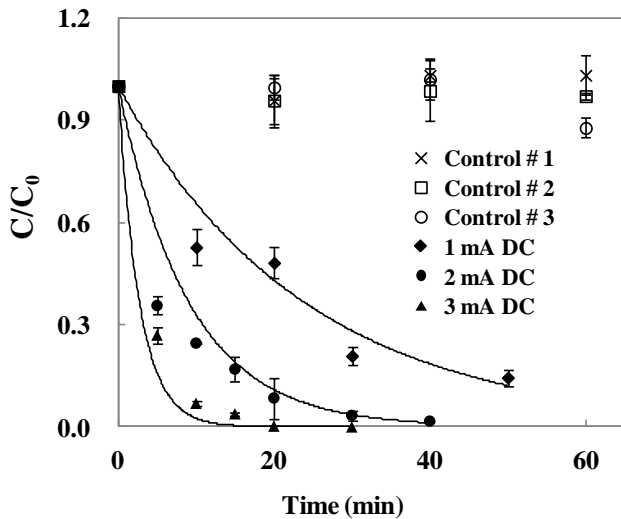

Figure 4. Effect of a direct current (DC) on *E. coli* in deionized water in the presence of either plain polysulfone or the 6% f-MWCNT/polysulfone composite membranes. See text for further details.

The inactivation patterns for *S. aureus* (Fig. 5) were similar to, but slower than those of, *E. coli*. In this case, a 5-log inactivation of the bacteria required 40 min with a 5 mA current and an energy input of approximately 1.5 W·h. Again, the time courses of bacterial inactivation under these conditions are satisfactorily approximated by first-order kinetics (all three correlation coefficients exceeded 0.94; Fig. 5). Note that for both *E. coli* and *S. aureus*, there was no significant temperature increase of the bacterial suspensions during the experiments, thereby ruling out this potential artifact.

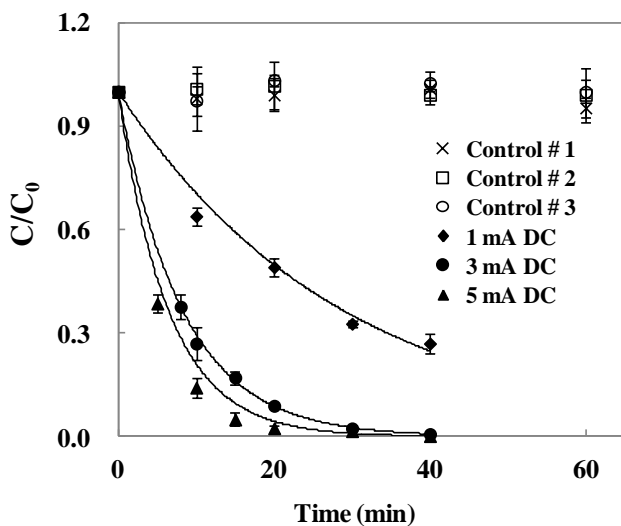

Figure 5. Effect of direct current (DC) on *S. aureus* in deionized water in the presence of either polysulfone or the 6% f-MWCNT/polysulfone composite membranes. See text for further details.

Inactivation of *E. coli* and *S. aureus* in a 25 mM NaCl solution in water by alternating current (AC) in the presence of composite membranes

As stated above, pronounced electrolysis of NaCl occurred when DC was applied to its aqueous solution. This was not the case with AC under the conditions used herein as described below. A municipal AC output source and a resistor were employed to adjust the municipal AC voltage to a suitable range. When the total AC input voltage was 120 V and the external resistance 3.4 k Ω , the electric current was approximately 35 mA.

As with DC (Figs. 4 and 5), no appreciable inactivation of either *E. coli* or *S. aureus* over at least one hour was observed (Figs. 6 and 7) in the control experiments where no current was applied to the bacterial suspensions over a plain polysulfone or the f-MWCNT/polysulfone composite membranes or when a 120-V AC was applied in conjunction with the plain polysulfone membrane. However, with the composite membranes containing CNTs, AC resulted in a marked inactivation of *E. coli*: some 95% of the bacteria killed after 60 min when the energy input was approximately 0.4 W·h (Fig. 6).

Qualitatively similar but slower inactivation was observed in the case of *S. aureus*, where about 80% of the bacteria were killed after 60 min (Fig. 7). Hence both of these representative bacteria were inactivated far more efficiently by DC than AC under the conditions used. Again, no significant temperature increase in either of the bacterial suspensions was observed during the experiments.

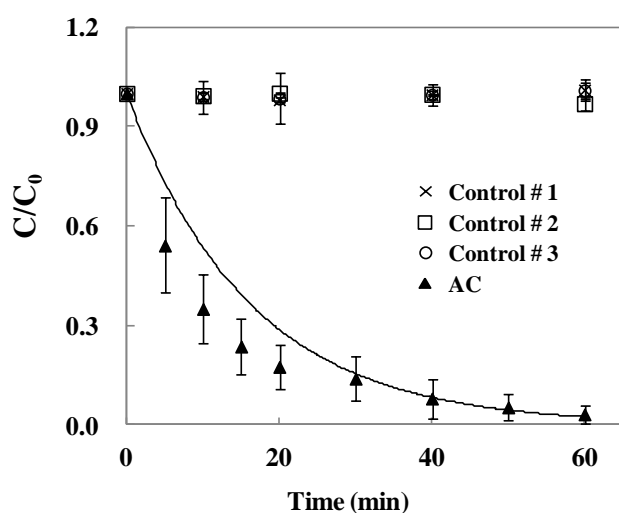

Figure 6. Effect of alternating current (AC) on *E. coli* in 25 mM NaCl aqueous solution in the presence of either polysulfone or the 6% f-MWCNT/polysulfone composite membranes. See text for further details.

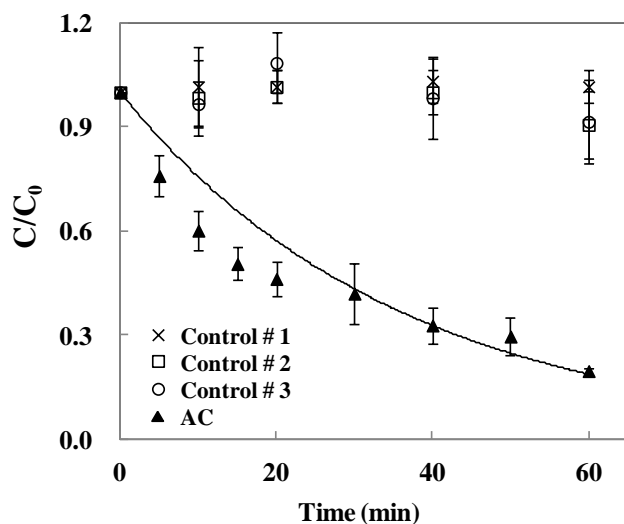

Figure 7. Effect of alternating current (AC) on *S. aureus* in 25 mM NaCl aqueous solution in the presence of either polysulfone or the 6% f-MWCNT/polysulfone composite membranes. See text for further details.

To summarize, in this study we have demonstrated that representative Gram-negative and Gram-positive pathogenic bacteria can be vigorously inactivated by electric current (DC and AC) in the presence of composite polymeric membranes with f-MWCNTs uniformly distributed within (and hence retained by) them. In light of the foregoing results (Figs. 4-7), killing of the bacteria requires both current and the CNTs since no bacterial inactivation was detected with plain polysulfone membranes under otherwise the same conditions without current. These observations point to direct bacterial inactivation by electric current enabled by electrically conductive CNTs embedded within the composite membranes.

Acknowledgements

This study was financially supported in part by the Infectious Diseases Research Center at MIT funded by the Skolkovo Foundation and by the National Natural Science Foundation of China (21277173).

References

1. Shannon, M.A., Bohn, P.W., Elimelech, M., Georgiadis, J.G., Mariñas B.J., & Mayes, A.M. (2008). Science and technology for water purification in the coming decades. *Nature*, 452, 301-310.
2. Liu, C., Xie, X., Zhao, W., Liu, N., Maraccini, P.A., Sassoubre, L.M., Boehm, A.B., & Cui, Y. (2013). Conducting

- nanosponge electroporation for affordable and high-efficiency disinfection of bacteria and viruses in water. *Nano Lett.*, *13*, 4288-4293.
3. Serrano, M.C., Gutiérrez, M.C., del Monte, F. (2014). Role of polymers in the design of 3D carbon nanotube-based scaffolds for biomedical applications. *Progr. Polym. Sci.*, *39*, 1448–1471.
 4. Gardea, F., & Lagoudas, D.C. (2014). Characterization of electrical and thermal properties of carbon nanotube/epoxy composites. *Composites: Part B*, *56*, 611-620.
 5. de Volder, M.F.L., Tawfick, S.H., Baughman, R.H., & Hart, A.J. (2013). Carbon nanotubes: present and future. *Comm. Appl. Sci.*, *339*, 535-539.
 6. Ramasubramaniam, R., Chen, J., & Liu, H.Y. (2003). Homogeneous carbon nanotube/polymer composites for electrical applications. *Appl. Phys. Lett.*, *83*, 2928-2930.
 7. Cadek, M., Coleman, J.N., Barron, V., Hedicke, K., & Blau, W.J. (2002). Morphological and mechanical properties of carbon-nanotube-reinforced semicrystalline and amorphous polymer composites. *Appl. Phys. Lett.*, *81*, 5123-5125.
 8. Coleman, J.N., Cadek, M., Blake, R., Nicolosi, V., Ryan, K.P., Belton, C., Fonseca, A., Nagy, J.B., Gun'ko, Y.K., & Blau, W.J. (2004). High performance nanotube-reinforced plastics: understanding the mechanism of strength increase. *Adv. Funct. Mater.* *14*, 791-798.
 9. Dalmas, F., Chazeau, L., Gauthier, C., Masenelli-Varlot, K., Dendievel, R., Cavallé, J.Y., & Forró, L. (2005). Multiwalled carbon nanotube/polymer nanocomposites: processing and properties. *J. Polym. Sci. B. Polym. Phys.*, *43*, 1186-1197.
 10. Dufresne, A., Paillet, M., Putaux, J.L., Canet, R., Carmona, F., Delhaes, P., & Cui, S. (2002). Processing and characterization of carbon nanotube/poly(styrene-co-butyl acrylate) nanocomposites. *J. Mater. Sci.*, *37*, 3915-3923.
 11. McCarthy, B., Coleman, J.N., Czerw, R., Dalton, A.B., Panhuis, M.I.H., Maiti, A., Drury, A., Bernier, P., Nagy, J.B., Lahr, B., Byrne, H.J., Carroll, D.L., & Blau, W.J. (2002). A microscopic and spectroscopic study of interactions between carbon nanotubes and a conjugated polymer. *J. Phys. Chem. B*, *106*, 2210-2216.
 12. Chiu, F.C., & Kao, G.F. (2012). Polyamide 46/multi-walled carbon nanotube nanocomposites with enhanced thermal, electrical, and mechanical properties. *Composites: Part A*, *43*, 208-218.
 13. Maphutha, S., Moothi, K., Meyyappan, M., & Iyuke, S.E. (2013). A carbon nanotube-infused polysulfone membrane with poly(vinyl alcohol) layer for treating oil-containing waste water. *Sci. Reports*, *3*, 1509-1514.
 14. Zhao, H., Qiu, S., Wu, L., Zhang, L., Chen, H., & Gao, C. (2014). Improving the performance of polyamide

- reverse osmosis membrane by incorporation of modified multi-walled carbon nanotubes. *J. Membrane Sci.*, *450*, 249-256.
15. Sun, X., Wu, J., Chen, Z., Su, X., & Hinds, B.J. (2013). Fouling characteristics and electrochemical recovery of carbon nanotube membranes. *Adv. Funct. Mater.*, *23*, 1500-1506.
 16. Shawky, H.A., Chae, S. R., Lin, S., & Wiesner, M. R. (2011). Synthesis and characterization of a carbon nanotube/polymer nanocomposite membrane for water treatment. *Desalination*, *272*, 46-50.
 17. Kar, S., Subramanian, M., Pal, A., Ghosh, A.K., Bindal, R.C., Prabhakar, S., Nuwad, J., Pillai, C.G.S., Chattopadhyay S., & Tewari, P.K. (2012). Preparation, characterization and performance evaluation of anti-biofouling property of carbon nanotube polysulfone nanocomposite membranes. *Carbon Mater.*, *1538*, 181-185.
 18. Gethard, K., Sae-Khow, O., & Mitra, S. (2011). Water desalination using carbon-nanotube-enhanced membrane distillation. *ACS Appl. Mater. Interfaces*, *3*, 110-114.
 19. Corry, B. (2008). Designing carbon nanotube membranes for efficient water desalination. *J. Phys. Chem. B*, *112*, 1427-1434.
 20. Shen, J., Yu, C., Ruan, H., Gao, C., & Van der Bruggen, B. (2013). Preparation and characterization of thin-film nanocomposite membranes embedded with poly(methyl methacrylate) hydrophobic modified multi-walled carbon nanotubes by interfacial polymerization. *J. Membrane Sci.*, *442*, 18-26.
 21. Yin, J., Zhu, G., & Deng, B. (2013). Multi-walled carbon nanotubes (MWNTs)/polysulfone (PSU) mixed matrix hollow fiber membranes for enhanced water treatment. *J. Membrane Sci.*, *437*, 237-248.
 22. Vecitis, C.D., Schnoor, M.H., Rahaman, S., Schiffman, J.D., & Elimelech, M. (2011). Electrochemical multiwalled carbon nanotube filter for viral and bacterial removal and inactivation. *Environ. Sci. Technol.*, *45*, 3672-3679.
 23. Rahaman, M.S., Vecitis, C.D., & Elimelech, M. (2012). Electrochemical carbon-nanotube filter performance toward virus removal and inactivation in the presence of natural organic matter. *Environ. Sci. Technol.*, *46*, 1556-1564.
 24. de Lannoy C.F., Jassby, D., Davis, D.D., & Wiesner, M.R. (2012). A highly electrically conductive polymer–multiwalled carbon nanotube nanocomposite membrane. *J. Membrane Sci.*, *415-416*, 718-724.
 25. de Lannoy, C.F., Jassby, D., Gloe, K., Gordon, A.D., & Wiesner, M.R. (2013). Aquatic biofouling prevention by electrically charged nanocomposite polymer thin film membranes. *Environ. Sci. Technol.*, *47*, 2760-2768.
 26. Zhang, Q., & Vecitis, C. D. (2014). Conductive CNT-PVDF membrane for capacitive organic fouling reduction. *J.*

Membrane Sci., 459, 143-156.

27. Katathikankul, C., Techangamvong, S., Wimolmala, E., Niltui, P., Kanking, S., & Sombatsompop, N. (2013). Antibacterial ability of HPQM base Neusilin/natural rubber reinforced with carbon black. *Adv. Mater. Res.*, 747, 455-458.