

**UNDERSPECIFICATION
IN YAWELMANI PHONOLOGY AND MORPHOLOGY**

by

DIANA BENNETT ARCHANGELI

B.A. Washington State University
(1974)

M.A. University of Texas at Austin
(1981)

Submitted to the Department of
Linguistics and Philosophy
in Partial Fulfillment of the Requirements
for the Degree of

DOCTOR OF PHILOSOPHY
IN LINGUISTICS AND PHILOSOPHY

at the

MASSACHUSETTS INSTITUTE OF TECHNOLOGY

June 1984

© Diana Bennett Archangeli, 1984

The author hereby grants to M.I.T. permission to reproduce
and to distribute copies of this thesis document in whole
or in part.

Signature of Author _____
Department of Linguistics and Philosophy
May 4, 1984

Certified by _____
Professor Morris Halle
Thesis Supervisor

Accepted by _____
Professor S. Jay Keyser, Chairman
Department of Linguistics and Philosophy

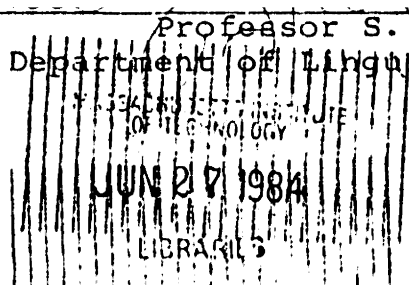

UNDERSPECIFICATION
IN YAWELMANI PHONOLOGY AND MORPHOLOGY

by

DIANA BENNETT ARCHANGELI

Submitted to the Department of Linguistics and Philosophy
on May 4, 1984
in partial fulfillment of the requirements
for the degree of
Doctor of Philosophy in Linguistics

ABSTRACT

This study of Yawelmani phonology and morphology provides insight into the types of phonological representations and rules permitted by Universal Grammar.

Generalizations about the sound pattern of a language which can be expressed by rule are omitted from underlying representation in all brands of phonological theory. Proposed here is a theory of underspecification which exploits this concept and so allows for simplification of both representations and rules. Underlying representations contain only the information that is absolutely necessary to distinguish between representations. Any information that is predictable, i.e. derivable by rule, is unspecified. "Information" here refers to all types of phonological characteristics, stress, syllable structure, templates, phonemes, and features. It is argued that the redundancy rules, i.e. the rules that fill in the unspecified values, are a combination of universal rules (which are cost-free) and learned rules (which are costly). In other words, what is unspecified in any given language is determined by both the details of that language and the principles of Universal Grammar. These redundancy rules are universally ordered late, with two exceptions. Earlier ordering of some rule can be provided by principles of Universal Grammar, i.e. intrinsic ordering (which is cost-free) or can be learned, i.e. extrinsic ordering (which must have clear motivation and is costly).

Non-linear representations figure centrally in this analysis of Yawelmani. It is shown that Yawelmani has a template-supplying morphology in both the verbal and noun systems (similar to certain Semitic languages). Interestingly, in most cases, the templates are supplied by affixes, and are meaningless without the affix. Besides the morphologically supplied syllabic templates, there is motivation for seven planes in the representation: The syllabification process consists of a syllable plane and a syncope tree plane; stress trees and a stress grid provide two more planes; vowels and consonant melodies constitute the fifth and sixth planes. The glottal stop in certain morphemes is on a plane of its own: A seventh plane. Examination of vowel harmony does not create an eighth plane. Evidence reveals that the harmonizing feature and the conditioning feature are on a single plane, but in separate matrices. The matrix of the harmonizing feature spreads on the single plane to the conditioning matrices.

Thesis supervisor: Professor Morris Halle

Title: Institute Professor

to my parents
with love

ACKNOWLEDGEMENTS

Major projects, like renovating a house or writing a thesis, share certain characteristics. Neither the house nor the thesis ends up being quite what you planned at the outset, and neither task can reach completion in isolation: Help from experienced hands and encouragement from friends is essential. The results of this venture are here to be observed and evaluated. The assistance received along the way is less visible. I take the opportunity to acknowledge that assistance here.

The master craftsmen on this project were Morris Halle, Jim Harris, and Jay Keyser. Morris is a rare blend of supervisor, co-worker, and Aesop. If I am truly changing from being an apprentice to being a craftsman myself, it is largely the result of working under Morris's direction. If I am a wiser person after the past three years, it is largely the result of Morris's fables.

Jim doggedly pursued implication after implication to help me see what exactly was being said. I hope I have learned some of his patient attention to detail. He also provided an informal second test case for underspecification theory by constantly examining his wealth of Spanish data in light of the proposals here. Jay one day had a full-blown theory of underspecification dropped on his lap. His reaction to that draft made me realize how much I was assuming rather than stating clearly.

Paul Kiparsky, K.P. Mohanan, and Doug Pulleyblank all contributed to my development as a phonologist. They also were the first to encourage me in my explorations of the theory of underspecification. It was a privilege to work with each of them.

Special thanks are due to John Lord, who introduced me to linguistics, and to John McCarthy, who introduced me to non-linear phonology. Both have remained generously interested and supportive. I am also grateful to Stanley Newman for readily answering my queries about the Yokuts data.

Thanks are owed also to Mike Hammond, Juliette Levin, and Malka Rappaport for their willingness to discuss this work with me, particularly as I became less willing to reciprocate as this year progressed.

A singular and very welcome support came from Nigel Fabb and Lisa Travis in particular, and also from Grant Goodall, Mario Montalbetti, and Mamoru Saito. We shared thesis agony this spring, and it has been a constant reassurance to watch others losing touch with mundane affairs and know I'm not the only one. In a similar vein, my office-mates Malka Rappaport and Andy Barss deserve special recognition. Malka proved that thesis madness is not a lasting affliction, and both tolerated a continual barrage of Yawelmani data, despite its being more than they needed to know.

There are many others in the linguistics community who have helped to satisfy my intellectual and/or emotional needs, perhaps without realizing it. Foremost among these is Base Generation/Monads; also Mark Baker, Maggie Carracino, Becky Gutmann, Isabelle Haik, Kyle Johnson, Judy Kegl, Beth Levin, Margaret Magnus, Diane Massam, Tara Mohanan (who also helped by proofreading), Nancy Peters, Tova Rapaport, Anne Rochette, Haj Ross, Peggy Speas, Richard Sproat, Jan Wager, Betsy Walli, Meg Withgott, and Munther Younes.

The act of writing this thesis involved both the "normal" problems one encounters in expository writing and certain technical difficulties, with the advent of word-processing. The clarity that one finds here is due largely to two factors, the plaintive wail "but what are the assumptions?" from the students of 24.961 (Fall 1984) and Jay Keyser's incessant exhortation on the margins: "UNPACK!" Sylvain Bromberger, Nigel Fabb, and Ron Wilson served as an invaluable word-processing community.

Finally, the wonderful pictures in Chapter 1 are Dante's handiwork; he has given more to the completion of this thesis than perhaps anyone.

TABLE OF CONTENTS

ABSTRACT	2
ACKNOWLEDGEMENTS	5
Chapter 1 INTRODUCTION	11
1.1 Surface and Underlying Representations	13
1.2 Rule Interaction	25
1.3 A Historical Perspective	27
1.4 A Comparison	29
Appendix Rule-Writing Notation	34
Chapter 2 UNDERSPECIFICATION	35
2.1 Full, Partial, and Underspecification	38
2.1.1 Full Specification	39
2.1.2 Partial Specification	40
2.1.3 Underspecification	41
2.2 The Alphabet	43
2.2.1 The Rules	46
2.2.2 The Matrix	48
2.2.3 Latvian Raising	51
2.3 Underspecification Theory	55
2.3.1 Default Rules and Complement Rules	57
2.3.2 Redundancy Rules	60
2.3.3 Complement Rule Formation	64
2.4 Yawelmani Vowels	72
2.4.1 Underlying Representation	73
2.4.2 Vowel Harmony in Brief	78
2.4.3 The Redundancy-Rule Ordering Constraint	83
2.4.4 Two Other Rules -- Epenthesis and Dissimilation	94
2.5 Yawelmani Consonants	96

2.5.1	Sonorants	99
2.5.2	Obstruents, Nasals, and Laterals	104
2.5.3	Underlying Representations and Redundancy Rules for Consonants	107
2.6	A Comparison with Markedness Theory	111
Appendix	Default Rules and the Yawelmani Vowel Alphabet	115
Chapter 3	PHONOLOGY	117
3.1	Vowel Quality	120
3.1.1	Spread vs. Copy	121
3.1.1.1	Yawelmani Lowering	125
3.1.1.2	Gashowu Lowering	130
3.1.1.3	Discussion	132
3.1.2	Uniplanar, Biplanar, and Coplanar Representations	136
3.1.2.1	Yawelmani Harmony	145
3.1.2.2	Gashowu Harmony	148
3.1.3	Implications	152
3.1.3.1	The Shared Feature Convention	153
3.1.3.2	The Branching Features Constraint	155
3.1.3.3	The Structure of the Melody	157
3.2	Syllable Structure	162
3.2.1	Underlying Representations	163
3.2.1.1	Underlying Syllable Structure	176
3.2.1.2	Association to the Template	170
3.2.2	Syllable Structure	172
3.2.3	Core Syllabification	175
3.2.4	Syllabification Rules	178
3.2.4.1	Shortening	178
3.2.4.2	Epenthesis	182
3.2.4.3	Syncope	184
3.2.4.4	Elision	195
3.2.5	Exceptions to Rime Formation/Shortening	198
3.2.5.1	<u>(i)(l)saa</u> 'causative-repetitive'	198
3.2.5.2	Retardative Activity	201
3.2.5.3	<u>xoo</u> 'durative auxiliary'	203
3.2.6	Exceptions to Syncope	206
3.2.6.1	Three Affixes not Undergoing Syncope	207
3.2.6.2	Case Affixes	208
3.2.6.3	Optional Deletion with <u>(?)iñay</u> 'contemporaneous gerundial'	209
3.3	Stress	211

3.3.1	The Representation of Stress	215
3.3.1.1	Trees	215
3.3.1.2	Extrametricality	218
3.3.2	Yawelmani Stress	224
3.3.2.1	Antepenultimate Stress	228
3.3.2.2	Antepenultimate Stress in Nouns	232
3.3.3	Implications for Stress Theory	237
Appendix Phonological Rules of Yawelmani		241
Chapter 4 MORPHOLOGY		245
4.1	Template--Supplying Affixes	250
4.1.1	How to Supply a Template	255
4.2	The Templates	261
4.2.1	Neutral Templates	261
4.2.2	Consonant and Vowel Melodies	267
4.3	Templates Supplied to Verbs by Affixes	271
4.3.1	The Six Templates	271
4.3.2	The Template Pool	276
4.3.3	Additional Support	278
4.3.3.1	Floating Consonants	279
4.3.3.2	Floating Glottal Stop	282
4.4	Classification of Verbal Suffixes	288
4.4.1	Regular Affixes	289
4.4.2	Template-Supplying Affixes	292
4.4.3	Template-Supplying Affixes with Limited Application	294
4.4.4	Template-Supplying Affixes with Interesting Associations	296
4.4.4.1	<u>(i)(l)saa</u> 'causative-repetitive'	297
4.4.4.2	<u>d(aa)</u> 'repetitive'	299
4.4.4.3	<u>(?)ii</u> 'causative'	301
4.4.4.4	<u>?aa</u> 'durative'	303
4.4.4.5	<u>(?)iñay</u> 'contemporaneous gerundial'	308
4.5	Classification of Noun Morphology	309
4.5.1	Case	311
4.5.1.1	CC]-Final Nouns	311
4.5.1.2	Cxx]-Final Nouns	312
4.5.1.3	CxC]-Final Nouns	314
4.5.1.4	xxC]-Final Nouns	315
4.5.1.5	Generalizations about Case Affixes	315

4.5.2	Template Activity	318
4.5.2.1	Collapsing Templates	319
4.5.2.2	Items Undergoing Template Affixation	326
4.5.3	Floating Segments	329
4.5.3.1	Floating [+G] -- (?) <u>in</u> 'attributive'	329
4.5.3.2	Floating [+G] -- (?) <u>inin</u> 'resident of'	330
4.5.3.3	Floating [+G] -- (?) <u>aa</u> 'inchoative'	331
4.5.3.4	CxCCC + (<u>m</u>) <u>aam</u> 'decedent'	332
4.5.3.5	(<u>n</u>) <u>iit</u> 'decedent'	333
4.5.4	Floating Vowels	334
4.5.4.1	<u>taa</u> , <u>yaa</u> 'causative inchoative'	336
4.5.4.2	CxCCC 'plural'	341
4.5.5	Catalog of Affixes on Nouns	343
4.5.5.1	A Catalog of N-->V Morphology	343
4.5.5.2	<u>naa</u> Affixation	345
4.5.5.3	"Ø" Affix 'characteristic activity'	345
4.5.5.4	A Catalog of N-->N Morphology	346
4.6	The Template Pool	349
4.7	Conclusion	350
	REFERENCES	352

Chapter 1

INTRODUCTION

All theories of phonology agree that the representations that underlie concrete phonetic forms do not contain all the phonetic information, as the missing information is nondistinctive or redundant. Underspecification Theory, which I develop in this thesis, is an attempt at understanding what information is necessarily contained in underlying representation and what mechanisms are available for providing the missing information. It is a study of the nature of phonological representations and of the formal properties of the rules that provide the full specification.

These representations and rules differ in a number of ways from those found in earlier models of phonology incorporating "underspecification", for example the structuralists' "archiphonemes" and Chomsky and Halle's (1968) (henceforth SPE) "markedness conventions" (further developed in Kean 1975). The most fundamental difference between my approach and the previous approaches is that in the former, both distribution and alternations constitute the basis for resolving these questions, while in the latter, questions of underspecification are resolved on the basis of distributional evidence alone. Furthermore, the underspecified representation argued for here has only the bare minimum of information present: No feature has both "+" and "-" (in different matrices) in underlying representation. A feature has the value "a" (either "+" or "-", not both) and the value

"-a" is supplied by rule elsewhere, or the feature has no value at all in underlying representation and both "a" and "-a" are supplied by rule. The same goes for other facets of the phonological representation, syllable structure, stress, etc. In other words, underspecification theory applies to all phonological information, not simply to feature values. The phonological representation in current non-linear models includes such items as skeletal slots, syllable structure, trees, and a grid, none of which were a formal part of the representation when "underspecification" was examined previously. I suggest that all types of structure are subject to the same constraints that feature specification is subject to.

The information absent in underlying representation is supplied by redundancy rule which may be either language specific or universal. This approach shares traits with the "archiphoneme", which is a language dependent entity, and with "markedness conventions", which are language universal rules. A further trait of the theory developed here is that values not present in underlying representation are not necessarily specified prior to application of phonological rules: True phonological rules interact with the redundancy rules of the language. This interaction allows simplification of phonological rules and of representations; it also suggests a means of expressing which rules create new segments and which rules do not create new segments.

Which phoneme is least specified, and what the specifications for each phoneme are, is language dependent, based primarily on the phonological alternations of that language. Unlike markedness theory, cross-linguistic distributional facts are not the basis for deciding the relative specification of any given phoneme. It is this partial dependence on language particular alternations which

1.1 -- Surface and Underlying Representations

allows the underspecified matrices and the redundancy rules to simplify the grammar.

1.1 Surface and Underlying Representations

The phonological representation which I assume here contains several interrelated components, the core skeleton, melodies, structures, and the relationships between melodies or structures and the core skeleton. In this section, we examine the complete surface representation of a single word and remove the redundant information, i.e. that information which is supplied by rule. In so doing, we also examine each component which makes up the representation: The core skeleton, the melodies, the structures, the "planes".

The surface phonological representation of the word yawelmani 'tribal name-pl.', Newman p. 208 is as (1.1).

(1.1)

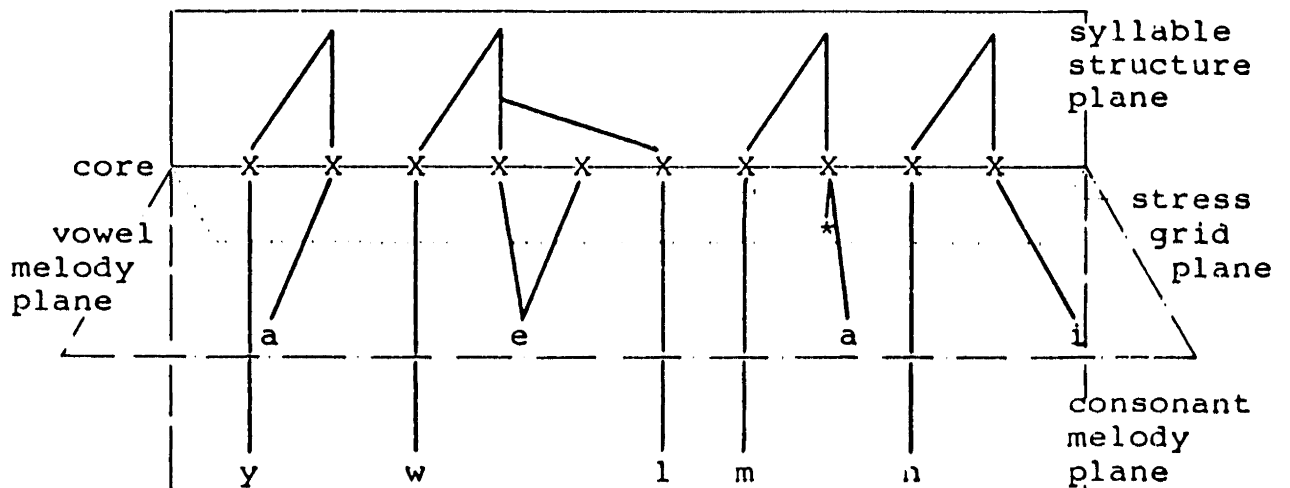

There is a lot of information packed into the above figure, and a two-dimensional page can not do justice to the formalism behind the metaphor. Let us unpack the information

1.1 -- Surface and Underlying Representations

plane by plane, and in so doing reduce the surface representation to the underlying representation.

As a first step in uncovering a more abstract representation, we remove the final rime and vowel: The rime and vowel constitute a case affix (Subject case: See Chapter 4.5.1). We examine the caseless stem yawelman/-.

Syllable Structure Plane

The figure (1.1) contains four separate planes intersecting in a single line constituted of a sequence of Xs, which is called the core skeleton (see Chapter 3, section 2):¹

(1.2)

X X X X X X X X X

This string corresponds to the string of Xs which are present in the representation in (1.1) above without the case affix. The nine Xs in (1.2) do not suffice for the underlying representation of this word. We need to know the number of syllables in the word: To do this, we establish to know only the number and location of the syllable heads ("rimes"). Syllable heads are denoted by a vertical line "|" anchored in an X; non-head positions in a syllable are denoted by an angled line "/" or "\". Once we locate the rimes, the rest of

1. This is not simply a notational variant of the skeleton in terms of a sequence of [+syllabic] ("V") and [-syllabic] ("C") slots (cf. McCarthy 1979), as shown by Levin (1983, to appear, in prep.) who presents arguments for differentiating the two notations, some of which are found in Chapter 3, section 2.1.

1.1 -- Surface and Underlying Representations

the syllable structure can be built by rules.

(1.3)

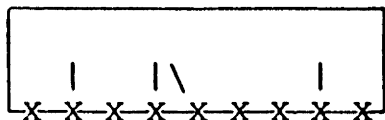

In (1.3) we see the rudiments of a first plane, syllable structure, where three rimes are represented. Although there is not much syllable structure present in (1.3), it still contains redundant information: A rule of epenthesis (3.110) inserts the penultimate rime, so this rime is not present in underlying representation:

(1.3) cont.

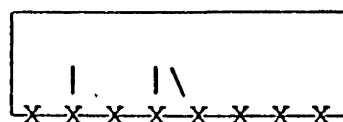

underspecified
syllable structure plane

The above is the underlying skeleton template for the word yawelmani. The syllable structure is underspecified. Only rimes are permitted in underlying representation, and only those rimes whose location is unpredictable actually appear in underlying representation. Rules of syllabification provide the missing syllable structure, to give the completely syllabified form in (1.1).

The template itself is supplied by the morphology: In the singular the word is yawlamnii/-. (See Chapter 4 for a discussion of the template-supplying morphology.) Syllabification rules bracket the Xs into units, called syllables. In Yawelmani, each syllable must have one non-head unit to the left and may have one to the right. Notationally, the following are well-formed Yawelmani syllables:

(1.4)

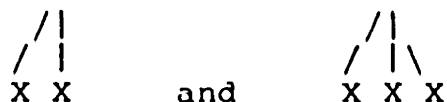

1.1 -- Surface and Underlying Representations

These are constructed by a set of rules from the underlying minimally specified string:

(1.5) (=1.3 cont.)

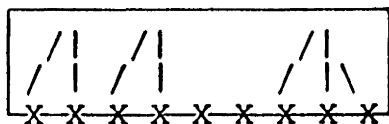

fully specified
syllable structure plane

A fourth syllable is created by the affixation of i 'subject', resulting in:

(1.5) cont.

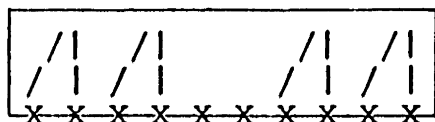

From this, we see that the set of all Xs are possible anchors for syllable structure and that the syllables themselves, with their anchors, constitute the plane.

Consonant Melody Plane

In Yawelmani the phonetic values of the skeleton slots are given in two separate planes, one for the consonants (given immediately below) and the other for the vowels. This is one of several respects in which Yawelmani resembles the Semitic languages (see McCarthy 1979, etc.). The five consonants of the word yawelman/- do not associate freely with the Xs of the core skeleton. Only certain Xs are permissible anchors, namely those Xs unsyllabified in underlying representation. The consonant plane is defined by the consonant melody (true consonants and glides) and by the anchors (unsyllabified X slots):

(1.6)

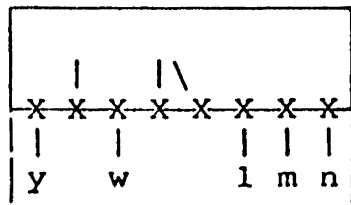

fully specified
consonant melody plane

Association between the consonant melody and its anchors follows from the Universal Association Convention and does not violate the Wellformedness Condition, both given below.²

(1.7)

Universal Association Convention

- Associate autosegments and autosegment-bearing units
- i. one-to-one
 - ii. left-to-right

The Universal Association Convention (1.7) takes the underlying representation in (1.8a) and provides the linking in (1.8b), where Ps and Xs together define a plane:

(1.8)

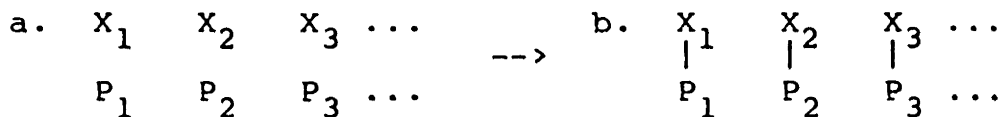

(1.9)

Wellformedness Condition³

Association lines can not cross.

The Wellformedness Condition prevents representations like the

2. These conventions differ substnatively from earlier proposals to be found in the literature, see Goldsmith (1976), Halle and Vergnau (1980), etc., which include automatic multiple associations from anchor to melody and from melody to anchor. Pulleyblank (1983) forced a rethinking of these universals, and the Yawelmani data are entirely compatible with a theory without automatic spread.

3. This was argued for in Williams (1971), Leben (1973), and Goldsmith (1976).

1.1 -- Surface and Underlying Representations

one in (1.10):

(1.10)

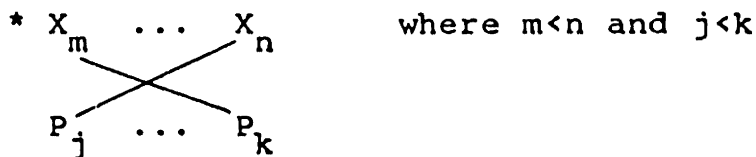

Given the Universal Association Convention (1.7) and the Wellformedness Condition (1.9), the associations need not be represented underlyingly. Rather, the melody is independent of the template and the Universal Association Convention (1.7) provides the associations. Thus, in underlying representation, there are no connections between the consonant melody and the skeletal slots:

(1.10) (=1.6 cont.)

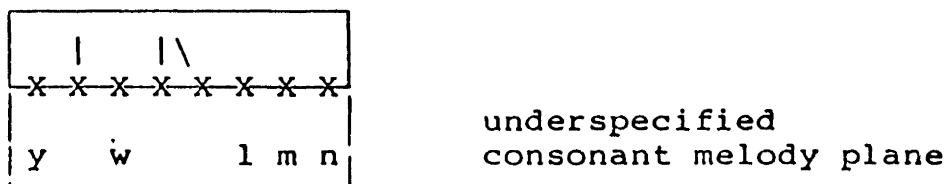

The absence of connecting lines is, of course, necessary since the template itself is supplied by the morphology. The underlying representation of the noun contains the consonant and vowel melodies alone, as shown below where the brackets are syntactic brackets:

(1.11)

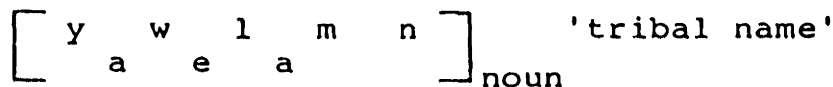

Vowel Melody Plane

As noted above, vowels paired with rime heads define a third plane. The Universal Association Convention (1.7) and the Wellformedness Condition (1.9) provide the following

1.1 -- Surface and Underlying Representations

associations:

(1.12)

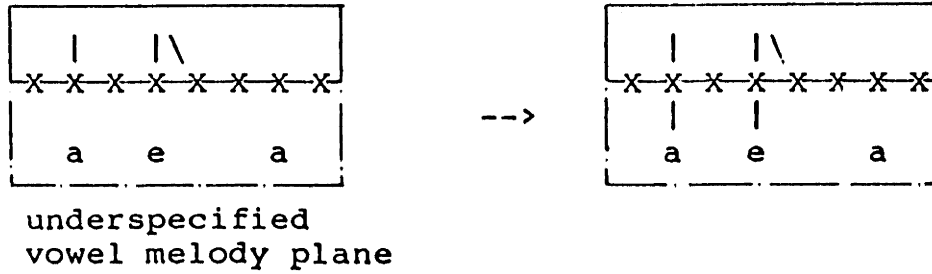

The /e/ associates to the second rime position by a general (perhaps universal) rule:

(1.12) cont.

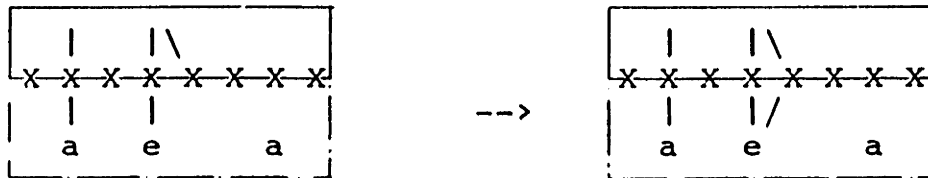

When a third rime is inserted (by the rule of epenthesis 3.110), the unlinked /a/ automatically associates with the melody-less slot, by the Universal Association Convention (1.7):

(1.12) cont.

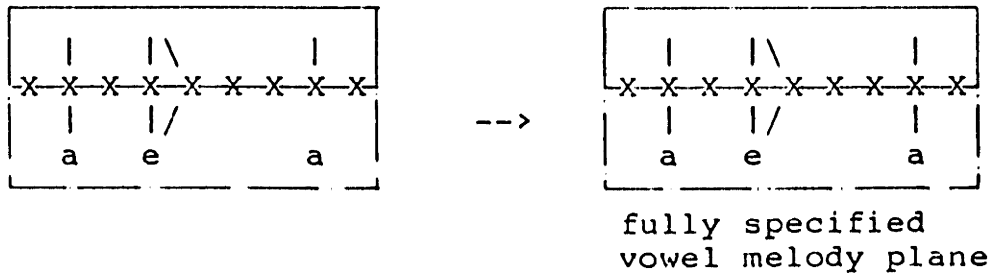

As noted above, the Universal Association Convention (1.7) applies automatically wherever possible. Also, following Pulleyblank (1983), I assume if something is linked (by rule) to an already linked slot, the original association line is automatically broken, unless a special proviso to the

contrary exists in the language:⁴

(1.13)

$$\begin{array}{ccc} \begin{array}{c} X \\ | \\ Y \ Z \end{array} & \longrightarrow & \begin{array}{c} X \\ \backslash \\ Y \ Z \end{array} \quad * \begin{array}{c} X \\ | \backslash \\ Y \ Z \end{array} \end{array}$$

An interesting result of the Universal Association Convention (1.7) is that slots can end up without tones/features after it has taken effect. I argue in Chapter 2 for a theory of underspecification which fills in unspecified values by a variety of rules. This theory is not possible if spread is automatic since unspecified matrices induce spread (by the earlier version of the universal association convention and wellformedness condition, see footnote 3), and so are no longer unspecified.

Up to this point, we have used letters to abbreviate the segment matrices. Although I do mean for these letters to represent matrices, the underlying matrices are more abstract than those found in many theories: Many features are not present. There are four underlying vowels in Yawelmani:⁵

(1.14)

	i	a	o	u
H	+	-	-	+
L	-	+	-	-
R	-	-	+	+
B	-	+	+	+

The above matrix contains too much information: To distinguish the four vowels, we need to know only that two are

4. In some theories, the original link is lost only if the delinking is specified in the rule. Pulleyblank (1983) provides convincing arguments for automatic delinking.

5. The surface [e] is derived from underlying /i/ by a rule assigning [-high] to underlying long vowels. See chapter 3, section 1.

1.1 -- Surface and Underlying Representations

not high and that two are round:

(1.15)

	i	a	o	u
H		-	-	
R			+	+

Consequently, the underlying vowels have the following specifications:

(1.16)

a = [-high] e = []

Thus, the representation of (1.12) is actually

(1.17) (=1.12 cont.)

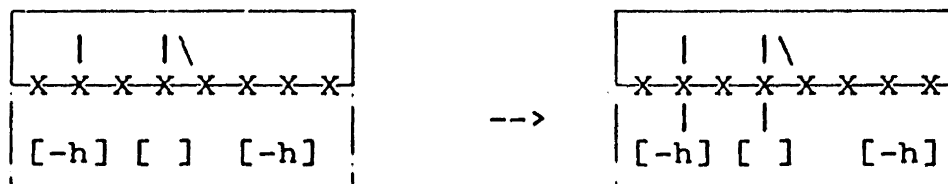

and general redundancy rules fill in the absent values. The same treatment applies to consonants as well.

Given a representation in which segment matrices appear on different planes:

(1.18)

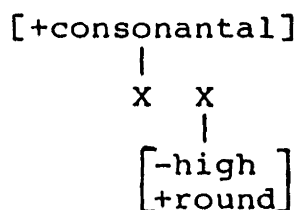

it is easy to imagine a representation in which the features of a given segment appear on separate planes, a **biplanar representation**:

(1.19)

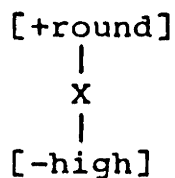

In examining vowel harmony in this language, we find motivation for a **coplanar representation**, that is one with "planes-within-planes", or **sub-planes**. Thus, within the [high, round] plane on vowels, the feature [high] anchors directly to the core skeleton and the feature [round] anchors to the feature [high], which I call a **coplanar representation**.

(1.20)

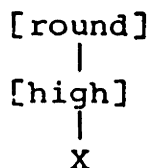

[Round], [high], and X form a single plane, the "end view" being

(1.21)

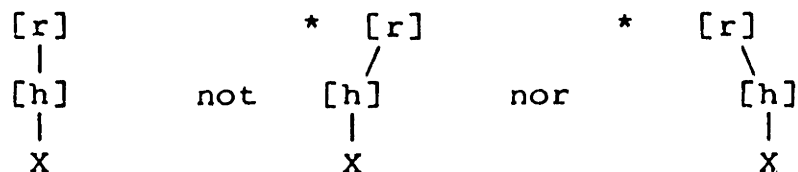

Stress Plane

The remaining plane in (1.1) registers stress via a grid

1.1 -- Surface and Underlying Representations

mark ("*").⁶ Stress falls on the penultimate syllable (after affixation):

(1.22)

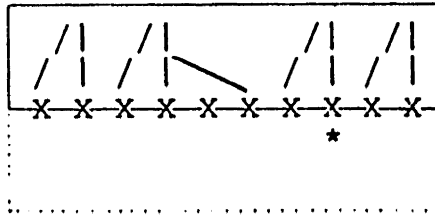

fully specified stress plane

The grid is constructed with respect to tree structure, which counts syllables to locate the penultimate syllable:

(1.22) cont.

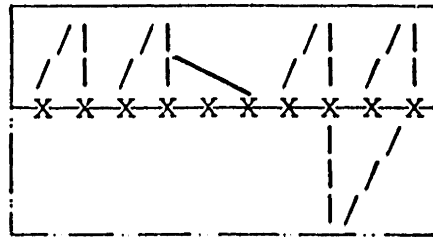

The grid marks the head of this tree:

(1.22) cont.

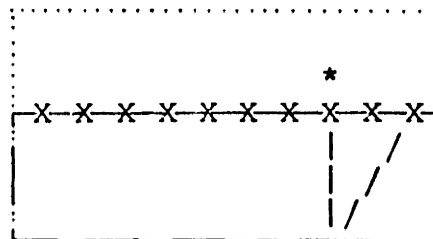

fully specified stress plane

Notice that in underlying representation, neither tree structure nor grid mark is present. In this way, the representation is completely unspecified for stress. The rule inserting the grid mark in a certain context (on the head of the stress tree) is a redundancy rule.

 6. Grid marks ("*") and the symbol for ungrammaticality ("*") are typographically the same symbol. However, they are not to be confused.

1.1 -- Surface and Underlying Representations

Trees do not have phonetic or phonological interpretation of their own. They are merely an abstract computational device, to which other rules may be sensitive. (Tree structure is omitted in (1.1) for clarity.)

In sum, the underlying representation of the word yawelmani contains

- a partially syllabified skeleton, provided by the morphology
- a consonant melody plane
- a vowel melody plane

(1.23)

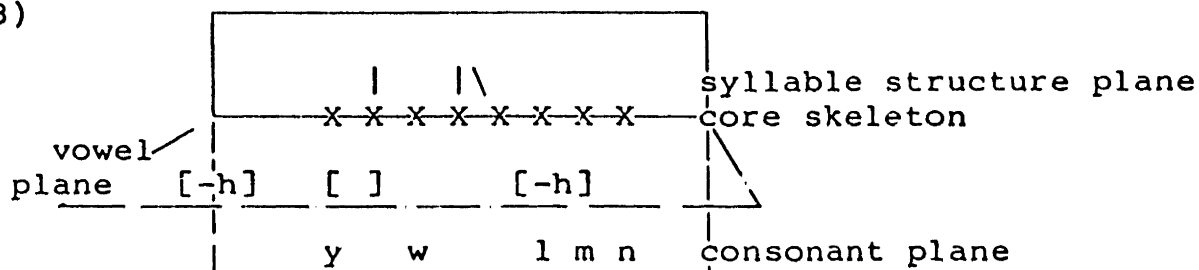

Associations, stress, and the remaining syllabification are the result of universal conventions and rules, both discussed in this thesis. Chapter 2 develops the theory of underspecification with respect to features. Chapter 3 examines the phonological rules (vowel quality processes, syllabification, and stress), with the assumption that these are under- or unspecified in underlying representation. Chapter 4 examines the template-supplying morphology: Most verbs and nouns are not specified underlyingly for the X-skeleton. The template is supplied by rule.

1.2 Rule Interaction

The notion of cyclicity as I understand it is entwined in the theory of lexical phonology (see Kiparsky 1982, Mohanan 1982, Halle and Mohanan 1983). The phonology and morphology of Yawelmani is organized in a two-strata lexicon, though here I discuss phenomena at stratum 1 and the post-lexical stratum primarily (see Archangeli 1984 on stratum 2).

(1.24)

stratum 1	affixation	templates inserted Copy (3.9) Syllable Internal Spread (3.13) Syllabification (3.99) Harmony (3.49) Lowering (3.15) some redundancy rules /?/ rules
stratum 2	wiy compounds	Syltable Internal Spread (3.13)
post-lexical stratum	stress most redundancy rules	

Within a cyclic stratum, after each affixation process, the phonological rules apply. Then the forms (may) undergo affixation again. In this way, phonological rule application is cyclic. When affixation is complete, the form undergoes the phonological rules once again, then proceeds to the next stratum:

(1.25)

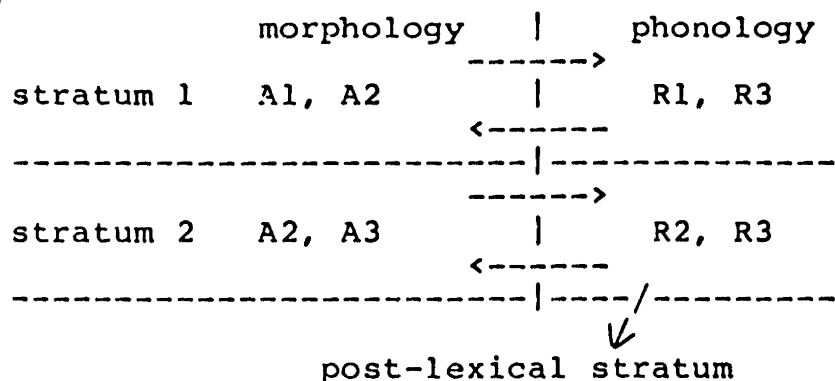

The passing from morphology to phonology and back encodes cyclic application of phonological rules in the very structure of the grammar. It also marks a distinction between rule applications, which are lexical (and cyclic) or post-lexical (and not cyclic). Syllabification (Chapter 3.2) is an example of the former in Yawelmani, stress (Chapter 3.3) of the latter.

Since lexical rule applications are cyclic, they are subject to the **Strict Cycle Condition** (based on work by Mascaro 1976, Pesetsky 1979, and Kiparsky 1982).

(1.26)

Strict Cycle Condition

- a. Cyclic rules apply only to derived representations.
- b. Definition: A representation Φ is derived with respect to rule R in cycle j iff Φ meets the structural analysis of R by virtue of a combination of morphemes introduced in cycle j or the application of a phonological rule in cycle j.

Kiparsky 1982, p. 41

The Strict Cycle Condition (1.26) prevents phonological rules from changing material of a previous cycle, unless the context for the rule is created on the present cycle.

1.3 -- A Historical Perspective

A second principle governing rule application is one adopted from Panini by Kiparsky (see Kiparsky 1973, 1982, also Koutsoudas, Sanders, and Noll 1974), called the **Elsewhere Condition**. The intuition behind the Elsewhere Condition is that if two rules can apply to a given string, and one rule has more limited application than the other, then the more limited rule applies and the more general rule does not apply.

(1.27)

The Elsewhere Condition

Rules A, B in the same component apply disjunctively if and only if

- a. The input of A is a proper subset of the input of B.
- b. The outputs of A and B are distinct.

In that case, A (the particular rule) is applied first, and if it takes effect, then B (the general rule) is not applied.

Kiparsky 1984, p. 3

1.3 A Historical Perspective

The theoretical points made in this work are valid only insofar as they account for a large body of the phonological and morphological alternations in some language, in this case Yawelmani, more effectively than can be done assuming other theories. They also are valid only insofar as the data on which they are based are reliable.

By all counts, Newman's (1944) grammar of Yokuts satisfies the requirements stated above. Immediately after its publication, Newman's grammar was heralded by Zellig

1.3 -- A Historical Perspective

Harris as "a major addition...a model contribution to descriptive linguistic method and data". Harris goes on to point out that the grammar "is sufficiently detailed...to enable the reader to become familiar with the language and to construct correctly...statements about the language" (Harris 1944:196). There have been a number of studies of Yokuts since the appearance of Newman's book. Hockett (1973) provides a comprehensive annotated list (with an addendum in Pullum 1973) of publications about the Yokuts languages -- and non-publications as well. He reports a flurry of review articles between 1944 and 1949, with some reanalysis, followed by the period "1946-present" (i.e. 1973) during which

"data from Yawelmani, particularly on verbs, [was--DA] used repeatedly in courses designed to train apprentice linguists in the analytic techniques of descriptive linguistics,...in general leading only to student reports...Hockett (1967) and Kuroda (1967) are, each in its own way, products of this twenty-year period of analytical puzzlement and experimentation." (emphasis mine)

Hockett 1973, p. 64

The two publications mentioned by Hockett spawned a second flurry of interest in the language, with reviews of Kuroda's book (Rice 1969, Kisseberth 1970b), and Kisseberth's (1969a) thesis and subsequent publications (1969b, 1970a, 1973a).⁷

The descriptive period was followed by a period when once again data from Yawelmani was used repeatedly in basic linguistics courses, with the focus more on theoretical issues than on descriptive techniques; for example, Kenstowicz and

7. Kisseberth also co-authored several works with Kenstowicz: See references under both names.

1.4 -- A Comparison

Kisseberth (1979) is a text which makes repeated reference to Yawelmani to illustrate such diverse phenomena as vowel harmony, rule interaction (ordering), and vowel epenthesis.

This continued use of the data presented in Newman (1944) is testimony to the valuable contribution to linguistics -- both descriptive and theoretical -- made by his detailed and systematic study.

1.4 A Comparison

Here we compare four approaches to one of the basic processes in Yawelmani phonology, vowel harmony. These approaches are (i) descriptive, (ii) early generative, (iii) autosegmental, and (iv) underspecified autosegmental. Such a comparison illustrates the deepening of our understanding of the nature of linguistic processes in the past forty years.

Vowel Harmony

Consider vowel harmony. The facts are uncontroversial. Vowels round to the right of a round vowel of the same value for [high], if no vowels of a different value for [high] intervene. This gives the following alternations:

(1.28)

$$\begin{array}{l} /..u..i../ \quad \rightarrow \quad [..u..u..] \\ /..o..a../ \quad \rightarrow \quad [..o..o..] \end{array}$$

The technique that Newman employs to account for vowel

alternations is that of listing:⁸

(1.29)

"Every suffix possesses one vocalic form for stems of three vowel series and another for stems of the fourth vowel series.

series of last stem vowel

		a	o	i	u
suffix	1.	i	i	i	u
vowel	2.	e:	e:	e:	o:
types	3.	a	o	a	a
	4.	a:	o:	a:	a:"

Newman 1944, p. 21

Simply listing the sounds does little for explaining why /i/ alternates with [u] after /u/, and /a/ with [o] after /o/. Also, the close relationship between /i/ and [e:], /u/ and [o:] is not explained. The chart above could equally read:

(1.30)

series of last stem vowel

		a	o	i	u
suffix	1.	i	i	o	i
vowel	2.	e:	a:	e:	e:
types	3.	a	i	a	a
	4.	a:	i:	a	a

The distribution in (1.30) not only does not describe the Yawelmani data, it does not describe data one is likely to find in the grammar of any natural language. This unlikelihood can not be captured by listing alternations.

In the early generative study of Yawelmani, Kuroda (1967, p. 14) presents a linear harmony rule using distinctive features (the feature diffuse occurs where we now use high). This allows expression of the relationships between the height of the vowels and the roundness of the vowels. Using

8. In this notation, V: is a long vowel.

1.4 -- A Comparison

features, the list in (1.30) cannot be expressed, at least in any reasonably concise form. By contrast the actual distribution is readily formalized:

(1.31)

$$V \text{ ---> } \left\{ \begin{array}{l} [-\text{round}] / V C_1 \text{ ---} \\ [+round] / \left[\begin{array}{l} \text{a diffuse} \\ +\text{round} \\ V \end{array} \right] C_1 \left[\begin{array}{l} \text{a diffuse} \end{array} \right] \end{array} \right.$$

Kuroda 1967, p. 14

Special rules then adjust values for [back] and [low].

The linear rule above misses certain generalizations about the harmony process. Most crucially, the fact that [+round] is inserted by this rule in an environment conditioned by a [+round] vowel is entirely coincidental. Also, the harmony rule alone is not sufficient: Special rules are needed to make [ü] back and to make [ɔ] non-low.

In autosegmental theory, the harmonizing feature is on a plane separate from all other features of the harmonizing segments:

(1.32)

$$\begin{array}{c} [+round] \\ | \\ X \\ | \\ \left[\begin{array}{l} +\text{high} \\ +\text{back} \\ -\text{low} \end{array} \right] \end{array}$$

The rule of harmony is represented by spreading the feature [round] on matrices of like height:

1.4 -- A Comparison

(1.33)

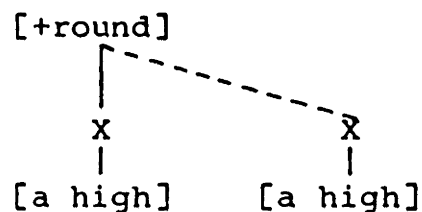

The accident (in the linear account) that the features are identical is no accident here; it is expressed in the formulation of the rule.

However, this representation is still open to criticism. If matrices are fully specified, then either (i) the harmony rule must be complicated or (ii) additional "clean up" rules are needed. This is because in Yawelmani when /i/ harmonizes after /u/, it surfaces as [u], not as [ü], and /a/ after /o/ surfaces as [o], not as [ɔ]:

(1.34)

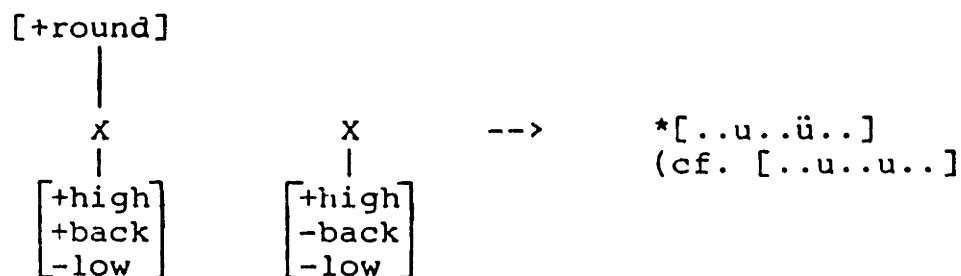

We can account for this either by adding a rule to back [ü] to [u] and to raise [ɔ] to [o], or we can obscure the basic rounding process by adding both [back] and [low] to the formulation of the rule.

In the account proposed in this thesis, harmony is represented as a non-linear rule spreading [+round] on like values for [high]:

APPENDIX

Rule-Writing Notation

The following formal notation is used here in rules dealing with melodies and anchors, where Z can be either melody unit or anchor:

(1.36)

Ⓢ	unlinked
Z 	linked
Z	ambiguously linked or unlinked
Z / 	leftmost link
Z \	rightmost link
 	delink
⋮	link

Chapter 2

UNDERSPECIFICATION

This chapter introduces a theory of underspecification exploiting the use of minimally specified matrices in underlying representation and applies this theory to the Yawelmani vowel system.¹ Redundancy rules, ordered by the Redundancy Rule Ordering Constraint (2.88), supply the unspecified values.

There are asymmetries in the distribution of phonological features in inventories for languages and in phonological rules. Pulleyblank (1983) discusses tonal phenomena in Yoruba where High and Low tones are mentioned in the structural descriptions and changes of rules throughout the phonology, but Mid tone is never mentioned. Yet all three tones surface. Archangeli and Pulleyblank (1984) presents an analysis of Tokyo Japanese tone which refers solely to High tone in the rules of the tonology, yet both High and Low tones surface.

This asymmetry is not restricted to tonal phenomena. In Spanish, several different epenthesis rules are noted to insert a single vowel quality (Harris 1980). In harmony systems, the existence of "opaque" segments blocking harmony

1. Doug Pulleyblank, Paul Kiparsky, and K.P. Mohanan deserve special recognition for their support, encouragement, and suggestions when I first began developing the ideas presented here.

and "transparent" segments unaffected by harmony is discussed in the literature (see for example Halle and Vergnaud 1981). Spreading rules in Yoruba (Pulleyblank 1984) treat /i/ differently from all other vowels in the language.

In this section, a theory of underspecification is proposed which provides a principled explanation for asymmetries of the sort noted above. In this theory, certain values for all features are supplied by redundancy rules, rather than being present in underlying representation. In this way, underlying representations are simplified. For example, in Yoruba, the Mid tone is supplied by redundancy rules (Pulleyblank 1983), and in Tokyo Japanese, the Low tone is supplied by redundancy rule (Archangeli and Pulleyblank 1984). However, the theory of underspecification does not relate only to "neatening up the storage closets": We examine examples where underspecification also simplifies the phonological rules of languages. The epenthetic vowel in Spanish (/e/) is completely featureless in underlying representation. The redundancy rules which supply values for underlying /e/ also supply values to inserted vowel slots, thereby accounting for the fact that all epenthetic vowels are /e/ in Spanish, regardless of which rule inserts the slot. Transparent vowels (i) are not subject to harmony and (ii) have no specification for the harmonizing feature and so do not block harmony. Opaque vowels are specified for the harmonizing feature and so block spread. In Yoruba, the vowel /i/ is analyzed as having no specifications in underlying representation. Its feature values are supplied by redundancy rules applying after various spread rules, thus accounting for the asymmetric behavior. (See Pulleyblank 1984 on Yoruba.)

Adopting a theory of underspecification has consequences beyond simplifying both representations and rules, for example in the characterization of sound systems. Certain vowel

systems are preferred in the languages of the world. A three vowel system is most frequently /i, a, u/, and a five-vowel system is most frequently /i, e, a, o, u/. See Troubetzkoy (1929), Liljencrants and Lindblom (1972), and Reid (1973).² A four vowel system contrasts with this in that, although most four vowel systems contain /i, a, u/, the quality of the fourth vowel is relatively (but not entirely) unpredictable when there is no fifth vowel in the system. The questions both of how to characterize these preferred combinations of vowels and how to characterize the contrast between the predictable membership of three and five vowel systems compared to the unpredictability in four vowel systems is closely tied to the question of what constitutes a marked or unmarked segment and a marked or unmarked rule. "Markedness" is discussed in Chomsky and Halle (1968) (henceforth SPE) and Kean (1975, 1979) in response to the observation that without some formal notion of markedness, unlikely rules are valued equally or better than highly likely rules. For example,

(2.1)

- | | |
|---------------|---------------|
| a. i. i --> u | b. i. t --> s |
| ii. i --> ü | ii. t --> ø |

In Yawelmani we have an example of (2.1a): If the suffix (?)ihay 'contemporaneous gerundial' follows a root with the vowel /u/, the vowel /i/ of the suffix surfaces as [u], not as [ü]:³

2. These sources cannot be taken overly seriously, since they examine surface vowels only. For example, Klamath is cited as having an /i, e, a o/ vowel system in Liljencrants and Lindbom (1972), yet examination of the phonology suggests this is best regarded as a /i, e, a, u/ system. (See Levin in prep).

3. The rule of rounding harmony is discussed in detail in this and the following chapters.

(2.2) dub+(?)inay --> [dub?unay] 'while leading by the hand' 136

In English we have an example of (2.1b): If we add the suffix -ive to words with the morpheme mit, the final /t/ surfaces as [s], and not as [θ].

(2.3)

permit/perm[i]sive	remit/remi[s]ive
*perm[i]θive	*remi[θ]ive

In each pair in (2.1), the (i) rule requires that more features be changed than are changed in the (ii) rule: In (2.1ai), both [back] and [round] change while in (2.1aii) only [back] changes. In (2.1bi), both [continuant] and [strident] change while in (2.1bii), only [continuant] changes. Yet most phonologists agree that the (2.1i) rules are more likely in the languages of the world, despite the fact that the (2.1i) rules are formally more complex (since they mention two features rather than one). Thus, for the theory to be complete, we need some means of formally encoding the differences between the rules in (2.1) above.

2.1 Full, Partial, and Underspecification

The assumption that some degree of abstractness is necessary coupled with the assumption that there are principles governing underlying representations gives rise to three possibilities for these principles governing underlying representation:

2.1 -- Full, Partial, and Underspecification

(2.4)

- | | | |
|----|--|--|
| a. | FULL SPECIFICATION
(loosely Markedness
Theory) | a value for every feature is
assigned to every phoneme;
there are no features with
no values |
| b. | PARTIAL SPECIFICATION
(structuralists) | for some features a value is
assigned for every phoneme;
for other features values
are not assigned |
| c. | UNDERSPECIFICATION | there is no feature such
that some value is specified
for that feature in every
phoneme |

I discuss each in turn. For purposes of this discussion, let us assume three binary distinctive features [F], [G], and [H] available in Universal Grammar and in the language under consideration, the three phonemes /A/, /B/, and /C/, with the following feature composition:⁴

(2.5)

	A	B	C
F	+	-	-
G	-	+	-
H	+	+	+

2.1.1 Full Specification

The figure (2.5) above is the underlying representation if Full Specification is assumed: Every feature has some value assigned for each phoneme in the inventory. There is no

4. This matrix could be a real partial matrix like the following:

	a	u	o
L	+	-	-
H	-	+	-
B	+	+	+

feature [F'] which has no value assigned to some phoneme. Phonological rules operate on these representations.

The SPE and Kean (1975) "Markedness Theory" is similar to full specification in that all features are specified before any phonological rules take effect. In underlying representations, however, features are assigned u(nmarked) or m(arked).⁵ This allows expression of certain generalizations about sound systems, generalizations which cannot be expressed assuming Full Specification. Markedness Conventions translate the "u"s and "m"s to "+"s and "-"s prior to application of phonological rules. All specifications are present before application of phonological rules and so the absence of specifications does not have an effect on the phonology at all.

2.1.2 Partial Specification

Here our hypothetical grammar has the following underlying representation:

(2.6)

	A	B	C
F	+	-	-
G	-	+	-
H			

Two features, [F] and [G], are fully specified for all phonemes in the inventory. The third feature, [H], which has the same value on all three segments, is not specified in the inventory at all. Some rule, universal or language specific, fills in the missing value.

5. In SPE, four types of markings are allowed, "+", "-", "u", and "m". Kean (1975) reduces all universal markings to "u" or "m", and posits universal markedness conventions which translate the "u"s and "m"s into "+"s or "-"s.

(2.7)

[] --> [+H]

Assuming Partial Specification means that there is no feature [F'] which has specifications for some phoneme and no specifications for another phoneme, i.e.

* A' B'
 F' +

if Partial Specification is assumed. Since only features which are not distinctive have no values supplied in underlying representation, any rule which might be written in terms of the unspecified feature ([H] in the above) may equally be formulated in terms of the features which are fully specified. If for example [H] is filled in as [+H], then any rule which refers to [+H] in the focus of the structural description applies to all segments and so referring to [+H] in that rule is irrelevant. The same logic is applicable if [+H] is in the environment of the structural description.

With Partial Specification once again the lack of specification is not available for use in the phonological rules. If Underspecification is assumed, however, the lack of values may be exploited -- but only if specifications are inserted after at least some phonological rules have applied, not before.

2.1.3 Underspecification

The underlying representation of our hypothetical

6. The suggestion that not all features are fully specified (2.4b or c) in underlying representation is not new. There have been "archiphonemes" in many analyses, at least since Troubetzkoy (1969).

2.1 -- Full, Partial, and Underspecification

language is considerably streamlined if underspecification is assumed.⁶ This means that the language learner has less to learn and less to memorize.

(2.8)

	A	B	C
F	+		
G		+	
H			

Rules (universal for the most part) fill in missing values:

(2.9)

- a. [] --> [-F]
- b. [] --> [-G]
- c. [] --> [+H]

Assuming Underspecification means that an underlying representation where a feature has specifications for all phonemes is ill-formed:

(2.10)

*	A	B	C
H	+	+	+

It also means that both values cannot be represented for a given feature:

(2.11)

*	A	B	C
F	+	-	-

Both of these points follow from (2.4c), which says that there is no feature which has a value specified for every phoneme.

In the hypothetical system assumed here, the phoneme /C/ is totally unspecified. The prediction made is that such a phoneme may behave asymmetrically with respect to the other phonemes of the language. In elaborating the theory of Underspecification we examine examples of this asymmetry, and see that the asymmetry extends beyond phonemes to the behavior of specific features as well, particularly in the case of

2.2 -- The Alphabet

Yawelmani vowel harmony and Latvian Raising.

2.2 The Alphabet

In Underspecification Theory, the concept of **distinctive feature** has a highly significant role. In a language's underlying representations only the features that are distinctive in that language, that is, features which actually are necessary to distinguish two sounds, have values specified. Any feature which is non-distinctive in some environment is a redundant feature and its values are supplied by **redundancy rule**. The elaboration of this theory is as follows: First we consider possible underlying matrices and the sources of redundancy rules which specify these matrices. Then, in a detailed analysis of the Yawelmani vowel system, a constraint on the interaction of the redundancy rules with the other phonological rules in the grammar is motivated. In this discussion, the term **inventory** is used to refer non-theoretically to the collection of sounds in a grammar. The underlying inventory refers to the set of sounds available in underlying representations, without making any claims about the representation of these sounds. That it is possible to discuss inventories at all is due to the intuition that languages have alphabets, that is, a subset of the sounds possible in natural human language is selected by each language as the building blocks of the words of that language.

In Underspecification Theory, the **alphabet** has a very particular structure. The alphabet contains a **matrix component**, an array of the underlying distinctive feature combinations of the sounds of the language. This array, of

2.2 -- The Alphabet

course, does not have all values represented on all features. Consequently, the alphabet also contains a rule component, a set of redundancy rules filling in some the values not specified in the matrix component. If the matrix component undergoes application of all the rules in the rule component, fully-specified matrices result. However, these fully specified matrices do not necessarily correspond to the surface matrices, because phonological rules proper can also apply to the matrices. Underlying representations are constructed from the members of the matrix component, and rules (redundancy and phonological) apply to these representations:

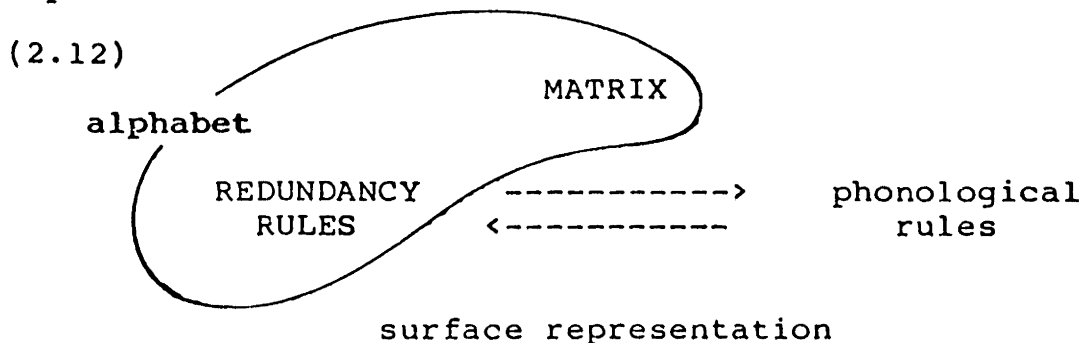

Redundancy rules and phonological rules consequently have different roles in the grammar. A means of formally distinguishing the two is needed. Redundancy rules have as the focus something either obligatorily without the inserted feature/structure, here [+F]:

(2.13)

$$\textcircled{X} \text{ --> } \begin{array}{c} X \\ | \\ [+F] \end{array}$$

or optionally without the inserted feature/structure:

(2.14)

$$X \text{ --> } \begin{array}{c} X \\ | \\ [+F] \end{array}$$

Phonological rules, on the other hand, are rules which either

2.2 -- The Alphabet

change feature values or change structure. The focus obligatorily has a feature/structure which gets changed. To encode this we include the specification in the rule itself:

(2.15)

$$\begin{array}{ccc} X & \text{-->} & X \\ | & & | \\ [aF] & & [+F] \end{array}$$

Of the following rule pairs, the first is a redundancy rule and the second is a phonological rule because the first does not obligatorily have feature/structure on the focus and the second does have a specified focus:

(2.16)

- a. i. [] --> [-voice] / ___##
 ii. [a voice] --> [-voice] / ___##

b. i.  (i.e. make an unsyllabified slot the onset)

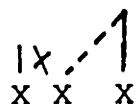
ii.  (i.e. resyllabify into the onset)

The redundancy rules, i.e. rules filling in the unspecified values, are of three types:

(2.17)

- | | |
|---------------------|---|
| a. Default Rules | Rules which are part of Universal Grammar. These are cost-free. |
| b. Complement Rules | Rules created by a process called Alphabet Formation (2.55), which is part of Universal Grammar. Alphabet Formation requires language particular information to create the Complement Rules. These are cost-free. |
| c. Learned Rules | Language particular rules which must be learned. These are not cost-free. |

(2.21) "Two units U_1 and U_2 are distinct if and only if there is at least one feature F such that U_1 is specified $[a F]$ and U_2 is specified $[b F]$ where a is plus and b is minus... Two strings X and Y are distinct if they are of different lengths, that is, if they differ in the number of units that they contain, or if the i^{th} unit of X is distinct for the i^{th} unit of Y for some i ."

SPE, p. 336

The Distinctness Condition (2.20) and the definition of "distinct" (2.21) block application of redundancy rules for a given feature to matrices already specified for that feature. This is because $[a F]$ and $[-a F]$ are distinct, but $[a F]$ and $[a F]$ (or $[-a F]$ and $[-a F]$) are not distinct. If a feature is specified in underlying representation as $[a F]$, then there is a rule inserting $[-a F]$:

(2.22) $[] \rightarrow [-a F]$

The value in the lexical item ($[a F]$) surfaces and the redundancy rule (2.22) is blocked. Consider the two schematic lexical entries below:

(2.23) lexical entry 1: ...X $\begin{bmatrix} a F \\ + G \end{bmatrix}$ Y...
lexical entry 2: ...X $\begin{bmatrix} F \\ + G \end{bmatrix}$ Y...

If we attempt to apply the redundancy rule (2.22) to the entries in (2.23), we derive from lexical entry 2 :

(2.24) lexical entry 2: ...X $\begin{bmatrix} -a F \\ + G \end{bmatrix}$ Y...

With lexical entry 1, however, redundancy rule (2.22) is blocked by the Distinctness Condition (2.20) and so no change is made. Without something like the Distinctness Condition

(2.20), (2.22) does apply to lexical entry 1, the output is distinct from the input, and the underlying specification is lost. Thus, if the Distinctness Condition (2.20) (or some other principle including this effect) is not part of Underspecification Theory, the Underspecification Theory is meaningless because all values specified in underlying representation are wiped out by application of the redundancy rules.

Notice that in underlying underspecified representations, phonemes are not distinct, according to the definition in (2.21). They are potentially distinct, and will become distinct through the application of rules. The Distinctness Condition (2.20) prevents their becoming non-distinct through application of redundancy rules. However, as we see in the discussion of Latvian Raising (immediately below), phonological or morphological rules may render underspecified matrices non-distinct.

2.2.2 The Matrix

Let us now turn to the question of the matrix in the underlying alphabet. There are various assumptions possible about what constitutes the most highly valued minimally specified matrix. These break into three categories, algorithms based on:

(2.25)

- a. the rules necessary to supply the missing feature values
- b. the number of feature values (i.e. the number of pluses and minuses) in underlying representation
- c. the number of features in underlying representation

Consideration of these options ranks the third above the other two, and the second above the first.

2.2 -- The Alphabet

As noted above in the discussion of redundancy rules (see 2.17), there are three classes of these rules, two of which are provided by Universal Grammar (default rules and complement rules). Thus, counting the number of rules needed to supply missing values reduces to counting the number of learned rules. This is relevant, but it is relevant only in languages where rules must be learned. This option is not relevant in the majority of cases, where there are no learned rules in the set of redundancy rules in the grammar. Furthermore, the number of rules can be reduced to the number of segments in the language, one rule per segment, if rule formation is unconstrained. Such an approach is purely mechanical.

Counting the number of specifications necessary, i.e. the number of "+"s and "-"s, leads to conceptual problems, and a misuse of underspecification. Given a phonology using n features, we can define $n+1$ phonemes simply by supplying a single value to a single feature for each phoneme, and leaving one featureless:

(2.26)

	P1	P2	P3	P4	...
F1		+			
F2			+		
F3				+	
:					

This uses only three feature values. If we decrease the number of features, we are forced to increase the number of values specified, creating a more costly system. Yet if we do not decrease the number of features, in theory we will at some point be using non-distinctive features to discriminate phonemes. Furthermore, in a system with only a few sounds, like a three- or four-vowel system, there is more than one representation of the vowels. An illustrative example is the Latvian underlying vowel system which contains four vowels,

2.2 -- The Alphabet

/i, e, a, u/.⁸

Below we see three different feature count systems, all of which mention three feature values to distinguish the four sounds.

(2.27)

	i	e	a	u		i	e	a	u		i	e	a	u
H		-					-					+		
L			+											
B				+				+					+	
R									+					+

Three feature values must be marked but there is ambiguity as to which features and which values are relevant.

Now consider the third option, presented in (2.28) below.

(2.28)

Feature Minimization Principle

A grammar is most highly valued when underlying representations include the minimal number of features necessary to make different the phonemes of the language.

Consider the following underlying representation for the Latvian vowels, adopting the Feature Minimization Principle (2.28):

(2.29)

	i	e	a	u
H	+			+
B	-	-		

8. Thanks to Morris Halle for assistance with the Latvian data. Steinbergs (1977) discusses a fifth underlying vowel, /æ/. /æ/ and /e/ are almost in complementary environments, according to Steinbergs. /æ/ may also be a phoneme of Latvian; however, it is not available as a stem vowel, where Raising takes place. If /æ/ is an underlying vowel, then (2.29) must also include a vowel that is [+low, -back], namely /æ/.

2.2 -- The Alphabet

This is an intuitively attractive system since it is symmetrical, with two high vowels and two back vowels.⁹ Also, this is the only feature combination possible under the Feature Minimization Principle: The Feature Minimization Principle (2.28) is restrictive. No other combination of two features results in a four-way division between the vowels, as shown below. The circled vowels are identical in these representations.

(2.30)

	i	ⓔ	ⓐ	u		ⓔ	e	a	ⓐ
H	+			+	H	+			+
R				+	L			+	
	ⓔ	ⓔ	a	u		ⓔ	ⓔ	a	u
L			+		L			+	
R				+	B	-	-		
	ⓔ	ⓔ	a	u					
R				+					
B	-	-							

2.2.3 Latvian Raising

The representation in (2.30) has further empirical consequences as well. In Latvian, noun stems end with one of the four underlying vowels, with feminine stems ending in one of /i, e, a/ and masculine in one of /a, i, u/. The following paradigm illustrates feminine nouns in the locative, dative, and accusative singular.

9. The values of these two features could of course be the opposite. In the discussion of Raising, selection of [+high] over [-high] is motivated. Since [+high] is the representation of the accusative singular suffix, [+high] must be available for underlying representations. In the discussion of Alphabet Formation (2.55), there is motivation for selecting [-back] over [+back] -- then the default rule supplying [+back, -round] on [+low] vowels is applicable.

(2.31)

feminine	'sister'	'mother'	'fish'
sg. loc.	ma:sa:	ma:te:	zivi:
sg. dat.	ma:say	ma:tay	zivi
sg. acc.	ma:su	ma:ti	zivi

From the locative and dative singulars, we see that ma:sa 'sister' has a stem vowel /a/, ma:te 'mother' a stem vowel /e/, and zivi 'fish' a stem vowel /i/. In the accusative singular, this vowel is replaced in the /a/- and /e/-stems by a [+high] vowel which agrees in backing with the stem vowel:

(2.32)

a --> u e --> i in the accusative singular

In (2.33), the masculine paradigm is given, and the same process of Accusative Raising occurs: /a/ surfaces as [u].

(2.33)

masculine	'horse'	'market'	'swan'
sg. loc.	zirga:	tirgu:	gulbi:
sg. dat.	zirgam	tirgum	gulbim
sg. acc.	zirgu	tirgu	gulbi

In (2.33), the stem vowels are /a/, in zirga 'horse', /i/, in gulbi 'swan', and /u/, in tirgu 'market'. In the accusative singular of zirga, the /a/ surfaces as [u], a [+high] vowel agreeing in backness with /a/.

Suppose that the accusative singular marker is a rule assigning [+high]:

(2.34)

Accusative Raising

[] --> [+high] / _____]accusative singular

When the accusative singular is affixed to a noun, if the stem vowel is /a/ or /e/ there is no value for [high] present, the

2.2 -- The Alphabet

[+high] feature is assigned to that stem-final vowel:

(2.35)

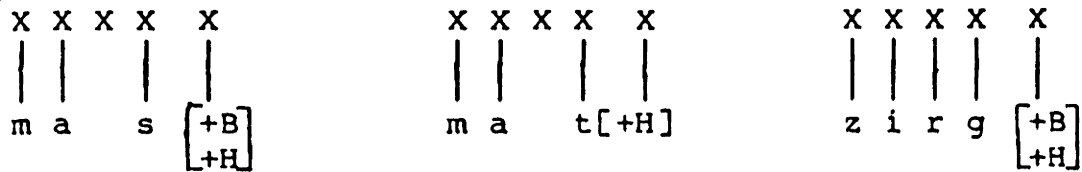

The accusative singular affix results in all stem final vowels being linked to [+high], but no other feature changes take place. But once [+high] is added to the underlying representations for /e/ and /a/, the derived representations are identical to the underlying representations for /i/ and /u/ respectively:

(2.36)

underlying		i	e	a	u
representation	H	+			+
	B	-	-		
accusative		i	e	a	u
raising	H	+	+	+	+
	B	-	-		

The representations for /e/ and /i/ and for /a/ and /u/ are now identical. The redundancy rules necessary to produce [i] from underlying [+high, -back] and [u] from underlying [+high]

10. The redundancy rules, intrinsically ordered as given, are

- a. [] --> [-high]
- b. [] --> [-low] / [____, -back]
- c. [] --> [+low] / [____, -high]
- d. [] --> [+back, -round] / [____, +low]
- e. [] --> [+back]
- f. [] --> [+a round] / [____, -low, a back]

Rules (a) and (e) are "Complement Rules" and rules (c,d,f) are "Default Rules". See 2.17). Both types of rules are provided by Universal Grammar, and are not explicitly learned. Rule (b), on the other hand, is a learned rule. These types of rules are discussed in the remainder of this section.

2.2 -- The Alphabet

give the same vowels, [i] and [u], from underlying /e/ and /a/ respectively.¹⁰

There are certain predictions made by the Feature Minimization Principle (2.28). In the above example, we see that the set of possible underlying representations is restricted by this principle. Also, this principle forces the use of the same features for consonants as are necessary for vowels. In Latvian, for example, there is evidence in the vowel system for representing [back] in underlying representation, rather than, say [round] (see footnote 9). Consequently, the most highly valued consonant system in Latvian is one which does not use the feature [round]. The Feature Minimization Principle (2.28) means that Universal Grammar prefers an underlying system using the smallest number of features possible. If [round] is not needed for vowels, but is for consonants, a feature is added to the alphabet, an undesirable result. Furthermore, if it uses the feature [back], the only possible value is [-back]. Since [-back] is marked on vowels, specifying [+back] on some consonants means both values of [back] are specified in underlying representation. This is possible only if the environments differ, since the following two complement rules (see section 3.3 of this chapter) can not coexist in a language:

(2.37)

- a. [] --> [-back]
- b. [] --> [+back]

Of course, two rules can specify different values if an environment is included on one of the rules:

(2.38)

- a. [] --> [-back] / [____, +consonantal]
- b. [] --> [+back]

2.3 -- Underspecification Theory

The notion "distinct" depends crucially on the uncontroversial assumption that there must be motivation for rules and underlying representations. It also depends on the order in which rules (both phonological and redundancy) are allowed to apply. This is the focus of the next section.

2.3 Underspecification Theory

In this discussion, four issues are addressed, (i) the features which are represented underlyingly, (ii) the values of these features which are present underlyingly, (iii) the rules supplying the missing features, and (iv) the constraints on the system.

Loosely, the features represented in underlying representation are the features which distinguish members of the alphabet of the language in question. A simple example comes from considering the contrast between vowels and consonants. Once it is known that something is a vowel, the values of many features are also known, for example the values of features like [continuant] and [strident]. Also, there are a few features for which the value is probably known, for example [voice] and [nasal]. In a language with only oral, voiced vowels, these features are not distinctive in underlying representation, and so are not even present. Nothing at all must be learned about these features. A universal default rule supplies the missing feature with the appropriate value:

(2.39)

a. [] --> [-nasal] b. [] --> [+voice] / $\left[\begin{array}{c} \text{---} \\ +\text{son} \end{array} \right]$

By contrast, in a language which has underlying distinctive

2.3 -- Underspecification Theory

nasal vowels, the nasal vowels must be specified as [+nasal] in underlying representation. The vowels surfacing as oral have no specification for [nasal] in underlying representation. The universal rule (2.39a) fills in [-nasal].

(2.40)

underlying representation			application of (2.39a)		
	V1	V2		V1	V2
nasal	+		nasal	+	-

Whether a feature is distinctive or not depends on the language system, not solely on abstract universals. This contrasts with the SPE theory, in which the markedness of a given segment has a universal value, and the underlying specifications for each feature of a given segment are determined universally, not system-specifically.

The above discussion has dealt with the question of which features are represented underlyingly, namely, the features that are truly distinctive in a particular language. The question remains of which values are represented for those features. In general, the values of the underlying features are those values which are unpredictable. In a given environment, only one value is present in underlying representation, and the other is supplied by a rule. The value that is unpredictable depends partially on Universal Grammar, but also on the system in which the feature is found. This is a second point on which the proposal here differs from SPE. In SPE, a given segment has a given markedness value, independently of the rest of the language. I propose instead that the least specified segment in a language is dependent on the alphabet of that language as well as on Universal Grammar, in a sense to be defined shortly.

2.3.1 Default Rules and Complement Rules

Let us first look at specific languages providing evidence for an unspecified vowel. Spanish, Japanese, and Telugu all have five vowel systems, /i, e, a, o, u/.¹¹ Each language also has at least one epenthesis rule. Now, if epenthesis is represented as the insertion of a syllable-head position, devoid of phonemic material, the simplest account is the one which supplies the quality of the inserted vowel by the same rules that supply features for the vowels in general. Compare the following rules, where "[V]" stands for the features of some vowel:¹²

(2.41)

$$\begin{array}{ll} \text{a. } \emptyset \rightarrow X / Y _ Z & \text{b. } \emptyset \rightarrow [V] / Y _ Z \\ & \quad \quad \quad | \\ & \quad \quad \quad X \end{array}$$

By the normal standards of simplicity, (2.41a) is the simpler rule: It mentions fewer features. Thus, if the quality of the epenthetic vowel is provided by independent means necessary to supply features to the vowels of the language in general, the entire grammar is simpler. Furthermore, there are languages (like Spanish) which have more than one epenthesis rule (see, e.g. Harris 1980 for four rules inserting vowels) yet the quality of the inserted vowel is always /e/. This distribution is expected with (2.41a) but

11. Thanks to Jim Harris for help with the Spanish facts, to Paul Kiparsky for help with Telugu, and to Anne-Marie Grignon for help with Japanese.

12. I am not concerned here with the proper formulation of the environment for epenthesis, which I assume is determined by syllable structure, and I have not presented an explicit environment since the environment is irrelevant to the present discussion.

coincidental with (2.41b).

What is particularly interesting about these three languages is that, although the vowels are the same, and each has an epenthesis rule, the epenthetic vowels are different. In Spanish, the epenthetic vowel is /e/, in Japanese, it is /i/, and in Telugu it is /u/ (see Harris 1980, Grignon in prep, and Romaro 1976, respectively). If it is correct to assume that the epenthetic vowel is the maximally unspecified one, then the underlying representations of the vowels in these three languages are different, despite the fact that the surface vowels are identical. Consider Spanish. The vowel inventory is represented below.

(2.42)

	i	e	a	o	u
H	+	-	-	-	+
L	-	-	+	-	-
B	-	-	+	+	+
R	-	-	-	+	+

If /e/ has no values, then the values of its features are not specified on /e/ nor on any vowel which shares these features. For example, /o/ is not specified for [high] nor for [low], since both of these are supplied by the same rule which supplies the values for /e/. Below, we see the value "-" removed from all features in the matrices in (2.42), since /e/ is [-F] for all [F]:

(2.43)

	i	e	a	o	u
H	+				+
L			+		
B			+	+	+
R				+	+

One of [back] and [round] must be specified for /o/ (and /u/) since otherwise it is filled in as [-round] and [-back] by the same rule that specifies /e/ "-" for these features. However, since these vowels agree in roundness and backness, we do not

need to specify values on both features. I remove [back].

(2.44)

	i	e	a	o	u
H	+				+
L			+		
R				+	+

The following redundancy rules fill in the blanks. The sources and ordering of these rules are discussed in the following sections. Some of the rules are universal default rules, marked "DR" in (2.45), and some are complement rules, marked "CR" in (2.45). Universal default rules are discussed in section 3.2 and complement rules in section 3.3. The ordering is intrinsic, and is discussed in section 4.

(2.45)

a.	[]	-->	[-high]	CR
b.	[]	-->	[-low]	CR
c.	[]	-->	[+back, -round] / [____, +low]	DR
d.	[]	-->	[-round]	CR
e.	[]	-->	[a back] / [.____, -low, a round]	DR

In the other languages, the case is similar except that the maximally unspecified vowel is not /e/. Representations and rules for Japanese and Telugu are given below.

(2.46)

	Japanese					Telugu				
	i	e	a	o	u	i	e	a	o	u
H		-		-		H		-	-	
L			+			L			+	
B				+	+	B	-	-		

It is proposed in the ensuing sections that certain redundancy rules are provided by universal grammar and further that the redundancy rules are intrinsically ordered. As a consequence, all of the rules supplying feature values in Japanese and

2.3 -- Underspecification Theory

Telugu are non-learned rules, just as they were with Spanish.¹³

(2.47)

Japanese rules

- | | | |
|----|---|----|
| a. | [] --> [-high] / [____, +low] | DR |
| b. | [] --> [+high] | CR |
| c. | [] --> [-low] | CR |
| d. | [] --> [+back, -round] / [____, +low] | DR |
| e. | [] --> [-back] | CR |
| f. | [] --> [a round] / [____, -low, a back] | DR |

(2.48)

Telugu rules

- | | | |
|----|---|----|
| a. | [] --> [-high] / [____, +low] | DR |
| b. | [] --> [+high] | CR |
| c. | [] --> [-low] | CR |
| d. | [] --> [+back, -round] / [____, +low] | DR |
| e. | [] --> [+back] | CR |
| f. | [] --> [a round] / [____, -low, a back] | DR |

What these three languages illustrate is that although the inventories of underlying segments are identical, the representation of the underlying segments may differ radically. The underlying matrix and redundancy rules, i.e. the alphabet, is closely connected to the way those segments are used in the language's phonological system.

2.3.2 Redundancy Rules

Of interest now is the question of how the missing values get assigned to the segments. The rules assigning missing values are called redundancy rules. For the most part, these are assigned by universal means, that is, by rules which do not have to be learned. There are two types of redundancy rules which do not have to be learned. One is a

13. To be precise, in Japanese, a learned rule specifies the [+high, +back] vowel as [-round]: [i], not [u].

2.3 -- Underspecification Theory

set of universal rules, called **default rules**, similar to the rules proposed in SPE and in Kean (1975). The other is a set of rules automatically created when a given underlying representation is learned, called **complement rules**. Rules of the latter type are not found in SPE-like treatments of markedness.¹⁴ See (2.17) for a classification of the three types of redundancy rules.

There are certain configurations of vowel features which are required:

(2.49)

- a. $\begin{bmatrix} +\text{high} \\ -\text{low} \end{bmatrix}$ b. $\begin{bmatrix} -\text{high} \\ +\text{low} \end{bmatrix}$

Other combinations are extremely common:

(2.49) cont.

- c. $\begin{bmatrix} +\text{low} \\ -\text{round} \\ +\text{back} \end{bmatrix}$ d. $\begin{bmatrix} -\text{low} \\ -\text{round} \\ -\text{back} \end{bmatrix}$ e. $\begin{bmatrix} -\text{low} \\ +\text{round} \\ +\text{back} \end{bmatrix}$

By positing universal default rules creating these combinations, the learnability of systems including these feature combinations is captured. Claiming that the default rules creating these configurations are universal rules means that a language which uses these rules is simpler than a language which contradicts these rules. The latter type of language is one in which both the alphabet and some redundancy rules must be learned. The language which uses the default rules as redundancy rules is one in which the rules need not be learned, only the underlying representation.

14. Kean (1975) uses the general concept of "complement" in constraining markedness rules. The rules in Kean (1975) are universals, however, not language dependent like the complement rules discussed here.

Some universal default rules are given below.

(2.50)

Universal Default Rules
[high] and [low]

- a. [] --> [-high] / $\left[\frac{\quad}{+low} \right]$
- b. [] --> [-low] / $\left[\frac{\quad}{+high} \right]$
- c. [] --> [+low] / $\left[\frac{\quad}{-high} \right]$
- d. [] --> [+high] / $\left[\frac{\quad}{-low} \right]$

(2.50a-d) create the two "required" feature combinations given in (2.49a,b). These are required in the sense that if either [+high] or [+low] is present, the opposing feature must be filled in as "-". This necessity is expressed by the existence of the rule pairs, both creating [a high, -a low] matrices. The configurations in (2.49a,b) contrast with those in (2.49c,d,e) because in the latter case the combinations are common, or preferred, but may be violated. Here, we simply establish values for [back] and [round] dependent on the value for [low] (and, if [-low], on the value for [back] or [round], whichever is present in underlying representation).

(2.50) cont.

Universal Default Rules:
[back] and [round]

- e. [] --> $\left[\frac{-round}{+back} \right]$ / $\left[\frac{\quad}{+low} \right]$

2.3 -- Underspecification Theory

f. [] --> [a round] / $\left[\begin{array}{c} \text{a back} \\ \text{-low} \end{array} \right]$

g. [] --> [a back] / $\left[\begin{array}{c} \text{a round} \\ \text{-low} \end{array} \right]$

Rules (2.50a-d) create [+high, -low] and [-high, +low] matrices; (2.50e) states that the preferred [+low] vowel is /a/, as it is [+back, -round]; (2.50f,g) capture the fact that for non-low vowels, the unspecified arrangement is where backing and rounding agree.

These rules also rank the five vowels /i, e, a, o, u/. If there is no phonological evidence in the language about vowel quality, /a/ is the least marked vowel: Specifying [+low] or [-high] is sufficient to distinguish the vowel /a/. All other values are filled in by universal default rules. Specifying [+high] or [-low] and some value for [back] or [round] distinguishes /i/ and /u/. To distinguish /e/ and /o/, both [-high] and [-low] must be specified (either in underlying representation or by rule) as well as some value for [back] or [round]. Consequently, all else being equal, the vowels are ranked:

[a] < {i,u} < {e,o}

Furthermore, this generates certain of the vowel systems discussed in the literature on vowel typologies (e.g. Liljencrants and Lindblom 1972 and Troubetskoy 1929), namely the odd-numbered vowel systems:

(2.51)

a. a	b. i u	c. i u
	a	e o
		a

2.3 -- Underspecification Theory

However, these rules do not supply all the missing values, even in simple systems like the three considered above. Consider the underlying representations we have for Spanish: We can apply the Universal Default Rule (2.50e) since /a/ is specified [+low], specifying /a/ as [+back, -round] as well. Also, Universal Default Rule (2.50a) fills in /a/ as [-high]: /a/ is now fully specified for the relevant features for vowels.

(2.52)

Spanish											
	i	e	a	o	u		i	e	a	o	u
H	+				+	====>	H	+	-		+
L			+				L		+		
B				+	+		B		+	+	+
							R		-		

Another rule may apply, (2.50b) which supplies [-low] to the [+high] vowels:

(2.53)

	i	e	a	o	u		i	e	a	o	u
H	+		-		+	====>	H	+	-		+
L			+				L	-	+		-
B			+	+	+		B		+	+	+
R			-				R		-		

Without filling in any more values, we cannot apply any other Universal Default Rules because the correct environments are not met, and /i/, /e/, /o/ and /u/ are incompletely specified.

2.3.3 Complement Rule Formation

We have assumed that Universal Grammar predisposes language learners to isolate feature oppositions, i.e. to isolate pairs of sounds distinguished by one feature. We have assumed further the set of universal default rules (2.50). These oppositions, the default rules, and additional information about the phonological system, e.g. the quality of

2.3 -- Underspecification Theory

an epenthetic vowel, serve as input to a procedure, the output of which is a set of Complement Rules and a minimally specified matrix component. Recall that a matrix and a set of rules is the alphabet of a language. Thus, the procedure is one of Alphabet Formation.

(2.54)

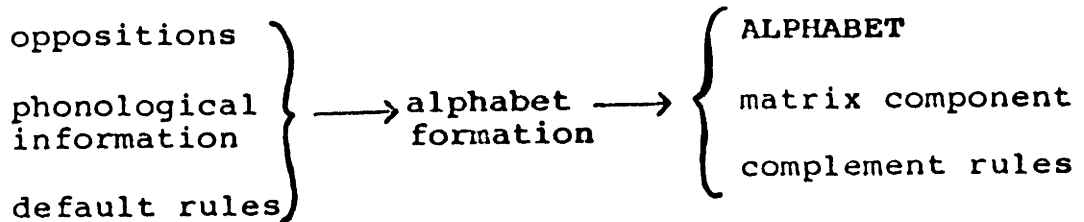

The procedure includes principles like those noted above: Minimize the number of features and minimize the number of marks. It also include the formation of complement rules and the selection of matrix values. Ideally, Alphabet Formation is an algorithm which takes certain information and automatically produces alphabets. I have not yet been able to formalize this algorithm beyond the statements below.

(2.55)

Alphabet Formation (Universal)

1. Given an opposition [a F] -- [-a F] in environment Q in underlying representation, one value "b" is selected as the matrix value for F in Q and the other value is specified by an automatically formed complement rule:

$$[] \text{ --> } [-b F] / Q$$

2. In the absence of language internal motivation for selecting a value as the matrix value for a feature F, the value "b" is selected as the matrix value where

$$[] \text{ --> } [-b F] / Q$$

is a member of the set of default rules.

In underlying representation in Spanish, vowels are specified [+high], [+back], and [+low]. The specification

2.3 -- Underspecification Theory

[+high] automatically creates a complement rule assigning [-high] elsewhere:

(2.56)
 $[] \rightarrow [-high]$

The specification [+back] automatically creates a complement rule assigning [-back] elsewhere:

(2.57)
 $[] \rightarrow [-back]$

and the specification [+low] automatically creates a complement rule assigning [-low] elsewhere:

(2.58)
 $[] \rightarrow [-low]$

Once these complement rules apply to the underlying representations for Spanish, the environments for other default rules are met. Recall that /a/ has been fully specified by the default rules. Below, we see the application of the rules formed automatically by Alphabet Formation (2.55). In (2.59), rule (2.56) applies, assigning [-high] to all matrices unspecified for [high], that is the matrices of /e/ and /o/:

(2.59)

	i	e	a	o	u		i	e	a	o	u
H	+	-	-	-	+	====>	H	+	-	-	+
L			+				L		+		
B			+	+	+	(2.56)	B		+	+	+
R			-				R		-		

Rule (2.57) supplies [-back] to matrices unspecified for [back], namely /e/ and /i/.

(2.59) cont.

	i	e	a	o	u		i	e	a	o	u
H	+	-	-	-	+	====>	H	+	-	-	+
L			+				L		+		
B			+	+	+	(2.57)	B	-	-	+	+
R			-				R		-		

2.3 -- Underspecification Theory

The value [-low] is specified on all vowels but /a/ by (2.58):

(2.59) cont.

	i	e	a	o	u			i	e	a	o	u
H	+	-	-	-	+		H	+	-	-	-	+
L			+			====>	L	-	-	+	-	-
B	-	-	+	+	+	(2.58)	B	-	-	+	+	+
R			-				R			-		

Now the rule supplying values for [round] (2.50f) applies.

(2.59) cont.

	i	e	a	o	u			i	e	a	o	u
H	+	-	-	-	+		H	+	-	-	-	+
L	-	-	+	-	-	====>	L	-	-	+	-	-
B	-	-	+	+	+	(2.50f)	B	-	-	+	+	+
R			-				R	-	-	-	+	+

The Japanese and Telugu examples are similar.

In this exposition, we have not paid particular attention to the ordering of the rules. The set of rules as applied here is given below.

(2.60)

- a. [] --> [-high] / $\left[\begin{array}{c} \text{---} \\ [+low] \end{array} \right]$ (=2.50d)
- b. [] --> $\left[\begin{array}{c} -round \\ +back \end{array} \right]$ / $\left[\begin{array}{c} \text{---} \\ [+low] \end{array} \right]$ (=2.50e)
- c. [] --> [-high] (=2.56)
- d. [] --> [-low] (=2.58)
- e. [] --> [-back] (=2.57)
- f. [] --> [a round] / $\left[\begin{array}{c} \text{---} \\ a \text{ back} \\ -low \end{array} \right]$ (=2.50f)

All of the ordering here is intrinsic, or there is no ordering. Rules (2.60a,b,c,d) are unordered with respect to each other. (2.60a) and (2.60c) are unordered by the Elsewhere Condition (1.21) since the outputs are

2.3 -- Underspecification Theory

non-distinct. (2.60b) must precede (2.60e) however, since the outputs are distinct, ordered by the Elsewhere Condition (1.21). Finally, (2.60f) must follow (2.60d,e) since (2.60d,e) provide values mentioned in the structural description of rule (2.60e). This ordering is provided by the Redundancy Rule Ordering Constraint (2.88), discussed below.

There is one other type of rule which supplies missing values, and that is a rule which must be learned for a given language. Some of these rules are rules which fill in values in the manner of the complement and default rules above, some are autosegmental spreading rules, or other "phonological" rules, like those in harmony systems, lowering rules, and the like. We examine rules of both types in Yawelmani.¹⁵

Notice that for the five vowel system /i, e, a, o, u/, regardless of the quality of the unspecified vowel, no learned rules are necessary to complete the specification of the vowel features once the underlying representation has been established. The default and complement rules are sufficient. The same holds for the three vowel system /i, a, u/. If we were to switch one of the vowels in these systems for any other vowel, we would need to add a rule to be learned as well as learning the underlying representations.

Consider the following five-vowel systems as a demonstration, where the circled vowel is the default vowel.

15. In the discussion of Latvian, there is a rule filling in the value [-low] on /o/, in footnote 6. This is a learned rule, not predictable by Universal Grammar.

2.3 -- Underspecification Theory

(2.61)

a. Nez Perce

i	u
	o
æ	a

b. Sarangani Manobo

i	i	u
	ə	
	a	

Consider Nez Perce first (data from Aoki 1965). The vowels divide into two harmonic classes, both of which contain /i/, which suggests that /i/ might be the default vowel since it is neutral. The following underlying representation results through Alphabet Formation (2.55):

(2.62)

Nez Perce:	i	æ	a	o	u	
H				-		a. [] --> [+high]
L	+	+				b. [] --> [-low]
B			+	+	+	c. [] --> [-back]

The values on /i/ ([+high, -low, -back, -round]) have all been removed in (2.62), as well as the redundant [-high] on the [+low] vowels. [Round] has been removed as well, since it is predictable for the [-low] vowels and does not distinguish between the two [+low] vowels.

Three features are used to distinguish the five vowels. The default rules (2.50) and the complement rules (2.62a-c) do not correctly supply all the missing values:

(2.63)

Nez Perce:	i	æ	a	o	u
H	+	-	-	-	+
L	-	+	+	-	-
B	-	-	+	+	+
R	-			+	+

A rule must be learned to specify the [+low] vowels as [-round]:

(2.64)

[] --> [-round] / [____, +low]

2.3 -- Underspecification Theory

Nez Perce has a more complex system than Spanish, Japanese, or Telugu, because a rule must be learned, even after Alphabet Formation (2.55). Sarangani Manobo (Reid 1973) has a more complex vowel system, too. Its complexity lies in the fact that four features must be present in its alphabet -- but no rules must be learned.

(2.65)

Sarangani		i	ɨ	u	ə	a		
Manobo	H				-		a.	[] --> [+high]
	L					+	b.	[] --> [-low]
	B	-					c.	[] --> [+back]
	R			+			d.	[] --> [-round]

A five vowel system not composed of /i, e, a, o, u/ is complicated either in that a rule (or more) must be explicitly learned (Nez Perce) or in that more than three features are required to distinguish the vowels of the system (Sarangani Manobo). With the /i, e, a, o, u/ system, all feature values are filled in without learning any rules at all, and the logically minimal number of features (three) to distinguish the five vowels is sufficient.

A further word must be said about four-vowel systems. Using the four features [high, low, back, round], we predict six combinations of four-vowel systems specified with the minimal number of features, two. There are only three alphabets, however, which are least costly for four vowel systems, those using the feature [high] with either [back] or [round] and one using [low] with [back]. These are given below, where it is arbitrarily assumed that "+" is the specified value.

(2.66)

		V ₁	V ₂	V ₃	V ₄		
a.	high	+	+			i.	[] --> [-high]
	back		+	+		ii.	[] --> [-back]

- | | | | | | | | | |
|----|-------|---|---|----|-----|-----|---------|----------|
| b. | high | + | + | i. | [] | --> | [-high] | |
| | round | | + | + | ii. | [] | --> | [-round] |
| | | | | | | | | |
| c. | low | + | + | i. | [] | --> | [-low] | |
| | back | | + | + | ii. | [] | --> | [-back] |

There are of course other feature combinations possible: [low, round], [low, high], and [round, back]. The first is extremely costly for four vowel systems because a [+low, +round] segment is not easily distinguished perceptually from [+low, -round] nor from [-low, +round]. A rule marking a [+low] vowel [+round] and vice versa is undesirable. We formally encode this by including

(2.67)

- | | | | | | |
|----|-----|-----|----------|---|----------------|
| a. | [] | --> | [-round] | / | [____, +low] |
| b. | [] | --> | [-low] | / | [____, +round] |

in Universal Grammar, ordered intrinsically after (2.50e) (which supplies [+back, -round] on [+low] vowels. (2.67) must be a rule separate from (2.50e), else /æ/ is valued equally with /a/, yet this apparently is not the case (see Liljencrants and Lindblom 1972 for a listing of four-vowel systems).

The other two systems, [high, low] and [back, round], are undesirable also. In examining the vowel harmony systems in Yokuts (Chapter 3, section 1) we see evidence for separating [high] from [back, round]. If we assume that features are grouped in certain ways, one of these ways being tongue height features in one group and backness and roundness in another, then highly valued systems are ones which exploit both groups, selecting a feature from each (one of [high, low] and one of [round, back]). A system using only one group (e.g. [back, round] does not exploit the natural grouping and so is harder to learn. The tongue height features are readily grouped by being a common articulator. The features [round]

and [back] are grouped because each enhances the other (see Keyser and Stevens 1983 on enhancement).

The [high, low] system is logically ruled out for four-vowel systems also. It is impossible to register both [+high] and [+low] on a non-contour segment. Thus, [high] and [low] distinguish only three segments, not four.

Given the possible alphabets, the following are the least costly systems (since they maximize the use of the default rules provided by universal grammar):

(2.68)

<p>a. i u a æ</p> <p> H + +</p> <p> B + +</p>	<p>b. i u o a</p> <p> H + +</p> <p> R + +</p>	<p>c. i u a æ</p> <p> L + +</p> <p> B + +</p>
---	---	--

If 2.68a should actually produce /i, u, a, e/ in its least costly state some other default rule must be added. It might be desirable to make this move, since 2.68b,c cannot produce /i, u, a, e/ yet this system intuitively is not as marked as, say /i, u, a, æ/.

Other systems can be produced from the alphabets in (2.68) but they involve learned rules, and so are more costly.

2.4 Yawelmani Vowels

We turn now to a detailed examination of the Yawelmani vowel system. Three independent rules, Epenthesis, Harmony, and Dissimilation converge on the underlying representations of Yawelmani vowels predicted by the theory of underspecification outlined above.

2.4.1 Underlying Representation

It has long been recognized that there are four vowels in underlying representation in Yawelmani, while there are five on the surface (see, for example, Kuroda (1967)). I do not dispute the observation: The underlying and surface vowels are given below in (2.69).

(2.69)

underlying	surface
i/ii	i/ii
a/aa	e/ee
o/oo	a/aa
u/uu	o/oo
	u/uu

The surface alternations are due to a variety of rules, indicated in Newman (1944) and made formal in Kuroda (1967), rules of vowel harmony, lowering, and syllabification primarily. (These are the focus of the ensuing chapter.) Here, we consider the minimal specification of the underlying vowels and the interaction of this specification with Harmony, Epenthesis, and Dissimilation.

The feature matrices for the four underlying vowels are given in (2.70) below. In this discussion, only the features [high], [low], [back], and [round] are considered. This is of significance: These are the only features which provide phonetic distinctions among the various Yawelmani vowels. The other features, e.g. [nasal], [voice],..., have the same value for all four vowels and consequently have been ignored.¹⁶

(2.70)

	i	a	o	u
high	+	-	-	+
low	-	+	-	-
round	-	-	+	+
back	-	+	+	+

Splitting along the high/low and round/back axis, we see immediately that [high] and [round] are the distinctive features in Yawelmani, not [low] nor [back]. The feature [high] divides the vowels into two equal groups, those which are [+high] (i,u) and those which are [-high] (o,a). The feature [low] does not divide the four segments evenly -- only one is [+low] (a) and the rest are [-low] (i,u,o). The feature [round] divides the vowels evenly as well -- two are [+round] (u,o) and two are [-round] (i,a). [Back], however, does not do this: Three vowels are [+back] (u,o,a) while only one is [-back] (i).

16. The feature [ATR] has different values for vowels of different height values if totally unspecified, supplied by the following default rule:

[] --> [a ATR] / [____, -a low]

Presumably Yawelmani follows this pattern: [ATR] could be included in the representations in the text and has been omitted simply for brevity.

(2.71)

	i	a	o	u
high	+	-	-	+
round	-	-	+	+

This much can be discerned simply from the underlying vowels of the language. Add to this the knowledge that /i/ is the epenthetic vowel. This means that the values for the features of /i/ are given by rule, not in the underlying representation. We are left, then, with the alphabet below, with minimal specifications of the two features and the relevant complement rules:

(2.72)

	i	a	o	u
high		-	-	
round			+	+

- a. [] --> [+high]
 b. [] --> [-round]

Note that no other combination of two features can capture the distinctions between these four vowels. Consider specifying [low] and [round] instead of [high] and [round]:

(2.73)

	i	a	o	u
L		+		
R			+	+

The matrices for /o/ and /u/ are identical. A third feature must be added to distinguish them. Since they are both [+back], the feature [high] must be added.

(2.74)

	i	a	o	u
L		+		
R			+	+
H		-	-	

Once [high] is added, there is no motivation for representing [low] in the alphabet.

Specifying [high] and [back] leads to essentially the same problem, two segments, /a/ and /o/ are not distinguished:

(2.75)

	i	Ⓐ	Ⓞ	u
H		-	-	
B		+	+	+

We must add [low] or [round], a third feature, to distinguish /a,o/. If [round] is added, [back] becomes unmotivated.

Combining [high] and [low] or [back] and [round] is equally unsatisfactory. In each case a third feature must be added to differentiate the two identical matrices (circled below).

(2.76)

	⓪	Ⓢ	a	o		i	a	Ⓞ	Ⓢ
L			+			B	+	+	+
H			-	-		R	+	+	+

The only minimal representation of the four vowels of Yawelmani is that given in (2.72), but the complement rules do not suffice to fill in all of the unspecified values. We also need rules supplying values for [back] and [low]. Some of these, of course, are provided by universal grammar:

(2.77) (=2.72 cont.)

- c. [] --> [+low] / $\left[\begin{array}{c} \text{---} \\ \text{-high} \end{array} \right]$
- [] --> [-low] / $\left[\begin{array}{c} \text{---} \\ \text{+high} \end{array} \right]$
- d. [] --> $\left[\begin{array}{c} \text{+back} \\ \text{-round} \end{array} \right]$ / $\left[\begin{array}{c} \text{---} \\ \text{+low} \end{array} \right]$
- e. [] --> [a back] / $\left[\begin{array}{c} \text{---} \\ \text{-low} \\ \text{a round} \end{array} \right]$

These rules, however, predict a low, round vowel with an unknown value for [back], instead of /o/. If the hypothesis

2.4 -- Yawelmani Vowels

made with respect to (2.67) is correct, there is a universal rule inserting [-low] on the [+round] vowel. Otherwise, a language particular rule must be learned to produce [o] instead of a back or front low round vowel.

(2.77) cont.

f. [] --> [-low] / $\left[\begin{array}{c} +\text{round} \\ -\text{high} \end{array} \right]$

Given the representations in (2.72) and the redundancy rules in (2.77a-f), we can derive the completely specified matrices for the four underlying vowels in Yawelmani. However, as listed in (2.77), the rules are in the wrong order, in particular (2.77c) must follow (2.77f), else /o/ is specified as [+low] by (2.77c) and (2.77f) cannot change the value. Given the formulation of the rules above, the Elsewhere Condition (1.21) provides the correct ordering. (2.77c,f) must precede (2.77d,e) since otherwise there is no value on the feature [low] to act as trigger in (2.77d,e). We return to this point in the discussion of the Redundancy-Rule Ordering Constraint (2.88) in section 4.3 of this chapter.

Notice further that, given the representation in (2.72), there are only two possible unbounded spread rules, spread of [-high] and spread of [+round]. These are the only unbounded harmony rules available in Yawelmani. Any other spread rule must be bounded because spreading a value unspecified in underlying representation necessitates supplying the value prior to spread. But once the feature's values are inserted, spread is stopped by the associations between slots and melody units. We return to this point after introduction of the Redundancy-Rule Ordering Constraint (2.88). Yawelmani has, in fact, a rule spreading [+round]. In the next section, this rule and its interaction with the redundancy rules is discussed.

2.4 -- Yawelmani Vowels

2.4.2 Vowel Harmony in Brief

The rule of vowel harmony rounds (and backs) /i/ to [u] after /u/, and rounds (and raises) /a/ to [o] after /o/. This is illustrated below.¹⁷

(2.78)

a. i ----> u / u C _____

lihimhin	< lihm + hn	'ran'	137
hoginhin	< hogn + hn	'floated'	122
baḥinhin	< baḥn + hn	'fell down'	138
?ugunhun	< ?ugn + hn	'drank'	151
ṣil'hin	< ṣil' + hn	'saw'	145
yoloowinhin	< yoloow + in + hn	'assembled'	122
cawhin	< caw + hn	'shouted'	135
duyduyhun	< duy + dy + hn	'stung rep.'	122

b. a ----> o / o C _____

di?ṣal	< di?ṣ + al	'might make'	120
xatal	< xat + al	'might eat'	120
hoḥnol	< hoḥn + al	'might take the scent'	120
ṣoogal	< ṣuug + al	'might pull out'	120

17. Numbers after each form indicate the page in Newman (1944) on which the example may be found. The first morpheme in each sequence is the verb root. In (2.78a), the other morphemes are hn 'aorist', in 'mediopassive', CC (reduplication) 'repetitive'. In (2.78b), the other morphemes are (a)l 'dubitative', (h)atn 'desiderative', xoo 'durative', Ka 'imperative', hn 'aorist', and ? 'future'. For discussion of the parenthesized /h/ in (h)atn, see Chapter 4, section 3.3.1, of the parenthesized /a/ in (a)l see Chapter 3, section 2.4.4.

2.4 -- Yawelmani Vowels

bintatinoxok	'be trying to ask!'	
< biniit + (h)atn + xoo + ka		104
ɕawhatinxoohin	'was trying to win'	
< ɕaw + (h)atn + xoo + hn		104
hudhatinxo?	'wants to know about'	
< hud + (h)atn + xoo + ?		114
doshotinxoohin	'was trying to tell'	
< dos + (h)atn + xoo + hn		114

Harmony spreads the feature [+round] onto a sequence of vowels with the same value for [high]. The exact formulation of this rule is motivated in the following chapter.

(2.79)

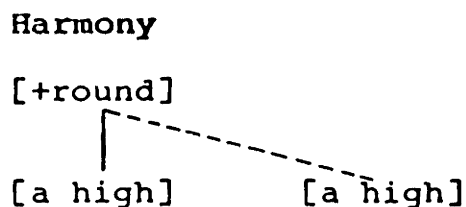

In order for precisely this rule to apply, and not a rule spreading [+round] on [-high] vowels for example, the values [+high] and [-high] must be present at the point in the derivation that Harmony (2.79) applies. This necessitates ordering (2.77a), the redundancy rule which inserts [+high], prior to Harmony (2.79). We return to this point in the following section (4.3 immediately below). For the moment, we simply stipulate that when Harmony (2.79) applies, the following are the feature matrices of the vowels:

(2.80)

vowels after application of [high] default rule (2.77a)

	i	a	o	u
high	+	-	-	+
round			+	+

What is of interest to us is to consider what happens to the matrices for /i/ and /a/ after Harmony (2.79) has applied. When the feature [+round] is added to the matrices

2.4 -- Yawelmani Vowels

in (2.80), the representations of /i/ and /a/ collapse with those of /u/ and /o/ respectively. This is seen below, where the circled values have been added by Harmony (2.79).

(2.81)

vowels after application of Harmony (2.79)

	i	a	o	u
high	+	-	-	+
round	⊕	⊕	+	+

The rules needed independently to get [u] from [+round, +high] and to get [o] from [-high, +round] (given in (2.77) and again below in (2.82) for convenience) give [u] and [o] respectively from underlying /i/ and /a/ if Harmony has applied.

(2.82) (=2.77 reordered)

Default Rules for Yawelmani Vowels

- a. [] --> [+high]
- b. [] --> [-low] / $\left[\begin{array}{c} \text{+round} \\ \text{-high} \end{array} \right]$
- c. [] --> [a low] / $\left[\begin{array}{c} \text{-a high} \end{array} \right]$
- d. [] --> $\left[\begin{array}{c} \text{+back} \\ \text{-round} \end{array} \right]$ / $\left[\begin{array}{c} \text{+low} \end{array} \right]$
- e. [] --> [-round]
- f. [] --> [a back] / $\left[\begin{array}{c} \text{-low} \\ \text{a round} \end{array} \right]$

The complete derivations of the vowels are seen in (2.83). In the first four columns we see the four underlying vowels and Harmony (2.79) does not apply to any of them. In the last two columns, we see underlying /i, a/ which surface as [u, o] respectively, due to the effects of Harmony (2.79) at the second step in the derivation. From that point on, the

2.4 -- Yawelmani Vowels

harmonized matrices are non-distinct from those of underlying /u/, /o/, and so no difference in derivation occurs. The values inserted by each rule are circled.

(2.83)

		no harmony				harmony	
		i	u	a	o	i	a
UR	H			-	-		
	R		+		+		-
Redundancy Rule 2.82a	H	⊕	⊕	-	-	⊕	-
	R		+		+		
Harmony 2.79	H	+	+	-	-	+	-
	R		+		+	⊕	⊕
Redundancy Rule 2.82b	H	+	+	-	-	+	-
	R		+		+	+	+
	L				⊖		⊖

Notice that rule (2.82b) fills in [-low] both on the underlying /o/, which is [-high, +round] in underlying representation, and on the harmonized /a/, which is [-high] underlyingly and which is assigned [+round] by Harmony (2.79), thereby meeting the environment for (2.82b). Rule (2.82c) now fills in values for [low] elsewhere.

(2.83) cont.

		i	u	a	o	i	a
Redundancy Rule 2.82c	H	+	+	-	-	+	-
	R		+		+	+	+
	L	⊖	⊖	⊕	-	⊖	-

Application of (2.82d) assigns [-back, +round] to the [+low] vowel. It cannot apply to the harmonized /a/ because this vowel is not [+low].

2.4 -- Yawelmani Vowels

(2.83) cont.

		i	u	a	o	i	a
Redundancy	H	+	+	-	-	+	-
Rule 2.82d	R		+	⊖	+	+	+
	B			⊕			
	L	-	-	+	-	-	-

Now, (2.82e) applies to fill in [-round] on /i/. Application of (2.82e) to the harmonized /i/ is blocked by the Distinctness Condition (2.20) because the harmonized /i/ already has a value for [round].

(2.83) cont.

		i	u	a	o	i	a
Redundancy	H	+	+	-	-	+	-
Rule 2.82e	R	⊖	+	-	+	+	+
	B			+			
	L	-	-	+	-	-	-

Finally, (2.82f) applies to assign values to the feature [back]. The feature [+back] is added to the harmonized /i, a/ because Harmony (2.79) assigned [+round] to each.

(2.83) cont.

		i	u	a	o	i	a
Redundancy	H	+	+	-	-	+	-
Rule 2.82f	R	-	+	-	+	+	+
	B	⊖	⊕	+	⊕	⊕	⊕
	L	-	-	+	-	-	-

		no harmony				harmony	
UR		i	u	a	o	i	a
SR		i	u	a	o	u	o

Notice that if we assume the matrices are fully specified in underlying representation, then we fail to account for /i/ backing (as well as rounding) to [u] and /a/ raising (as well as rounding) to [o] by Harmony (2.79). We could get around this problem by introducing the two features [back] and [low] into the harmony rule, thereby obscuring the basic rounding process.

2.4 -- Yawelmani Vowels

2.4.3 The Redundancy-Rule Ordering Constraint

We now consider certain constraints on the ordering of the redundancy rules.

First, as already mentioned, these rules are subject to the Elsewhere Condition (1.21). Thus, if in underlying representation some feature [F] is learned as [a F] in environment Y, then, by alphabet formation we also have a (complement) rule supplying [-a F] in environment Y:

(2.84)

UR:	A	B	Complement Rule
	F	a	[] --> [-a F] / Y
	Y	Y	

The Elsewhere Condition (1.21) means that if a language particular rule, like harmony, supplies a value for some unspecified feature, the language particular rule takes precedence over the redundancy rule. This happens with Latvian Raising (see section 2.2.3) and with Yawelmani harmony (see this section).

A second constraint, implicit in the above discussion, is that all redundancy rules apply as late as possible. This is in direct contrast to the assumptions in SPE and in Kean (1975), where it is assumed that rules providing feature values apply prior to any phonological rule in the familiar sense. Late application of the redundancy rules puts the feature-specifying rules in the same position in the grammar as the "phonetic clean-up rules", a traditional grab-bag used informally to simplify phonological rules. We have seen two examples already of the redundancy rules operating in the grammar in a manner similar to "clean-up" rules, Latvian Raising and Yawelmani Harmony. In Latvian, the following alternations occur:

2.4 -- Yawelmani Vowels

(2.85)

	a --> u		e --> i	
H	-	+	H -	+
L	+	-	L -	-
R	-	+	-	-
B	+	+	i -	-

In Yawelmani, the alternations are:

(2.86)

	a --> o		i --> u	
H	-	-	H +	+
L	+	-	L -	-
R	-	+	R -	+
B	+	+	B -	+

The following rules effect the change common to both pairs:

(2.87)

Latvian: V --> [+high]

Yawelmani: V --> [+round]

However, as noted above, other features change as well. "Clean-up" rules have been claimed to account for these alternations, rather than obscuring the basic processes by changing all features which change by the application of one rule. I know of no formal account of these "clean-up" rules. The theory of underspecification provides (i) a formal and principled means for filling in "phonetic details", via redundancy rules not ordered in the phonology and (ii) an explicit procedure for knowing when a feature can not be supplied by a late redundancy rule, that is, if it is present in underlying representation, inserted by a phonological rule, or referred to in the structural description of a phonological rule and so reordered by the Redundancy-Rule Ordering Constraint (2.88), which we now turn to.

Not all redundancy rules apply "last thing". Beyond being ordered by the Elsewhere Condition (1.21), the feature-specifying rules (both complement and default rules)

are subject to the following Redundancy-Rule Ordering Constraint:

(2.88)

Redundancy-Rule Ordering Constraint

A redundancy rule assigning "a" to F, where "a" is "+" or "-", is automatically ordered prior to the first rule referring to [a F] in structural description.

In other words a specific redundancy rule (either default, complement, or learned) which supplies [a F] is ordered immediately preceding the first rule mentioning [a F] in its structural description. This includes the following points:

- The structural description includes both focus and environment.
- The ordering is absolute (not local). This means that if a redundancy rule R is ordered by the Redundancy-Rule Ordering Constraint (2.88) prior to some phonological rule P_n , then rule R applies prior to all rules P_m where P_m is ordered after P_n , regardless of whether P_n actually applies
- Depending on the stratum the redundancy rule is placed in, its application is cyclic or non-cyclic.
 - * Only the relevant redundancy rule is reordered. All other rules are unaffected.
 - * In particular, only the redundancy rule inserting [a F] is reordered. A redundancy rule inserting [-a F], if one exists, is not reordered.

Consider the phonological rules in (2.89a,b) and the two

redundancy rules in (2.89ci,ii):¹⁸

(2.89)

- a. $A \rightarrow B / ___ [+F]$ b. $[+F] \rightarrow B$
- c. i. $[] \rightarrow [+F] / ___ Q$
 ii. $[] \rightarrow [-F]$

Since in (2.89a), the environment of the phonological rule mentions $[+F]$ and in (2.89b) the focus mentions $[+F]$, in both cases the redundancy rule (2.89ci), which supplies $[+F]$, is ordered prior to the (2.89a,b) rules, as noted above. This is a constraint on rule ordering, not on derivations, so the orders

ci < a < cii and ci < b < cii

are absolute. If there is a rule (d) ordered after (2.89a) or after (2.89b), (2.89ci) also precedes (d). Also, in the reordering, only (2.89ci) is reordered. The redundancy rule (2.89cii), although it inserts the feature $[F]$, does not insert $[+F]$, and so is unaffected by the Redundancy-Rule Ordering Constraint (2.88).

A similar constraint was proposed and rejected in SPE, because it was conceived of as a constraint on derivations, not on rule order.

18. The formal difference between redundancy rules and phonological rules is that in the structural description of phonological rules, a feature or structure to be changed is necessarily mentioned. Redundancy rules do not, since they never change structure. Redundancy rules can change structure/value in an derived environment (i.e. subject to the Strict Cycle Condition 1.20) if the redundancy rule does not specify that the segment being changed has no structure/value.

2.4 -- Yawelmani Vowels

(2.90)

"A grammar is not well-formed if in any derivation the rule

$$A \rightarrow B / X _ Y$$

is available for application to a matrix M which is not distinct from XAY and of which XAY is not a submatrix."

SPE, p. 384

(Distinct is defined in 2.21).

The constraint above limits derivations. Hence, with (2.90) it is impossible to tell if a grammar is well-formed simply by examining the grammar itself. Examination of all possible derivations to test whether a given grammar is well-formed puts too great a burden on the language learning process. To quote Chomsky and Halle (1968):

"A grammar represents a particular speaker's competence in some language. Since only well-formed grammars are acquired and since such grammars are acquired in a reasonably short time, the question of well-formedness must be decidable by a procedure that terminates quite rapidly. Under condition (147) [=90 --DA], this is not the case; therefore, it follows that this condition cannot realistically be imposed on grammars."

SPE, p. 384

With the Redundancy-Rule Ordering Constraint (2.88), examination of the grammar itself, not of specific derivations, decides whether or not the grammar is well formed.

There are both theoretical and practical results to be gained from the Redundancy-Rule Ordering Constraint (2.88). I address the theoretical points now, and return to the

2.4 -- Yawelmani Vowels

practical point in further discussion of Yawelmani Harmony (2.79). A problem for an unrestricted theory of underspecification is that it allows for ternary use of binary features, the objections raised by Lightner (1963) and Stanley (1967). They observed correctly that if a feature F is represented as any one of [+F], [-F] and [] (or "[Ø F]") in the same environment, then three distinct matrices can be derived from these three matrices, thus allowing [] to act as a third feature value. As noted above, if we adopt the Redundancy-Rule Ordering Constraint (2.88), there is no motivation for the configurations in (2.91) occurring in the same environment.

(2.91)

A	B	C
F	+	-

By the Redundancy-Rule Ordering Constraint (2.88), the redundancy rule supplying [+F] (or [-F]) and so filling in C must apply prior to the first rule referring to that value for [F] in its structural description. Consider the following grammars:

(2.92)

Phonological rule: a. [] --> [-G] / [____, +F]

Redundancy rules: b. [] --> [+F]
 c. [] --> [+G]

The Redundancy-Rule Ordering Constraint (2.88) automatically reorders (2.92):

(2.93)

b. [] --> [+F]
 a. [] --> [-G] / [____, +F]
 c. [] --> [+G]

Application of (2.93b) to (2.91) gives (2.94), where A and C are identical:

2.4 -- Yawelmani Vowels

(2.94)

	A	B	C
F	+	-	+
G			

The first rule that could distinguish between A and C (or B and C, with the redundancy rule [] --> [-F]) on the basis of [F] (which we are assuming is the only difference between A, B, C) is not able to distinguish because of the Redundancy-Rule Ordering Constraint (2.88). As a consequence, there is no motivation for positing the underlying representations in (2.91), but only for those below:

(2.95)

	A	B		A	B
F	+		F		-

Thus, the Lightner-Stanley objection is dismissed.¹⁹

A second result obtained from the Redundancy-Rule Ordering Constraint (2.88) is that "alpha-notation" can only be used to refer to both "+" and "-", as distinct from each other. If a rule refers to [a F], then both [+F] and [-F] must be present prior to application of the rule. Consider the Yawelmani harmony rule:

19. Kiparsky (1982) also discusses the Lightner-Stanley objections to underspecification. Kiparsky's proposal is to constrain the grammar by stipulating that both values may not be assigned to the same feature in the same environment in underlying representation. This constraint is a stipulation focussed directly on the Stanley-Lightner objections. This contrasts with the Redundancy-Rule Ordering Constraint (2.88) which, as shown in the text, has implications beyond preventing ternary use of binary features.

2.4 -- Yawelmani Vowels

(2.96) (=2.79)

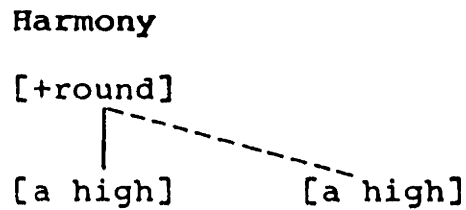

Recall the Yawelmani vowel system (2.72). The Redundancy-Rule Ordering Constraint (2.88) forces filling in of [+high] prior to application of the rule (2.96), resulting in the following matrices:

(2.97)

	i	u	a	o
high	+	+	-	-
round		+		+

Now consider the following sequences of [+round]--[] vowels: When Harmony (2.96) applies to the representations in (2.97), the following forms result:

(2.98)

UR	u	i	o	i	o	a	u	a
high	+	+	-	+	-	-	+	-
round	+	+	+	-	+	+	+	-

As seen above, the redundancy rules (2.82) fill in the rest of the features.

(2.99)

UR	u	i	o	i	o	a	u	a
high	+	+	-	+	-	-	+	-
round	+	+	+	-	+	+	+	-
back	+	+	+	-	+	+	+	+
low	-	-	-	-	-	-	-	+
SR	u	u	o	i	o	o	u	a

Suppose instead that we apply Harmony (2.96) before filling in all values for [high]. Now, since only one of the two values is present, we must define "Ø" as either distinct from or non-distinct from a specified value. If "Ø" is not distinct from + (or -), then the [+high] and [] act the same:

2.4 -- Yawelmani Vowels

(2.100)

[] and [a F] are not distinct

UR	u	i	o	i	o	a	u	a
high			-		-	-		-
round	+	+	+	+	+	+	+	+

Universal default rules then give (ignoring [back] and [low]):

(2.101)

UR	u	i	o	i	o	a	u	a
high	+	+	-	+	-	-	+	-
round	+	+	+	+	+	+	+	+
SR	u	u	o	u	o	o	u	o

which contrasts with the results in (2.99) where all values for [high] are filled in prior to application of (2.96).

Furthermore, there is a simpler way of writing the rule to account for the data in (2.101), namely

(2.102)

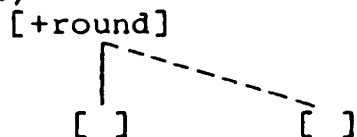

since the values for [high] do not matter. This is essentially the rounding harmony rule of Khalkha Mongolian and (with [+back] replacing [+round]) the backing harmony rule of Turkish.

The second option is to consider [] as distinct from "+" or "-": Here, the rule spreads [+round] if both vowels are [-high] and nothing spreads if either is []:

(2.103)

[] and [a F] are distinct

UR	u	i	o	i	o	a	u	a
high			-		-	-		-
round	+		+		+	+	+	

Universal default rules now give us (again ignoring [back] and

2.4 -- Yawelmani Vowels

[low]):

(2.104)

UR	u	i	o	i	o	a	u	a
high	+	+	-	-	-	-	+	-
round	+	-	+	-	+	+	+	-
SR	u	i	o	i	o	o	u	a

again a different result from (2.99) and again there is a formulation for precisely this rule:

(2.105)

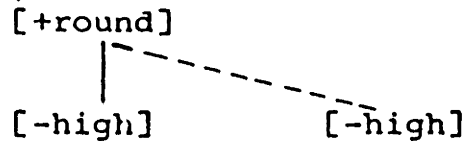

The rule in (2.105) is essentially the rounding harmony rule of Turkish (with [+high] replacing [-high]) and the backing harmony rule of Khalkha Mongolian (replacing [round] with [back]). (See Clements and Sezer 1982 and Steriade 1979 on Turkish and Khalkha Mongolian respectively.)

Since in principle we do want to be able to express all three types of rule and if we maintain underspecification theory, there must be some property of Universal Grammar which allows expression of the distinction between the three rules, (2.96), (2.102), and (2.105). The Redundancy-Rule Ordering Constraint (2.88) has exactly this effect, as well as ruling out ternary values.

A third result has been alluded to already: There are severe constraints on unbounded autosegmental spreading rules. Recall the Yawelmani vowel alphabet, repeated below for convenience:

(2.106)

	i	a	o	u
H		-	-	
R			+	+

2.4 -- Yawelmani Vowels

If we want to spread [-round] instead of [+round], then [-round] must be inserted by the Redundancy-Rule Ordering Constraint (2.88). Yet if [-round] is inserted, then all X-slots bear some value for [round] and unbounded spread may not apply:

(2.107)

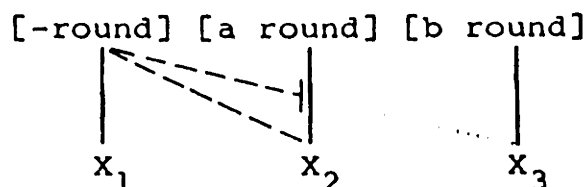

The association between [a round] and X₂ blocks unbounded spread of [-round].

A rule spreading [back] or [low] has similar problems. To spread [back] (+, -, or "a"), all values of [back] must be inserted. The relevant rules are:

(2.108)

- a. [] --> [+back, -round] / [____, +low]
- b. [] --> [a back] / [____, a round, -low]

The first rule supplies only [+back], but the second rule also supplies [+back] and so [a back] or [+back] spread may not precede application of the two rules in (2.108), by the Redundancy-Rule Ordering Constraint (2.88). Also, [-back] is supplied simultaneously with [+back] so both values are present prior to application of a rule spreading [-back]. Hence spread of the feature [back] can only be bounded.

With [low], there are three relevant rules:

(2.109)

- a. [] --> [-low] / [____, +round, -high]
- b. [] --> [+low] / [____, -high]
- c. [] --> [-low] / [____, +high]

A rule spreading [-low] cannot apply until all values of [low] are inserted since the last of the three rules inserts

2.4 -- Yawelmani Vowels

[-low]. A rule spreading [a low] is similarly restricted. A rule spreading [+low] is permitted to apply after /o/ is specified [-low] by (2.109a) and /a/ is specified [+low] by (2.109b), but before /i,u/ are specified [-low]. The Redundancy-Rule Ordering Constraint (2.88) and the theory of underspecification thus predicts asymmetries in spread rules.

2.4.4 Two Other Rules -- Epenthesis and Dissimilation

As is discussed in Chapter 3, section 2, there is an epenthetic vowel in Yawelmani which surfaces as [i] or [u], [u] occurring in harmony environments only. Thus we may say that the epenthetic vowel is underlyingly /i/. But this is precisely what we expect if we epenthesize a position only. The other features are filled in automatically by the redundancy rules (2.82), needed anyway. Thus, the theory of underspecification allows the simplest representation of epenthesis (at least in this case), the insertion of a skeletal position, with all other results following from independently needed rules, most of which are provided by universal grammar.

A second rule, discussed further in section 5 of Chapter 4, operates in certain noun paradigms to insert a vowel with a value for [high] opposite that of the preceding vowel. (Forms are given with underlying vowel quality and quantity, not surface. Results of Harmony, Shortening, and Epenthesis are not depicted.)

(2.110)

plural singular

- a. insert /i/ after /a/ 207
naa?id < na?aad 'older sister'
naaptim < napaatm 'male relation by marriage'

2.4 -- Yawelmani Vowels

- b. insert /i/ after /o/ 207
 noopip < nopoop 'father'
 ʔooŋtim < ʔooŋoŋm 'transvestite'
- c. insert /a/ after /i/ 206
 niiʔaʃ < niʔiiʃ 'younger brother'
 ʔiipan < ʔipnii 'one endowed with magic powers'
- d. insert /a/ after /u/ 206
 nuusas < nusuus 'paternal aunt'
 huuʃaʔ < huluuʃaʔ 'one who is sitting down'

With full specification, the rule uses alpha notation to capture the values of [back] and [low] as well as of [high]:

(2.111)
 $\emptyset \rightarrow \left[\begin{array}{l} \text{-a high} \\ \text{-round} \\ \text{a low} \\ \text{a back} \end{array} \right] / [\text{a high}] \text{ ______ } \text{ in certain noun paradigms}$

The dependence of [back], in particular, and [low] on the preceding vowel's value for [high] is an unintuitive move at best. Consider the rule in terms of underspecification, however:

(2.112) (=4.112)
 Dissimilation

$\emptyset \rightarrow [-\text{a high}] / [\text{a high}] \text{ ______ } \text{ in certain noun paradigms}$

Dissimilation (2.112) must follow (2.82a), the rule which inserts values for [high], by the Redundancy-Rule Ordering Constraint (2.88). However, (2.82a) is the only redundancy rule that must precede Dissimilation (2.112). Once a value for [high] is inserted, the remaining features spelling out [i] or [a] follow from the Yawelmani Redundancy Rules (2.82a-f).

Thus, three different rules, Harmony (2.96), Epenthesis, and Dissimilation (2.112), converge on the same underlying

2.5 -- Yawelmani Consonants

(2.113)

	Labial	Dental	Alveolar	Palato- Alveolar	Palatal
Stops					
intermediate	b	d	ɖ		ʃ
aspirate	p	t	tʰ		k
glottalized	p̚	t̚	t̚ʰ		k̚
Affricates					
intermediate		z			
aspirate		c			
glottalized		c̚			
Fricatives					x
Sibilants		s	ʂ		
Nasals					
plain	m	n			
glottalized	m̚	n̚			
Semivowels					
plain	w			y	
glottalized	w̚			y̚	
Laterals					
plain			l		
glottalized			l̚		
Aspiration					h
Glottal stop					ʔ

For the most part, symbols are standard. There are a few exceptions, however. The symbols normally reserved for voiced obstruents (b, d, g, etc.) here make reference to voiceless unaspirated obstruents (what Newman calls *intermediates*, see Newman 1944, p. 14). The symbol z represents a voiceless unaspirated affricate, not a voiced continuant. A subscripted dot, C, indicates alveolar articulation.

Notice that in Yawelmani, voicing is entirely redundant: There are no voiced obstruents and no voiceless sonorants. Consequently, the feature [voice] is not necessary in underlying representation in Yawelmani.

The distinctive feature matrices assumed here for the thirty consonants in (2.113) are given below in (2.114).²¹

(2.114)

	b	p	p'	m	m'	d	t	t'	s	n	n'	z	c	c'	t̥	t̥'	ʃ	g	k	k'	x	w	w'	l	l'	y	y'	h	?
son	-	-	-	+	+	-	-	-	-	+	+	-	-	-	-	-	-	-	-	-	-	+	+	+	+	+	+	+	+
cont	-	-	-	-	-	-	-	-	+	-	-	v	v	v	-	-	-	+	-	-	-	+	+	+	-	-	+	+	-
strid	-	-	-	-	-	-	-	-	+	-	-	v	v	v	-	-	-	+	-	-	-	+	-	-	-	-	-	-	-
ant	+	+	+	+	+	+	+	+	+	+	+	+	+	+	-	-	-	-	-	-	-	-	+	+	-	-	-	-	-
cor	-	-	-	-	-	+	+	+	+	+	+	+	+	+	+	+	+	-	-	-	-	-	-	-	+	+	+	+	-
round	+	+	+	+	+	-	-	-	-	-	-	-	-	-	-	-	-	-	-	-	-	-	+	+	-	-	-	-	-
high	-	-	-	-	-	-	-	-	-	-	-	-	-	-	-	-	-	-	+	+	+	+	+	+	-	-	+	+	-
back	-	-	-	-	-	-	-	-	-	-	-	-	-	-	-	-	-	-	+	+	+	+	+	+	-	-	-	-	-
low	-	-	-	-	-	-	-	-	-	-	-	-	-	-	-	-	-	-	-	-	-	-	-	-	-	-	-	-	-
nasal	-	-	-	+	+	-	-	-	-	+	+	-	-	-	-	-	-	-	-	-	-	-	-	-	-	-	-	-	-
lat	-	-	-	-	-	-	-	-	-	-	-	-	-	-	-	-	-	-	-	-	-	-	-	-	+	+	-	-	-
spr	-	+	-	-	-	-	+	-	-	-	-	-	+	-	-	+	-	-	+	-	-	-	-	-	-	-	-	-	+
const	-	-	+	-	+	-	-	+	-	-	+	-	-	+	-	-	+	-	-	+	-	-	+	-	+	-	+	-	+

The symbols + and - are as in SPE. The symbol v indicates that the melody unit is a contour unit, that is the melody unit bears two sequentially ordered values for the so-marked feature. The affricatives are represented as [continuant] contours (following Leben 1980):

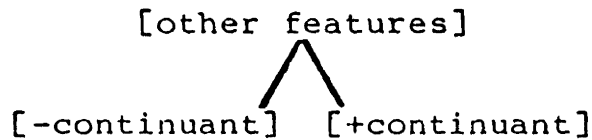

Another option is to represent the affricates as two independent melody units, e.g. /t/ and /s/, not /c/. This proposal must be rejected because the affricates pattern like single segments with respect to syllabification (See Chapter

 21. I use the label [round] with vowels because it abbreviates easily with "R", as distinct from "L", meaning [low]. However, [round] and [labial] are only one feature, and [labial] is the more accurate label since [labial] refers to the lips and so can include any kind of lip gesture. Thus, in the discussion of consonants, I use the feature [labial]. See Walli 1984 for more discussion of this feature.

2.5 -- Yawelmani Consonants

3, section 2) and linking to skeletal slots (see Chapter 3, section 2.1.2). Furthermore, in the sequence account, there is no explanation for the distribution of /z/ and /s/, which occur only in the "sequences" and nowhere else.

2.5.1 Sonorants

Consider the sonorants first, /m, m', n, n', l, l', w, w', y, y', ʔ, h/. The nasals and laterals are [+sonorant], but redundantly so since [+nasal] and [+lateral] are always [+sonorant]. This is expressed in the following universal default rules.

(2.115)

[] --> [+sonorant] / [____, +nasal]

[] --> [+sonorant] / [____, +lateral]

It remains to examine /h, ʔ, w, w', y, y'/. The alphabet for these sounds is motivated by the phonological process of Glottal Infection (2.116), fully discussed in Chapter 4 section 3.3.2, a process by which a glottal feature "[+G]" docks on a skeletal slot which is also linked to a [+sonorant] segment, thereby glottalizing the sonorant.²²

(2.116) (=4.135)

Glottal Infection

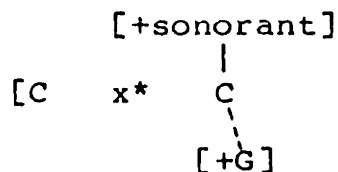

Note that in Yawelmani, /ʔ/ patterns with the sonorants. This contrasts with the assumption in Kean (1975) that /ʔ/ is [-sonorant]. Although /h/ patterns with the obstruents, I

22. See Chapter 3, section 2 on the "Cx" notation.

2.5 -- Yawelmani Consonants

assume that it is also a sonorant. This necessitates principles of Feature Conflict Resolution, discussed with (2.123) below.

[+G] sometimes docks on an empty skeletal slot, and surfaces in these cases as a glottal stop, [ʔ]. Since [+G] surfaces as [ʔ] if it links to an empty skeletal position, we assume that [+G] is identical to the underlying representation of a glottal stop. The features of a glottal stop are seen in (2.114) above (the rightmost column). The specification [+constricted] distinguishes the glottal stop and glottalized sounds from the "plain" sounds, so [+constricted] may be used to defined /ʔ/ in underlying representation. Also, since it docks on [+sonorant] consonants, [+sonorant] is also specified in underlying representation. This way, [-sonorant] is supplied (by redundancy rule) only very late, since it is never mentioned in any phonological rules. The underlying representation and complement rules for /ʔ/ are given below.

(2.117)

	?	
constricted	+	[] --> [-constricted]
sonorant	+	[] --> [-sonorant]

Since /y/ and /w/ each "absorb" the glottal feature without changing place of articulation, it follows that each must have some feature distinct from those for /ʔ/, given in (2.117), in underlying representation. Otherwise, if one of these sonorants is specified simply as [+sonorant], and [+constricted] is added by Glottal Infection (2.116), the underlying sonorant surfaces incorrectly as [ʔ], not as a glottalized sonorant with the original articulation.

Values for [coronal], [high], and [continuant] differ for /y/ and /ʔ/. Because of the vowel system, [+high] is not available as a specification for /y/, and [continuant] does not determine place of articulation. The feature [coronal]

2.5 -- Yawelmani Consonants

remains, creating the alphabet below:

(2.118)

coronal	y	+	[] -->	[-coronal]	
sonorant		+	[] -->	[-sonorant]	(2.117)

Anticipating the results of considering the rest of the consonants, we specify /w/ as [+anterior]:

(2.119)

	y	w	a. [] -->	[-coronal]	(2.118)
coronal		+	b. [] -->	[-anterior]	(2.117)
anterior		+	c. [] -->	[-sonorant]	(2.118)
sonorant		+			

Notice that (2.119a,b) are necessary to specify features of /?/: In considering /y,w/ we find that these rules are complement rules, automatically created as part of Alphabet Formation (2.55).

Certain other rules are needed for the glides; these may also be universal default rules. The first specifies that the [+anterior] sonorant /w/ is [+back].

(2.120)

$$[] \text{ --> } [+back] / \left[\begin{array}{c} \hline +anterior \\ +sonorant \\ -nasal \end{array} \right]$$

The second rule specifies the [+coronal] sonorant /y/ as [+high].

(2.121)

$$[] \text{ --> } [+high] / \left[\begin{array}{c} \hline +coronal \\ +sonorant \\ -nasal \end{array} \right]$$

One point of interest is the different underlying representations of the glides /y/ and /w/ when compared to the vowels /i/ and /u/. The features are not identical. This

2.5 -- Yawelmani Consonants

supports claims by Guerssel (1983) and Cairns and Feinstein (1982) that glides and high vowels may have different featural representations. In languages as diverse as Yawelmani, Berber, and Sinhalese there is motivation for non-identical representations; in a language like Spanish or Klamath, however, there is a glide/high vowel alternation which suggests that in these languages the two have the same underlying representation (on Spanish see Harris 1983; on Klamath see Kisseberth 1973b, Clements and Keyser 1983, Levin to appear).

The result of applying Glottal Infection (2.116) to /?/ is [ʔ]: The glottal stop does not change and the glottal feature does not surface elsewhere. When Glottal Infection (2.116) applies to /h/, [+G] is not absorbed by the /h/, but surfaces elsewhere if there is a vacant skeletal position. In each case, the result is not unexpected. The following figure represents the configurations after Glottal Infection has applied:

(2.122)

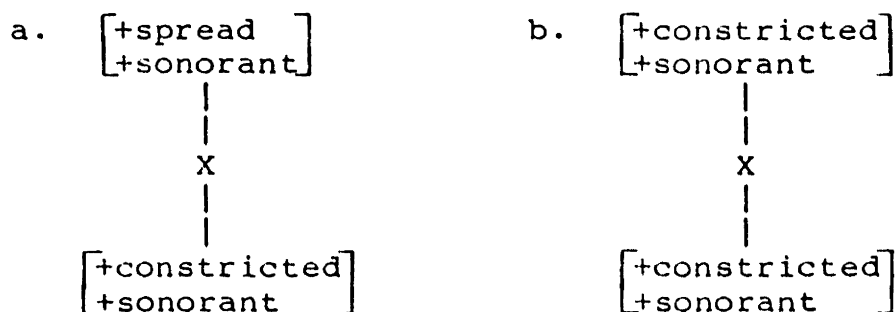

In (2.122b), "[+G]" has docked on an underlying /?/. The features on the two planes are identical. Specifying all features for the two segments, or specifying them only for the underlying segment results in no conflicting feature values: [ʔ] surfaces.

In (2.122a), where [+G] docks on /h/, a position is labeled [+spread] and [+constricted]. The two values conflict

universally (as do [+high] and [+low], or [-continuant] and [+strident]): It is impossible for the two to be represented on the same slot.²³ The rule governing docking (2.116) refers only to whether [+sonorant] is linked to the slot, and /h/ satisfies this criterion, hence the representation in (2.122a) arises. Something must be done to remove either [+constricted] or [+spread] from the skeletal slot. I call this **Feature Conflict Resolution**. If a rule associates [aF] with some slot already linked to [bG], and [aF], [bG] are universally incompatible, then one of the following principles is selected:

(2.123)

Feature Conflict Resolution

- i. dissociate [bG]
- ii. do not link [aF]
- iii. dissociate both [bG] and [aF]

In this case, (2.123ii) is relevant: Glottal Infection (2.116) does not apply, so [+constricted] does not associate to a slot already associated with [+spread], and "[+G]" links elsewhere if a slot is available. I suggest that the above three options are the only choices available in Universal Grammar for feature conflict resolution (so deleting the slot is not an option, nor is dissociating all features, etc.)

The underlying glottalized sonorants have the same representation as the derived ones, except that all features are on a single plane:

23. Different values for a given feature, or for universally conflicting features, may surface if the segment is contour. In the case of Glottal Infection, [+G] must be on a separate plane (see Chapter 4, section 3.3.2), and so this is not a contour segment. On contour segments, see Leben (1980), Steriade (1982).

2.5 -- Yawelmani Consonants

(2.124)

	ʔ	h	y	ý	w	w̥			
sonorant	+	+	+	+	+	+	[]	-->	[-sonorant] (2.119)
constricted	+			+		+	[]	-->	[-constricted]
spread		+					[]	-->	[-spread]
anterior					+	+	[]	-->	[-anterior] (2.119)
coronal			+	+			[]	-->	[-coronal] (2.119)

The same difference is observed with the other sonorants, /m,m,n,n,l,l/ when glottalized. The only alternation is the addition of [+constricted], either in underlying representation or by Glottal Infection (2.116). We turn to these sonorants and the obstruents now.

2.5.2 Obstruents, Nasals, and Laterals

There are four "place of articulation" series in the obstruents, containing stops and/or affricatives. These series are subdivided by glottal features (voiceless aspirated, voiceless unaspirated, and voiceless glottalized), and [continuant], [nasal], and [lateral]:

(2.125)

P:	b	p	p̥	m	m̥				
T:	d	t	t̥	n	n̥	s	z	c	ć
T̥:	d̥	t̥	t̥̥	l	l̥	ʃ			
K:	g	k	k̥			x			

The four categories, P, T, T̥ and K, are distinguished using [anterior] and [coronal]:

(2.126)

	P	T	T̥	K		
coronal		+	+		[]	--> [-coronal] (2.124)
anterior	+	+			[]	--> [-anterior] (2.124)

The remaining distinctions are expressed with the features [nasal], [lateral], [continuant], [spread], and [constricted]:

2.5 -- Yawelmani Consonants

in the series containing affricatives, the two values for [continuant] must be registered in some way on each segment. This means that an empty matrix, "[]", is distinguishable from nothing at all:

(2.130)

$$x \neq \begin{array}{c} x \\ | \\ [] \end{array}$$

and the underlying representation of the affricates is precisely as in (2.128).

The feature [strident] is distinctive only on [+continuant, -sonorant] segments, otherwise sounds are [-strident]. The default rules are given below:

(2.131)

- a. [] --> [+strident] / $\left[\begin{array}{c} \text{+continuant} \\ \text{-sonorant} \end{array} \right]$
- b. [] --> [-strident]

By (2.131a), any [+continuant, -sonorant] is [+strident] by default.²⁴ All other sounds are [-strident] by default rule (2.131b). A segment specified in underlying representation as [-strident] must also be specified as [+continuant] since (i) [-strident] is the inviolable default valutstraint (2.88) and the theory of underspecification thus predicts asymmetries in spread rules. The Redundancy-Rule Orderis that in a language with only [+strident] continuants, and no [-strident]

24. Keyser and Stevens (1983) propose a phonetic basis for (2.131a,b), which they call *enhancement*. With respect to these features, continuancy is registered phonetically by means of irregular high frequency noise. Stridency increases the amount of high frequency noise. Thus, if a continuant is also strident, it is more noticeable than one which is not strident because its high frequency noise has been enhanced by stridency. See Keyser and Stevens (1983) for more detail.

2.5 -- Yawelmani Consonants

continuants, [continuant] is specified in underlying representation but no value for [strident] is specified. A language with both strident and non-strident continuants must include both [continuant] and [strident] in underlying representation, a more costly arrangement by the Feature Minimization Principle (2.28). A language with only non-strident continuants apparently has two choices, (i) list both [strident] and [continuant] in underlying representation or (ii) list only one ([continuant]), and learn a rule filling in the value of the other ([strident]). However, only the latter is possible given the theory developed here, since it contains the generalization that all continuants are [-strident]. A grammar of this sort is more costly than one with only strident continuants, however, since a rule must be learned.

2.5.3 Underlying Representations and Redundancy Rules for Consonants

Below, the underlying representations of the Yawelmani consonants are given, followed by the relevant redundancy rules introduced thus far. Those which are default rules are marked DR, those which are complement rules are marked CR, and learned rules are marked LR.

(2.132)

	b	p	p̣	m	ṃ	ɖ	t	ṭ	s	n	ṇ	z	c	c̣	ɖ̣	ɖ̣̣	ʂ	g	k	ḳ	x	w	ẉ	l	ḷ	y	ỵ	h	?						
spr		+					+						+						+											+					
const			+		+			+			+		+		+					+			+		+		+		+	+					
ant	+	+	+	+	+	+	+	+	+	+	+	+	+	+																					
cor						+	+	+	+	+	+	+	+	+	+	+	+																		
nasal				+	+					+	+																								
cont									+			v	v	v				+			+														
lat																														+	+				
son																															+	+	+	+	+

2.5 -- Yawelmani Consonants

q. [] --> [+back] / $\left[\begin{array}{l} \text{+anterior} \\ \text{+sonorant} \\ \text{-nasal} \end{array} \right]$ DR/LR? (2.120)

r. [] --> [+high] / $\left[\begin{array}{l} \text{+coronal} \\ \text{+sonorant} \\ \text{-nasal} \end{array} \right]$ DR/LR? (2.121)

What remains to be discussed are the rules inserting values for the features [high], [low], [back], and [labial]. These are the four features relevant to the Yawelmani vowel system. The problem here is that up to this point, nothing has been said about the featural differences between vowel and consonant melody units. Some distinction must be made, however, since the two must be represented on separate planes in this language (as in other languages, for example Arabic as argued in McCarthy 1979). (In Arabic, there is a clear argument that the vowel melodies form separate morphemes. Here, there is no such argument. If the vowels and consonants are separate morphemes, the vowels are all "cranberry" morphemes, that is they have no independent meaning.) The question remains, and I do not provide an answer here, whether this distinction is due to a diacritic marking or to a featural difference. The notation [+consonantal] is used here; all consonants are [+consonantal] in underlying representation. If there is no need for a distinctive feature [consonantal], then this is interpreted as a diacritic marking on the segments which link to unsyllabified slots (see chapter 3, section 2). However, if [consonantal] is a diacritic, then there is no simple natural class representation of the segments which are marked in this way.

Using [+consonantal] in the environments for the rules allows a simple representation of the default rules. Consider

2.5 -- Yawelmani Consonants

first the feature [labial]. All [+anterior, -coronal] sounds are [+labial]; otherwise all consonants are [-labial]:

(2.133) cont.

s. [] --> [+labial] / $\left[\begin{array}{c} \text{+anterior} \\ \text{-coronal} \end{array} \right]$ DR

t. [] --> [-labial] / $\left[\begin{array}{c} \text{+consonantal} \end{array} \right]$ DR

The feature [back] is distributed similarly: Among the non-sonorants all [-anterior, -coronal] units are [+back] (recall that /w,w/ are specified [+back] by 2.133q). Elsewhere consonants are [-back].

(2.133) cont.

u. [] --> [+back] / $\left[\begin{array}{c} \text{-anterior} \\ \text{-coronal} \\ \text{-sonorant} \end{array} \right]$ DR

v. [] --> [-back] / $\left[\begin{array}{c} \text{+consonantal} \end{array} \right]$ DR

The [+back] consonants are [+high]; elsewhere consonants are [-high] (except /y,y/ which are specified [+high] by 2.133r).

(2.133) cont.

w. [] --> [+high] / $\left[\begin{array}{c} \text{+consonantal} \\ \text{+back} \end{array} \right]$ DR

x. [] --> [-high] / $\left[\begin{array}{c} \text{+consonantal} \end{array} \right]$ DR

Finally, all consonants are [-low]:

(2.133) cont.

y. [] --> [-low] / $\left[\begin{array}{c} \text{+consonantal} \end{array} \right]$ DR

The rules in (2.133s-y) specify values for [high], [low], [back], and [labial]. Combined with the rules and representations in (2.133a-r) above, the surface matrices seen

2.6 -- A Comparison with Markedness Theory

in (2.114) are derived.

Finally, a principle of Feature Conflict Resolution (2.123), which is not relevant only for redundancy rules but rather for a general phonological principle, is repeated below for convenience.

(2.134) (=2.123)

Feature Conflict Resolution

- i. dissociate [bG]
- ii. do not link [aF]
- iii. dissociate both [bG] and [aF]

(2.134ii) is selected when [+constricted] is to link to [+sonorant, +spread].

2.6 A Comparison with Markedness Theory

According to the theory of underspecification developed here, Universal Grammar includes the following:

A set of default rules specifying distinctive feature values.

Alphabet Formation, an algorithm by which underlying representations and redundancy rules are generated for a given language.

The Redundancy-Rule Ordering Constraint, a constraint on the interaction of redundancy rules with phonological rules.

The Distinctness Condition, a constraint on the application of redundancy rules.

Alphabet Formation and the Redundancy-Rule Ordering Constraint are repeated below for convenience.

2.6 -- A Comparison with Markedness Theory

(2.135) (=2.55)

Alphabet Formation (Universal)

1. Given an opposition [a F] -- [-a F] in environment Q in underlying representation, one value "b" is selected as the matrix value for F in Q and the other value is specified by an automatically formed complement rule:

$$[] \text{ --> } [-b F] / Q$$

2. In the absence of language internal motivation for selecting a value "a" as the matrix value for a feature F, the value "b" is selected as the matrix value where

$$[] \text{ --> } [-b F] / Q$$

is a member of the set of default rules.

(2.136) (=2.88)

Redundancy-Rule Ordering Constraint

A redundancy rule assigning "a" to F, where "a" is "+" or "-", is automatically ordered prior to the first rule referring to [a F] in structural description.

The default rules combine with Alphabet Formation (2.135) to create underlying representations and redundancy rules for a given language. The remaining two conditions govern the interaction of the redundancy rules with the phonological rules of the language. These interactions are also governed by the Elsewhere Condition (1.21) and the Strict Cycle Condition (1.20).

This theory differs from Markedness Theory (SPE, Kean 1975) in three basic ways, noted in the preceding discussion and summarized below:

2.6 -- A Comparison with Markedness Theory

(2.137)

Underspecification Theory

Markedness Theory

The Alphabet

underlying representations
are language dependent

underlying representations
are language universal

redundancy rules are
language dependent

markedness rules are
language universal

Rule Interaction

redundancy rules are
ordered as late as possible

markedness rules apply
first thing

redundancy rules interact
with phonological rules

markedness rules do not
interact with other rules

The Entire Phonology

all phonological structure
(features, syllabification,
stress, etc.) is subsumed
under this theory

feature assignment only is
subject to markedness

The first point, The Alphabet, is that underlying representations (meaning both features represented and the values on those features) are language dependent in Underspecification Theory but are universal in Markedness Theory. In Markedness Theory, then, whatever language some segment *S* is found in, the underlying representation of that segment is determined by Universal Grammar. In Underspecification Theory, however, the underlying representation of any segment depends on the phonological rules of the language and so can vary. Since the underlying representations vary, both the features used to represent the segment and the rules filling in unspecified values on the segment vary as well. This is captured by Alphabet Formation (2.135).

2.6 -- A Comparison with Markedness Theory

The second point, Rule Interaction, is that in Underspecification Theory, the redundancy rules of a language interact with the phonological rules of that language, subject to the Redundancy-Rule Ordering Constraint (2.136) and the Distinctness Condition (2.20) (specific constraints on redundancy rules) and to the Elsewhere Condition (1.21) and the Strict Cycle Condition (1.20) (general constraints on grammar). Otherwise, redundancy rules apply as late as possible. This contrasts sharply with Markedness Theory, where the markedness rules apply immediately, prior to any phonological rules, and so there is no rule interaction.

The third point, The Entire Phonology, follows from considering underspecification to be a characteristic of all aspects of representation, as argued in Chapters 3 and 4, not simply of the distinctive features as it is in Markedness Theory. All rules supplying unspecified information to a representation are ordered as late as possible, whether they supply feature values, syllable structure, stress, etc.²⁵

25. This is consistent with the theory of Lexical Phonology and Morphology argued for in Halle and Mohanan (1983), where rules are ordered in the latest possible stratum, and contrasts with that argued for in Kiparsky (1982, etc.) where rules are ordered in the earliest stratum possible.

APPENDIX

Default Rules and the Yawelmani Vowel Alphabet

(2.138) (=50)

Universal Default Rules

[high] and [low]

a. [] --> [-high] / $\left[\begin{array}{c} \text{---} \\ +\text{low} \end{array} \right]$

b. [] --> [-low] / $\left[\begin{array}{c} \text{---} \\ +\text{high} \end{array} \right]$

c. [] --> [+low] / $\left[\begin{array}{c} \text{---} \\ -\text{high} \end{array} \right]$

d. [] --> [+high] / $\left[\begin{array}{c} \text{---} \\ -\text{low} \end{array} \right]$

[back] and [round]

e. [] --> $\left| \begin{array}{c} -\text{round} \\ +\text{back} \end{array} \right|$ / $\left[\begin{array}{c} \text{---} \\ +\text{low} \end{array} \right]$

f. [] --> [a round] / $\left[\begin{array}{c} \text{a back} \\ -\text{low} \end{array} \right]$

g. [] --> [a back] / $\left[\begin{array}{c} \text{a round} \\ -\text{low} \end{array} \right]$

Appendix -- Default Rules and
the Yawelmani Vowel Alphabet

h. [] --> [-round] / $\left[\begin{array}{c} \text{---} \\ +\text{low} \end{array} \right]$ (=2.67a)

i. [] --> [-low] / $\left[\begin{array}{c} \text{---} \\ +\text{round} \end{array} \right]$ (=2.67b)

j. [] --> [a ATR] / [__, -a low] (footnote 15)

(2.139) (=2.72)

Yawelmani Vowel Alphabet

	i	a	o	u
high	-	-		
round			+	+

(2.140) (=82)

Redundancy Rules for Yawelmani Vowels

a. [] --> [+high]

b. [] --> [-low] / $\left[\begin{array}{c} \text{---} \\ +\text{round} \\ -\text{high} \end{array} \right]$

c. [] --> [a low] / $\left[\begin{array}{c} \text{---} \\ -\text{a high} \end{array} \right]$

d. [] --> $\left| \begin{array}{c} +\text{back} \\ -\text{round} \end{array} \right|$ / $\left[\begin{array}{c} \text{---} \\ +\text{low} \end{array} \right]$

e. [] --> [-round]

f. [] --> [a back] / $\left[\begin{array}{c} \text{---} \\ -\text{low} \\ \text{a round} \end{array} \right]$

Chapter 3

PHONOLOGY

In this chapter, we examine three basic areas of the phonology of Yawelmani, vowel quality, vowel quantity, and stress. The first two areas were considered in Kuroda (1967), and are familiar to students of introductory phonology courses with discussions of rule ordering and abstractness (see for example Kenstowicz and Kisseberth's 1979 textbook). The quality rules include rounding harmony and lowering of long vowels, and the quantity rules include shortening of long vowels, epenthesis, and syncope. Stress in Yawelmani appears to be a trivial rule stressing the penultimate syllable. Deeper consideration, however, reveals interesting implications for the concept of extrametricality.

Using the underspecified matrices motivated in Chapter 2, in 3.1 we consider the autosegmental treatment of the rules of Harmony (3.49) and Lowering (3.15). Comparing data from three different dialects leads to an interesting claim about autosegmental representations. Harmony results in the target surfacing as identical in quality to the trigger. Given autosegmental representation, this could be represented with the features in a single matrix on a single plane, called **uniplanar representation**. A rule spreads the trigger matrix onto the target slot ("a" means "alpha", in other words trigger and target agree for feature [F]):

(3.1)

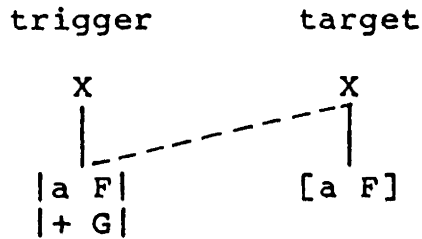

or it could be represented as spreading only some of the trigger's features. In this case, there are two options: In one, **biplanar representation**, the two features are on separate planes. A rule spreads a feature on one plane dependent on feature values on another plane.

(3.2)

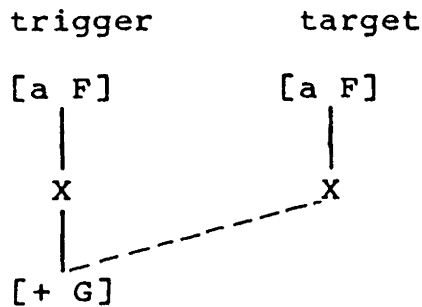

In the other, **coplanar representation**, the features are in separate matrices but on a single plane. Here, the rule spreads from feature to feature.

(3.3)

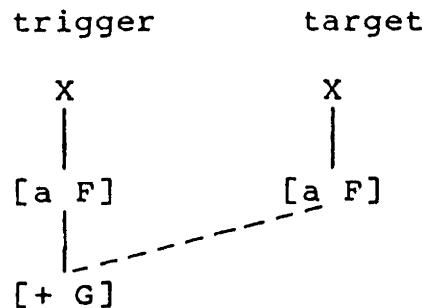

The evidence here argues for the third type, coplanar representations.

In the second section, 3.2, both the labeling of the core skeleton and the syllabification procedure in Yawelmani are examined. It is argued that taking underspecification theory seriously forces a re-evaluation of possible skeletal slot labels. I argue for a X skeleton, where X denotes a quasi-temporal unit or slot. Some Xs are dominated in underications in underlying representation. Its feature values are supplied by redundancy rules applying after various spread rules, thus accounting for the asymmetric behavior. (See Pulleyblank 1984 on Yoruba.)

Adopting a derlying syllable structure, marked

X'

Skeleta, then, are constructed from phonemically unlabeled slots (X slots), which are partially organized into syllable heads. Complete syllables are constructed on this skeleton by rules. Core syllabification rules create CV, CVC or CVV syllables, and apply whenever the structural description is met. Other, non-core rules, like epenthesis, apply across the board, non-directionally and non-iteratively. Syncope is construed as the construction of feet across the word, with foot-internal resyllabification leaving some light rimes onsetless. Onsetless syllables are then deleted.

The final section, 3.3, contains an analysis of Yawelmani stress. The stress system is relatively trivial: The penultimate syllable of the phrase is stressed. However, there are two cases of morphologically governed extrametricality which provide insight into this concept. Suggestions are made both for how extrametricality is marked on units and in what environment something marked extrametrical is not visible.

3.1 Vowel Quality

In the first part of this section, the issue of whether both autosegmental spread rules and feature copy rules are permissible is addressed. The conclusion drawn is that both types of rules are necessary but that spread rules are preferred over copy rules. We examine two dialects for evidence from the process of Lowering, by which underlying long vowels surface as [-high] regardless of surface length and regardless of underlying quality. Although the effects of this rule differ in different dialects, the analysis proposed here posits the same lowering rule for all dialects. The differences in surface forms depend specifically on whether the representations on which the lowering rule operates are derived by a spread rule (as in Gashowu) or by a copy rule (as in Yawelmani).

In the second part of this section, three different types of autosegmental representations for spread rules are examined. In the first, **uniplanar representation**, features are represented in a single matrix on a single plane:

(3.4)

$$\begin{array}{c} \left[\begin{array}{c} F \\ G \\ \vdots \end{array} \right] \\ | \\ X \end{array}$$

In the second, **biplanar representation**, features are represented in separate matrices on separate planes. There is

3.1 -- Vowel Quality

one matrix per plane in this view.¹

(3.5)

$$\begin{array}{c} [F] \\ | \\ X \\ | \\ [G] \end{array}$$

In the third, coplanar representation, features are represented in separate matrices on a single plane:

(3.6)

$$\begin{array}{c} [F] \\ | \\ [G] \\ | \\ X \end{array}$$

Evidence from the interaction of harmony and lowering in two dialects, Yawelmani and Gashowu, suggests strongly that the preferred representation is the third, the coplanar representation.

3.1.1 Spread vs. Copy

At issue here are two possible types of non-linear representations to account for a sequence of slots (at least two) surfacing as identical in quality.

(3.7)

$$C a C x \rightarrow C a C a$$

In both approaches, the underlying representation contains a single matrix. Under the first hypothesis, **Spread**, the single matrix spreads by rule to all appropriate positions:

1. I do not address the question of how many features may be represented in a single matrix.

(3.8)

Spread Hypothesis

Spread Rule:

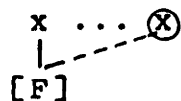

Derivation:

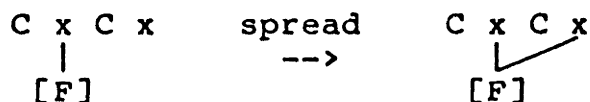

Under the second hypothesis, **Copy**, the single matrix is replicated, and then links according to the Universal Association Convention (1.5):

(3.9)

Copy Hypothesis

Copy Rule:

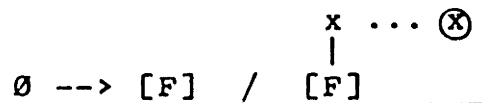

Derivation:

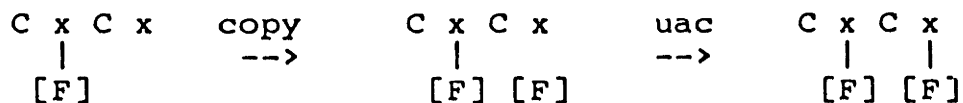

Without changing any of our assumptions about phonological rules, a copy rule like the one below



is valued the same as a rule with inserts [-a F]



or as one which inserts [b G]



where [G] and [F] are not identical. Either (i) there is no universal preference for spread rules over copy rules and the assumptions must be changed to include the following

3.1 -- Vowel Quality

statement:

(3.10)

A copy rule is preferred to an otherwise identical non-copy rule.

or (ii) the statement in (3.10) is not part of Universal Grammar and spread rules are universally preferable to copy rules to handle data like that represented in (3.7).

In examining the lowering rule in Yawelmani and in Gashowu, an argument evolves for a theory which admits both spread and copy rules. In Yawelmani, the alternations are handled readily if a copy rule is assumed whereas a spread rule results in the simplest grammar for the Gashowu alternations.

Before turning to the data, a brief discussion of verb morphology is presented here so that the issues raised by the lowering rules are more transparent. The arguments supporting this summary are presented in Chapter 4. Although this discussion relies on data from Yawelmani, the basic analysis of template insertion and verb root forms holds for all Yokuts dialects.

Regular verb roots associate to one of three templates, CxCC, CxxCC, or CxCxxC, depending on the morphology.² Regular verb roots have only one vowel matrix in the melody, and two or three consonant matrices. If a template is inserted which

2. See section 2 of this chapter for a discussion of the Cx notation. Roughly, Cs are underlyingly unsyllabified slots (X') and xs are underlyingly in a syllable head,

 | or |\
 x x x

3.1 -- Vowel Quality

has more than one 'x' slot, all xs surface with a vowel quality identical to that of the only vowel in the root melody (except in certain unusual cases, see Chapter 4, section 4.4). This is shown by the following forms:³

(3.11)

a.	?agayhin	< ?agy + CxCxxC + hn	'pulled'	134
b.	panaahin	< pan + CxCxxC + hn	'arrived'	135
c.	yawalhin	< yawl + CxCxxC + hn	'followed'	122
d.	hoyot	< hoy + CxCxxC + t	'was named'	29
e.	bowon?ey	< bown + CxCxxC + ?iiy	'a trap-O'	163
f.	yolowko	< yolw + CxCxxC + ka	'assemble!'	118

In terms of the present discussion, either a spread rule or a copy rule could account for the surface forms, resulting in the following structures:

(3.12)



A rule of Syllable Internal Spread is assumed in the copy approach.

(3.13)

Syllable Internal Spread



This accounts for the lack of diphthongs in Yokuts. Long open syllables always contain a single vowel quality. Since the melody spreads to a featureless rime slot, this rule (a

3. The symbol "O" in (3.11e) refers to Object case, one of the six cases of Yawelmani. Case is discussed in Chapter 4, section 5.1.

3.1 -- Vowel Quality

redundancy rule providing values to the second rime slot, and perhaps a universal rule, see Levin 1983) legitimately precedes Rime Formation/Shortening (3.101): Rime Formation/Shortening (3.101) syllabifies slots linked to some melody unit.

We now turn to the lowering rules.

3.1.1.1 Yawelmani Lowering

In Yawelmani, underlying long vowels surface as [-high] regardless of surface length:⁴

(3.14)

a.	deeya?	< diy + CxxCC + a?	'one in front-S'	159
b.	gewka	< giw + CxxCC + ka	'meet!'	18
c.	woowulka	< wuwl + CxxCC + ka	'stand up!'	21
d.	coomon	< cum + CxxCC + iin	'will devour'	128
e.	?edlen	< ?idl + CxxCC + iin	'will hunger'	128
f.	dooluhun	< dull + CxxCC + hn	'climbed'	122

This alternation is expressed most simply by the following rule:

(3.15)

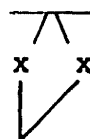
Lowering [a high] --> [-high] / 

Since this rule changes values, rather than inserting them, it is a phonological rule. This is captured by noting "[a high]" in the focus of the structural description. Lowering (3.15) states that [-high] replaces the original value for [high] on

4. S refers to subject case, one of the six cases in Yawelmani. See Chapter 4, section 5.1 on case affixes.

3.1 -- Vowel Quality

adjacent x-slots linked to the same matrix.⁵ The unsyllabified slots are circled. They are not deleted, simply they are not in a syllable and so do not surface.⁶

(3.16)

underlying representation
and Universal Association

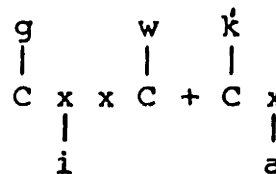

Syllabification
(see Chapter 3, section 2)

(consonants and vowels
are on separate planes)

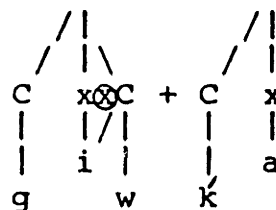

Syllable Internal Spread
(3.13)
(brackets bound syllables)

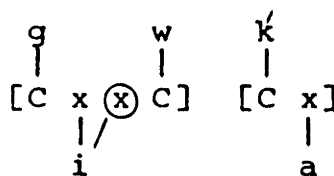

Lowering
(3.15)

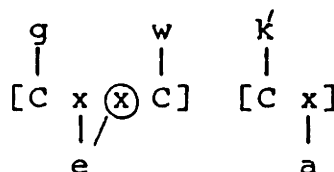

surface representation

gewka

A possible problem for Lowering as formulated in (3.15) arises

5. At this point in the derivation, geminate consonants do appear. Hence, it is necessary to specify the rime structure. True geminates are found only in certain forms with the wiy verbs, discussed in Archangeli (1984).

6. Long vowels are represented as a sequence of two slots. Long vowels shorten to a single slot if the syllable is closed by a consonant. Here, this is represented formally as leaving one of the vowel slots without syllable structure. This process is discussed in detail in section 2 of this chapter.

3.1 -- Vowel Quality

when further data are considered. In the examples below, the verb root is supplied with a CxCxC template, and only the second vowel surfaces as [-high]. (On templates, see Chapter 4.)⁷

(3.17)

a.	hiwet	< hiwt	'journey-S'	145
b.	?ileehin	< ?il + hn	'fanned'	25
c.	hideesić	< hids + (?)ć	'one who is gathering wood-S'	153
d.	şudookúć	< şudk' + (?)ć	'one who is removing-S'	25
e.	şudok?uy	< şudk' + ?iy	'that which is removed-S'	163
f.	ţuloo?uy	< ţul + ?iy	'burning-S'	25

If Spread (3.8) is assumed for the vowel matrices, immediately prior to Lowering (3.15) (3.17a) has the representation in (3.18a); if Copy (3.9) is assumed, the representation is that given in (3.18b) (where [+H] means [+high]):

(3.18)

a.	C x C x x C	b.	C x C x x C
			/
	[+H]		[+H] [+H]

Lowering (3.15) predicts the correct surface pattern (3.19b) if (3.18b) is the representation, for only the branching /i/ lowers. With the representation in (3.18a), however, and Lowering as formulated in (3.15), the incorrect (3.19a) is predicted:

(3.19)

a.	C x C x x C	b.	C x C x x C
			/
	[-H]		[+H] [-H]

If Spread (3.8) is the only option available in the theory, and Copy (3.9) is not possible, Lowering (3.15) is

7. In (3.17a,c-f), S means subject case. See Chapter 4, section 5.1 on case morphology.

3.1 -- Vowel Quality

complicated. In fact, the rule cannot be written in terms of the symbols laid out in the appendix to Chapter 1. The rule severs association lines and so rewrites much of the geometry:

(3.20)

Lowering (Spread)

$$\begin{array}{c} x \quad x \\ \diagdown \quad / \\ [a \quad H] \end{array} \quad \dashrightarrow \quad \begin{array}{c} x \quad x \\ \diagdown \quad / \\ \underline{[-H]} \end{array}$$

The structural description selects matrices linked to adjacent slots; the structural change rewrites only those adjacent slots as linked to [-high]. Notice that the rule cannot be expressed more simply. For example, the following rule (which looks for non-connections, rather than creating non-connections) erroneously does not lower the long vowels in (3.17).

(3.21)

$$[a \quad H] \dashrightarrow [-H] / \begin{array}{c} x \quad x \\ \diagdown \quad / \\ \underline{\quad} \end{array}$$

The rule in (3.21) is inadequate because in (3.17) the matrix which is linked to two adjacent slots is also linked to a non-adjacent slot, circled below.

(3.22)

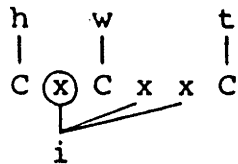

The structural description in (3.21) states that a matrix linked to two and only two adjacent slots lowers. Thus, Lowering (3.21) incorrectly does not apply to forms like that in (3.22). With Spread (3.8) the only option, the rule-writing alphabet must be expanded to allow the notation in (3.20), an undesirable result since this notation allows

3.1 -- Vowel Quality

other, more baroque rules. This notation permits simultaneous delinking of a matrix from some but not all slots to which it is associated and insertion of a matrix to replace the values just delinked.

There is an apparent problem for the Copy analysis, (3.9), illustrated in (3.23) below. In all cases, the CxCxxC template is provided to the verb stem. The affix (?) means 'one who is Ving' and the affix (a)l means 'dubitative' (i.e. 'might'). Here, [h] or [ʔ] intervenes between the short and long vowel of the root, and both vowels surface as [-high].

(3.23)

a.	leʔeeʔiç	<	liʔ	+	(ʔ)ç	'	--	sinking-S'	17
b.	woʔooyuç	<	wuʔy	+	(ʔ)ç	'	--	falling asleep-S'	17
c.	mohooʔuç	<	muh	+	(ʔ)ç	'	--	getting lean-S'	17
d.	ʔeheeʔiç	<	ʔih	+	(ʔ)ç	'	--	diving-S'	17
e.	ʔehel	<	ʔih	+	(a)l	'	--	become lean'	120
f.	neʔeewal	<	niʔw	+	(a)l	'	--	come late'	120

In the copy analysis an assimilation rule is necessary:

(3.24)

Assimilation

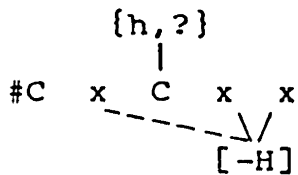

At first glance, the alternations in (3.23) might suggest that a spread analysis accounts for the data more concisely. However, formalizing the lowering rule so that it accounts for the alternations in (3.23) as well as the other data is clumsy at best:

3.1 -- Vowel Quality

(3.25)

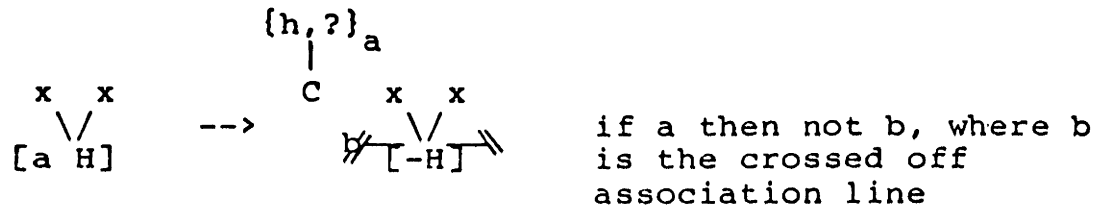

If Copy (3.9) is assumed, the simplest assimilation rule is the one in (3.24) above. In summary, then, in Yawelmani the simplest grammar uses Copy (3.9), Syllable Internal Spread (3.13), Lowering (3.15), and Assimilation (3.24).

3.1.1.2 Gashowu Lowering

Long vowels lower in Gashowu also, as the following alternations illustrate.

(3.26)

deeyilhanši	< diiyl + han + ši	'was watched'	84
leelištaš	< liil + štaa + š	'will read to s.o.'	87
hod?aš	< huud + ?aš	'know'	99
?ognaš	< ?uugn + aš	'was drinking'	99

When the verb root's template is disyllabic (i.e. CxCxxC), all root vowels are [-high].⁸ This is illustrated below.

(3.27)

deyeelaš	< diyiil + aš	'is watching'	99
tešetšaš	< tišiiitš + aš	'come out rep.'	99

If we assume a rule of Spread (3.8), the evidence in (3.27) shows that in Gashowu, [-high] replaces the value for [high] in the original matrix whenever that matrix is linked to two skeletal slots. This rule is identical to the Yawelmani rule of Lowering.

8. Dialects similar in the relevant respect are Choynimni and Chukchansi; Gashowu has been selected because the examples are (perhaps) more complete.

3.1 -- Vowel Quality

(3.28) (=3.15)
Lowering

[a high] --> [-high] /

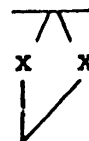

This precise formulation of Lowering is corroborated by the examples below: In these cases, the vowel matrix branches onto non-adjacent slots (assuming Spread) but Lowering does not occur. Lowering (3.28) applies only to matrices which are linked to two adjacent slots.⁹

(3.29)

ḍugug?uy	< ḍugg + CxCxC + ?uy	< ḍugg 'to point')	
		'index finger-S'	164
hut?uk'	< hutk' + CxC?xC	< hutk' 'to pull weeds')	
		'weed-pulling-S'	147

Lowering (3.28) is maximally simple in Gashowu if it is assumed that the vowel matrix spreads rather than copies. If it is assumed that the vowel matrix copies, Lowering (3.28) remains the same, but an assimilation rule must be added:

(3.30)

Assimilation (Gashowu)

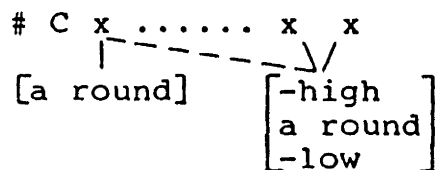

9. The templates in Gashowu are identical to those in Yawelmani (CxCC, CxxCC, and CxCxxC), with the addition of a CxCxC template and a CxC?xC template. Lowering does not occur in the latter two cases, hence we must formulate the rule so that only melodies linked to two adjacent slots lower. Furthermore, suffixes with more than one vowel of the same quality (which are of a ...xCxx... or ...xxCx... pattern) only lower the long vowel, not both. These, I suggest, are represented with two melodic segments.

3.1 -- Vowel Quality

However, this rule constitutes a complication of the grammar. The simplest account is a general spread rule, followed by Lowering (3.28), the same rule necessary in Yawelmani.

3.1.1.3 Discussion

The relevant rules for Yawelmani, assuming a copy rule, are listed below:

(3.31) (=3.9) Copy

$$\emptyset \rightarrow [F] / \begin{array}{c} x \dots x \\ | \\ [F] \end{array} \underline{\quad}$$

(3.32) (=3.13) Syllable Internal Spread

$$\begin{array}{c} | \backslash \\ x \ x \\ | \ \backslash \\ [F] \end{array}$$

(3.33) (=3.28) Lowering

$$[a \text{ high}] \rightarrow [-\text{high}] / \begin{array}{c} \wedge \\ x \ x \\ \vee \end{array}$$

(3.34) (=3.24) Assimilation

$$\begin{array}{c} \{h, ?\} \\ | \\ \#C \ x \ C \ x \ x \\ \quad \quad \quad \backslash \ / \\ \quad \quad \quad \quad \quad [-H] \end{array}$$

The grammar for Yawelmani is more complex if Spread (3.8) is assumed. Lowering (3.33) is complicated in a manner which forces a more permissive theory, and the assimilation effects are still necessary, although they can be incorporated into the Lowering rule:

3.1 -- Vowel Quality

(3.35a) (=3.8) Spread

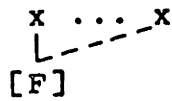

(3.35b) (=3.25) Lowering

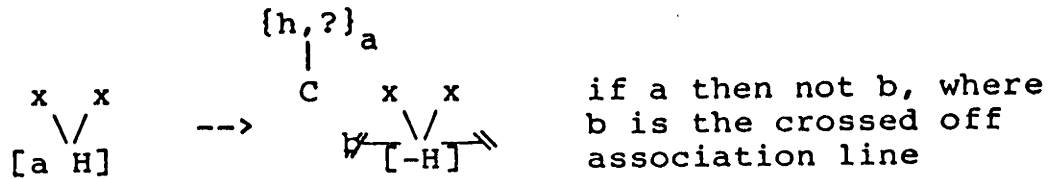

If we do not allow a more permissive theory, then the lowering rule must be written in three parts, one which copies, one which delinks, and one which lowers (recall that Spread 35 precedes Copy):

(3.36a) (=3.31) Copy

(3.36b) Delink

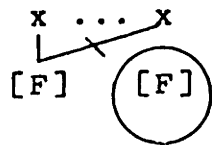

(3.36c) (= 3.33) Lowering

(3.36d) (=3.34) Assimilation

Maintaining a restrictive theory forces the copy analysis.

The relevant rules for Gashowu, assuming Spread (3.35), are listed below:

(3.37) (=3.35) Spread

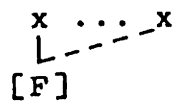

3.1 -- Vowel Quality

(3.38) (=3.33) Lowering

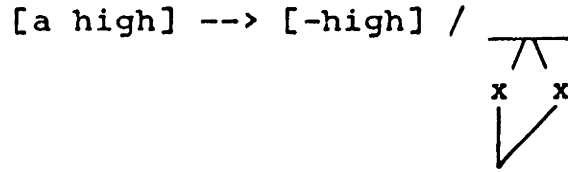

The grammar for Gashowu is more complex if a copy rule is assumed. Not only are both a copy rule and a spread rule necessary but also an assimilation rule is required to account for the forms in (3.27).

(3.39a) (=3.31) Copy

(3.39b) (=3.32) Syllable Internal Spread

(3.39c) (=3.33) Lowering

(3.39d) (=3.30) Assimilation¹⁰

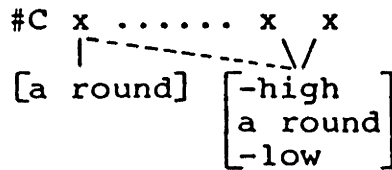

The data from these two dialects suggest strongly that both Copy (3.31) and Spread (3.37) are rules permitted by Universal Grammar, since in the case of Yawelmani a simpler grammar is available if Copy (3.31) is assumed and in the case of Gashowu a simpler grammar is available if Spread (3.37) is assumed. Without adding more power to the theory, spread rules are preferred to copy rules because spread rules capture the generalization that the target's features are identical to those of the trigger. Note that the theory of

10. The formulation of this rule predicts that if the two vowels are heteromorphic, Assimilation (3.39d) applies, just as when the two are homomorphic. Unfortunately, I have not been able to locate a test case in the relevant dialects.

3.1 -- Vowel Quality

underspecification makes certain copy rules more natural than many rules inserting a different feature or a different value since if the copied feature is present in underlying representation, no new features need be added prior to application of the copy rule. The grammars represented by (3.31) - (3.34) and (3.37) - (3.38) are assumed in the subsequent sections.

Consider now the application of Lowering (3.33) with respect to the Yawelmani Redundancy Rules (2.140). If Lowering operates on representations to which only Harmony (3.49) has applied (necessarily then 2.140a) has also applied, inserting [+high]), we predict *[a] from underlying branching /i/, not the correct [e]. Here, then, we have a case of extrinsic ordering of redundancy rules with respect to some phonological rule. The derivation below illustrates this rule interaction, where inserted values are circled.

(3.40)

a.	underlying representation		i	a	o	u
		H		-	-	
		R			+	+
b.	redundancy rule (2.140a)		i	a	o	u
		H	+	-	-	+
		R			+	+
c.	redundancy rule (2.140b)		i	a	o	u
		H	+	-	-	+
		R			+	+
		L			-	
c.	redundancy rule (2.140c)		i	a	o	u
		H	+	-	-	+
		R			+	+
		L	-	+	-	-

3.1 -- Vowel Quality

d.	Lowering (3.33)		i	a	o	u
		H	-	-	-	-
		R			+	+
		L	-	+	-	-
e.	surface		e	a	o	o

Rule (2.140c) inserts [+low] on /a/ and so precedes Lowering (3.33), as does (2.140b), which marks /o/ as [-low], since order is transitive. However, Rule (2.140c) is an "alpha" rule: It also inserts [-low] on [+high] vowels. Thus, underlying /i/ is marked [-low] and when it is assigned [-high] by Lowering (3.33), the result is [e].

Notice that Lowering (3.33) refers only to the feature [high]. By the Redundancy-Rule Ordering Constraint (2.136), redundancy rule (2.140a) must precede Lowering (3.33) since (2.140a) inserts a value for [high]. This ordering predicts an i/a alternation (as well as the u/o alternation), not the observed i/e alternation. The i/e alternation is possible only by extrinsically ordering redundancy rules (2.140b,c) before Lowering (3.33) as shown in the derivation in (3.40) above.

3.1.2 Uniplanar, Biplanar, and Coplanar Representations

The vowel harmony rule in Yokuts is apparently a straightforward example of rounding harmony (see Chapter 2, section 4.2). In this section we examine further Yokuts harmony data, both from Yawelmani and from two other dialects, Gashowa and Wikchamni, which provide subtle evidence suggesting a resolution to a recent controversy in non-linear phonology. Consider the basic Yokuts harmony, illustrated in

3.1 -- Vowel Quality

(3.41) below using verbs.¹¹ Recall that regular verb roots contain only one vowel in the melody (see Chapter 4, section 2.2). Suffixal vowels alternate between [i] and [u] (or [e] and [o] with Lowering 3.33) or between [a] and [o], depending on the vowel quality of the root and of the suffix. In (3.41), the form of the suffix hn 'aorist', which becomes [hin] by epenthesis (see Chapter 3, section 2.4.2), alternates between [hin] and [hun], the latter occurring only when the root vowel is /u/:

(3.41)			
a.	lihimhin	< lihm + hn	'ran' 137
b.	?ugunhun	< ?ugn + hn	'drank' 151
c.	ba?inhin	< ba?n + hn	'fell down' 138
d.	hoginhin	< hogn + hn	'floated' 122

In (3.42) below, the suffix (h)atn (-->[(h)atin] by epenthesis, see section 2 of this chapter) alternates between [(h)atin] and [(h)otin], the latter occurring only when the root vowel is /o/:¹²

(3.42)			
a.	bintatinxoK'	'be trying to ask!'	104
		< bint + (h)atn + xoo + ka	
b.	hudhatinxo?	'wants to know about'	114
		< hud + (h)atn + xoo + ?	
c.	ʕawhatinxoohin	'was trying to win from'	104
		< ʕaw + (h)atn + xoo + hn	
d.	doshotinxoohin	'was trying to tell'	114
		< dos + (h)atn + xoo + hn	

The process observed above is one in which a vowel rounds after a round vowel with the same value for [high]. The

11. These examples are from figure (2.78).

12. The /h/ in parentheses is floating in underlying representation, and surfaces only with biconsonantal roots as in (3.42b,c,d). It does not surface with triconsonantal roots, as in (3.42a). This alternation is discussed in detail in Chapter 4, section 3.3.1.

process is represented linearly below:¹³

(3.43)

Linear Harmony

$$V \rightarrow [+round] / \begin{bmatrix} +round \\ a \text{ high} \end{bmatrix} C_{\emptyset} \begin{bmatrix} \underline{\quad} \\ a \text{ high} \end{bmatrix}$$

Given a theory of non-linear phonology as outlined in Chapter 1, at least three different representations for the harmony rule are possible, (i) uniplanar harmony, where all features of each melody unit are in one matrix on a single plane, (ii) biplanar harmony, where features are in separate matrices on independent planes, and (iii) coplanar harmony, where features are in separate matrices on a single plane. Evidence for the coplanar or uniplanar representation over the biplanar representation is provided by examination of further harmony data from Yawelmani. Support for a coplanar or biplanar representation over a uniplanar representation is provided by the interaction of harmony and lowering in Gashowu. Since the coplanar representation handles all facts, while the biplanar and uniplanar representations handle only some of the facts, we conclude that the default formulation of harmony is in terms of a coplanar representation.

Before turning to the data, consider the formulation of the harmony rule in each type of representation. The uniplanar representation has all features in a single matrix on a single plane.

13. The linear representation is in fact a copy rule, and is included for descriptive purposes only. The similarity between structural change (" $\rightarrow [+round]$ ") and structural description (to the right of a $[+round]$ vowel) is entirely coincidental. The rule could insert $[-back]$, $[-low]$, $[+tense]$, etc. at equal cost. The intuition that it is less costly for the target to surface as $[+round]$ rather than as some other feature is not expressed in Linear Harmony (3.43).

3.1 -- Vowel Quality

(3.44)

Uniplanar Harmony

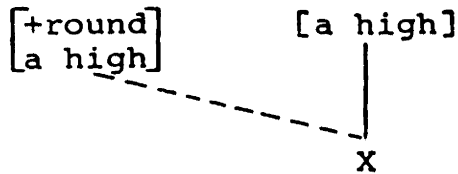

The derivation of /ʔugn + hn/ --> [ʔugunhun] follows, using Uniplanar Harmony (3.44).

(3.45)



The rule spreads the matrix of the trigger onto the slot of the target, delinking the target's features.¹⁴

(3.45) cont.

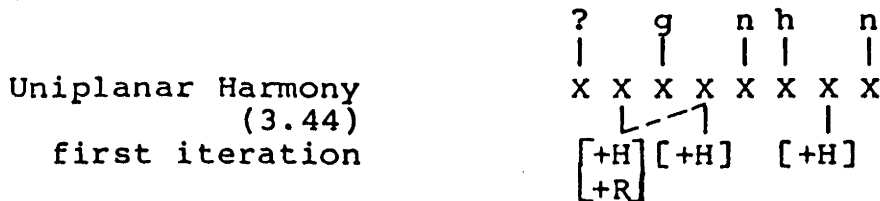

This rule must apply iteratively since all /i/s in a sequence are rounded.¹⁵

14. As noted in Chapter 1, it is assumed that delinking is automatic unless noted especially, following Pulleyblank (1983).

15. Another suggestion might be to apply this rule cyclically. However, there are morphemes with more than one /i/, for example ihnii? 'agentive', both of which round in the harmony environment, so the cyclic account fails. Furthermore, we assume that the first cycle applies after the first affixation, here the affixation of hn.

3.1 -- Vowel Quality

(3.45) cont.

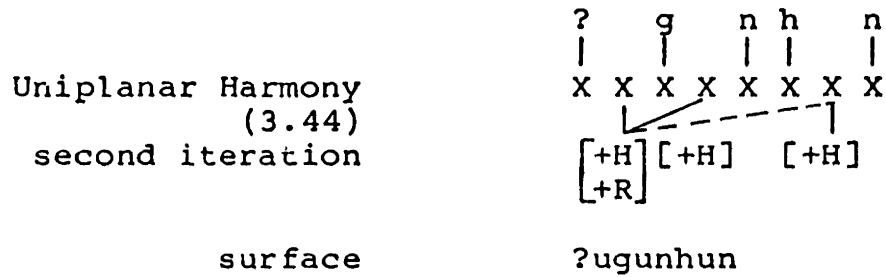

Given the assumption that features of single melody units are represented as members of single matrices in underlying representation, we might consider Uniplanar Harmony (3.44) the simplest representation. The underlying structure is unaltered. Notice, however, that if this is the correct representation of Yokuts harmony, then the case for underspecification (argued in Chapter 2) is considerably weakened. If the matrices are fully specified and are uniplanar, the following derivation of [?ugunhun] results:

(3.46)

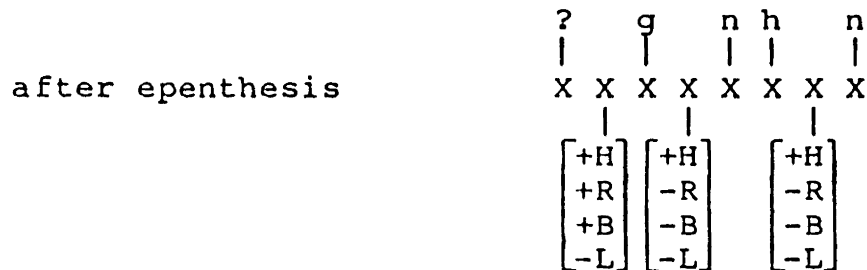

Harmony spreads the entire first matrix to the second vowel's slot:

(3.46) cont.

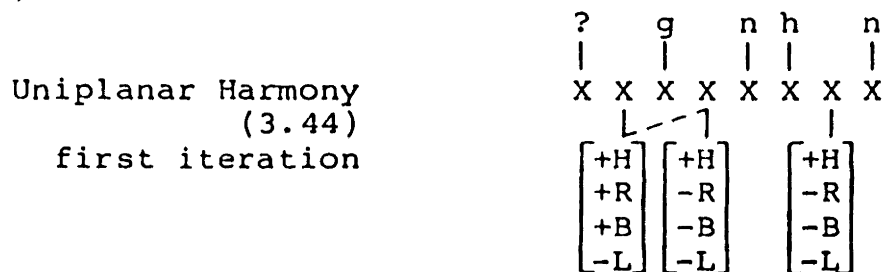

The second iteration then gives the surface form:

3.1 -- Vowel Quality

(3.46) cont.

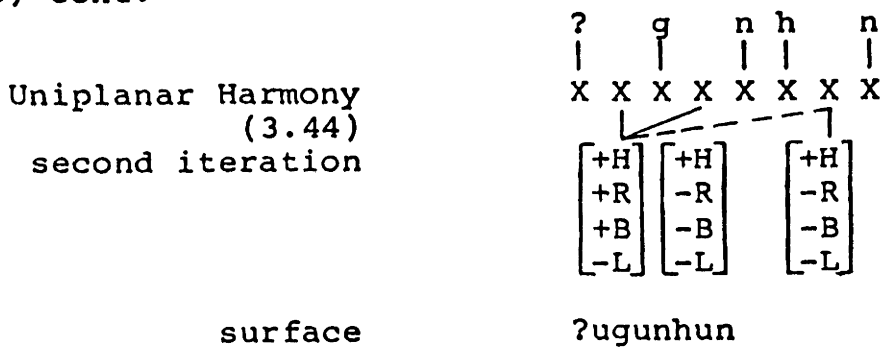

The observation that /i/ "rounds and backs" to [u] while /a/ "rounds and raises" to [o] is pointless, since all of the features of /u/, /o/ simply spread onto the slots linked to /i/, /a/ respectively. In order to maintain the strong argument for Underspecification Theory, evidence must be brought to show that Uniplanar Harmony (3.44) is not a desirable representation of the rule.

The biplanar representation does not require iterative application and does support Underspecification Theory. The feature [round] is represented on one plane, and the feature [high] on another, independent plane. Harmony is formulated below:

(3.47)

Biplanar Harmony

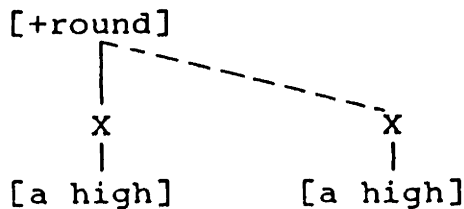

Only the feature [+round] spreads, and Underspecification Theory spells out the remaining unspecified features, thus accounting for the backing of /i/ and the raising of /a/.

The derivation of [?ugunhun], assuming biplanar harmony, is given in (3.48) below. The consonant symbols are written

3.1 -- Vowel Quality

in place of skeletal slots for ease of exposition. The consonants are to be thought of as on a separate plane from those of the two vowel features.

(3.48)



Biplanar Harmony (3.47) now applies, spreading [+round] to all [+high] vowels, and the surface form is derived:

(3.48) cont.

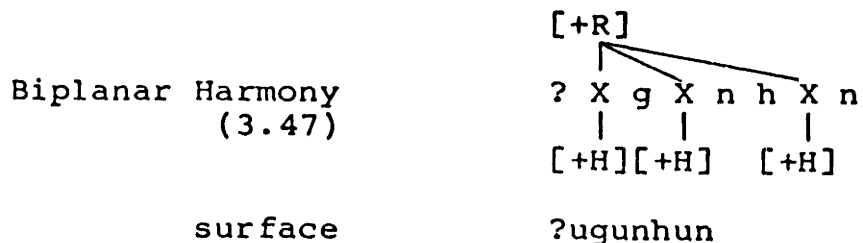

The biplanar representation is assumed in a number of analyses of vowel harmony, for example Clements and Sezer (1982) and McCarthy (1984).

Linear order of the features is maintained through the mediation of skeletal slots.

The final type, the coplanar representation, places features in distinct matrices on a single plane. Harmony is formalized below:

(3.49)

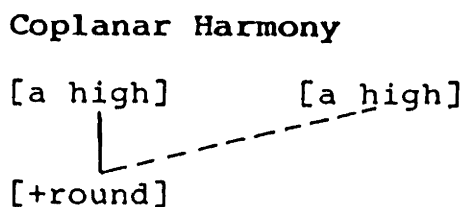

The derivation of [?ugunhun] follows, with the effects of Coplanar Harmony (3.49) shown by dashed lines:

3.1 -- Vowel Quality

(3.50)

Coplanar Harmony
(3.49)

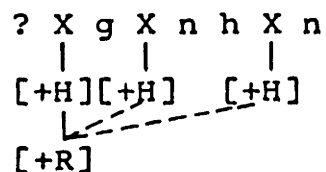

surface

?ugunhun

An interesting contrast is revealed by formally representing harmony in the simplest manner possible, given each of the three theories. A comparison of Uniplanar Harmony (3.44), Biplanar Harmony (3.47), and Coplanar Harmony (3.49) reveals that the amount of skeletal structure necessary in each rule varies depending on the type of representation assumed. Biplanar Harmony (3.47) is mediated by skeletal slots on both trigger and target for two reasons, (i) without a skeletal position for the target, it is not possible to express the structural change and (ii) without a skeletal position for the trigger it is not possible to express the underlying connection between the two features of the trigger ([+round] and [a high]). Thus Biplanar Harmony (3.47) includes skeletal slots for both the trigger and the target. Uniplanar Harmony (3.44) needs no skeletal slot for the trigger since the features are included in a single matrix. However, a skeletal slot is necessary for the target else, as with the biplanar rule, it is not possible to express the structural change. Coplanar Harmony (3.49), however, allows representation of harmony without any reference to the skeletal core. The structural change affects the relationships between features only. The trigger's features are connected on their plane, so no skeletal slot is needed to mediate the underlying connection.

The argument which results in the rejection of Biplanar Harmony (3.47) is based on the second point. In considering the Yawelmani data, we see that it is necessary to formulate

3.1 -- Vowel Quality

the harmony rule so that a floating vowel, that is a vowel not linked to a skeletal slot, can trigger harmony. This eliminates Biplanar Harmony (3.47) since there the trigger must be linked to a skeletal position.

Uniplanar Harmony (3.44) is eliminated when data from Gashowu is examined. Lowering (3.38), which crucially refers to the branchingness of [high], is seen to operate independently of the branchingness of the feature [round]:

(3.51)

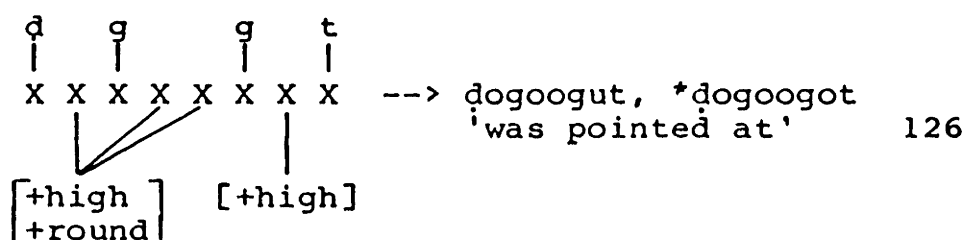

This independence is possible only if [round] and [high] appear in separate matrices, a characteristic of Coplanar Harmony (3.49) and Biplanar Harmony (3.47).

In brief, then, either the theory allows three types of representations (at least) and evidence in the language selects one or another representation, or only one of these, the coplanar representation, is allowed. The latter, being the more restrictive view, is the one proposed here.¹⁶ We now turn to the Yawelmani data, and the argument against Biplanar Harmony (3.47).

16. A further possibility is to allow all three representations, but to prefer one as the default case, needing evidence elsewhere. This mid-way proposal must adopt coplanar representations as the default case on account of the Yawelmani evidence.

3.1 -- Vowel Quality

3.1.2.1 Yawelmani Harmony

In (3.41, 3.42) above, the regular case of vowel harmony is shown. There is one other pertinent piece of data, floating vowels which may trigger harmony in certain noun paradigms.

Most, but not all, underived nouns have a single vowel quality. Polyvocalic nouns are rare, those with a [+round] final vowel are rarer still.¹⁷ The noun paradigms of interest are ones in which only the first of the underlying vowels surfaces. In these paradigms, harmony is triggered by the final root vowel, whether or not it surfaces.

In the following paradigm, the suffix (?)i'niin 'resident of' supplies a CxCC template to the noun stem. Notice the /i/ --> [u] harmony when (?)i'niin is affixed to baluw 'west':¹⁸

(3.52)

a.	?i'ki'niin	< ?ilk	'water'	'Water People-S'
b.	xom'ti'ni	< xomootii	'south'	'southerner-P'
c.	?a'l'ti'niin	< ?aalt	'salt-grass'	'Poso Creek tribe'
d.	ba'wu'nu	< baluw	'west'	'westerner-S'

(These words are all found on p. 220 in Newman 1944 except

17. The underived nouns with a [-round][+round] vowel melody are listed below:

?an'uw	'shaman'	196	ba'uunaay	'wasp'	169
baluw	'west'	153	beemamgoc'	'humming bird'	191
damuut'	'beard'	37	gawaayuu	'horse'	168
gaadoo	'cat'	168	pi'slu?	'mouse'	179
gaxoon	'box'	168	?it'woop'	'woman's	221
				brother's wife'	

18. S stands for Subject and P stands for Possessive, two of the six case markings in Yawelmani.

3.1 -- Vowel Quality

3.52a, which is on p. 219.)

A similar distribution is observed with the suffix i(y)in 'intensive possessor'. The suffix supplies a CxCC template, and surfaces with [u]s when concatenated with daamuut 'beard':¹⁹

(3.53)

- | | | | | | |
|----|----------|---|---------|-------------|-----------------------------------|
| a. | bidkiyin | < | bidk | 'excrement' | 'one who is always excreting' |
| b. | tukuyun | < | tuk | 'ear' | 'jackrabbit, one with large ears' |
| c. | tiitiyin | < | tiitiit | 'anus' | 'raccoon, one with a large anus' |
| d. | damtuun | < | daamuut | 'beard' | 'one with a heavy beard' |

(3.53a,b are found on p. 218 in Newman 1944; 3.53c,d on p. 219.)

If Coplanar Harmony (3.49) obtains, this distribution is expected:

(3.54)

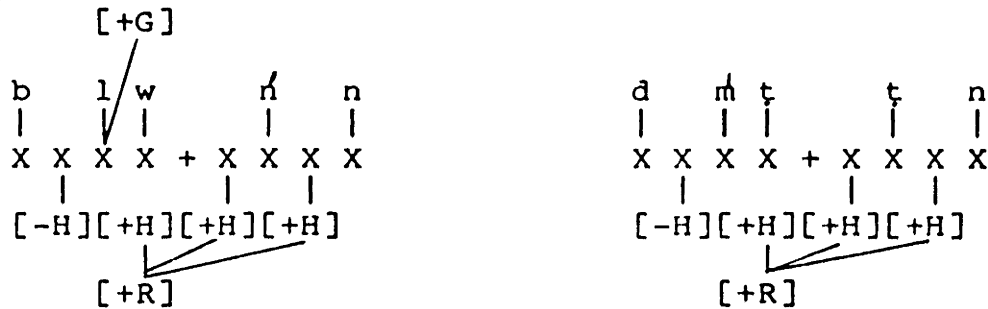

Also, if Uniplanar Harmony (3.44) obtains, this distribution is expected:

19. The appearance of the stem-final consonant in place of the /y/ of the affix is a sporadic occurrence with this suffix. See Newman 1944, p. 218-219 for discussion.

3.1 -- Vowel Quality

(3.55)

Uniplanar Harmony (3.44): First Iteration



Uniplanar Harmony (3.44): Second Iteration

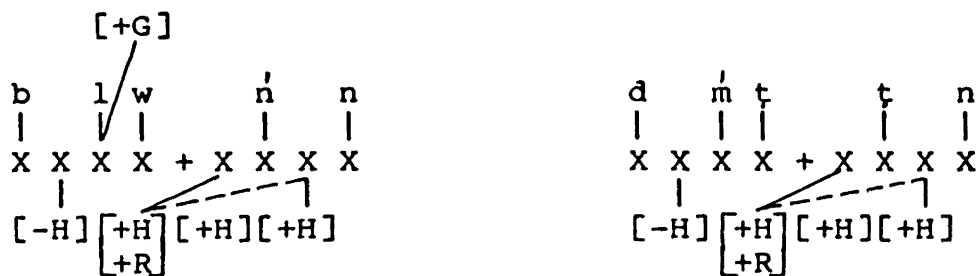

With Biplanar Harmony (3.47), this distribution is inexplicable because this rule makes crucial reference to the skeletal slots, yet in the cases in (3.52) and (3.53), the trigger, that is the [+high, +round] matrix, is not associated with a skeletal position. There is no way to indicate that the [+round] "belongs to" the second [high] matrix.

(3.56)

Biplanar Harmony (3.47)



Means of salvaging the biplanar rule exist but constitute powerful revisions of the theory. For example, one might propose connections between features on separate planes. In this approach, the floating [+high] and [+round] are linked to each other independently of the skeleton. This is done only

at cost, however, for it permits loss of linear ordering: The floating [+high] is ordered with respect to all other segments in the word except the second and third consonants because it is ordered between two linked [high] matrices. The feature [+round] is not necessarily linked in this manner -- the universal association convention would link it to the first slot, for example.

(3.57)

[+R]

b	<	X	<	l	<	w	<	X	<	n	<	X	<	n
		[-H]	<	[+H]	<	[+H]	<	[+H]	<	[+H]	<	[+H]	<	[+H]

Stipulations could be added to prevent this. The force of such stipulations are a natural result of both uniplanar and coplanar representations. Consequently, the biplanar representation is rejected.²⁰

3.1.2.2 Gashowu Harmony

The vowel harmony alternations in Gashowu are identical to those in Yawelmani.

20. There is one example in Newman 1944 where the second vowel is /o/, not /u/. In this case, when the suffix (m)aam 'deceased' is added, instead of the expected ...oom we observe ...aam:

?it'woop' --> ?it'awpaam 'deceased woman's brother's wife' 221
 *?it'owpoom

I have no ready explanation for this form. None of the representations considered here (not even the biplanar representation) predicts the surface form.

3.1 -- Vowel Quality

(3.58)

ʔiptiɲi	< ʔipt+iɲi	'will leave (it)'	129
ʔuluɲu	< ʔul+iɲi	'will burn'	129
mooʂiɲi	< mooʂ+iɲi	'will gather nuts'	129
wabaɟɲiɲi	< wabaɟɲi+iɲi	'will get angry'	129
diɲhan	< diɲ+han	'get strong!'	119
ʔuɟuʔɟúwʂaxʔoʔ	< ʔuɟuʔɟ+wʂa+xʔoʔ	'are stealing from each other rep.'	89
waɲakdávʂaxʔoʔ	< waɲaaɟ+da+wʂa+xʔoʔ	'were jerking each other repeatedly'	89
ɟoɟokdolloʂ	< ɟoɟaaɟ+da+lla+ʂ	'will cause s.o. to perforate (it) rep.'	93

The general case of harmony in Gashowu may be represented with any of the three representations seen in the preceding discussion, Uniplanar Harmony (3.44), Biplanar Harmony (3.47), or Coplanar Harmony (3.49). The interaction of Lowering (3.33) and Harmony provides insight into the uni/bi/coplanar controversy. Coplanar and Biplanar Harmony (3.49 and 3.47 respectively) predict results different from those predicted by Uniplanar Harmony (3.44). By comparing derivations assuming each hypothesis, we see that bi- and coplanar representations give exactly the right results whereas the uniplanar representation leads to complications in the formulation of Lowering (3.38) for Gashowu.

Recall Lowering (3.33, 3.38), repeated below for convenience.

(3.59)

Lowering [a high] --> [-high] /



As discussed above, the notation in the structural description indicates that the matrix is associated with at least two adjacent skeletal slots, but may be associated with more,

3.1 -- Vowel Quality

including non-adjacent slots, if the matrix has undergone Spread.

The case to test is where the harmony trigger is a high vowel linked to two adjacent x slots, which are subsequently marked [-high] by Lowering (3.38). In such words, the template contains a long vowel (...xx...), the vowel /u/ is in the melody of the (regular) verb root, and a subsequent /i/ undergoes harmony. This situation is illustrated in (3.3.60), the representation of /ɖugg + CxCxxC + t/ 'was pointed at' (Newman 1944, p. 126) (after epenthesis -- see section 2.4.2 of this chapter for a discussion of epenthesis). In (3.60a), a uniplanar representation is given, in (3.60b) a biplanar representation is given, and in (3.60c) a coplanar representation is given.

(3.60)

a. uniplanar

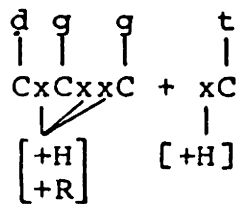

b. biplanar

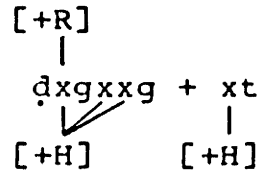

c. coplanar

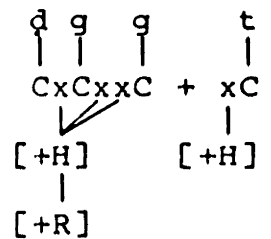

Consider the uniplanar representation (3.60a) first. By Uniplanar Harmony (3.44), the first matrix spreads onto the slot linked to the second vowel matrix, shown in (3.61a) below:

(3.61)

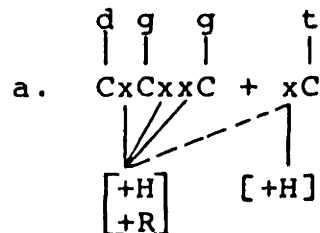

3.1 -- Vowel Quality

If, as the uniplanar representation assumes, the entire trigger matrix spreads onto the target slot, then application of Lowering (3.38) results incorrectly in [-high] vowels throughout the word, as seen in (3.61b):

(3.61) cont.

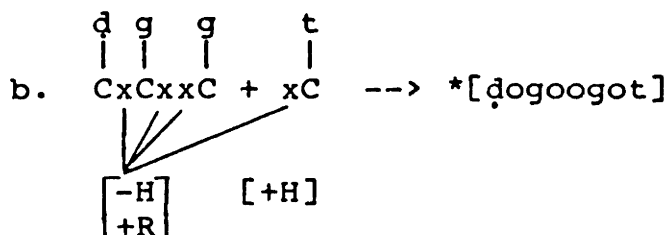

If Uniplanar Harmony (3.44) is assumed, then Lowering is inexpressible. The problem is that once the trigger matrix has spread onto the target vowels, there is no way to define the set of vowels which were originally linked to the trigger, yet it is precisely this class of vowels which is the target of Lowering. An escape might be to order Lowering before Harmony, but since Harmony is sensitive to the pre-Lowering value for [high], this option is not available. The uniplanar representation must be rejected.

Both coplanar and biplanar representations predict the correct surface form. The derivations are provided below:

(3.62)

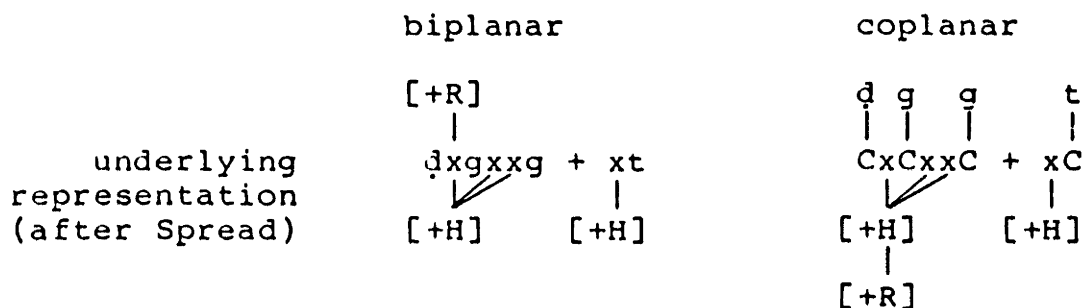

3.1 -- Vowel Quality

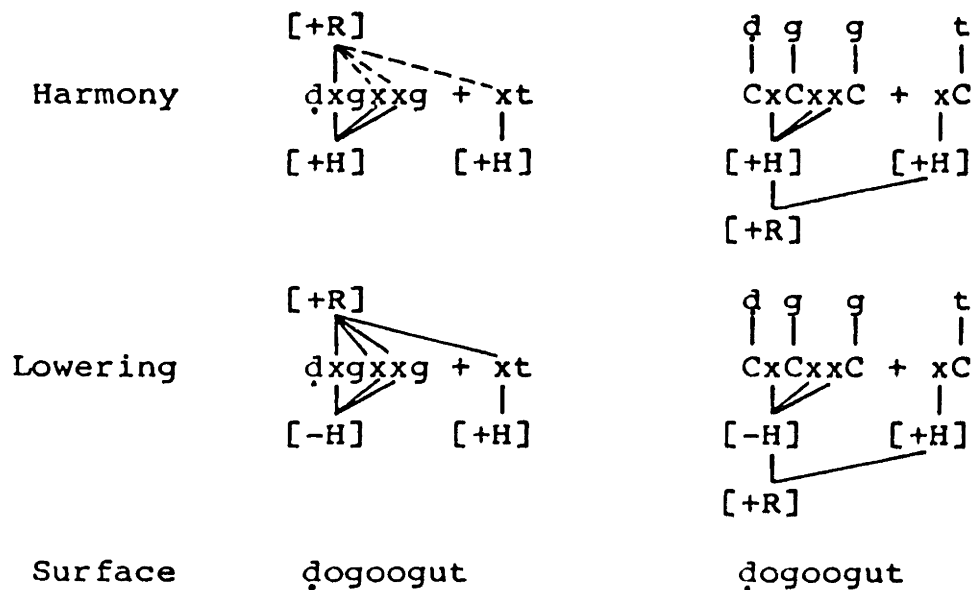

The features [round] and [high] are independent in both the biplanar and the coplanar representations. Harmony, either biplanar (3.47) or coplanar (3.49), affects all vowels since it spreads a single [round] feature to all [+high] matrices. In contrast, Lowering (3.38) affects only [+high], and so does not affect all matrices. This distinction results in the correct surface forms.

The following examples show that the distribution seen in (3.62) is, in fact, the general case.

(3.63)

ɔdookunšu?	< ɔduuk'in+šu	'came off'	85
goyoolum	< guyuulm	'young woman'	212
?oɬ?uɬmu	< ?uuɬ?ɬ+mi	'having stolen rep.'	135
?ooɬuwuš	< ?uuɬ+iwš	'stealing from e.o.-S'	150
lo?ooču	< lu?uu+č+u	'playing-O'	154

3.1.3 Implications

The main argument here is as follows: Autosegmental representations allow three general types of formulation of total assimilation rules, uniplanar, biplanar, and coplanar. The data presented here from the various Yokuts dialects

3.1 -- Vowel Quality

support the coplanar representation, where the harmonizing feature is spread from feature to feature.

The argument has two parts. First, in examining the Yawelmani data it is seen that a floating vowel can trigger harmony. This is possible only if the linear order of the floating segment can be maintained with respect to the other segments. As shown in 3.1, both uniplanar and coplanar harmony have this effect, while there is no means of maintaining the linear order in biplanar harmony. Secondly, in Gashowu the interaction between Harmony and Lowering (3.38) shows that it is necessary to maintain the independence of [high] and [round], possible with biplanar and coplanar representations, but not with uniplanar representations.

Since coplanar representations handle all data, and biplanar and uniplanar representations handle only part of the data, I suggest that coplanar representations are universally the default representations.

The data presented here argue for coplanar representations as the default case. The coplanar representation is assumed in Steriade (1982) as well, where she proposes the Shared Feature Convention and the Branching Features Constraint, discussed in 3.1.3.1 and 3.1.3.2 respectively. The evidence here argues against both as universal conditions.

In 3.1.3.3, a third dialect is considered, which argues for underlying coplanar representations, not underlying uniplanar representations.

3.1.3.1 The Shared Feature Convention

The Shared Feature Convention (Steriade 1982:48) is a

3.1 -- Vowel Quality

corollary to coplanar representations. It is a universal convention which states that if a feature [F] is linked simultaneously to two matrices any other features common to both matrices automatically "percolates" into the shared matrix containing [F].

(3.64)

Shared Feature Convention (Steriade 1982:48)

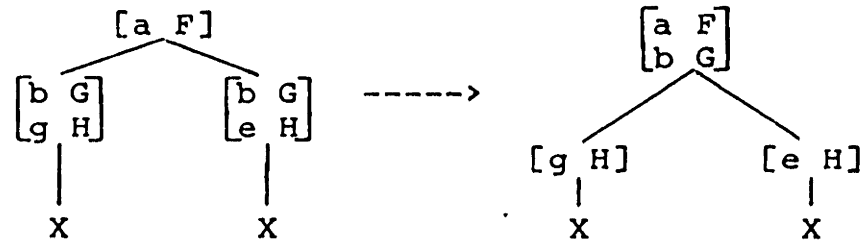

The data in Gashowu are a problem for the Shared Feature Convention (3.64). Recall the result of Coplanar Harmony (3.49) applied to Gashowu /ḍugg + CxCxxC + t/ 'was pointed at', repeated below for convenience.

(3.65)

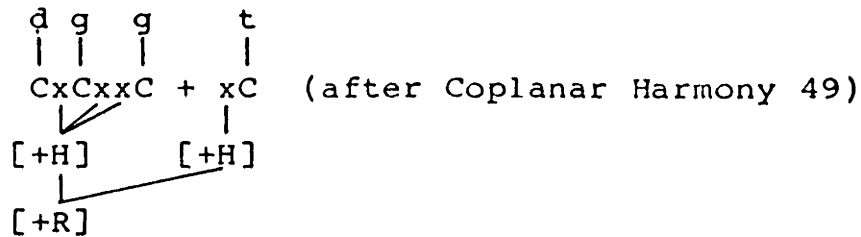

The Shared Feature Convention (3.64) causes the common features to percolate automatically into the shared matrix, giving the configuration below.

(3.65) cont.

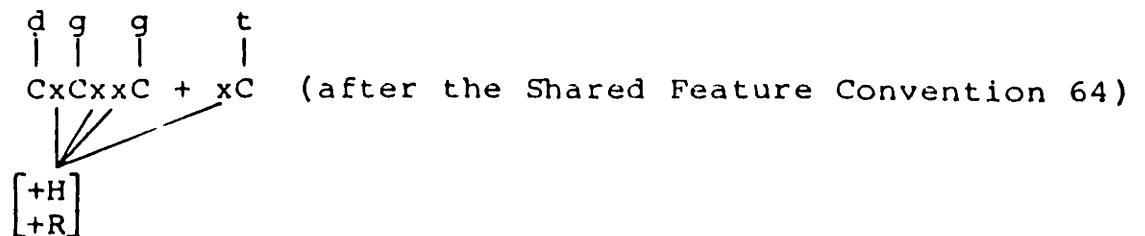

The configuration now is identical to that derived by

3.1 -- Vowel Quality

uniplanar harmony. As seen in 3.1.2, when Lowering (3.38) applies all vowels are lowered, giving the wrong result:

(3.65) cont.

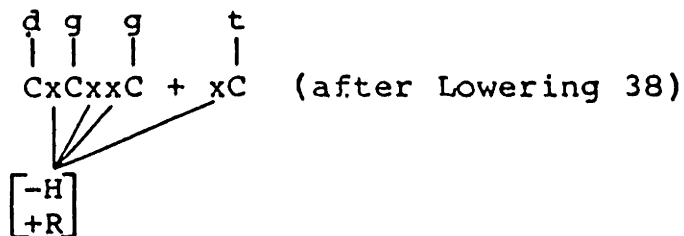

SR *ḍogoogot (ḍogoogut) 'was pointed at'

The Shared Feature Convention (3.64) cannot be maintained as a universal in the face of the Gashowu data.

3.1.3.2 The Branching Features Constraint

The Branching Features Constraint, also introduced in Steriade (1982:59-60, 67) states²¹

(3.66)

Branching Features Constraint

Any unit in the melody which is shared between several skeleton positions is inaccessible to rules whose structural descriptions are met by only part of the linked structure.

Assume the hypothetical configurations and rules below (R means "rime", i.e. a syllable head):

21. Steriade says "any rule whose structural description is not met by both of the matrices sharing [the feature]" on p. 60, 65, and "...linked structure..." on p. 67. From the discussion, which involves true geminates as well as partial geminates, it is clear that she means the entire linked structure, including both matrices and skeletal slots.

3.1 -- Vowel Quality

(3.67)

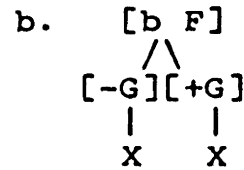
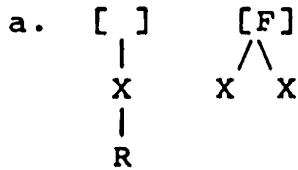

$[] \rightarrow [+cont] / \overset{R}{|} \underline{\quad}$ $[F] \rightarrow [-b F] / [\underline{\quad}, a G]$

The rules cannot apply to the configurations in (3.67) according to the Branching Features Constraint (3.66), because the structural description is not met in all slots/matrices sharing [F]. In (3.67a), the second slot is not immediately after a rime and so the rule cannot apply, by the Branching Features Constraint (3.66). In (3.67b), [b F] is linked to [-a G] as well as to [a G] and so the Branching Features Constraint (3.66) blocks application of the rule.

Consider now the case from Gashowu. Prior to Lowering (3.38), the following structure is derived by Spread (3.37) and Harmony (3.49):

(3.68)

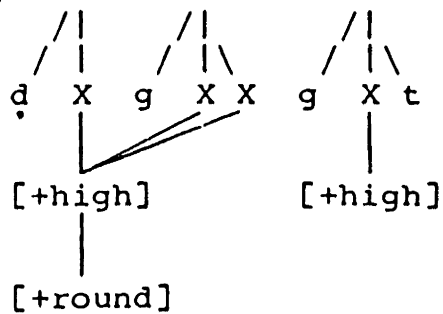

Lowering (3.38) applies to matrices linked to adjacent slots. The Branching Features Constraint (3.66) blocks application of Lowering (3.38) to both [+high] matrices in (3.68), the second because it is linked only to one slot and the first erroneously because, although it is linked to two adjacent slots it is also linked to a singular slot. The Branching Features Constraint (3.66) predicts Lowering (3.38) applying

3.1 -- Vowel Quality

in cases like the following:

(3.69)



In (3.69a), Lowering (3.38) applies to both matrices since both are linked to two adjacent slots. Furthermore, in (3.69b), Lowering (3.38) applies to the only matrix because each slot that it is linked to is adjacent to another slot that it is linked to. The prediction is that Lowering (3.38) does not apply in the following configurations:

(3.70)

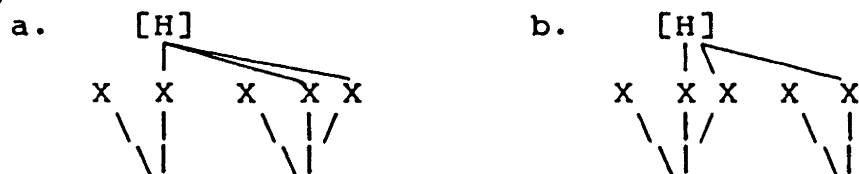

Yet the facts are that Lowering (3.38) does apply in (3.70a), which is equivalent to (3.68), [ɔ̄ogoogut].

Consequently the Branching Features Constraint (3.66) is too strong.²²

3.1.3.3 The Structure of the Melody²³

The argument for coplanar representations leads naturally to the question of whether features are coplanar or uniplanar in underlying representation. There is some

22. Perhaps the Branching Features Constraint (3.66) should apply only to geminate structures, but this is not something I have examined in any detail.

23. The title for this section is taken from a 1983 squib by K.P. Mohanan. This section benefits from discussion with him.

3.1 -- Vowel Quality

evidence in another dialect of Yokuts, Wikchamni, (Newman 1944 and Gamble 1978) which suggests matrices are coplanar, not uniplanar, in underlying representation.

Wikchamni differs from Yawelmani in that it also has a high front round vowel /ü/. The theory of underspecification argued for in Chapter 2 gives rise to the following underlying representations and complement rules, by Alphabet Formation (2.135).

(3.71)

	i	ü	u	a	o	
high				-	-	[] --> [+high]
round	+	+			+	[] --> [-round]
back		-				[] --> [-round] / [____, -back]
						[] --> [+back] / [____, +round]

Certain default rules are used here as well, and a rule may have to be learned about /o/ (see the discussion of 2.67). These rules are intrinsically ordered as follows:²⁴

(3.72)

- a. [] --> [+high] CR
- (Harmony)
- b. [] --> [-low] / [____, +round] DR/LR?
- c. [] --> [-a low] / [____, a high] DR
- d. [] --> [+back, -round] / [____, +low] DR
- e. [] --> [-round] CR
- f. [] --> [a back] / [____, a round, -low] DR/CR

The vowel /ü/ occurs in stems and if an /i/ follows, that /i/ harmonizes to [ü]. In all other respects Wikchamni harmony is like Yawelmani harmony. The examples below are

24. As in Chapter 2, CR refers to Complement Rules, the rules formed by Alphabet Formation (2.135) as shown in (3.71). DR refers to universal Default Rules (see Chapter 2, section 2.3.1) and LR refers to rules which must be learned ("Learned Rules").

3.1 -- Vowel Quality

from Gamble (1978).²⁵

(3.73)

a.	pińši	< piń	+ ši	'stung'	G15
b.	dü?üsšü	< dŭ?s	+ ši	'made'	G15
c.	hudšu	< hud	+ ši	'knew'	G15
e.	tanši	< taan	+ ši	'went'	G15
f.	mooxidši	< mooxd	+ ši	'got old'	G60

(3.74)

a.	pičwad	< pičw	+ ad	'might catch'	G15
b.	?öökünad	< ?üük	+ in + ad	'might be seen'	G55
c.	hugyad	< hugy	+ ad	'might mix'	G15
d.	dawtad	< dawt	+ ad	'might run'	G15
e.	ťoyxod	< ťoyx	+ ad	'might doctor'	G15

Suppose that features are coplanar in underlying representation. Since vowel harmony rules tend to spread [back] and [round], but not [high] and [low], I suggest that universally the coplanar hierarchy organizes [high] and [low] closer to the skeletal core than [back] and [round]. In Wikchamni, the matrices (after [+high] is inserted by 3.72a) have the following representations when linked to skeletal slots.

(3.75)

		[-B]			
		[+R]	[+R]		[+R]
[+H]	[+H]	[+H]	[-H]		[-H]
x	x	x	x		x
/i/	/ü/	/u/	/a/		/o/

The features [back] and [round] could be represented in a single matrix rather than in two separate matrices.

25. In (3.73), the suffix ši 'aorist' is added. In (3.74), the suffix ad 'dubitative' appears. In (3.74b) we also see in 'mediopassive'.

3.1 -- Vowel Quality

(3.76)

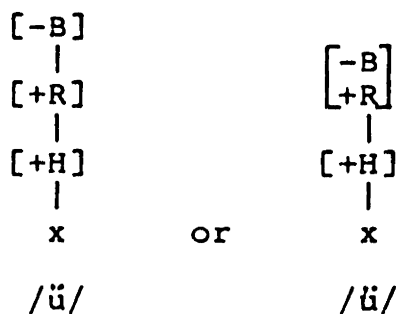

This is a question which must be explored. For attempts at grouping features, see Mohanan (1983) and Walli (to appear).

With these representations, the harmony rule for Wikchamni is Coplanar Harmony (3.49), the same rule necessary for the other Yokuts dialects. If the triggering vowel is /u/, when [+round] spreads rightwards, [-back] "goes along for the ride". The feature [-back] does not need to be represented in the rule at all.

At the first stage in the derivation below, the template is supplied to the verb root and melody units are associated via the Universal Association Convention (1.5) to the skeletal slots.

(3.77)

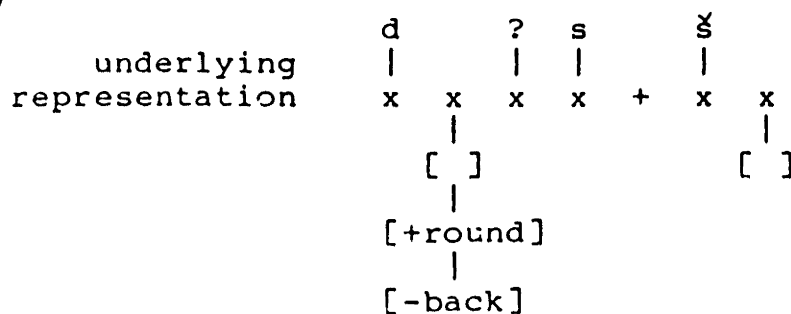

Epenthesis (3.110) inserts a skeletal slot between the two adjacent non-rime slots. (Certain points of syllabification are ignored here. See the next section, 3.2, for details.)

3.1 -- Vowel Quality

(3.77) cont.

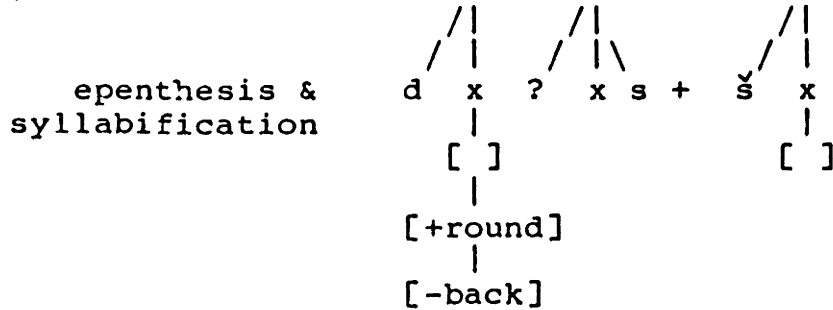

The first redundancy rule (3.72a) applies prior to Harmony, inserting [+high] on all vowels with no value for [high].

(3.77) cont.

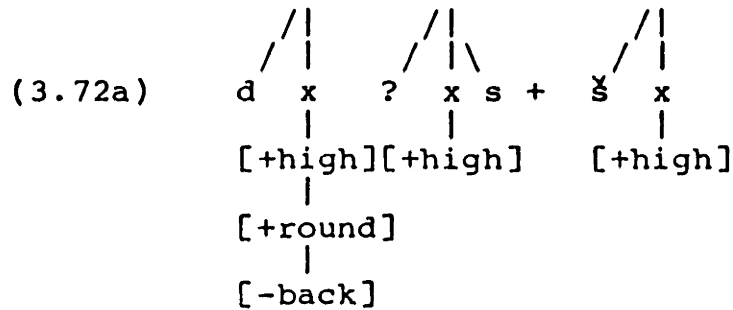

Harmony (3.49) applies, spreading [+round] from the first [+high] vowel to all successive [+high] vowels. Since [-back] is docked in [+round], all vowels end up associated with [-back] as well as with [+round], as the surface form shows.

(3.77) cont.

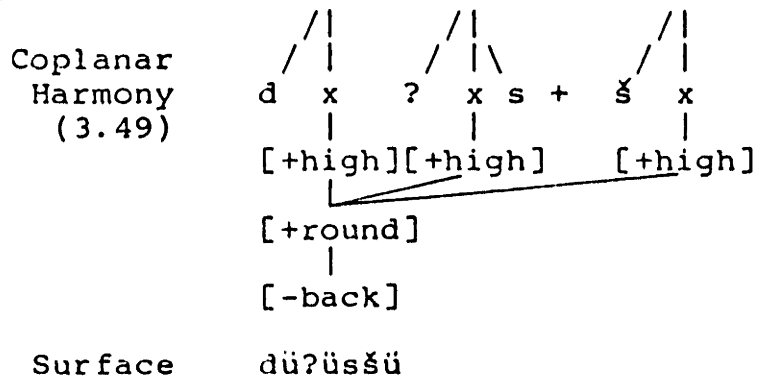

The idea that features are represented in different matrices on a single plane is appealing in two ways: First, it predicts that languages may have rules spreading

3.2 -- Syllable Structure

combinations features, but if some feature [F] spreads, then all other features further from the skeletal slot than [F] are also spread. For example, a rule spreading [high] and [back], and not spreading [round] is impossible in Wikchamni, because [round] intervenes between [high] and [back]. Secondly, assuming underlying coplanar representations means that rules altering the underlying geometry of a single unit are extremely costly.

A third point, which is also addressed in Mohanan (1983), Walli (to appear), and Kegl (in prep), is whether features are underlyingly represented in a single matrix, in a set of matrices, or in individual matrices, one for each feature. The Yokuts harmony evidence argues against the single matrix approach, at least when harmony applies. However, no arguments are brought to bear selecting between blocks of features (as argued in both Mohanan 1983 and Walli to appear) and individual matrices for each feature, provided that the individual matrices are on the same plane. This must be explored. The evidence against the biplanar representation rejects Kegl's approach as well, where each feature is on an independent plane as well as being in individual matrices.

3.2 Syllable Structure

The issue of syllable construction cannot be addressed in Yokuts without also considering the nature of underlying representations. In Chapter 4, arguments show that the pattern of consonants and vowels in verb and noun roots may be determined independently of the underlying representation of the roots themselves. The nature of this pattern, or template, is crucial to an analysis of the syllabification of

3.2 -- Syllable Structure

strings in Yawelmani, since the templates supplied to roots do not necessarily constitute well-formed syllabifications. Hence, in this section we focus both on the syllabification procedure for Yawelmani and on the representation of the core-skeleton.

In the following discussion, the symbol **V** refers to skeletal slots which are linked to the matrix for one of /i, a, o, u/, which is also linked to the slot dominated by the syllable head. The symbol **C** refers to skeletal slots linked to any of the phonemes in Yawelmani which are not linked to the slot dominated by a syllable head. Thus, **C** refers to skeletal slots linked to glides as well as to consonants.

3.2.1 Underlying Representations

McCarthy (1979a) introduces an independent "CV-skeleton", where "C" means a slot which must be [-syllabic] and "V" means one which must be [+syllabic]. Under McCarthy's assumptions, C and V indicate (i) which positions may be syllable heads and which may not be syllable heads, and (ii) where the melody units may link. Melody units, then, also bear a value for the feature [syllabic], and the values for [syllabic] of slots and of melody units must be identical. The three templates for Yawelmani, in CV notation, are

CVCC, CVVCC, CVCVVC.

Arguments for these specific patterns are given in Chapter 4; I do not repeat them here.

There are certain problems with the CV-skeleton approach. There are cases where a slot which normally

3.2 -- Syllable Structure

surfaces as V (or [+syllabic]) surfaces as C (i.e. [-syllabic]). This entails an additional mechanism or rule which changes [+syllabic] into [-syllabic]. (See Levin 1983 for discussion of these problems.) A second problem is the representation of long vowels. If [+syllabic] ("V") means 'is a syllable head', and [-syllabic] ("C") means 'is not a syllable head', then the second position of a long vowel, which is not the syllable head, should be marked "C", not "V". If it is marked "C", however, there is no template differentiation between a "CVV" syllable and a "CVC" syllable: Both are represented as "CVC" in the template. Special association rules are required to distinguish the long open syllable from the closed syllable. A third and fourth problem are theory internal. In Chapter 2, I argue for a theory of underspecification which does not allow both "+" and "-" to be specified for a given feature. In the theory of underspecification [+syllabic] and [-syllabic] are not both available for specification in underlying representations. Only one value may be specified, not the two. Rejecting both values of [syllabic] does not mean rejecting syllabicity entirely. We are, in fact, left with options -- do we reject [+syllabic] or do we reject [-syllabic]? Finally, the "feature" [syllabic] is not like distinctive features, in a very specific way. The value for [syllabic] on a given segment is correlated to the syllable structure dominating that segment. For example, /l/ is generally [-syllabic]. In the word whistling [hwislɪŋ], /l/ is in the onset of the final syllable. However, /l/ can also be [+syllabic]: In whistle [hwisl̩], /l/ forms the head of the final syllable. Syllable structure itself can record this difference, rather than using distinct feature matrices. The syllable structures of

3.2 -- Syllable Structure

whistling and whistle are represented below.²⁶

(3.78)

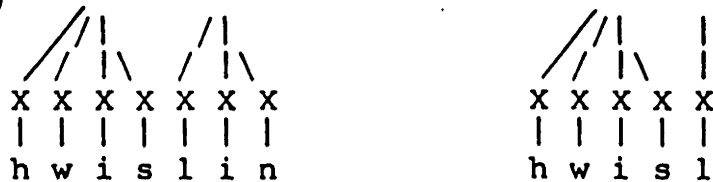

The variations in /l/ are registered solely in terms of syllable structure.

If [syllabic] is not a feature and is removed entirely from the skeleton, a sequence of unlabeled positions remains, indicated by "X" in the figure above. In a template-supplying language (like Yawelmani, or like certain Semitic languages), a sequence of unlabeled Xs is not sufficient. The three verb templates (see Chapter 4 for evidence supporting these three templates) without any indication of syllable structure are

XXXX XXXXX XXXXXX

Rules must be learned showing how melody units link to the skeletal positions. If a certain amount of labeling is added to the templates above, these are general rules, capitalizing on the Universal Association Convention (1.5), not specific rules, with different rules required for different morphemes. The question, of course, is what kind of labels are to be used.

Following work by Kaye and Lowenstamm (1981) and Levin (1983), I represent each template as a partially syllabified sequence of slots. The templates are built from the following units:

26. In 3.2.2 below, a discussion of how to interpret the syllable structure is given.

3.2 -- Syllable Structure

(3.79)

$$\begin{array}{ccc} & & | \\ & & x \\ x' & & | \backslash \\ & & x \ x \end{array}$$

The three templates, then, are

(3.80)

$$\begin{array}{ccc} & | & \\ x \ x \ x \ x & & | \backslash \\ & & x \ x \ x \ x \ x \end{array} \quad \begin{array}{ccc} & | & | \backslash \\ x \ x \ x \ x \ x \ x & & x \ x \ x \ x \ x \ x \end{array}$$

In this and subsequent discussion, for typographical convenience the following patterns are used to represent specific syllable structures:

(3.81)

$C = X'$ a slot not syllabified in underlying representation

$xx = X \ X$ two slots dominated by a single syllable head

$x = X$ a single slot dominated by a syllable head

The three templates are written as $CxCC$, $CxxCC$, and $CxCxxC$ respectively.

Furthermore, any xx must be two slots dominated by a single syllable head and can not be two slots dominated by two independent syllable heads, i.e.

(3.82)

$*| \ |$
 $X \ X$ in Yawelmani underlying representations

3.2.1.1 Underlying Syllable Structure

In this section justification is provided for exactly the three templates listed in (3.80), rather than templates with different rime structures, for example

3.2 -- Syllable Structure

(3.83)

	\	\	\ \
	*X X X X	*X X X X X	*X X X X X X
i.e.	C x C C	C x x C C	C x C x x C

"xC" is a branching rime
and "x/ x" is a non-branching rime

or

	*X X X X	*X X X X X	*X X X X X X
i.e.	C x C C	C x x C C	C x C x x C

"x" is a non-branching rime, regardless of context

The evidence comes from a template position which is normally linked to a vowel but which is linked to a consonant in certain morphological and phonological environments. In one case, the morpheme (?)ii 'causative' provides a "CxCxxC" template for the verb root. The /?/ of the affix is linked by rule to the next to last slot in the template. Another, optional, rule spreads the vowel melody onto this slot, hence the alternations below:

(3.84)

- | | | | |
|----|-------------|--------------------------------|----|
| a. | moyo?neenit | < moyn + CxCxxC + (?)ii + nt | |
| | | 'will be made tired' | 93 |
| b. | moyoonet | < moyn + CxCxxC + (?)ii + t | |
| | | 'was made tired' | 93 |
| c. | biniitihni? | < bint + CxCxxC + (?)ii + ihni | |
| | | 'one who makes X ask questions | 93 |
| d. | hubu?şom | < hubş + CxCxxC + (?)ii + mi | |
| | | 'having made X choose' | 93 |

The long vowel which results from the optional spread rule is identical in quality to the underlying vowel: Lowering (3.33) does not apply. Consequently, the spread rule must follow Lowering (3.33). The derivation is as follows (syllabification is omitted: It applies before Harmony 3.49).

3.2 -- Syllable Structure

(3.85)

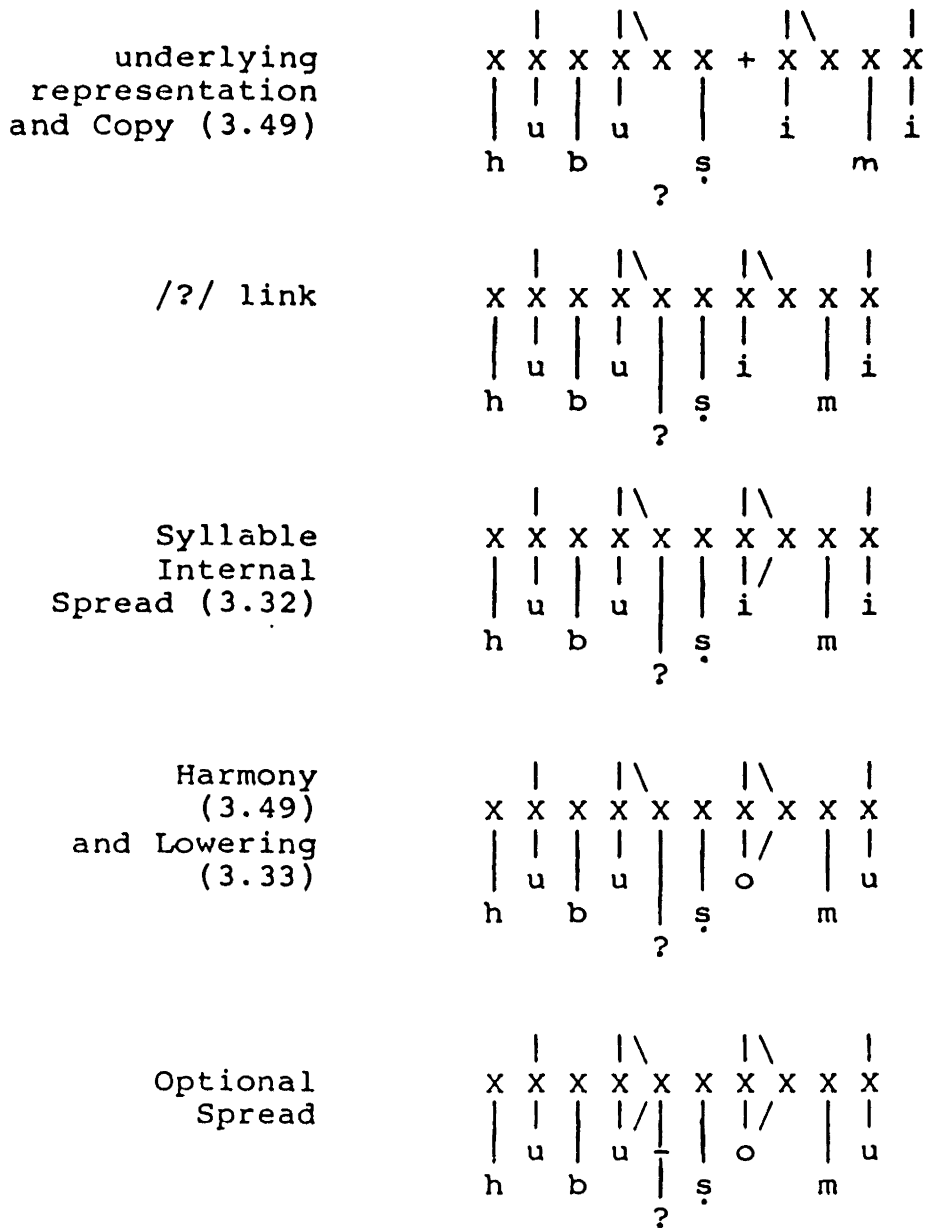

Two Surface Forms

[hubuusom] and [hubu?som]

In the example above, the domain of the underlying rime can be linked either to a vowel melody or to a consonant melody. Syllable structure is the only labeling, but this structure does not change on application of the rule linking the /?/, if we assume the underlying syllable structures in (3.80). If, however, we assume either type of syllable structure from (3.83), the position /?/ links to is the head of a syllable,

3.2 -- Syllable Structure

and a special rule must be added allowing the head to become a non-head position. Such a rule is identical to the rules which change "V" to "C", and is undesirable.

The causative paradigm given above is one of two places where this alternation between consonant and vowel positions is observed. In another case, word-final underlying long vowels never surface as long. Rather, the final syllable surfaces as closed by a glottal stop and the vowel itself surfaces with its underlying quality. Lowering (3.33) does not apply. A [-high] vowel surfaces as [-high] and a [+high] vowel surfaces as [+high]. This is shown in (3.86a,b,d,f,h).²⁷

(3.86)

a.	hoýlihni?	< hoýlii + ihni	'hunting-S'	156
b.	wastuhnu?	< wastuu + ihni	'injurer-S'	156
c.	coowihnee?in	< coow + ihni + ?in	'worker-O'	156
d.	sama?	< samaa	'mouth-S'	K55
e.	samaa?ni	< samaa + ni	'mouth-IO'	K55
f.	ti?	< tii	'house-S'	K55
g.	teenit	< tii + nit	'house-A'	K55
h.	?uplalli?	< ?uplallii	'wild dove-S'	K55
i.	?uplallew	< ?uplallii + w	'wild dove-L'	K55

However, if something follows the otherwise final long vowel, as in (3.86c,e,g,i), the underlying [+high] vowel surfaces as [-high] (via Lowering 3.33). The length of the vowel in question depends on the syllable structure of the string: In open syllables it remains long and in closed syllables it is shortened (via Rime Formation/Shortening 3.101). In both instances, an underlying vowel position is free to be linked

27. "K" refers to Kuroda (1967). S is subject case, O is object, IO is indirect object, A is ablative, and L is locative. Case is discussed in Chapter 4, section 5.1.

(3.88)

Causative Glottal Association

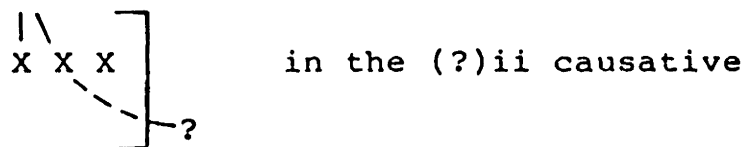

Syllable Internal Spread (3.32) is another rule which provides a melody for the underlying domain position:

(3.89) (=3.32)

Syllable Internal Spread

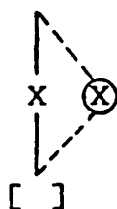

This rule crucially precedes syllabification, because after Rime Formation (3.95 below) applies, the underlying rime structure may be lost forever. Yet it is the underlying long rimes which are subject to Lowering (3.33). See the discussion of (3.103) for discussion of the ordering of these rules. We now turn to the rules of syllabification in Yawelmani. Consider two facts: First, surface syllables in Yawelmani are of the following three patterns:²⁸

(3.90)

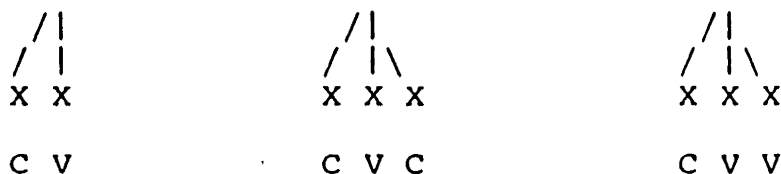

There are no vowel initial syllables on the surface. Secondly, verbs are provided with one of the following three

28. There are two well-defined exceptions, where CxxC surfaces as a syllable, see section 3.2.6 of this chapter.

3.2 -- Syllable Structure

templates (from 3.80):

(3.91)

			\			\			
	X	X	X	X	X	X	X	X	X
i.e.	C	V	C	C	C	V	C	V	C

Clearly these templates do not all correspond to well-formed syllabifications, regardless of whether the following position is a consonant or a vowel.

In order to construct well-formed syllables on strings, we must know (i) what the labeling of the slots in the skeleton is and (ii) what the rules of syllabification are. For labeling, we adopt partially syllabified templates in underlying representation. We now turn to syllabification in general, and the Yawelmani syllabification process in particular.

3.2.2 Syllable Structure

Syllables are hierarchical structures anchored (as all structure is) in the skeleton. Syllable structure constitutes yet another plane, along with the planes used by vowel melodies and consonant melodies (and tone melodies, stress trees, and so on).

The syllable assumed here consists of heads and domains. Heads are denoted by vertical lines over X slots:

|
X

and domains by angled lines over X slots. In

/ / |
/ |
X₁ X₂

| \ \
| \ \
X₂ X₃

3.2 -- Syllable Structure

X_1 , X_3 are in the domain of X_2 , which is the head in both cases. The structure X_2 - X_3 forms a constituent which may be combined with another position. The X_2 - X_3 constituent forms the head of the entire structure:

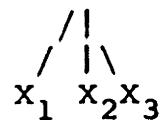

The above structure is a syllable. The syllable head, called a rime for convenience, is the embedded head and domain:



and the rime head is simply



Syllable heads and rime heads alone are also syllables: A syllable, then, consists of a head with (optional) righthand and lefthand domains.

The terms "rime" and "rime head" are convenient handles to refer to the structure above (since "syllable head's head" is awkward). The domain of a syllable head (X_1 above) is called an "onset" for the same reason. These terms do not have independent theoretical status beyond the structure given above.

A strong prediction is made here: Rules (syllabification rules or other kinds of rules) may refer to heads or to heads and domains together, but, since domains are defined solely in terms of heads, domains in isolation cannot be referred to. In examining the syllabification rules for Yawelmani, we see that these rules are expressed in terms of syllable structure only. Rules construct and delete structure. Only rarely do rules make reference to information

3.2 -- Syllable Structure

on another plane.

The syllabification rule vocabulary is given below. First the vocabulary for formulating the structural description :

(3.92)

 X	Head, with or without domain
/ X X	Head with at least one element in the lefthand domain
\ X X	Head with at least one element in the righthand domain
↙ X	Head, with no domain to the left
↘ X	Head, with no domain to the right
X'	Unsyllabified position

Structural changes are expressible in terms of the following vocabulary:

(3.93)

 ∅ --> X, X', X	Insertion Only rime heads, unsyllabified, or unlabeled positions may be inserted
--------------------	--

 X, X', X --> ∅	Deletion Only rime heads, unsyllabified, or unlabeled positions may be deleted
--------------------	--

3.2 -- Syllable Structure

- - - **Construction**
 A dashed line indicates construction of
 syllable structure

—|— **Demolition**
 A line broken indicates demolition of
 piece of syllable structure

The following rules illustrate how the vocabulary works.

(3.94)

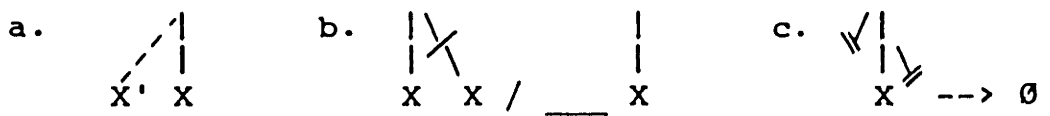

(3.94a) is a construction rule: An unsyllabified position directly to the left of a head position is adjoined as a domain element to that head position. (3.94b) is a demolition rule: A righthand domain is demolished immediately to the left of a syllable head. (3.94c) is a deletion rule; if the arrow were reversed it would be an insertion rule. A non-branching head is deleted.

3.2.3 Core Syllabification

Adapting proposals by Steriade (1982) and Levin (1983), I assume a universal rule of syllable formation.²⁹ Since the slot syllabified by Syllable Formation (3.95) may already be part of a syllable, this rule ensures that each syllable has an onset.

29. In light of the syllabification algorithm proposed in Walli (to appear), it may be too radical to call this rule a universal. Walli's algorithm must be tested with languages with more complex syllable structure.

3.2 -- Syllable Structure

(3.95)

Syllable Formation

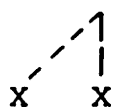

A second rule, of Rime Formation, combines with Syllable Formation (3.95) to form the Core Syllabification rules of Yawelmani. Core Syllabification rules have a special status: They apply automatically whenever possible in their lexical stratum. (See Chapter 5 on the organization of the Yawelmani lexicon.) After application of any rule at all, Core Syllabification applies. Of course, Core Syllabification has an effect only after rules which alter syllable structure. The rule of Rime Formation, given below, is a first approximation. The Yawelmani data indicate that a complication of this rule is necessary.

(3.96)

Rime Formation

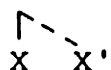

Rime Formation (3.96) is ordered after Syllable Formation (3.95). Since both rules incorporate a position adjacent to a rime into that rime's syllable, to ensure that all syllables are consonant-initial (i.e. have "onsets"), Syllable Formation (3.95) precedes Rime Formation (3.96). These two rules account satisfactorily for the syllabification of many strings, if rime heads and rimes are represented as part of the underlying templates. Consider the following forms, which have relatively straightforward syllabification: Nothing is

3.2 -- Syllable Structure

inserted nor deleted. The dot "." indicates a syllable boundary.³⁰ (The suffix iini is a resultative gerundial, meaning 'in order to V', found on p. 137 in Newman 1944. ?oglinmi is found on p. 135, taxin?as on p. 140, and gooninxaska on p. 117.)

(3.97)

xa.tee.ni	?il.kee.ni	bi.nee.tee.ni
xat + iini	?ilk + iini	biniit + iini
eat	sing	ask
'in order to eat'	'in order to sing'	'in order to ask'
?og.lin.mi	ta.xin.?as	goo.nin.xas.ka
?ogl + in + mi	tax + in + ?as	goon + in + xas + ka
emerge	come	fall
'having emerged'	'let s.o. come'	'fall right down!'

Let us take examples from the second row. Underlying syllabifications are given below. Vowel and consonant melodies are on separate planes, as indicated by the different levels.

(3.98)

								\					
x	x	x	x	x	x	x	x	x	x	x	x	x	x
								/					
?	o	g	l	i	n	m	t	a	x	i	n	?	s
								g		n	n	x	s
													ka

Syllable Formation (3.95) and Rime Formation (3.96) apply in that order. Below we see the results of Syllable Formation (3.95).

³⁰. The suffix iini 'resultative gerundial' surfaces as [eeni] by Lowering (3.33); in 'mediopassive' is followed by mi 'gerundial', ?as 'precatative gerundial', and xas 'exclusive' is followed by ka 'imperative'.

3.2 -- Syllable Structure

(3.98) cont.

$\begin{array}{cccccccc} / & & & / & & & / & \\ / & & & / & & & / & \\ \text{X} & \text{X} & \text{X} & \text{X} & \text{X} & \text{X} & \text{X} & \text{X} \\ & & & & & & & \\ & \text{o} & & & \text{i} & & & \text{i} \\ ? & \text{g} & \text{l} & & \text{n} & \text{m} & & \end{array}$	$\begin{array}{cccccccc} / & & & / & & & / & \\ / & & & / & & & / & \\ \text{X} & \text{X} & \text{X} & \text{X} & \text{X} & \text{X} & \text{X} & \text{X} \\ & & & & & & & \\ & \text{a} & & & \text{i} & & & \text{a} \\ \text{t} & & \text{x} & & \text{n} & ? & & \text{s} \end{array}$	$\begin{array}{cccccccc} / & & & / & & & / & \\ / & & \backslash & / & & \backslash & / & \\ \text{X} & \text{X} & \text{X} & \text{X} & \text{X} & \text{X} & \text{X} & \text{X} \\ & & & & & & & \\ & \text{o} & & & \text{i} & & & \text{a} \\ \text{g} & & \text{n} & & \text{n} & \text{x} & & \text{s} \end{array}$	$\begin{array}{cccccccc} / & & & / & & & / & \\ / & & \backslash & / & & \backslash & / & \\ \text{X} & \text{X} & \text{X} & \text{X} & \text{X} & \text{X} & \text{X} & \text{X} \\ & & & & & & & \\ & \text{o} & & & \text{i} & & & \text{a} \\ \text{g} & & \text{n} & & \text{n} & \text{x} & & \text{s} \end{array}$
---	---	--	--

Now Rime Formation (3.96) applies, closing the syllables wherever possible:

(3.98) cont.

$\begin{array}{cccccccc} / & & \backslash & / & & \backslash & / & \\ / & & \backslash & / & & \backslash & / & \\ \text{X} & \text{X} & \text{X} & \text{X} & \text{X} & \text{X} & \text{X} & \text{X} \\ & & & & & & & \\ & \text{o} & & & \text{i} & & & \text{i} \\ ? & \text{g} & \text{l} & & \text{n} & \text{m} & & \end{array}$	$\begin{array}{cccccccc} / & & \backslash & / & & \backslash & / & \\ / & & \backslash & / & & \backslash & / & \\ \text{X} & \text{X} & \text{X} & \text{X} & \text{X} & \text{X} & \text{X} & \text{X} \\ & & & & & & & \\ & \text{a} & & & \text{i} & & & \text{a} \\ \text{t} & & \text{x} & & \text{n} & ? & & \text{s} \end{array}$	$\begin{array}{cccccccc} / & & \backslash & / & & \backslash & / & \\ / & & \backslash & / & & \backslash & / & \\ \text{X} & \text{X} & \text{X} & \text{X} & \text{X} & \text{X} & \text{X} & \text{X} \\ & & & & & & & \\ & \text{o} & & & \text{i} & & & \text{a} \\ \text{g} & & \text{n} & & \text{n} & \text{x} & & \text{s} \end{array}$	$\begin{array}{cccccccc} / & & \backslash & / & & \backslash & / & \\ / & & \backslash & / & & \backslash & / & \\ \text{X} & \text{X} & \text{X} & \text{X} & \text{X} & \text{X} & \text{X} & \text{X} \\ & & & & & & & \\ & \text{o} & & & \text{i} & & & \text{a} \\ \text{g} & & \text{n} & & \text{n} & \text{x} & & \text{s} \end{array}$
---	---	--	--

The surface syllabification is so derived.

3.2.4 Syllabification Rules

We now turn to the particular syllabification rules for Yawelmani.

3.2.4.1 Shortening

As noted above, Rime Formation (3.96) must be reconsidered. Examine the following forms:

(3.99)

?ed.len 128	?i.lek.?an 49	mek.ka 18
?iidl + iin	?iliik + ?an	miik + ka
hunger future	sing durative	swallow imperative
'will hunger'	'is singing'	'swallow!'

The underlying syllabifications are given below:

3.2 -- Syllable Structure

(3.102)

Rime Formation/Shortening

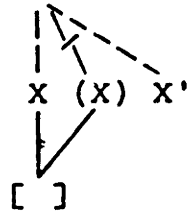

The longer expansion is Shortening (3.101) and the shorter expansion is Rime Formation (3.96). We see the desirability of collapsing the two rules in the discussion of (i)(l)saa 'causative-repetitive' in 3.2.5.1 below.

If information from the vowel melody plane is not included, then we predict the following:

(3.103)

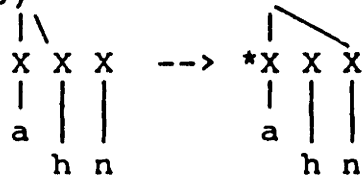

which does not happen (epenthesis, discussed below, takes place instead, and [...ahin] surfaces). Applying Rime Formation/Shortening (3.102) to the examples in (3.100) gives the following, correct, syllabifications:

(3.104) (=3.100 cont.)

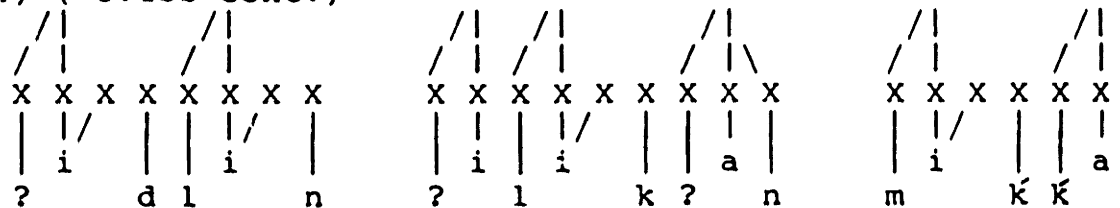

It is crucial that the extra position in the rime is not deleted. One reason is because Lowering (3.33) operates on branching vowel matrices, but the branchingness is lost if the slot is deleted. That Lowering (3.33) must follow syllabification is shown by the interaction of Epenthesis

3.2 -- Syllable Structure

(3.110 below), Harmony (3.49), and Lowering (3.33). The epenthetic vowel harmonizes with the preceding vowel, depending on the pre-Lowering value for [high]. Thus, syllabification, which produces the epenthetic vowels, must precede Harmony (3.49), which in turn must precede Lowering (3.33). Also, if a shortened syllable is subject to resyllabification, the final consonant may be resyllabified into a syllable to the right by Syllable Formation (3.95). Then Rime Formation/Shortening (3.102) reapplies and the underlying long vowel is once again syllabified. This is illustrated in the discussion of Epenthesis, immediately below.

The rules of Syllable Formation (3.95) and Rime Formation/Shortening (3.102) are together called Core Syllabification. Recall from the discussion of Syllable Formation (3.95) that these rules apply automatically whenever rules apply within their lexical stratum.

(3.105)

Core Syllabification

(3.106) (=3.95)

Syllable Formation



(3.107) (=3.102)

Rime Formation/Shortening

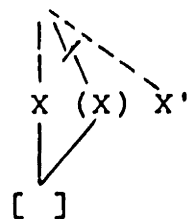

3.2 -- Syllable Structure

3.2.4.2 Epenthesis

As mentioned above, a rule of Epenthesis is necessary. Consider the following forms:

(3.108)					
?i.dil	145	ʔo.yix.ka	118	soo.nil.mi	135
?idl		ʔoyx + ka		soonl + mi	
hunger		doctor imperative		back-pack gerund	
'getting --S'		'cure!'		'having V-ed'	

In the surface forms, there are more vowels present than there are in underlying representation. Examine first the results of Core Syllabification, (3.105), on the underlying representations:

(3.109)			
X X X X	X X X X X X	X X X X X X	X X X X X X
i	o a	o i	
? d l	ʔ y x k	s n l m	

after application of Core Syllabification (3.105)

/ / \	/ / \	/ / \	/ / \
X X X X	X X X X X X	X X X X X X	X X X X X X
i	o a	o i	
? d l	ʔ y x k	s n l m	

The unsyllabified consonants are circled. Comparison of the forms in (3.109) and the surface forms in (3.108) shows that a vowel /i/ is inserted to the left of the unsyllabified consonants. From Chapter 2, we know that the quality /i/ is produced from a featureless vowel by the Redundancy Rules (2.140) for Yawelmani and so Epenthesis (3.110) simply inserts a rime head:

3.2 -- Syllable Structure

(3.111)

Epenthesis

$$\emptyset \rightarrow \overset{|}{x} / \underline{\quad} x'$$

Applying Epenthesis (3.111) to the forms in (3.109) gives:

(3.112) (=3.109 cont.)

$\begin{array}{cccc} / & / & & / \\ & & \backslash & \\ x & x & x & x \\ & & & \\ ? & i & & l \end{array}$	$\begin{array}{cccc} / & / & & / \\ & & & \\ x & x & x & x \\ & & & \\ t' & o & y & x \end{array}$	$\begin{array}{cccc} / & / & & / \\ & & & \\ x & x & x & x \\ & & & \\ s & o & n & l \end{array}$
--	--	---

Now Core Syllabification (3.105) applies automatically. First syllables are formed by (3.106):

(3.112) cont.

$\begin{array}{cccc} / & / & / & / \\ & & & \\ x & x & x & x \\ & & & \\ ? & i & & l \end{array}$	$\begin{array}{cccc} / & / & / & / \\ & & & \\ x & x & x & x \\ & & & \\ t' & o & y & x \end{array}$	$\begin{array}{cccc} / & / & / & / \\ & & & \\ x & x & x & x \\ & & & \\ s & o & n & l \end{array}$
---	--	---

Now rimes are formed, by (3.107):

(3.112) cont.

$\begin{array}{cccc} / & / & / & / \\ & & & \\ x & x & x & x \\ & & & \\ ? & i & & l \end{array}$	$\begin{array}{cccc} / & / & / & / \\ & & & \\ x & x & x & x \\ & & & \\ t' & o & y & x \end{array}$	$\begin{array}{cccc} / & / & / & / \\ & & & \\ x & x & x & x \\ & & & \\ s & o & n & l \end{array}$
---	--	---

"Onset" consonants are taken from the domain of the rime of the syllable on the left by Syllable Formation (3.106), since the slot syllabified by the rule is not necessarily unsyllabified.

The rule of Epenthesis (3.111) is motivated from very simple forms, like those above. There is another process, Syncope, which is also motivated from simple forms.

3.2 -- Syllable Structure

3.2.4.3 Syncope

Consider the following words.³¹

(3.113)					
com.la?	91	pa.nam	135	puḥ.na?	84
cuum + ilaa + ?		panaa + mi		puḥ + in + a?	
devour cause fut.		arrive gerund		full medio- noun	
				passive	
'will cause to V'		'having V-ed'		'full-blooded one'	

In these cases, the underlying representation has more vowels than the surface representation, and Rime Formation/Shortening (3.107) does not account for all the differences. Below we see the result of Core Syllabification, (3.105), applied to the underlying representations:

(3.114)			
a.		b.	
		c.	

The syllabified slots which do not surface are circled in the above examples. Notice that in all cases, the slot is dominated by a non-branching rime.

Contrast the forms in (3.114) with those below, where there is multiple application of Epenthesis (3.111).

31. Morris Halle first urged me to consider a tree-based approach to syncope. This follows in the general idea of work by Selkirk (1978), Anderson (1981), and Withgott (1982) on French "mute e", Prince (1980) on Estonian quantity, and Rappaport (1984, to appear) on Tiberian Hebrew vowel reduction. Thanks especially to Malka Rappaport for helpful discussion of this section.

3.2 -- Syllable Structure

(3.115)

- | | | | | | |
|----|--------------------|-----|----|------------------|----|
| a. | li?.ha.tin.hin | 114 | b. | ?i.lik.mix.hin | 85 |
| | li? + (h)atn + hn | | | ?ilk + mx + hn | |
| | sink desire aorist | | | sing with aorist | |
| | 'wants to sink' | | | 'sang with s.o.' | |

Consider the underlying forms after Core Syllabification, (3.105), has applied:

(3.116)

- | | | | |
|----|--|----|--|
| a. | <pre> / / / \ / \ x x x x x x x x x i i a l ? h t n h n </pre> | b. | <pre> / / / \ / \ x x x x x x x x i i ? l k m x h n </pre> |
|----|--|----|--|

Epenthesis (3.111) applies:

(3.116) cont.

- | | | | |
|----|---|----|---|
| a. | <pre> / / / \ / \ x x x x x x x x x x x i i a l ? h t n h n </pre> | b. | <pre> / / / \ / \ x x x x x x x x x x x x x x i i ? l k m x h n </pre> |
|----|---|----|---|

Core Syllabification (3.105) automatically applies, with Syllable Formation (3.106) first:

(3.116) cont.

- | | | | |
|----|--|----|--|
| a. | <pre> / / / / / / \ / \ / \ / \ / \ x x x x x x x x x x x i i a l ? h t n h n </pre> | b. | <pre> / / / / / / / / \ / \ / \ / \ / \ / \ x x x x x x x x x x x x i i ? l k m x h n </pre> |
|----|--|----|--|

Rime Formation/Shortening (3.107) now applies:

(3.116) cont.

- | | | | |
|----|--|----|--|
| a. | <pre> / / / / / / \ / \ / \ / \ / \ x x x x x x x x x x i i a l ? h t n h n </pre> | b. | <pre> / / / / / / / \ / \ / \ / \ / \ x x x x x x x x x x i i ? l k m x h n </pre> |
|----|--|----|--|

3.2 -- Syllable Structure

The vowels that eventually delete are circled in (3.116). We observe two points about the vowels that delete, (i) they are always short rimes but not all short rimes delete, and (ii) when the short rime deletes, the segment "left over" closes the syllable to the left, whether it is underlyingly a long rime (ćomla?) or a short rime (pumna?). This second observation is strengthened by the following forms, where the circled short rimes do not delete.

(3.117)

- | | | |
|----|---|--|
| a. | $\begin{array}{c} // \\ / \quad \quad \backslash \\ \text{d} \quad \text{u} \quad \text{b} \end{array} \quad ? \quad \begin{array}{c} // \\ / \quad \quad \backslash \\ \text{u} \quad \text{n} \end{array} \quad \begin{array}{c} // \\ / \quad \quad \backslash \\ \text{a} \quad \text{y} \end{array}$ | <p>< dub+CxCC+(?)ińay
'while leading by the hand' 136</p> |
| b. | $\begin{array}{c} // \\ / \quad \quad \backslash \\ \text{h} \quad \text{u} \quad \text{d} \end{array} \quad \begin{array}{c} // \\ / \quad \quad \backslash \\ \text{d} \quad \text{u} \end{array} \quad \begin{array}{c} // \\ / \quad \quad \backslash \\ \text{l} \quad \text{u} \end{array} \quad ?$ | <p>'owl-S' 218</p> |
| c. | $\begin{array}{c} // \\ / \quad \quad \backslash \\ \text{l} \quad \text{i} \quad \text{n} \end{array} \quad \begin{array}{c} // \\ / \quad \quad \backslash \\ \text{ć} \quad \text{a} \end{array} \quad \begin{array}{c} // \\ / \quad \quad \backslash \\ \text{t} \quad \text{i} \end{array} \quad \begin{array}{c} // \\ / \quad \quad \backslash \\ \text{n} \quad \text{m} \end{array} \quad \begin{array}{c} // \\ / \quad \\ \text{i} \end{array}$ | <p>< linć+CxCC+(h)atn+mi
'having tried to speak' 114</p> |

Apparently deletion applies only when the result is syllabifiable. However, adding the ability to examine the result of applying a rule prior to that rules application adds considerable power to Universal Grammar.³² A restrictive theory does not allow such power.

I propose here a tree-based syncope rule. With a tree-based approach, rules do not need to "look ahead". First the process of Syncope is presented and illustrated. Then we return to motivation for each part of Syncope (3.118).

In Syncope, Tree Construction (3.118i) proceeds

32. Both Feinstein and Lapointe (1982) and Noske (to appear) propose syllabification algorithms for Yawelmani which examine the output of syllabification prior to actually applying the rules, algorithms with exactly this "look ahead" power.

3.2 -- Syllable Structure

according to the following parameters. (Parameters for tree construction are discussed later in this chapter, section 3.3.)

(3.118)

Syncope

i. Tree Construction

- a. branching rimes must be heads³³
- b. bounded trees
- c. left dominant
- d. right to left

ii. Resyllabify heads within the tree (ignoring syllable structure of the domain)

iii. Bare Rime Deletion

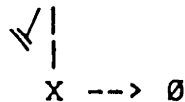

Consider the forms in (3.114a) and (3.116b): Tree Construction (3.118i) produces the following structures. (The core slots are represented by the phonemes which are linked to the positions, due to the two-dimensional page. Syllables are above the skeleton and syncope trees are below the skeleton.)

(3.119)

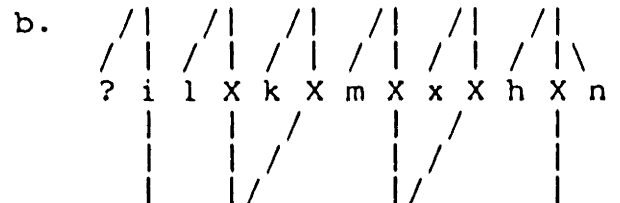
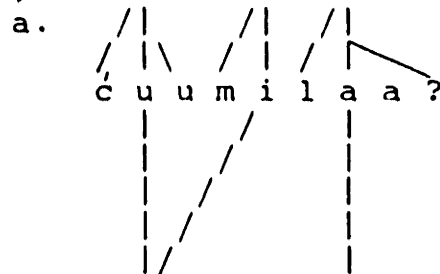

Tree-internal Head Resyllabification (3.118ii) now applies.

33. This is accomplished by a rule accenting all branching rimes. See section 3 of this chapter.

3.2 -- Syllable Structure

Consider (3.119a) first: In čuumilaa? the lefthand tree, bounding [čuu.mi] is resyllabified to [čuum.i] (where "." indicates a syllable boundary). Resyllabification (3.118ii) is not possible in the righthand tree. Now examine (3.119b): In ?ilXkXmXxXhXn, the medial trees [lX.kX] and [mX.xX] resyllabify to produce [lXk.X] and [mXx.X]. The final tree [hXn] cannot resyllabify, nor can the initial tree [?i] since there are no additional tree-internal segments to incorporate into these syllables.

(3.119) cont.

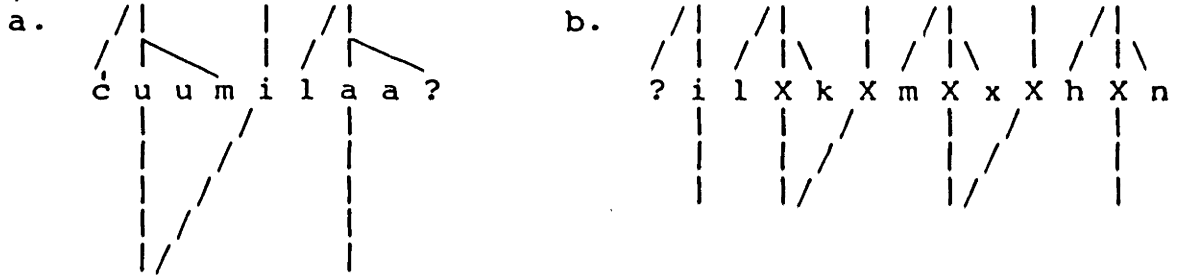

Syllables consisting solely of a rime are deleted by Bare Rime Deletion (3.118iii). When Bare Rime Deletion (3.118iii) applies to the words in (3.119), the following are derived:

(3.119) cont.

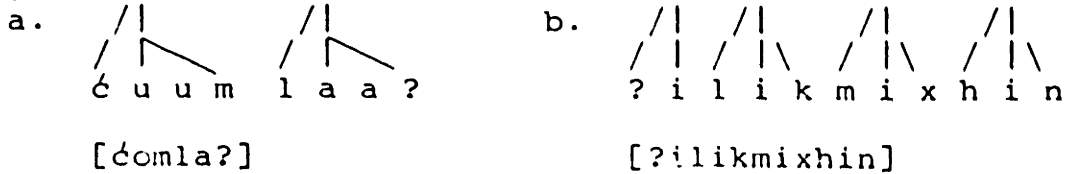

There are four interesting results of this analysis. The intuition that syncope occurs only when the result is syllabifiable is captured by Resyllabification (3.118ii), a reapplication of Core Syllabification (3.105) to the head of each tree. If Resyllabification (3.118ii) has no effect, which happens if the head syllable is closed by a consonant, then Bare Rime Deletion (3.118iii) has nothing to delete:

3.2 -- Syllable Structure

(3.120)

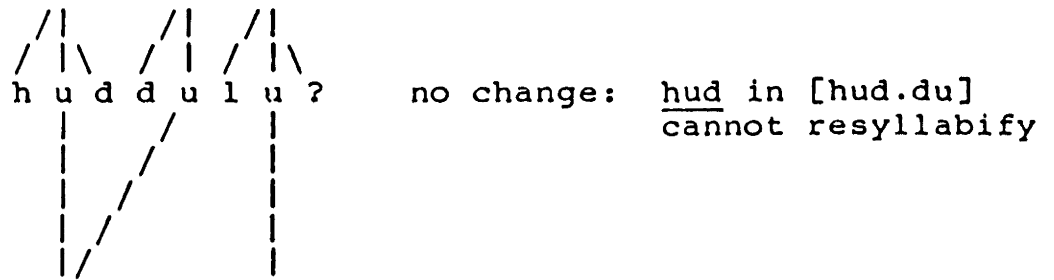

Languages with the simplest epenthesis rule (insert a rime before or after an unsyllabified slot) either (i) have strings of CV syllables on the surface or (ii) have a syncope rule and no strings of CV syllables, since Epenthesis creates CV syllables and syncope gets rid of light rimes. Exceptions to Syncope (3.118) (see section 3.2.7 of this chapter) can be characterized in terms of the underlying representations: The non-syncoating rimes are simple marked as heads of syncope trees. Non-tree-based accounts of syncope require arbitrary diacritics on these morphemes. Finally, a strong claim is made here about iterative and directional application of rules. Only tree construction has these characteristics. No other rule type may be either directional or iterative. Although it is possible to write a directional and iterative rule of epenthesis which does not over-generate epenthetic vowels (which the across-the-board account given here does), a rule of syncope is still essential, for underlying vowels which syncope, for example in /¹cuum + ilaa + ?/, /panaa + mi/, and /¹pu¹m + in + aa + ?/. Furthermore, if iterativity is a property of rules in general, then iterative rules should have a context of any length, for example tri-syllabic shortening in English (see SPE, p. 180, 241) could be iterative. If iterativity is a property of trees built on rimes (or morae), then iterative rules may refer either to adjacent syllables or to unbounded strings of syllables, but not to strings of three syllables. Thus, the proposal here predicts that there can be no rules like

3.2 -- Syllable Structure

"iterative tri-syllabic shortening".³⁴ A final point is that trees no longer are restricted to stress phenomena. In the next section (3.2) we examine stress in Yawelmani and see that the trees necessary for stress are not the same the trees necessary for syncope. Trees are merely a counting device, which can be used in stress or in syllabification, or in other types of rules.

We turn now to motivation for setting the parameters.

Trees are bounded. This is seen from sequences of epenthetic vowels: Every other vowel deletes. For example, in /?ilk + mx + hn/, if trees are unbounded as in:

(3.121)

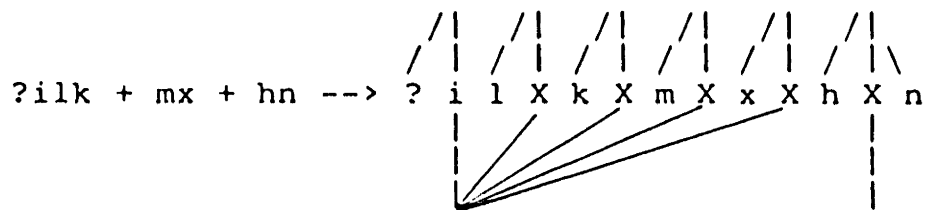

Head Resyllabification (3.118ii) must deal with the sequence [?il.X.kX.mX.xX], giving [?il.X.kX.mX.xX], and Bare Rime Deletion (3.118iii) removes only one rime: *?ilkimixihin. Bounded trees, however, correctly remove every other vowel:

(3.122)

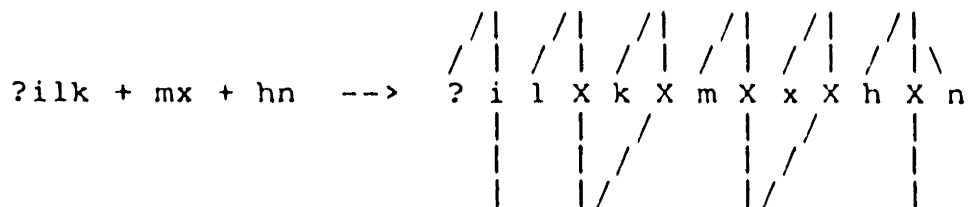

The circled X slots are deleted, giving ?ilikmixhin.

34. Thanks to Malka Rappaport for pointing out this last consequence.

3.2 -- Syllable Structure

Trees are left-dominant. The word-final syllable syncopates if possible. With right-dominant trees, the word-final syllable is always a head and so could never syncopate:

(3.123)

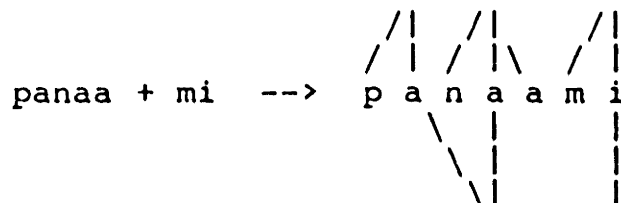

Also, the word-initial sequence [pa.naa] does not resyllabify to [pan.aa], giving *panmi or *panami after Bare Rime Deletion (3.118iii).

Trees are constructed right to left. With left-to-right construction, incorrect syncopation is predicted with epenthetic vowels (the circled vowels are incorrectly deleted):

(3.124)

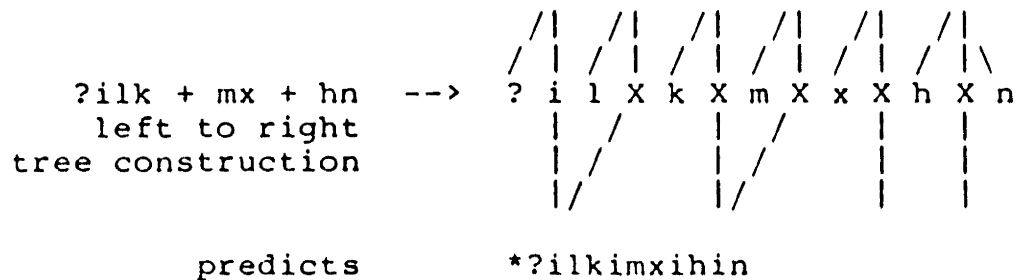

All heavy rimes are heads. We accomplish this by the device of placing an accent on heavy rimes. Certain light rimes are underlyingly accented, also, since they never syncopate. The notion "accent" is discussed briefly in the following section (3.2). If not, we predict syncopation of heavy rimes as well as light rimes (the circled rime is incorrectly deleted by Bare Rime Deletion 3.118iii):

3.2 -- Syllable Structure

(3.125)

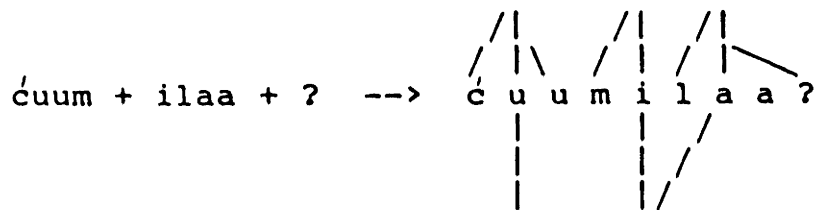

predicts $*\acute{c}oomul, * \acute{c}oomul?, \text{ or } * \acute{c}oomula?$

From the interaction of Epenthesis (3.111) and Syncope (3.118), we see that syllabification must be cyclic. The evidence is provided by the following forms.³⁵

(3.126)

a.	pa?iṭmixit	< pa?ṭ	+ mx + t	'fight'	K2Ø
b.	logiẉmixit	< logẉ	+ mx + t	'pulverize'	K2Ø
c.	?aamiḷmixit	< ?aamḷ	+ mx + t	'help'	K2Ø
d.	mooxiḷmixit	< mooxḷ	+ mx + t	'grow old'	K2Ø
e.	p̣axaṭmixit	< p̣axaaṭ	+ mx + t	'mourn'	K2Ø
f.	ṣudoḱṃuxut	< ṣuduuḳ	+ mx + t	'remove'	K2Ø

If the syllabification rules apply non-cyclically, then we erroneously derive the following:

(3.127)

a.	*pa?ṭiṃxit	c.	*?amḷiṃxit	e.	*p̣axaaṭiṃxit
b.	*logẉiṃxit	d.	*mooxḷiṃxit	f.	*ṣudoḱuṃxit

This is shown in the derivation of *pa?ṭiṃxit below:

(3.128)

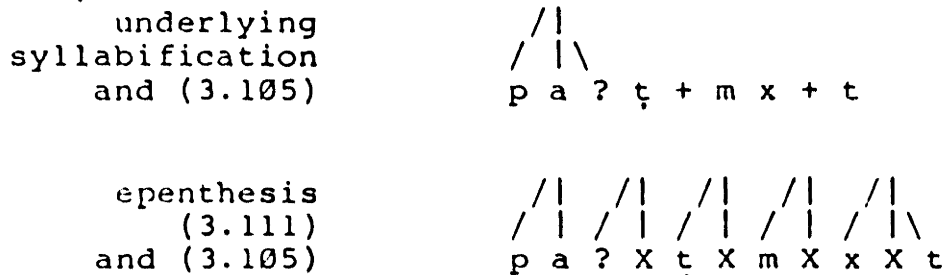

35. mx 'comitative' and t 'passive aorist' are combined with the verbs in Kuroda (1967), regardless of the meaning of the verb. The forms correspond to that described in Newman (1944), although examples are not found there.

3.2 -- Syllable Structure

syncope
trees
(3.118i)

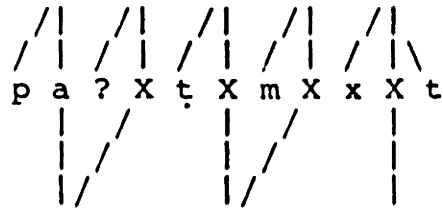

resyllabification
(3.118ii)

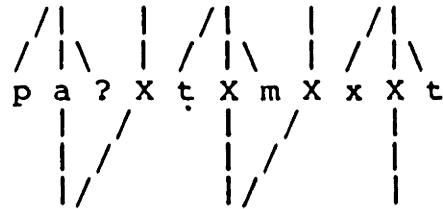

bare rime
deletion
(3.118iii)

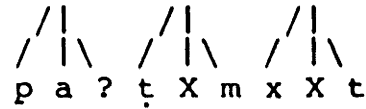

predicts

*pa?timxit

If the statement in (3.129; below holds for Yawelmani, then the correct syllable structure is derived:

(3.129)

Syllabification is cyclic.

(Recall that the first cycle begins after the first morphological process.)

Let us consider the derivation of /pa.t + mx + t/, given (3.129).

(3.130)

First Cycle

underlying
syllabification
and (3.105)

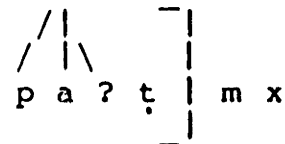

epenthesis
(3.111)
and (3.105)

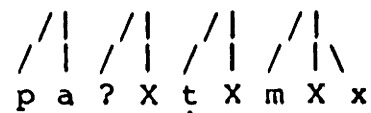

3.2 -- Syllable Structure

syncope
trees
(3.118i)

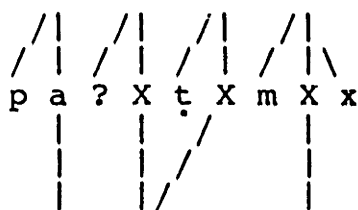

resyllabification
(3.118ii)

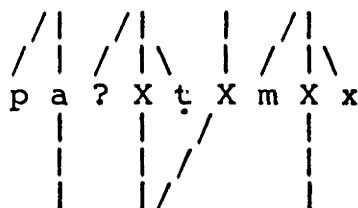

bare rime
deletion
(3.118iii)

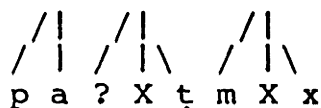

end of first cycle

pa?itmix-

At the end of the first cycle, we have three syllables in the root. As noted in Chapter 1, the trees are demolished at the end of the cycle and structure is built anew. This is because the trees themselves have no phonetic correlates. They simply count positions. Grids, features, and syllables have phonetic correlates and these do not delete at the end of the cycle.

At the second cycle, the suffix t 'passive aorist' is added. After epenthesis, the /x/ of the penultimate syllable resyllabifies into the syllable of the epenthetic vowel, by Core Syllabification (3.105).

(3.130) cont.

Second Cycle

underlying
syllabification
and (3.105)

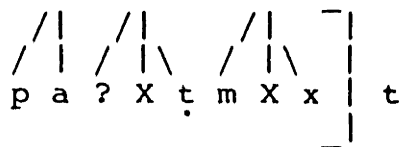

3.2 -- Syllable Structure

epenthesis
(3.111)
and (3.105)

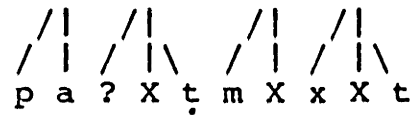

syncope
trees
(3.118i)

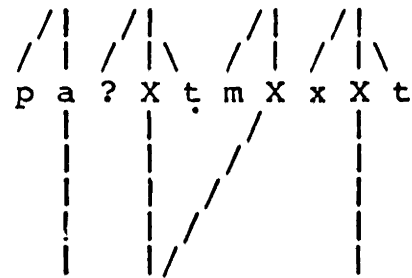

resyllabification
(3.118ii)
and bare rime
deletion
(3.118iii)
(not applicable)

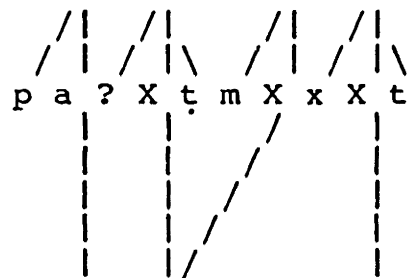

end of second cycle

pa?itmixit

Since the second syllable ends up closed at the end of the first cycle, it cannot resyllabify in the syncope process. The result is the correct pa?itmixit.

Although syllabification is done non-cyclically in the discussion preceding 3.130, the same results obtain if it is done cyclically.

3.2.4.4 Elision

When a vowel-initial suffix is added to a vowel-final sequence, the lefthand vowel deletes:

3.2 -- Syllable Structure

(3.131)

Vowel Elision

$$\begin{array}{c} | \backslash \\ \text{X X} \end{array} \rightarrow \emptyset / \text{ ____ } \begin{array}{c} | \\ \text{X} \end{array}$$

$$\begin{array}{c} | / \\ [] \end{array}$$

No morphemes end with short rimes: Morphemes are either C-final or xx-final. Thus, the rule need not be complicated to also delete light rimes.

In (3.132) we see some examples. In (3.132a-d), the affix ihnii 'agentive' is added to vowel-final sequences. In (3.132e) the suffix is ilaa 'causative', in (3.132f) it is istaa 'indirective', and in (3.132g) it is in 'mediopassive'. The second member of each pair shows the deleted sequence in a non-elision environment.^{36,37}

(3.132)

- a. wilaldihni? < will + CxCxxC + d(aa) + ihnii
'one who is always preparing to depart-S' 109
- ?ipaṭdaalis < ?ipt + CxCxxC + d(aa) + ls
'that which has been lost many times-S' 109
- b. biniitihni? < bint + CxCxxC + (?)ii + ihnii
'one who makes s.o. ask questions-S' 93
- hiṣiineehaṭxo? < hiṣ + CxCxxC + (?)ii + haṭ + xoo + ?
'wants s.o. to hide s.t.' 90

36. The long high vowel in (3.132b) is derived from the vowel-glottal stop sequence that arises in the (?)ii causative. See sections 3.2.1.1 and 3.2.1.2.

37. S refers to subject case, O to Object case. Case affixes are discussed in Chapter 4, section 5.1.

3.2 -- Syllable Structure

c.	?uṭoolsuhnu?	< ?uṭ + CxCxxC + (i)(l)saa + ihnii	'one who makes s.o. play music repeatedly-S'	95
	nireelsaahin	< nin + CxCxxC + (i)(l)saa + hn	'got s.o. to keep quiet repeatedly'	94
d.	hoýlihni?	< hoýlii + ihnii	'hunting-S'	156
	hoýlii/-	'to hunt'		74
e.	paxyulaahin	< paxyuu + ilaa + hn	'caused s.t. to scatter'	92
	paxyuu	'to scatter -intransitive'		92
f.	lool'istiisa	< lool' + istaa + iws + a	'inheritance-O'	87
	istaa	'indirective'		87
g.	hoyinhin	< hoyoo + in + hn	'was named'	Kuroda 21
	hoyok'	< hoyoo + ka	'name!'	29

There is one possible counter-example to Vowel Elision (3.131), the suffix -(a)l 'dubitative'. The vowel of this suffix surfaces only when it follows a consonant final root:

(3.133)

a.	tihel	< tihii + (a)l	'might get skinny'	120
	*tihal			
	*tiheéal ³⁸			
b.	di?şal	< di?ş + (a)l	'might repair'	120
c.	şoogal	< şuug + (a)	'might pull out'	120
e.	paxyulaahin	< paxyuu + ilaa + hn	'caused s.t. to scatter'	92

38. Recall that /ii/ --> [ee] by Lowering (3.33).

3.2 -- Syllable Structure

A rule deleting a vowel after a vowel across a morpheme boundary (i.e. *V--->∅ / V+___) is costly since the opposite rule is in fact the general case, as seen above. If the representation of -(a)l is

(3.134)

l
|
C

a

then the a links if a rime position is inserted by Epenthesis (3.111).³⁹

3.2.5 Exceptions to Rime Formation/Shortening

There are two exceptional cases involving Rime Formation/Shortening (3.107), both morphologically conditioned. With the morpheme (i)(l)saa 'causative-repetitive' and with certain wiy verbs, Rime Formation/Shortening (3.107) should apply but does not; with the morpheme xoo 'durative auxiliary', Rime Formation/Shortening (3.107) should not apply but does.

3.2.5.1 (i)(l)saa 'causative-repetitive'

This morpheme provides a CxCxxC template for the verb root melody. The second syllable never shortens. (The distribution of the suffixal "(i)" and "(l)" is discussed in Chapter 4, section 4.4.1.)

39. This is basically a reformulation of Kuroda's (1967) and Hockett's (1973) insights about (a)l. The same account is presented in Archangeli (1983a), and a similar one is found in Noske (to appear).

3.2 -- Syllable Structure

(3.135)

- | | | | |
|----|----------------|--|----|
| a. | ?uṭoolsuhnu? | <?uṭ + CxCxxC + (i)(l)saa + ihnii | 94 |
| | | 'one who makes s.o. play music repeatedly-S' | |
| b. | nineelsaahin | <nin + CxCxxC + (i)(l)saa + hn | 95 |
| | | 'got s.o. to keep still repeatedly' | |
| c. | ?uhwiyeelsaa/- | <?uh + wiy + CxCxxC + (i)(l)saa | 56 |
| | | 'cause s.o. to cough repeatedly' | |
| d. | ?opeetsaanit | <opt + CxCxxC + (i)(l)saa + nt | 95 |
| | | 'will be made to get up repeatedly' | |
| e. | moyeensaa/- | <moyn + CxCxxC + (i)(l)saa | 33 |
| | | 'cause to get tired' | |
| f. | pa?eetsaa/- | <pa?ṭ + CxCxxC + (i)(l)saa | 33 |
| | | 'cause to fight' | |

There are two general procedures for accounting for this kind of aberrant structure, (i) by underlying representation or (ii) by diacritic triggering or blocking some structure changing rule. However, with (i)(l)saa, either option requires a special rule. If the affix provides the following template

$$\begin{array}{c} | \quad | \backslash \\ X \ X \ X \ X \ X \end{array}$$

then a special rule is necessary to incorporate the final slot into the final syllable:

(3.136)

(i)(l)saa Rime Incorporation

$$\begin{array}{c} | \backslash \backslash \\ | \backslash \backslash \\ X \ X \ X' \end{array}]_{\text{root}} \quad \text{in the causative-repetitive}$$

Rime Formation/Shortening (3.107) cannot apply to this super-long rime since the environment is not met. A derivation follows.

3.2 -- Syllable Structure

(3.137)

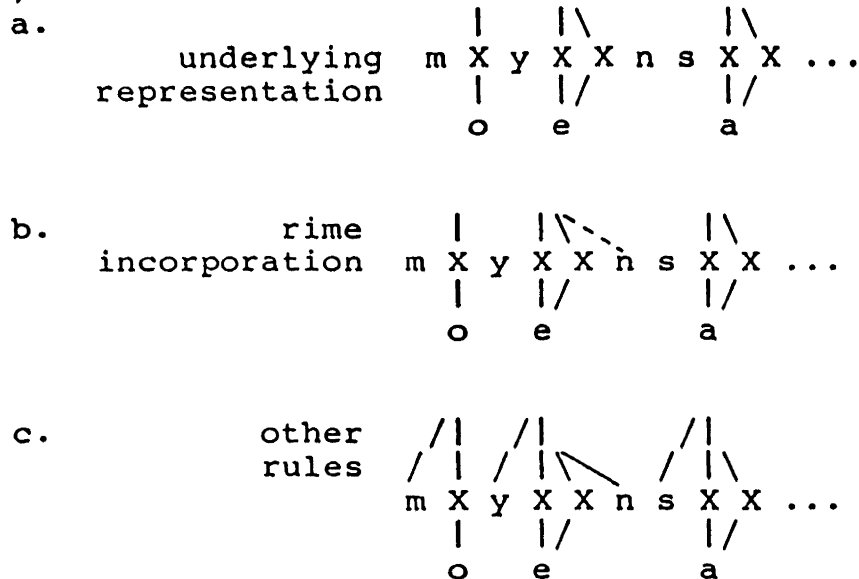

Rime Formation/Shortening (3.107) does not apply to the syllable yeen in (3.137c) since there is no unsyllabified slot. The form moyeensaa/- is correctly derived.

Consider now what happens if we posit a three-slot rime in underlying representation:

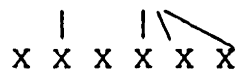

Under this account, there is no need for (i)(1)saa Rime Incorporation (3.136) since the rime is underlyingly super-heavy. However, a different special rule is required, namely one that links a consonant melody unit to the final template slot:

(3.138)

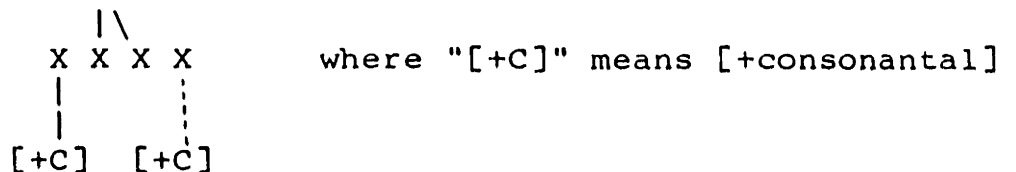

This rule must specify that the consonant which links to the final template slot is the leftmost unlinked consonant. That

3.2 -- Syllable Structure

this is the very consonant which is eligible for linking were the Universal Association Convention (1.5) applicable is coincidental, an undesirable consequence. Another undesirable consequence is that this increases the template pool to four,

| | \ | | \ | | \ | \ | \
X X X X, X X X X X, X X X X X X, X X X X X X

The fourth template is only used with the one affix. That the syllable structure of the fourth is aberrant is lost in this account, since the form undergoes regular syllabification rules.

As shown in chapter 4, throughout the template-supplying morphology, only three basic templates are supplied. They vary only by the addition of X' ("C") at the right edge. Thus, adding a fourth template is a costly move. I propose instead the rule of (i)(1)saa Rime Incorporation, (3.136).

3.2.5.2 Retardative Activity

There is a subsection of the language which is used primarily by children, called the wiy verbs, discussed in more detail in Chapter 5. The verb wiy means 'do, say'. A prefix is added to wiy, to create verbs. wiy itself undergoes regular morphology in these constructions.

The prefixes have one of the three following templates:

3.2 -- Syllable Structure

(3.139)

Examples of bi-, tri-, and quadriconsonantal preverbs

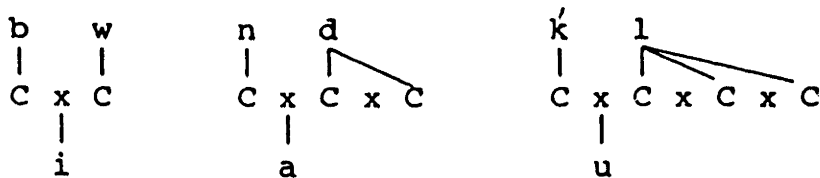

biwwiy/-	'make a ringing sound'	57
nadadwiw/-	'become smooth, agree with'	58
k'ulululwiw/-	'roll along'	58

To indicate that the same activity is done slowly, the final vowel of the prefix is lengthened.⁴⁰

(3.140)

a. hik'wiw-	'make a hiccuping sound'	57
hiik'wiw-	'make a panting sound'	57
b. palwiw-	'overspread quickly'	57
paalwiw-	'overspread slowly'	57
c. bidinwiw-	'tumble from a high place'	59
bidiinwiw-	'walk over a high place'	59
d. ʔataʔwiw-	'flutter'	59
ʔataaʔwiw-	'flutter slowly'	59

The lengthened vowel is always in a closed syllable but never lowers if underlyingly [+high], and never shortens:

(3.141)

a. *hek'wiw-	*heekwiw-	*hikwiw-	
	'make a panting sound'		
b. *palwiw-	'overspread slowly'		
c. *bidenwiw-	*bideenwiw-	*bidinwiw-	
	'walk over a high place'		
d. *ʔataʔwiw-	'flutter slowly'		

In Archangeli (1984), I account for these two facts by

40. There are no examples with quadriliteral wiy prefixes.

3.2 -- Syllable Structure

ordering the lengthening rule at lexical stratum 2 and the rules of Syllabification (3.106 and 3.107) and Lowering (3.33) at lexical stratum 1 (assuming a theory of lexical phonology and morphology as in Kiparsky 1982, 1983, etc.)

3.2.5.3 xoo 'durative auxiliary'

The effect of this morpheme on a preceding long open syllable is to shorten the rime. Following Newman (1944), I mark the stress only where it is aberrant. See section 3 of this chapter. (All examples are found on p. 104 of Newman 1944.)

(3.142)

- | | | | | | |
|----|---|---------------|---|----------------------------------|-----------------------------|
| a. | / | hooyexot | < | hooyii + xoo + t | 'is being sent' |
| b. | / | ?ohyoxo? | < | ?ohyoo + xoo + ? | 'is searching for' |
| c. | | maawoxoohin | < | maawuu + xoo + hn | 'was playing harp' |
| d. | | binatdaxoonit | < | bint + CxCxxC + d(aa) + xoo + nt | 'is being asked repeatedly' |

The syllable structure of (3.142c) is given below, with the slot circled that should be syllabified, were all the rules given above in normal operation.

(3.143)

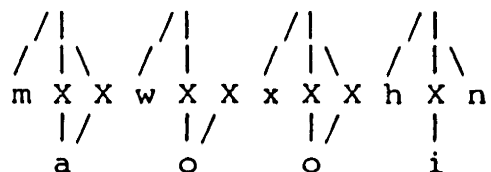

When xoo is attached to a consonant-final sequence, the syllable structure (and stress) is unremarkable. (All examples are found on p. 104 of Newman 1944.)

3.2 -- Syllable Structure

(3.144)

- a. hoynilxo? < hoynl + xoo + ? 'rallies'
- b. ?oyoowixxot < ?oyoowix + xoo + t 'was being pitied'
- c. bintatinoxó < bint + CxCC + (h)atn + xoo + ka
'be trying to ask!'
- d. ha'kaawinxoonit
< ha'kaawn + xoo + nt 'will be ridiculed'

Again, the question is whether these patterns can be accounted for in terms of the underlying representation of the morpheme xoo, or in terms of a special rule. A special rule is relatively simple to construct: A long vowel rime is shortened to the left of xoo.

(3.145)

xoo Demolition

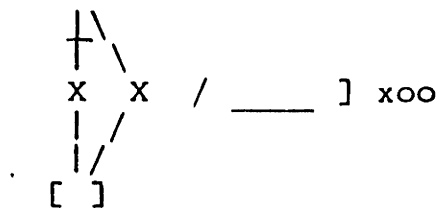

Since the head of the rime is demolished, Core Syllabification (3.105) can apply: The structure of the relevant syllable after xoo Demolition (3.145) is:

(3.146)

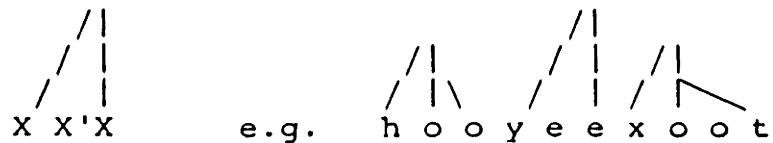

Rime Formation/Shortening (3.107) applies to the slots to the right of a rime; its environment is not met. Syllable Formation (3.106) applies to the slots to the left of a rime. Since vowels cannot be in the domain of the syllable head (i.e. in the "onset") in this language, Syllable Formation (3.106) is blocked from application.

Is another type of account possible? If the

3.2 -- Syllable Structure

syllabification with xoo is due to the general rules along with something quirky in the representation of xoo when syllabification applies, that quirkiness must be restricted to xoo only to the right of open syllables. This suggests that the quirkiness is assigned, not underlying. Also, as seen in section 3 of this chapter, stress is peculiar with xoo, if an open syllable is immediately to the left of xoo. The stress pattern is accounted for by assigning extrametricality to xoo after (i.e. to the right of) open syllables. Can "extrasyllabicity" be assigned to xoo also? At this juncture, I do not think that extrasyllabicity can account for the distribution of short open syllables seen above, for two reasons. First, the short, open rime does not delete, as Syncope (3.118) predicts. This is possible only if the syllable is shortened after syllabification is completed, not in the middle of syllabification. In all other cases where Syncope (3.118) fails, the critical mass is a morpheme (see the next section, 3.2.7). Here it is "to the left of" a certain morpheme. Secondly, there are three possible righthand environments for xoo, underlying C, Cx, and CC. In the first two cases, the C syllabifies with xoo (the singleton x is deleted by Syncope 3.118), and the entire rime is peripheral:

(3.147)



If this rime is marked extrasyllabic, the x of xoo is freed to close the preceding syllable, inducing Rime Formation/Shortening (3.107). However, when CC is affixed to xoo, a full syllable (after Epenthesis 3.111) follows xoo:

(3.148)

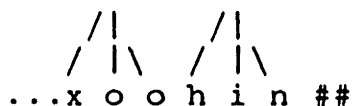

3.2 -- Syllable Structure

and extrasyllabicity is moot, since the relevant syllable is not peripheral. Extrasyllabicity predicts the following schematic distribution:

(3.149)

surface:
 [..C V x o C] [..C V x o C] *[..C V V x o o C V C]
 from underlying:
 /..CVV+xoo+C/ /..CVV+xoo+CV/ /..CVV+xoo+CC/

not the observed

[..C V x o C] [..C V x o C] [..C V x o o C V C]

Thus, I assume the rule, repeated below, which crucially applies after syllabification.

(3.150) (=3.145)

xoo Demolition

$$\begin{array}{c} | \backslash \\ | \backslash \\ x \quad x \quad / \quad \text{---} \quad] \quad xoo \\ | \backslash \\ | \backslash \\ [\quad] \end{array}$$

3.2.6 Exceptions to Syncope

Certain words have short open syllables which surface even in the deletion environment. There are two classes of morphology which fit into this category: (i) Three affixes have short vowels which never delete, and a fourth has a short vowel which optionally deletes and (ii) Certain case affixes are impervious to Syncope (3.118). The lack of Syncope (3.118) in one of the suffixes may be accounted for by appealing to the notion "strict cycle" (Mascaro 1976, Kiparsky 1982, 1983). For the others, and for the case affixes, I propose underlying tree structure.

3.2 -- Syllable Structure

3.2.6.1 Three Affixes Not Undergoing Syncope

The following suffixes have a short open vowel which surfaces in the Syncope (3.118) environment.

(3.151)

a. **eeni** 'resultative gerundial' 137

xateeni	*xaten	
	< xat+iini	'in order to eat'
taaneeni	*taanen	
	< taan+iini	'in order to go'

b. **hanaa** 'passive noun'

hooyeehana?	*hooyehna?	
	< hooyii+hanaa+?	'messenger-S' 136
gobooneehanaani	*joboonehnaani	
	< gobn+CxCxC+(?)ii+hanaa+ni	'being made to go in-IO' 149

c. **iyoo** 'prioritive' 116

maxiyu?	*maxyu?	
	< max+iyuu	'will first procure'
bineetiyox	*binetyox	
	< biniit+iyuu+xa	'first let s.o. ask'

If the first suffix, iini, undergoes Syncope (3.118), it surfaces as en. Thus, if Syncope (3.118) can apply to iini, there is no motivation for an underlying xxCx sequence: The final x never surfaces since it is always in the Syncope environment. Once the surface form is heard, it must be marked as exceptional. Kiparsky (1982, 1983) explores the concept of the strict cycle, in order to formalize this intuition. Certain rules apply only if the sequence to which they apply is derived by (i) concatenation of morphemes or (ii) application of a feature- or structure-changing rule.

3.2 -- Syllable Structure

Appealing to the notion of strict cyclicity to account for ini is supported by another, unrelated, fact about Yawelmani syllabification. One of the wiy verb prefixes is CxCxCxC: The Syncope (3.118) environment is built-in. For example,

(3.152)

a.	ʔunununwiy	'shiver'	*ʔunnunwiy	56
b.	ciwakaywiy	'turn green'	*ciwakaywiy	58
c.	kulululwiy	'roll along'	*kullulwiy	58
d.	saṅaṅaṅwiy	'quake'	*saṅaṅwiy	58

Both the wiy verb prefix and ini are readily accounted for by the lack of a derived environment.

The other two affixes must simply be diacritically marked so as not to undergo Syncope (3.118). I suggest they are underlyingly represented with an accent present:

(3.153)

\	\	<--- underlying rime structure
hanaa	iyoo	
↑	↑	<--- underlying accent

Thus, these light rimes are always heads of syncope trees and so never undergo resyllabification.

3.2.6.2 Case Affixes

When the case affix is a single vowel, for example the Subject marker ("S") in the plural and the Object marker ("O") in certain paradigms, it does not syncope, nor does a preceding vowel in the Syncope (3.118) environment:

(3.154)

a.	nusoosu	*nusos	'paternal aunt-O'	198
b.	neeʔaši	*neʔsi, *neeʔaš	'younger brother-S'	214

(Stress is marked in (3.154b) because it is aberrant. See section 3 of this chapter.)

3.2 -- Syllable Structure

The case system is constructed so that the syncope environment occurs only in the two cases illustrated above, and sometimes in the Indirect Object case:

(3.155)

a.	xataani	*xatan	'food-IO'	201
b.	bonyooni	*bonyon	'two-IO'	201
c.	heexaani	*heexan	'fat-IO'	201

The long vowel is inserted in (3.155a,b) but is part of the noun in (3.155c). See Chapter 4, section 5.1.

At this point, we simply observe the facts. I have nothing insightful to say about the syllabification here.

3.2.6.3 Optional Deletion with (?)iñay 'Contemporaneous Gerundial'

One final example of exceptional Syncope (3.118) occurs with the suffix (?)iñay 'contemporaneous gerundial'. If the floating glottal feature docks on the second consonant in the template (see Chapter 4, section 3.3 for this process), then the Syncope environment is met. Syncope (3.118) is optional here.

(3.156)

a.	pañiñay / pañniy	'while arriving'	137
b.	ćowiñay / ćowniy	'while grasping'	137
c.	tañiñay / tañniy	'while going'	137

This optionality can be expressed in terms of a "normal" representation and an optional rule assigning tree structure to the initial vowel of the affix.

3.2 -- Syllable Structure

(3.157)

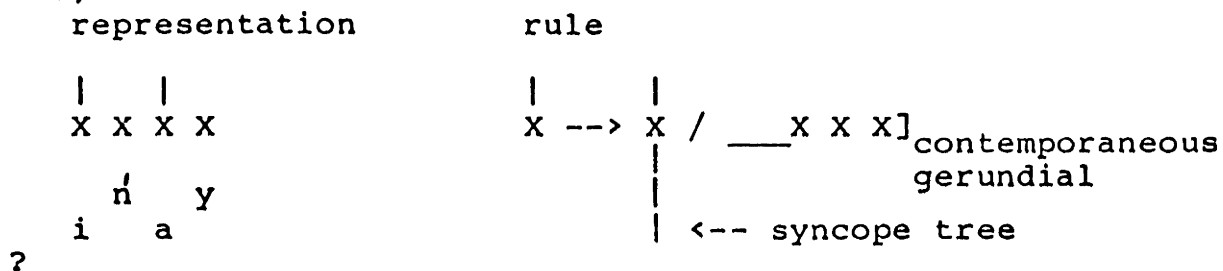

Newman (1944, p. 137) notes that this suffix is rare, which may account functionally for the variants. Of particular interest here, however, are the alternations in the vowel melody: When a syllable head is deleted, the vowels apparently shift rightwards:

(3.158)



A rule can be formulated to relink the floating vowel. Another option is to mark the vowels of (?)inay so as to prevent their linking until after syllabification. This account is preferable to positing a relinking rule because the Universal Association Convention (1.5) predicts exactly which vowel melody unit links (the leftmost unassociated unit) and exactly where it links (the leftmost free syllable head):

(3.159)

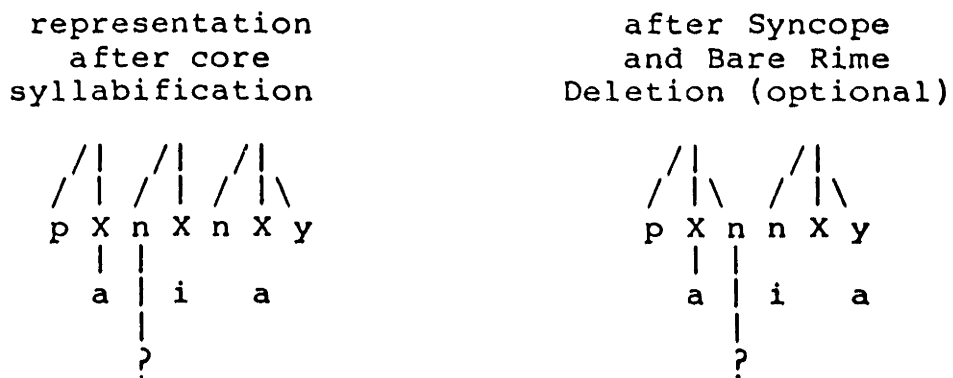

3.2 -- Syllable Structure

Universal Association Convention



Under either account, the relink rule account or the floating vowel account, this adds support to the argument that consonant and vowel melodies form independent planes.

Note that most vowels must link prior to Syllabification, else there is no explanation for when Copy (3.31) applies and when the Redundancy Rules (2.140) fill in an empty slot as /i/.

3.3 Stress

We now turn to stress in Yawelmani. The following examples illustrate that stress is basically penultimate in Yawelmani ("/" marks stress on the syllable beneath).

(3.160)

- | | | | |
|----|---------------|----------------------------|-----|
| a. | hooyeehana? / | 'messenger-SUBJ' | 136 |
| b. | hiw'ti'na? / | 'while walking' | 136 |
| c. | ?ohyoohin / | 'searched for' | 163 |
| d. | wo?yuyok' / | 'go to sleep immediately!' | 116 |

3.3 -- Stress

Furthermore, as (3.161) demonstrates, stress is phrasal, not word-based. Stress in a sentence may vary, depending on how the phonological phrases are built up. Newman (1944, p. 29) provides the following example. The wide gaps indicate stress phrase boundaries and the narrow gaps indicate word boundaries.

(3.161)

- | | | | | | | | |
|----|------------------------------------|-----|-----|------|------|----------|-------|
| a. | / | | / | | / | | / |
| | ?ohom | ma? | nim | hi? | dab | wiyen | mokyi |
| b. | / | | / | | / | | / |
| | ?ohom | ma? | nim | hi? | dab | wiyen | mokyi |
| c. | / | | / | | / | | / |
| | ?ohom | ma? | nim | hi? | dab | wiyen | mokyi |
| d. | | | / | | / | | / |
| | ?ohom | ma? | nim | hi? | dab | wiyen | mokyi |
| | not | you | my | will | then | tell-fut | wife |
| | 'you, then, will not tell my wife' | | | | | | |

Stress on a given word varies depending on its position in a phonological phrase. For example, ?ohom 'not' is stressed on either the penultimate syllable (in 3.161a), on the ultima (3.161b,c), or unstressed (3.161d), depending on the phrasing. The citation form of a word, of course, is with penultimate stress since it forms a phrase of its own. Newman notes that in general nouns and verbs regularly end phonological phrases so their stress usually is on the same syllable that it falls on in citation.

Consider now the following words with the morpheme xoo 'durative': Sometimes xoo occurs in words with penultimate stress (3.162), and sometimes in words with antepenultimate

3.3 -- Stress

stress (3.163).⁴¹

(3.162)

/			
wiywiyxoohin		'was doing thus repeatedly'	
wiy-wiy + xoo + hn			104
do-rep.	aorist		

/			
wu?yatinxoonit		'is being desired to go to sleep'	
wu?y + (h)atn + xoo + nt			114
sleep desid.	passive-fut.		

(3.163)

/			
coowoxo?		'is working already'	110
coow + (?)aa	+ xoo + ?		
work continuative	fut		

/			
hooyexot		'is being sent'	104
hooyii + xoo + t			
send	passive aorist		

/			
?ohyoxo?		'is searching for'	104
?ohyoo + xoo + ?			
search	future		

The difference between (3.162) and (3.163) is that in (3.162), xoo occurs in the penult, whereas in (3.163) xoo appears in the ultima. Antepenultimate stress appears in the latter examples only. If in some way the final syllable does not count for stress assignment, then stress is identical to stress in words without xoo: Stress the penult.

Interestingly, sometimes xoo surfaces in the final syllable although in underlying representation it is in the penult. This is due to Syncope (3.118) discussed in section 2 of this chapter. When xoo (which ends with an open syllable)

41. For a complete discussion of the affixation processes involved in wu?y + (h)atn... and cow + (?)aa..., see Chapter 4, section 3.

3.3 -- Stress

is followed by ka 'imperative', the vowel of ka is deleted by Syncope (3.118), and the morpheme xoo ends up in the final syllable. This is shown in the following derivation of /hiiççaa+xoo+ka/ 'be teasing (s.o.)!' 104.⁴²

(3.164)

UR	hiiççaa + xoo + ka	
	tease	imperative
other rules	ee	
syllabification		
SR	heççaxok'	

In this example, as in others, syncope removes the vowel of the final suffix and xoo ends up in the final syllable. Stress in this case is antepenultimate:

(3.165)

/	heççaxok'	'be teasing (someone)!'	104
/	?ohyoxo?	'is searching for'	104

In short, it does not matter how xoo ends up in the final syllable, just so long as it does, for stress to be shifted one syllable to the left.

An analysis of Yawelmani stress must account for placement of penultimate stress, the regular case, and antepenultimate stress, in case the xoo morpheme forms part of

 42. Here and elsewhere, "other rules" include Shortening of long vowels in closed syllables (3.107) and before xoo (3.150), Epenthesis (3.111), discussed in section 2 of this chapter and Harmony (3.49), discussed in section 1 of this chapter.

3.3 -- Stress

Dominance, then, is one of the parameters to be set. There is no default value for the direction of dominance, as far as I know.

A second parameter determines the size of the domain. There are two possible domain sizes: A domain is either bounded to contain maximally one terminal element:

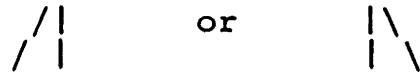

or it is unbounded, containing any number of terminal elements:

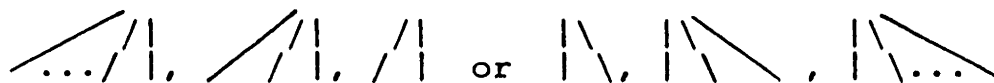

Halle and Vergnaud (in prep) suggest that unless specified otherwise, trees are unbounded.

A third parameter is **directionality**: Trees may be built from the right edge of the word, i.e. **right-to-left**, or from the left edge of the word, i.e. **left-to-right**. Keeping the settings of the parameters for boundedness and dominance constant, different settings for directionality may result in different tree patterns, depending on whether there is an odd or even number of syllables in the stress phrase. The "x" indicates a syllable head.

bounded right dominant trees

left to right

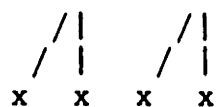
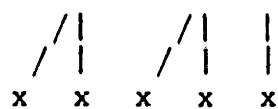

right to left

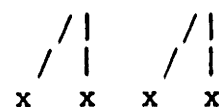
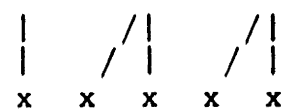

I know of no arguments for one direction over the other as the

default setting.

There are two other parameters, (i) iterative or non-iterative tree construction and (ii) the definition of the terminal elements of trees. When tree construction is iterative, every X slot which is in the set of terminal elements is in a tree. Non-iterative construction means only the rightmost/leftmost (depending on directionality) terminal elements have tree structure:

right to left, left dominant, bounded trees

iterative

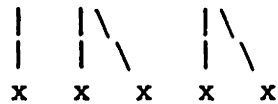

non-iterative

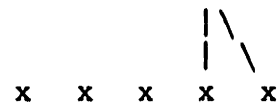

I know of no default setting here.

The X-slots which may be terminal elements of trees are a subset of the X-slots which are syllable heads. All syllable heads may be terminal elements, or there may be some limitations set. For example in a language with multiple degrees of stress, one set of trees may be built on syllable heads, and a second set built on syllable heads which are also heads of the first set of trees (for example, English -- see Halle and Vergnaud in prep). Halle and Vergnaud (in prep) suggest that the default setting here is that the set of all syllable heads is the set of possible terminal elements.

The following list summarizes the parameters for tree construction and lists the default values where known:

(3.166)

Parameters for Tree Construction

- a. left or right dominant
- b. bounded or unbounded -- default unbounded
- c. left-to-right or right-to-left
- d. iterative or non-iterative
- e. definition of terminal elements
-- default all syllable heads

3.3.1.2 Extrametricality

There are two diacritics used in stress analyses, **extrametricality** and **accent**. Of real interest here is **extrametricality**; **accent** is discussed only orthogonally. **Accent** is a diacritic which may either be assigned by rule to certain terminal elements or be present on terminal elements in underlying representation. **Accent** indicates that the so-marked terminal element must be the head of its tree. If it is in a tree, it is the head of the tree, but if it is not in a tree, the **accent** diacritic is irrelevant.

Extrametricality is introduced in Hayes (1980) and Harris (1980, 1983), following Liberman and Prince (1977) and Nanni (1977), to account for a certain class of systematic aberrations in stress patterns found in a variety of languages. In broad terms, if a terminal element is marked "extrametrical", it does not participate in stress assignment when peripheral. Latin stress is illustrative:

(3.167)

/	/	/
refectus	refecit	reficit

The distribution in (3.167) is described by the following statements.

(3.168)

Latin Stress

- a. Stress the penult if it is heavy; also stress the penult in disyllables.
- b. Otherwise stress the antepenult.

This relatively simple stress pattern cannot be captured solely in terms of trees because there is no means of deriving stress on the antepenultimate syllable, as in reficit. If, however, the final syllable is ignored and heavy syllables are accented, the stress rule is trivial:

(3.169)

Latin Stress

Accent all heavy syllables in the word.

Build bounded left dominant trees from the right edge of the word.

Prior to application of stress (3.169), the final syllable is marked extrametrical, and consequently it ignored by the stress rule. I use the diacritic "sub-x" to indicate extrametricality.⁴⁴ The symbol "o" means "syllable head".

(3.170)

Assignment of Extrametricality (Latin)

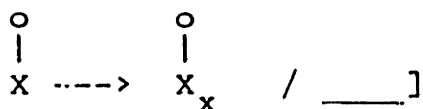

The derivations below demonstrate what happens to the three words in (3.167). (Accent is marked by an underline, dots

44. This notation is taken from Clements (1983). I prefer it to the more common parentheses because "sub-x" may be marked only on one segment/unit at a time, whereas parentheses are capable of delimiting strings of segments/units and so are misleading.

3.3 -- Stress

separate the phonemes into syllables.)

(3.171)

underlying representation

$\begin{array}{c} / \quad / \quad / \\ X X X \quad X X X \quad X X \\ \quad \quad \\ r e . f \quad e c . t \quad u s \end{array}$	$\begin{array}{c} / \quad / \quad / \\ X X X \quad X X X \quad X X \\ \quad \quad \\ r e . f \quad e e . c \quad i t \end{array}$	$\begin{array}{c} / \quad / \quad / \\ X X X \quad X X \quad X X \\ \quad \quad \\ r e . f \quad i . c \quad i t \end{array}$
--	--	--

At the first step in the derivation, the final syllables (-tus, -cit, and -cit) are marked extrametrical by rule (3.170).

(3.171) cont.

assign extrametricality

$\begin{array}{c} / \quad / \quad / \\ X X X \quad X X X \quad X X \\ \quad \quad X \\ r e . f \quad e c . t \quad u s \end{array}$	$\begin{array}{c} / \quad / \quad / \\ X X X \quad X X X \quad X X \\ \quad \quad X \\ r e . f \quad e e . c \quad i t \end{array}$	$\begin{array}{c} / \quad / \quad / \\ X X X \quad X X \quad X X \\ \quad \quad X \\ r e . f \quad i . c \quad i t \end{array}$
--	--	--

Now, accent is assigned to all heavy syllables in each word. It is not assigned to the final syllables because they are extrametrical and consequently are not subject to the stress rule.

(3.171) cont.

assign accent

$\begin{array}{c} / \quad / \quad / \\ X X X \quad X X X \quad X X \\ \quad \quad X \\ r e . f \quad e c . t \quad u s \end{array}$	$\begin{array}{c} / \quad / \quad / \\ X X X \quad X X X \quad X X \\ \quad \quad X \\ r e . f \quad e e . c \quad i t \end{array}$	$\begin{array}{c} / \quad / \quad / \\ X X X \quad X X \quad X X \\ \quad \quad X \\ r e . f \quad i . c \quad i t \end{array}$
--	--	--

Next, stress trees are built according to (3.169). Although the stress tree is bounded and left-dominant, in both refectus and refecit the rightmost "visible" syllable is the head of the stress tree, because it is accented. With reficit, in contrast, stress is on the antepenult since the penult is not accented. (In this figure, the X slots have been "replaced"

3.3 -- Stress

by the sounds of the word, due to the limitations of the two-dimensional page. The stress trees are to be interpreted as anchored in the same X slot as the sound is anchored in in the preceding figure.)

(3.171) cont.

assign stress

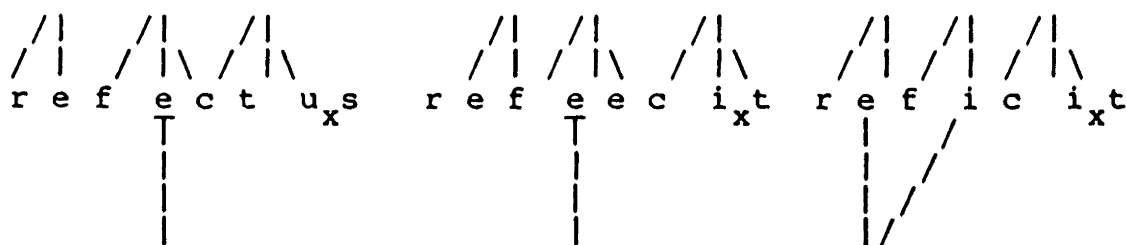

Hayes (1980, 1981) uses examples like the one above to argue for the theoretical construct **extrametricality**. The arguments have subsequently been strengthened to the point of making all aberrant stress patterns the result of either extrametricality or accent (on the latter see Halle and Clements 1983, Halle and Vergnaud in prep). Furthermore, the scope of extrametricality has expanded considerably. Its application has been extended to tone assignment (Pulleyblank 1983, Archangeli and Pulleyblank 1984), syllabification (Clements and Keyser 1983, Clements 1983)⁴⁵ and Kiparsky

45. Clements and Keyser (1983) and Clements (1983) are somewhat fuzzy in their use of the term "extrasyllabic". Clements (pc) states that extrasyllabic simply means "not in a syllable". Peripheral extrasyllabic segments are meant to be the result of being "extrametrical with respect to syllabification" whereas word-medial extrasyllabic segments are the result of the syllable structure filters of the language. Given non-iterative tree assignment, we have both types of extrametricality also: Syllables that are marked extrametrical and so may not participate in the stress rules and syllables that are too far to the left/right to be incorporated in the one stress tree in non-iterative stress assignment. Terminal elements which may not participate are termed **extrametrical**; those which may but do not are termed **non-metrical**.

3.3 -- Stress

(1983) suggests the term "extraprosodicity", as he accounts for peripheral vowels not undergoing harmony in Vata by treating them as "extraharmonic".

The Yawelmani data bear on the loss of extrametricality. There are two views, that of Hayes (1980, 1981) and that of Kiparsky (1983). For both, a single morphological or phonological unit is marked extraprosodic (by using a feature-like notation "[+ex]") either by rule or in its lexical entry. The point on which Hayes and Kiparsky differ is in the loss of extrametricality. For Hayes, an automatic universal convention changes the notation [+ex] to [-ex] when the so-marked unit is not peripheral in its domain.⁴⁶ Instead of giving extrametricality a feature-like status, I propose that it is interpretive:

(3.172)

Peripherality Condition

X --> is invisible / [Y ___ Z]_D
[+ex]

where Y, Z are not null and
D is the domain of stress rules

Kiparsky presents a different view. Extrametricality may be lost in one of two ways, given below (from Kiparsky 1983:47):

46. This condition is originally due to Harris (1980).

3.3 -- Stress

(3.173)

Lexical Model Extrametricality (Kiparsky 1983)

- a. An element automatically loses its extraprosodic [=extrametrical -- DA] status at the end of the lexicon. (It may, however, be marked again as extraprosodic postlexically if the rule applies there and if it is peripheral in its phrasal domain.)
- b. Such marking is only permitted in peripheral positions. An element automatically loses its extraprosodic status when it ceases to be peripheral, as for example by affixation.

The example presented here illustrates that Hayes' Peripherality Condition (3.172) is to be preferred over Kiparsky's Extrametricality (3.173) since in the Yawelmani data extrametricality cannot be lost automatically under affixation nor automatically at the end of the lexicon. Rather, extrametricality is relevant to the stress rule and is considered only when the stress rule applies. The extrametrical morpheme xoo may lose and then regain its peripherality during the course of a derivation. It still counts as extrametrical, just as if it never lost its peripherality in the first place. What is crucial is first that peripherality is checked only when the stress rule applies, and second that stress is phrasal, and thus post-lexical, yet what is extrametrical is a morpheme, and thus is lexically marked. We conclude, then, that an extrametrical unit is interpreted as visible or invisible only when the relevant rules apply.

The morpheme xoo may be lexically marked as extrametrical, or its extrametricality may be assigned by rule. In another example from Yawelmani, extrametricality must be assigned by rule, triggered by a specific morphological class. This example is found in one of the noun paradigms. Words in a particular noun paradigm surface

3.3 -- Stress

sometimes with antepenultimate stress, sometimes with penultimate. Antepenultimate stress occurs only if the case ending is monosyllabic; penultimate stress occurs when the case ending is disyllabic (there are no "zero" case endings in this paradigm). There are two problems to be addressed here, what induces the assignment of extrametricality and what extrametricality is assigned to.⁴⁷

3.3.2 Yawelmani Stress

Recall the data in (3.162) and (3.163), which show that stress is basically penultimate in Yawelmani. Penultimate stress in a metrical theory is arrived at in one of two ways: (i) Stress is assigned by a non-iterative left-dominant bounded tree from the right edge of the word. This gives the representation below, where "o" is a syllable head:

(3.174)

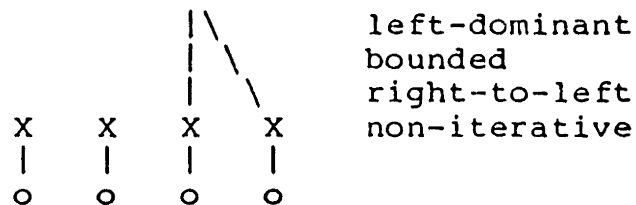

left-dominant
bounded
right-to-left
non-iterative

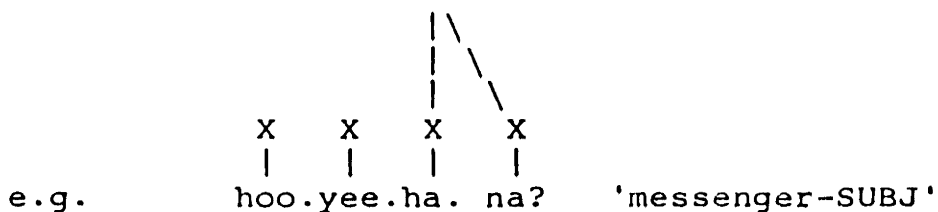

47. Similar examples are found in languages as diverse as Polish and Spanish. On the former, see Franks (1983) and Halle and Vergnaud (in prep) and on the latter see Harris (1983). The Franks and Halle and Vergnaud analyses are similar to the one given here. The Harris analysis, on the other hand, is very different (although it too uses extrametricality and could, to the best of my knowledge, be attributed to a rule very like the one proposed here.)

3.3 -- Stress

*

and (ii) Extrametricality is assigned to the head of the final syllable of every word and stress is assigned via a right-dominant unbounded or bounded tree.

(3.175)

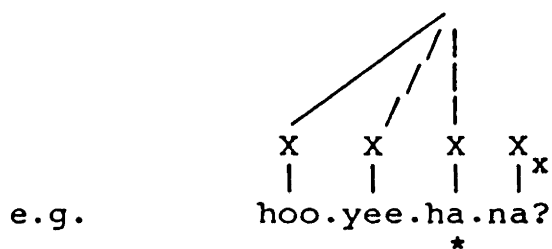
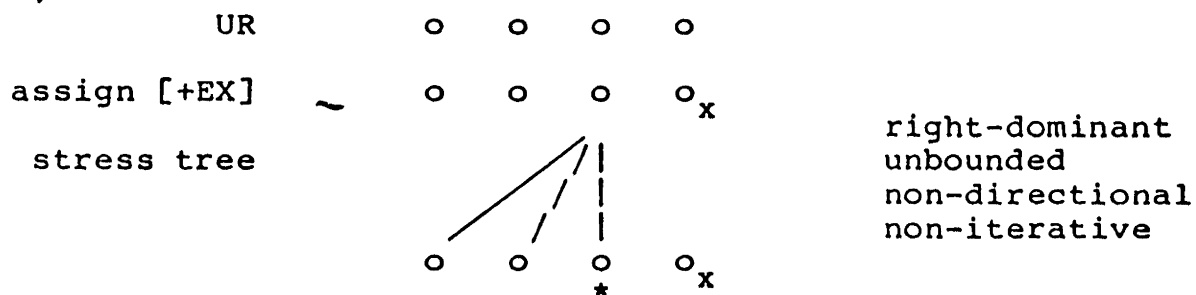

(3.176)

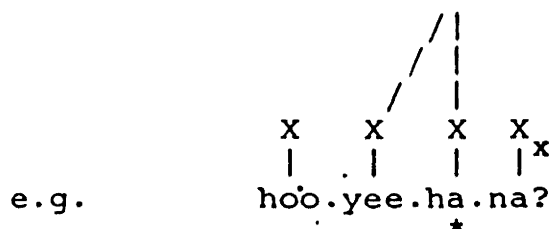
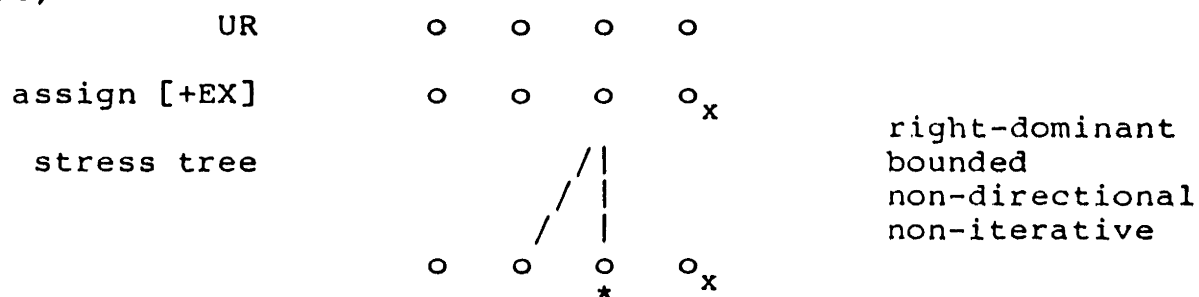

Recall from (3.166) that unless specified otherwise, trees are unbounded. Also, extrametricality is a diacritic and so must

3.3 -- Stress

be learned. This rules out the third option, i.e. mark final syllables extrametrical and construct a right dominant bound tree from the right edge of the word.

There are also problems with the second approach, final extrametricality and unbounded trees: It leaves no reasonable way of dealing with the morpheme xoo. The final two syllables must be marked extrametrical if the final syllable contains xoo. Extrametricality can only be assigned to xoo by rule because, since the entity marked extrametrical is polymorphemic, extrametricality cannot be part of the underlying representation. Yet this rule either marks the final two syllables as extrametrical, a solution not allowed in the theory as it stands since extrametricality may only be assigned to units, or creates a word-final bounded tree which is then marked as extrametrical.

With this first account, a non-iterative bounded tree built at the right edge of the word, there is a straightforward way of accounting for the distribution of xoo -- mark xoo extrametrical.

A comparison of the two solutions is given below.

(3.177)

	bounded	unbounded
tree	bounded	default (unbounded)
dominance	left	right
direction	right to left	not applicable
other	----	o --> o _x / ____]
<u>xoo</u>	$\begin{array}{c} \text{xoo}_x / \begin{array}{l} \backslash \\ \text{X} \text{X} \\ / \\ [] \end{array} \text{---} \end{array}$	$\begin{array}{c} \text{F} \\ \backslash \\ \text{oo} \text{---} \text{o} \text{o} / \text{---}] \text{ if} \\ \text{o}] \text{ contains } \text{xoo} \text{ and} \\ \text{o} / \text{---} \text{o}] \text{ is open} \end{array}$

3.3 -- Stress

Neither account needs to mention non-iterativity since this is the default value. The unbounded tree account does not need to specify that the tree is unbounded because unbounded is the default case. Furthermore, with unbounded trees, directionality does not matter. All that need be stipulated is the dominance setting. This makes the unbounded tree account appear simpler if stress with xoo is not considered.

Even so, the bounded-tree account is intuitively simpler in one respect: There is no rule assigning extrametricality, as there is in the unbounded-tree account.

Consider now stress with xoo. In the unbounded analysis, a single bounded tree is created in a complex environment solely to avoid assigning extrametricality to a non-constituent. It plays no other role in the phonology of Yawelmani. This is an unmotivated use of phonological structure since a simpler solution (namely the bounded account) exists. I conclude, on these grounds, that the bounded account is the simplest representation of Yawelmani stress available in the theory assumed here.

As noted above, we assume that trees are unbounded in the default case (and that bounded trees are specified). Furthermore, since extrametricality must be learned, in the default case there is no extrametricality. However, there is no discussion of the relative cost of the two types of specifications with respect to each other. Intuitively, setting a parameter should be less marked than assigning a diacritic. The evidence in Yawelmani argues for the correctness of this intuition. We see a choice between specifying trees as bound or using the extrametricality diacritic. If setting the tree construction parameter is preferable to assigning extrametricality, then the observation of the extrametricality of xoo is unremarkable.

3.3 -- Stress

If assigning extrametricality is preferable to setting the tree construction parameter, then when the extrametricality of xoo is observed, the entire stress system must be revamped.

The Yawelmani stress rule, then, is:

(3.178)

Yawelmani Stress Rule

- | | |
|------------------|-----------------------|
| a. bounded ~ | d. non-iterative |
| b. left dominant | e. all syllable heads |
| c. right to left | |

3.3.2.1 Antepenultimate Stress

Let us return to the morpheme xoo. Recall from (3.162) and (3.163) that when xoo is in the phrase-final syllable after an open syllable it does not count for stress assignment. As noted above (3.163) and (3.165), for xoo to be in the word-final syllable morphemes of the shape C or Cx must follow xoo. If we assume either (i) the following underlying representation for xoo,

(3.179)

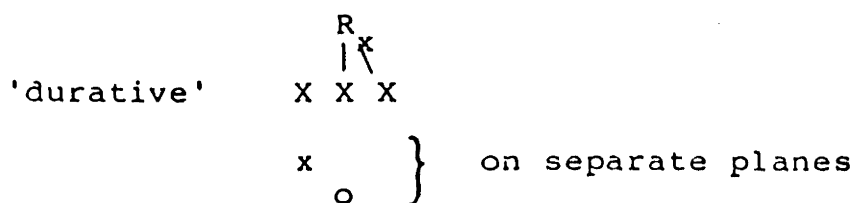

and a rule which deletes extrametricality after a consonant, or (ii) an underlying representation without extrametricality and a rule which assigns extrametricality to the final rime of xoo,

(3.180)

xoo Extrametricality Assignemnt

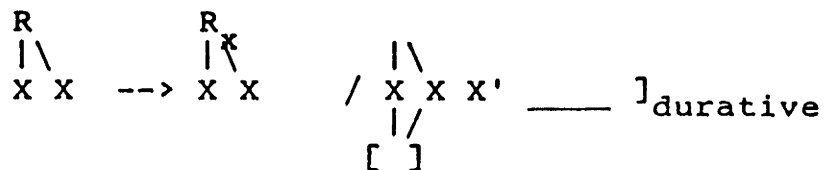

the following derivation results:⁴⁸

(3.181)

	...+C]
root	ćow
affixation	ćoow + (?)aa + x[oo] _x + ?
other rules	w' oo

Note that after affixation the extrametrical rime of xoo is not peripheral. Syllabification (see section 2 of this chapter) applies.

(3.181) cont.



The final morpheme ? 'future' induces shortening of the sequence xoo?, because it closes the long syllable (see Rime Formation/Shortening 3.107 above) and the extrametrical rime is still peripheral. However, this results only if Hayes' Peripherality Condition (3.172) holds. If we assume Kiparsky's Extrametricality (3.173), extrametricality is automatically lost upon affixation.

5. Placing consonants and vowels on separate planes is motivated in Chapter 4, as is the glottalization of /w/ in the derivation of ćoow'oxo?. Harmony (3.49) is motivated in Chapter 3, section 1.

3.3 -- Stress

(3.182)

affixation	$\acute{c}oow + (?)aa + xoo_x + ?$
lexical model	$\acute{c}oow + (?)aa + xoo + ?$
extrametricality (3.173)	

The derivation of (3.181) continues, assuming Hayes' Peripherality Condition (3.172):

(3.183) (=3.181 cont.)
 Peripherality Condition (3.172) n/a

stress

*
 $\acute{c}oo \cdot \acute{w}o \cdot xo_x ?$

| /
 | /
 | /

Since the extrametricality diacritic is on a peripheral terminal element when the stress rule (3.178) applies, antepenultimate stress is correctly derived.

Below we see a similar derivation, where a CV suffix is added: héççaxók 'be teasing someone' is derived from hiiççaa 'tease', xoo 'durative' and ka 'imperative'.

(3.184)

root	hiiççaa
affixation	hiiççaa + x[oo] _x + k̄a
other rules	ee
syllabification	$\begin{array}{c} / \quad \quad \backslash \quad / \quad \quad \backslash \quad / \quad R \quad \backslash \\ h \quad e \quad eçç \quad a \quad x \quad oo \quad k̄a \end{array}$

In (3.184), Syncope (3.118) syllabifies the k̄ of k̄a into the syllable containing xoo, and deletes the vowel of k̄a. Stress is assigned below.

(3.184) cont.

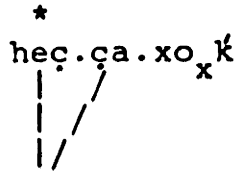

As seen in the above derivations, the Hayes' Peripherality Condition (3.172) correctly predicts antepenultimate stress when xoo is in the phrase-final syllable. If Lexical Model Extrametricality (3.173) is assumed, extrametricality is lost immediately upon the affixation of ka. Yet if it is lost, we have no account of the data.

Kiparsky's second point (3.173b) is that extrametricality is automatically lost at the end of the lexicon. In (3.161), it is clear that stress in Yawelmani is phrasal, and so it must be post-lexical. However, if, as in (3.173a), extrametricality is automatically lost at the end of the lexicon, the wrong stress patterns are predicted.⁴⁹

(3.185)

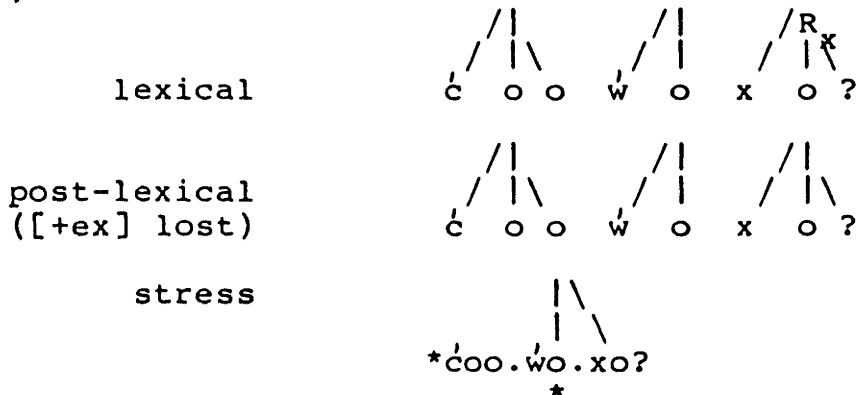

One might try to save (3.173a) by proposing that words are stressed lexically, then post-lexically all but the stress

49. See (3.181) for the complete derivation of /'cow+(?)aa+xoo+?/ 'is working already'.

3.3 -- Stress

of the last word in the phrase is lost. This, however, incorrectly predicts a lack of stress loss on phrase-final monosyllables (recall (3.161a) above: *[ma? nim hi?] vs. [ma? nim hi?] where the underlined syllable is stressed). Consequently, Kiparsky's proposal (3.173) must be abandoned in favor of Hayes' (3.172).

3.3.2.2 Antepenultimate Stress in Nouns

The paradigms below compare the stress of a regular noun (3.186a) with the stress of an "CxxCCC plural" noun (3.186b).^{50,51}

(3.186)

	a.	biwiineelis 'one who is made to sew' 189	b.	nee?aş 'younger brothers' 214
S		biwiineelis		nee?aşi
P		biwiinelsin		nee?aşin
O		biwiinelsi		nee?aşi
IO		biwiinelseeni		nee?aşheeni
A		biwiinelseenit		nee?aşheenit
L		biwiinelsiw		nee?aşhiw

The contrast occurs in all cases except indirect object and

50. The abbreviations are based on Newman (1944): S = subject, P = possessive, O = object, IO = indirect object, A = ablative, and L = locative. See Chapter 4.5.1 for a discussion of case and Chapter 4.5.2 for a discussion of the A-induced plural paradigm.

51. biwiineelis is derived from the causative biwi?nii and the suffix ls 'consequent agentive'. The long [ii] is derived from the /i?/ sequence. See section 2 of this chapter for a discussion of this process.

ablative, and these are the only disyllabic case endings. Since antepenultimate stress occurs only with the A-induced plurals, case endings may not be represented as always extrametrical if mono-syllabic. The possibility argued for here is that extrametricality is not induced by the affixes at all but rather is triggered by the plural paradigm. Another possibility is to attribute the differences to two homophonous affixes, one both marked extrametrical and attached to the CxxCCC plural nouns and the other not marked as extrametrical and available for affixation "elsewhere". The unexplained redundancy in this second option renders it implausible.

Under the assumption that extrametricality is not a property of the affix, we are still left with choices: Is it a property of the noun with which the affix is concatenated or is it a property of the template to which the noun's melody has conformed?⁵²

Newman (1944) does not provide a paradigm of the singular of /ni?iis/ 'younger brother' (surface [ne?ees...]). However, he states that we may assume stress to be penultimate unless he notes to the contrary. Consequently, we may assume that stress in the singular of these nouns is penultimate, the regular case. Since the singular forms of nouns like ni?iis do not exhibit stress alternations, but only the plural forms, the extrametricality is not a property of the noun stem itself, but rather it must be a property of the CxxCCC plurals. This is consistent with the fact that among nouns all and only the CxxCCC plurals have the aberrant stress patterns. The diacritic assigning extrametricality is part of the lexical entry of the CxxCCC plural template and triggers

52. On the matter of "templates", see Chapter 4 (also Archangeli 1983a,b).

3.3 -- Stress

the relevant rule whenever an affix is concatenated with the template.

We now consider this rule. As observed above, if the case affix is monosyllabic, then it behaves as if it is extrametrical:

(3.187)

/		/
nee?aşhi	vs.	nee?aşheeni

Assume that the CxxCCC plural has a diacritic [+D] which triggers Noun Extrametricality (3.188):

(3.188)

Noun Extrametricality

$$\begin{array}{c} \circ \\ | \\ X \end{array} \text{ ---> } [ex] /]_N \text{ ___ in the presence of } [+D]$$

Noun Extrametricality (3.188) assigns extrametricality to the (head of the) syllable immediately following the noun root. In the event that the suffix is monosyllabic, this single syllable is marked extrametrical, as seen below:

(3.189)

/ \	/ \	/
X X X X	X X	X X ^x
n e e ?	a ş	h i
} root		

Since the extrametrical syllable is peripheral, when stress is applied the final extrametrical syllable is ignored.

(3.190)

*		/
nee.?aş.hi _x	---->	nee?aşhi
/		
/		

3.3 -- Stress

On the other hand, if the affix is disyllabic, extrametricality is assigned to the penult by Noun Extrametricality (3.188).

(3.191)

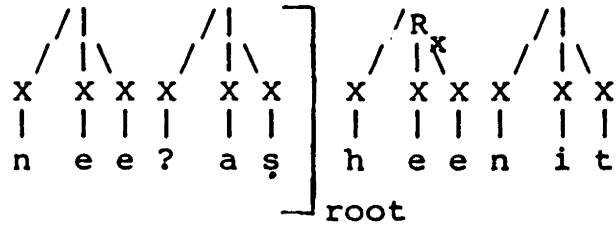

This extrametrical rime is not peripheral. When stress trees are constructed, all syllables are visible and available as terminal elements.

(3.192)

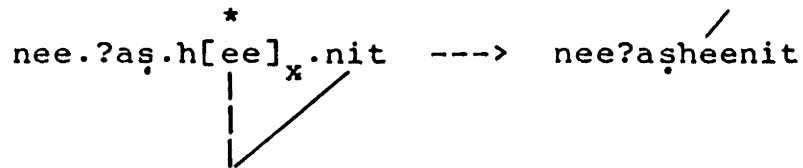

The analysis argued for here consists of two parts, the diacritic [+D] associated with the CxxCCC plural template in the representation of the morpheme and the rule Noun Extrametricality (3.188) which assigns extrametricality in the presence of the diacritic. There are other possibilities, for example, the rule might assign extrametricality only to a monosyllabic case endings or extrametricality might be associated with certain affixes. The second (as has already been noted) leaves certain redundancies unexplained.

First, and most obviously, there is the redundancy of the case affixes' phonological strings. The fact that these are identical is accidental if we must list the two sets separately. Secondly, it is accidental that all and only the monosyllabic case endings are extrametrical if we choose a list approach rather than a diacritic-triggered rule

3.3 -- Stress

approach. Both of these points are expressed if we represent the diacritic as associated with the CxxCCC template.

Changing the rule assigning extrametricality means complicating the rule:

(3.193) (=3.188)

Noun Extrametricality

o ---> [ex] /]_N ___ in the presence of [+D]

(3.194)

False Extrametricality

o ---> [ex] /]_N ___] in the presence of [+D]

Both rules produce the correct surface forms. However, the first rule, Noun Extrametricality (3.188), is formally more general in that the environment is represented with fewer symbols. Thus it is a simpler rule than the second rule, False Extrametricality (3.194). Under the assumption that formal generality, i.e. simplicity, is preferred in a grammar, Noun Extrametricality (3.188) is the rule that is learned.

Furthermore, there is a claim inherent in Noun Extrametricality (3.188) and lacking in False Extrametricality (3.194). Noun Extrametricality (3.188) predicts exactly when extrametricality counts (i.e. when the extrametrical syllable is invisible to stress assignment) and when it does not count, simply by the general principles governing extrametricality. It counts only if the syllable marked extrametrical is the final syllable in the word. With the rule False Extrametricality (3.194), this distribution also obtains, but it is built directly into the rule and so is accidental. Given that the general principles governing extrametricality provide exactly the distribution observed, a grammar capitalizing on this is a simpler grammar than one not capitalizing on this.

3.3 -- Stress

3.3.3 Implications for Stress Theory

As seen here, the stress distribution in Yawelmani is a relatively trival system except for the one morpheme xoo and the CVVC(C)VC plural paradigm.

In the regular case, the stress rule of Yawelmani could be analyzed either as a bounded tree without extrametricality or as an unbounded tree with extrametricality. This raises a question for the relative markedness of setting the marked value of the bounded/unbounded parameter vs. adding extrametricality. Under the parameter-setting analysis, the treatment of xoo and of the CVVC(C)VC plural is straightforward, but if a general extrametricality rule is added an account of xoo and the CVVC(C)VC plurals is impossible without drastically altering the nature of extrametricality. Thus, this relatively simple stress rule provides evidence that setting a parameter to a marked value is preferable to adding a diacritic, even a universal diacritic like extrametricality.

The Yawelmani data also supports Hayes' Peripherality Convention over Kiparsky's claims about loss of extrametricality. The stress alternations and syllabification with xoo interact to show that extrametricality is not "checked" by the Peripherality Condition (172) until the stress rules apply. During the course of a derivation, the morpheme xoo may lose and then regain its peripherality, but it is only at the time of applying stress rules that the peripherality (or lack thereof) matters. Further, extrametricality is marked on a lexical item, yet has no effect until the post-lexical phonology. Although extrametricality is marked lexically, it is not automatically lost simply because the form has come to the end of the

3.3 -- Stress

lexicon as argued in Kiparsky (1983). Post-lexically when stress applies, the extrametricality is still present.

The Yawelmani data show that extrametricality is in a sense global: It remains as part of the unit with which it is originally associated throughout any derivation involving the unit, regardless of the peripherality of the unit during the course of the derivation and regardless of the stratum (lexical or post-lexical), until the domain to which [+ex] is relevant (here, stress rules) is achieved.

A diacritic is represented in the lexicon but is relevant post-lexically. A problem for the theory of lexical phonology is raised by this result. In lexical phonology (see Kiparsky 1982, 1983, Mohanan 1982), it is argued that rules with lexical exceptions must be lexical rules. However, if we extend to other diacritics the conclusion drawn here about extrametricality, namely that it is not automatically lost at the end of the lexicon, then we lose part of this distinction between lexical and post-lexical rules. The data considered here show that this must be a property of extrametricality. Whether this is a property of extrametricality itself or whether this property can be extended to diacritics in general remains to be demonstrated.

Notice that there are two types of "diacritics", however. One is the diacritic like extrametricality and like [+D]: These are both non-phonological diacritics in that there is no phonological content to them, although phonological rules are sensitive to these diacritics. (Accent is also a "non-phonological diacritic".) These contrast with "phonological diacritics", i.e. phonological structure that is not predictable by rule. This can be as simple as a single feature value (see section 1 of this chapter) or as complex as pre-built syllable structure (see section 2.3 of this

3.3 -- Stress

chapter), pre-linked tones, etc. The claim in lexical phonology and morphology is that lexical rules do not apply to underlying representations, but only to derived representations (see the discussion of lexical phonology in Chapter 1). Post-lexically, rules apply across-the-board and do not respect the derived/underived contrast. Thus, "phonological diacritics" are not relevant post-lexically, but "non-phonological diacritics" are relevant until the rule sensitive to the diacritic has applied.

In the discussion of antepenultimate stress in nouns, it is noted that the diacritic triggering Noun Extrametricality (188) must be represented lexically, assuming the criteria for lexical rules in Mohanan (1982) and Kiparsky (1982, 1983). Noun Extrametricality (188) must also be triggered lexically, since it makes reference to bracketing. Even though Noun Extrametricality (188) is triggered lexically, the extrametricality remains even upon exiting the lexicon, since stress is phrasal. Again, we have evidence for the global nature of extrametricality: Once extrametricality is assigned by whatever means, it remains intact until the relevant rules apply, here stress rules.⁵³

This adds to the literature on using "universal diacritics" like extrametricality rather than "language specific diacritics" like [+D]. There are certain diacritics argued for in the literature which are needed for numerous languages, like extrametricality. These universal diacritics are ones whose characteristics are prescribed by universal grammar. Other diacritics (like [+D] here) are language specific, at least at this point in the understanding of

53. I do not mean to imply that there could be no rule explicitly deleting extrametricality, although there is no argument for such a rule in Yawelmani.

3.3 -- Stress

phonology. One point to explore is whether diacritics like [+D] have certain general properties, as do extrametricality and accent

(3.199) (=3.49)

Coplanar Harmony

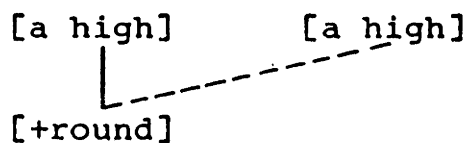

(3.200) (=3.105)

Core Syllabification = Syllable Formation
and
Rime Formation/Shortening

(3.201) (=3.106)

Syllable Formation

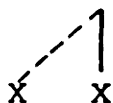

(3.202) (=3.107)

Rime Formation/Shortening

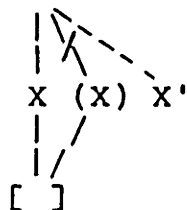

(3.203) (=3.111)

Epenthesis

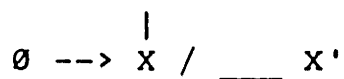

(3.204) (=3.118)

Syncope

i. Foot Construction

- a. accent branching rimes (i.e. branching rimes must be heads)
- b. bounded feet
- c. left dominant
- d. right to left

ii. Resyllabify foot heads (ignoring syllable structure of the domain)

iii. Bare Rime Deletion

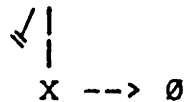

(3.205) (=3.131)

Vowel Elision

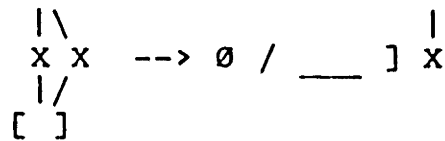

(3.206) (=3.136)

(i)(1)saa Rime Incorporation

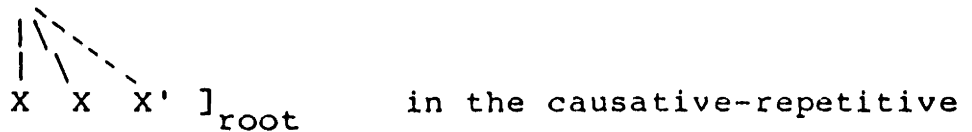

(3.207) (=3.150)

xoo Demolition

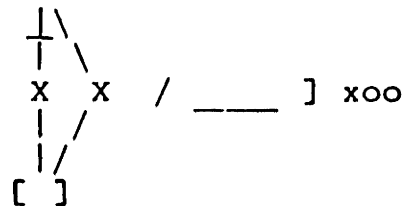

(3.208) (=3.178)

Yawelmani Stress Rule

- a. bounded
- b. left dominant
- c. right to left
- d. non-iterative
- e. all syllable heads

(3.209)

Ordering of Rules

Lexical Rules

Copy (3.195)

Syllable Internal Spread (3.196)

(i)(l)saa Rime Incorporation (3.206)

Vowel Elision (3.205)

Syllabification (3.200) - (3.204)

xoo Demolition (3.207)

Harmony (3.199)

Lowering (3.197)

Post-Lexical Rules

Stress (3.208)

Assimilation? (3.198)

Chapter 4

MORPHOLOGY

The problem addressed here is the relation between underlying and surface representations of verbs and nouns in Yawelmani. With certain suffixes in Yawelmani the form of a given regular verb/noun stem is not necessarily identical to the canonical form which that stem exhibits with the majority of affixes in the language. The phenomenon is illustrated with verbs first, then in section 5 nouns are discussed. Under general affixation, called neutral affixation here, regular verbs conform to one of the six patterns given in (4.1), where the parenthesized final X (or C) surfaces with triconsonantal roots and does not surface with biconsonantal roots.

- (4.1)
- | | | | | | |
|----|--------|----|---------|----|----------|
| a. | | b. | \ | c. | \ |
| | XXX(X) | | XXXX(X) | | XXXXX(X) |
| | or | | or | | or |
| | CxC(C) | | CxxC(C) | | CxCxx(C) |

I call the (4.1a) pattern short, the (4.1b) pattern long, and the (4.1c) pattern disyllabic.

Certain affixes, called template affixes, have the property of supplying a particular pattern, or template, for the root, which supersedes the patterns in (4.1). Thus, regardless of the form of the verb under neutral affixation, the roots will surface with the template supplied by the

suffix.

For example, ?ilk- 'sing' surfaces with the short CxCC pattern with the neutral affixes but assumes the disyllabic form CxCxxC, i.e. ?iliik- when followed by the template affix -?aa 'durative'. In fact, every regular verb root exhibits the disyllabic pattern when -?aa is affixed.¹

(4.2)

a.	short root		?ilk 'sing'	
	?ilk+iin	-->	?ilken	'will sing' 27
	?iliik+?aa+n	-->	?ilek?an	'is singing' 49
			(*?ilik?an)	

The neutral suffix in (4.2) is -iin 'future'. In (4.2a), the template affix is -?aa 'durative', which provides a CxCxxC template. It is followed by another future suffix, -n 'future'.²

With other template affixes, roots exhibit other patterns. Thus, a root with the disyllabic form CxCxxC before neutral affixes, e.g. hiwiit- 'walk' surfaces in the short pattern CxCC, i.e. hiwt- preceding another template affix -(?)iñay 'gerundial'. Again, any root assumes the short template when concatenated with -(?)iñay.

1. The alternations between [+high] and [-high] vowels are regular, due to Lowering (3.197), discussed in Chapter 3, section 1. The alternations between long and short vowels are also regular, due to the rule of Rime Formation/Shortening (3.202), discussed in Chapter 3, section 2.

2. The distribution of the two future affixes is as follows: The suffix -iin follows consonant-final verbs, and the suffix -n follows vowel-final verbs, that is, the suffix is iin and there is a rule (3.205)

VV --> Ø / V + ____

which is discussed in Chapter 3, section 2.4.4.

(4.2) cont.

b. disyllabic root	hiwt	'walk'	
hiwiit+iin	-->	hiweeten	'will walk' 101
hiwt+(?)i ^h inay	-->	hiw ^h ti ^h inay	'while walking' 136
		(*hiw ^h etnay)	

The template suffix in (4.2b) is -(?)i^hinay 'gerundial', which supplies a CxCC template.³

The syllabic structure of the verb is dependent on the verb root itself when concatenated with neutral affixes. In contrast, with template affixes the syllabic structure of the verb is determined by the affix. The chart in (4.3) characterizes the distribution of these patterns. The parenthetical consonant is included, as in (4.1), because some roots are biconsonantal and others are triconsonantal.

(4.3)

Underlying Cx patterns with root and template affixes

root pattern		short	long	disyllabic
neutral affix A		CxC(C)	CxxC(C)	CxCxx(C)
affix B		CxC(C)	CxxC(C)	CxCxx(C)
affix C		CxC(C)	CxxC(C)	CxCxx(C)
template affix P		CxC(C)	CxC(C)	CxC(C)
affix Q		CxxC(C)	CxxC(C)	CxxC(C)
affix R		CxCxx(C)	CxCxx(C)	CxCxx(C)

Assuming a core skeleton independent of phonemic melodies allows us to capture elegantly this curious distribution of root forms, a distribution which has been largely ignored in treatments of Yawelmani since Newman (1944).

3. The vowel insertion in the putative form *?ilik?an in (4.2a) is due to Epenthesis (3.203), and the shortening and deletion in the form *hiw^hetnay in (4.2b) to Shortening (3.202) and Syncope (3.204), discussed in Chapter 3, section 2.

The analysis here makes apparent a formal similarity between certain Semitic languages⁴ and the Yokuts dialects, namely the morphologically-conditioned alternations in vowel and consonant patterning in roots. However, Yokuts differs from these Semitic languages in an interesting way: In Semitic, the root template is fixed by the morphology independently of any affixation. In Yokuts, the affixation determines the template of the root.⁵

The account here also provides insight into the difference between regular verbs and irregular verbs, which explains the affixational properties of each verb type.⁶

To begin with, we simply assume that the general forms of verbs are essentially those proposed in Newman (1944), Kuroda (1967), and Kisseberth (1969). Examples of the six regular verb forms are given in (4.4), where the roots are concatenated with either -hn 'aorist' or -t 'passive aorist'. Alternations are the regular ones discussed in Chapter 3.

4. See, for example, McCarthy (1979a,b), Broselow (1984). Harris (1944) observed a similarity of morphological vowel alternations in verb roots between Semitic and Yokuts soon after Newman's grammar (1944) was published. Ellen Broselow (pc) has pointed out another prosodic similarity between the two language groups: The syllabification rules are nearly identical.

5. The same phenomenon has been argued for in Smith and Hermans (1982) for S. Sierra Miwok. Thanks to John McCarthy for pointing out their article to me.

6. There is one other verb type in Yawelmani, the wiy- verbs used by children. wiy verbs are discussed in Archangeli (1984).

4.1 -- Template-Supplying Affixes

(4.4)

Examples of the six regular verb patterns

pattern	example			
	underlying	surface		
CxC	caw + hn	cawhin	'shout'	135
CxxC	cuum + t	coomut	'destroy'	125
CxCxx	hoyoo + hn	hoyoohin	'name'	
CxCC	?amc + t	?amcit	'be near'	
CxxCC	diiyl + hn	deeyilhin	'guard'	
CxCxxC	biniit + t	bineetit	'ask'	

In section 1, using verbs of these six forms, we see that the initial claim made in the introduction is in fact true: There are neutral affixes which concatenate with the above patterns of the verbs but there are also the template affixes which determine the template of the verb. An outline of the analysis is provided.

In section 2, justification is given for the basic templates for the verb roots (i.e. those in 4.4). This relies on the phonological rules motivated in Chapter 3, and is essentially the argument made in Kuroda (1967). These rules also provide evidence for the forms of the affix-supplied templates: With the vocalic alternations peeled away, the underlying patterns emerge. In addition, the distribution of vowels is shown to be simplest if the vowel and consonant melodies are on separate planes, in the sense discussed in Chapter 1.

In section 3, we deal more extensively with the template-supplying affixes. It is established that only the triconsonantal templates are needed in Yawelmani and that there is no need for biconsonantal templates.

A catalog of all of the verbal affixes in Yawelmani

4.1 -- Template-Supplying Affixes

(based on the data in Newman 1944), is presented in section 4, along with a discussion of peculiarities seen with some of the template-supplying affixes. This discussion provides further evidence for representing vowel and consonant melodies on separate planes.

Section 5 contains a discussion of noun morphology, including template-supplying morphology. Noun morphology is in one respect extremely similar to Arabic (cf. McCarthy 1979a, 1981, etc.) since in some cases no suffix need be added in the template-supplying paradigms. A catalog of noun suffixes is included.

4.1 Template-Supplying Affixes

As stated in the introduction, we are provisionally assuming that regular Yawelmani verb roots conform to one of the six Cx-templates given in (4.1) and represented again below in (4.5). (As noted above, these templates are motivated in section 2 of this chapter.) In the first row, roots have only two C-slots, and in the second row, each has three C-slots, biconsonantal and triconsonantal templates respectively.

(4.5)

	short	long	disyllabic
Biconsonantal templates	CxC	CxxC	CxCxx
Triconsonantal templates	CxCC	CxxCC	CxCxxC

Associated with a biconsonantal template is a root with two consonant segments (and one vowel segment), a biconsonantal root. Triconsonantal roots, those with three consonant segments, are associated with triconsonantal templates. Each lexical entry (i.e. the underlying representation of each

4.1 -- Template-Supplying Affixes

verb) consists of one vowel segment and two or three consonant segments. The distribution of melody segments is motivated in section 4.2.2. These segments are linked to corresponding skeletal slots by the Universal Association Convention (1.5) discussed in Chapter 1.

About half of the forty to fifty verbal suffixes in Yawelmani concatenate with these forms. In (4.6) paradigms with the suffixes -hn 'aorist' and -(a)l 'dubitative',⁷ and -t 'passive aorist' are given.⁸ The surface forms in square brackets are derived by the regular processes of Epenthesis (3.203), Shortening (3.202), and Harmony (3.199), discussed in Chapter 3.

7. See Chapter 3, section 2.5 on the dubitative suffix -(a)l.

8. The paradigms in (4.6), and also those in (4.16), (4.17), (4.18), (4.24), (4.27), (4.33), (4.36), (4.37), (4.38), consist (partially or entirely) of contrived forms which are consistent with Newman (1944). All other forms in the article are attested in Newman on the page shown unless marked otherwise.

4.1 -- Template-Supplying Affixes

(4.6)

Cx-pattern	aorist <u>-hn</u>	dubitative <u>-(a)l</u>	passive aorist <u>-t</u>	
a. CxC	caw + hn [cawhin]	caw + al [cawal]	caw + t [cawit]	'shout'
b. CxxC	cuum + hn [comhun]	cuum + al [coomal]	cuum + t [coomut]	'destroy'
c. CxCxx	hoyoo + hn [hoyoohin]	hoyoo + al [hoyol]	hoyoo + t [hoyot]	'name'
d. CxCC	?amc + hn [?amichin]	?amc + al [?amcal]	?amc + t [?amcit]	'be near'
e. CxxCC	diiyl + hn [deeyilhin]	diiyl + al [deylal]	diiyl + t [deylit]	'guard'
f. CxCxxC	biniit + hn [binethin]	biniit + al [bineetal]	biniit + t [bineetit]	'ask'

The patterns in (4.6) contrast sharply with the forms we observe when the durative suffix -(?)iixoo is affixed (followed by the aorist -hn in 4.7).

(4.7)

Cx-pattern in (4.6)	surface Cx-pattern	example
CxC	CxC	caweexoohin
CxxC	CxC	cumooxoohin
CxCxx	CxC	hoyeexoohin
CxCC	CxCC	?amceexoohin
CxxCC	CxCC	diyleexoohin
CxCxxC	CxCC	binteexoohin

These forms may be derived from the pattern in the first column in (4.6) by positing a few morphologically-conditioned rules. This is, in fact, the approach taken in Kuroda (1967) and Kisseberth (1969a). There are certain problems with such a 'rule account', both conceptual and empirical. First, it is necessary to posit at least two rules to collapse all of the six underlying forms into the two patterns surfacing with the suffix -(?)iixoo in (4.7). Two other rules are needed to get the disyllabic form occurring before -?aa (see figure 4.2).

4.1 -- Template-Supplying Affixes

Furthermore, the root exhibits the long CxxC(C) pattern before other template affixes. To get this pattern, two further rules are needed. A possible rule solution is given below.

(4.8)

A Rule Account

a. Short CxC(C) Pattern

	i. x ----> Ø / x ____	ii. x ----> Ø / CxC ____	
UR:	CxC(C)	CxxC(C)	CxCxx(C)
i:	n/a	CxC(C)	CxCx(C)
ii:	n/a	n/a	CxC(C)
output:	CxC(C)	CxC(C)	CxC(C)

b. Long CxxC(C) Pattern

	i. Ø ----> x / Cx__C	ii. xx ----> Ø / xC__	
UR:	CxC(C)	CxxC(C)	CxCxx(C)
i:	CxxC(C)	n/a	CxxCxx(C)
ii:	n/a	n/a	CxxC(C)
output:	CxxC(C)	CxxC(C)	CxxC(C)

c. Disyllabic CxCxx(C) Pattern

	i. x ----> Ø / #C__x	ii. Ø ----> xx / C__ C#	
UR:	CxC(C)	CxxC(C)	CxCxx(C)
i:	n/a	CxC(C)	n/a
ii:	CxCxx(C)	CxCxx(C)	n/a
output:	CxCxx(C)	CxCxx(C)	CxCxx(C)

In each case, the (i) rule is needed to lengthen/shorten the vowel in the first syllable. The (ii) rule is needed to change the disyllabic skeleton into a monosyllabic skeleton, or vice versa in (4.8c). The (i) and (ii) rules together derive identical Cx-patterns, regardless of the input sequence. By the rule account, the regularity of the resulting patterns is merely accidental. Nothing constrains a pair of rules from producing six different forms, paired with the six different input sequences, but this does not happen.

4.1 -- Template-Supplying Affixes

Furthermore, the rules operate only in tandem as paired in (4.8). They are not independently motivated. No rules intervene between them. Also, there is no explanation of the fact that the patterns resulting from these rules are identical to the patterns that serve as input to these rules.⁹

Finally, there is no natural explanation of the fact that there is a class of irregular verbs which do not conform to the templates in (4.1) (even with neutral affixes) and which do not undergo concatenation with template affixes at all. The rules in (4.8) could apply equally to an irregular verb as shown in (4.9) with (4.8a), but this never happens.

(4.9)

Applying (4.8a) to irregular verbs:

UR	tiixal + (?)iixoo + t	wastuu + (?)iixoo + t
(4.8ai)	∅	∅
(4.8aai)	∅	n/a
	*tixleexot	*wasteexot
	'talk'	'hurt, injure'

The irregular verbs simply do not concatenate with the group of affixes which supply templates for the root. Along with the non-existent forms in (4.9), the following are also non-existent:

(4.10)

*/tiixal+iixoo+t/ --> *[teexaleexot]
*/wastuu+iixoo+t/ --> *[wasteexoot]

Exceptions, where irregular verbs do concatenate with template affixes, are rare. (In these cases a template is

9. The last observation is due to Mark Baker.

10. Only four of the approximately twenty template affixes are observed with irregular verbs: c 'one who is Ving', d(aa) 'repetitive', (?)aa 'one who has Ved', and "∅" 'noun'.

4.1 -- Template-Supplying Affixes

supplied.)¹⁰

The account offered here is that each template suffix supplies a template for the verb root and this template surfaces, in place of the verb's neutral template. For example, when concatenated with -(?)i'ay biconsonantal roots are provided with a CxC template and triconsonantal roots with a CxCC template. The phonemes of the root melodies link to the C- and x-slots in accordance with the Universal Association Convention (1.5).

Before examining in more detail the variety of templates imposed by affixes and the associations of melodies to template slots, let us consider what it means for an affix-supplied template to surface, "in place of" the neutral template. One may, of course, have a stipulation in the grammar, a rule to be learned, which deletes the regular template upon or prior to insertion of the affix-supplied template. Note that such an account predicts that irregular verbs undergo template affixation as well. The proposal sketched here, however, provides a principled reason why the affix-supplied template surface in place of the regular template. It also accounts for the non-participation of irregular verbs in this kind of affixation.

4.1.1 How to Supply a Template

At the heart of the proposal here is the Elsewhere Condition, repeated below from chapter 1:¹¹

11. Thanks to Mark Baker and Richard Sproat for much helpful discussion of this section.

4.1 -- Template-Supplying Affixes

(4.11) (=1.21)

The Elsewhere Condition

Rules A and B in the same component apply disjunctively if and only if

- a. The input of A is a proper subset of the input of B.
- b. The outputs of A and B are distinct.

In that case, A (the particular rule) is applied first and if it takes effect then B (the general rule) is not applied.

It is clear that, in the case of Yawelmani, supplying a template is determined by the affixes and verbs involved. In this sense it is a morphological process. However, the template that is supplied has no syntactic or semantic content and in this sense it is a phonological process. I assume that the affix-determined template is supplied by a rule and further that the 'neutral template' is itself also supplied by rule. A diacritic on each (regular) verb triggers a rule which provides the verb's neutral template. Affixes may carry diacritics triggering template-inserting rules as well. Examples of the rules and the lexical entries for a few verbs and affixes are given below. (We ignore biconsonantal roots for the moment.)

(4.12)

Rules inserting Cx-templates:

- a. Insert CxCC / ({{(?)ihay, iixoo, ...}})
- b. Insert CxxCC / ({{aa, ...}})
- c. Insert CxCxxC / ({{?aa, wsiil, ...}})

In (4.12) the rules which insert the three triconsonantal templates are listed. Triconsonantal verbs subject to each of the rules are given in (4.13).

4.1 -- Template-Supplying Affixes

(4.13)

Lexical entries of a few verbs:

- | | | | |
|----|-------|-----------|---------------|
| a. | ?amc- | 'be near' | apply (4.12a) |
| b. | diy1- | 'guard' | apply (4.12b) |
| c. | bint- | 'ask' | apply (4.12c) |

(4.14)

Lexical entries of a few affixes:

- | | | |
|----|--------|------------------|
| a. | hn | 'aorist' |
| | CC | |
| b. | l | 'dubitative' |
| | C | |
| | a | |
| c. | t | 'passive aorist' |
| | C | |
| d. | ? | 'durative' |
| | Cxx | |
| | a | |
| e. | ? ṇ y | 'gerundial' |
| | | |
| | xCxC | |
| | i a | |

The affixes in (4.14) illustrate both the neutral and the template affixes from figure (4.3). The affixes (4.14) have no diacritic triggering a rule from (4.12). However, the template affixes are mentioned in the structural description of the rules in (4.12). This illustrates the formal difference between the two types of affixes. Affixation with a neutral affix is straightforward. The affix concatenates with a root and the root diacritic forces application of one of the rules in (4.12).

4.1 -- Template-Supplying Affixes

When a template affix is concatenated with a root, the structural descriptions of two rules are met. For example, the affix -(?)iḥay is in the structural description of (4.12a) yet this affix may concatenate with diyl- (which triggers (4.12b) or with bint- (which triggers (4.12c)). Which rule wins? Consider the structural description of each rule: The affix-triggered rule applies only when that affix is present, and so is a special rule. A root-triggered rule is a general rule in that it applies whenever the root is present, regardless of affixation. Thus, the structural description of the affix-triggered rule is contained in the structural description of the verb root triggered rule, and so is a special rule. The results of applying each rule to the string are distinct, and so the special rule applies, blocking the general rule.

This accounts for how the affix-supplied template surfaces in place of the neutral template. Also, it makes clear that what has been called the 'neutral template' is not part of the underlying representation of each verb: Only the diacritic is underlying. The neutral template is supplied whenever no other template has been supplied. Verb roots, then, are underspecified in two ways. Only the minimal number of features are specified for the phonemes of the root and no skeletal core is associated with the root. Redundancy rules, some of which fill in rules and some of which fill in templates, provide the missing information.

We are now in a position to see why irregular verbs cannot undergo template affixation. Irregular verbs contrast with the regular verbs in a variety of ways. They may have more than three consonants in the consonant melody. They may have more than one vowel in the vowel melody. And the Cx-template with which the segments are associated does not conform to any one of the six given in (4.1). In fact, the

4.1 -- Template-Supplying Affixes

patterns of the Cx-skeleta are unpredictable even among the irregular verbs.

(4.15)

Some irregular verb roots:

CxxCxx	hooyii- 'send' 35; maawuu- 'play harp' 104; ʔiiʔaa 'seek a husband' 164-5; ʔooyoo 'be pregnant' 108
CxxCCxx	hiiççaa- 'tease' 104; diiʔyaa- 'haul away' 108; wiillaa 'prepare to depart' 109
CxxCxC	tiixal- 'talk' 120
CxCCxC	panwix- 'bring' 66; yaxwis 'quarrel reciprocally with one's spouse' 66; hoynil 'rally' 104
CxCCxx	damnaa- 'try' 118; wastuu- 'hurt' 84; hoýlii- 'hunt' 74; ʔohyoo- 'want' 104; walxuu 'pass' 35; paxyuu- 'scatter' 92; yoʔkii- 'return' 130
CxCxxCCxx	pitiilsii- 'teach' 66
CxCxCC	ʔoyoowx- 'pity' 89
CxxCxCCxx	wuusaynaa- 'whistle' 35
Cxx	xoo 'live' 148

Here we have two options: (i) Underlying forms may consist of a phonemic melody and each irregular verb undergoes a special 'irregular' template-supplying rule, distinct for each of the roots but in other ways like the rules in (4.12); or (ii) Underlying forms may be specified for both the melody and the Cx-template, the normal situation in languages like English. Under the second option, irregular verbs differ in a rather deep way from the regular verbs. Instead of being supplied with a template-triggering diacritic in underlying representation (as are the regular verbs), they exceptionally are represented with both the phonemic melody and the Cx-template. I suggest that the latter approach is the

4.2 -- The Templates

correct one for three reasons. First, if we adopt (i), we are forced to introduce several rules which apply to just one or two verbs. With (ii), however, rules supplying templates are general rules, triggered only by regular verbs and template affixes. Thus, with (ii) we have a formal distinction between regular and irregular verbs. Second, with (ii) we have a clear explanation of why irregular verbs simply do not undergo concatenation with template-supplying affixes: Template affixation consists of supplying a template and concatenation of a morpheme, but the rules supplying templates cannot apply, since a template is already present in underlying representation. The template-supplying rules of (4.12) are redundancy rules, inserting a template rather than a feature when no template is present. Finally, template-supplying affixes appear adjacent to regular verb stems (and underived noun stems) only.

Once an affix is attached, a template is inserted (triggered by the root or by the affix). No template supplying affixation follows.¹² If template affixes must supply a template and so are successfully concatenated only with strings having no template present, this distribution is accounted for. If template affixes may concatenate anywhere, this distribution is idiosyncratic. The proposal has four parts:

- regular verbs have rule-triggering diacritics;
- irregular verbs have underlying templates;

12. There is one exception to this, the suffix n 'mediopassive'. This suffix has no template slot, it is simply a phoneme. It affixes to biconsonantal root melodies only, and effectively turns them into triconsonantal roots. No template is supplied immediately after affixation of n. See section 4.4.1.

4.2 -- The Templates

- rules insert templates, optionally conditioned by certain affixes;
- template affixes must supply a template.

4.2 The Templates

In section 4.2.1, consideration of the surface forms of the six default templates in light of the processes motivated in Chapter 3 reveals the underlying templates assumed by the roots. In this discussion, Newman's classificatory system (also used in subsequent work, e.g. Kuroda 1967, Kisseberth 1969, Gamble 1978) is included so that readers familiar with the Yokuts literature may cross-reference more easily. In section 4.2.2, we examine the vowel and consonant melodies of regular verbs and see that representing the vowels and consonants on separate planes results in an explanation of the distribution of vowels when templates are supplied.

4.2.1 Neutral Templates

Given the rules in Chapter 3, examination of surface forms readily reveals the neutral templates of verbs. These patterns, which surface with neutral affixes, are equivalent to (4.5), that is, to the templates of the template pool.

Consider first the short roots (Cx \bar{C} and Cx $\bar{C}\bar{C}$). Figure (4.16) provides illustrations with both the aorist suffix (- $\bar{h}\bar{n}$) and the passive aorist suffix (- \bar{t}). In (4.16a), the verb root is biconsonantal and the surface form is always Cx \bar{C} , regardless of affix. (See footnote 8 regarding paradigms 4.16, 4.17, 4.18.)

4.2 -- The Templates

(4.16)

a. CxC roots

aorist	passive aorist	
cawhin	cawit	'shout'
şilhin	şilit	'see'
bokhin	bokit	'find'
dubhun	dubut	'lead by the hand'

In (4.16b), the verb pattern alternates between CxCiC (or CxCuC with Harmony 3.199) and CxCC (aorist and passive aorist respectively).

(4.16) cont.

b. CxCC roots

aorist	passive aorist	
?amichin	?amcit	'approach'
bilışhin	bilşit	'finish'
?ogilhin	?oglit	'emerge'
luKulhun	luKlut	'bury'

The root internal [i]/[u] in the aorist in (4.16b) is predictable by Epenthesis (3.203), (/?amc+hn/ ---> [?amichin]). Beyond Harmony (3.199), this is the only alternation. We may posit, then, that the (4.16a) verbs have a CxC neutral template and in (4.16b) verbs have a CxCC neutral template. (These are equivalent to Newman's IAl and IIAI roots respectively.)

As seen in (4.16), the short roots have an unvarying vowel pattern: The root vowel is always short. This contrasts with the long roots, whose vowels alternate between long and short depending on the syllabification (i.e. Rime Formation/Shortening 3.202, Epenthesis 3.203, Syncope 3.204). Lowering (3.197) provides evidence of underlying long vowels, since none of the root vowels surface as [+high]. In (4.17a) we see biconsonantal roots.

4.2 -- The Templates

(4.17)

a. CxxC roots

aurist	passive aurist	
lanhin	laanit	'hear'
hexhin	heexit	'be fat'
doshin	ḁousit	'report'
ḁomhun	ḁoomut	'destroy'

In (4.17a), there are no [+high] root vowels, even when a short vowel surfaces (as in the aurist where Rime Formation/Shortening 3.202 has applied). This is also true in the triconsonantal roots, illustrated in (4.17b). Here, the short vowel appears in the passive aurist but, again, it is [-high].

(4.17) cont.

b. CxxCC roots

aurist	passive aurist	
haatimhin	hatmit	'dance'
deeyilhin	deylit	'guard'
boowinhin	bownit	'trap'
?ookuḁhun	?okḁut	'depend on'

Compare ḁomhun, ḁoomut, and doshin, ḁoosit, ?ookuḁhun, ?okḁut and boowiinhin, bownit. Vowel Harmony (3.199) appears to apply after the [o]s in the first members of the pairs and not after the [o]s of the second members. The harmony that appears, however, is what is expected after an /u/, not after an /o/. This of course indicates that the [o]s which trigger harmony derive from /u/s via Lowering (3.197). The template vowels, then, are underlyingly long, lowered by Lowering (3.197) and shortened by Rime Formation/Shortening (3.202). Consequently we may posit CxxC and CxxCC neutral templates (corresponding to Newman's IA2 and IIA2 roots respectively). The derivations below illustrate these processes. (Justification for representing vowel and consonant melodies

4.2 -- The Templates

on separate planes is given in the following section, 4.2.2. The dots in the figure below indicate syllable boundaries and the circled slots show unsyllabified positions. Recall that Rime Formation/Shortening (3.202) leaves one vowel slot unsyllabified in a "CxxC" syllable, as with ?okcut below.)

(4.18)

underlying form, UAC (1.5) & Syllable Internal Spread (3.196)	<table border="0"> <tr><td>?</td><td></td><td></td><td>k</td><td>ć</td><td></td><td>h</td><td>n</td></tr> <tr><td> </td><td></td><td></td><td> </td><td> </td><td></td><td> </td><td> </td></tr> <tr><td>C</td><td>x</td><td>x</td><td>C</td><td>C</td><td>+</td><td>C</td><td>C</td></tr> <tr><td></td><td> </td><td>/</td><td></td><td></td><td></td><td></td><td></td></tr> <tr><td></td><td></td><td>u</td><td></td><td></td><td></td><td></td><td></td></tr> </table>	?			k	ć		h	n									C	x	x	C	C	+	C	C			/								u						<table border="0"> <tr><td>?</td><td></td><td></td><td>k</td><td>ć</td><td></td><td>t</td></tr> <tr><td> </td><td></td><td></td><td> </td><td> </td><td></td><td> </td></tr> <tr><td>C</td><td>x</td><td>x</td><td>C</td><td>C</td><td>+</td><td>C</td></tr> <tr><td></td><td> </td><td>/</td><td></td><td></td><td></td><td></td></tr> <tr><td></td><td></td><td>u</td><td></td><td></td><td></td><td></td></tr> </table>	?			k	ć		t								C	x	x	C	C	+	C			/							u				
?			k	ć		h	n																																																																						
C	x	x	C	C	+	C	C																																																																						
		/																																																																											
		u																																																																											
?			k	ć		t																																																																							
C	x	x	C	C	+	C																																																																							
		/																																																																											
		u																																																																											

Syllabification	<table border="0"> <tr><td>?</td><td></td><td></td><td>k</td><td>ć</td><td></td><td>h</td><td>n</td></tr> <tr><td> </td><td></td><td></td><td> </td><td> </td><td></td><td> </td><td> </td></tr> <tr><td>C</td><td>x</td><td>x</td><td>C</td><td>x</td><td>C</td><td>C</td><td>x</td><td>C</td></tr> <tr><td></td><td> </td><td>/</td><td></td><td></td><td></td><td></td><td></td><td></td></tr> <tr><td></td><td></td><td>u</td><td></td><td></td><td></td><td></td><td></td><td></td></tr> </table>	?			k	ć		h	n									C	x	x	C	x	C	C	x	C			/									u							<table border="0"> <tr><td>?</td><td></td><td></td><td>k</td><td>ć</td><td></td><td>t</td></tr> <tr><td> </td><td></td><td></td><td> </td><td> </td><td></td><td> </td></tr> <tr><td>C</td><td>x</td><td>(x)</td><td>C</td><td>C</td><td>x</td><td>C</td></tr> <tr><td></td><td> </td><td>/</td><td></td><td></td><td></td><td></td></tr> <tr><td></td><td></td><td>u</td><td></td><td></td><td></td><td></td></tr> </table>	?			k	ć		t								C	x	(x)	C	C	x	C			/							u				
?			k	ć		h	n																																																																									
C	x	x	C	x	C	C	x	C																																																																								
		/																																																																														
		u																																																																														
?			k	ć		t																																																																										
C	x	(x)	C	C	x	C																																																																										
		/																																																																														
		u																																																																														

Redundancy Rule (2.140a) Harmony	<table border="0"> <tr><td>?</td><td></td><td></td><td>k</td><td>ć</td><td></td><td>h</td><td>n</td></tr> <tr><td> </td><td></td><td></td><td> </td><td> </td><td></td><td> </td><td> </td></tr> <tr><td>C</td><td>x</td><td>x</td><td>C</td><td>..</td><td>C</td><td>C</td><td>x</td><td>C</td></tr> <tr><td></td><td> </td><td>/</td><td></td><td> </td><td></td><td></td><td> </td><td></td></tr> <tr><td></td><td></td><td>u</td><td></td><td>u</td><td></td><td></td><td>u</td><td></td></tr> </table>	?			k	ć		h	n									C	x	x	C	..	C	C	x	C			/									u		u			u		<table border="0"> <tr><td>?</td><td></td><td></td><td>k</td><td>ć</td><td></td><td>t</td></tr> <tr><td> </td><td></td><td></td><td> </td><td> </td><td></td><td> </td></tr> <tr><td>C</td><td>x</td><td>(x)</td><td>C</td><td>C</td><td>x</td><td>C</td></tr> <tr><td></td><td> </td><td>/</td><td></td><td></td><td> </td><td></td></tr> <tr><td></td><td></td><td>u</td><td></td><td></td><td>u</td><td></td></tr> </table>	?			k	ć		t								C	x	(x)	C	C	x	C			/							u			u	
?			k	ć		h	n																																																																									
C	x	x	C	..	C	C	x	C																																																																								
		/																																																																														
		u		u			u																																																																									
?			k	ć		t																																																																										
C	x	(x)	C	C	x	C																																																																										
		/																																																																														
		u			u																																																																											

Lowering (3.197)	<table border="0"> <tr><td>?</td><td></td><td></td><td>k</td><td>ć</td><td></td><td>h</td><td>n</td></tr> <tr><td> </td><td></td><td></td><td> </td><td> </td><td></td><td> </td><td> </td></tr> <tr><td>C</td><td>x</td><td>x</td><td>C</td><td>x</td><td>C</td><td>C</td><td>x</td><td>C</td></tr> <tr><td></td><td> </td><td>/</td><td></td><td> </td><td></td><td></td><td> </td><td></td></tr> <tr><td></td><td></td><td>o</td><td></td><td>u</td><td></td><td></td><td>u</td><td></td></tr> </table>	?			k	ć		h	n									C	x	x	C	x	C	C	x	C			/									o		u			u		<table border="0"> <tr><td>?</td><td></td><td></td><td>k</td><td>ć</td><td></td><td>t</td></tr> <tr><td> </td><td></td><td></td><td> </td><td> </td><td></td><td> </td></tr> <tr><td>C</td><td>x</td><td>(x)</td><td>C</td><td>C</td><td>x</td><td>C</td></tr> <tr><td></td><td> </td><td>/</td><td></td><td></td><td> </td><td></td></tr> <tr><td></td><td></td><td>o</td><td></td><td></td><td>u</td><td></td></tr> </table>	?			k	ć		t								C	x	(x)	C	C	x	C			/							o			u	
?			k	ć		h	n																																																																									
C	x	x	C	x	C	C	x	C																																																																								
		/																																																																														
		o		u			u																																																																									
?			k	ć		t																																																																										
C	x	(x)	C	C	x	C																																																																										
		/																																																																														
		o			u																																																																											

Surface ?ookuchun

?okcut

In (4.19) we have the final type of regular verb. The biconsonantal root is represented in (4.19a). It is disyllabic, unlike the CxC(C) and CxxC(C) roots. The second syllable varies between a long and short vowel, but is always [-high].

(4.19)

a. CxCxx roots

aorist	passive aorist	
lagaahin	lagat	'spend the night'
tiheehin	tihet	'get lean'
hoyoohin	hoyot	'name'
ꞑuyoohun	ꞑuyot	'urinate'

The first syllable of each root contains one of the four underlying vowels. The second syllable is a [-high] copy of the first syllable. The second syllable, then, contains an underlying long vowel, identical in quality to the vowel of the first syllable but lowered to [-high] by Lowering (3.197). Shortening (3.202) accounts for the long and short alternations in the second root vowel, shown below with derivations of ꞑuyoohun and ꞑuyot.

(4.20)

underlying form & UAC (1.5)	$\begin{array}{ccccccc} \acute{c} & & y & & & h & n \\ & & & & & & \\ C & x & C & x & x & + & C & C \\ & & & & & & & \\ & & u & & & & & \end{array}$	$\begin{array}{ccccccc} \acute{c} & & y & & & & t \\ & & & & & & \\ C & x & C & x & x & + & C \\ & & & & & & \\ & & u & & & & \end{array}$
Copy (3.195) & Syllable Internal Spread (3.196)	$\begin{array}{ccccccc} \acute{c} & & y & & & h & n \\ & & & & & & \\ C & x & C & x & x & + & C & C \\ & & & & / & & & \\ & & u & & u & & & \end{array}$	$\begin{array}{ccccccc} \acute{c} & & y & & & & t \\ & & & & & & \\ C & x & C & x & x & + & C \\ & & & & / & & \\ & & u & & u & & \end{array}$
Syllabification	$\begin{array}{ccccccc} \acute{c} & & y & & & h & n \\ & & & & & & \\ C & x.C & x & x.C & x & C & C \\ & & / & & & & \\ & u & u & & i & & \end{array}$	$\begin{array}{ccccccc} \acute{c} & & y & & & & t \\ & & & & & & \\ C & x.C & x & x & C & & C \\ & & / & & & & \\ & u & u & & & & \end{array}$

4.2 -- The Templates

Harmony (3.199)	$\begin{array}{cccc} \acute{c} & & y & & h & & n \\ & & & & & & \\ C & x.C & x & x.C & x & C \\ & & & & \\ u & u & / & u & u \end{array}$	$\begin{array}{cccc} \acute{c} & & y & & & & t \\ & & & & & & \\ C & x.C & x & x & C \\ & & & \\ u & u & / & u \end{array}$
Lowering (3.197)	$\begin{array}{cccc} \acute{c} & & y & & h & & n \\ & & & & & & \\ C & x.C & x & x.C & x & C \\ & & & & \\ u & o & / & u & u \end{array}$	$\begin{array}{cccc} \acute{c} & & y & & & & t \\ & & & & & & \\ C & x.C & x & x & C \\ & & & \\ u & o & / & u \end{array}$
Surface	duyoohun	duyot

In (4.20b) we see exactly the same contrasts in root vowel length and quality. The only differences are caused by the presence of a third root consonant.

(4.21) (=4.19 cont.)

b. CxCxxC roots

aorist

passive aorist

?agayhin
binethin
lowonhin
hudokhun

?agaayit
bineetit
lowoonit
hudookut

'pull'
'ask'
'attend a feast'
'straighten'

In (4.21), then, we posit roots with the CxCxx and CxCxxC neutral templates (Newman's IB and IIB respectively) and invoke the rules motivated in Chapter 3.

To summarize, I argue here that the neutral root templates in Yawelmani are the six templates listed in (4.5). The surface forms resulting from the short template, CxC(C), contrast with those resulting from the long template, CxxC(C), in two ways. First, the surface vowel in a short template root is always short (i.e. x) whereas with a long template it varies between long (xx) and short (x), the latter being due to Rime Formation/Shortening, (3.202). Second, the vowel in a short root may be [+high] or [-high], depending on its

4.2 -- The Templates

underlying melody. The vowel in a long root, on the other hand, is always [-high], due to Lowering (3.197), regardless of whether it surfaces as long or short. The disyllabic template is easily identifiable in the usual case in that it has two syllables (but recall Elision 3.205 and the examples in 3.132). The second vowel may be realized as long (CxCxx(C)) or short (CxCx(C)), depending again on Rime Formation/Shortening (3.202). The vowel in the second syllable is always [-high], regardless of its length and regardless of the value for [high] on the first syllable, although otherwise the vowels of the two syllables are of the same quality. The quality is again due to Lowering (3.197).

4.2.2 Consonant and Vowel Melodies

Verb stems consist of two or three consonant segments (including glides) and one vowel segment. We could posit two vowel segments in the verb melody and do away with the rule Copy (3.195). However, the non-copy account forces stipulation of /i/ as the epenthetic vowel (rather than letting the vowel be filled in by redundancy rules 2.140) and it makes accidental the fact that in all regular verbs given a CxCxxC template, the two vowels have the same underlying quality. With the copy account, the epenthesis rule is more concisely expressed and Copy (3.195) accounts for the vowels in the CxCxxC template having the same underlying quality.

Now consider what happens to a verb's melody when a template is inserted (by applying one of the rules in (4.12) according to the diacritic of the root in question). Arguments are presented here for representing the vowel melody and consonant melody on two independent planes. In (4.22a,b,c) we see the representations for the six root types, following neutral template insertion.

4.2 -- The Templates

(4.22)

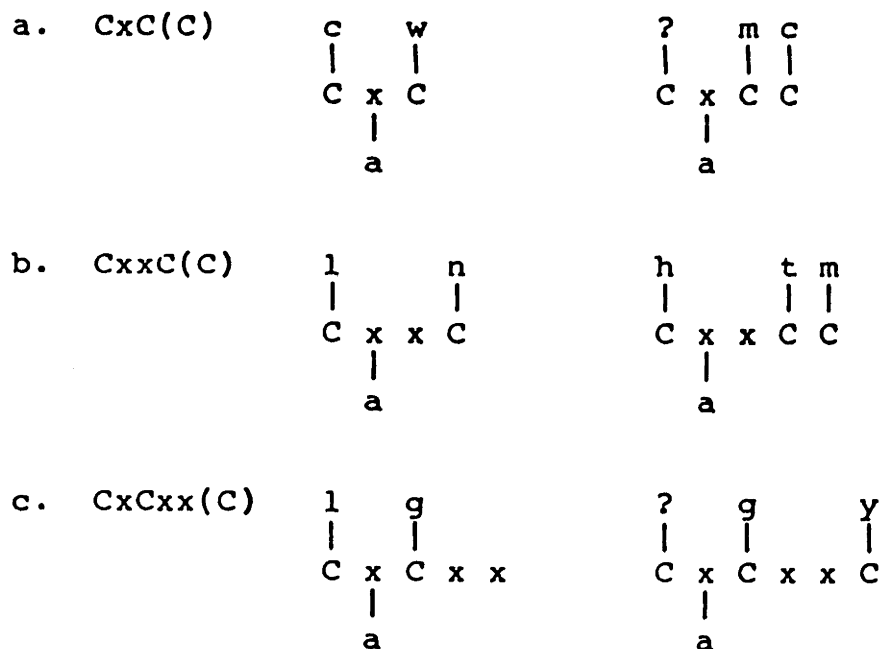

The linking seen in (4.22) follows the Universal Association Convention (1.5). As argued in Chapter 3, section 1 Yawelmani has a rule copying a linked vowel in the presence of a vacant syllable head, repeated below for convenience:

(4.23) (=3.195)

Copy

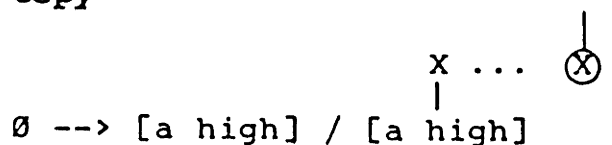

Below we see (4.23) applied to (4.22c).

(4.24) (=4.22 cont.)

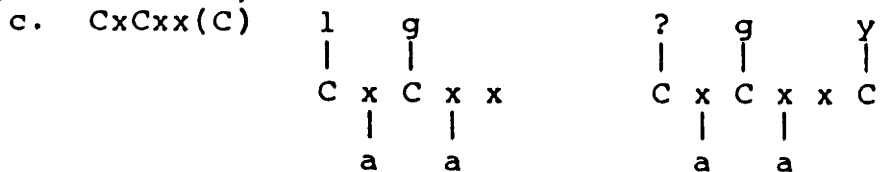

Another rule, Syllable Internal Spread (3.196) now applies. The rule is given in (4.25) and the derivation continues below.

4.2 -- The Templates

(4.25) (=3.196)

Syllable Internal Spread

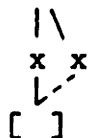

(4.22) cont.

c. CxCxx(C)

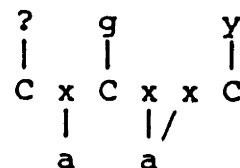
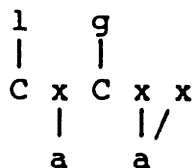

If consonants and vowels are on the same plane, there is an empirical problem. Certain template suffixes which provide the disyllabic template also provide a vowel for the second syllable, for example -d(aa) 'repetitive' in sudakdaahin 'often removed' 109 (< sudk +CxCxxC + d(aa) + hn). With vowels and consonants on separate planes, we have a straightforward account of these suffixes. The vowel in the suffix is unlinked in underlying representation and so associates by the Universal Association Convention (1.5) to the leftmost free x-slot. Copy (4.23) then copies the /a/.

(4.26)

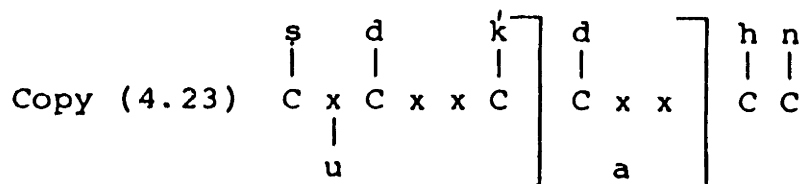
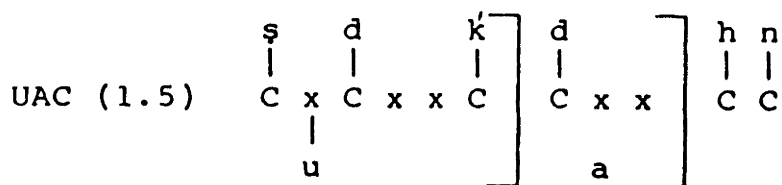

4.2 -- The Templates

SIS (4.25) $\left[\begin{array}{cccc} s & d & & k \\ | & | & & | \\ C & x & C & x & x & C \end{array} \right] \left[\begin{array}{cc} d & \\ | & \\ C & x & x \\ & a & \end{array} \right] \left[\begin{array}{cc} h & n \\ | & | \\ C & C \end{array} \right] \text{ ----> sudakdaahin}$

If, on the other hand, the vowels and consonants are on a single plane, suffixes like -d(aa) must trigger special rules to metathesize the final root consonant and the suffix vowel.

(4.27)

$\left[\begin{array}{cccc} s & u & d & k \\ | & | & | & | \\ C & x & C & x & x & C \end{array} \right] \left[\begin{array}{cc} d & a \\ | & | \\ C & x & x \\ & & \end{array} \right] \left[\begin{array}{cc} h & n \\ | & | \\ C & C \end{array} \right]$

metathesis

$\left[\begin{array}{cccc} s & u & d & a & k \\ | & | & | & | & | \\ C & x & C & x & x & C \end{array} \right] \left[\begin{array}{cc} d & \\ | & \\ C & x & x \\ & & \end{array} \right] \left[\begin{array}{cc} h & n \\ | & | \\ C & C \end{array} \right]$

copy

$\left[\begin{array}{cccc} s & u & d & a & k \\ | & | & | & | & | \\ C & x & C & x & x & C \end{array} \right] \left[\begin{array}{cc} d & a \\ | & | \\ C & x & x \\ & & \end{array} \right] \left[\begin{array}{cc} h & n \\ | & | \\ C & C \end{array} \right]$

This is a mechanical solution, but provides no understanding of the processes involved. There is a further conceptual problem. As shown in Chapter 3, some Yokuts dialects have a Copy (4.23) rule, others a Spread (3.8) rule. The Spread account is coherent only if vowel and consonant melodies are on independent planes. If the Copy dialects differ also by having consonant and vowel melodies on a single plane, then the dialects are fundamentally different, and this difference should manifest itself in a variety of ways. At this point, the only relevant difference I am aware of is the difference in Lowering (3.197), attributable simply to Copy (4.23) vs. Spread (3.8).

4.3 Templates Supplied to Verbs by Affixes

In this section, we do two things. First we establish that six templates are supplied by affixes. Then, we examine evidence which reduces this group of six to a set of three templates. Thus, we posit only three templates for the regular verbs, both in the affix-supplied set of templates and in the neutral set.

4.3.1 The Six Templates

In section 2 above, we saw that the affixes -(?)iixoo and -(?)iñay supply the short CxC(C) templates. Here we look at two more affixes, one which selects the long CxxC(C) templates and one which selects the disyllabic CxCxx(C) templates. Figure (4.28) illustrates the first case.

Inspection reveals that in (4.28) the suffix -(?)aa 'continuative' is fixed to a CxxC pattern with biconsonantal roots and to a CxCC pattern with triconsonantal roots.¹³ Here

13. Newman (1944: 110 and pc) points out that this affixation process is unproductive and that the forms in (4.28) probably do not occur in the language. It is clear from the text, however, that if this process did apply, the results found in the column headed "example" would be obtained. Curiously, the only affixes (there are two, (?)aa 'continuative' and aa 'consequent agentive') which supply the CxCC template are unproductive affixes. I have no explanation for this fact and assume it is accidental, not systematic. This conclusion is supported by the fact that the CxCC template shows up in the noun morphology.

4.3 -- Templates Supplied to Verbs

-(?)aa is followed by -hn 'aorist'.¹⁴ See footnote 8 regarding figures (4.28) and (4.30).

(4.28)

default template		supplied template	example
biconsonantal roots			
CxC	/caw/	CxxC	caaw [˙] aahin
CxxC	/cuum/	CxxC	coom [˙] aahin
CxCxx	/hoyoo/	CxxC	hooy [˙] oohin
triconsonantal roots			
CxCC	/ʔamc/	CxxCC	ʔam [˙] caahin
CxxCC	/diiyl/	CxxCC	dey [˙] laahin
CxCxxC	/biniit/	CxxCC	ben [˙] taahin

I argue that the CxxC(C) template has been inserted here. With biconsonantal roots, this is readily apparent: The vowel surfaces as long and [-high] (coom[˙]aahin, *cuum[˙]aahin). With the triconsonantal roots, we also see that high vowels surface as [-high] (dey[˙]laahin, *diy[˙]laahin; ben[˙]taahin, *bi[˙]ntaahin) despite their being short. The extra C-slot in the triconsonantal root creates the environment for Rime Formation/Shortening (3.202), which gives rise to the short [-high] vowels. The postulation of a long vowel template CxxCC with -(?)aa is thus motivated by the alternations in both vowel quality and quantity in a root like biniit- 'ask'. The derivation of ben[˙]taahin illustrates the application of these rules in conjunction with the rule inserting the templates.¹⁵

14. We ignore the alternations in the second stem consonant for the moment. These relate to the parenthesized glottal stop of the affix and are dealt with in detail in section 3.3 of this chapter.

15. The dot "." indicates a syllable boundary, the circled "x" indicates a slot not in a syllable.

4.3 -- Templates Supplied to Verbs

(4.29)

lexical entry for -(?)aa

(?)

x x

a

(4.30)

derivation of bentaahin

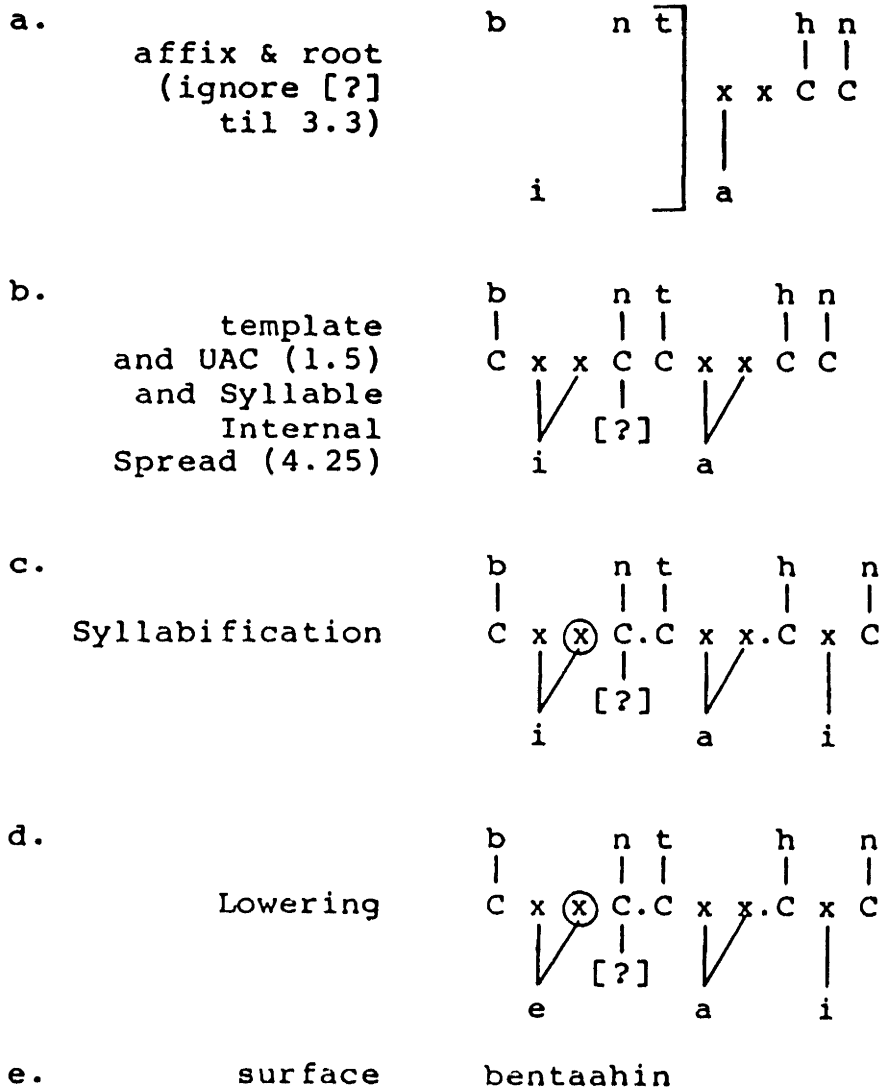

The CxxCC template for triconsonantal roots gives the right results when we employ independently motivated rules. If we

4.3 -- Templates Supplied to Verbs

assume that the template is CxCC, we must add a lowering rule which applies only in these triconsonantal forms and nowhere else.

Notice that the template for biconsonantal roots, CxxC, and the one for triconsonantal roots, CxxCC, differ only by the presence or absence of the third C-slot. This was also observed in section 2 where CxC and CxCC were paired. This pairing is persistent with the template affixes and can be explained by positing only the triconsonantal template (even for biconsonantal roots).

In (4.31) we observe the effects of affixation of a template affix triggering the CxCxxC template. The suffix is -wsiil 'reflexive/reciprocal adjunctive'. (Recall that /wsiil/ ---> [wse1] by Rime Formation/Shortening 3.202 and Lowering 3.197.)

(4.31)

default template		supplied template	example
biconsonantal roots			
CxC	/caw/	CxCxx	cawawsel
CxxC	/cuum/	CxCxx	cumowsel
CxCxx	/hoyoo/	CxCxx	hoyowsel
triconsonantal roots			
CxCC	/?amc/	CxCxxC	?amaaciwsel
CxxCC	/diiyl/	CxCxxC	diyeeliwsel
CxCxxC	/biniit/	CxCxxC	bineetiwsel

The biconsonantal roots in (4.31) all surface with a CxCx pattern. The second vowel is always [-high] (e.g. cumcwsol, *cumuwsol). This forces us to postulate that the underlying template has a long second vowel which undergoes Rime Formation/Shortening (3.202) and Lowering (3.197), illustrated in the following derivation.

4.3 -- Templates Supplied to Verbs

(4.32)

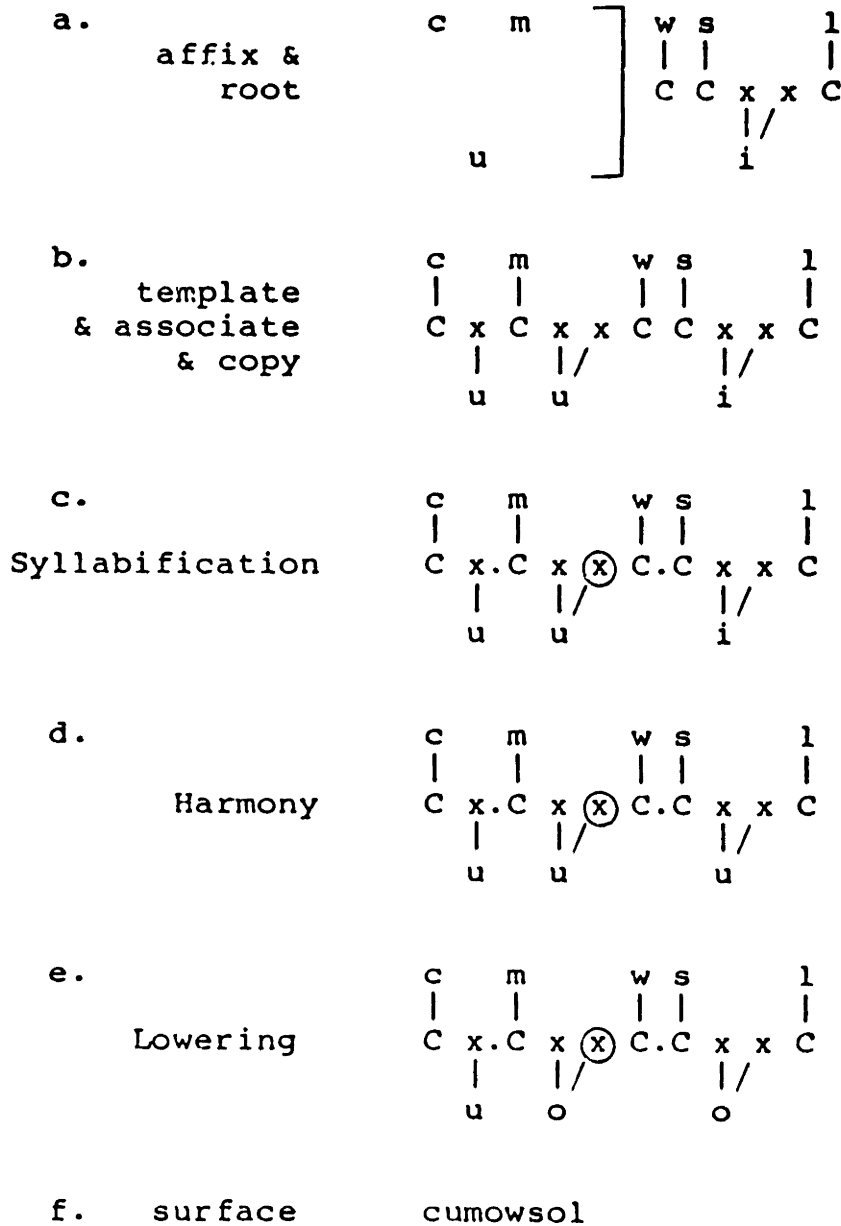

In (4.32c) we see the application of Rime Formation/Shortening (3.202) before the biconsonantal cluster /ws/ and in the word-final ...xxC sequence. In (4.32e) we see Lowering (3.197) applying to the underlying long vowels.

The triconsonantal roots surface with a CxCxxC pattern when -wsiil is affixed, with the expected [-high] long vowel.

4.3 -- Templates Supplied to Verbs

The vowel between the root final consonant and the suffix initial consonant cluster /ws/ is the epenthetic /i/ placed by Epenthesis (3.203). This epenthetic vowel 'protects' the long vowel of the second root syllable from being shortened by Rime Formation/Shortening (3.202):

(4.33)

	/d i y i i l + w s i i l/
syllabification	d i . y i i . l X w . s i i l
Lowering	e e e e
Surface	diyeeliswel

Again the bi- and triconsonantal templates differ from each other merely by the absence/presence of a final C-slot (although the rules in Chapter 3 render this minimal difference opaque). This pairing is the focus of the next section.

4.3.2 The Template Pool

Up to this point we have assumed that there are six templates, three biconsonantal and three triconsonantal. This forces the inclusion of some mechanism which selects the biconsonantal template with biconsonantal roots and the triconsonantal template with triconsonantal roots. Furthermore, assuming six templates does not capture the distribution of biconsonantal and triconsonantal templates with respect to each other: There is no affix which mixes template pairs (i.e. *Cx_C/Cx_xCC, *Cx_C/Cx_Cx_C, *Cx_xC/Cx_CC, etc., before a single affix). For example, a suffix like -(?)iixoo which selects a short biconsonantal pattern CxC selects the short triconsonantal pattern CxCC, not CxxCC nor CxCxC, etc. Following a suggestion by Malka Rappaport, I derive this pairing from supplying only the triconsonantal template, never the biconsonantal template, by the rules. It is not necessary to posit both biconsonantal and

4.3 -- Templates Supplied to Verbs

triconsonantal templates in Yawelmani, but only triconsonantal templates. Figure (4.34) illustrates the linking of the biconsonantal root caw- 'shout' with the three triconsonantal templates. (Copy, 4.23, has applied.)

(4.34)

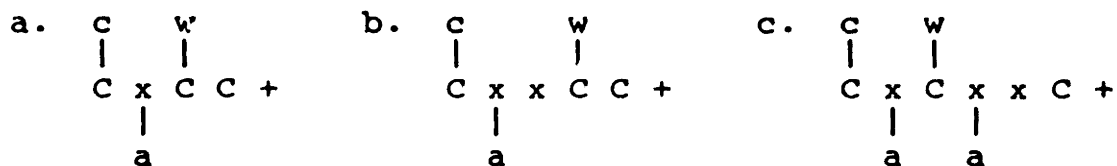

(Universal linkings, by the Universal Association Convention (1.5), are shown with solid lines. The result of Syllable Internal Spread (3.25) is represented with dotted lines. Affixes are omitted.)

In (4.34) the effect of a biconsonantal template is obtained merely by associating the consonants according to the Universal Association Convention (1.5). There is no rule of Consonant Spread so the third C-slot remains unassociated. The lack of spreading consonants follows from the Universal Association Convention (1.5) argued for in Pulleyblank (1983) for tone. If segments spread automatically (as in the conventions argued for in Goldsmith 1976, McCarthy 1979, and Halle and Vergnaud 1980, for example) we expect the non-occurring forms in (4.34').

(4.34')

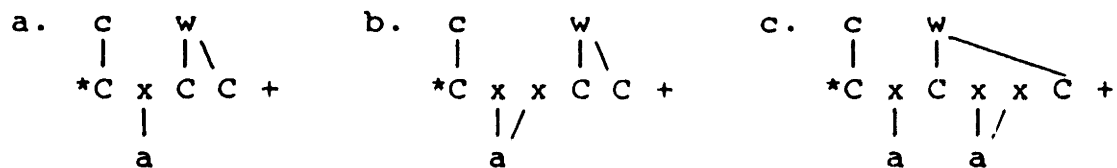

The assumption that segments do not automatically spread onto empty C-slots also accounts for the absence of geminates in Yawelmani. The only $C_i C_i$ sequences found are those which arise by concatenating a verb ending with C_i with an affix

4.3 -- Templates Supplied to Verbs

beginning with C_i.¹⁶

Once we acknowledge that segments do not spread, we can allow a biconsonantal root to associate with a triconsonantal template even when no floating segments exist. The consonant segments do not spread and so the third C-slot remains vacant. Vacant C-slots are deleted by rule. (Recall that X' means an unsyllabified slot. This rule must precede syllabification.)

(4.35)

Slot Deletion

(X') --> Ø

This holds whether the template is selected by an affix or supplied by the diacritic associated with the verb's lexical entry. Hence, we reduce the template pool to the three inserted by (4.12a-c).

(4.36)

template pool for Yawelmani

	\	\
XXXX	XXXXX	XXXXXX
CC	CxxCC	CxCxxC

4.3.3 Additional Support

The majority of template-supplying suffixes confirm the conclusion drawn above, that the template pool consists only of triconsonantal templates. These fall into two classes, those with a floating segment and those with a floating

16. This is not quite true. In children's speech, verbs are made by suffixing -wiy- 'do, say' to onomatopoeic syllables or other "proclitics", to use Newman's term. See Archangeli (1984).

glottal feature.

4.3.3.1 Floating Consonants

The paradigms in (4.37) give evidence for floating consonants. In (4.37a), the CxCC template is supplied by the affix -(h)atn 'desiderative' and in (4.37b) the CxCxxC template is supplied by the affix -(h)niil 'passive adjunctive'. What is of interest here is the alternations in suffix form. Both suffixes are [h] initial with biconsonantal roots but there is no [h] in the surface forms of triconsonantal roots. This is why these affixes are represented with an initial /h/ in parentheses. In (4.37a) -(h)atn is followed by -hn 'aorist' and in (4.37b), -(h)niil is followed by -aw 'locative'.

(4.37)

a. default template		supplied template		example
CxCC	caw	CxCC		cawhatinhin
CxxCC	cuum	CxCC		cuumhatinhin
CxCxxC	hoyoo	CxCC		hoyohatinhin
CxCC	?amc	CxCC		?amcathinhin
CxxCC	diiyl	CxCC		diiylathinhin
CxCxxC	biniit	CxCC		biniitathinhin
b. default template		supplied template		example
CxCC	caw	CxCxxC		cawahneelaw
CxxCC	cuum	CxCxxC		cuumhneelaw
CxCxxC	hoyoo	CxCxxC		hoyohneelaw
CxCC	?amc	CxCxxC		?amacneelaw
CxxCC	diiyl	CxCxxC		diiylneelaw
CxCxxC	biniit	CxCxxC		biniitneelaw

See footnote 8 regarding paradigms (4.37), (4.40), (4.41), (4.42).

4.3 -- Templates Supplied to Verbs

We can account for the [h]-Ø alternation very simply by positing a floating /h/ as part of the lexical entry for these two affixes, as seen in (4.38). A floating element is an element that is not linked in underlying representation to a skeletal position. The floating status is indicated by parentheses in the text and by the segment being circled in examples.

(4.38)



As shown in the derivations in (4.39), when a template is inserted the floating /h/ sometimes finds a vacant C slot and links (by the Universal Association Convention 1.5). If the root melody is biconsonantal as in (4.39a) there is a vacant slot available for association to which the /h/ links. On the other hand if the melody is triconsonantal as in (4.39b), there is no empty slot. The /h/ simply floats and so cannot surface.

(4.39)

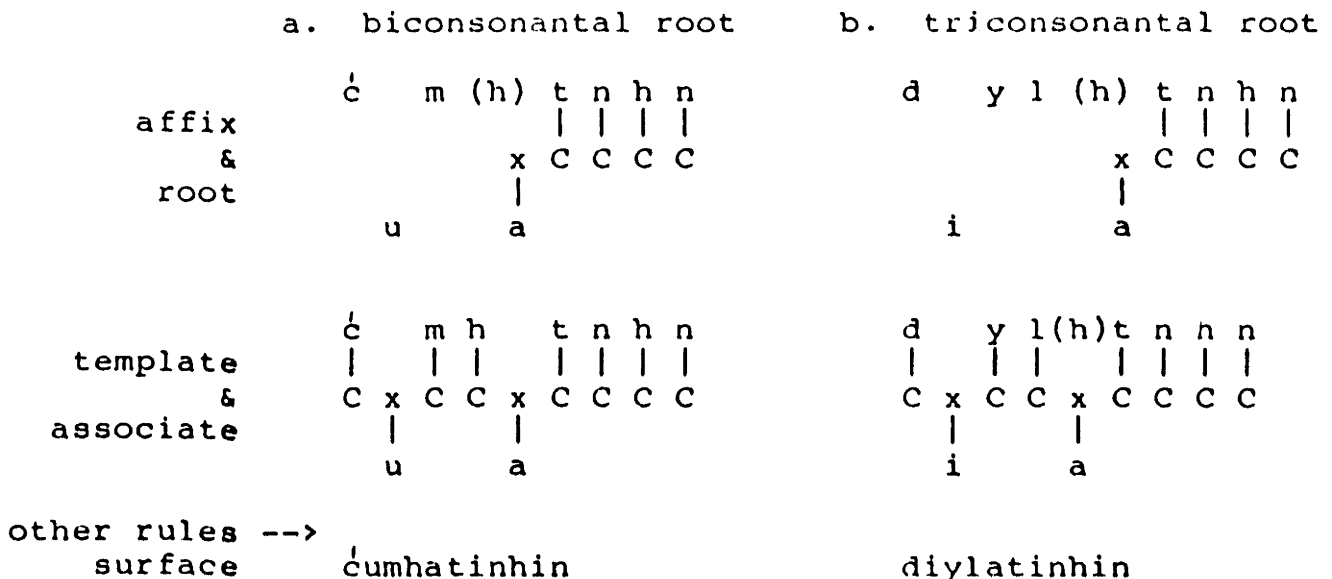

4.3 -- Templates Supplied to Verbs

In the second step of the derivation, the /h/ associates to the third C-slot in the template of the biconsonantal root because no C-segment has been associated with that slot. However, there is no vacant slot when a triconsonantal melody is involved. The /h/ cannot link.

There are other possible alternatives to the solution just outlined. One possibility is to suggest that bi- and triconsonantal templates are inserted with bi- and triconsonantal roots respectively and that a floating consonant 'projects' a C-slot for itself. This account includes in it the assumption that there are allomorphs of the affixes, -hatn/atn and -hniil/niil, the first allomorph in each case concatenating only with biconsonantal roots and the second only with triconsonantals. This solution is descriptively adequate but adds little to explanatory adequacy. It simply stipulates everything that happens.

Another possible account is to argue that /h/ is the "default consonant", i.e. that any empty C-slot is filled with an /h/. This means that the funny thing about -(h)atn and -(h)niil is that they select only triconsonantal templates while other affixes, e.g. -wsiil, select biconsonantal templates for biconsonantal roots and triconsonantal templates for triconsonantal roots. This account fails, however, when we consider yet another affix of the same type, -(i)(l)saa 'causative-repetitive', which surfaces as -(i)lsaa following biconsonantal roots and -(i)saa following triconsonantal roots.¹⁷ If /h/ is the "default consonant", we have no account of the distribution of /l/ with -(i)(l)saa.

17. The syllabification of (i)(l)saa is discussed in Chapter 3, section 2.5 and the association pattern is discussed in section 4.4.1 of this chapter.

4.3 -- Templates Supplied to Verbs

By the first alternative, however, we also have an account of -(i)(l)saa. The /l/ is floating in underlying representation, just as the /h/ is with the two suffixes in (4.38). If there is a vacant C-slot, then the /l/ links to that slot. If there are no empty C-slots, the /l/ continues to float and so never surfaces.

The floating-consonant account confirms the explanation for the pairing of templates given above. If only triconsonantal templates are supplied and never biconsonantal templates, this pairing is the only option.¹⁸

4.3.3.2 Floating Glottal Stop

There is another reason why we do not want to posit /h/ as the 'default' consonant, and that is because a vacant C-slot does not necessarily get filled, as the behavior of the 'floating glottal' shows. We now consider this phenomenon. A class of affixes which must have a triconsonantal template supplied, even with a biconsonantal melody, but for which, unlike the floating consonant affixes, the third C-slot does not necessarily get filled. Affixes which are marked here with an initial '(?)', e.g. -(?)iixoo 'durative' and -(?)aa 'continuative', show a four-way surface contrast. With some roots, the same distribution as the floating /h/ is observed. With biconsonantals, we see a [?] on the surface and with triconsonantal roots, we see only a vowel-initial suffix.

18. Noske (to appear) points out that in another dialect, there is an affix with two adjacent floating consonants. The leftmost of the two floaters surfaces only with biconsonantal roots, the rightmost surfaces with both bi- and tri-consonantal roots. (Noske accounts for these alternations in terms of syllabification, not in terms of floating consonants.)

4.3 -- Templates Supplied to Verbs

(4.40)

biconsonantal roots	dub 'lead by the hand'
	dubʔeexot dobʔaahin
triconsonantal roots	ʔogl 'emerge'
	ʔogleexot ʔogloohin

With other roots, the second stem consonant surfaces as glottalized, regardless of underlying representation and regardless of whether the root is bi- or triconsonantal.

(4.41)

biconsonantal roots	caw 'shout'
	caʷeexot caʷaahin
triconsonantal roots	diyl 'guard'
	diyleexot deylaahin

The four-way contrast is illustrated in (4.42) with the suffix (?)iixoo. There are two columns. The difference between the first column (4.42a,c) and the second column (4.42b,d) is that in the former, where the second root consonant (i.e. C2) surfaces as glottalized, this consonant is a sonorant. In (4.42b,d), C2 is [-sonorant].

(4.42)

biconsonantal roots	
a. caʷeexot	b. dubʔeexot
cuʷeexot	hixʔeexot
hoʷeexot	lagʔeexot
triconsonantal roots	
c. ʔamceexot	d. ʔogleexot
diyleexot	hatmeexot
biŋteexot	ʔagyeexot

As Newman says, "the floating glottal stop of suffixes...may infect only the second consonant of a stem, if

4.3 -- Templates Supplied to Verbs

that consonant is a nasal, semivowel, lateral, or glottal stop" (Newman 1944, p. 15). This 'infection' is seen in (4.42a,c). If the second consonant is not of this class, i.e. is [-sonorant], the glottal surfaces as the third consonant with a biconsonantal root (4.42b). It does not surface at all with a triconsonantal root (4.42d).

To understand the distribution of derived glottalized sonorants, it is helpful to understand more about glottalized consonants in Yawelmani. For this discussion, we abbreviate the glottal feature as '[+G]'.¹⁹ As is observed in Chapter 2, section 5, in Yawelmani there are a large variety of glottalized consonants, not all of them sonorants. Any [-aspirate, -sonorant, -continuant] is either [+G] or [-G] in underlying representation (i.e. /p, p̣; t, ṭ; ʔ, ʔ̣; k, ḳ; c, c̣; s, *ṣ; ʃ, *ʃ̣). The [+G, -sonorant] may be associated with any of the C-slots (i.e. C1, C2, or C3) in a template and there may be more than one glottalized consonant in a morpheme. In short, the distribution of glottalized non-sonorants is unrestricted.

(4.43)

Distribution of [+G, -sonorant] in roots

	biconsonantals		triconsonantals	
C1	ćuum 'destroy'		paʔaaʔ 'mourn'	
C2	boʔ 'find'		baʔn 'fall down'	
C3	--		ʃaalk 'wake up'	

The distribution of [+G, +sonorant] segments is limited to C2. [+G, +sonorant] segments may appear as underlying phonemes as well as derived ones, as the following minimal pair melodies

19. See Chapter 2, section 5 on the underlying representation of [+G], and of consonants in general.

4.3 -- Templates Supplied to Verbs

demonstrate (pointed out by S. Newman, pc).

(4.44) ʔoyx 'get rusty' ʔoyx 'give medicine'

Some other verbs with underlying [+G, +sonorant] segments are provided below.

(4.45)

ʔayk	'throw a lance'	kayeewis	'beg for mercy'
kan	'touch a goal'	giy	'touch'
taw	'throw'	ɕaw	'aim'

The distribution of underlying and derived glottalized sonorants is identical. Each may associate only to C2, the second C-slot in the template. Word initial sonorants are always [-G]. I suggest that we have in the default rules of Yawelmani a rule which applies both to underived and to derived forms alike to link a floating [+G] to the second C-slot in the template, if that slot is linked to a [+sonorant]. This means that an underlying glottalized sonorant is represented like a regular sonorant except there is a floating [+G] associated with the root.

(4.46) **Glottal Infection**

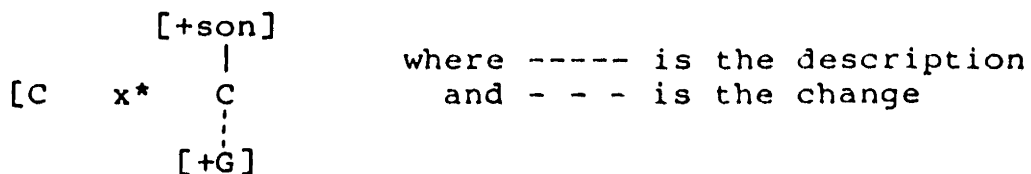

If there is no [+sonorant] in C2 position, the floating feature [+G] links to the first vacant C-slot. This will be C3 if the template is associated with a biconsonantal root. Otherwise the feature continues to float. As with /h/ and /l/, the floating feature does not surface.

[+G] must be on a plane independent consonants since [+G] does not link as predicted by the Universal Association

4.3 -- Templates Supplied to Verbs

Convention (1.5) if it is on the same plane as the consonant melodies. This results in the simplest analysis as well. If [+G] is on the same plane as the consonant melodies, then with a triconsonantal root either Glottal Infection (4.46) may not apply or, if it does apply, association lines must be crossed. To avoid this, and to keep [+G] on the same plane as the consonants, a metathesis rule is required. However, if [+G] is on a separate plane, we need no metathesis rule.

In (4.47) we see derivations involving [+G]. In (4.47a) we have a biconsonantal root and in (4.47b) a triconsonantal root, both with [-sonorant] C2 melodies.

(4.47)

Derivation with [+G] and [-sonorant] C2

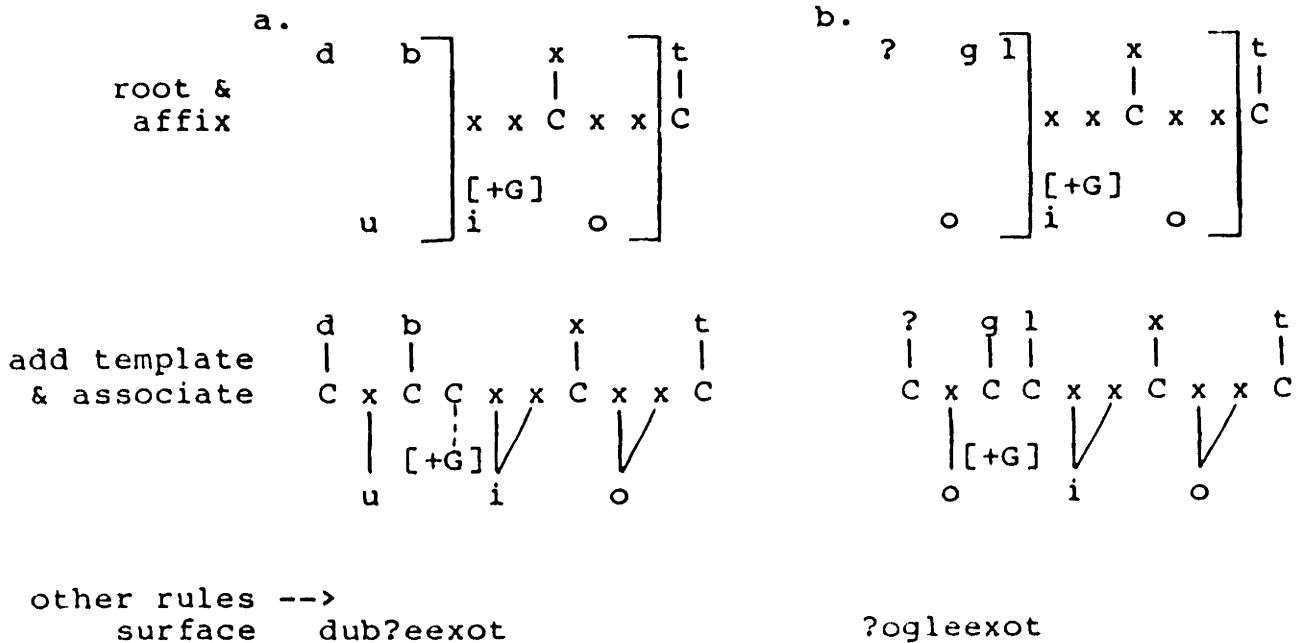

If the second root consonant is [+sonorant], the feature [+G] associates with C2 and the sonorant surfaces as glottalized. The appropriate derivations are illustrated in (4.48a,b) for bi- and triconsonantal roots respectively. The feature [+G] is able to associate in both cases.

4.4 -- Classification of Verbal Affixes

for consonants, and the third for the floating glottal feature. In the following section, we examine more evidence for the biplanar representation.

4.4 Classification of Verbal Suffixes

This section is a catalog of the various affixes which concatenate with verbs. It includes a description of a variety of oddball associations as well as the affixes with normal properties as discussed in the preceding sections.

Yawelmani is basically a suffixing language. Suffixes divide roughly into two categories, those which must adjoin directly to the verb root and those which may not adjoin directly to the verb root. Cutting across these two classes are two other categories, those suffixes which must be word-final and those which may not be word-final.

(4.49)

	adjoin to verb [verb]___	adjoin to affix ...affix]___
final ___]##	(?)inay 'gerundial' ic 'agentive'	hn 'aorist' (a)l 'dubitative'
non-final ___]affix	-in 'mediopassive' (h)atn 'desiderative'	ilaa 'causative'

The majority of affixes which are located directly after the verb root are ones which supply templates for the verb root. An exception is the mediopassive, discussed in section 4.4.1 below. Word final affixes either are tense or mood affixes or they change the verb into a noun or adverb of some sort. There are also a number of affixes which are not word final but which do not necessarily follow the verb root directly,

4.4 -- Classification of Verbal Affixes

for example st 'indirective', mx 'comitative', and ws 'reflexive/reciprocal'.

Finally, there are two "auxiliary" suffixes, xoo 'durative auxiliary' and iixoo 'consequent auxiliary', which must immediately precede the tense affix, and which may be followed only by a small set of the tense affixes. (The auxiliary xoo is discussed in Chapter 3, section 3, where the stress patterns of Yawelmani is considered.)

4.4.1 Regular Affixes

The following affixes concatenate with either the default verb root form or with a "verb root + affix" sequence. The first group (4.50) must be the last suffix in a sequence.

(4.50)

a. Tense/mood Affixes

-al	'dubitative'	120
-iin	'future' (surface -en)	128
-hn	'aorist'	122
-t	'passive aorist'	125
-ka	'imperative'	118
-nt	'passive future'	132
-xa	'precatative'	119

b. Gerund-forming affixes

-iini	'resultative gerundial'	137
-mi	'consequent gerundial'	134
-taw	'non-directive gerundial'	139
-tn	'passive gerundial'	138
-?as	'precatative gerundial'	140

c. Noun-forming affixes

-hanaa	'passive verbal noun'	149
-iwis	'reflex/recipr. verbal noun'	150

4.4 -- Classification of Verbal Affixes

It must be noted that the noun-forming affixes (e.g. in 4.50c) are not absolutely final since case suffixes follow. However, only case suffixes may follow, and no other suffixes. In this sense, they are final.

The list below consists of affixes which must not be the last affix in a sequence.

(4.51)

a.	-haꞥ	'desiderative-reflexive'	90
	-istaa	'indirective'	87
	-iwsaa	'reflexive/reciprocal'	89
	-laa	'causative'	91
	-mx	'comitative'	85
	-st	'indirective'	86
	-ws	'reflexive/reciprocal'	150
b.	-iyoo/iyuu	'prioritive'	116
	-xas	'exclusive'	117

The suffixes in (4.51a) all add an argument to the verb's subcategorization frames (causative, comitative, and indirective), or change the nature of an argument by restricting it to coreference with the subject (reflexive/reciprocal).

The next group of affixes are ones which must follow another affix. They cannot attach directly to a verb root. Those in (4.52a) are the last morpheme (barring case on nouns) in a sequence. In (4.52b) is a morpheme which can be neither the first nor the last in a string. The last two affixes, given in (4.52c), are the auxiliaries, restricted to the position immediately before the final suffix and allowing only a subset of the final suffixes in affixation.

4.4 -- Classification of Verbal Affixes

(4.52)

a.	-ls	'consequent adjunctive'	164
	-iċ	'agentive'	152-3
	-ihni	'agentive'	155-6
b.	-ilaa	'causative'	91
c.	-xoo	'durative auxiliary'	104
	-iixoo	'consequent auxiliary'	107

Finally, the mediopassive suffixes must be the first affix after a verb root and may not be the last affix in a string. These affixes have the effect of deleting an argument position from the subcategorization frame of the verb.

(4.53)

-in	'mediopassive'	84
-(n)	'mediopassive'	75

The second of these two is worth some discussion. It is affixed only to biconsonantal roots, and upon affixation the erstwhile biconsonantal root now behaves as a triconsonantal root.

(4.54)

hix (apply 4.12b)	hix + n (apply 4.12b)
'apply grease'	'get greasy' 75-6
xay (apply 4.12a)	xay + n (apply 4.12a)
'place, put'	'get into position, get placed' 75-6

Thus, when regular affixation takes place, say the affixation of ihni 'agentive', this /n/ fills up the third, otherwise vacant, C-slot in the template.

(4.55)

h		x+n	+	h	n					
C	x	x	C	C	+	x	C	C	x	x
	/								/	
	i					i			i	

'one who is getting fat' 76

4.4 -- Classification of Verbal Affixes

Furthermore, this derived triconsonantal root undergoes affixation with template-supplying suffixes just as the underived triconsonantals do. They are free to concatenate with those affixes which supply templates only to triconsonantal roots. This is shown in (4.56) with the affixes discussed below in 4.3, all of which supply a CxCxxC template and either concatenate **only** with triconsonantal roots (4.56a) or have different associations, depending on whether the root is bi- or triconsonantal (4.56b).²⁰

(4.56)

a.	hixeenic̣	'one who is getting fat'	76
	hixen?eey	'place, time, or instrument for getting fat'	76
b.	hixen?an	'is getting fat'	76
	hixen?aahin	'was gettin fat'	76

The above paradigm indicates that the affixation of /n/ precedes all other types of affixation, including rules supplying templates.

This concludes the discussion of affixes which do not provide templates for the verb root. We now turn to the other affixes for verbs in Yawelmani.

4.4.2 Template-Supplying Affixes

About half of the template affixes are regular in that once the template is supplied, the phonological rules of Chapter 2 and the rules of the preceding sections specific to

²⁰. These association patterns are discussed in this chapter, in section 4.4.4.

4.4 -- Classification of Verbal Affixes

template-supplying affixes account for their surface patterns.²¹ These affixes are listed below in (4.57).

(4.57)

Regular template affixes

supplying	(h)atn	'desiderative'	114
CxCC	(?)aa	'consequent agentive'	157
	(?)aas	'habitual agentive'	160
	(?)iixoo	'durative'	107
	laa	'causative'	91
supplying	ic	'agentive'	152
CxCxxC	wsiil	'reflex/recipr. agent'	166-7
	(h)niil	'passive adjunctive'	166
	?(i)iy	'consequent adjunctive'	162

There are also several unproductive or rarely occurring template affixes. These also follow the rules of the preceding sections.

(4.58)

Rare/unproductive template affixes

supplying	(?)ic'	'agentive'	154
CxCC	(a)ac'	'consequent adjunctive'	165
	lii	'continuative'	111
supplying	(?)aa	'continuative'	110
CxxCC	aa	'consequent agentive'	139

Finally, there are template affixes which are productive and whose behavior merits some comment. These are the topic of the following sections. They break into two classes: Those which only concatenate with a definable class of verbs and those which have an odd spreading or linking pattern.

21. There are a few template-suppliers not discussed here. They create stems which are then suffixed with wiy...

4.4 -- Classification of Verbal Affixes

4.4.3 Template-Supplying Affixes with Limited Application

The affixes discussed in this section are marked in some way such that they concatenate only with the appropriate verb roots. Generally this is defined by the number of consonants in the root melody. One sub-group of the template-supplying affixes with limited application concatenates only with triconsonantal roots: These are listed in (4.59).²²

(4.59)	daa	'repetitive'	108-9
	(?)ii	'causative'	93
	(?)anaas	'desiderative agentive'	162

There is also an affix which concatenates only with biconsonantal roots, given in (4.60).

(4.60)	aalaa	'causative'	91
--------	-------	-------------	----

Except for daa and (?)ii (as noted in footnote 22), these suffixes are abnormal only in that the roots to which they may affix are restricted by the number of consonants in the melody. A similar, although slightly varied, restriction is found in the formation of deverbal nouns. The chart in (4.61) shows one way in which the six root types form nouns.²³

22. The first two in (4.59), daa and ii also exhibit interesting linking, discussed in the following section.

23. Other ways of forming nouns from verbs are by affixation, both template-supplying and regular concatenation. These affixes are catalogued in the present section.

4.4 -- Classification of Verbal Affixes

(4.61)

Deverbal noun formation (no affixation)

biconsonantals		triconsonantals							
verb	noun	verb	noun						
CxC	CxC	CxCC	CxCC						
<table border="1" style="display: inline-table; vertical-align: middle;"><tr><td>CxxC</td><td>CxC</td></tr><tr><td></td><td>CxxC</td></tr></table>	CxxC	CxC		CxxC		<table border="1" style="display: inline-table; vertical-align: middle;"><tr><td>CxxCC</td><td>CxCC</td></tr></table>	CxxCC	CxCC	
CxxC	CxC								
	CxxC								
CxxCC	CxCC								
<table border="1" style="display: inline-table; vertical-align: middle;"><tr><td>CxCxx</td><td>CxCxxC</td></tr><tr><td></td><td>n</td></tr></table>	CxCxx	CxCxxC		n		CxCxxC	CxCxxC		
CxCxx	CxCxxC								
	n								

The forms which alter are boxed. An analysis which would parallel in templates the description given in Newman (1944:144) treats this distribution as CxCC and CxxCC roots taking a CxCC template, optionally with CxxC roots, and that CxCxx roots affix n. An alternative is to say that CxxCC roots take a CxCC template (optionally with the biconsonantal form) and the other two roots have no change in template form. CxCxxC roots, however, do take an affix: A floating n (i.e. a phoneme /n/ with no skeletal slot). This n will link to the empty slot when a biconsonantal root is inserted but there is no place for it with triconsonantal roots.

(4.62)

noun	verb	
CxCC	CxCC	no change
caw-a 'shout-O'	< caw 'shout'	145
taxn-a 'coming-O'	< taxn 'come'	145
CxxCC/CxCC (2Cs)	CxxCC	change optional
CxCC (3Cs)		with biconsonantals
?uṭa 'stealing-O'	< ?uṭ 'steal'	145
?oṭ 'stealing-O'		145
?idil 'hunger-S'	<?iidl 'get hungry'	145

4.4 -- Classification of Verbal Affixes

CxCxxC + n	CxCxxC	add floating /n/
ʼcuyon 'urine-O'	< ʼcuyuu 'urinate'	148
hiwet 'journey-S'	< hiwiit 'walk'	145

Notice that although the distribution of templates must be listed with the deverbal nouns, and that the distribution of bi/triconsonantal roots must be diacritically marked with the affixes in (4.59, 60), neither group constitutes a counterexample to the template solution. Each employs templates, in fact each employs the same templates that are necessary elsewhere in the language; and the rules motivated in Chapter 3 operate regularly.

For the next group of affixes, however, we must posit somewhat different underlying representations or add some association rules.

4.4.4 Template-Supplying Affixes with Interesting Associations

There are five template-supplying suffixes that fit into this category, four providing a CxCxxC template and one giving the CxCC pattern. Two, (i)(l)saa and d(aa) have straightforward representations, given that the consonant and vowel melodies must be represented on separate planes. Two others, (?)ii and ?aa, require special rules. The last, (?)iḥay, provides evidence for some suffix vowels being unlinked in underlying representation.

(4.63)

Template-supplying affixes with odd associations

supplying	(i)(l)saa	'causative-repetitive'	94
CxCxxC	d(aa)	'repetitive'	109
	ii	'causative'	93
	?aa	'durative'	98
supplying	(?)iḥay	'contemp. gerundial'	136
CxCC			

4.4 -- Classification of Verbal Affixes

Each of the affixes in (4.63) provides additional support for representing the consonants and vowels on separate planes.

4.4.4.1 (i)(l)saa 'causative-repetitive'

Let us begin with (i)(l)saa: Examples are given below.

(4.64)

a.	?uṭoolsuhnu?	<?uut 'play harp' 'one who makes s.o. play the harp repeatedly'	94
b.	nineelsaahin	<ninii 'be still' 'got s.o. to keep still'	95
c.	da?eelsa?	<da?l 'bring to life' 'will bring s.o. to life'	95
d.	?opeetsaanit	<?opoot 'get up' 'will be made to get up repeatedly'	95
e.	?ugoonsaa/-	<?ugn 'drink' 'cause to drink rep.'	33
f.	pa?eetsaa/-	<pa?t 'fight' 'cause to fight rep.'	33

There are three points of interest. There is an /l/ which surfaces with biconsonantal roots and not with triconsonantal roots. Also, the second syllable contains the vowel /ii/ (lowered to [ee] by Lowering (3.197)). Finally, the second syllable is aberrant here in that it does not undergo Shortening (3.202).

Examination of (4.64a,b) leads us to suspect a CxCC template with a suffix of the form iilsaa. However, (4.64c,d) belies this: The root final consonant surfaces in place of the /l/ of the suffix. With a CxCC template we would predict *?opteelsaanit, not the correct ?opeetsaanit. The /l/-∅ alternation is like the /h/-∅ alternation discussed in section 4.3.3 (this chapter): Here we may posit a floating consonant /l/ which associates with an empty C-slot once the root melody has been inserted.

4.4 -- Classification of Verbal Affixes

(4.67)

```
      1  s
        |
        C x x  Apply 4.12c
        |
      i   a
```

The lack of Shortening (3.202) is discussed in Chapter 3, section 2.5.

4.4.4.2 d(aa) 'repetitive'

The second affix to consider is d(aa) 'repetitive'. Recall from the previous section that this affix concatenates only with triconsonantal roots. Examples follow.

(4.68)

- | | | | | |
|----|-------------|---------|------------------------------|-----|
| a. | ʔipaṭdaalis | <ʔipt | 'lose' | |
| | | | 'that which has been lost | |
| | | | many times-S' | 109 |
| b. | sodoxdoʔ | <sodx | 'throw' | |
| | | | 'will throw s.t. repeatedly' | 109 |
| c. | ṣudaḱdaahin | <ṣuduuk | 'remove' | |
| | | | 'often removed' | 109 |

We see that the verb root assumes a CxCaC pattern before the suffix daa. Thus, there are two points of interest with daa: How does the /a/ get into the second x-slot and what template is supplied (since there are no long vowel/short vowel alternations)? To account for the /a/, I follow the analysis of (i)(l)saa. Once again, an underlying floating vowel does not associate until the root melody is inserted because the template (to which the floating vowel may associate) is not inserted until after the affix and stem are concatenated. Unlike (i)(l)saa, with d(aa) the floating vowel is the only vowel of the affix:

4.4 -- Classification of Verbal Affixes

In (4.70c), Copy (4.23) and Syllable Internal Spread (4.25) apply. The rules from Chapter 3 shorten the long vowel (3.202) and epenthesize /i/ (3.203) as seen in (4.70d).

(4.70) cont.

d.	s	d	k	d	h	n
Syllabification	C	x.C	x x	C.C	x x.C	x C
			/		/	
		u	a		a	

e. surface şudakdaahin

The rules of Copy and Syllable Internal Spread are the rules seen before, (3.23) and (3.25) respectively.

4.4.4.3 (?)ii 'causative'

Let us now look at another type of peculiar association. (This affix is also discussed in Chapter 3, section 2, with respect to syllabification. See figure 3.84.) The affix (?)ii 'causative' also combines only with triconsonantal roots. In the examples below, notice the alternations in the second syllable. (These forms are all found in Newman 1944, p. 93.)

(4.71)

moyo?neenit	< mooyn	'will be made tired'
moyoonet	< mooyn	'was made tired'
hubu?şom	< hubş	'having made s.o. choose'
biniitihni?	< biniit	'one who makes s.o. ask'

The second syllable alternates occur in free variation, according to Newman (1944, p. 93). What is interesting is that the long vowel is not lowered in biniitihni? (*bineetihni?). I suggest here that the glottal stop is associated by rule with the fifth skeletal slot in the template. A late rule optionally spreads the vowel (and deletes the glottal stop). The template then is CxCxC.

4.4 -- Classification of Verbal Affixes

Notice that this solution goes through only if we assume that the glottal stop is on a tier independent of the other consonants. If it is on the same tier as the other consonants, we must also have a metathesis rule so that glottal stop surfaces between the two stem-final consonants. In (4.72) we see the glottal association rule and in (4.73) a derivation.

(4.72)

Glottal Association

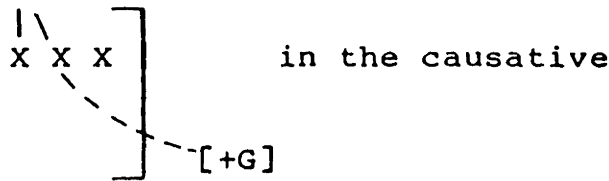

(4.73)

A derivation with (?)ii 'causative'

- a. melody & affix & associations including (4.72)
- | | | | |
|---|---|---|---|
| m | y | n | t |
| | | | |
| C | x | C | x |
| | | | |
| o | o | ? | i |
- b. Copy (4.23) and Universal Association Convention (1.5)
- | | | | |
|---|---|---|---|
| m | y | n | t |
| | | | |
| C | x | C | x |
| | | | |
| o | o | ? | i |
- c. syllabification and lowering
- | | | | |
|---|-----|---|-----|
| m | y | n | t |
| | | | |
| C | x.C | x | x.C |
| | | | |
| o | o | ? | e |
- d. SR moyo?net

The optional rule is given in (4.74) and the derivation of (4.73) is continued in (4.75) (where [+G] stands for [+constricted]).

4.4 -- Classification of Verbal Affixes

(4.74)

Optional Spread Rule

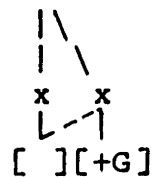

where ----- is description
and - - - is change

(4.75)

apply (4.74) to (4.73)

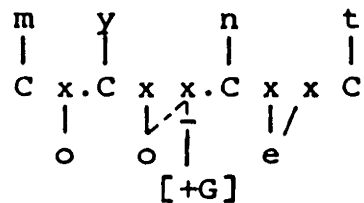

SR moyoonet

Glottal Association (4.72) applies before Lowering (3.197) and so Lowering does not apply. Consequently we derive forms like biniitihni?, *bineetihni?.

4.4.4.4 ?aa 'durative'

The last affix to be discussed is ?aa 'durative'. This may be followed only by nt 'passive future/present', t 'passive aorist', hn 'aorist', or n 'present'.²⁴ The associations and template are of particular interest here because they are so strange.

The template selected is unequivocally CxCxxC, as shown below:

24. Newman (1944:9) decides because of the unproductiveness that the combinations of ?aa with the four suffixes listed above are four different affixes. These ?aa... suffixes supply one template and they have the same aberrant associations regardless of their internal structure, which suggests that these are actually combinations with a single ?aa. Otherwise this distribution is accidental.

4.4 -- Classification of Verbal Affixes

(4.76)

tanaa?aaahin	< taan	'had gone'	98
ʔoyox?oohin	< ʔoyx	'had gotten rusty'	98
goʔoo?ot	< gooʔ	'being overtaken'	102
koʔoo?oonit	< koʔ	'will be thrown at'	102

When we look at roots with /i/ or /u/ as the underlying vowel, however, we see the association of /a/ is indeed curious. With biconsonantals, /a/ spreads, as it did with daa 'causative-reflexive' above. With triconsonantals, on the other hand, it does not. Compare below.²⁵

(4.77)

hiṣaa?aaahin	< hiṣ	'were getting ripe'	98
woʔoy?aaahin	< wuuʔy	'was falling asleep'	98
tihaa?an	< tihii	'is getting lean'	101
ʔilew?an	< ʔiilw	'is blooming'	101
ʔuyaa?at	< ʔuy	'is being shot at'	102
binet?at	< biniit	'is being asked'	102
ʔuṭaa?aanit	< ʔuut	'will be stolen'	102
ʔukoʔ?aanit	< ʔuukʔ	'will be depended on'	102

The representations of the glottal stop with biconsonantals and triconsonantals are contradictory. With biconsonantals, the glottal stop must be on a tier separate from the vowels so that the affix vowel /a/ is able to dock on the second syllable head in the template, as seen in (4.78a). With triconsonantals, we want the glottal stop to be on the same tier as the vowels, so that the affixal vowel can not dock leftward, seen in (4.78b).

25. The [o] in the first syllable of woʔoy?aaahin is discussed below shortly as well as in Chapter 3 section 1.

4.4 -- Classification of Verbal Affixes

c. Copy (3.23) and Spread (3.25)

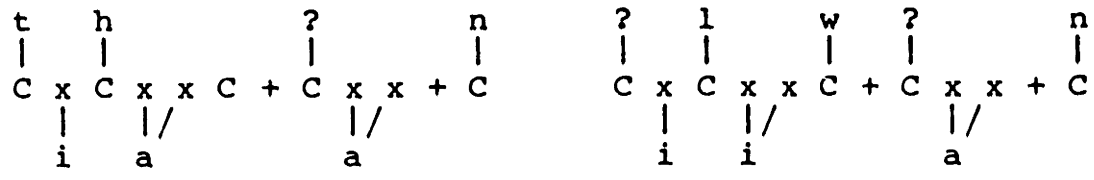

Notice that when Durative Delink (4.79) applies, the Universal Association Convention (1.5) blindly relinks the vowel to the slot just vacated. However, as noted in Pulleyblank (1983), this is not possible:

(4.81)

Universal Convention Blocking

A universal convention is blocked from applying to the output of a rule in the event that the result of application of that convention is identical to the input to the rule.

After Durative Delink (4.79) applies in (4.81b), relinking the /a/ is blocked by the Blocking Principle (3.81), until after some other rule, here Copy (4.23), applies.

Another possibility is to represent ?aa with both /?/ and /a/ on the same plane. Both bi- and triconsonantal roots then have the following representation:

(4.82)

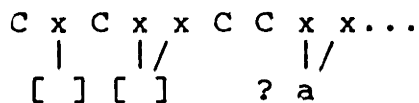

We then relate the alternations in (4.78a,b) to an optional rule that Newman notes (1944. p. 16-17):

"When either of these consonants [i.e. /h/ or /?/ -- DA] occurs medially in a stem, a following strong vowel [i.e. a long [-high] vowel -- DA] will, so to speak, break through the medial h or ? and influence the preceding vowel to become strong assimilated; i.e., the first vowel assumes the quality but not the long quantity of a genuinely

4.4 -- Classification of Verbal Affixes

strong vowel."

We observe this in wo?oy?aahin (<-- wu?ooy?aahin <-- wu?uuy+?aa+hin, with the application of the rules from Chapter 3). However, except for the ?aa forms, this does not happen when the vowels are of different qualities and so associated to distinct matrices, as shown in (4.83).

- (4.83)
 tanaa?ey 'that which was gone/footprint-OBJ' 104
 (< taan 'go' +?iiy 'consequent adjunctive')
 *tanee?ey

What we have seen here is that there are two types of aberrant associations: First, there are normal associations stemming from floating consonants and vowels in the underlying representation (e.g. (i)(l)saa, d(aa)). Secondly, there are aberrant associations related to the glottal stop. One weakness in the analysis presented here, is the number of bizarre rules relating directly to /?/. We have (4.46), (4.72), and (4.74), repeated below.

- (4.84) (=4.46)
 Glottal Infection

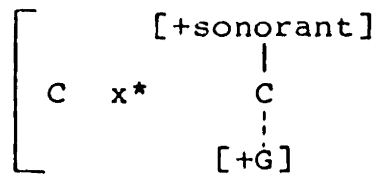

- (4.85) (=4.72)
 Glottal Association

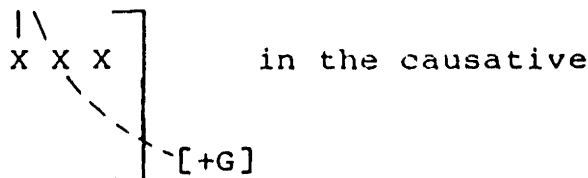

4.4 -- Classification of Verbal Affixes

(4.86) (=4.74)

Optional Spread

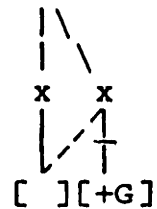

I have been unable to relate these rules to each other in any way, although Optional Spread (4.86) may be a special case of Syllable Internal Spread (3.25).

These glottal-related rules do not detract from the main point made here, that some affixes determine the Cx-template of the verb root in Yawelmani while other affixes do not. In the latter case, a neutral template, determined by the root, is supplied for the root.

4.4.4.5 (?)inay 'contemporaneous gerundial'

The CxCC template is supplied by (?)inay:

(4.87)

a.	dub?uñay	<dub	'while leading by the hand'	136
b.	dos?iñay	<doos	'while reporting'	136
c.	lihmiñay	<lihm	'while running'	136

Since this suffix has a floating glottal stop, if the second consonant is [+sonorant], the following patterns are derived:

(4.87) cont.

d.	pañiñay	<panaa	'while arriving'	136
e.	cowiñay	<coow	'while grasping'	137
f.	hiwtiñay	<hiwiit	'while walking'	136
g.	tañiñay	<taan	'while going'	136

As noted in Chapter 3, section 2.5, the biconsonant roots with sonorants as the second consonant optionally undergo Syncope (3.204):

4.5 -- Classification of Noun Morphology

(4.87) cont.

a.	paḥniy	<panaa	'while arriving'	136
b.	downiy	<coow	'while grasping'	137
c.	tāniy	<taan	'while going'	136

The import of the alternations here are discussed in Chapter 3, section 2.

4.5 Classification of Noun Morphology

The affixes which attach to nouns can be divided into two groups, those which are case affixes (marking subject, object, indirect object, possessive, ablative, and locative) and those which are not. Case affixes are discussed in section 5.1, the others in sections 5.2, 5.3, and 5.4.

Noun affixation (i.e. affixation on nouns, as opposed to verb affixation, or affixation on verbs) deepens our understanding of certain phenomena in Yawelmani. In section 5.2, two facets of template-supplying affixation are considered. We examine cases where the templates differ in pattern depending on the number of consonants in the noun root (three, four, or five). The means of collapsing these templates is as with the verbs: A single template, with all alternations following from the rules in Chapter 3. We also examine some apparent counter-examples to the claim that only items with no underlying template are subject to template affixation, and see that the claim is still tenable.

In section 5.3, floating melody units are discussed. A floating glottal feature and floating consonants (see with

4.5 -- Classification of Noun Morphology

verbs in section 3.3 of this chapter), and floating vowels are all exemplified.

The floating glottal feature and the floating consonants both behave with nouns as they do with verbs. The floating vowel, seen in the discussion of figures (3.53) and (3.52), serves as a trigger for vowel harmony. Thus, the formalization of the rule of vowel harmony can not make reference to skeletal slots, at least with respect to the trigger. As argued in Chapter 3, section 1, this forces a coplanar representation of the vowel-feature plane, rather than biplanar with some vowel features on one plane and other vowel features on another plane.

(4.88) (=3.199)

Coplanar Harmony

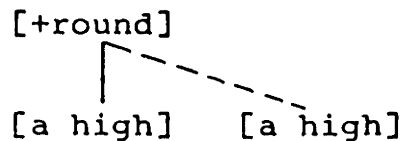

The representation in (4.88) captures the intuition that vowel harmony is a process changing relations between features only.

Finally, in section 4, a catalog of all affixes attaching to nouns is provided, divided between those which make verbs (4.5.4.1) and those which make nouns (4.5.4.2). Some discussion is presented of the affixes not mentioned elsewhere in the chapter. Primarily, this section is a translation of Newman's data into the representations employed here.

In discussing the verb-creating affixes, we see that affixes which make verbs from nouns are almost exclusively template-supplying affixes, and the templates they supply are elements of the template pool observed above,

4.5 -- Classification of Noun Morphology

(4.89)

CxCC CxxCC CxCxxC

This does not hold exactly for noun-creating affixation. We return to the template pool in 4.5.4.3.

4.5.1 Case

There are six distinct case affixes in Yawelmani:

(4.90)

S = Subject	∅, X
P = Possessive	in
O = Object	∅, X, in
IO = Indirect Object	ni, XXni
A = Ablative	nit, XXnit
L = Locative	w

The quality of the vowel which fills the empty slots above, and in the slot epenthesized before w, is determined by the noun itself, and is either /i/ or /a/.

The form of the case affixes depends on the syllabic template of the right edge of the noun stem. There are four types of noun-final syllable structure, CC], Cxx], CxC], and xxC], i.e.

X X	X X X	X X X	X X X
	\		\

We examine each in turn, then consider the form as a group.

4.5.1.1 CC]-Final Nouns

The mark of this group is CxC]## in Subject and CC]... elsewhere.

4.5 -- Classification of Noun Morphology

(4.91)

		'one who is made to sew'		'two'	
S		biwiineelis		bonoy	
P		biwiinelsin		bonyin	
O		biwiinelsi		bonyo	
IO		biwiinelseeni		bonyooni	
A		biwiinelseenit		bonyoonit	
L		biwiinelsiw	189	bonyow	194
		(Newman's IIA)		(Newman's IIBc)	

If the case affixes are as in the first column of (4.92), the derivations are straightforward. The first arrow indicates the processes of concatenation and syllabification (here epenthesis). The second arrow indicates the process of association. I assume that the noun bonoy 'two' has two vowels /o/ in its vocalic melody. The second /o/ then associates to both the epenthetic slot and the X's of the indirect object and ablative affixes.

(4.92)

S	Ø	bony + Ø	-->	bonXy	-->	bonoy
P	in	bony + in	-->	bonyin		
O	X	bony + X	-->	bonyX	-->	bonyo
IO	XXni	bony + XXni	-->	bonyXXni	-->	bonyooni
A	XXnit	bony + XXnit	-->	bonyXXnit	-->	bonyoonit
L	w	bony + w	-->	bonyXw	-->	bonyow

4.5.1.2 Cxx]-Final Nouns

There are two types of Cxx] final nouns: (i) Those which are directly derived from a Cxx] final verb, with no overt noun-forming affix

(4.93)

a.	hoolii	'narrate'	hoolii	'narrative'	183
b.	wastuu	'injure'	wastuu	'injury'	183
c.	xataalaa	'cause to eat'	xataalaa	'act of causing to eat'	183

and (ii) those which are underived or which are derived with a

4.5 -- Classification of Noun Morphology

Cxx]-final noun-forming affix, like hanaa 'passive agentive', aa 'consequent agentive', hayaa 'plural', ihnii 'agentive', and (?)aa 'consequent agentive'. The form of the suffix depends on whether the noun is derived directly from a verb (4.94a) or not (4.94b.c).

(4.94)

	a. 'trying'	b. 'mouth'	c. 'one who has stolen'
S	damna?	sama?	?uṭ?a?
P	damnin	samaa?in	?uṭ?aa?in
O	damna	samaa?in	?uṭ?aa?in
IO	damnaani	samaani	?uṭ?aani
A	damnaanit	samaanit	?uṭ?aanit
L	damnaw 186	samaw 186	?uṭ?aw 182
	(Newman's IBb)	(Newman's IBa)	(Newman's IBa)

In these paradigms, there are two contrasts. First, in Possessive and Subject, in (4.94a) there are two different suffixes, in and a (or X) respectively. In (4.94b,c) there is only one affix, ?in. Secondly, Subject is marked by a glottal stop closing the word-final syllable. If the word-final syllable contains a [+high] vowel, the vowel surfaces as [+high] in Subject and [-high] elsewhere: ?upɔllalli? 'wild dove-S' but ?uplallew 'wild dove-L' 182.

If the case affixes are as in the first column, then Vowel Elision (3.205) (first arrow) and the Universal Association Convention (1.5) (second arrow) take care of the rest.

(4.95)

S	(?)	sama + ?	-->	sama?
P	in/?in	sama + ?in	-->	sama?in
O	X/?in	sama + ?in	-->	sama?in
IO	XXni	sama + XXni --> samXXni	-->	samaani
A	XXnit	sama + XXnit --> samXXnit	-->	samaanit
L	w	sama + w	-->	samaw

Elision (3.205) deletes the stem-final vowel when a rime-initial affix follows (the Possessive and Object for

4.5 -- Classification of Noun Morphology

deverbal nouns and Indirect Object and Object for all Cxx] nouns). One of the two case endings in Possessive and Object must be marked for its affixation class.

4.5.1.3 CxC]-Final Nouns

All nouns in this group have a word-final short closed syllable which does not alternate with CC. Some are monosyllables, others are polysyllables:

(4.96)		'road'		'stones'	
	S	pil		silelhal	
	P	pilin		silelhalin	
	O	pila		silelhali	
	IO	pilni/pilaani		silelhalni	
	A	pilnit/pilaanit		silelhalnit	
	L	pilaw	177	silelhaliw	192
		(Newman's IAa)		(Newman IIBb)	

The following case affixes derive these forms unproblematically:

(4.97)	S	∅	siliilhal + ∅	-->	silelhal
	P	in	siliilhal + in	-->	silelhalin
	O	X	siliilhal + X	-->	silelhali
	IO	ni	siliilhal + ni	-->	silelhalni
	A	nit	siliilhal + nit	-->	silelhalnit
	L	w	siliilhal + w	-->	siliilhalXw --> silelhaliw

The first arrow indicates Epenthesis (3.203), the second the Universal Association Convention (1.5), Shortening (3.202) and Lowering (3.197).

We return to the variant pilaani, pilaanit shortly, around figure (4.102).

4.5 -- Classification of Noun Morphology

4.5.1.4 xxC]-Final Nouns

These nouns have a word-final alternation between a long open syllable (before Possessive and Locative) and a closed [-high] syllable (before Object, Indirect Object, and Ablative). The monosyllables are rare.

(4.98)

	'sweathouse'		'a place for staying the night'	
S	moş		lagaa?iy	
P	moşun		lagaa?eeyin	
O	moş		lagaa?ey	
IO	moşnu		lagaa?eyni	
A	moşnut		lagaa?eynit	
L	moşaw	177	lagaa?eeyaw	195
	(Newman IAb)		(Newman's IIBa)	

In monosyllables, the vowel always surfaces as [-high]; elsewhere, in Subject the surface vowel bears the underlying value for [high]; i.e. it is not an underlying long vowel and so does not undergo Lowering (3.197).

Here we might posit

(4.99)

S	∅	lagaa?iiy + ∅	-->	lagaa?iy
P	in	lagaa?iiy + in	-->	lagaa?eeyin
O	∅	lagaa?iiy + ∅	-->	lagaa?ey
IO	ni	lagaa?iiy + ni	-->	lagaa?eyni
A	nit	lagaa?iiy + nit	-->	lagaa?eynit
L	w	lagaa?iiy + w	-->	lagaa?iiyXw --> lagaa?eyiw

with special rules for the Subject case. (Epenthesis 3.203 applies with the first arrow.)

4.5.1.5 Generalizations about Case Affixes

Possessive and Locative are consistent, in and w respectively.

4.5 -- Classification of Noun Morphology

Indirect Object and Ablative vary together between xxni/xxnit and ni/nit, depending on the final syllable of the root. This is one alternation to be accounted for. There are three others.

(4.100)

- i. /?/ in Subject of Cxx]
- ii. [-high] in xxC monosyllables Subject
[+high] in xxC polysyllables Subject
- iii. /?/ in Object, Possessive of some Cxx]
- iv. xxni/xxnit vs. ni/nit

We consider (4.100iv) first. If the affixes are identical for all nouns, either an insertion rule or a deletion rule is required. An insertion rule inserts a long rime after a CC sequence:

(4.101)

Long Rime Insertion

$$\emptyset \xrightarrow{\quad \begin{array}{c} | \backslash \\ X \ X \end{array} / X' \ X']} \text{ ______} \quad \begin{array}{l} \text{in the Indirect Object} \\ \text{and Ablative} \end{array}$$

All other paradigms are derivable from a consonant-initial suffix.

A deletion rule is more clumsy:

(4.102)

$$\begin{array}{c} | \backslash \\ X \ X \end{array} \xrightarrow{\quad \quad \quad} \emptyset / \begin{array}{c} | \backslash \\ X(X) \ X' \end{array}] \text{ ______} \quad \begin{array}{l} \text{in the Indirect Object} \\ \text{and Ablative} \end{array}$$

The insertion rule also offers a possible account of the pilni/pilaani options noted above. CxC monosyllables have two possible underlying representations, CxC and CC. If the underlying representation is CxC, insertion does not apply and pilni is derived. If, however, it is underlyingly CC, insertion applies, hence pilaani.

4.5 -- Classification of Noun Morphology

(4.106)

$$\begin{array}{c} | \backslash \\ X \ X]_V]_N \\ | / \\ [\] \end{array}$$

damnaa + in
--> damnaa?in

A deletion rule is necessary:

(4.107)

$$? \text{ --> } \emptyset / \begin{array}{c} | \backslash \\ X \ X]_V]_N \end{array} \text{ ---}$$

--> damnaa]in

Now Elision (3.205) applies:

(4.108)

--> damnin

and the surface form is derived.

What is of real interest here is that a theory of syllable structure allows us to collapse Newman's eight noun classes into one basic group, with certain idiosyncracies whose environments are defined in terms of syllable structure itself. Subject (usually \emptyset) and Object (usually X) vary somewhat depending on syllable structure, but otherwise there is a rule inserting a long rime (4.101) and four case affixes:

(4.109)

P = in IO = ni A = nit L = w

4.5.2 Template Activity

Two questions are dealt with in this section, (i) how to reduce a number of different templates to one template and (ii) what the formal representation is of items which may undergo template-affixation.

4.5 -- Classification of Noun Morphology

4.5.2.1 Collapsing Templates

The suffix mliwis 'reciprocal relation' is discussed below. The surface patterns of the noun roots are

CxCCx and CxCxCCx

If we posit a CxCCC template, the rest follows from the regular syllabification procedures given in Chapter 3 section 2.

Consider also "template-collapsing" in certain plural forms. One type of plural formation consists simply of inserting a template. The template's shape varies depending on the number of consonants in the noun: In one plural we get

CxxCxC and CxxCCxC

and in another

CxCxxC and CxCxxCxC and CxCxxCCxC

The syllabification procedure alone in the first case creates the correct surface forms from a CxxCCC template. In the second case, the correct surface form is derived by syllabification from a CxCxxCCC template.

CxCCC + mliwis 'reciprocal relation'

The two templates used with mliwis 'reciprocal relation' can be captured simply by invoking the regular syllabification processes. Triconsonantal nouns surface with a

CxCCx

pattern, as seen in (4.110a-c) below.

4.5 -- Classification of Noun Morphology

(4.110)

- | | | | |
|----|-------------|----------------------------------|----------|
| a. | niʔsimliwis | 'brothers to each other' | <neʔees |
| b. | nuʔdumluwus | 'sisters to e.o.' | <noʔood |
| c. | ʔinsamliwis | 'grandfather/grandchild to e.o.' | <ʔeenaas |

Quadriconsonantals, on the other hand, surface with a

CxCxCCx

pattern, as shown in (4.110d,e) below.

(4.110) cont.

- | | | | |
|----|---------------|--|------------|
| d. | komiysamliwis | 'paternal uncle/man's brother's child to each other' | <komooyees |
| e. | ʔonimlamliwis | 'daughter-in-law and parent-in-law to each other' | <ʔonmil |

Suppose that the template here is CxCCC, with the quality of the epenthetic vowel determined independently, perhaps idiosyncratically. The suffix is mliwis. If a triconsonantal noun is inserted, the surface pattern is derived from

CxC.Cm.li.wis

(where the dots refer to syllable boundaries and the underlined segments are not syllabified). Epenthesis (3.203) predicts CxC.Cxm.li.wis, which is correct. When a quadriconsonantal noun is inserted the string again cannot be properly syllabified:

CxC.CCm.li.wis

The underlined segments are not syllabified. The syllabification rules (Epenthesis 3.203 and Syncope 3.204) from Chapter 3, section 2 predict

Cx.CiC.Cxm.li.wis,

which is correct.

CxxCCC -- The A-induced and I-induced Plurals

One plural-formation process consists simply of changing the template the noun is associated with. Consider the following paradigm, using triconsonantal nouns, all from p. 206:

(4.111)

	plural	singular	gloss
a.	nee?aş	ne?eeş	'younger brother'
b.	noosas	nusoos	'paternal aunt'
c.	ṭeepan	ṭipnee	'one endowed with magic powers'
d.	naa?id	na?aad	'older sister'
e.	noopip	nopoop	'father'

First, the quality of the second vowel depends on the quality of the first vowel: For one, they disagree in the value for [high]. Using the theory of underspecification outlined in Chapter 2, the difference in the value for [high] is the only difference we need to encode: The rest of the features follow from the default rules, needed also to account for epenthesis and vowel harmony. If we do not use underspecification, then the rule which provides the vowel for the second syllable of this template is greatly complicated. (This is detailed in Chapter 2.) As it stands, we may say:

(4.112) (=2.112)

Dissimilation

∅ --> [-a high] / [a high] } _____ in the appropriate morphological environment

Reexamine the paradigm in (4.111) to discover the form of the template supplied here: The first vowel is always [-high], regardless of its underlying height. The second

4.5 -- Classification of Noun Morphology

vowel can be either [+high] or [-high], depending on (4.112). The vowels are separated by a single consonant. Apparently, the template is CxxCxC. Case suffixes attach to this, according to the rules set out in section 1 of this chapter.

Now consider the following forms, where the root noun is quadriconsonantal. These are all from Newman 1944, p. 206.²⁶

(4.113)

	plural	singular	gloss
a.	mekʔač	mikeeʔiç	'one who is swallowing'
b.	holšač	huloošuč	'one who is sitting'
c.	heywat	hiyáwʔaa	'warrior'
d.	ʔonʔim	ʔonooʔim	'transvestite'
e.	naptim	napaatim	'sister's husband, husband's brother, son-in-law, son-in-law's brother'

The rule determining the vowel quality of the second vowel in the plural is Dissimilation (4.112).

The template inserted here has a long vowel in the initial syllable, as we see by the lowering of the [+high] vowels in (4.113a-c). The vowel of the second syllable can be [+high], as we see in (4.113d,e), and so the template is

CxxCCxC

Compare this to the template for the triconsonantal nouns above:

26. Note that (4.113a,b) apparently are derived from the singular of a verb concatenated with a template supplying affix, so a template is already supplied prior to the process illustrated here. However, if the CxxCC template forms the plural with a ?Xc suffix (and the vowel quality is provided by Dissimilation 4.112), then the claim made here still holds, that templates are supplied only if there is no template present. See 4.5.2.2 for another, similar plural formation.

4.5 -- Classification of Noun Morphology

CxxCxC

The two templates can be collapsed since the shorter contains basically the same syllabic arrangement as the longer:

CxxCCC

Under this interpretation, triconsonantal nouns surface erroneously with a

CxxCC

template. However, Epenthesis (3.203) inserts the vowel in the correct position. To understand this plural, we need to know a little about the plural case affixes. The case endings are

(4.114)

Subject	x	(=S)
Possessive	in	(=P)
Object	x	(=O)
Indirect Object	xxni	(=IO)
Ablative	xxnt	(=A)
Locative	w	(=L)

In all cases except S there is a "stem augment", the consonant /h/, between the stem and the case affix. The /h/ forms a syllable with the vowel of the case affix (or the epenthetic vowel in the locative). Consequently, all plural noun forms without case affixes have the same syllable structure. The only exception is the subject case but, as noted in Chapter 3.2, syllabification in the subject case is peculiar.

Thus, the CxxCCC template, followed by any case affix except S has the following syllabification (using the object affix):

4.5 -- Classification of Noun Morphology

(4.115)

underlying representation

X X X X X + X + X

X X X X X X + X + X

core syllabification (3.200)

X X X X X X X

X X X X X X X X

other syllabification rules

X X X X X X X X
| | / | | | | |
t e p a n h i

X X X X X X X X X X
| | / | | | | | | |
h e y w a t h i

In the Subject case, the syllabification is consistent with the irregularities in the Subject case elsewhere.

The template, then, is CxxCCC, and syllabification handles the rest.

CxCxxCC -- Weak Plurals

Consider now the following (from Newman p. 208):

(4.116)

	plural	singular	gloss
a.	lomeet	lomit	mountain
b.	ta?eet	ta?taa	ally
c.	taçeeçay	taççeeý	Tachi (tribal name)
d.	yawelman	yawlamnee	Yawelmani (tribal name)

In (4.116a,b) we see triconsonantal roots assuming a

CxCxxC

4.5 -- Classification of Noun Morphology

template, where the second syllable's vowel is /i/. In (4.116c), the quadriconsonantal noun surfaces as

CxCxxCxC

where the second syllable's vowel is /i/ and the third syllable's vowel is /a/. And in (4.116d), the quinquiconsonantal noun surfaces with a

CxCxxCCxC

template, where the vowels of the second and third syllable are /i/ and /a/ respectively, as with the quadriconsonantals. These three templates may be collapsed, again with parentheses:

CxCxx((C)xC)

and the melody for this plural is /i a/, invoking the rule of Vowel Docking (4.135) necessary in section 5.3 of this chapter.

If we assume a CxCxxCCC template, we account for the vowel positions by the regular rules of syllabification, again with S exhibiting predictably odd behavior. Derivations of tri-, quadri-, and quinquiconsonantal roots follow:

(4.117)

a. X X X X X X

X X X X X X X

X X X X X X X X

b. / / / / / /
X X X X X X

/ / / / / /
X X X X X X X

/ / / / / /
X X X X X X X X

c. --

/ / / / / / / / / /
X X X X X X X X X

/ / / / / / / / / /
X X X X X X X X X

forms begin with a closed syllable, in the one case where the underlying vowel is [+high], the vowel surfaces as [-high], even though it is short: ?epʰsilxo?, *?ipʰsilxo?. The first form, loptilen bears on the question of the form of the suffix. This suffix must be il and cannot be simply l with the i inserted by epenthesis. If the suffix were simply l, then from /loopt+l+iin/, the regular syllabification rules derive *loopitlen.

The last form in this paradigm, (4.118d) xatçilka, provides evidence for representing "demorphologized" or "lexicalized" words as underived nouns in underlying representation, rather than including some or all of the (unproductive) derivational history. The form, xatçilka 'gather seeds!', is derived from xataac 'seed', which is in turn derived from xat 'eat' by affixation of aac 'adjunctive' (which provides a CxC template, Newman 1944, p. 165-166). Newman notes that this suffix is unproductive and frequently words with this suffix have specialized meanings, for example (4.119a-d are from Newman p. 165, the rest from p. 166):

(4.119)

a.	tomooç 'a cover'	<tom 'cover'
b.	çunaaç 'a door, a cork'	<çun 'enclose'
c.	hixaaç 'grease'	<heex 'apply grease'
d.	puşaaç 'a whistle'	<puuş 'blow the breath'
e.	xataac 'seed'	<xat 'eat'
f.	wişaaç 'arrow-straightener'	<wiiş 'straighten'
g.	diyaac 'goal'	<deey 'take the lead'

Now, there are two possibilities: (i) xataac 'seed' could be represented as an underived noun in underlying representation and thus be subject to regular processes that other underived nouns are subject to, like template-inserting affixation; (ii) xataac 'seed' could be represented as a derived noun and either (a) be marked as an exceptional form and so be able to act like underived nouns or (b) force a radical revision of the explanation for the generalization that derived nouns are

4.5 -- Classification of Noun Morphology

Notice that with this account we maintain (i) the claim that verbs are provided one of CxCc, CxxCC, and CxCxxC and (ii) the claim that only items with no template may undergo template-affixation (with the possible exception noted in the preceding subsection). If the plural form is derivative of the singular form, then we must relinquish the latter claim.

4.5.3 Floating Segments

The floating glottal feature, or [+G], in 4.5.3.1 is shown to dock according to the rule of Glottal Infection (4.84), motivated in section 3.3 of this chapter for verbs. There are three suffixes with floating glottal features. There are also two suffixes with floating consonants, surfacing if there is a vacant C-slot in the supplied template, (m)aam 'decedent' and (n)iit 'decedent' (see 4.5.3.2).

4.5.3.1 Floating [+G] -- (?)in 'attributive'

One of the two suffixes providing a CxCC template, (?)in 'attributive', illustrates that the floating glottal feature functions in exactly the same way in the $[[\]_N]_V$ morphology as it does in the $[[\]_V]_V$ morphology: If C2 is [+sonorant], it associates to C2 as seen in (4.122a,b). If C2 is not [+sonorant], and there is no C3, a glottal stop surfaces exactly where C3 is expected to appear (4.122c):²⁷

(4.122)

- | | | | | |
|----|---------------------------------|---------|---------|-----|
| a. | diwʔinhiin 'was tough' | <diwiʔ | 'tough' | 225 |
| b. | ziʔbinnit 'is considered swift' | <zilaab | 'swift' | 225 |
| c. | doʔʔinxoʔ 'dislikes' | <doʔʔee | 'bad' | 225 |

27. The other affixes seen in (4.122) are hn 'aorist' (in 4.122a), nt 'passive future' (in 4.122b), and xoo 'durative auxiliary' and ʔ 'future' (in 4.122c).

4.5 -- Classification of Noun Morphology

This parallels the distribution of glottal stops and glottalized sonorants seen in 3.3. We account for these alternations with the rule of Glottal Infection (4.84), motivated above.

It is clear that this suffix provides a CxCC template because (i) there are no vowels between the second and third root consonants so it can not be the disyllabic template CxCxC, and (ii) there are examples (4.122a,b) where the vowel is [+high] in the first syllable: If the long template, CxCC, were supplied, this vowel would be [-high].

4.5.3.2 Floating [+G] -- ?inin 'resident of'

A suffix providing the CxCC template, (?)inin 'resident of', has a floating glottal feature, again symbolized as [+G]. Notice the distribution of glottalized sonorants and non-glottalized sonorants in the following paradigm: C2 is [+sonorant, +constricted glottis] with this affix, regardless of whether it surfaces as [+constricted glottis] in isolation.

(4.123)

a.	?iŋkiŋin	'Water People-S'	<?ilik	'water'	219
b.	balwunun	'Westerner-S'	<baluw	'West'	220
c.	xomtiŋni	'Southerners-O'	<xomootee	'South'	220
d.	xosmiŋnin	'Northerners-P'	<xosim	'North'	220

The distribution of glottalized sonorants is again predicted by the rule of Glottal Infection (4.84), from section 3. The non-appearance of the glottalization in (4.123d) is also predicted, since there is no [+sonorant] in C2 position and C3 is filled by the root's consonant melody. Nothing further need be said.

4.5.3.3 (?)aa 'inchoative'

Consider the following paradigm, with the inchoative suffix (?)aa:²⁸

(4.124)

a.	diweeṭaahin	'became hard'	<diwit'	'hard'	22:
b.	doṭeeʔaahin	'became bad'	<doṭee	'bad'	22:
c.	tiwéesaxoʔ	'is strong'	<tiwaas	'strong'	22:
d.	kabeētaxoʔ	'is warm'	<kabit'	'warm'	22:
e.	yitéesaxoʔ	'is Friday'	<yitis	'Friday'	22:

The shape assumed by the noun to which (?)aa is affixed is systematic. The first syllable contains a short vowel identical in quality to the vowel of the first syllable of the corresponding noun, for example [o] in doṭeeʔaahin is the vowel of the first syllable of doṭee 'bad'. The second syllable contains a long [e] regardless of the vowels of the noun. We know from Chapter 3 that [e] is derived from an underlying long /i/ by Lowering (4.197). The template assumed by the nouns must be CxCxxC, where the second syllable's vowels are linked to an /i/:

(4.125)

d	w	t'	
C	x	C	x x C x x ...
i	i	a	

Notice the effect of adding this suffix to a biconsonantal noun, the only example being doṭeeʔaahin 'became

28. In (4.124a,b) the suffix hn 'aorist' is attached; in (4.124c,d,e) the suffixes xoo 'durative' and ʔ 'future' are added. (Recall from Chapter 3, section 2.5.3, that long vowels shorten before xoo.) Once these affixes are stripped away, an aa-final form remains.

4.5 -- Classification of Noun Morphology

bad' (4.124b). The problem is to account for the appearance of the glottal stop. This is one point which I would like to wait on, in the hopes of finding more elucidating data, before venturing an account. The problem is that if we posit a floating [+G] feature as before, then we are left with no explanation for why the /w/ in diweeṭaahin does not surface as glottalized. One possibility is that with the CxCxC template, the [+G] docks on the final C if empty or if [+sonorant], rather than on the second C as with the other two templates. But with (?)aa, there are no example where C3 is [+sonorant], so this hypothesis can not be tested yet. I must carefully examine all suffixes providing the CxCxC template and see if there is some clue.

4.5.3.4 CxCCC + (m)aam 'decedent'

In (4.126) below, we see triconsonantal nouns assuming a CxCxC pattern with the suffix (m)aam 'decedent' (from Newman 1944, p. 220-221).²⁹

(4.126)

- | | | | |
|----|-------------|---------------------------------|---------|
| a. | pulammaam/ | 'deceased husband' | <puulum |
| b. | mokoynoomb/ | 'deceased wife' | <mokiý |
| c. | ni?ašmaam/ | 'deceased younger brother' | <ni?iis |
| d. | gačipmaam/ | 'deceased sibling's daughter' | <gačaap |
| e. | čayixmaam/ | 'deceased man's sister's child' | <čayaax |

In the following paradigm, quadrilateral nouns show up with a suffix without the initial m, -aam. The template appears to be CxCCC, with a second syllable head inserted by Epenthesis (3.203) (from Newman 1944, p. 221):

29. The quality of the vowel in the second syllable is not entirely predictable.

4.5 -- Classification of Noun Morphology

(4.127)

- | | | | |
|----|-------------|-----------------------------|------------|
| a. | ?it'awpaam/ | 'deceased husband's sister' | <?it'woop' |
| b. | ?onotpoom/ | 'deceased mother-in-law' | <?ontip |
| c. | naximsaam/ | 'deceased father-in-law' | <naxaamis |
| d. | ?onimlaam/ | 'deceased daughter-in-law' | <?onmil |

If a CxCCC template is supplied by the suffix (m)aam 'decedent', and the suffix itself has a floating initial m, the distribution of m/s in (4.126) and (4.127) is predicted, and syllabification inserts the missing slot.

(4.128)

biconsonantal noun

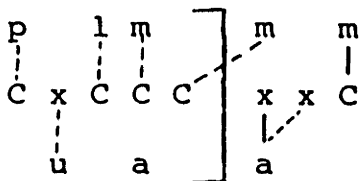

triconsonantal noun

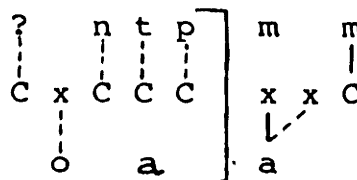

The underlying link is shown with a solid line; the linkings due to the Universal Association Convention (1.5) and Syllable Internal Spread (3.196) are represented with dotted lines. Syllabification gives:

(4.129)



The m/Ø alternation is predicted simply from the underlying representation of the suffix. The derivation proceeds in a manner parallel to the verbal derivations.

4.5.3.5 (n)iiit 'decedent'

Although this suffix is rare, it suggests the existence of yet another floating consonant quality, /n/ (adding to /h/, /l/, and /m/). The words are considered somewhat archaic

4.5 -- Classification of Noun Morphology

(Newman 1944, p. 221).

(4.130)

- | | | | |
|----|---------|----------------------------|-----------|
| a. | ?omneet | 'deceased mother' | ?< no?oom |
| b. | šoʃnoot | 'deceased paternal aunt' | ?< nusuus |
| c. | ?esneet | 'deceased younger brother' | ?< ni?iis |
| d. | betneet | 'deceased older brother' | ?< nibiič |
| e. | ?otnoot | 'deceased younger sister' | ?< no?ood |
| f. | ketneet | 'deceased maternal aunt' | ?< nikiid |
| g. | xamyet | 'deceased father' | -- |

In (4.130a-f), the noun roots used are all biconsonantal; in (4.130g) it is triconsonantal. Only in the last case does the /n/ of (n)iit not surface, suggesting yet another floating consonant in underlying representation. There is no synchronic word related to xamyet in Yawelmani, nor in the other Yokuts dialects. (See Newman 1944, p. 221-222.) Consequently this example may not be correctly analyzed here.³⁰

4.5.4 Floating Vowels

Certain vowels present in a noun's melody do not necessarily surface. This could be due to deletion of the extra vowels or simply to their not being linked to a skeletal position. I argue here for the latter account, that the extra vowels float. Before looking at particular cases, let us consider schematically how "floating vowels" arise.

Floating vowels arise, as do floating consonants, when there are not enough skeletal slots available for all of the vowels in the melody. This is seen when a template and vowel melody are supplied simultaneously to a noun with more than one vowel unit in its melody.

30. Newman (1944, p. 221) suggests the initial /n/ in the kinship terms is derived from Penutian n 'my'.

4.5 -- Classification of Noun Morphology

Of particular interest now is the case of tiwéesaxo? 'is strong' (4.124c), which is derived from a bivocalic noun, tiwaas 'strong'. The second vowel of the noun, /a/, does not surface at all in the verb form. Either the vowel /i/ is linked to the second syllable head in underlying representation or a rule links the /i/, blocking the Universal Association Convention (1.5). There are two other N-->V affixes which select the CxCxxC template, and both surface with the vowel /i/ linked to the second syllable of the template. At this point, to be consistent with the analysis of verbs in the preceding chapter, I assume that the inserted template has no associated phonemic material, and that the affix has two vowels, /i/ and /a/. A rule associates the /i/ to the vowels of the second syllable in the template.

(4.135)

Vowel Docking

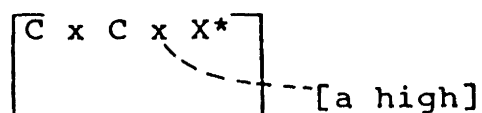

Vowel Docking (4.135) links the first floating vowel of the suffix to the head of the second syllable in the template.

Another option would be to have a rule which deletes all but the first vowel of the noun, with the associations following from the Universal Association Convention (1.5), Copy (3.195), and Syllable Internal Spread (3.196). When we consider the causative inchoative yaa (directly below) we will see that vowel deletion makes the wrong predictions.

4.5.4.1 taa, yaa 'causative inchoative'

In (4.136) we see taa and in (4.137), (4.138) we see yaa, both meaning 'causative inchoative' and both providing the disyllabic template CxCxxC. Since they are both

4.5 -- Classification of Noun Morphology

(4.131)

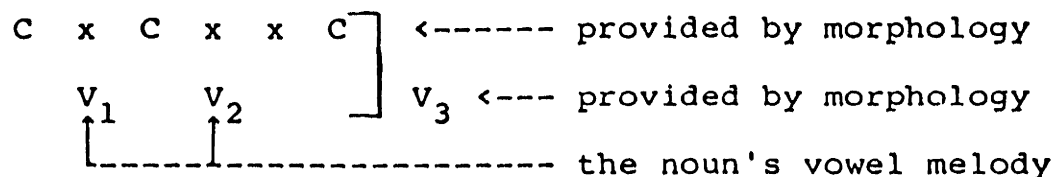

In these cases, the affix vowel melody associates to the vowel(s) of the second syllable of the template (by rule):

(4.132)

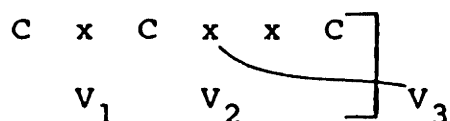

The Universal Association Convention (1.5) now links V_1 to the first V-slot in the skeleton and V_2 floats:

(4.133)

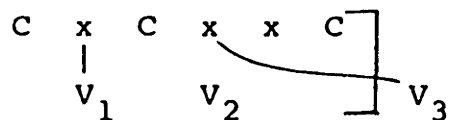

When we examine the various cases where of the noun's melody only " V_1 " surfaces, we see evidence for the above (schematic) analysis: The floating vowel is a trigger for certain rules, just as linked vowels are.

(?)aa 'inchoative'

Recall the examples in (4.124) above, repeated below for convenience.

(4.134) (=4.124)

a.	diweeṭaahin	'became hard'	<diwiṭ	223
b.	doṭee?aahin	'became bad'	<doṭee	223
c.	tiwéesaxo?	'is strong'	<tiwáas	223
d.	kabéetaxo?	'is warm'	<kabiṭ	223
e.	yitéesaxo?	'is Friday'	<yitís	224

4.5 -- Classification of Noun Morphology

consonant-initial, with a trisyllabic noun the second syllable is shortened, as seen with taa in (4.136) below.

(4.136)

- | | | | | |
|----|---------------|----------------------|---------|-----|
| a. | ʔohemtaahin | 'made vanish' | <ʔohom | 224 |
| b. | lageltaawiská | 'disguise yourself!' | <lagiil | 224 |

The vowel of the second syllable in both cases is once again [e], regardless of the length on the surface and regardless of the quality of the vowels in the noun. If we posit the CxCxxC templates, an unassociated /i/ in the suffix, and the above rule of Vowel Docking (4.135), the independently needed rules of Lowering (3.197) and Rime Formation/Shortening (3.202) account for the quality and length of the second syllable's vowel. Thus, the suffix taa 'causative inchoative' must be represented with a floating /i/, just like (?)aa 'inchoative'.

As noted above, the third suffix yaa 'inchoative causative' has this same distribution of template and vowels. It provides a CxCxxC template and the vowels of the second syllable surface as [e].

(4.137)

- | | | | | | |
|--|-------------|-----------|--------|-------|-----|
| | doʔeeyaahin | 'spoiled' | <doʔee | 'bad' | 225 |
|--|-------------|-----------|--------|-------|-----|

Newman's description of the inchoative causative suffix yaa states clearly that it follows a "CxCeeC" form of the noun (Newman 1944, p. 225). The examples he provides are tantalizing with respect to the correct representation of vowel harmony. First, there are only three forms in Newman's grammar with the suffix yaa, and second, each of the three comes from a different dialect. They are given below.³¹

31. The Wikchamni form is derived from xap'oodyaa. The final /aa/ deletes by rule, and Epenthesis (3.203) inserts a vowel between the two final consonants of the stem.

4.5 -- Classification of Noun Morphology

/i/ of the suffix is linked prior to Universal Association Convention (1.5) and this forces all but the first vowel of the noun to float, as represented in (4.140) above.

Intuitively, the floating /u/ induces harmony on the following /i/. The /i/ then becomes /u/, and by Lowering (3.197) and Shortening (3.202) it surfaces as [o]. There is further evidence suggesting that harmony induced by floating vowels seems to be a general process in Yokuts, not an obscure phenomenon. When a vowel initial suffix follows a vowel final string, the final vowels do not surface. However, they are "present" in that they can induce harmony.³²

(4.142)

wastuu + ihni? --> wastuhnu? 'injurer-S'

(?)iñin 'resident of' and iyin 'intensive possessor'

Further evidence for floating vowels triggering harmony is provided by these two affixes.

Both of these suffixes provide a CxCC template for the noun root. In the event that the noun is bivocalic, the second vowel of the noun floats. If that floating vowel is /u/, the vowels of the suffix surface as [u], not [i]. Examples follow.³³

32. See Ito (to appear) for a rule in Ainu which refers only to the phonemic melody.

33. In (4.144), the suffix surfaces as ...uṭun, not the expected ...uyun. Newman (1944, p. 218) notes that with this suffix, there is considerable unpredictable variation in the quality of the first suffix consonant.

4.5 -- Classification of Noun Morphology

(4.143)

bal'wu'nun 'Westerner-S' <baluw + (?)i'nin 220

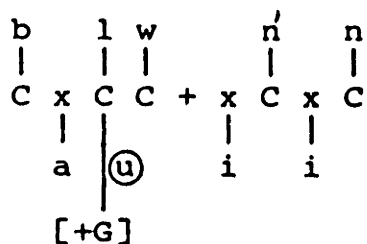

(4.144)

dam'tu'tun 'one with a heavy beard' <damuu't + iyin 219

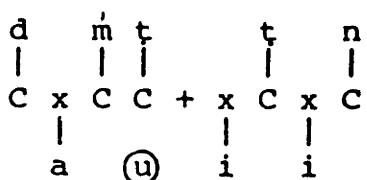

These two affixes are also discussed in Chapter 3, figures (3.52, 3.53) respectively.

4.5.4.2 CxCCC 'plural'

In 4.5.2.1, template-supplying plural formation is analyzed. Besides inserting a template, a vowel is inserted as well, and linked to the final syllable head of the template. The rule of Dissimilation (4.112) accounts for the quality of this vowel. Consider now the following noun:

?antuw 'shaman'

The vowel melody here is /a u/. Dissimilation (4.112) predicts that a [-high] vowel will be inserted in the CxCCC plural of ?antuw:

4.5 -- Classification of Noun Morphology

(4.145)

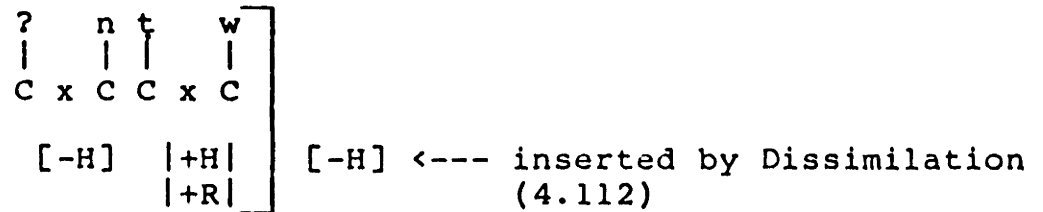

The rule of Vowel Docking (4.135) links the final [-H] to the vowel of the second syllable:

(4.146)

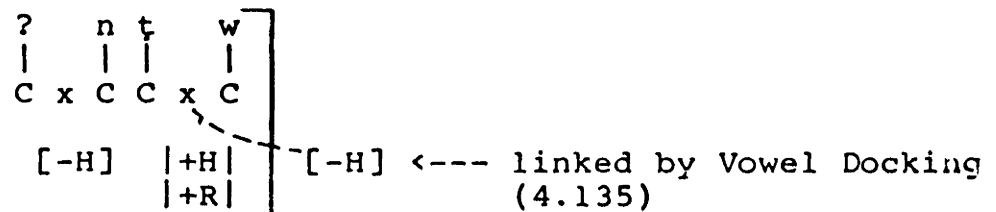

The correct surface form [ʔanʔaw] 'shaman-pl' is so derived.

The rule of Dissimilation (4.112) is sensitive to the vowel melody, and ignores skeletal positions or linkings to skeletal positions. The rule of Vowel Docking (4.135) is a more general rule than first appeared.

(m)aam 'deceased'

Apparently there are places where vowels are deleted as well. Consider the following forms:

(4.147)

- a. moko¹ymoom 'deceased wife' < moki¹y 220
 b. ʔonotpoom 'deceased mother-in-law' < ʔontip 221

The prediction made by the floating vowel hypothesis is that there should be no harmony in these words, because the floating /i/ intervenes between the word-initial /o/ and the following /a/:

4.5 -- Classification of Noun Morphology

(4.148)

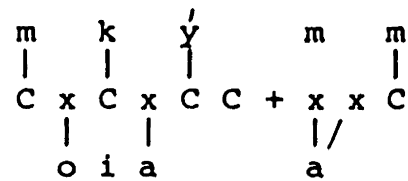

However, as seen in (4.147) above, Harmony (4.199) does obtain. I suggest that this is a result of the absence of the vowel /i/ in the underlying representation of these words. That is, the vowel /i/ in mokiy 'wife' and ?ontip is inserted by Epenthesis (3.203), and crucially is not part of the underlying representation. Thus, instead of the representation in (4.148), we have the representation in (4.149) below, and there is no [+high] vowel to block Harmony (4.199).

(4.149)

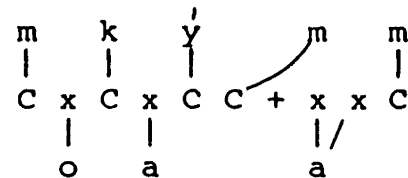

The apparent counter-example to the floating vowel hypothesis in (4.147) above is thus shown not to be a counter-example at all.

4.5.5 Catalog of Affixes on Nouns

4.5.5.1 A Catalog of N-->V Morphology

The affixes in question here are:

4.5 -- Classification of Noun Morphology

(4.150)

a.	(?)aa	'inchoative'	(4.5.3.1,2)
b.	(?)in	'attributive'	(4.5.3.1)
c.	yaa	'inchoative causative'	(4.5.3.2)
d.	taa	'inchoative causative'	(4.5.3.2)
e.	il	'manipulative'	(4.5.2.2)
f.	iixoo	'consequent'	
g.	naa	'acquisitive'	
h.	"0"	'characteristic activity involving the noun'	

The numbers to the right indicate the section in which the affixes in (4.150a-e) are examined. The remaining three affixes are dealt with here.

iixoo 'consequent'

Examples with the consequent suffix eexoo, which is rarely found with nouns³⁴ are interesting in that they demonstrate the neutralization under template affixation of the wide variation in Cx patterns of the underived noun. With eexoo, all nouns show up as CxCC, despite having CxCxCx, CxCxC, and CxCxC as nouns:

(4.151)

a.	hadmeexoohin	'was unripe/green'	<hadmee	'green'
b.	liwdeexok	'keep cold!'	<liwid	'cold'
c.	tiwseexo?	'is strong'	<tiwaas	'strong'

According to Newman, it is the number of consonant melody units (two or three) that determines whether affixation is possible, not the number of vowels nor the arrangement of Cs and Vs.

34. This suffix eexoo 'consequent auxiliary' also provides the CxCC template when it attaches to verbs.

4.5 -- Classification of Noun Morphology

4.5.5.2 naa Affixation

The suffix naa 'acquisitive' does not occur frequently enough for classification of the stem types to which it attaches. Newman's examples follow:

(4.152)

- a. CxCxC (not CxCxxC)
wiçibnaahin 'gave birth' <wiçeeb 'offspring'
- b. CxCxxC (not CxCxC)
pulómnaxo? 'is getting a husband'
<poolum 'husband'
- c. CxCaC or CxCaaC
?ilaknaċ 'compose a song!'
<?ilik' 'song'
- d. CxCxC or CxCxxC
mokoynoositċa 'get me a stepmother!'
<mokooy' 'stepmother'
- e. CxCCxxC or CxxCCxxC
naxmesnaahin 'got as father-in-law'
<naxaamis 'father-in-law'

Nothing consistent can be said about the templates assumed by the nouns in this construction, nor about the vowel alternations (see especially (4.152c) above).

4.5.5.3 "Ø" affix 'characteristic activity'

The "zero affix", denoting "a characteristic activity involving the entity described in the noun" (Newman 1944, p. 222), is essentially using the noun root as a verb.

(4.153)

- a. čeedaxoohin 'was gathering greens' < čeedaa
- b. tēpnaċ 'make acorn mush!' <tēepin
- c. čeelalnoohun 'went onto the bridge' <čeelaałun
- d. ?inmiṭċaahin 'became jealous' <?inmiṭċaċ
- e. hiyaŵṭihnee 'one acting belligerently'
<hiyaŵṭaa

4.5 -- Classification of Noun Morphology

The Cx pattern assumed by a noun depends on the shape of the final syllables of the noun. This is discussed in section 5.1 of this chapter, since the form adopted here is identical to the form used with the ablative and indirect object affixes.

4.5.5.4 A Catalog of N-->N Morphology

Some of the N-->N morphological processes consist of adding affixes (some of which supply templates), and some of which consist solely of vowel melody units. These are listed below.

(4.154)

| | | | |
|----|------------------|----------------------------------|----------------|
| a. | CxxCCC | 'plural' | (4.5.2.1, 3.2) |
| b. | CxCxxCCC | 'plural' | (4.5.2.1) |
| c. | CxxCCC + (?)iic | 'plural' | (4.5.2.2) |
| d. | CxCC + iyin | 'intensive possessor' | (4.5.3.2) |
| e. | CxCC + (?)iñin | 'resident of' | (4.5.3.1, 2) |
| f. | CxCCC + (m)aam | 'decedent' | (4.5.3.1, 2) |
| g. | CxxCC + (n)iit | 'decedent' | (4.5.3.1) |
| h. | CxCC + mliwis | 'reciprocal relation' | (4.5.2.1) |
| i. | CxCxxC + (i)way' | 'plural' | |
| j. | CxCxxC + (i)haal | 'plural' | |
| k. | haad | 'plural' | |
| l. | m | 'possessor' | |
| m. | miin | 'possessor' | |
| n. | naan | 'quality possessor' | |
| o. | CxCC + haay | 'plural' (rare and unproductive) | |
| p. | CxCxxC + hayaa | 'plural' (rare and unproductive) | |
| q. | haad | 'plural' (rare and unproductive) | ³⁵ |

Most of these affixes operate in a straightforward manner. Discussion of some of the interesting cases is included in the sections noted above. Here I comment briefly on the remaining suffixes, for completeness.

35. The three rare and unproductive affixes in (4.154o,p,q) are found in Newman on p. 216-217.

CxCxxC + way' plural

The examples below illustrate this process:

(4.155)

| | | | | |
|----|-----------|------------------|-----------|-----|
| a. | babeeway' | 'paternal aunts' | < baɪaa | 211 |
| b. | hayenway' | 'ducks' | < hay'naa | 211 |
| c. | ?usokway' | 'hearts' | < ?usuk' | 211 |
| d. | silelway' | 'stones' | < siliil | 211 |
| e. | ʔalepway' | 'bows' | < ʔalaap | 211 |

Two points indicate the CxCxxC template: (i) The first vowel is short in an open syllable, and it can be [+high]. Thus it cannot be "xx" underlyingly, but must be a single "x". This means we have CxCx... (ii) The second syllable alternates between Cxx (4.155a) and CxC (4.155b-e), but the vowel is always [-high]. The regular rules from Chapter 3 give these length and height alternations if we posit an underlying long vowel, hence CxCxxC.

Notice that here, too, we get an /i/ linked to the vowels of the second syllable. If way is underlyingly

(4.156)

| | | |
|---|---|---|
| w | | ɪ |
| | | |
| c | v | c |
| | | |
| i | a | |

Vowel Docking (4.135) provides the necessary linking.

CxCxxC + ha(a)l' plural'

This suffix provides the same template as way above, and a floating /i/:

4.5 -- Classification of Noun Morphology

(4.157)

- | | | | | |
|----|-------------|-------------------|-----------|-----|
| a. | silelhalnit | 'from rocks' | < siliil | 215 |
| b. | pikelhaal | 'sinews' | < pikiil | 215 |
| c. | čageshaal | 'much wire-grass' | < čagaas | 215 |
| d. | pagexhaal | 'much blood' | < paagaax | 215 |

The arguments given above for the CxCxC template apply here as well.

Regular Affixes

There are three regular affixes, mentioned only for completeness. The suffix m indicates possession, alienable or inalienable. These words are found on p. 217 in Newman (1944).

(4.158)

- | | | | | |
|----|----------|---------------------|---------|---------------|
| a. | ?anaasam | 'Basket Woman-S' | <?anaas | 'pack-basket' |
| b. | xataam | 'one who has food' | <xat | 'food' |
| c. | keexaam | 'one who has money' | <kiixaa | 'money' |

The suffix m attaches to the -VV final stem (see section 1 of this chapter).

The suffix miin indicates alienable possession. These examples are found in Newman (1944), p. 218.

(4.159)

- | | | | | |
|----|-----------|-----------------------|---------|----------|
| a. | teemin | 'dwellers-S' | <ti | 'house' |
| b. | ciwaameen | 'one who has rabbits' | <ci?iw | 'rabbit' |
| c. | čalapmeen | 'one who has a bow' | <čalaap | 'bow' |

The suffix naan indicates possession of a quality. These examples are also found on p. 218.

(4.160)

- | | | | | |
|----|-------------|------------------------|---------|---------|
| a. | mayeknan | 'one with a large ...' | <mayiik | 'large' |
| b. | dočeeanaan | 'one who uses bad ...' | <dočii | 'bad' |
| c. | diwčeeanaan | 'one with a hard ...' | <diwič | 'hard' |
| d. | wa?atnaan | 'one with a long ...' | <wa?aat | 'long' |

4.5 -- Classification of Nour Morphology

4.6 The Template Pool

Throughout this chapter, we see evidence that Yawelmani morphology involves template insertion. The distribution of these templates is curious. If a verb root is supplied with a template, or if a noun is supplied with a template and thereby becomes a verb, the template is one of the pool of three:

CxCC, CxxCC, CxCxxC.

However, if a noun is supplied with a template, but remains a noun, the template pattern is varied:

CxCC, CxCCC, CxxCC, CxxCCC, CxCxxC,
CxCxxCC.

This distribution is represented in the following chart.

(4.161)

| | | | | |
|-------|---|-------|--------|----------|
| V-->V | } | CxCC | CxxCC | CxCxxC |
| V-->N | | | | |
| N-->V | | | | |
| | | | | |
| N-->N | { | CxCC | CxxCC | CxCxxC |
| | | CxCCC | CxxCCC | CxCxxCC |
| | | | | CxCxxCCC |

It is clear from the above chart that the templates supplied to nouns are identical to those supplied to verbs except for the addition of unsyllabified slots (i.e. "C" slots) on the right edge. As noted above, syllabification produces the correct surface forms from these underlying templates.

Interestingly, when biconsonantal roots undergo reduplication (see Newman 1944, p. 61-65), these same templates are used,

4.5 -- Classification of Noun Morphology

| | |
|---------|------------------|
| CxCCC | "zero stem" |
| CxCxxCC | "weak stem" |
| | "i-induced stem" |

Although the surface forms appear widely varied, only three basic templates are used in Yawelmani,

(4.162)

| | | |
|-------------|----------------|------------------|
|
X X X X | \
X X X X X | \
X X X X X X |
|-------------|----------------|------------------|

4.7 Conclusion

In this chapter the pattern of the phonemes in a regular verb root is seen to be predictable, depending both on the affix and on the root. This provides support for a skeletal core independent of any phonemic material. This is not a new theoretical claim, but rather adds to a growing literature (McCarthy 1979 1981, Halle and Vergnaud 1980, Harris 1980, Marantz 1982, Yip 1982). However, the analysis here is an important addition because the skeleta are added to the grammar in an unfamiliar manner: Affixes may determine the skeletal template of a root; if not, a neutral template is supplied, determined by a lexical diacritic on each verb root.

In section 3, a template pool consisting of the three neutral verb templates in Yawelmani was established. Certain affixes supply templates from this pool and the phonemic melody of the root associates with the selected template according to universal conventions and the rule of Copy (3.195). The assumption of a pool containing only three templates accounts for the pairing of bi- and triconsonantal forms when a template is selected by an affix, that is, the

4.5 -- Classification of Noun Morphology

CxC-CxCC, CxxC-CxxCC, and CxCxx-CxCxxC pairings. The triconsonantal template is selected in all cases. With biconsonantal roots, the final slot of the template has no segment associated with it, and so cannot surface. Further support for this template pool is derived from noun morphology, where the templates are CxCC*, CxxCC*, and CxCxxC*. The template pool explanation is elegant and concise, but is not available without the existence of an independent skeletal tier. Also, further support for consonants and vowels forming individual planes appeared in sections 4 and 5, where characteristics of all suffixes are detailed.

REFERENCES

- Aoki, H. 1965. 'Nez Perce Vowel Harmony and Proto-Sahaptian Vowels', Language 42, p. 759-767.
- Anderson, S. 1981. 'The Analysis of French Schwa or How to Get Something for Nothing', UCLA ms.
- Archangeli, D. 1983a. 'Yawelmani Verb Morphology and Three-Dimensional Phonology', in P. Sells and C. Jones, eds., Proceedings of NELS 13, distributed by the Department of Linguistics, University of Massachusetts at Amherst.
- . 1983b. 'The Root CV-Template as a Property of the Affix: Evidence from Yawelmani', Natural Language and Linguistic Theory 1, p. 348-384.
- . 1984. 'The Yawelmani Lexicon', MIT ms.
- and D. Pulleyblank, 1984. 'Extratonicity and Japanese Accent', MIT and McGill ms.
- Broselow, E. 1984. 'Amharic Roots', paper presented at the Second MIT Independent Activities Period Morphology Workshop.
- and J. McCarthy, to appear. 'A Theory of Internal Reduplication', The Linguistic Review 3.
- Cairns, C. and M. Feinstein, 1982. 'Markedness and the Theory of Syllable Structure', Linguistic Inquiry 13, p. 193-225.
- Campbell, L. 1974. 'Phonological Features: Problems and Proposals', Language 50, p. 52-65.
- Clements, G. 1983. Talk given at Harvard University.
- Clements, G. and S.J. Keyser, 1981. A Three-Tiered Theory of the Syllable, MIT Center for Cognitive Science Occasional Paper 19.
- . 1983. CV Phonology: A Generative Theory of the Syllable, Linguistic Inquiry Monograph 9, MIT Press,

References

Cambridge, Massachusetts.

Clements, G.N. and E. Sezer, 1982. 'Vowel and Consonant Disharmony in Turkish', in H. van der Hulst and N. Smith, eds., The Structure of Phonological Representations, Foris Publications, Dordrecht.

Chomsky, N. 1957. Syntactic Structures, Mouton, The Hague.

---- and M. Halle, 1968. The Sound Pattern of English, Harper and Row, New York.

Feinstein, M. and S. Lapointe, 1982. 'The Role of Vowel Deletion and Epenthesis in the Assignment of Syllable Structure', in H. van der Hulst and N. Smith, eds, The Structure of Phonological Representations, Foris Publications, Dordrecht.

Franks, S. 1983. 'Extrametricity and Stress in Polish', Cornell ms.

Gamble, G. 1978. Wikchamni Grammar, University of California Publications in Linguistics, Vol. 89, University of California Press, Berkeley, CA.

Goldsmith, J. 1976. Autosegmental Phonology, Doctoral dissertation, MIT.

---- . 1973. 'The Aims of Autosegmental Phonology', in D. Dinnsen, ed., Current Approaches to Phonological Theory, p. 202-222, Indiana University Press, Bloomington, Indiana.

Grignon, A-M. in prep. Doctoral dissertation, University of Montreal.

Guerssel, M. 1983. 'Glides in Berber and Syllabicity', MIT ms.

Halle, M. and G.N. Clements, 1983. Problem Book in Phonology, MIT Press, Cambridge, Massachusetts.

Halle, M. and K.P. Mohanan, 1983. 'Segmental Phonology of Modern English', MIT ms.

Halle, M. and K. Stevens, 1971. 'A Note on the Laryngeal Features', in MIT Research Laboratory in Electronics Quarterly Progress Report 101, p. 198-203.

Halle, M. and J.R. Vergnaud, 1980. 'Three Dimensional Phonology', Journal of Linguistic Research 1,

References

- p. 83-105.
- . 1981. 'Harmony Processes', in W. Klein and W. Levelt, eds., Crossing the Boundaries in Linguistics, p. 1-22, D. Reidel, Dordrecht.
- . in prep. Grids and Trees: An Essay on Stress.
- Harris, J. 1980. 'Nonconcatenative Morphology and Spanish Plurals', Journal of Linguistic Research 1, 15-31.
- . 1983. Syllable Structure and Stress in Spanish: A Nonlinear Analysis, Linguistic Inquiry Monograph 8, MIT Press, Cambridge, MA.
- . in prep. 'Spanish Diphthongization and Stress: A Paradox Resolved'.
- Harris, Z. 1944. 'Yokuts Structure and Newman's Grammar', International Journal of American Linguistics 10.4, p. 196-211.
- Hayes, B. 1980. A Metrical Theory of Stress Rules, Doctoral dissertation, MIT.
- . 1981. 'Extrametricity and English Stress', Linguistic Inquiry 13, p. 227-276.
- Hockett, C. 1967. 'The Yawelmani Basic Verb', Language 43, p. 208-222.
- . 1973. 'Yokuts as Testing-Ground for Linguistic Methods', International Journal of American Linguistics 39, p. 63-79.
- Hyman, L. 1983. 'A Theory of Phonological Weight', USC ms.
- Ito, J. to appear. 'Melodic Dissimilation in Ainu', Linguistic Inquiry 15.3.
- Jakobson, R. 1928. 'Propositions au Premier Congres International de Linguistics', reprinted in Selected Writings I, P. 3-6, Mouton, The Hague.
- , G. Fant, and M. Halle, 1963. Preliminaries in Speech Analysis, MIT Press, Cambridge, Massachusetts.
- Kahn, D. 1976. Syllable-Based Generalizations in English Phonology, Doctoral dissertation, MIT.

References

- Kaye, J. and J. Lowenstamm, 1981. 'De la Syllabicite', ms.
- Kean, M. 1975. The Theory of Markedness in Generative Grammar, Doctoral dissertation, MIT, distributed by Indiana University Linguistics Club.
- . 1979. 'On a Theory of Markedness: Some General Considerations and a Case in Point', in A. Belletti e al., eds, Theory of Markedness in Generative Grammar, Proceedings of the 1979 GLOW Conference. Scuola Normale Superiore di Pisa, Pisa.
- Kegl, J. in prep. 'Palatalization and Complex Segment Formation in Slovene.'
- Kenstowicz, M. and C. Kisseberth, 1970. 'Rule Ordering and the Asymmetry Hypothesis', in Chicago Linguistic Society, Sixth Regional Meeting.
- . 1973. 'The Multiple Application Problem in Phonology', in C. Kisseberth, ed., Studies in Generative Phonology, Linguistic Research, Inc., Edmonton, Alberta.
- . 1979. Generative Phonology: Description and Theory, Academic Press, New York.
- Keyser, S. and K. Stevens, 1983. "Towards a Phonetic and Phonological Theory of Redundant Features", MIT ms.
- Kiparsky, P. 1973. 'Abstractness, Opacity, and Global Rules', in O. Fujimura, ed., Three Dimensions in Linguistic Theory, p. 57-86, TEC, Tokyo.
- . 1982. 'Lexical Phonology and Morphology', in I.S. Yange, ed., Linguistics in the Morning Calm, Linguistic Society of Korea, Hanshin, Seoul, Korea.
- . 1983. 'Some Consequences of a Theory of Lexical Phonology', MIT ms.
- . 1984. 'On the Lexical Phonology of Icelandic', Xerox PARC ms.
- Kisseberth, C. 1969a. Theoretical Implications of Yawelmani Phonology. Doctoral dissertation, University of Illinois.
- . 1969b. 'On the Abstractness of Phonology: The Evidence from Yawelmani', Papers in Linguistics 1, p. 248-282.

References

- . 1970a. 'On the Functional Unity of Phonological Rules', Linguistic Inquiry 1, p. 291-306.
- . 1970b. 'Review Article on Kuroda 1967', Linguistic Inquiry 1, p. 337-345.
- . 1973a. 'Is Rule Ordering Necessary in Phonology?', in B. Kachru et al., eds., Papers in Linguistics in Honor of Henry and Renee Kahane, University of Illinois Press, Urbana, Illinois.
- . 1973b. 'On the Alternation of Vowel Length in Klamath: A Global Rule,' in M. Kenstowicz and C. Kisseberth, eds., Issues in Phonological Theory, Mouton, The Hague.
- Koutsoudas, A., G. Sanders, and C. Noll, 1974. 'On the Application of Phonological Rules', Language 50, p. 1-28.
- Kuroda, S.Y. 1967. Yawelmani Phonology. Research monograph no. 43, MIT Press, Cambridge, MA.
- Ladefoged, P. 1971. Preliminaries to Linguistic Phonetics, University of Chicago Press, Chicago, Illinois.
- Leben, W. 1973. Suprasegmental Phonology, distributed by Indiana University Linguistics Club.
- . 1978. 'The Representation of Tone', in V. Fromkin, ed., Tone: A Linguistic Survey, Academic Press, New York.
- . 1980. 'A Metrical Analysis of Length', Linguistic Inquiry 11, p. 497-509.
- Levin, J. 1983. 'Reduplication and Prosodic Structure', MIT ms.
- . to appear. 'Conditions on Syllable Structure and Categories in Klamath Phonology', in the proceedings of the 1984 West Coast Conference on Formal Linguistics.
- . in prep. 'The X-Tier and Klamath Phonology'.
- Liberman, M. and A. Prince. 1977. 'On Stress and Linguistic Rhythm', Linguistic Inquiry 8, p. 249-336.
- Lightner, T. 1963. 'A Note on the Formulation of Phonological Rules', Quarterly Progress Report of the Research Laboratory of Electronics, MIT 68, p. 187-189.

References

- Liljencrants, J. and B. Lindblom, 1972. 'Numerical Simulation of Vowel Quality Systems: The Role of Perceptual Contrast', Language 48, p. 839-862.
- Marantz, A. 1982. 'Re Reduplication', Linguistic Inquiry 13, p. 435-482.
- Mascaro, J. 1976. Catalan Phonology and the Phonological Cycle, Doctoral dissertation, MIT.
- McCarthy, J. 1979a. Formal Problems in Semitic Phonology and Morphology, Doctoral dissertation, MIT.
- . 1979b. 'On Stress and Syllabification', Linguistic Inquiry 10, p. 443-466.
- . 1981. 'A Prosodic Theory of Nonconcatenative Morphology', Linguistic Inquiry 12, p. 373-418.
- . 1984. 'Theoretical Consequences of Montanes Vowel Harmony', Linguistic Inquiry 15, p. 291-315.
- Mohanan, K.P. 1982. Lexical Phonology, Doctoral dissertation, MIT. Distributed by Indiana University Linguistics Club.
- . 1983. 'The Structure of the Melody', MIT ms.
- and T. Mohanan. 1983. 'Lexical Phonology of the Consonant System in Malayalam', MIT ms.
- Nanni, D. 1977. 'Stressing Words in -Aive', Linguistic Inquiry 8, p. 752-763.
- Newman, S. 1944. The Yokuts Language of California, The Viking Fund Publications in Anthropology #2, New York.
- Noske, R. to appear. 'Syllabification and Syllable Changing Processes in Yawelmani', in H. van der Hulst and N. Smith, eds., Proceedings of the Amsterdam Workshop on Nonlinear Phonology 1983.
- Prince, A. 1980. 'A Metrical Theory for Estonian Quantity', Linguistic Inquiry 11, p. 511-562.
- . 1983. 'Relating to the Grid', Linguistic Inquiry 14, p. 19-100.
- Pulleyblank, D. 1983. Tone in Lexical Phonology, MIT PhD dissertation.

References

- . 1984. 'Default Vowels', paper presented at the University of Massachusetts in Amherst.
- Pullum, G. 1973 'Yokuts Bibliography: An Addendum', International Journal of American Linguistics 39, p. 269-271.
- Rappaport, M. 1984. Issues in the Phonology of Tiberian Hebrew, Doctoral dissertation, MIT.
- . to appear. 'Stress and Ultra-Short Vowels in Tiberian Hebrew', in the proceedings of the 1984 West Coast Conference on Formal Linguistics.
- Reid, L. 1973. 'Diachronic Typology of Philippine Vowel Systems', in T. Sebeok, ed., Current Trends in Linguistics vol. 11, p. 485-506, Mouton, The Hague.
- Rice, L. 1969. 'Review of Kuroda 1967', International Journal of Linguistics 35, p. 274-725.
- Romaro, C. 1976. 'Vowel Harmony in Telugu', Papers in Linguistic Analysis 1, p. 25-36, University of Delhi.
- Schein, B. 1981. 'Spirantization in Tigrinya', in H. Borer and Y. Aoun, eds., MIT Working Papers in Linguistics 3, p. 32-42.
- Selkirk, E. 1978. 'Comments on Morin's Paper: The French Foot: On the Status of "Mute" e', Studies in French Linguistics 1, p. 141-150.
- Smith, N. and B. Hermans, 1982. 'Nonconcatenatieve Woordvorming in het Sierra Miwok', Glott 5, p. 263-284.
- Stanley, R. 1967. 'Redundancy Rules in Phonology', Language 43, p. 393-436.
- Steinbergs, A. 1977. The Phonology of Latvian, Doctoral dissertation, University of Illinois, Urbana, Illinois.
- Steriade, D. 1979. 'Vowel Harmony in Khalkha Mongolian', in K. Safir, ed., Papers on Syllable Structure, Metrical Structure, and Harmony Processes, MIT Working Papers in Linguistics 1, p. 25-50.
- . 1981. 'Parameters of Metrical Harmony Rules', MIT ms.
- . 1982. Greek Prosodies and the Nature of Syllabification. MIT PhD dissertation.

References

- Troubetzkoy, N.S. 1929. 'Zur allgemeinen Theorie der phonologischen Vokalsystem', in J. Vachek, ed., A Prague School Reader in Linguistics, 1964, Indiana University Press, Bloomington, Indiana.
- . 1969. Principles of Phonology, University of California Press, Berkeley, California.
- Walli, E. to appear. 'On the Representation of Complex Segments and their Formation in Kinyarwanda', in D. Archangeli, A. Barss, and R. Sproat, eds., MIT Working Papers in Linguistics 6.
- Williams, E. 1976. 'Underlying Tone in Margi and Igbo', Linguistic Inquiry 7, p. 463-484.
- Withgott, M. 1982. Segmental Evidence for Phonological Constituents, Doctoral Dissertation, University of Texas, Austin, Texas.
- Yip, M. 1982. 'Reduplication and C-V Skeleta in Chinese Secret Languages', Linguistic Inquiry 13, p. 637-661.