

Creating a Low-Cost, Low-Particulate Emissions Corn Cob
Charcoal Grinder for Use in Peru

by

Ashley Elizabeth Thomas

SUBMITTED TO THE DEPARTMENT OF MECHANICAL ENGINEERING IN PARTIAL
FULFILLMENT OF THE REQUIREMENTS FOR THE DEGREE OF

BACHELOR OF SCIENCE IN MECHANICAL ENGINEERING
AT THE
MASSACHUSETTS INSTITUTE OF TECHNOLOGY

[June 2008]

May 19, 2008

© 2008 Ashley Elizabeth Thomas. All rights reserved.

The author hereby grants to MIT permission to reproduce
and to distribute publicly paper and electronic
copies of this thesis document in whole or in part
in any medium now known or hereafter created.

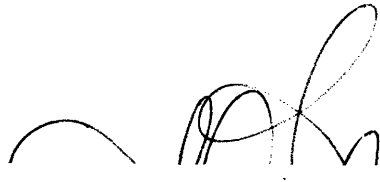

Signature of Author: _____

Ashley Thomas
Department of Mechanical Engineering
May 19, 2008

Certified by: _____

Amy Smith
Senior Lecturer
Thesis Supervisor

Accepted by: _____

John H. Lienhard V
Professor of Mechanical Engineering

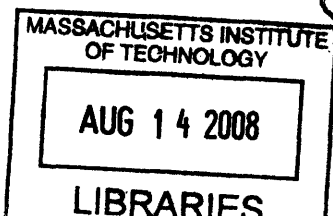

ARCHIVES

Creating a Low-Cost, Low-Particulate Emissions Corn Cob Charcoal Grinder for Use in Peru

by

Ashley Elizabeth Thomas

Submitted to the Department of Mechanical Engineering
on May 16, 2008 in partial fulfillment of the
requirements for the Degree of Bachelor of Science
in Mechanical Engineering

ABSTRACT

Indoor air pollution is a serious health risk in developing countries, and is the leading cause of death for children under five. By replacing traditional cooking fuels with charcoal, one can significantly reduce a user's exposure to the particulate matter responsible for the detrimental health effects. The MIT D-Lab has developed a method of creating charcoal using agriculture wastes such as bagasse and corncobs. However, it has been found that corncob charcoal produces dangerously high levels of carbon monoxide and as a result is unable to be burned directly and must be briquetted. In conjunction with this, an organization in Lima, Peru called Enlace Solidario makes coal briquettes in a configuration that optimizes the burning performance. They have entered in a partnership with the nearby orphanage of Segrada Familia to produce cooking fuel at no cost. However, Segrada Familia must supply their own ground charcoal to be briquetted. Thus, there is a clear need for a charcoal grinding machine. This thesis developed a successful grinding mechanism based on a peanut sheller design developed by the Full Belly Project. Though it needs to be scaled up to achieve the required throughput, this mechanism successfully limits the user's exposure to charcoal dust created during the grinding process and provides a means to produce corn cob powder necessary to briquette charcoal.

Thesis Supervisor: Amy Smith
Title: Senior Lecturer in Mechanical Engineering

Acknowledgements:

I would like to thank Amy Smith first and foremost for her continual support during this, and my myriad of other projects. I also like to thank the rest of the charcoal family including Kendra Leith, Amy Banzaert, and Manpreet Singh for their valuable wealth of charcoal knowledge.

Table of Contents

1. INTRODUCTION	1
2. BACKGROUND.....	8
2.1. GLOBAL HEALTH CONCERN	8
2.2. CHARCOAL PRODUCTION PROCESS	10
2.3. CARBON MONOXIDE EMISSIONS	10
3. DESIGN PROCESS	13
3.1. DESIGN REQUIREMENTS AND CONSTRAINTS	13
3.2. IDEA GENERATION AND SKETCH MODELS	14
3.3. PROTOTYPING	17
4. MANUFACTURING	19
4.1. STATOR	19
4.1.1. <i>Design</i>	19
4.1.2. <i>Manufacturing</i>	20
4.2. ROTOR.....	24
4.2.1. <i>Design</i>	24
4.2.2. <i>Manufacturing</i>	25
4.3. OTHER COMPONENTS	27
4.4. ASSEMBLY	31
5. RESULTS.....	33
6. CONCLUSIONS	34
7. APPENDIX	36

1. Introduction

Charcoal made from agricultural waste has been recognized as a solution to many issues in the developing world. First, it is made from waste, such as corn cobs, and replaces charcoal made from wood, thus reducing deforestation. Second, it produces lower particulate emissions during burning than wood. Lastly, charcoal made from corn cobs is less expensive than many other fuels, providing an economic incentive for users.

Enlace Solidario is an organization in Lima, Peru that creates a briquette with a configuration that improves burning characteristics. An example of this type of charcoal briquette can be seen in Figure 1.



Figure 1: Charcoal produced by Enlace Solidario

Crushed coal arrives at the Enlace Solidario from mines in the northern region. The coal is then mixed with dry clay, lime and water to form a briquette mixture. Finally, the mixture is formed into briquettes with a hydraulic press. Figures 2-4 illustrate this process.



Figure 2: Raw coal before briquetting

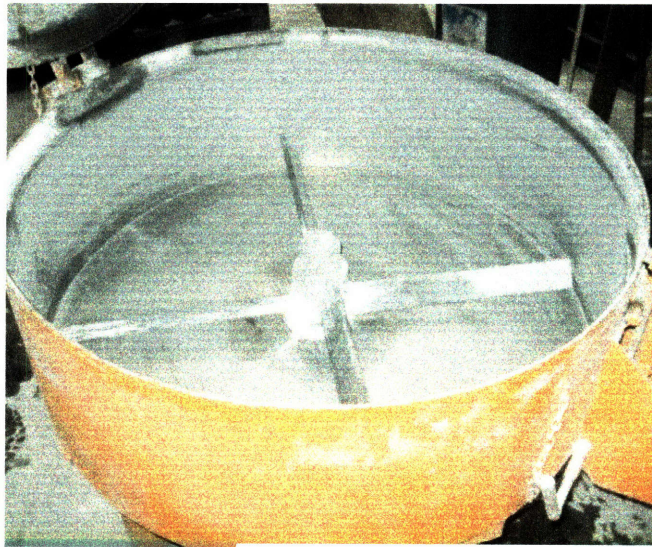

Figure 3: Mixer

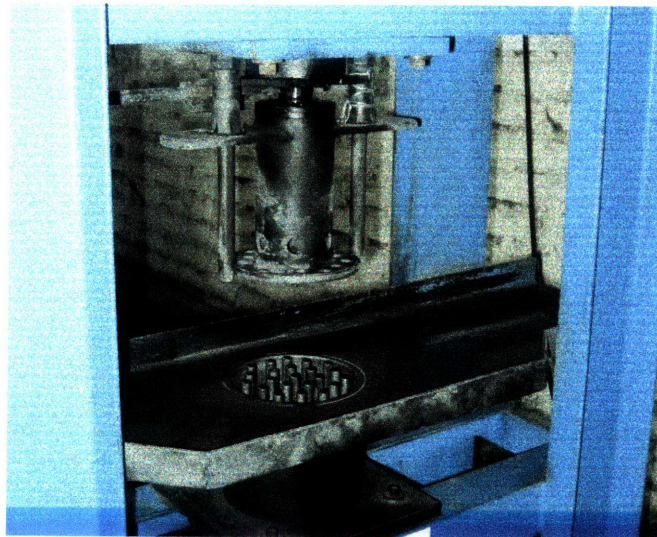

Figure 4: Hydraulic Press

Recently, Enlace Solidario developed a partnership with Segrada Familia, an orphanage in Lima, to make briquettes from corncob charcoal to power the cooking fires of the orphanage. In January, a D-lab trip to Peru visited Segrada Familia and instructed the older children in the corn cob charcoal making process. This provides opportunities for the youths upon graduating from the orphanage. However, to use the charcoal equipment of Enlace Solidario, the carbonized corncobs must first be ground into a powder. Moreover, crushing the carbonized corn cobs and forming them into briquettes mitigates one of the major health issues related to charcoal-based cooking fuels-- carbon monoxide. When burned directly, corn cob charcoal produces extremely high levels of CO, but produce much less when briquetted before burned. Figure 5 illustrates the CO emissions of corn cob charcoal under in both configurations correlated with the health effects of exposure.

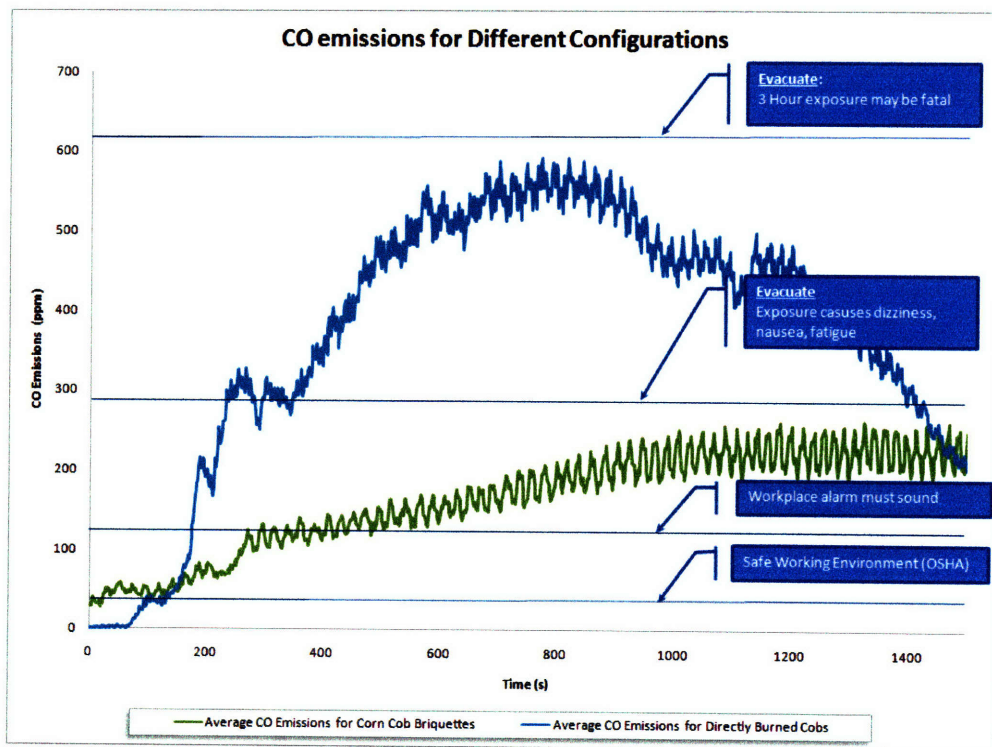

Figure 5: Plot of Carbon Monoxide Emissions from Corn Cob Briquettes and Corn Cob Charcoal with exposure notes

Although both fuels produce very high levels of carbon monoxide, the corn cob charcoal briquette barely reaches half of a lethal dose, where unbriquetted charcoal surpasses the lethal dose.

These levels of carbon monoxide emissions are similar to other types of charcoal and for this reason it is crucial to burn charcoal in an outdoor cooking area or in well ventilated areas. Thus, it is equally important to briquette the cobs for the health of the user as well as providing access to cooking fuels for Segrada Familia.

The goal of this thesis will be to create a corncob charcoal grinder with the following technical requirements:

1. Costs less than \$50 with a goal of \$30
2. Can be produced in Lima, Peru
3. Is human-powered
4. Grinds a variety of corncob sizes
5. Produces a powder with a particle size of smaller than 5mm
6. Grinds at least 0.5kg per minute
7. Limits the user's exposure to charcoal dust

These seven requirements will be the basis for evaluating the prototypes developed in this thesis.

2. Background

2.1 Global Health Concern:

Indoor air pollution is one of the most pressing health issues facing the world's poor. Nearly half of the world's population, 3 billion people, uses biomass fuels for cooking and heating. These fuels release toxic emissions during combustion and are responsible for the deaths of 1.5 million people annually

¹. Women and children are particularly vulnerable to indoor air pollution due to the large amount of time spent cooking, and it is the number one killer for children under five².

According to the Environmental Protection Agency's Partnership for Clean Indoor Air, indoor air pollution is the fourth leading health risk in developing countries³. Moreover, the World Health Organization (WHO) has concluded that the particulate inhalation leads to a

myriad of health issues including doubling a child's chance of contracting a respiratory infection and increasing a woman's risk of miscarriage.

A person's exposure to smoke is dependent on the concentration of toxins within the air and the duration of exposure. In a study done by the EPA⁴, women typically spend between 3 and 7 hours per day near a fire. Moreover, in many parts of the world small children are carried on the mother's chest or back, and are thus exposed to an equal amount of smoke from a very early age. There are six major toxins present in smoke:

1. Particulate matter
2. Carbon monoxide
3. Nitrous oxides
4. Sulphur oxides
5. Formaldehyde
6. Carcinogens

Although all are very damaging to health, studies have shown that particulate matter smaller than 10 microns (PM₁₀) can penetrate deep into the respiratory tract and are the most detrimental to one's health.⁵ In a normal 24 hour period, a woman cooking with a biomass (wood, dung, etc.) can inhale on average 10,000 µg/m³, more than ten times the safe limit set by the United States Environmental Protection Agency. This sustained exposure to PM₁₀ causes acute respiratory infections (ARI), broadly categorized into two groups, Acute Lower Respiratory Infections (ALRI) and Acute Upper Respiratory Infections (AURI).

It has been found that charcoal produces less than a quarter of the particulate matter produced by wood⁶. This striking difference in emissions results from the wood carbonization process. Raw wood contains volatile organic compounds that evaporate when heated, and are the source of PM₁₀ particles⁷. However, during the carbonization process to create charcoal, the volatile compounds are consumed in the burn. Thus, the resultant product, charcoal, produces very few particulates when it is burned as fuel.

2.3 Charcoal Production Process

Charcoal is simply carbonized organic matter, and is created when such matter is burned at high temperatures in a low-oxygen environment. As mentioned earlier, this thesis deals specifically with the issue of charcoal made from corn cobs, and thus documents the corn cob charcoal production process.

After harvesting the ears of corn, the majority of the harvest is left to sun-dry. After drying, the kernels are removed to produce a corn flour, and the dried cob remains. In the case where the corn was eaten without being dried, the cobs would need to be dried for several days to ensure proper carbonization.

When heated to a temperature greater than 270°C, a chemical reaction occurs to convert the organic matter into carbon. A kiln is required to create a low-oxygen environment in which to carbonize the cobs. Illustrations of a simple kiln and a more thorough description of the charcoal production procedure can be found in Appendix 1.

2.4 Carbon Monoxide Emissions

Although charcoal produces significantly less PM₁₀ when burned, it produces significantly more carbon monoxide, especially when burning corn cob charcoal. Exposure to CO can range from subtle flu-like symptoms in chronic low-dose exposure to asphyxiation in high levels. Carbon monoxide can easily pass from the lungs into the blood stream forming a complex with hemoglobin known as carboxyhemoglobin (CO_{Hb}). CO_{Hb} in the blood stream prevents oxygen from binding to the hemoglobin and causes hypoxia. The amount of CO_{Hb} that is formed is

largely dependent on concentration and duration of carbon monoxide exposure. Factors such as physical activity during exposure, ambient pressure, and the health and metabolism of the individual play a lesser, but important role⁸. The concentration of CO_{Hb} in the blood stream is a critical measurement when evaluating health effects, but impractical to measure in the field. Thus, a mathematical model was developed⁹ to estimate percent CO_{Hb} from measured carbon monoxide values. Figure 6 depicts the Coburn-Foster-Kane equation that models this trend

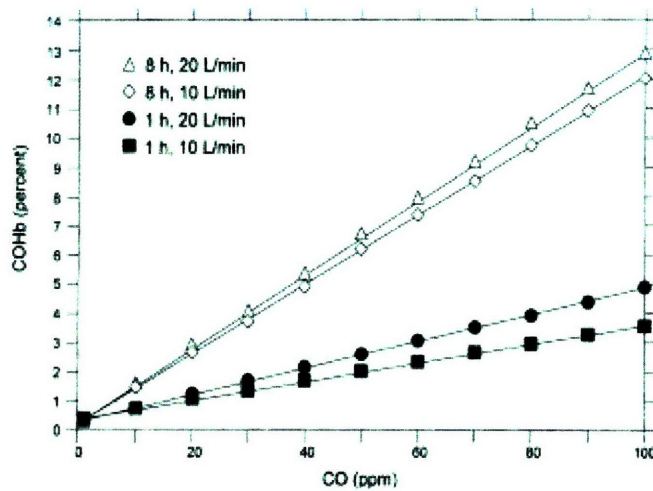

Figure 6: Relationship between CO exposure and COHb levels in the blood. Predicted COHB levels resulting from 1 and 8 h exposures to CO at rest (alveolar ventilation rate of 10 l/min) and with light exercise (20 l/min) are based on the Coburn- Forester- Kane equation¹⁰

Based on the above graph, nonsmoking adults exposed to 25-50 ppm for 8 hours with light exercise would experience between 4 and 7% CO_{Hb}. Similarly, an exposure of 100 ppm during the same period would result in 12-13 percent CO_{Hb}. Table 1 illustrates the health effects of CO_{Hb} percentages.

Population	CO_{Hb} %	Clinical Symptoms
Healthy Adults	0-10%	Normal, shortness of breath with vigorous exercise ¹¹
	10-20%	Headache, flushed skin, shortness of breath with moderate exercise, decrements in hand-eye coordination, inattention
	20-30%	Headache, throbbing temples, irritability, emotional instability, impaired judgment, memory impairment, rapid fatigue
	30-40%	Dizziness, weakness, nausea and vomiting severe headache, visual disturbances, confusion
	40-50%	Intensified symptoms, hallucinations severe ataxia, tachypnea
	> 50%	syncope, coma, tachycardia with weak pulse, incontinence of urine and feces, confusions, loss of reflexes, cyanosis, respiratory paralysis, death
Developing Fetuses	5-10%	reductions in birth weight
	15-25%	cardiomegaly, delays in behavioral development, disruption of cognitive function, increased occurrence of SIDS

Table 1: CO_{Hb} % and health effects in different populations

According to a study performed by researchers at the University of California at Berkeley, the average exposure for women and children burning charcoal in an unvented cook stove for one hour was approximately 528 ppm which converts to 20% CO_{Hb}. According to the American Conference of Governmental Industrial Hygienists (ACGIH), the threshold limit value for CO in the work environment is 9.66 ppm or under 1% CO_{Hb}. This huge difference between the

recommended safe limit and the actual exposure of women in developing countries is a serious cause for concern when using charcoal as a fuel.

3. Design process:

3.1 Design Requirements and Constraints:

Table 2 summarizes the design criteria motivating this thesis. Of particular concern was the ground charcoal's ability to form the briquettes, the throughput, and the health of the user. Other design criteria are common constraints of design for developing countries.

Attribute	Metric	Unit	Value
Ground charcoal is able to be briquetted with current amount of clay	Does a solid briquette come out of press?	Yes/No	X
Limits Exposure to Charcoal PM, is equal to or better to the bag method	Particulate Matter Levels	PPM	<7.71 peak PPM
Affordable for average wage in Peru	Cost	Dollars	Under \$50
Able to be manufactured and repaired in Peru	Made of materials and processes commonly available	Yes/No	X
Throughput	Rate	Kg/min	>0.5 Kg/min

Table 2: Design Requirements

The critical requirement of the ground charcoal is that it must be able to be formed into briquettes. The forming of briquettes involves mixing the ground charcoal with a clay binder and compressing it in a press. To maximize profits from the sale of the briquettes, the minimum possible amount of clay binder must be used. This design requirement limits the particle size of

the ground charcoal, the finer the particle size, the less clay is needed to bind. Moreover, there has to be a minimum percentage of finely ground particles to ensure that briquettes can be formed. It has been found that the briquette performance does not decrease as particle size increases up until about a quarter inch, and thus as long as the minimum percentage of finely ground particles is achieved, the fineness of the particles is not critical.



The effects of long-term inhalation of coal is well documented due to the pandemic of black lung disease among miners¹². Similarly, the inhalation of charcoal has equally seriously health effects. Thus, it is critical to limit exposure to charcoal dust. Moreover, one must account for children within the vicinity of charcoal production. Thus, the product must not only be designed for the user's exposure, but also incidental exposure.

3.2 Idea Generation and Sketch Models:

Because there are many well established methods of grinding, there was no need to create a revolutionary grinding method. Instead, several existing grinding mechanisms were tested with corncob charcoal and the resulting products were compared. Five methods were compared to the original bag method, described later in the document, over a series of four tests.

1. Percent loss: How much of the material was lost in the grinding process
2. Percent of product finely ground: This measures the percentage of ground charcoal that is smaller than 2mm and can mix with the clay to bind the briquette.
3. Time to grind 50g: This measures grinding rate
4. Max/Average PM: This measures both the maximum and average exposure to PM10 during the grinding process. The sensor was worn around the operator's neck to gauge the user's exposure to PM10.

These four tests were performed on five different grinding methods to compare strengths and weaknesses of each design. Details of each tested grinding mechanism appears in Table 3.

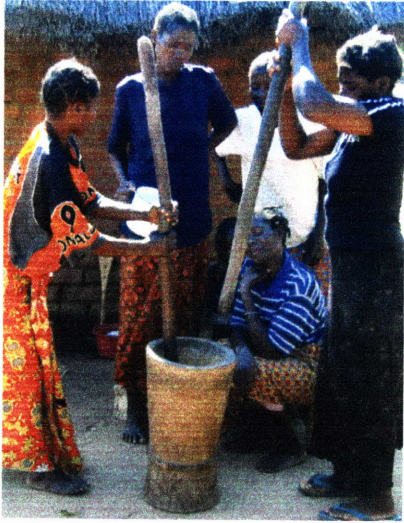
Method	Details	Photo
1. Bag Method	<ul style="list-style-type: none"> • Current Technique • Load a set amount of charcoal into a plastic trash bag or a double-layered rice bag • Crush with cinderblock or with body weight 	
2.	<p>Victoria Mill</p> <ul style="list-style-type: none"> • Traditional grain mill that grinds the charcoal between a pair of grinding plates 	
3.	<p>Mortar and Pestle</p> <ul style="list-style-type: none"> • A traditional Ghanaian wooden mortar and pestle were used to crush the charcoal between two hard surfaces. 	

4.	<p>Peanut Sheller</p> <ul style="list-style-type: none"> • Developed by the Full Belly Project to shell peanuts • Grinds due to friction between the cob and the concrete surfaces as the gap between the rotor and stator decreases 	
5.	<p>Inverted cone</p> <ul style="list-style-type: none"> • Vertical, hollow cone with a rotating pa rotor grinders against the surface objects 	
6.	<p>Rolling Pin</p> <ul style="list-style-type: none"> • The same process as the bag method but using a rolling cylinder instead of a cinderblock 	

Table 3: Grinding Methods

These results were laid out in a Pugh chart to select the best grinding method. The Pugh chart appears in Table 4.

Grinder Type	Max PM	Ave PM	Percent "large"	Ease of Manufacture	Grinding Rate	Ease of Use	Continuous Process	Percent Loss	Sum
Bag	0	0	0	2	0	0	0	0	2
Victoria Mill	-2	-2	2	-3	-1	2	1	-1	-4
Mortar and Pestle	-1	-1	-1	1	0	1	0	0	-1
Peanut Sheller	-1	-1	1	-2	2	2	1	-1	4
Vertical Cone	-2	-2	1	0	-1	1	1	-2	-4
Rolling Pin	0	0	0	1	1	1	0	0	3

Table 4: Pugh Chart Selection Criteria

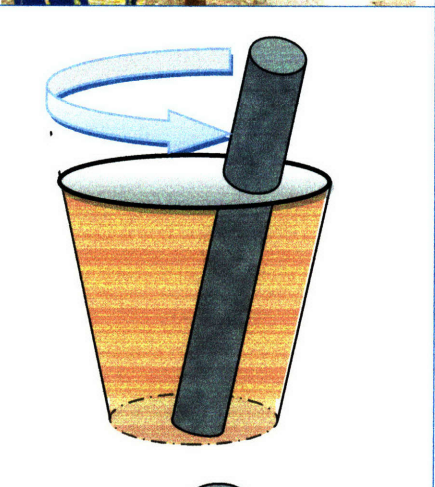
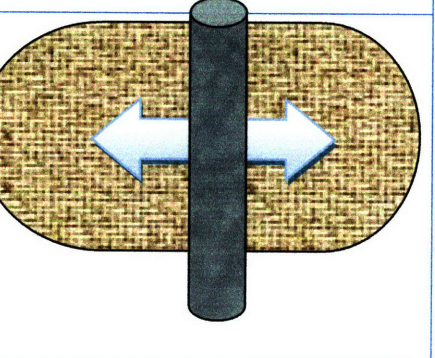
Based on the Pugh Chart, it was decided that the best approaches were the peanut sheller and the rolling pin design.

3.3 Prototyping

Prototypes were constructed to further test the peanut sheller design. The peanut sheller is a well tested and established technology and thus improvements in the component design was not necessary. However, constructing a peanut sheller in the developing world requires the purchase of expensive fiberglass molds, which are not only difficult to obtain but also too costly for the average person to afford. Thus, a bulk of this thesis was dedicated to designing a method for manufacturing peanut sheller style molds from locally available materials. Moreover, the peanut sheller was designed for peanut-sized output. The design had to be optimized for a corncob-sized

input and powder output. Figures 7 and 8: Identify the components of the entire mechanism (Figure 7) and the Rotor (Figure 8)

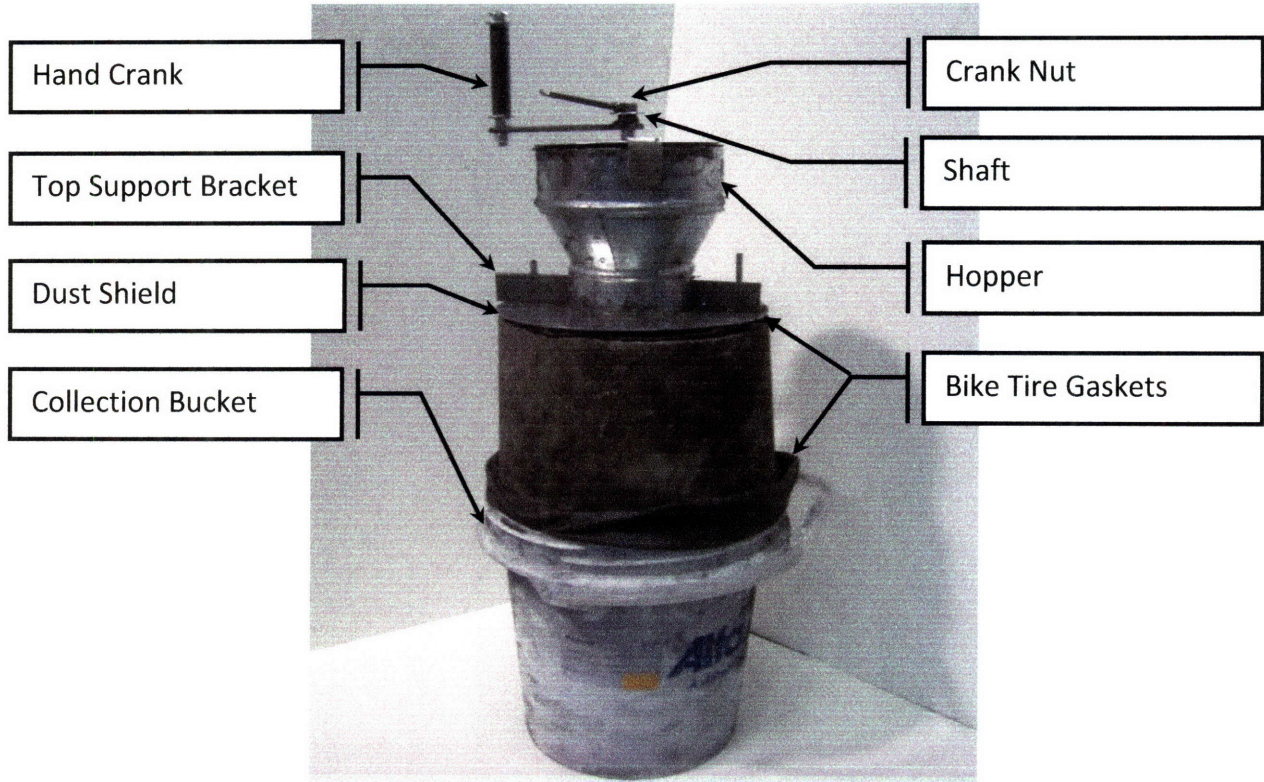

Figure 7: Full Assembly of rotor and stator mechanism

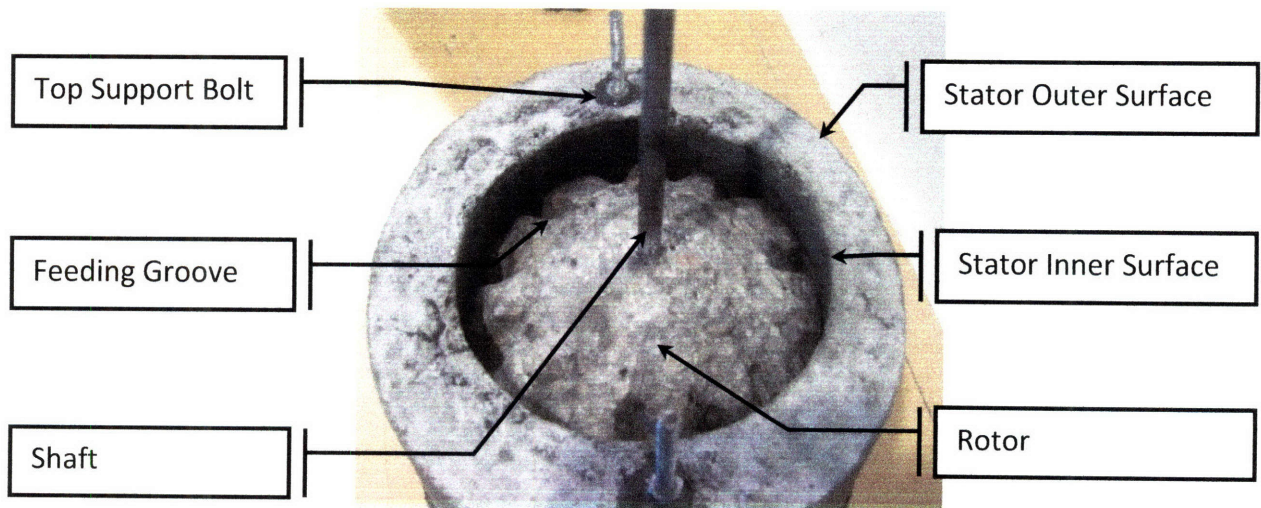

Figure 8: Inside view of stator

4. Manufacturing

4.1 Stator:

4.1.1 Design:

There are two critical features of the stator. First, it must be strong enough to support the weight of the rotor, prevent breaking or cracking during general use and assembly, and withstand the torque applied during operation. Secondly, it must have a very round inner surface that is concentric with the rotor.

To maximize the strength of the concrete walls, this project uses fiber reinforced concrete. The aggregate particles should not exceed a quarter inch in diameter, and should consist mostly of smaller gravel. Lastly, all walls must be at least a quarter inch thick. Because the metal support pieces are inserted into the walls of the concrete when cast there must be at least a quarter of an inch between each side of the support piece and the closest wall, as illustrated below.

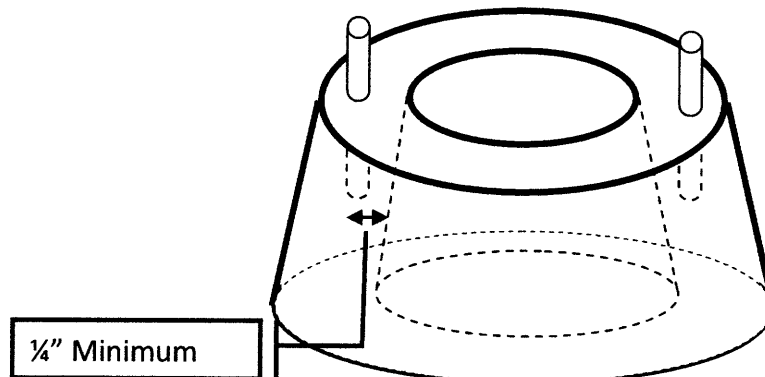

Figure 9: Illustration of minimum wall thickness

The stator's inside surface was created using a ceramic mold. Because ceramic pots are thrown on a potter's wheel, they are generally very circular around their central axis. Moreover, ceramic work is a common process in many developing countries, and thus is appropriate for this application. Ceramic pots also have an advantage over plastic buckets, which were used in early iterations of this design, because they are not flexible and do not deform with the weight of the concrete.

What is notable in these design criteria is the fact that the outer surface shape is not critical, and that it can be any shape as long as it meets the minimum wall thickness. A similarly shaped cylinder was selected to minimize the concrete usage. A picture of the mold assembly appears below in Figure 10.

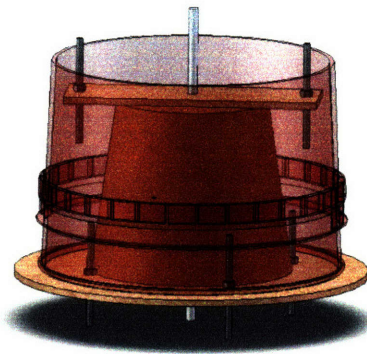

Figure 10: Illustration of stator mold

4.1.2 *Manufacturing:*

This manufacturing plan is based on the design of a cylindrical outer wall and an inner wall mold made from a ceramic pot tapered from 6" to 8" in diameter. These can be modified to accommodate other wall geometries. A step-by step manufacturing plan appears in Table 5.

Parts Needed:

1. Enough concrete mix to fill mold
2. 14" diameter plywood circle at least ½" thick
3. 8" diameter plywood circle at least ½" thick, tapered to approx. 15°
4. 8" top diameter tapered ceramic pot
5. 4 x 4" Lengths of ¼"-20 threaded Rod
6. 2 x 3" Lengths of ¼"-20 threaded Rod
7. 12 x Hex Nuts (¼"-20)
8. 6 x ¼" Flat Washers
9. 5 gallon plastic bucket for outer wall mold with bottom 6" removed
10. Plastic Sheeting
11. Viscous grease

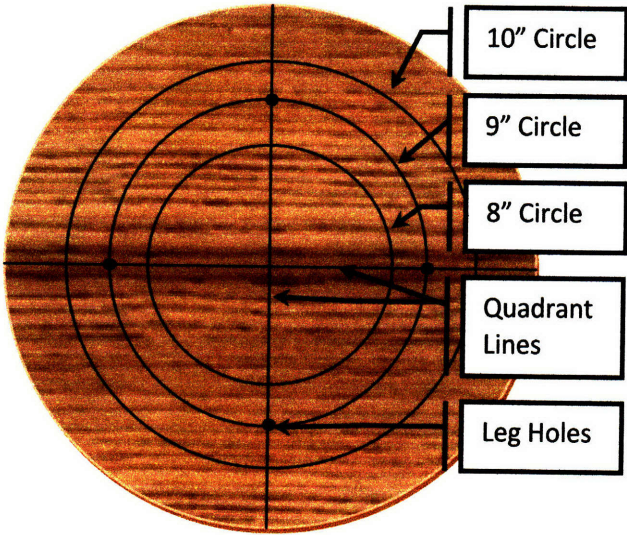
<p>1.</p> <ul style="list-style-type: none">• Cut a 14" Plywood circle• Draw concentric 8", 9", and 10" circles• Divide the disk into 4 quadrants and draw dividing lines	 <p>The diagram shows a circular plywood disk with three concentric circles drawn on it. The outermost circle is labeled '10" Circle', the middle one '9" Circle', and the innermost one '8" Circle'. Two perpendicular lines intersect at the center, labeled 'Quadrant Lines'. Four small circles are drawn on the 8-inch circle, labeled 'Leg Holes'.</p>
<p>2.</p> <ul style="list-style-type: none">• Cut a 8" diameter plywood circle• Sand the edges to a roughly 15° taper	

3.

- Attach tapered 8" piece to center of 14" piece
-
- Drill a 3/8" hole through both pieces in the exact center of the assembly

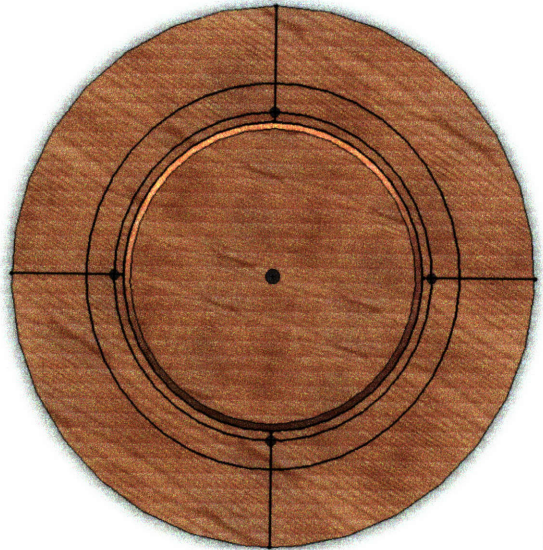

4.

- Bolt Legs into each of the four holes

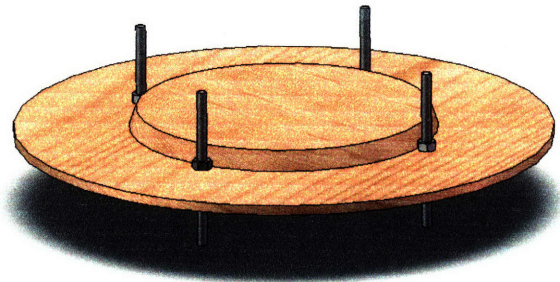

5.

- Attach outer wall mold to the rest of the mold using the 10" circle as a locating line
- Use small wood screws to bolt the bucket to the bottom wood circle

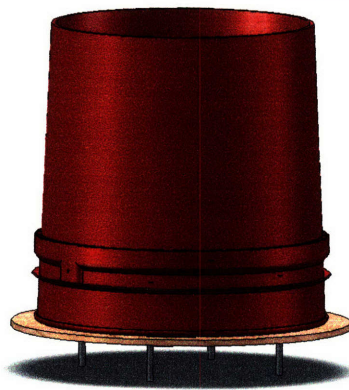

6.

- If using a purchased ceramic pot, it might be necessary to cut off a lip to result in a smoothly tapered cylinder

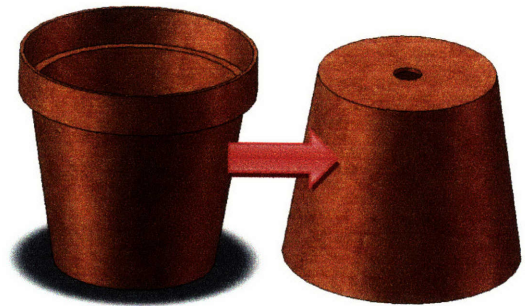

7.

- Cover the cylinder with a tightly fitted sheet of plastic

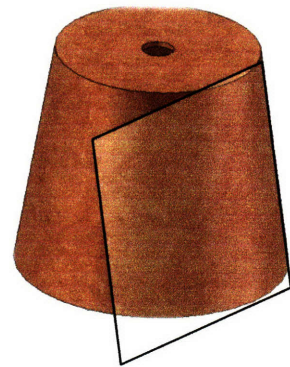

8.

- Put the wrapped ceramic mold on top of the wooden tapered support disk

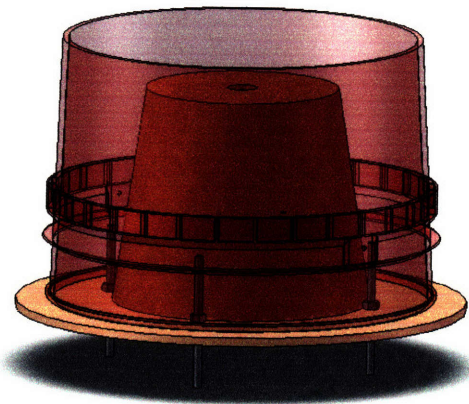

9.

- Cut a 7"x 2" piece of plywood
- Drill $\frac{1}{4}$ " holes a half inch from each side
- Drill a $\frac{3}{8}$ " hole in the center

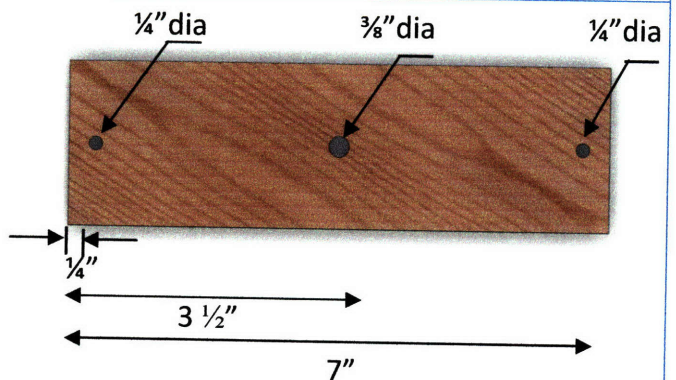

10.

- Bolt the two 3” pieces of threaded rod into the holes in the piece.
- The rods should extend equally on either side of the wood.
- Place on top of ceramic pot in mold and use a 3/8” rod to keep piece in center

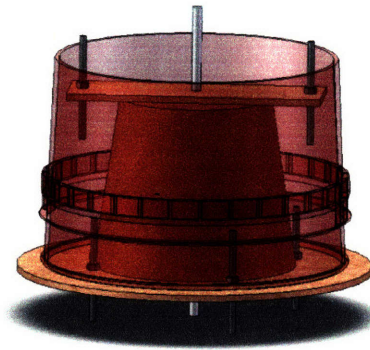

11.

- Mix cement according to manufacturer's specifications
- Pour concrete while taking precautions to remove all air bubbles before setting.

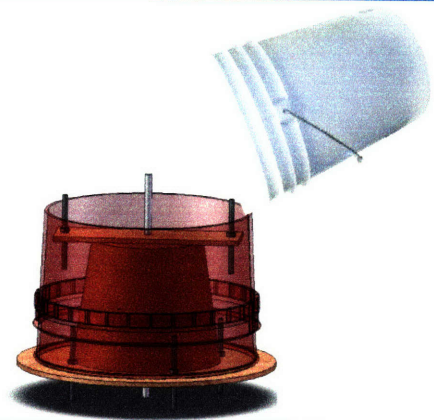

Table 5: Manufacturing of the stator

4.2 Rotor:

4.2.1 Design:

There are three critical features of the rotor. First, the central axis of the rotor must be perfectly aligned with the shaft both. This ensures that when the shaft rotates, the rotor spins about its center and is not lopsided. However, the top and bottom faces do not necessarily need to be perpendicular to the shaft or parallel with each other (though it is easiest to manufacture when they are). Secondly, the shaft must have wings that engage with the concrete so that when the shaft is rotated, it rotates the rotor instead of spinning freely inside the concrete.

4.2.2 Manufacturing:

Parts Needed:

1. Ceramic mold with same geometry as the stator inner surface mold- though it is not necessary to remove the “lip” if the part is bought. (8” top diameter tapered pot)
2. Epoxy or ceramic glue (not necessary if using ceramic molds without a bottom hole)
3. Plastic sheeting
4. 3/8” diameter steel rod
5. 3/8” tap
6. 2 pieces of 2” x 1” x 1/8” pieces of mild steel
7. 8” diameter plywood circle
8. (top of rotor)” diameter plywood circle
9. 2 x 3” long 3/8” ID piping

1. Rotor Shaft

- Weld two pieces of mild steel with dimensions of 2”x 1”x 1/8” to the 3/8” rod.
-
- Thread the top 2”
-
- The top of the top wing should be 5 inches from the bottom of the bottom wing

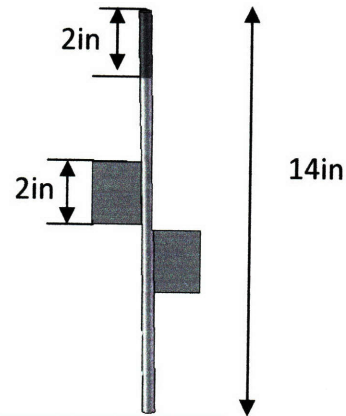

2. Rotor Mold

- Fill drainage hole with epoxy (if using a purchased ceramic pot)
- Locate exact center
- Drill a 3/8” hole in the center of the top surface

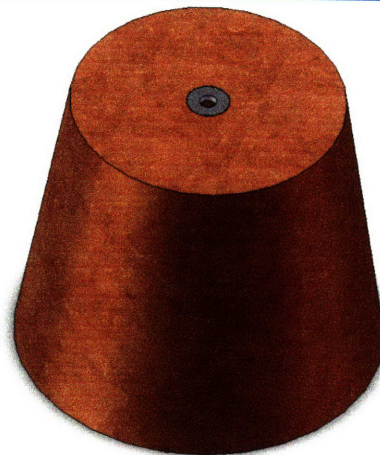

3.

- Cut a 6" and 8" plywood circle
- Drill a 1/2" hole in the center of each

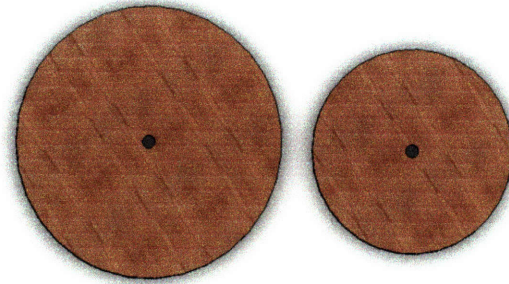

4.

- Put 6" disk inside ceramic mold
- Line top surface of 6" disk and inside of the ceramic mold with a liberal amount of grease
- Slide the shaft in place- it will rest on the bottom wood piece
- Mix concrete and pour into mold
- Replace 8" disk and check alignment between disks
- Cure the concrete according to manufacturer's directions

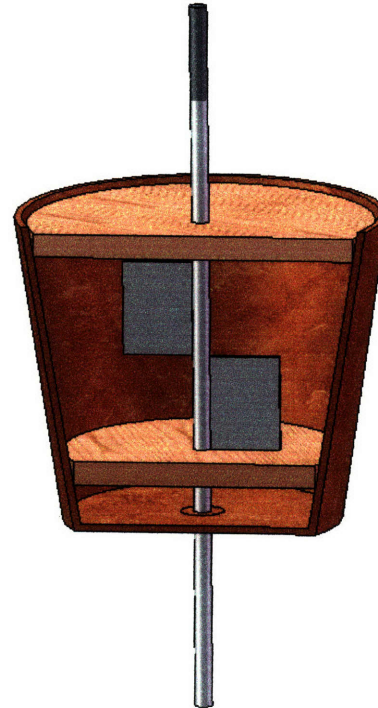

5. Rotor Finishing

- After curing, taper the top surface of the rotor to roughly a 15° angle
- Cut 6 feeding grooves evenly spaced along rotor.
 - Grooves should be about 3/4" wide at top to 1/8" wide at bottom
 - Should extend from 2" away from outside top of rotor to halfway down the side of rotor
 - Should curve to left at the bottom

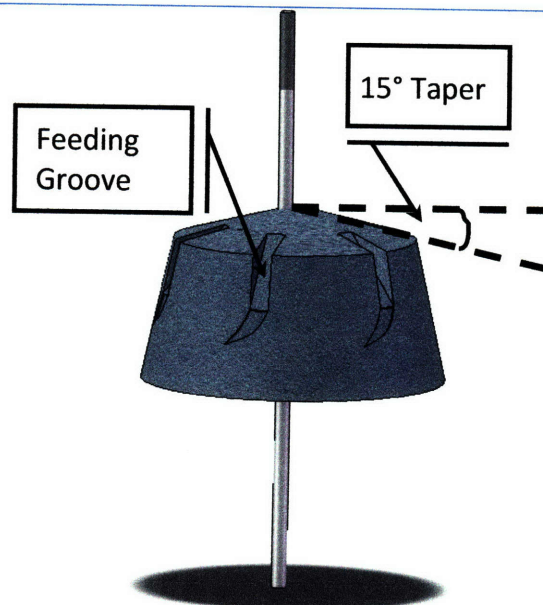

Table 6: Manufacturing of Rotor

4.3 Other Components:

The metal components are all components used by the Full Belly Project with some slight modifications.

Parts needed:

1. 3 x 3" long 3/8" ID steel pipe
2. 2 x 10" long of 1" angle iron
3. 2 x 3.8" U-bolt
4. 3" piece of 1/4" steel bar
5. 5" piece of 1/4" thick 3/4" wide angle iron
6. 2 x 3/8" nut
7. 3 x 1/4" nut
8. 2 large, flat washers
9. 5" of 1/4" ID steel tube
10. 4" long 1/4-20 hex bolt

1. Support Bracket:

- Cut a 1/2" clearance hole in the exact center of a 10" long piece of angle iron
- On the adjacent side, drill two clearance holes for a u-bolt to hold the piping in place
- Measure the distance from the central shaft to each of the top support bolts
- Drill holes in the angle iron to fit the support bolts

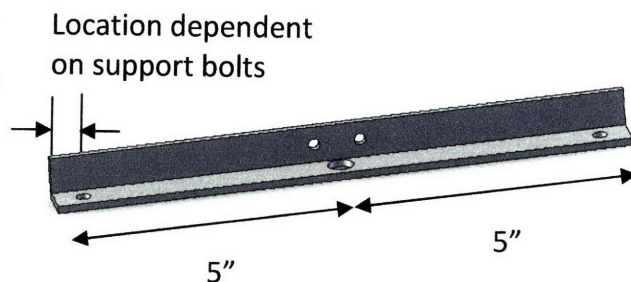

2.

- Fit pipe into $\frac{1}{2}$ " hole and secure with U-bolt

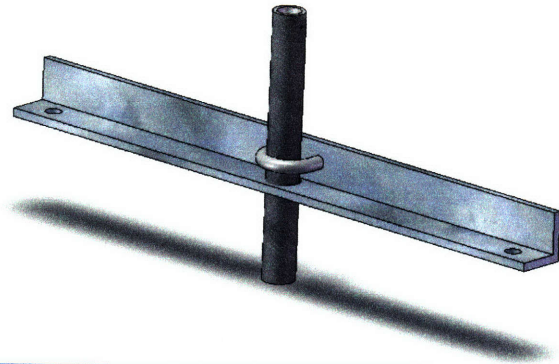

3. Handle:

- Drill a hole horizontally centered and roughly $\frac{1}{2}$ " from the end
- Weld a $\frac{3}{8}$ " nut onto the $\frac{1}{2}$ " piece so the hole is concentric to the threads in the nut
- Slide a washer, one of the metal tubes, second washer, and nut onto the bolt.

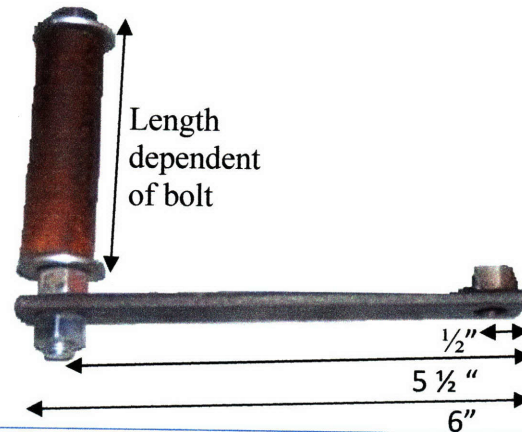

4. Crank Nut :

- Weld the 3" piece of steel onto the side of a $\frac{3}{8}$ " hex nut.

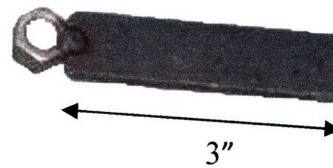

5.

- Repeat this process for the bottom support bracket
- Align brackets so they are perpendicular when viewed from above

6. Dust Shield

- Cut a piece of 1/8" thick sheet metal to the shape of the outside of the stator
- Cut a 5" diameter hole in the center of the dust shield
- Cut two 1/4" holes at the location of each of the support bolts on the top of the stator

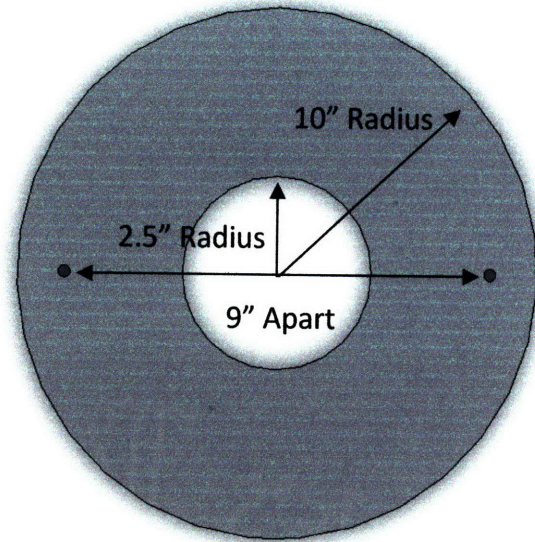

7.

- Cut 1/8" slits in the side of the pipe reducer so that it can slip over the angle iron



8.

- Place the dust plate onto the top of the stator
- Put support bracket on top of the dust plate
- Slide the slotted galvanized reducer onto support bracket
- Glue the galvanized reducer to the dust plate to minimize exposure to charcoal dust



9.

- Cut out two circles out of 1/8" Aluminum
- Drill a 1/2" clearance hole in the center of each circle
- Remove the top 1/3 of each circle

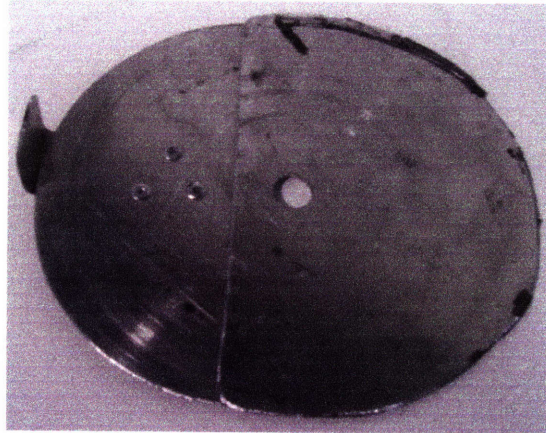

10.

- Rivet a small tab onto one of the moving plates

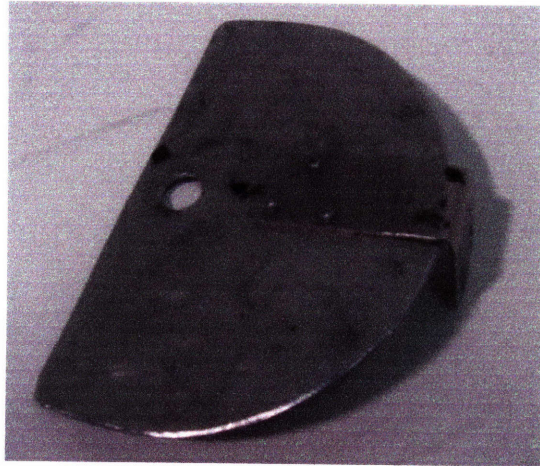

Table 7: Other Components Manufacturing

4.4 Assembly:

Parts Needed:

1. Rotor
2. Stator
3. Top and bottom support brackets
4. Dust shield and hopper
5. Bicycle innertube cut to the circumference of outer wall
6. 8 x ¼" - 20 Hex nuts and washers
7. 2 x 1" spacer

1.

- Insert rotor into stator
- Place bottom support bracket onto the stator legs/ support bolts
- Center bracket and loosely tighten bolts
- Screw on handle and crank nut to top of shaft



2.

- Put stator right-side up
- Slide washer onto each support bolt
- Place the dust guard, top support bracket and hopper assembly in place
- Place a bike inner tube between the stator and the dust screen. The pressure of the bolts will be enough to hold it in place



- 3.
- Place the sliding cover plates onto the shaft.
 - Attach the handle and washer by threading them onto the shaft
 - Align top and bottom brackets so that the rotor is perfectly centered
 - Measure the distance between support bolts on either side and move top and bottom brackets to the center
 - Check alignment by spinning rotor
 - Slide the top bracket until perfectly aligned
 - Once aligned, carefully tighten all bolts



4.

- Place on top of a bucket to collect ground charcoal



Table 8 :Assembly

5. Results:

A summary of the averages of the data collected during experiments using both the bag and rotor and stator methods appears below in Table 9.

Methods	kg/min	%Fine Particles	Average PM	Max PM	Cost
Bag	1.63	44.61	0.28	7.71	\$1
Rotor and Stator	0.27	88.11	0.15	0.41	\$15

Table 9: Comparison of grinding methods

Experiments with using the rotor and stator machine to grind corn cob charcoal resulted in lower PM emissions than any other grinding mechanism and comparable to the bag method. The rotor and stator method also has a significantly smaller maximum PM value. The effectiveness of the dust shield and the sliding plates can be seen in Figure 11.

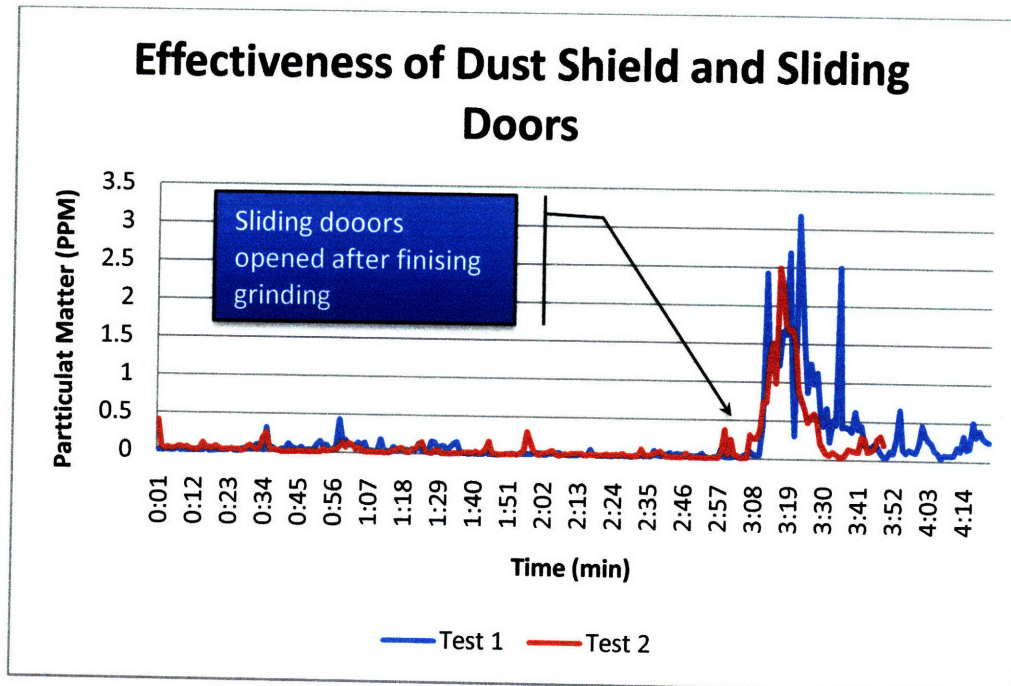

Figure 11: Effectiveness of dust shielding mechanisms

As can be seen in the figure, the particulate matter peaks when the doors are opened. During the rest of the test, particulate levels stay below 0.5 ppm.

Conversely, the rotor and stator method is much slower than the bag method. Where one can grind 1.63 Kg/min using the bag method, one can only grind 0.27 Kg in the same time using the rotor and stator. However, the bag method only produced 45% fine particles which means that the user did not spend enough time grinding. Because the bag method has no concrete way of determining sufficient grinding time, it is easy to grind for an insufficient length and produce lower quality ground charcoal. Moreover, the rotor and stator used for these tests was a prototype built to determine grinding performance. To achieve maximum grinding rate it should be scaled so that more carbonized cobs can be loaded into the hopper and also so that it can grind more cobs simultaneously. This design was a prototype based on the “Mini Nut Sheller” produced by The Full Belly Project. If scaled to the normally-sized sheller, one can expect drastic improvements in grinding rate.

6. Conclusion:

This thesis has successfully developed a corncob charcoal crushing mechanism which allows carbonized corncobs to be briquetted into a low particulate and reduced carbon monoxide emitting fuel. Moreover, it provides a mechanism by which the youth at Segrada Familia can earn an income while supplying the rest of the orphanage a cleaner burning fuel. Although the prototype developed in this thesis must be scaled-up to match the required grinding rate, the alpha prototyped served as a successful proof-of concept and justifies further development of a full scale model. Charcoal provides a source of income for the producers, a health benefit to the users, and a means to stall deforestation. This is a unique situation where social, environmental, and economic goals align to a common solution which is enabled by this device.

¹Warwick H and Doig A. "Smoke—The Killer in the Kitchen: Indoor Air Pollution in Developing Countries." London:ITDG,2004, pp.1

²Warwick H and Doig A. "Smoke—The Killer in the Kitchen: Indoor Air Pollution in Developing Countries." London:ITDG,2004, pp.1

³Environmental Protection Agency. "Partnership for Clean Indoor Air " January 2007. Winrock International. 2 May 2008 < <http://www.pciaonline.org/site/c.krLWJ7PIKqG/b.2660445/>>

⁴Environmental Protection Agency. "Partnership for Clean Indoor Air " January 2007. Winrock International. 2 May 2008 < <http://www.pciaonline.org/site/c.krLWJ7PIKqG/b.2660445/>>

⁵Environmental Protection Agency. "Partnership for Clean Indoor Air " January 2007. Winrock International. 2 May 2008 < <http://www.pciaonline.org/site/c.krLWJ7PIKqG/b.2660445/>>

⁶Ezzati, Majid. Kammen, Daniel. "The health impacts of exposure to indoor air pollution from solid fuels in developing countries: knowledge, gaps, and data needs." *Environ Health Perspective*. 2002 November; 110(11): 1057–1068.

⁷Ezzati, Majid. Kammen, Daniel. "The health impacts of exposure to indoor air pollution from solid fuels in developing countries: knowledge, gaps, and data needs." *Environ Health Perspective*. 2002 November; 110(11): 1057–1068.

⁸Raub, J.A. "Health effects of exposure to ambient carbon monoxide" *Chemosphere - Global Change Science*, Volume 1, Issues 1-3, August 1999, Pages 331-351

⁹Raub, J.A. "Health effects of exposure to ambient carbon monoxide" *Chemosphere - Global Change Science*, Volume 1, Issues 1-3, August 1999, Pages 331-351

¹⁰Raub, J.A. "Health effects of exposure to ambient carbon monoxide" *Chemosphere - Global Change Science*, Volume 1, Issues 1-3, August 1999, Pages 331-351

¹¹Principles of forensic toxicology levine

¹²Raub, J.A. "Health effects of exposure to ambient carbon monoxide" *Chemosphere - Global Change Science*, Volume 1, Issues 1-3, August 1999, Pages 331-351

Appendix I :Corn Cob Charcoal Production

The custom kiln is made from a modified oil drum as pictured in Figure A-1.

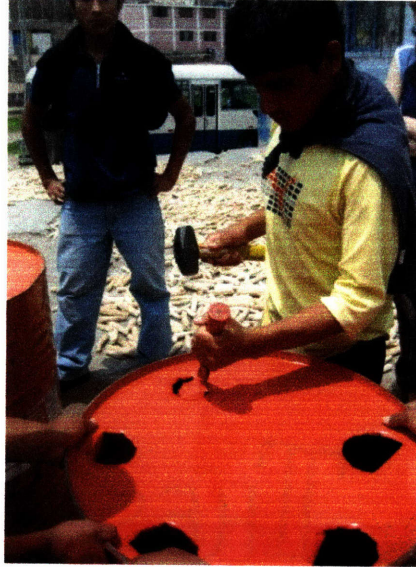

Figure A-1: Creating the kiln

The top of the kiln has a large hole removed to allow it to be loaded. The bottom has a number of smaller holes to allow air to enter during the initial part of the burn. A 2x4” piece of wood is placed into the center of the kiln and removed after the kiln is fully loaded. This creates a gap for air flow. Rest the kiln on three bricks equally spaced across the bottom. This allows for air to flow into the drum. Load the kiln with quick-lighting materials such as corn husks, so that the burn can catch quickly.



Figure A-2: Loading the kiln

After three-inch layer of husks, the kiln can be filled with any organic material to be carbonized. We have found that the best burns occur when layered in alternating layers of cons and husks. Once the kiln is full, carefully remove the 2"x4" to preserve the space in the center. Place some cornhusks or other quickly lighting material into the holes on the bottom of the kiln, these will act like fuses to start the burn. Light the husks and ensure that the flame travels into the kiln.

During this initial burn period, the fire will produce a lot of smoke but the flames should be contained within the drum. For the first few minutes the smoke will mostly consist of steam evaporating from the corn cobs (or other organic matter). However, after the temperature raises high enough, volatile gases will begin to evaporate, which is sometimes viewable by a change in color of the smoke.



Figure A-3 Evaporating Volatile Gases

At this point it is necessary to ignite the evaporating gases. This serves to raise the temperature of the kiln, creates more complete combustion and also prevents the toxic gases

from being inhaled. As can be seen in Figure XX, the flames can be quite high so caution must be taken during this stage



Figure A-4: Igniting the Gases

After the smoke is ignited, it should be left to burn for a few minutes. The kiln must reach an adequate temperature to ensure that the material is fully carbonized. However, if it is left to burn for too long, the material will combust and there will be little left to carbonize. (add more here) Once the kiln has reached the appropriate temperature, the kiln must be sealed so that the rest of the combustion can take place in a low oxygen environment.



Figure A-5: Stifling the flame and sealing the kiln

First, a lid is slid onto the top of the drum. This should stifle most of the flames. Next, the kiln must be taken off the bricks. This is done using a 2"x4" to support the kiln as another person kicks away the bricks one at a time



Figure A-6: Removing the stones from under the kiln

The drum must be sealed completely, so sand should be poured around the edges of the lid and around the base of the drum to create the seal.



Figure A-7: Sealing the kiln

The kiln should then be left for a few hours until completely cool. After it has cooled, the lid can be removed and the material should be carbonized.

Once the matter has finished burning, the corn cobs can be directly burned as fuel.