

IX. STROBOSCOPIC RESEARCH

Prof. H. E. Edgerton
B. F. Logan, Jr.

RESEARCH OBJECTIVES

To gain an insight into the production and utilization of electronically generated pulses of light is the goal of our research effort. Part of the work concerns studies of the physical mechanisms by which light can be obtained, including spectral distribution, flash duration, peak light, delay time, efficiency, and so on. In addition, the design of flash equipment for specific scientific measurement assignments is carried through.

A. CHARACTERISTICS OF THE FT-17A FLASH TUBE

The experimentally determined electrical and light-producing characteristics of a large quartz xenon-filled flashtube (FT-17A) are reported here. This tube was originally developed at M.I.T. with technical help from the General Electric Company, Lamp Division, as a source for airborne night photography (1, 2) in 1942.

Similar tubes (General Electric Company types FT-623 and FT-617) are now in use as sources for color photography in studios. The FT-623 has a sealed-in glass cover to reduce noise; the FT-617 is open so that air can be forced through the tube for cooling.

The flashtube described in this section (FT-17A) differs from the FT-623 and the FT-617 flashtubes by an additional turn of quartz tubing. Therefore, the results reported in this paper will differ somewhat from those from commercially available tubes.

Figure IX-1 shows the FT-17A flashtubes. The active spiral consists of about 40 inches of 5/8-inch (outside diameter) quartz tubing formed into a 2.5-inch (outside diameter) 6-turn spiral and filled with 20 cm of xenon gas. Massive iron electrodes with sintered tungsten-barium-nickel slugs serve as electrodes. An outer glass tube is used as a cover and support for the quartz spiral. Attached to the end of the tube is a bakelite member that holds contact pins for terminals and connectors. Two of the five connectors form a safety circuit to disconnect the power in case the tube is withdrawn from the socket. The other three terminals are the anode, cathode, and external starting electrode. Either terminal of the tube can be used as cathode, since the electrodes are identical.

The FT-17A tube was used in a special model of the Airforce type D3 night photography equipment with 4800 mfd at 4000 volts (38,400 watt sec). Actually two such devices were used in a B-24 airplane, thus totaling a stored energy of 76,800 watt sec. The FT-17 tube (5 turns instead of 6) was used in other flash units as follows:

Navy type N-2	3800 volts	300 mfd	2150 watt sec
Airforce type D-2	4000 volts	600 or 1200 mfd	4800 or 9600 watt sec
Airforce type D-3 (standard type)	4000 volts	7200 mfd	57,600 watt sec

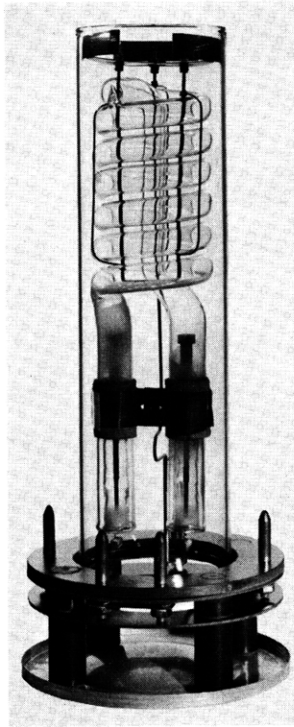

Fig. IX-1
 Photograph of the FT-17A flashtube.

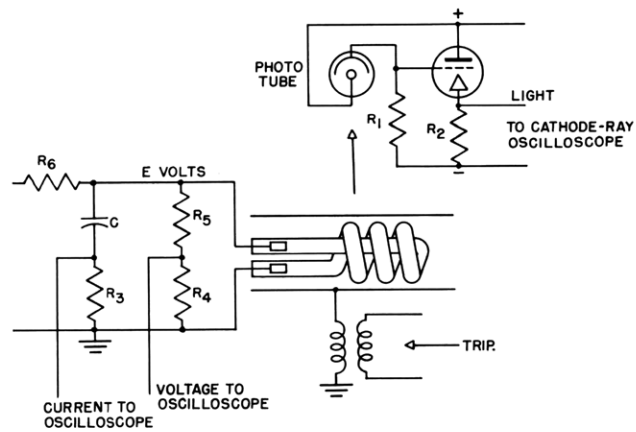

Fig. IX-2
 Experimental circuits used for measuring the characteristics of the FT-17A flashtube.

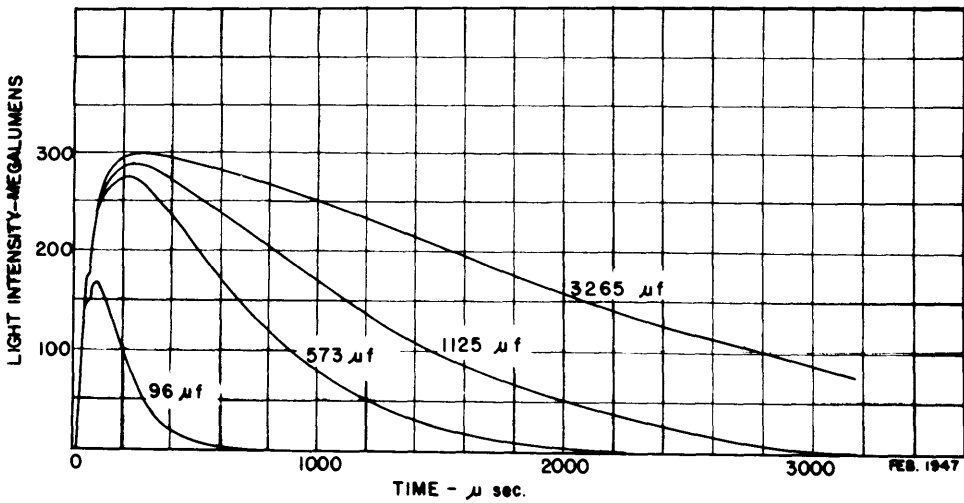
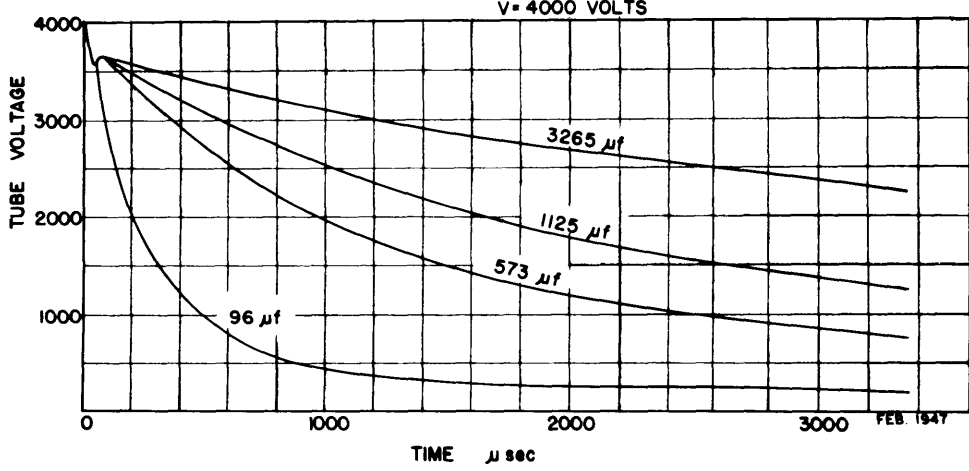
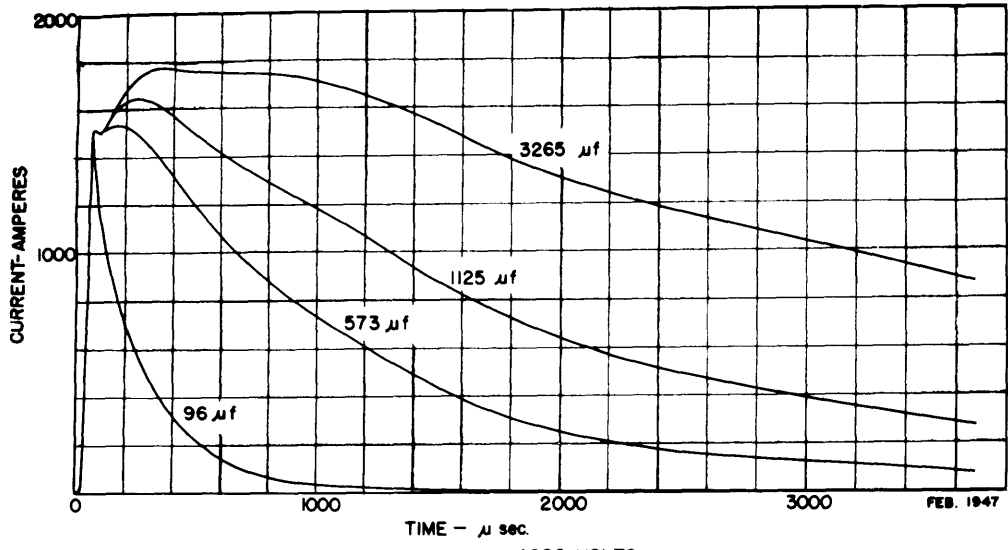

Fig. IX-3
 Data from oscillograms showing light, voltage,
 and current as a function of time.

(IX. STROBOSCOPIC RESEARCH)

1. Light-Time Characteristics

The light output of the flashtube was measured as a function of time, with the tube operated at a constant initial voltage (4kv) and with the discharge capacitance as the variable parameter. The light output was measured normal to the axis of the tube and the results recorded (Fig. IX-3) in horizontal candlepower (hcp).

A 929 phototube (blue-sensitive S-4 surface) was used in conjunction with a cathode-follower amplifier to deflect the beam of a cathode-ray oscillograph Dumont A/R Range Scope proportional to light intensity with a single-shot sweep tripped by a voltage from the primary of the flashtube ignition coil. A camera recorded the trace, thus measuring the light output as a function of time.

The phototube and oscillograph were calibrated directly by the use of a flashtube, FT-214, whose output was known under prescribed operating voltage and capacitance conditions. The normal FT-214 has a peak hcp output of about 2.6 million candlepower, when flashed from 100 mfd at 2000 volts. Differences in deflection calibration for the standard lamp and the large quartz tube were effected by varying the distance from the lamp to the phototube and by the use of filters. The total light output was calculated by multiplying the hcp by 10, a factor due to geometry that differs slightly from the factor 4π , which applies for a symmetrical source.

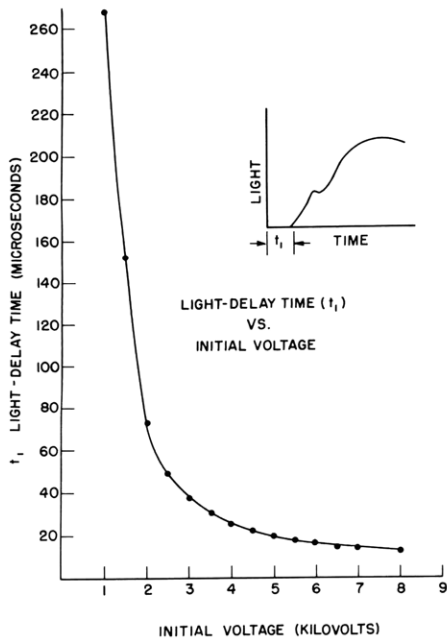

Fig. IX-4

Starting-time delay of the FT-17A flashtube.

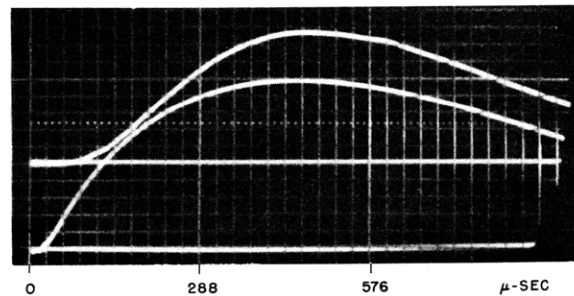

Fig. IX-5

Light (top) current (bottom) as a function of time with 0.54-mh series inductance. FT-17A, 4000 volts, 300 mfd.

(IX. STROBOSCOPIC RESEARCH)

The circuit connections used for measuring current and voltage and light in the flashtube are shown in Fig. IX-2. Figure IX-3 shows the information that was measured from the oscillograms of voltage, current, and light as a function of time for the FT-17A.

It was observed that the instantaneous output as a function of time during the first part of the flash showed a time delay in starting. Experimentally, it was found that this delay was less when a high voltage was used. A plot of the delay time from the start of the sweep is shown in Fig. IX-4. It should be remembered that there is an inherent delay in the spark coil, which is also included in the delay time.

The time delay of the starting of the light may be attributable to the time required for the gas to become ionized or heated. The results of Fig. IX-4 indicate that the product of initial voltage squared by the delay time, after subtracting the spark delay, is about constant. Apparently the flashtube does not become an efficient producer of light until a given minimum amount of energy has been discharged into the gas.

The effect of a series inductance in the discharge circuit was next studied. A 0.54-mh inductance was first used, and its effect on the shape of current and light-vs.-time oscillograms is shown in Fig. IX-5. The inductive effect delays and smooths out the peak, giving a longer "effective-light" duration. A much smaller inductance (approximately 5 μ h) was then used, and it was noted that it smoothed out the small ripple in the current and light-output rises.

The peak light output as a function of voltage was measured with the discharge capacitance as the parameter. The output of the phototube circuit was fed through a calibrated voltage divider (in order to obtain a multiplier) to the oscilloscope, and the peak was measured with a scale on the scope face. This scale was calibrated with the standard flashtube. The results plotted on log-log paper are straight lines and show that the peak light varies as the cube of the voltage (up to the working limit of the tube). See Fig. IX-6.

Next, the voltage was used as the constant parameter, and the peak light as a function of capacitance was determined. The curves (Fig. IX-7) show that the peak light tends to approach a limit as the capacitance is increased.

In the course of taking the data for the peak-light curves, interesting double-peaking phenomena were observed in the range of 2000-3000 volts and 500-1000 μ f. In this range a second peak appeared in the light-vs.-time oscillograms; and as the voltage or capacitance was increased, the second peak climbed until the original peak became only a ripple in the rise of the second peak. This is shown in the oscillograms of Fig. IX-8 and Fig. IX-9.

A final curve, Fig. IX-10, gives the over-all efficacy of the FT-17A in lumens/watt as a function of voltage and capacity. This data was measured by J. A. Vitka, Jr., and W. W. Smith with a General Radio Integrating meter type 1501, as a thesis project (1949) in the Electrical Engineering Department, M.I.T.

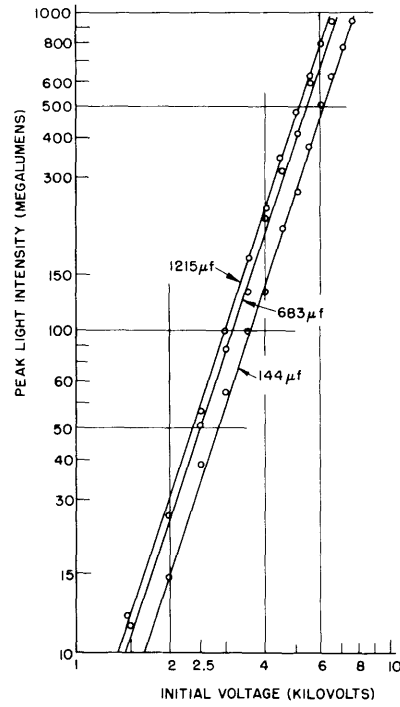

Fig. IX-6

Peak light as a function of initial voltage for several capacitors.
The peak light appears to be a cube function of the voltage.

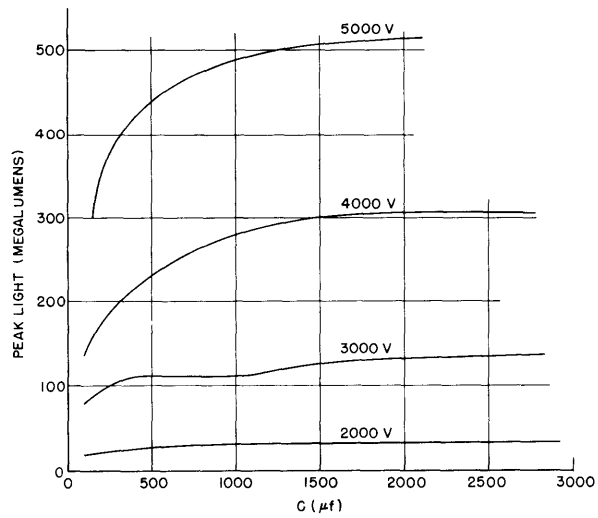

Fig. IX-7

Peak light as a function of capacitance.

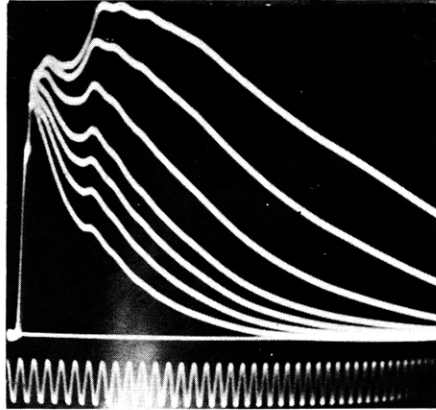

Fig. IX-8

Light-time oscillograms (10 kc/sec timing wave) to show ripples in light output. Capacity 287, 383, 481, 576, 850, 1400, 2510 mfd (peak light, 71×10^6 lumens). Voltage, 2500.

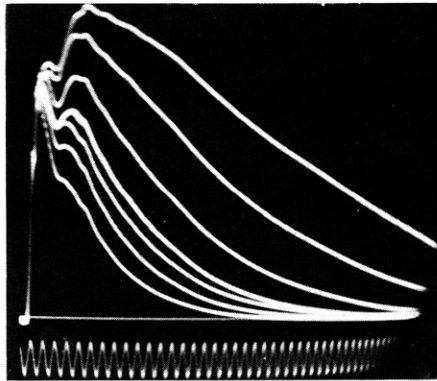

Fig. IX-9

Light-time oscillograms (10 kc/sec timing wave) to show ripples in light output. Capacity 287, 383, 481, 576, 850, and 1400 mfd (peak light, 117×10^6 lumens). Voltage, 3000.

(IX. STROBOSCOPIC RESEARCH)

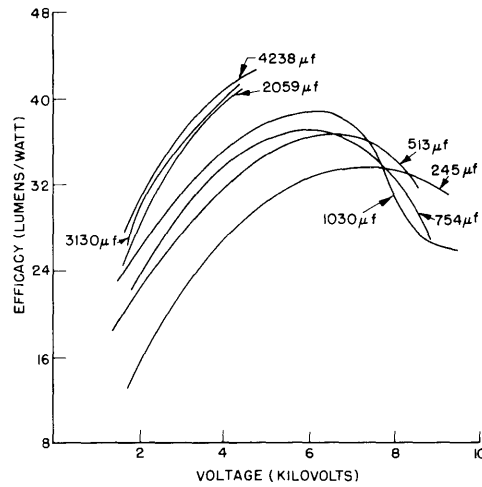

Fig. IX-10
Efficacy of the FT-17A flashtube.

The lumen-second output was calculated as

$$Q = W_h D^2 10 \text{ lumen sec}$$

where W_h is the horizontal reading of the meter in candlepower seconds at a distance of D feet from the meter to the lamp. The factor, 10, is one whose exact value depends upon the geometry of the flashtube.

The electrical input was calculated from the relationship

$$\frac{CE^2}{2} = \text{energy input in watt sec}$$

$$n = \frac{W_h D^2 10}{CE^2/2} \text{ lumen/watt}$$

2. System Guide-Factor Calculations

The "guide factor" of a photographic system composed of a closely spaced camera and light can be stated as

$$Df = \left(\frac{S}{C} \text{ bcps} \right)^{1/2}$$

where D is the light-subject distance in feet, f is the aperture of the lens, S is the exposure index of the film (ASA Z38.2.1.1947), C is a constant varying from 15 to 30, and bcps is the beam-candle-power-second output of the flash-lamp reflector combination. (See ASA Z38.2.6.1948.)

(IX. STROBOSCOPIC RESEARCH)

As an example, consider the FT-17A excited from $C = 4800$ mfd at 4 kv in a reflector with a factor of 10 (increases the bcp by 10).

$$\text{bcps} = \frac{CE^2}{2} \frac{n}{10} 10 = 1,500,000$$

Note that $n = 41$ lumens/watt from Fig. IX-10, or $n/10 = 4.1$ candlepower/watt.

Assume $S = 100$, and $C = 15$, to give $Df = 3170$, the guide factor. Suppose an $f2.5$ lens is used, then

$$D = \frac{3170}{2.5} = 1260 \text{ ft}$$

In actual use it was found that a much greater distance could be used for aerial reconnaissance, since a considerably underexposed negative could still give an adequate photograph with useful intelligence.

For example, this condition under favorable weather conditions has produced usable photographs at 6000 feet and even higher.

The back-scattered light from the beam of the flash is a very serious problem in aerial photography, since it creates an over-all fog on the film and thereby reduces the contrast. Every effort must be made to obtain the maximum camera-to-lamp spacing on the airplane. For example, in the A-26 airplane, the camera was in the nose compartment, while the lamp was mounted on the tail. Night aerial photography will be greatly improved when the spacing is increased.

References

1. H. E. Edgerton, Airborne photographic equipment, *PSA Journal* 13, No. 7, 439-440 (July 1947); Night aerial photography, *Technology Review*, pp. 273-278 (March 1947).
2. J. E. Burchard, Q.E.D., M.I.T. in *World War II* (John Wiley and Sons, Inc., New York, 1948), pp. 196-204.