

Learning Material for Constructing Environmental Understanding

by

Georgina Echaniz Pellicer

Submitted to the Program in Media Arts and Sciences,
School of Architecture and Planning
in partial fulfillment of the requirements for the degree of

Master of Science

at the

MASSACHUSETTS INSTITUTE OF TECHNOLOGY

June 2003

©Massachusetts Institute of Technology 2003. All rights reserved.

Author

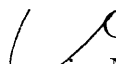
 Georgina Echaniz Pellicer
Program in Media Arts and Sciences,
School of Architecture and Planning

 May 9, 2003

Certified by

 David Cavallo
Research Associate of the Media Laboratory
Thesis Supervisor

Accepted by

 Andrew B. Lippman
Chair, Department Committee on Graduate Students
Program in Media Arts and Sciences

ROTCH

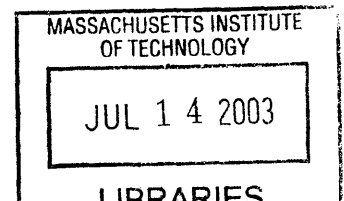

Learning Material for Constructing Environmental Understanding

by

Georgina Echaniz Pellicer

Submitted to the Program in Media Arts and Sciences,
School of Architecture and Planning
on May 9, 2003, in partial fulfillment of the
requirements for the degree of
Master of Science

Abstract

Environmental acknowledgement or awareness by itself does not necessarily implicate that people have understood the causes, effects and impact of environmental issues. Understanding and critically thinking about environmental problems is crucial and is not always addressed within the environmental education process. This deficiency is mainly due to the lack of adequate learning environments and suitable learning material. This study proposes an environmental education learning environment that was tested at the Fayerweather Street School in Cambridge, MA. During this study, motivated participants were fostered to engage in a personal project to address particular environmental issues, and were given the opportunity to design a methodology for conducting their own environmental projects. The learning environment included the use of technology-based learning material, such as electronic boards and environmental sensors, for people to interact with the chosen environment and produce data to support their arguments while addressing the environmental issue. As a result of the study, the participants produced two environmental projects. One of them was about measuring noise levels around the school, and it brought out the causes and effects of noise pollution in the context of the school. The other project was about measuring ground-level ozone and comparing indoors and outdoors concentrations, this project exposed some characteristics of ground-level ozone particles and its formation process. The proposed learning environment provided an opportunity for people to understand environmental issues and critically address them within a meaningful context and it contributes to the enhancement of the process of environmental education.

Thesis Supervisor: David Cavallo

Title: Research Associate of the Media Laboratory

Learning Material for Constructing Environmental Understanding

by
Georgina Echaniz Pellicer

Submitted to the Program in Media Arts and Sciences,
School of Architecture and Planning,
on May 9, 2003, in partial fulfillment of the
requirements for the degree of
Master of Science

Readers

THESIS READER: _____

A

BAKHTIAR MIKHAK
Research Scientist
MIT Media Laboratory

THESIS READER: _____

L

MARIO MOLINA
MIT Institute Professor
Department of Chemistry and
Department of Earth, Atmospheric
and Planetary Sciences

Acknowledgments

For their support, I would like to thank TELMEX; David Cavallo and the rest of the Future of Learning Group; Mario Molina; Bakhtiar Mikhak; Lorin Wilde; Juan Rivas; Alexandra Andersson; Ing. Rafael Ramos Villegas, Armando Retama, Jorge Dominguez, Miguel Sanches Rodriguez and the rest of the team of the 'Red de Monitoreo Atmosferico' (RAMA) at the Secretary of Environment in Mexico City; Jennifer Kay Goodman, Zoe, Anna and the people of the Fayerweather Street School; PEPETL; Telmex Fellows; my family and my friends.

To Rodrigo Pellicer Basanez

Contents

1	Introduction	17
1.1	Purpose of this Study	17
1.2	Environmental Education Review	19
1.3	Problems of Environmental Education	23
1.4	Integrative Proposal	25
2	Rationale for Understanding and Critical Thinking	29
2.1	Motivation for Learning	30
2.2	Contextualized Project	31
2.3	Personal Project Methodology	32
2.4	Technological Learning Material	34
3	Design: Learning Environment and Learning Material	37
3.1	Environmental Education Learning Environment	38
3.1.1	Compelling Object of Study	39
3.1.2	Participatory Design of Learning Tasks	39
3.1.3	Programmable Sensing Board and Environmental Sensors	40
3.1.4	Concrete Product of Projects	46
4	Environmental Education Case Study	49
4.1	Choosing Environmental Issues to Address	49
4.2	Designing Project's Activities and Methodologies	50
4.3	Using Tools to Interact with the Environment	53
4.4	Creating Concrete Products	55
5	Case Study Evaluation	61
5.1	Observation of Projects and Products	62
5.2	Analysis of Data Collected for Projects	65
5.3	Discourse and Word Analysis	67
6	Conclusion and Further Discussion	73
A	Specifications of the PSB	81

B Specifications of Ozone Detector	87
C Specifications of Noise Sensor	93

List of Figures

3-1	Programmable Sensing Board	41
3-2	Ground-level Ozone Detector	43
3-3	Noise Sensor	44
4-1	Ozone Trend Outdoors	57
4-2	Ozone Trend Indoors	57
5-1	Noise Pollution Concrete Project	63
5-2	Ground-level Ozone Concrete Project	64
A-1	PSB Schematic Layout	83
B-1	Ozone detector Schematic Layout	89
C-1	Noise Sensor Schematic Layout	95
C-2	Noise Sensor PCB Layout	97

List of Tables

3.1	Programmable Sensing Board Commands	42
5.1	Summary of Noise Discourse and Word Analysis	69
5.2	Summary of Ozone Discourse and Word Analysis	70
A.1	PSB List of Parts	85
B.1	Ozone Detector List of Parts	91
C.1	Noise Sensor List of Parts	99

Chapter 1

Introduction

1.1 Purpose of this Study

Our understanding of the importance of the environment and how we relate to it as a society is not a static conception. The human-nature relation has been determined by diverse points of view over time. By the first part of the past century, nature was conceived as a means of providing resources; therefore, people learned to manage nature in order to avoid permanent depletion of resources. This view changed by the second half of the century, when part of the concern regarding nature's conservation was the increasing population rate and other social factors intervening on the management of natural resources. As time went by people realized that there is balance in the human-nature relation that considers human needs and environmental protection as equally valuable and tightly interconnected. By the decade of the 70s, some countries saw the necessity of developing a regulatory framework to pursue that balance. In order to accomplish this regulation, environmental education has been suggested as a critical element for promoting sustainable development and improving the capacity of people to address environmental and development issues.[1]

Despite the policy effort to emphasize and promote environmental education, even I have experienced some practical failures in environmental education. These attempts were intended to convince people of what is good or bad for them and the environment, based

on external ideas. For example, an attempted to educate people in a Mexican neighborhood about the hazardous effects of pesticides used to combat vectorial diseases, and to teach them possible solutions to prevent mosquito proliferation as well as remedial actions to avoid direct contact or ingestion of the pesticide. Me and a Non Governmental Organization (NGO) team thought that going there and talking to these people would be a good start, so we organized a meeting at a local school; surprisingly—or maybe not—only two people out of a community of approximately 70 inhabitants attended. Evidently, effective environmental education takes more than just talking to people and try to *convince* them of what they should do to protect their health and their environment. In another occasion, we visited a rural village in southern Mexico where inhabitants were fishing by pouring pesticide into the river and collecting the affected fish downstream. Our goal was to persuade the people to stop throwing pesticides into the river, and to inform the rest of the population of the risks of eating the contaminated fish captured in that river. Once again, we organized a meeting. This time there were a lot of participants, almost every man, woman and child in the village were present at the gathering. They showed interest in the subject, and were already aware of the possible implications for the river ecosystem and for their own health. However, they did not develop a deeper understanding of how they could start to address this problem that was affecting the community, and they did not have the opportunity to think and propose possible solutions that would come from the community. As soon as we left the village, the people polluting the river continued to do so. For them, adding pesticide to the river makes it both easy, to collect a considerable amount of fish, and to make more money by selling it to their own and neighboring villages. The consumers, evidently, continued to buy and eat the contaminated fish. For them, fish is the only source of protein in their diet and, sometimes for some of them, fish is the only food for the day.

I consider these attempts to be ineffective due to the lack of connection between environmental education policy and educational theories. As much as education reform has overlooked the social origin of environmental problems[2], environmental education policy has failed to take advantage of educational theories, new learning environments and techno-

logical learning material. This lack of consistency between environmental education policy and education theory has undermined efforts to achieve sustainable societies. Provided that public behavior is strongly related to education, successful environmental policy and environmental regulation highly depend on awareness and understanding of environmental issues.

When I first came to the Media Laboratory and joined the Future of Learning group, I saw the opportunity to work on a research project that attempts to bridge the gap among environmental policy, education and technology. This thesis grew out of a research project that combined environmental education policy with some guidelines of constructionist education theory and put both into practice. The result is a learning environment and technological tools for the enhancement of the environmental education process. Before discussing methodologies for the environmental education process, I consider convenient to review what environmental education is and how this concept has evolved since it first appeared in international meetings and official environmental policy documents.

1.2 Environmental Education Review

The concept of “Environmental Education” has been differently understood by individuals, interest groups and organizations over time.[3] This diversity is, in part, a result of adapting the definition to current postulates. For example, the first US National Environmental Education Act (US Public Law 91-516-1970) signed into law on October 30, 1970, by President Nixon defines environmental education as:

“the educational process dealing with [man’s] relationship with [his] natural and manmade surroundings...”

The beginning of the 70’s is marked, as expressed in the previous definition, by a clear concern regarding the necessity of further understanding the balance of the human-nature relation. This concern, of course, was a result of many years of environmental degradation that captured worldwide attention. From this moment, environmental education is mentioned and taken into account at diverse international environmental forums.

It was not until the conference on human environment in Stockholm between June 5 to 16 1972, when a need was stated for “creating citizenries not merely aware of the crisis of over-population, mismanagement of natural resources, pollution, and degradation of the quality of human life, but also able to focus intelligently on the means of coping with them.” [3] At this conference, it was made clear that awareness is not the only component of environmental education. The process should include more elements that allow people not only to acknowledge the problematic but also to act in response to it. As a result of the recommendations given at the Stockholm conference, UNESCO and the United Nations Environmental Program (UNEP) launched an international Environmental Education Programm (IEEP). As part of their activities, they held an international workshop on environmental education at Belgrade, Yugoslavia in 1975.[4] The Belgrade Charter stated that the objective of environmental education should encompass not only awareness, but also the development of a population that has knowledge, skills and attitudes toward current environmental problems.[5] Two years later, the Tibilisi Conference in THE USSR held by UNESCO in collaboration with UNEP, established as a principle that environmental education should develop critical thinking skills in order to emphasize the complexity of environmental problems.[3] Critical thinking must be the basis for improving the capacity of the people to address environment issues, as suggested more recently by the Chapter 36 of Agenda 21, which is a policy document developed at the Earth Summit at Rio de Janeiro, Brazil in 1992.[1]

If we compile all of the elements that have been added to the concept of environmental education, we can surmise that its basic objectives are the following:

1. Awareness. Our perception, attention and concern about environmental problems is considered to be awareness.[6] A great example of modern environmental awareness is Reachel Carson’s book *Silent Spring* which was an outstanding effort of generating awareness regarding the use of pesticides in the decade of the 70’s.[7] This book not only increased individual awareness, but also directly called for public education about these substances as ‘sadly needed’.[8] Awareness has been related to education in studies like a Jakarta survey, which raised questions such as, ‘what kind of environmental

pollution sources do you have in your neighborhood?’ or ‘do you know the problem of air pollution?’. Results have shown that educated groups have a higher level of perception of regional and global environmental problems.[6] Awareness is also the trigger of the rest of the environmental action; if I do not even know that there is a problem, I am not able to understand it or to try to do something to solve it.[9]

2. Knowledge, understanding and critical thinking. Once we have acknowledged an environmental problem, it is indispensable that we extend our knowledge about it in order to understand and critically think about it. Knowledge, understanding and critical thinking involve investigating, judging and addressing the causes and effects of environmental problems as much as the relationship between those causes and effects and between them and human activities. These relationships should be interpreted as part of a dynamic system that can allow us to see the consequences of our actions, and see how we contribute to our own problems.[10] Knowledge and understanding allow the creation of sound environmental plans and form the basis for future achievement of those plans.[9]
3. Action Skills. What we refer to as skills are usually abilities to make decisions. An action skill, from the environmental education point of view, is the ability to make decisions to productively act and participate in the production of solutions for current environmental problems, and to be able to act according to plans for the prevention of future environmental problems.[11]

In terms of promoting awareness, there are a lot of activities that are effective to help people to notice or acknowledge environmental issues, not only around their local area, but also on a global scale. There are great efforts to call people’s attention to our planet; for example, World Environment Day on June 5th, which we observe every year since the Stockholm conference.[4] Another example is World Water Day, held on March 22nd each year, and the International Year of Freshwater, 2003, which received its official launch at a ceremony at the United Nations in New York on December 12th, 2002. The aim of the year is to raise

awareness of the importance of protecting and managing freshwater.¹ There are also some specific means that have been suggested to increase awareness of environmental issues. For example, promoting non-formal environmental education through mass media, such as radio, television, films, etc. This could reach a great number of people from general backgrounds and can be specialized for more educated people through newspapers, magazines, and Web sites published on the Internet.

On the other hand, possessing the skills and abilities to solve and prevent environmental problems has been suggested to be a result of being better informed and exposing more arguments to make better decisions. Furthermore, it has also been suggested that changes in attitudes and behaviors should be founded on relevant knowledge and understanding.[12] It is clear that before solving or preventing an environmental problem, we should know more about the subject. This knowledge should foster further understanding of the causes and effects of the environmental problem and it should allow us to critically think about the issue in order to address it in a cognitive and thoughtful way. After this process is internalized, we account for the sufficient basis for making strong arguments and support behavioral changes towards environmental issues. The quest, then, is to make sure that this process is comprehensive and robust enough to support future development of abilities and skills.

The focus of this study is how to generate knowledge and critical thinking as the basis to address an environmental issue. I will not refer to awareness or perception of an environmental issue because I am taking that for granted from the participants. Introducing new or unknown environmental issues is also avoided; in order to construct understanding and critical thinking, participants will address an issue that they have already at least heard of. From there, we will build knowledge and understanding about that specific environmental issue. On the other hand, I will not evaluate the participant's development of abilities and skills in the future; this would require a longer and deeper study and followup. I will only refer to the part of the environmental education process by which we can develop understanding and critical thinking to thoughtfully address an environmental issue.

¹See <http://www.wateryear2003.org>

1.3 Problems of Environmental Education

Genuine environmental knowledge can be considered to be the cognitive skill that allows people to understand the environment and the impacts of the relationship between humans and nature.[13] However, critics have suggested that to a certain extent, environmental education has misled people to unsound environmental opinions.[14] This could be the result of the educational process that we go through to obtain the environmental knowledge in which we base our opinions. In this case, the educational process might be affected by the imposition of environmental information, the introduction of fragmented knowledge, a lack of understanding, a lack of meaningful context, unsuitable learning material, or by all of them.

In some cases, the focus of environmental education has been directed only towards the acquisition of knowledge of environmental problems.[14] The fact of simply conveying information should not even be considered as a successful learning experience because it does not leave an open opportunity for understanding or critical-thinking to take place. If we try to impose information about a given environmental problem, we may be as well be imposing our own understanding and thinking. This would undermine the opportunity and the capacity of other people to develop their own understanding about the issue, denying any attempt to produce knowledgeable critical thinking. Furthermore, in the event of generating some kind of knowledge by imposing environmental information, this would result in a fragmented knowledge. By fragmented knowledge we should understand a compound of several pieces of information that are provided independently of a system that they are part of, or are presented without a meaningful context for the learner.

Conversely, in other cases the focus of environmental education has only been around nature experience: arguing that if people are physically exposed to environmental problems they will develop a solution, disregarding the necessary knowledge to understand the causes and effects of the problem related to a broader system intrinsically attached to this problem.[15] This fragmented solution forces people to act impulsively upon a part of the problem, while an understanding of the dynamic connection between the causes and effects

of environmental problems is lost.[10] In this case, we have an environmental opinion driven by emotions and not by reason and understanding.

In fact, this kind of unsound environmentalism is not what we need at present. As claimed by Moore in his study ‘Energy Related Information-Attitude Measures of College-Age Students’, what we really need is knowledge and understanding of environmental issues and a critical attitude to evaluate and address those issues.[16] When there is a lack of understanding and critical thinking, no matter how much we have heard about an environmental issue, we will not be able to critically address it or to act in response to it. This absence of knowledge and understanding take us to a ‘denial’ stage where we probably know—or have been told—what to do as an alternative for abating an environmental problem, but we are unable to choose that path because we are not convinced of its convenience and we do not have a clear motivation to act towards it.[17] Lack of understanding and critical thinking is part of what made the people at the neighborhood affected by vectorial diseases and in the rural village affected by fishing practices using pesticides to choose not to do anything about their environmental problems, even when they were aware of them. This denial is incubated by fragmented and decontextualized knowledge, which in turn is a result of the methodology and tools that are used (or not used) in the educational process.[18]

Selecting tools that should be used to aid the process of understanding an environmental issue is always a great concern. Environmental projects, not exclusively education oriented, have extended their activities by providing people with professional equipment as material for people to collaborate on the project and learn about a targeted environmental issue. Nevertheless, there are some factors, either on the methodology or the utilized tools, that obstruct this goal, such as the ones mentioned for the “Schools for a Living River Elba” project in Germany. The general goal of the Elba project is that German school children (primary and secondary) measure the quality of the water in the river and then integrate the results on the World Wide Web.[19] The Elba project addresses chemical and biological knowledge by an action-oriented method of physically measuring the quality of the water. However, since the predetermined and inflexible physical context of the project is imposed, some schools

reported lack of student motivation.[19] Other important difficulties that this project faces are the lack of money and the lack of suitable material.[19] Students are provided with specific and expensive material, such as biology kits that are expensive and complicated even for teachers to use. Furthermore, the methodology of the project establishes a narrow and specific list of activities that the participants should perform with these tools, namely measuring and sharing results. Some environmental education projects focused only in natural experiences end up utilizing people as instruments to collect data for a foreign and unfamiliar project. One of the main problems of these kind of projects is that they try to impose activities biased by a foreign interest that do not rasonate with some people because they are presented outside of a meaningful and appealing context.

The lack of motivation and student participation, the learning material deficit and the passive transference of information without meaningful context have undermined the goals of environmental education of fostering understanding and critical thinking. Projects affected by these burdens had people memorizing information or mechanizing activities without deeply thinking about them or understanding them. In contrast, to promote environmentally informed opinions and critical thinking, it is necessary to design an adequate learning environment that promotes participation and suitable learning material to support a learner-centered environmental education process.

1.4 Integrative Proposal

The objective of this research is to propose a learning environment and technology-based learning material to develop a methodology that enhances the environmental education process, while including the concepts encompassed by environmental policy and the guidelines of education theory. The environmental education process to which I am referring is a process that can encourage people to learn more about and understand an environmental issue and to critically think about it. For this process to avoid the burdens mentioned before, it is necessary that the learning environment balance a few basic elements. The next chapter describes a theoretical rationale of how to reach this balance to create an opportunity for

understanding and critical thinking. The methodology for the educational process includes four elements that will be explained in more detail: 1. choosing a compelling object of study, 2. encouraging people to address an environmental issue by engaging in a personal project that can generate understanding of the environmental issue within a meaningful context, 3. allowing people to design a personal methodology for studying the chosen environmental issue to build their personal project and 4. providing people with tools, such as sensing boards and environmental sensors to offer them an opportunity to physically interact with the chosen environment and accomplish the steps of their designed methodology.

In the third chapter, I explain in more detail how this proposal can be implemented. I describe the physical and social characteristics of the learning environment in which an environmental education case study was conducted. It gives a general background on the Fayerweather Street School and the students who participated in the study. The general steps that are followed during the case study are also described in this section. Finally, in this chapter I describe the learning material prepared and proposed for this study. The description includes information on how this learning material was conceived and developed, and how it is expected to contribute to the education process.

As mentioned above, in order to take this methodology into practice, a case study is implemented. The fourth chapter describes the implementation of this qualitative experiment. This section describes the environmental education experience, and provides details on how the participants experienced the basic elements of the proposed learning environment. The description includes a narrative about how the participants chose an environmental issue to focus on and how they engaged in projects that allowed them to interact with the environment, gain new contextualized knowledge and made evident the causes, effects and impacts of those environmental issues.

To come to an objective conclusion and further discussion, in the fifth chapter I evaluate the activities developed during the case study based on three qualitative evaluation tools: observation of participants' projects, analysis of the data collected for the projects, and a discourse and word analysis. Based on these evaluation tools, it is possible to identify and

highlight the cases in which the suggested basic elements were present and to evaluate if the concurrence of those elements that defined the proposed learning environment and learning material generated an opportunity for participants to construct understanding and critical thinking of environmental issues.

Chapter 2

Rationale for Understanding and Critical Thinking

In terms of environmental education, critical thinking is a crucial element for understanding the causes and effects of environmental problems, as well as its impacts in a broader system or context. What we usually picture when we think about being critical is deeper understanding of the causes and effects of a given issue in the context of a broader system. This critical thinking allows us to rationally decide what to do or what to believe regarding a given issue.[20] Thus, it would be a contradiction to establish a set of steps that people must follow in order to think critically. People are not machines that can perform a series of activities and reach the desired results every time. What we can do is design a learning environment where the learner can develop understanding and critical thinking regarding environmental issues. In the introduction, I mentioned lack of motivation, imposed methodologies, lack of learning material and decontextualized knowledge as some burdens that obstruct the environmental education process. Now I will provide an overview of how to overcome those concerns.

The educational practice usually tends to one of two extremes with respect to the openness of the educational process. One extreme is to neglect learners based on excuses, such as their age or capability to participate in the design of the educational activities. The other extreme is the belief that understanding is going to magically evolve if the students

are engaged in an activity.[21] In order to stay away from those extremes, the presence of a person whose passion for environmental issues and advocated involvement can guide the learning process. This guidance occurs without imposing authoritarian knowledge on the learners, but by learning with them from their projects and activities. Later in Chapter 4, the description of the case study shows the role that this person, in this case me, plays during the process by asking questions, fostering discussion and participating on the learner's activities. I do not call this person "a teacher" first because I am not dealing with a formal education environment, and second because the role is not to teach a fixed curriculum but to guide the way of learners through the different steps of the educational process by including some basic elements.

The referred elements consist of a compelling object of study, a meaningful context for knowledge, the liberty of designing a personal methodology for studying an issue and the adequate use of learning materials to complement the educational process. This is not an exhaustive list of all the requirements of the complete education process, but four basic variables to integrate within the learning environment that can support understanding and critical thinking activities. This chapter is devoted to exploring what different theories and authors suggest in relation to those basic components for the environmental education process to be able to foster understanding and critical thinking.

2.1 Motivation for Learning

Interest is the symptom of necessity.[22] In education, the initiative for learning comes directly from the learners.[21] They must find a personal motive and reason to get involved in learning about something. Part of this motivation includes not only a reason to learn but also a realistic direction or way in which this knowledge and understanding can be used.[22] Whether the knowledge is applied immediately to an existing problem or is assimilated and combined with previous knowledge to critically address an issue or to face possible future situations, personal interest is a latent impulse that opens the mind into a ready state to learn, critique and understand.

For environmental education, it is also crucial to commence relevant work towards understanding and critical thinking about environmental issues based on focal interests.[23] These interests are often associated with immediate surroundings, establishing a real and direct need of people to be better informed and understand deeply an already known and familiar environmental issue. A personal motivation is the starting point of the process by which we can develop deep understanding in order to critically address an environmental issue. However, being motivated and eager to explore an issue does not bring understanding straightaway. There are other elements of the educational process that combined with motivation can construct an educational experience from where we can gain further understanding of environmental issues.

2.2 Contextualized Project

For people to be motivated and to engage in learning and understanding an environmental issue, they should do it by working on a project related to it. As suggested by Papert, the educational process evolves better when people have the opportunity to engage in a personal and tangible project.[24] Moreover, this project is conceived within a meaningful context that attaches the studied issue to a broader system surrounding the chosen issue. Being able to choose and contextualize the object of study means diving into its situation rather than looking at it from a distance. That connectedness, according to Papert, is a powerful means of gaining understanding.[25]

In terms of environmental education, research has shown that environmental knowledge and nature experience coupled with an adequate social context have a stronger effect on promoting well-informed environmental opinions.[26] This is not to suggest that environmental issues should only be considered in terms of their social value, but to emphasize that environmental issues are better understood when studied as part of a broader system and not as isolated knowledge. Trying to force people to learn about particular environmental knowledge without a meaningful context would be less compelling for the learner and would generate what Papert refers to as *denatured* knowledge.[18] Furthermore, fragmenta-

tion of knowledge forces people to act impulsively while the understanding of the connection between the causes and effects of environmental problems is lost.[10]

Contextualization of environmental education has been recognized by the international community. At the Tbilisi Conference in the former USSR in 1977, while establishing the principles of environmental education, it was recommended that environmental knowledge and understanding should be related to environmental sensitivity to the learner's own community.[4] As suggested in Tbilisi, the context of an educational experience could be determined by history, geographical location, regional problems, prevailing culture, ideals and policies. This localization of environmental issues facilitates the educational process and places the new knowledge and understanding about an environmental issue in connection with a series of interconnected issues and not as an isolated problem. Therefore, the contextualization of environmental knowledge, or the situation of a project within a meaningful surrounding, opens the possibility for further understanding of the causes and effects of an environmental issue, its specific characteristics and impact. For example, it is more meaningful to study and understand an environmental issue from the point of view of its value for a particular ecosystem or in terms of its impact for a specific community.

2.3 Personal Project Methodology

To achieve the goal of the educational process of promoting creative understanding and generating habits of critical thinking, it is not enough to guide the learner through prefabricated set of steps. It is necessary to foster the learners to play an active role in the educational process and to create and shape a personal design for their own learning experience.[27] Once that people are motivated and engaged in a project, they need to create their own personal methodology to reach the objective of their project. The capacity to define creative paths and structures for exploring environmental issues is present in people since they are in primary school age. It has been demonstrated that children are able to design their own learning tasks and also generate and justify their own personal rules.[28] They start with a particular idea and then develop a methodology, an orderly logical arrangement of steps, to

reach specific goals of the project in a systematic way.

The capability of proposing an initial idea regarding an environmental issue is not infallible; many of our judgements can be proven to be false. We often hesitate in making new judgements for fear of being wrong again; however, we should continue to try new ideas.[29] Each time that it is necessary to rethink previous ideas or methodologies should be considered as an opportunity to explore new knowledge and develop new ideas of the processes related to the studied object. This process takes time and involves reflection to design a new idea. Mitchel Resnick suggests in his work 'Thinking like a tree' that the process by which we discover further understanding of an issue should be based on defining and testing ideas and then evaluating the results and deciding if these results show a new direction to move toward.[30] Then, as suggested by Dewey in his book '*How we think*', this natural capacity to testing and inferring needs to be transformed into habits of critical thinking.[21]

A way to support this critical thinking is by generating ideas that should be not only pondered and tested, but also discussed and analyzed to develop deeper understanding of an environmental issue. In his work about how children solve environmental problems, Sheehy stated that a critical and structural way of thinking is a key element to reach deeper understanding and it is broadly encompassed by causal thinking. Causal thinking suggests the ability to identify the causes and effects of an issue in terms of a more complex system that is highly connected.[31] However, causal thinking in relation to environmental issues might not come only by observation and passive study of information. Environmental understanding also requires creative discussions and actions. These actions reflect the need for an interaction with the environment that is being explored and, of course, our senses are great direct tools to experience nature[32]. However, there are some intangible matters that we can perceive with our senses but cannot appreciate concretely. In these cases, it is necessary to take advantage of technological material as external tools to facilitate and enrich the educational experience.[33]

2.4 Technological Learning Material

The use of technological tools and other external means is conceived as an extension of our physical capabilities in order to aid the educational process. Through the mediation of digital technology, there are many powerful ideas that can emerge and be explored. [34] In terms of the environmental education process, the use of technological tools not only allow people to engage in activities that they could not pursue before, but also to engage in projects and activities that they did not even think of doing before.[30] The possible tasks the learners might not have thought about before and are able to explore by utilizing technological tools are countless, as well as their contributions to further understanding those unexplored issues.

For example, as described by Robert F. Tinker in his work ‘Science for Kids: The promise of Technology’, the staff at TERC, a not-for-profit education research and development organization, explored educational applications of computer-based, real-time data acquisition. This work was motivated by the ideal of developing low-cost sensors to improve student learning in experimental settings and making learning more effective. One of the developed sensors was an ultrasonic motion detector connected to a computer. The computer was programmed to tell the sensor to emit a ‘chirp’. The sound reflected back to the sensor, which detected the returning signal. They measured the time between emitting and detecting the signal and, using the known speed of sound, they obtained the distance between the two. The computer was also programmed to generate a graph of this distance as people moved around in front of the sensor. The result of the system is that you can walk up to the sensor and see a graph of your motion as you are moving. In a few minutes, users at all grade levels quickly learned to interpret the graphs and relate them to their motion. These kind of activities can produce large gains in students intuition, which cannot be achieved by any combination of lecture, traditional labs, and homework.[35]

There are many other examples where people have used technological tools as part of their learning experience, like a project in which handheld computers were provided to support learners to engage in mapping activities. As part of the study, a group of students used the handheld device to create a map that could demonstrate their understanding of

weather before and after their curriculum unit on weather. After creating their map, they exchanged with a partner who provided comments. Students were encouraged to review their maps based on peer feedback and to think about how their understanding of weather had changed.[36] In other projects, students learn to think for themselves and discover answers on their own with the aid of technology. For example, there was a project in which school children were provided with different kind of tools, such as modelling software and data collection devices, to monitor the quality of a water body near the school.[37]

In the previously described examples, people were provided with technological tools for specific activities. However, when students design their own projects, they should not be limited to the capabilities of the given tools. In that regard, there are some projects, such as the Beyond Black Boxes (BBB) project, that emphasize not only the use of technology-based tools, but the development of new computational learning material that allow people to create, customize and personalize their own tools.[38] This exemplifies how technology-based learning material can contribute to enrich people's projects by giving them opportunity to explore the physical world and offering them opportunities for acquiring and displaying data to increase the sophistication of their methodologies. This provides them with new mechanisms for creative expression and for generating their own vast databases of information. Without the technology, the possibility of directly studying and addressing particular issues, and the rest of the student-centered activities are difficult to offer and sustain.[35]

Chapter 3

Design: Learning Environment and Learning Material

The proposed design encompasses two different elements. The first consists of the methodology that is followed in order to create a suitable learning environment to implement an environmental education study where people can explore, understand and critically address environmental issues. As described in the next sections, during the study the participants have control over their disposition to learn and understand a particular environmental issue, the opportunity to participate in the design of a personal project to address a chosen environmental issue, and the choice of accessing, shaping or creating tools to support the educational process. The second important element, which is also part of the learning environment, consists of the set of tools to support the environmental education process. For this study, I chose to focus on sensing the environment because sensing is a piece of information that the participants can generate by themselves and requires specific learning material. These tools are not constrained to what is presented in this chapter. On the contrary, one of the possibilities of the proposed tools is that people are encouraged to create their own new environmental learning material. Nevertheless, we cannot just give people tools and expect them to always know what to do with them or how to do what they want to do with them. It is in these cases when, without restricting the participants' control of their projects or

activities, a facilitator is needed to support the participants to engage in each step of the environmental education process.

3.1 Environmental Education Learning Environment

The learning environment conception and the relevance of the learning material is encompassed by B.G. Willson's definition "a learning environment is a place where learners may work together and support each other as they use a variety of tools and information resources in their pursuit of learning goals and problem-solving activities." [39] Based on this definition, for this environmental education study we can understand the learning environment as the physical and social scenery where certain properties and tools are present for understanding and critical thinking to take place. The learning environment is determined by the properties of the particular place in which the educational process takes place. In this case, I chose to perform our study at a school. The Fayerweather Street School, as they describe it, is "a coeducational independent day school enrolling approximately 185 students in pre-kindergarten through eighth grade. Fayerweather was founded in 1967 by parents and educators interested in exploring alternatives in schooling..."¹ This interest is reflected in the activities going on in all the areas of the school, such as regular classes, special events and recreation. Our case study was not an exception. Even though they do not include a strong technological element within the school environment and the proposed tools were unfamiliar for them, the fact that they are exposed to an environment in which they are encouraged to learn and express their opinions and thoughts, makes the social environment more participatory and proactive. This characteristic of the Fayerweather Street School and the help of the Unit teacher, who collaborated in facilitating the study, contributed to the process of building a rich learning environment, where the planning of activities to perform during the education experience are integrated along with the education process and defined by the learners.[39] On the other hand, there are some controlled variables within the learning environment that are described in the following sections.

¹See <http://www.fayerweather.org/>

3.1.1 Compelling Object of Study

In this study we adopt a learner-centered approach. All of the participants can focus on particular environmental issues, but each one can bring into the learning environment his or her own concern or motivation for studying that particular environmental issue. This motivation is, as stated in Chapter 2, the igniting factor that mobilizes the rest of the elements that complement an educational experience. To start, learners are free to choose a particular environmental issue that they would like to explore. Some choices could be out of the scope of this study, but we try to encourage openness and have some examples that are feasible, such as air pollution or noise pollution.² After motivation is stated and participants are ready to address their personally interesting environmental issue, a process of thinking and discussion takes place in order to determine their initial ideas regarding the chosen issue. From the discussion, ideas flow in terms of what we think about a particular environmental issue and the different ways to explore and address it. Discussions and thinking are an important part of the educational process and are also a crucial element of the learning environment. Through these discussions, people shape their understanding and thinking regarding environmental issues and are empowered to generate personal opinions and new ideas based on the shared knowledge.

3.1.2 Participatory Design of Learning Tasks

Validating new opinions and ideas, reshaping them and reconstructing them are the next important steps. Within this learning environment people are able to design their own set of steps that allow them to test their initial ideas regarding the chosen environmental issue. This methodology reflects the way in which the chosen environmental issue is going to be understood, and the context for this understanding. Designing this contextualized methodology implicates a decision making process that involves general decisions, such as localization

²As discussed later, all the participants of the study decided to focus on the given example topics. Only one of them suggested another topic, recycling, which due to time constraints was out of the scope of this study.

or situation of the objectives of the projects, and specific decisions, such as what kind of information to collect for the project and how to collect it. To immerse in this experiential part of the process of exploring and understanding environmental issues, it is necessary to identify the possible sources of potentially needed information.[4] This information can come from existing sources, such as the Internet, libraries and other institutions and interviews with targeted people, or it can come from new sources generated by the learner.

To carry out this methodology and to aid the process of understanding the chosen environmental issue, the use of digital media and other external tools come into the learning environment. Utilizing learning material, such as sensors and electronic boards to collect data regarding the chosen environmental issue is a crucial element of the learning environment. This step influences the way in which we think about an otherwise personally unacknowledged part of environmental problems. The process of shaping thinking and understanding of environmental issues through the analysis of data happens when the learner is planning the data collection, during the sensing process and, of course, after the collection when there is a need to be critical to analyze the data. This process allows the learner to quantify and visualize information, facilitating the analysis and giving place to new possible mindsets not conceived before.[40] To provide people with tools to generate their own sources of information, I am adding to this environment a set of technological learning materials designed for this particular environmental education study, which consists of a programmable sensing board and sample environmental sensors.

3.1.3 Programmable Sensing Board and Environmental Sensors

Technology has given leverage to the educational process by allowing new and more proactive activities. According to his study regarding the use of different kits for environmental education in Hong Kong, Kara Chan concludes that people prefer to utilize tools that allow them to engage in actions or activities related to environmental problems that might have a direct influence on everyday lives in their community.[41] These findings support the idea that the educational process requires activeness of the learner as a key element. The set of

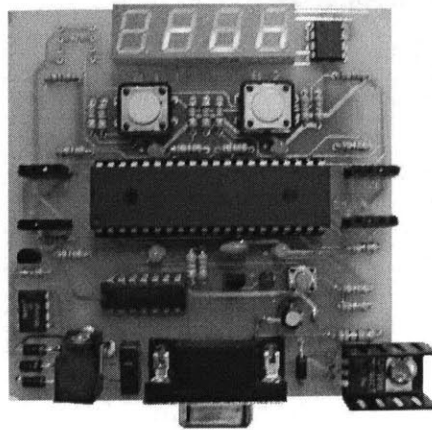

Figure 3-1: Programmable Sensing Board

tools developed for this study was designed for people to engage in activities related to environmental issues and to allow them to physically explore the chosen environment to produce their own data or content for their projects.

Starting from the idea that our senses are an effective tool to understand the physical environment, I focused on sensing as a perceptible way to identify environmental issues and as a connection point between abstract or somehow directly incalculable problems and the internalization of the understanding of their causes, effects and implications. This is how the design of the Programmable Sensing Board³ (PSB) emerged, a tool that allows people to go around and physically interact with the environment while collecting and storing relevant environmental data from that particular environment to be analyzed later. Hence, as shown in Figure 3-1, the PSB consists of a set of four sensor ports that can take readings from any sensor attached to them. The board also contains a memory chip to store the collected data.⁴

The programmable feature is common on the boards from the Media Lab and is based on the LOGO programming language. The programming environment is quite simple. This simplicity is in a way a disadvantage because it does not allow the user to do some basic

³This board was built by Arnan Sipitakiak, a member of the Future of Learning Group at the MIT/Media Laboratory

⁴See specifications on Appendix A

Table 3.1: Programmable Sensing Board Commands

<i>Command</i>	<i>Function</i>
loop	routine that will be repeated forever
record	save the data from a sensor to the memory
sensor1	sensor port identifier, e.g. sensor2
print	show value or text on the board's display
wait	wait before executing the next instruction
example	loop [record sensor1 print sensor1 wait 3]

analysis of the collected data. The PSB can only store and download the raw numbers coming from the sensor ports, preventing the user from managing these numbers in the board in order to download them to the computer already converted to the real unit of a specific sensor. On the other hand, this simplicity represents an advantage for inexperienced users because a simple programming environment means that there are few commands that can be manipulated to program the board, as shown in Table 3.1. Consistent with constructionist ideas, instead of utilizing a preprogrammed sensor, the users can program and download to the board their own routines to define a certain pattern to record sensors' readings. After typing the program, users download it to the board in one step by hitting the 'download' button.

The way in which the data can be extracted from the Programmable Sensing Board in order to be presented in a suitable fashion for further analysis includes two options. The first one is by introducing the collected data into a Microworlds⁵ project file. The values can then be called by Microworlds using specific commands to include, for example, sensor readings into a project. The second option is a more general one and consists of saving the data as a text file, which can be managed later using software like Microsoft Excel or other computer programs that can support text format files.

For data collection purposes there is a wide variety of sensors that can be attached to the PSB. Basically, anything that can give an electric resistance feedback to the board can be attached to it as a sensor. For instance, simple temperature sensors and photoresistors can be directly attached to the board to measure temperature or light respectively. In order to

⁵Microworlds is an LCSi software for LOGO programming

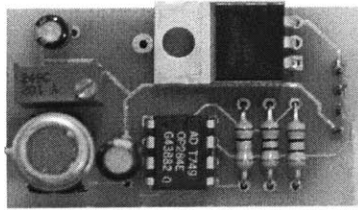

Figure 3-2: Ground-level Ozone Detector

give people more concrete ideas of tools or sensors that can be attached to the Programmable Sensing Board, and to serve as examples of peripherals that can be attached to the PSB, we designed and built models of environmental sensors. These two peripherals are based on the need to visualize two environmental problems that are usually present in many communities but are not easy to estimate only using our senses. One can detect ground-level ozone, a main component of smog and product of the chemical photoreaction of pollutants, such as the emitted by cars and power plants, with the presence of sunlight[42]. The other environmental sensor can sense decibels, which allows us to quantify environmental noise.

The first peripheral that I built consists of a simple electronic circuit that interfaces an existing commercial sensor with the PSB.⁶ The MiCS-2610 sensor is developed by Micro-Chemical Systems SA and can detect particles of ground-level ozone in the environment by a resistor that is eroded in the presence of those particles. As shown in Figure 3-2, the sensor requires a resistor, power for the heater and a buffer to give feedback to the PSB. For this sensor to start detecting ozone, it is necessary to heat it for thirty minutes and, after that, it starts providing information about the variations of ozone present in the environment. These variations are not registered as accurately as professional equipment because it takes time for the sensor to identify if there is a change in the amount of particles. In addition, the sensor's response is affected by other factors such as humidity. In an indoor operation like a laboratory or an industrial area, for which the sensor was originally created, it is more likely that we can control humidity in the environment.

Nevertheless, despite the fact that the response of the sensor when used in variable

⁶See specifications on Appendix A

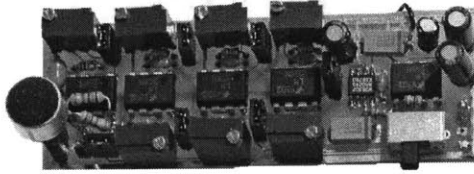

Figure 3-3: Noise Sensor

conditions is not as precise as a professional equipment, I decided to adapt the use of this sensor because it makes it possible to sense ozone in a less expensive manner than with professional equipment. For this study, low price is a determining factor whereas exact precision is not an essential requirement. The ozone detector is a good instrument to visualize an otherwise ‘invisible’ environmental pollutant. With this low-cost sensor, learners are able to infer a great deal of information regarding the impact, causes and effects of what we call modern smog⁷ by, for example, observing the path defined by the particles during the day. In any event, I made sure that the sensor gives reliable data on ozone concentrations in terms of parts per million through testing measurements and comparisons performed at the Automatic Network of Atmospheric Monitoring (RAMA) in Mexico City in July 2002, with the cooperation of the Secretary of Environment of Mexico City.

The second example that was built consists of a noise sensor.⁸ This peripheral follows the same idea as the ozone detector. It is suggested as an inexpensive tool that can aid the process by which we learn and think about something that we cannot see. Noise is an acoustic phenomenon that causes a potentially uncomfortable auditive sensation. This varies depending on peoples’ acclimatization, which means that not everyone is affected by noise at the same level.[44] Even if we can perceive noise with our senses, we are not able to be critical about it because the levels of noise are not easily quantifiable. In order to explore

⁷The combination of smoke and fog (condensation of water and SO²) gave rise to the term smog. Smoke and SO² were already declining by the early 20th century. Modern photochemical smog results from the interaction of CO and NO_x (emitted notably by car exhausts) with light and natural and anthropogenic organic compounds. Since we all associate the word ‘smog’ with air quality, we still call it smog, or photochemical smog[43]

⁸The noise sensor was designed and built by Alexandra Andersson, who joined the Future of Learning Group by the Undergraduate Research Opportunity Program (UROP)

these variations of perceiving noise and its causes and impacts, the sensor allows people to interact with a specific environment and obtain noise level measurements on the dB(A) scale. The sensor, shown in Figure 3-3, is integrated with a microphone, an amplifier and a set of capacitors and filters.⁹ The output signal consist of a voltage that can later be interpreted in decibels by calibrating the sensor. We performed this calibration with the use of a sound meter. The advantage of our sensor over the sound meter is, again, its low-cost. Like the PSB and the other example sensor, the noise sensor is conceived as a learning tool that can be accessible for learners and not as professional equipment. However, in this case, the noise sensor is likely to produce accurate readings if properly calibrated.

The argument about the characteristics of the technology-based tools that I suggest as part of the learning environment for environmental understanding leads us towards a discussion regarding which are the decisive elements that constitute a good learning material. According to Chan's study in Hong Kong, some of the most important characteristics of a learning tool that one might put in hands of learners are its accessibility, the appropriateness of its content, and how they are attractive to the learners. [41]

In terms of accessibility, it is a fact that in many cases the cost of the material and degree of difficulty for the user are important elements that determine the functionality or impracticality of a learning tool. As stated in previous paragraphs, it is clear that the proposed tools are less expensive than other equipment that serve the same or similar functions. This feature makes it possible to have a sufficient amount of material available for large numbers of learners. The low-cost characteristic is possible mostly because we selected basic electronic components for the materials. The plain and versatile design of the proposed tools also allows people to manage them in an uncomplicated fashion. Even though for some people the fact that the proposed learning tools are technological could implicate a degree of complexity, the tools are easy to use by adults and also by children. Furthermore, the accessibility of the proposed material allows users not only to manipulate the tools as they are provided, but also opens the possibility for the learner to put additional features to the

⁹See specifications on Appendix B

tools. Some of these possibilities include the option of putting together their own PSB, as well as designing and building new kinds of sensors. This can be done by using locally found inexpensive components to create new material and sensors that can be attached to the provided tools.

The proposed tools enable the user to generate personalized content that can be as wide as the environmental topics that the learners choose for their personal projects. Learners are not only free to determine the extent of the content that they want to address, but also the kind of activities required to produce their project. This characteristic makes the appropriateness of the content more flexible to satisfy the needs of learners, which in turn makes the material attractive in a different way for each user. Low cost and versatility, coupled with the variety of content that can be addressed with these tools, make them adequate materials for learners to construct sufficient arguments to impact the way in which they think about and understand environmental issues. Furthermore, by utilizing technological tools, such as the proposed material, people can experience an integrated educational process by also having the opportunity to get involved in other activities besides environmental knowledge and understanding. The use of the electronic sensing board not only allows people to get familiarized with electronics, in which the board and the sensors are based, as well as explore and apply mathematical knowledge to manage and analyze the data collected. For example, mathematical operations are needed in order to convert the output signal of the sensor into real measurement units, and to obtain mean values or other mathematical functions to analyze the data.

3.1.4 Concrete Product of Projects

After the learners have experienced the different steps of the learning environment, they are ready to concretize the experience. To do this, they build a model or a concrete product of their project so they can have an opportunity to share their impressions about the chosen environmental topic.[31] Material, such as computers, collected data and its analysis,

Vensim¹⁰, Geographical Information Systems (GIS) and other pieces of software suggested by the participants, as well as digital cameras and traditional material like paper, colored markers or clay, can generate an evocative environment where participants can concretize their projects. The participants' concrete products serve a double function. First, this product constitutes a concrete object, produced by learners as a result of the learning process, that can be analyzed at the end of the study to evaluate the effectiveness of the learning environment. Second, the artifact that is created facilitates a channel for people to reflect on their own ideas as they expressed them in their projects; in Papert's terminology, people can create an "object to think with." [45]

These products, or objects to think with, are the link that maintains the understanding process flowing. After creating the concrete product of a project, this creation not only reflects understanding but also inspires new projects. Understanding does not stop after finishing one project, but it evolves as we continually engage in activities that allow us to explore deeper questions regarding the same issue, or engage in new projects to explore related or different environmental issues. This process cannot be fitted into a specific schedule because this can constrain the possibilities of the learners to extend their projects to pursue further understanding of environmental issues. On the contrary, it should continue until critical thinking can be a habit that people can practice by themselves. With time, people can internalize this way of analyzing environmental issues and can be able of studying, understanding and critically addressing environmental issues without participating in a study or in an environmental education process, but going through the steps by self motivation. This way, we are not teaching people what to think, but helping them to develop their own way of approaching and understanding environmental issues.

¹⁰Vensim is an environment for conceptualizing, building, simulating, analyzing, optimizing and deploying models of dynamic systems

Chapter 4

Environmental Education Case Study

The design described in the previous chapter is, of course, based on the guidelines suggested on the theoretical rationale described in chapter 2. The proposed design covers the main concerns of environmental education regarding the adequate learning environment and learning material for understanding and critically thinking about environmental issues. In order to test this design in real settings, an experimental phase of the study is performed. Based on the discussed guidelines for constructing a learning environment, I decided to physically implement a study on environmental education. For this study, we chose the physical environment mentioned in the previous chapter, the Fayerweather Street School. To meet the schedule of the Fayerweather Street School, we had to adjust the proposed activities to just more than a week. During this time, we had the opportunity to implement this study and participate on the activities described in this chapter.

4.1 Choosing Environmental Issues to Address

The first day that we went to the School was Friday April 11, we introduced ourselves to the Unit; they are a small group and they all are around 13 years old. We talked about the objectives of the study and we started by asking a broad question about who was interested in the environment. Most of them seemed to care about the environment and some of them

even showed concern about specific environmental issues, such as air pollution. This was a good start because they showed interest and they pointed out one of the environmental issues that is possible to explore with the proposed tools, specifically using one of the suggested examples, the ozone sensor. On the other hand, it left out the possibility of extending the used of the given tools by creating new sensors to attach to the programmable sensing board.

Now that the topics were set on the table, we started to talk about what they think was important in terms of air pollution and noise. At the beginning of the study, the characteristics of the projects that the participants were willing to conduct was determined by the physical surroundings. This is important because it also determined the context in which we addressed the environmental issues. Since the study was introduced in the school and we were going to be working at the school, they showed great interest in knowing more about what is happening with the environment inside and surrounding the school. They related the importance of air pollution with the outdoors environment and the access to high quality natural resources because of the fact that the school is close to open natural spaces, such as Fresh Pond. For the case of noise pollution, it was the teacher who suggested that it could be interesting to know the levels of noise inside the school. As soon as the teacher mentioned this, the children showed immediate interest and started a discussion about what might be the patterns of noise around the school.

4.2 Designing Project's Activities and Methodologies

During the discussion of the first day, we pointed out different environmental issues that would be interesting to explore. We went on with the discussion about air pollution and we introduced the fact that ozone is one of the main components of smog, but we cannot actually see it. By this time, we passed along the sensors so they could look at them and realize that there is a simple way of exploring this kind of environmental issues in a non expensive manner. Regarding the cost of the sensing equipment, an interesting discussion took place. The children were trying to figure out what would be the cost of a professional tool to measure ozone levels; some of them had no idea of the possible cost, but others

suggested amounts that ranged around thousands of dollars and were not far from reality. We also added the fact that in order to do this kind of measurements it is not enough to have the sensors, but it is also necessary to have the adequate equipment, such as computers and connectivity, to collect this kind of data in a bigger scale, in a whole city for example. As soon as we mentioned ozone, they raised the issue of the hole in the ozone layer. There was confusion about ozone being good or bad, so we proceeded to point out the difference between the atmospheric ozone layer and ground level ozone. After the discussion, it was clear for them that ozone in the atmosphere is good for humans to protect us from the ultra violet rays from the sun, and that ozone at tropospheric or lower levels is dangerous to humans if we breathe it.

This was a rich discussion in which we shared opinions, knowledge and interests regarding the air pollution problem; however, none of them seemed to be mentioning noise pollution. We asked what they think about noise, and their answer was clear, they know that there is noise but they never thought about it as a pollution problem. It was at this point when the teacher suggested to measure noise level around the school. The suggestion boosted children's interest and they immediately started a discussion about which would be the loudest place and class around the school and at what time of the day. The first day ended with great interest and exciting discussion.

On my next visit to the school on Monday April 14, we decided to set up teams that were going to work on projects about different environmental issues. We did not have much time to work out the study because the school was having their usual break in April. Therefore, they decided to work on projects that involved the existing tools, the board, and the provided ozone and noise sensors. We made a list and there were six children who signed-up to work on a project regarding noise around the school and there were four children who signed-up to work on a project about ground ozone-levels.

We continued the discussion with the noise team regarding the potential loud places at school. Some of the children thought that the unit or 7/8 grade class would be louder than a regular kindergarten class. Most of them agreed that kindergarten classes are not as

noisy as the Unit classes. One of them suggested that the hall during recess and lunch time should also be loud, and other pointed out that one of the noisiest places in school was the gym. Nobody else thought so about the gym and the discussion went on. Some of them were worried about the possibility that the board was not only recording noise, but also recording what was actually being said in the classroom. For some of them who explained the situation, it was clear that the sensor could only detect the amount of noise and not specific sounds. From this discussion, I asked if some of them knew which is the unit in which we were about to measure noise. Out of the six or seven people in the room only one, a girl working on the ozone project, said that the unit for measuring noise are decibels. The fact of knowing a specific unit for what we were measuring made it clear and more appealing for the students, who now started to have an idea of how were we going to compare the results of the measurements in different locations.

Regarding the ozone team, there was no initial discussion right away, so I started to ask questions to foster some argumentation. I asked if they had any idea of the pattern of ozone or at what time during day we could have the highest concentrations of ozone in the air. Instead of trying to guess out of nothing, one of them told me that they would like to know more about ozone before they could start making any argument. This was an interesting and clever attitude, that demonstrates that when people are interested in something and they have the opportunity to explore an unknown issue, they feel the curiosity and the necessity to know more about it. I talked to them about how ozone is formed and we thought about the cars and industries around the area that could be emitting the fumes that eventually would react with sunlight to form ground level ozone during the day. After we talked about this for a while, I asked again the same question: at what time of the day should we have higher concentrations. This time, there was no hesitation, "It has to be at noon" one of them said. In some way, I was expecting that on our next meeting this team would be willing to measure ozone levels and sunlight pattern during the day to compare them and verify what we have discussed about ozone.

4.3 Using Tools to Interact with the Environment

According to the proposed learning environment, the participants are able to control their education experience and are expected to design their own methodology to approach the chosen environmental issue. To follow this guideline, I decided let them do this on my next visit to the school on Wednesday April 16. Based on the discussion from previous meetings, I was expecting them to be able to define a project by themselves. We started the day talking about what they wanted to do, and they immediately told me that they had been thinking about doing specific measurements in specific places. I had prepared some questions to induce discussion and to foster them to generate a plan for their experience interacting with the tools and the school environment; however, it was exciting to discover that they had also prepared their own ideas for conducting their own project.

While we were planning the activities for the day, we took the boards and the sensors out of the box and they started to look more carefully at them. When they saw the board they were reluctant to touch it and some of them said that they could not use those tools because they might break them. I told them that it was fine to be careful but there was no problem if they break a board or a sensor, so I gave them a simple schematic of the different buttons and main features of the board. This helped them a great deal and they started to test the on/off switch and the other buttons. After a while, they felt comfortable with the tools; they even took the boards and the sensors with them to set them where they had planned. During this day we mostly worked on setting the sensors and taking the measurements, but we also had some valuable discourse and we also took some pictures of the sensors at their locations and some shots of the school and the surroundings. I will refer first to the noise team because since previous meetings it was more clear what they wanted to do.

Before describing what we did, is important to mention that during this visit, there were fewer children participating in the study. In part this was because there was an event going on that morning at the school and some of them were involved helping with that event. Some others just decided not to join us that day. There were just three girls who were interested in measuring noise and they planned to put the sensors in different places during the day.

They had the idea that the Unit is louder than Kindergarten, so they wanted to compare them to figure out which area is loudest during class time. We programmed the boards and proceeded to set them around the school. The first sensor that we set was located in the middle of the table where children were sitting around during a humanities Unit class, it started at 11:15am and ended at 12:15pm. The second sensor was set on top of the lockers, right in the front of the Unit classroom, and it started to take measurements at 12:45pm and they let it record during half an hour. They turned off the sensor at the hallway at 1:15pm, when the lunch and recess time was over. The third and last sensor was installed inside the K02 classroom during a kindergarten class that started at 2pm and ended at 3pm when the regular school day is over.

At the end of the day, we picked up the sensors and I asked what they would like to do with the obtained data as a way to integrate their projects into a concrete entity. The girl that was most interested in the noise project decided that what she wanted to do was to have a map of the school to point out with different colors the exact places where they did the measurements and to compare the levels of noise in the three different areas to identify who was around those areas and what was going on with noise levels at the school.

I will now refer to the ozone project, which until this moment was not clear. During the day that we did measurements, there was only one girl interested in doing a project about ground ozone levels, she was the same who figured out at what time should we experience the highest concentrations of ozone in the air. I thought about proposing to do a comparison between ozone and light; however, she surprised me when she told me she had her own idea for her project. Before I started talking about my idea, she told me that what she really wanted to do was to compare ground ozone levels outside the school with ground ozone levels inside the school. Since we talk about air pollution as to be an outdoors problem, she was wondering what was happening indoors during the day. I told her that was really interesting and I gave her two ozone sensors for her to place them where she wanted. She put the first sensor on top of a bench located right through the main door of the school. The second sensor was set outside the school, on top of a bin located at the outside playground. Both

sensors were set to start recording at 10am and were turned off at 3pm when the classes at school were over. While we were downloading the data from the boards into my laptop, I asked her what she wanted to do with the collected data. She said she also wanted to have a map, like in the noise project, to show the places where she set up the sensors to record ozone measurements, but she also wanted to look at graphics of the ozone trends during the day so she could compare what happens outdoors with what happens indoors, and she could also compare the amount of ozone in the air outside the school with the amount of ozone in the air inside the school.

4.4 Creating Concrete Products

Considering the interests of the participants and the kind of projects that they had in mind and wanted to do, for the session of Thursday April 17 we managed to obtain a map of the school showing the different areas and classrooms of the Fayerweather Street School. We also had some support material to integrate the projects, such as my laptop, banner paper, color markers, and some of the information produced by the children during the course of the study. This information consisted basically on the data collected; however, this data was represented in graphics showing the trends of the measured subject.

For the case of noise, the participant started by gathering all the material and organizing it. She was looking at the graphics that showed the trends of noise in the three locations and she was surprised by the peaks in the graph, she found it interesting how in the lapse of thirty seconds the noise levels could rise so much. I asked which would be a good way to obtain an indicative number out of the string of data, and she said that we should obtain an average. Using Microsoft Excel we obtained the average amount of noise for each one of the locations. The average noise during the Unit class was 68.91 dB(A) and the average noise during the Kindergarten class was 74.25 dB(A). When she compared the numbers, she could not believe that the Unit class was not as loud as the kindergarten class. Her rational was that is important to consider the activities going on during the period of the measurements. According to her, the humanities class was one of their quieter classes and

that was the explanation for the results we obtained. She added that even after looking at the numbers, she still believed that the Unit area is sometimes louder than the kindergarten. I asked how could she assure that some unit classes are louder than the one we measured, and she said that sometimes they are so loud that they cannot listen to what the teacher is saying. At that moment I remembered what they said about not considering noise as a pollution problem at the beginning of the study, so I asked again why does she think that noise could be a problem. She thought for a while and then she said that in the Kindergarten are the noise levels are high because small children are playing, but in the Unit area it is important to keep noise levels low because it can interfere with learning. After marking on the map the spot where we measured noise in the Unit classroom and specifying why she thought it was not an accurate representation of the noise level in the Unit area, she decided that she was going to use one map for each location. She marked the other two locations in the correspondent maps and then she put a poster together with all the material. She looked at the poster and she suggested that we should add some information about decibels and noise levels to have a reference. We also added a picture of the noise sensor and the data about noise in the hallway during recess and lunch time. The fact that the average noise during the lunch and recess time was only 64.96 dB(A) was extremely interesting for her. She mentioned that the teachers always tell them that they are excessively loud during recess and they are always running and shouting on the hallways, so it was surprising that the average noise at the hallway was lower than the average noise during class.

Finally the poster was done. Meanwhile we had a rich conversation regarding what they previously thought about noise and what we found out that was happening with noise levels around the school. Some classmates, even those who dropped the study, and some teachers stopped by to look at the poster and ask some questions about it. When they asked what happened with the measurements, the girl was happy to explain what she had done and shared the results of her project. One of the people who stopped by was the other girl working on the project about ozone. She liked the idea and said that she wanted a poster for the ozone project too.

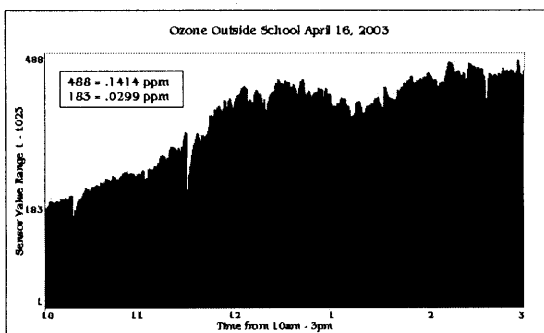

Figure 4-1: Ozone Trend Outdoors

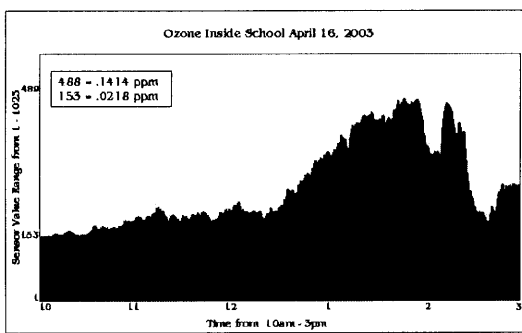

Figure 4-2: Ozone Trend Indoors

The first thing we did that day in relation to the ozone project was to talk about what she thought that the results were going to show. She said she had a hypothesis. This was an exciting moment because the fact that she had an idea of what could happen with the measurements revealed that she was taking some time to think about her project and she was being critically enough to speculate about its results. She was sure that the sunlight and the outdoors ground level ozone trends were going to be coincident, however she was not so sure about what could be happening with ground level ozone inside the school. Her prediction was that there should be lower levels of ozone inside the school. The next thing we did was to look at the graphics of the ozone trend outdoors and the graphic of the trends of sunlight from 10am to 3pm on the day of the measurements. Indeed, she was not surprised that they are actually coincident; however, when we looked and compared the graphics showing the trends of ozone outside the school and inside the school it was extremely interesting for her.

I had prepared some pictures to help her figure out what might have caused the indoors ozone trend to behave the way it did. Somewhat to my surprise, it took her just a couple of seconds to look at the graphics shown in Figures 4-1 and 4-2 and figure out what influenced the indoors ozone trend. She immediately suggested that someone must have opened the door. She was so excited about this finding that she decided that she definitely had to mention something about this in her poster. Unfortunately it was late that day and we did not have more time to put the poster together, so I suggested that I would be back the next day with the support material for her to build her poster and share her project.

During my last visit to the Fayerweather Street School on Friday April 18, 2003, I dared to suggest that we could work out the ozone project in the computer instead of doing a poster. Apparently, this was not a good idea; the girl working on the project told me that she did not want to do the project in the computer, what she wanted to do was a poster. We had barely an hour left to do whatever project we agreed to make. I decided that it would be frustrating for her and for me to force her to use the computer, and it would be impossible to teach her how to use software to manipulate the collected data and expect her to produce something in 45 minutes. The teacher told me that her students enjoy doing posters and they would be happy doing so, hence I pulled out the support material and gave her the banner paper, the markers and the school maps.

The girl working on the ground-level ozone poster decided that she, like the other girl did with the noise project, wanted to show the places where she set the sensors to collect the ozone data in the school map. As part of the poster, she also wanted to paste the graphics, and to compare ozone levels by placing them in two different columns, one for ozone inside and the other for ozone outside the school. Regarding the ozone values, she had an interesting and critical question about how were we measuring ozone. I told her that the units to measure ozone are 'parts per million' and explained to her that this means that you have a certain amount of parts of ozone per million parts of air. She said she understood that, but she wondered how to compare all the values so I suggested to do it using hourly averages; this way we could compare what was happening with the ratio of ozone indoors and outdoors every hour and identify at what time was the door opened. She agreed so we proceeded to obtain hour averages and she marked them in the columns of her poster. It was clear that from 12pm to 2pm, the amount of ozone indoors incremented from half to the same amount of ozone outdoors; therefore, we concluded that the door was opened during lunch and recess time. After presenting the data, she wanted to explain what caused the increment in ozone inside the school. I asked what does she think that this fact of the door means, and she said that it confirms her hypothesis that ozone levels are lower indoors and also indicates that ozone particles are rapidly spread by the wind.

Again, I asked if she would also like to say something about sunlight, but it was already too obvious for her that she did not feel it was necessary. Although, she noticed that there are other times of the day besides noon when it is hotter and there is heavy traffic so there should be more cars and more emissions. We went back to the discussion about the chemical reaction of particles coming out of cars and industry and the presence of sunlight, so it made sense for her that if the brighter time of the day is noon, then more particles would react to form more ozone at that time. She also wondered if there are higher concentrations of ozone in other areas of the country where they have more sun during the year, such as California. This was an extremely interesting reasoning because her suggestion of higher concentrations in California is a well informed argument, and especially because this could be a new hypothesis that could bring more to the process of understanding ozone as an air pollutant.

Chapter 5

Case Study Evaluation

Evaluating the way in which people think about and address environmental issues is not an easy task, specifically when you are trying to identify if this thinking is being critical, or based in the understanding of causes and effects of the environmental issue. Knowledge and critical thinking are not a matter subject to a quantitative measure; what this study is looking for is not a change on how much people think, but a change on how people think about a particular environmental issue. Therefore a quantitative study would not be suitable to determine if there was a change in participant's way of thinking. The effectiveness of the proposed learning environment design is determined by people's attitudes and actions, and by the quality of those attitudes and actions; thus, this study is considered as a qualitative research and requires a qualitative evaluation. The adequate evaluation of the results of this research is based on qualitative evaluation instruments and guidelines, and is being presented in a narrative style.[46]

For this evaluation, there are three basic qualitative evaluation tools that are effective to assess the potential change in the participants towards a more critical way of thinking and understanding environmental issues. These tools are the observation of participant's project, a discourse and word analysis, and the analysis of data collected for the projects. The first evaluation instrument is a general tool that allows us to determine if the suggested elements of the learning environment, motivation, contextualized project methodology and physical

interaction with the environment were present during the education process. The second evaluation tool allows us to establish if the data collected by the participants is relevant to the generation of new knowledge and potential change in discourse towards critical thinking. Finally, the last evaluation tool allows us to identify changes in people's understanding of environmental issues during the case study, as well as to detect significant change towards more critical ways of addressing environmental issues by the way participants express themselves and based on their vocabulary and their discourse.

5.1 Observation of Projects and Products

Observation is a useful qualitative tool that allows appreciation of the quality of the outcomes of the study in relation to the influence of initial variables. In this case, the initial variables were defined as the possibility of developing a project through a contextualized methodology that allows physical interaction with the environment to address a chosen environmental issue. Through observation of concrete products we can determine if these variables are embedded in the participants' projects. These concrete and observable products that resulted as the outcome of the environmental education study at the Fayerweather Street School are two posters addressing two different environmental issues. One of the posters was about measuring noise around the school, and the other one was about comparing ground-ozone levels inside and outside the school.

From observing the posters that the participants put together, it is possible to infer that the understanding of environmental issues was determined by their interaction with the specific places that they studied around the school. These settings also determined the context of the methodology for their projects. They did not study noise and ground-ozone levels as an isolated environmental issue, but they addressed them within a meaningful context of broader systems that allowed them to physically interact with the chosen environment and to highlight the causes and effects of the chosen environmental issues.

Noise was studied as a possible source of pollution within the school environment. Noise levels were understood as a product of the activities that usually take place at the school,

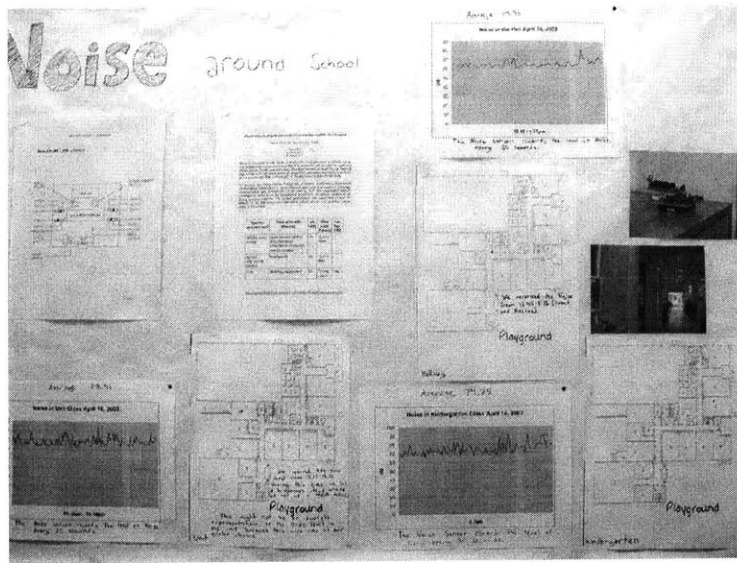

Figure 5-1: Noise Pollution Concrete Project

and it was finally conceived as an issue that can interfere with those activities. They were not trying to understand noise as an abstract conception, they were studying noise within a significant physical context. They were, as the title of the project reads, “Measuring Noise Around the School.” This geographical situation of the project was so relevant that the participant who build the poster added to her project maps of the school where, as shown in Figure 5-1, she identified the exact places in which she measured noise. They wanted to know which was the loudest place; however, the way in which this noise is related to the school context was meaningful when the participants realized that noise pollution at the school can interfere with the learning activities within their classroom.

When the noise project first started, they determined the places where they were planning on measuring. These were general places, such as the classroom, or the hallway. The presence of the participants at the measuring sites was, of course, was mainly for the purpose of setting the sensors and run them to take measurements; however, when they actually went to put the sensors in the chosen places, a further analysis emerged. It was not only a matter of putting the sensor, but they studied the area where they put it. They examined the places where they were going to put the noise sensors in terms of the way in which people were

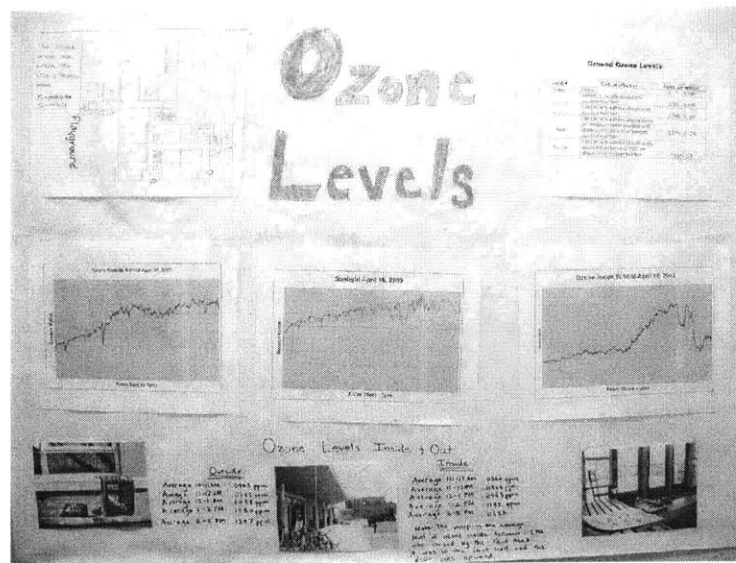

Figure 5-2: Ground-level Ozone Concrete Project

distributed within the area or classroom and the distance between people and the noise sensor. Regarding the idea of measuring noise in a hallway during recess and lunch time, they analyzed which would be best place to locate it; they decided to put it in the hallway that they thought would be the most populated during that time. Whether it was inside the school or outside the school, they were present at the sites where they wanted to measure noise or ozone and they dived into the study of those places and their relation to their projects and addressed environmental issues.

Concerning the ozone project, the context was embedded in a different way. The motivation for the project was studying ozone levels; however, this was a general concern. As opposed to the “Noise Around the School” project, the relation between the studied environmental issue and a broader system was not tightly determined by the physical environment; the context of this project was determined by its social impacts. The interest of the participant in ozone levels was derived from her interest on air pollution in general. She addressed air pollution as an environmental issue that is related to society in general due to the fact that it can impact human and ecosystems’ health and quality of life. Of course, she is part of that society and in that sense was she interested in measuring ozone, or as she called her project “Ozone Levels”, not as an isolated issue, but from the point of view of a broad envi-

ronmental issue—air pollution—that represents a social problem. The participant specifically wanted to understand the behavior of ozone particles in an outdoors set as compared to the trend in an indoors set as a particular aspect of air pollution and ozone levels. Within this context, she developed her method for measuring, including the timing for the measurements and the location of the sensors. For this project, it was also important to consider the characteristics of the areas where she wanted to run the sensors. When we went outside and started to think about what would be a good place to put the ozone sensor, some interesting ideas came along. Because we thought that if high concentrations of ground-level ozone are harmful if breathed, it would be more meaningful to take measurements at a breathable height. This is how we decided to run the ozone sensors on an elevated place, as shown in the pictures of Figure 5-2.

5.2 Analysis of Data Collected for Projects

When we judge something, we are determining the knowledge and meaning of an issue, and this knowledge is a matter of content.[47] However, sometimes this content or data can be biased. Influence on the arguments for addressing an environmental issue is determined by the environmental education process and the experiences of the person who is addressing a particular environmental issue. This bias in environmental education can be interpreted in two different ways, as environmental or 'green' propaganda or as the confrontation between environment and other interests and the apparent choice among them.[48] Environmental prejudice tends to occur when the education process implicates learning environments or learning material that are intended to only convey biased information from the knowledgeable to the uninformed. In this type of process, the recipient of the information is not able or allowed to analyze that information, but is forced to believe that information without a rational explanation or further understanding. Personally visualizing, quantifying and analyzing data, images or any other information related to the addressed issue provides foundations for reflective and critical thinking.[40]

The Programmable Sensing Board and the Environmental Sensors that can be attached

to it allow people to interact with the environment to collect their own data and to produce their own interpretations of that data. The noise sensor and the ozone detector, for example, allowed the participants to appreciate some otherwise abstract and difficult to estimate environmental problems such as noise levels and ozone levels. The collected data was managed in the form of averages, images and graphics, it was produced in relation to time, space, and the physical and social context of the projects. Each one of these factors had an important effect on the generation of the information and also on the analysis of the collected data, and they were freely determined by the participants. For the noise project, we generated averages for noise levels in three different areas of the school at three different but key times of the day. All of the noise sensors were set to take reading every thirty seconds; however, the one in the Unit area was set to record noise levels during a whole Unit class, the noise sensor in the Hallway was set to record noise levels during the recess and lunch break, and the noise sensor in the Kindergarten area was set to record noise levels during a period where all the children in the group were gathering in the classroom for an hour. For the ozone project, we also generated averages, but in this case we decided that hourly averages would be more meaningful for the purpose of the project—compare concentrations in two different locations at the school. Both ozone sensors and the light sensor were set to take readings every thirty seconds; however in this case, the participant decided to let them run for the entire school day, from 9am to 3pm. This longer measurements would allow her to track changes in concentration through time. For the two projects, we produced graphs to observe the patterns of the data collected; nevertheless, for the case of ozone these graphs were more relevant as they showed meaningful trends of indoors and outdoors ozone, as well as sunlight, which led us to specific conclusions: ozone is determined by sunlight, and it easily spreads with the wind.

The possibility of collecting data, and the sophistication of the data itself, triggered two different kind of events during the case study. On the one hand, it generated the need for more knowledge regarding the chosen environmental issue, such as the measuring units and particular characteristics that resulted in further understanding of its causes and effects. On

the other hand, the management of the collected data gave the participants the opportunity to produce a variety of information that would not be biased by an external view. This data is analyzed and interpreted by the participants and is the basis for their discourse change towards a more critical way of addressing environmental issues. This critical thinking now is shaped by the participant conclusions and based on the gained knowledge and the analysis of the generated data, and not by a foreign environmentalist or an anti-environmentalist influence.

An interesting example was the part of the noise project where they decided to determine the noise level at the hallway during the recess and lunch time. After collecting the data, quantifying it and analyzing it, it was surprising for them that it was not as loud as they thought, or, as the teachers always tell them it is. They realized that they could learn more about noise and be more critical about their environment. They even suggested that, like the teachers judgement, this was just not reliable data, they would need it to make more measurements over time and compare them to have a better sense of what really is a regular noise level at the hallway during recess time. This consideration was a display of their new critical thinking attitude applied directly to the environmental issue being studied.

5.3 Discourse and Word Analysis

This analysis is a qualitative evaluation instrument that allows the identification of specific indicators through the analysis of the usage of specific words and the linguistic context in which those words are used.[49] In this particular case, we are looking for two different signs that can demonstrate that there has been an important change in people's discourse about the environment. First, the occurrence of new vocabulary indicates that there has been an addition to the knowledge and understanding of environmental issues. Second, the discourse in which these words are used as an effective piece of information to determine if the new terms are used correctly and if the participants are being more critical and sophisticated in their projects and their arguments. Since we had people that participated by the end of the study and also participants that started the study but did not finish it, the word analysis

is focused only in two of the participants. These two participants are the girl who built the noise poster and the girl who built the ozone poster, mainly because these are the only two examples where notes about their discourse could be collected during the whole extent of the course of study. The most significant changes are identified by comparing the discussion of the first day of the work at the school with the discourse of the participants on the last day I visited the school. However, there were also interesting conversations and rich verbal demonstrations during the middle part of the study, which consisted of the time while we planned projects and actually did measurements.

When the participants were referring to environmental problems at the beginning of the study, their discourse was general and their statements were based on what they have heard other people saying about particular environmental issues and also by their own ideas and beliefs. They referred to noise as isolated from environmental concern by affirming that “[they] are aware of noise around the school, but did not think that noise could be considered as an environmental problem.” During the first discussion sessions, they were able to generally address the issue of noise by trying to define which could be the loudest place at the school. In terms of ozone levels, they were only able to conceive it as a generic problem—‘air pollution’—but none of them mentioned the causes of air pollution or any specific data on a particular air pollutant. Later on, we specifically addressed the causes and effects of tropospheric ozone; we discussed a chemical reaction of hydrocarbons and nitrogen oxides with sunlight as a cause of concentrations of ozone in the air.

During the study, the discussion turned more specific as they were defining the projects that they engaged in. This discussion was so specific that it required the participants to use new words to describe their projects. Talking about being loud or louder was now a vague concept; therefore, they had to identify a measuring unit to compare noise around different places at the school emerged. This need introduced new words to the discussion, so we started to talk about ‘decibels’ as a measuring unit to concretize the concepts of ‘loud’ and ‘louder’. The noise project was interesting for some people around the school because, as mentioned before, they wanted to know if the Unit was louder than the Kindergarten or

Table 5.1: Summary of Noise Discourse and Word Analysis

Beginning of Study	End of Study	Interpretation
“We don’t think that noise is an environmental problem”	“Noise at the Unit classroom can affect our learning”	The discourse denotes a radical change towards critically think about the effects of noise
“The Unit classroom must be louder than the Kindergarten classroom”	“Average noise at the Unit during Humanities class was 68.91 decibels, and at the Kindergarten area it was 74.25 decibels”	New vocabulary, such as ‘decibels’, and the use of specific data like amounts, places and time, show a sophisticated project, with gain of knowledge, understanding and informed statements

vice versa. Some people asked how did it go, and the participant gave answers like “In the kindergarten classroom the average noise level was 74.25 decibels and during the Unit class it was only 68.91 decibels.” At this point, she did not only refer to the comparison in terms of loud and louder, but she was analyzing her data and utilizing the word ‘decibel’ which was not present in her discourse before.

Furthermore, when she was analyzing the data, she was more critical in terms of considering the causes of noise depending on the circumstances of each class and also the specific times of the measurements, agreeing that in the kindergarten area the noise levels are high because the younger children are playing. She was now being conscious about the context of noise problems and analyzing the collected data in a more sophisticated way. Then, when she was working on the noise poster, I asked why she thought it would be important to keep noise levels low at her classroom and she said “because noise at the Unit classroom can affect our learning.” The change in her discourse went from not thinking about noise as a problem to thinking that noise could, indeed, be an environmental problem with specific effects on learning in the particular context of a school. By the end of the study, as summarized in Figure 5.1, her discourse had totally changed; her new statements denote new vocabulary related to a deeper understanding of the chosen environmental issue and a critical thinking regarding its causes and effects.

Table 5.2: Summary of Ozone Discourse and Word Analysis

Beginning of Study	End of Study	Interpretation
“I do not clearly know what ground-level ozone is”	“There should be a lower concentration of ozone inside the school”	The discourse denotes a critical change in the way the participant thinks about air pollution
“I want to see if there is more ozone inside or outside”	“Inside ozone levels were lower than outside until the door was opened”	New vocabulary, such as ‘levels’ and conclusions about what determined the data denote an increment in participant’s knowledge and a sophisticated project
“I am measuring ozone levels around the school”	“I wonder if California has higher levels of ozone because they have more sunlight”	Extrapolation of new knowledge and critical thinking denotes a deep understanding of the causes of an environmental issue previously unknown

The project around air pollution implicated the comparison of specific amounts of ozone in the air as an indicator of air pollution, so the participant was happy to share with some of their professors and schoolmates that she was engaged in a project in which “[she was] measuring ozone levels around the school”. After running the sensors but before looking at the results, the participant said that she had a hypothesis, “there should be a lower concentration of ozone inside the school.” This was already a significant change in the way she understood air pollution, now she was talking about ‘levels’ of a particular air pollutant and understanding how will it behave according to its characteristics and its formation process. The main newly arisen vocabulary for the case of the ozone project were the words ‘concentration’ and ‘level’, and as related to that, the phrase ‘parts per million’. It was, in fact, easy for her to understand the unit in terms of parts of ozone per a million parts of air. She used this new concept to compare the concentration of ozone inside and outside the school. By analyzing the graphs of ozone trends, she concluded that the reason for the increase in the ozone concentration indoors was the fact that somebody opened the door, and this made it explicit that ozone particles rapidly spread with the wind.

At the last moments of the study, we were talking about the correlation between the

trends of sunlight and outdoors ozone showed by the data collected when she brought to the discussion a comment. She said “I wonder if California has higher levels of ozone because they have more sunlight.” This outstanding reaction of the participant is extremely relevant for two reasons. First, it shows that the experience allowed her to deeply understand the causes of a particular environmental problem, and second it makes evident that this deep understanding is leading her to a more critical approach by making more informed judgements. In fact, the area of California has been recently identified by the Environmental Protection Agency as an area of extreme and severe nonattainment of the 1-hour ozone standard,¹ which means that the concentrations of ozone in the air in this region are well above the environmental standards. This experience reveals that the education process and the use of the proposed learning material contributed to generate a more sophisticated mindset. In this case, the sophistication of thinking consists of the ability to extrapolate the new concepts and ideas about air pollution from the physical place in which we were working to a different setting in a different spatial context.

¹<http://www.epa.gov/oar/oaqps/greenbk/onmapc.html>

Chapter 6

Conclusion and Further Discussion

This study was conducted seeking enhancing environmental education through the reinforcement of the process by which people can develop knowledge and critical thinking regarding environmental issues. Based on a wide theoretical framework and previous studies focused on environmental education, this intention was materialized into the design of a moderated learning environment in which the use of technological tools are a key elements towards critical thinking and environmental understanding. The aim of this learning environment is to generate a possibility for people to gain deeper understanding and express critical arguments while addressing an environmental issue.

According to the established theoretical rationale, the learning environment should support learners' motivation to address environmental issues within a meaningful context, the capacity of people to design personal projects and methodologies, and the use of adequate learning material. The effectiveness of the learning environment and the learning material proposed for this study was evaluated in terms of a case study conducted at Fayerweather Street School. The analysis and evaluation of the meaningful projects developed during the case study show that an open learning environment enriched with suitable learning material is an adequate environment for people to dive into the study of environmental issues. By providing the opportunity to choose an environmental issue to address, interact with the chosen environment to produce and analyze data, and relate this data to a meaningful

context, the learning environment and the use of the technological learning material led the participants to a deeper understanding of the causes, effects and complex processes of environmental problems such as noise and air pollution. The designed learning environment supports the part of the environmental education process by which people develop deeper understanding of environmental issues, as well as more critical and informed arguments to address them. This process, however, does not always flow absolutely straight forward; there are some aspects of each one of the elements of the learning environment that are worth to mention and discuss.

In terms of initial motivation, it was clear that the participants, who were around 13 years old, and also some of their 7/8 grade teachers were interested in environmental issues in general and motivated to participate in the study. After the first visit there were about ten children engaged in the study. However, when they had the chance to choose a particular environmental issue, we had a variety of reactions. Some of them decided definitely not to participate in the study, which is fine in terms of the suggested methodology of respecting people's motivation and interests. At least one of them wanted to participate and suggested an interesting environmental issue but did not address it within this study, perhaps because a recycling project was beyond the scope of this study and in part because we did not have more time to figure it out for sure. Some others students decided to get involved and participate in the study; nevertheless, they also had different attitudes during the course of study. This attitudes were canalized by the facilitators; when the teacher suggested to work on a project of measuring noise at the school, her intervention was not to impose her will to the participants, but to suggest an exciting idea that generated interest among the children.

By the time we were setting the sensors and making measurement around the school, the number of participants that were deeply engaged in the projects dropped from ten to five. Some of the children that were not there all the time, still asked how the measurements were going but they were not making any contribution to the project. By the end of the study when they were building their concrete projects, there were only two participants that had carried out the study through the last steps and were engaged in producing a poster to

concretize their projects. Again, the other children were around and kept asking about the results of the project but still were not involved in the activities of producing the poster. I attribute part of this lack of motivation to deeply engage to the fact that we only had the recess time to work on their projects, and it was evident that most of the children were not eager to give up their spare time at school to participate in the study.

The participants who actually finished a project were also more proactive since the beginning of the study; these two girls were in fact who suggested the topics for the projects and the ones that proposed the hypotheses and carried out the methodology. This level of involvement made them feel responsible for their projects and motivated them to take that projects to a concrete end, enabling them to develop deeper understanding of the chosen environmental issue and generate critical and informed arguments to address it. On the other hand, even though they were interested in the topic, children who did not actively participate in the design of the methodology and the use of the learning material did not fully engaged in the project. These facts show that motivation to deeply understand environmental issues is not only defined by the interest on the theme, but into some extent, it is shaped by the opportunity of people to participate in the design of the educational experience.

Regarding the design of a contextualized methodology, during the study the participants responded in a proactive way to the opportunity to develop their own method for conducting an environmental project. This stage of the education process was grounded on the idea that people are able to formulate hypotheses regarding environmental issues. Discussion gives place to the generation of specific hypotheses for specific environmental issues, and the process was supported by the introduction of suitable learning material that fosters the corroboration of those specific hypotheses by providing the possibility to explore the environment. Their methodologies denote that they have the capacity to determine an initial idea and the capacity to develop a validation experiment, resembling the scientific method.

For one of the projects, the results of the experimentation did not support the hypothesis. The girl working on the noise project had the idea that noise levels in her classroom

were higher than in the kindergarten area, and that noise levels in the hallway during recess and lunch time were higher than those inside the classrooms while the class was going on. The results of the experimentation proved the contrary on both judgments, at least for the particular day of the measurements. These findings forced her to critically analyze the evidence and to suggest further explanations for those results giving place to the formulation of new hypotheses. Her arguments in this process of reshaping her ideas, brought to discussion and highlighted the causes and effects of noise at the school. This helped her to understand noise and to be more critical about what was happening with noise in the environment. She developed critical arguments such as suggesting that more evidence and more experimentation with measuring noise around the school was needed, and she also concluded that high noise levels in her classroom can interfere with their learning activities at the school, and critical judgements such as the probability that the hallway is not as noisy as the students and teachers thought it was.

What happened with the ozone project was somewhat different; the initial idea of the participant was proven true by the experimental project of measuring ozone levels indoors and comparing them with ozone levels outdoors. The results were consistent with the original hypothesis and the girl corroborated that the concentration of ozone particles indoors was significantly less than outdoors. Even though this was an incontestable finding, there still were some controversial results that, as happened with the noise project, gave place to a rich discussion that highlighted the formation process of ozone particles, and one of its most important characteristics. The results of the measurements showed her that when the door was opened, the indoors level of ozone raised to the same level present outdoors. This piece of information indicated us that ozone particles rapidly spread with the wind. Also, the graphics produced with the collected data showed a higher concentration towards midday, which emphasized the role of sunlight in the chemical reaction that gives formation to ozone particles, and made this complex process comprehensible for the participant. She developed informed and critical arguments that allowed her to extrapolate her new understanding of ozone particles and generate a new hypothesis regarding air pollution in a distant but

significant place such as California. The evolving discourse and change in the way of thinking about the chosen environmental issues denoted that during the education process, specifically while carrying out the designed methodology and analyzing their self-generated data, deeper understanding of environmental issues emerged. Evidently, the learning material played an important role in the process of carrying out the designed methodologies.

The proposed technological learning material supported the physical interaction that the participants had with the explored environment. The participants were able to use the proposed learning material as part of their methodologies as an advantageous feature; they experimented on real places to look at environmental issues in a more critical way by using the boards and sensors to collect their own data and to add significant content to their projects. The proposed learning material was an adequate tool for people to produce sufficient data to support new informed arguments that impacted the way in which they perceive and understand environmental issues. However, the participants did not make full use of all the specifications of these tools. As mentioned before, one of the characteristics that was underused was the expandable feature of the tools, which prevented them from creating new sensors to attach to the board.

It is relevant how the participants constrained themselves and their projects to the tools that were provided as examples. It is really common that when you introduce a foreign interaction system, such as the proposed learning material, people tend to start by imitating the given examples. After they start to test those examples, they begin a process of adaptation from those starting ideas to their own version of what is possible with those tools. In the case study, for logistical purposes we had to fit the study into a schedule that restricted the possibility of verifying if, through time, people would have moved from the given topic examples and environmental sensors to proposing new topics and creating new tools and sensors to attach to the board. At the beginning of the case study, participants rapidly defined the environmental issues that they wanted to explore, which based on the examples were noise and ground-level ozone, and they immediately started working on their projects. As mentioned before, the participants were addressing the chosen environmental issue and

understanding it within a meaningful context; they were addressing noise in the context of the school, and they were addressing ozone levels as part of an outdoors air pollution problem. Hence, even though they were addressing the example topics and using only the example tools, we had a productive learning experience because they used these tools within a totally different context than the one presented in the examples, which resulted in the creation of two substantial projects.

Another characteristic of the tool that did not appeal to them was the programming environment. As stated in Chapter 3, computer content and computational thought are not part of the school culture. Therefore, children were more interested in actually running the sensors to take readings but did not have enough time to get deeply involved in the process of programming the board, uploading and downloading the data or building models by programming with the collected data. The participants mentioned in their projects that the sensors were taking measurements every thirty seconds, and they were aware of the program that made the board and the sensors run, but they did not take an active role in this activities. As a facilitator of the study, I took most of the responsibility for doing the programming and the uploading of programs and downloading of data. However, the fact that the participants did not fully program the board and downloaded the data did not interfere with their education process. Even if they were not familiar with the kind of proposed technological tools, they are used to an open learning environment enriched with discussions as part of their school culture. By providing them with these tools, we also provided them with new subjects and more concrete ways of studying environmental issues. They were able to construct environmental understanding of specific issues, such as noise and air pollution, and to create final products that encompassed the activities that they went through as part of the learning process.

The amount of steps and activities that were performed during the case study was too ambitious to be carried out in such a short time. Even when the participants were able to create posters as products of the educational experience and reflect on them, we did not have time to re-engage in new projects and continue with the process of understanding and

critically thinking. The posters were useful for them to gather all the information generated during the study and to analyze it as a whole in the context of their projects to arrive at some understanding. This understanding gave place to new inquiries, new discussion and even new hypotheses. The girl working on the noise poster understood what was going on with noise, and realized that she should run more sensors in the hallway and continue to measure noise levels to pursue a more reliable conclusion. The girl working on the ozone poster understood how ozone is formed and she was interested now in extending this understanding to different spatial settings to continue with her process of understanding ozone particles. This kind of thinking that evolves from the creation of an artifact, or object to think with, takes us back to the steps of defining new hypotheses and going through the process in a loop that creates a habit of critical thinking. However, in this case study we did not have enough time to go through this process again, which would have been ideal.

Despite the fact that without time restrictions the possible number of environmental projects that can be developed using the proposed tools is myriad, a further step would be to continue investigating different kind of learning material that could give people the opportunity to engage in environmental projects that can lead them to deeper understanding of environmental issues that are not based on measurable elements. Furthermore, it would be also interesting to take this research into a farther step of the environmental education process and conduct a longitudinal study to determine if the understanding and critical thinking developed in this part of the environmental education process actually leads to the incorporation of new action skills into the participants future behavior towards the environment.

Appendix A

Specifications of the PSB

Table A.1: PSB List of Parts

Manufacturer	Part	Specifications	Amount/Board
Microchip	Microcontroller	PIC 16F877	1
Microchip	Memory Chip	24Lc256 32K	1
Phillips Semiconductors	Hex Inverter	74HCT04	1
National Semiconductor	Voltage Regulator	LM294OCT-5.0	1
National Semiconductor	OpAmp	LM358	1
Vishay Semiconductors	Transistor	2n3904	1
Vishay Semiconductors	Diode	1N4001	4
	Display	4x1	1
	Battery Pack	4xAA	1
	Power Jack	2.1 mm	1
	Crystal	20 MHz	1
	Capacitor	100 uF	1
	Resistors	30 ohms	1
		150 ohms	5
		1k	4
		3.3k	4
		33k	8
		47k	1
	LED	green	4
		red	1
	Menu Buttons		2
	Reset Button		1
	DB9 Connector		1
	On/Off switch		1
	SIP Connectors		

The programmable Sensing Board (PSB) has a simple design that allows a rapid identification of its parts. All of them are low cost components that are easy to find almost everywhere in the world. Its design is simple and makes the board easy to assemble. Table A.1 and the following schematic show a list of the components and the way in which they were connected. For more specifications of the Programmable Sensing Board, contact arnans@media.mit.edu

Appendix B

Specifications of Ozone Detector

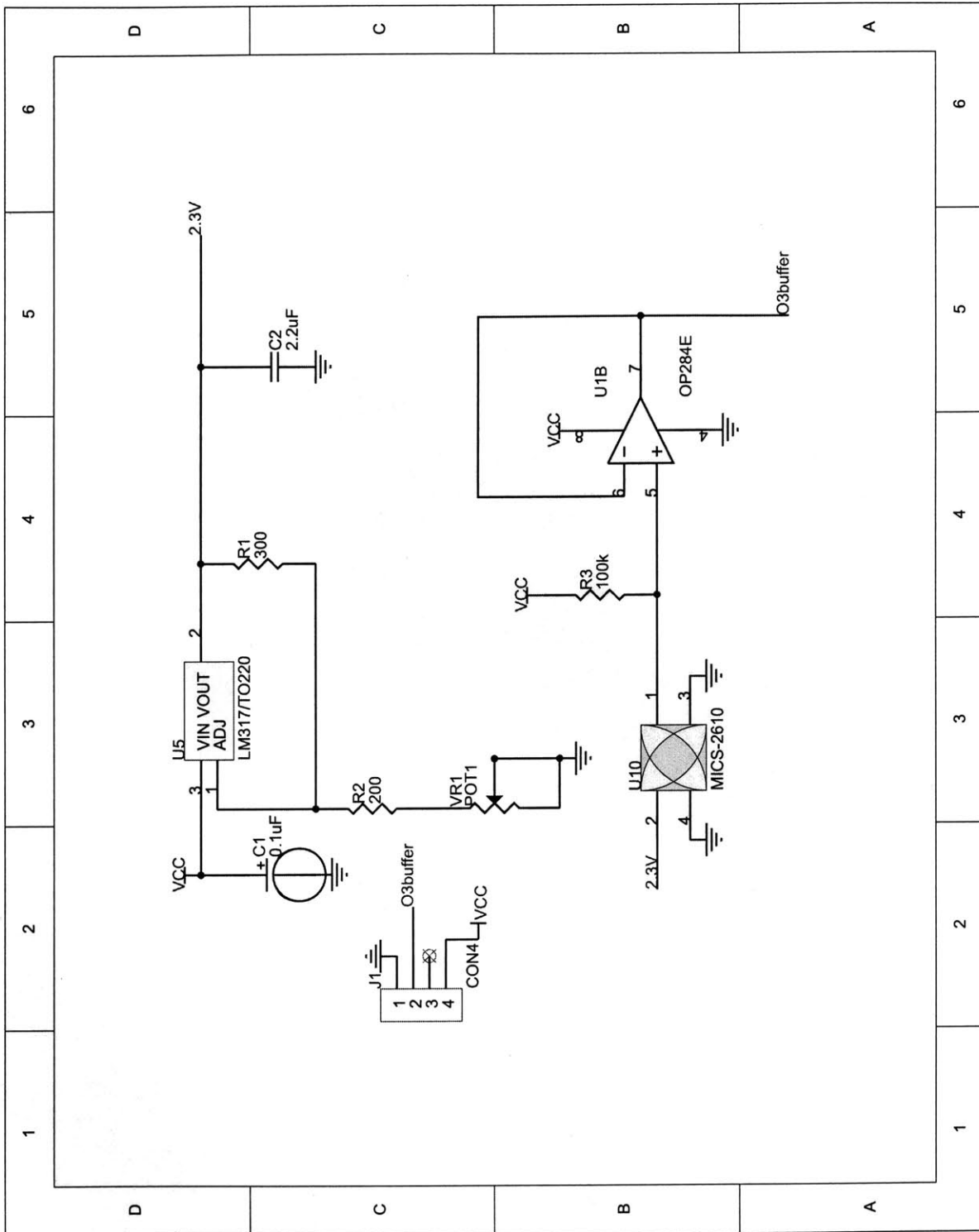

Figure B-1: Ozone detector Schematic Layout

Table B.1: Ozone Detector List of Parts

Manufacturer	Part	Specifications	Amount/Board
Analog Devices	OpAmp	OP284E	1
National Semiconductor	Voltage Regulator	LM317/TO-220	1
BOURNS	Potentiometer	3296Y-1-102	1
MicroChemical SA	Ozone Sensor	MiCS-2610	1
	Capacitors	0.1 uF	1
		2.2 uF	1
	Resistors	200 ohms	1
		300 ohms	1
		1k	1
	SIP Connectors		

The ground-level ozone detector mainly consists of the MiCS-2610, and the surrounding circuit to interface it with the Programmable Sensing Board, or any other suitable electronic board.

The ozone sensor circuit must be supplied with a voltage of 5V and Ground cable (VCC,GND) The voltage regulator and the potentiometer are used to generate the needed voltage for the sensor's heater. Turn the screw on the potentiometer until the output for the correspondent sensor pin is 2.3 volts. The OpAmp is used to buffer the output signal and it should be Rail to Rail input and output OpAmp to ensure reliable readings. It is important to mention that the sensor requires 30 minutes to heat prior reliable operation.

Table B.1 shows a list of the components that integrate this circuit, and Figure B-1 shows the way in which all the components are connected.

Appendix C

Specifications of Noise Sensor

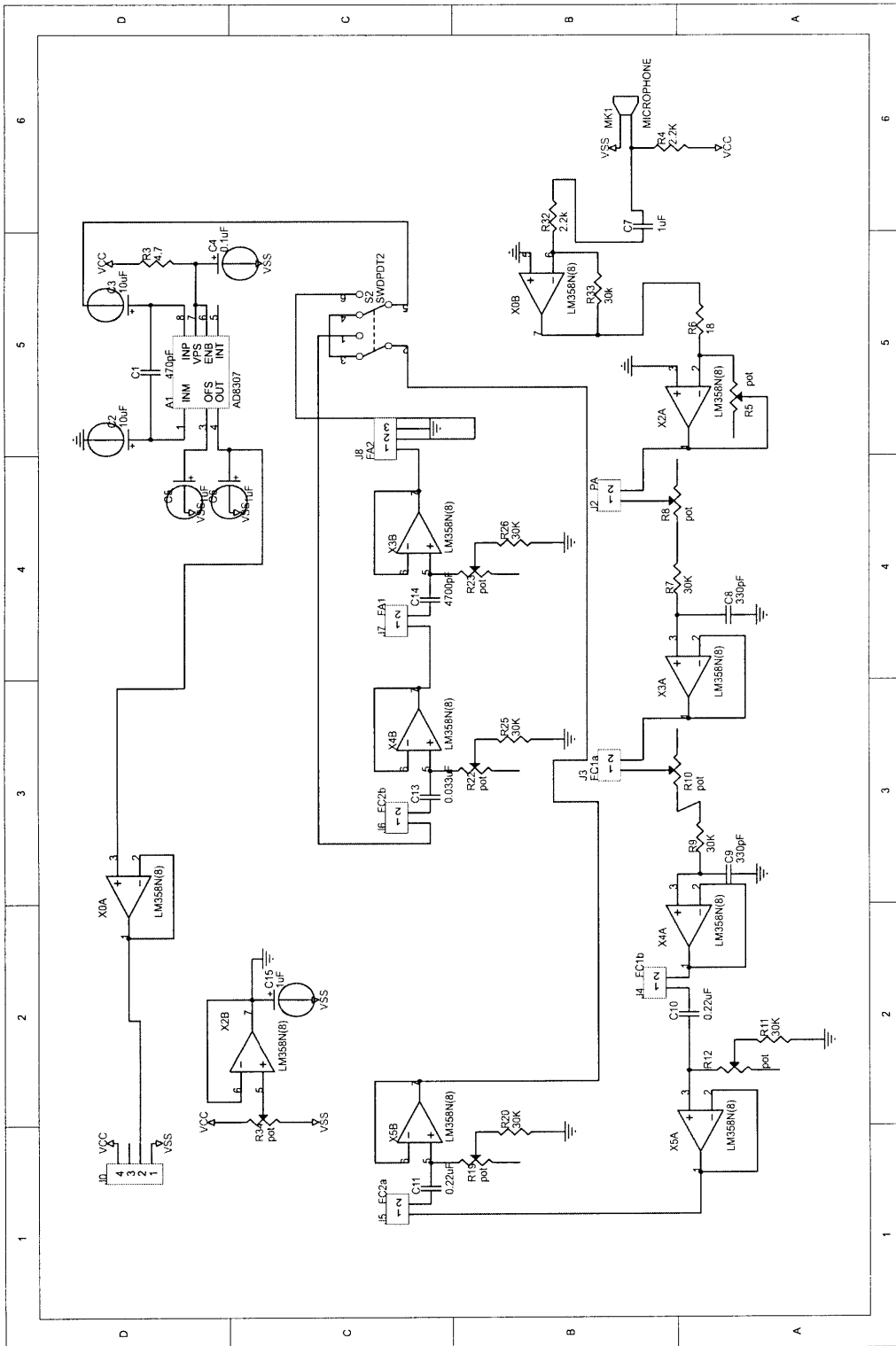

Figure C-1: Noise Sensor Schematic Layout

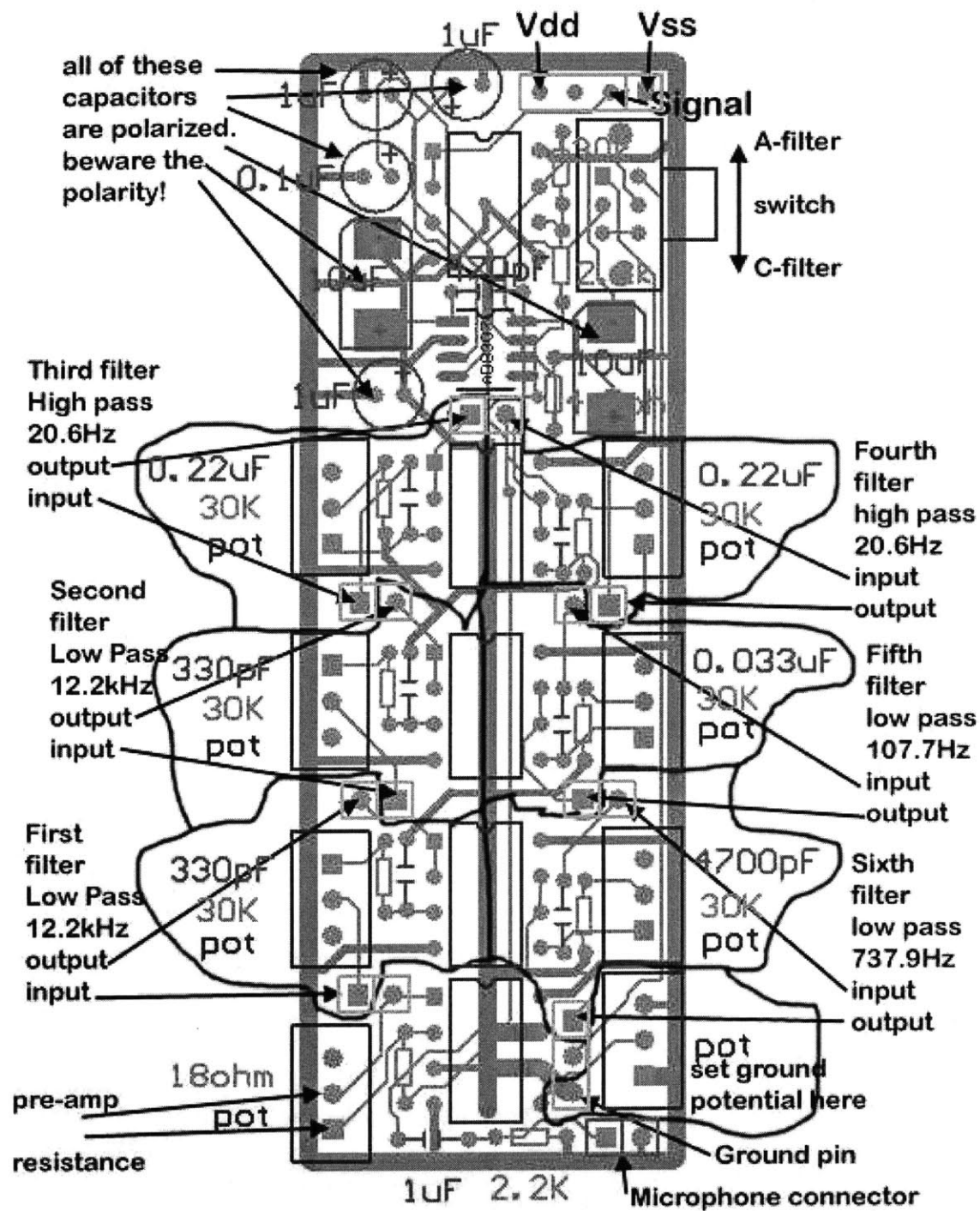

Figure C-2: Noise Sensor PCB Layout

Table C.1: Noise Sensor List of Parts

Manufacturer	Part	Specifications	Amount/Board
Analog Devices	OpAmp	OP284E	1
National Semiconductor	Voltage Regulator	LM317/TO-220	1
BOURNS	Potentiometer	3296Y-1-102	1
MicroChemical SA	Ozone Sensor	MiCS-2610	1
	Capacitors	0.1 uF	1
		2.2 uF	1
	Resistors	200 ohms	1
		300 ohms	1
		1k	1
	SIP Connectors		

Components shown in Table C.1 are used for the A and C filters. There are 6 single pole filters on the board. To tune them to the desired frequency use a power supply, a voltmeter, and a function generator. Flip the switch to A filter. Power the board with the supply at 5V (Vss and Vdd on Figure C-2), and then set the ground potential. Measure CD voltage between Vss and the Ground pin as you turn the screw on the corresponding potentiometer. Ground should be at 2V. The two first filters are low pass filters at 12.2kHz. Sine waves longer than 12.22kHz will pass through the filter but higher frequencies will be attenuated. Attach the ground of the signal generator and the ground of the volt meter to the ground pin. Input a sine wave at 1kHz on the first input pin and measure an AC voltage on the first output pin. Adjust the amplitude on the function generator until you have 0.5V at the output. Change the frequency of the function generator to 12.2kHz. Turn the screw on the potentiometer until the output is approximately 0.3536V. The second filter is tuned exactly the same way. The rest of the filters are high pass filters. Signals above their frequency should pass through and lower frequencies will be attenuated. Start the function generator about 10 times higher than the filter frequency. Adjust the amplitude until you measure 0.5V AC at the output, decrease the frequency to the filter frequency, and turn the potentiometer screw until you have about 0.3536V at the output. To set the pre amplification potentiometer, measure the pre amp resistance with an Ohm meter. It should be about 100 Ohms. Use the potentiometer to adjust the output level of the sensor.

Bibliography

- [1] United Nations Conference on Environment and Development Agenda 21, 1992.
- [2] Bowers C. A. *Educating for Eco-Justice and Community*. University of Georgia Press, USA, 2001.
- [3] Disinger John F. Environmental education definition problem. Information Bulletin No. 2, ERIC Clearinghouse for Science, Mathematics and Environmental Education, Columbus, OH., 1983.
- [4] Unesco-UNEP International Environmental Education Programme. *Environmental Education Series 9 Module for Pre-Service Training of Social Science Teachers and Supervisors for Secondary Schools*. Prepared at the National Council of Educational Research and Training, New Delhi, India, by: Dr. Savita Sinha, Dr. N.K. Jangira and Mrs. Supta Das, edited by professor willard j. jacobson, teachers college, columbia university in new york, n.y., u.s.a. edition.
- [5] United Nations Environmental Program Charter of Belgrade, 1975.
- [6] Sigit Sudarmadi Et. Al. A survey of perception, knowledge, awareness, and attitude in regard to environmental problems in a sample of two different social groups in jakarta, indonesia. *Environment, Development and Sustainability*, 3:169–183, 2001.
- [7] Thapa Brijesh. Environmental concern: A comparative analysis between students in recreation and park management and other departments. *Environmental Education Research*, 7(1):39–53, 2001.
- [8] Carson Rachel. *Silent Spring*. Houghton Mifflin, USA, 1994.
- [9] Chapman David and Sharma Kamala. Environmental attitudes and behavior of primary and secondary students in asian cities: An overview strategy for implementing an eco-schools programme. *The Environmentalist*, 21:265–272, 2001.
- [10] Senge Peter M. *The Fifth Discipline: The Art and Practice of the Learning Organization*. DOUBLEDAY, New York, New York, 1990.

- [11] Smith-Sebasto N.J. Environmental issues information sheet: Environmental education. Published by the University of Illinois Cooperative Extension Service, September 1997. EI-2.
- [12] Jimenez Alexandre Maria Pilar. Knowledge producers or knowledge consumers? argumentation and decision making about environmental management. *International Journal of Science Education*, 24(11):1171–1190, 2002.
- [13] Kassas M. Environmental education: Biodiversity. *The Environmentalist*, 22(22):345–351, 2002.
- [14] Disinger John F. Environmental education research news. *The Environmentalist*, 17:153–156, 1997.
- [15] Seke Alexius. Developing positive attitudes and values on the environment: A study in environmental education. *International Research in Geographical and Environmental Education*, Vol. 9(No. 1):53–57, 2000.
- [16] Moore H. Kent. Energy related information-attitude measures of college-age students. *The journal of Environmental Education*, 12:30–33, 1981.
- [17] Petrucci Mario. Recipe for disaster. *The environmentalist*, 22:297–300, 2002.
- [18] Papert Seymour. Some poetic and social criteria for education design. Appendix to a Proposal to the National Science Foundation, 1976.
- [19] Ulrich Bosler and Jürgen Lehmann. Students as water monitoring experts - new forms of environmental learning in the shools for a living river elbe project. *Int. Journal of Environmental Education and Information*, 20(2):93–106, 2001.
- [20] Ennis R. H. A taxonomy of critical thinking dispositions and abilities. In J. Baron and R. Sternberg, editors, *Teaching Thinking Skills: Theory and Practice*, pages 9–26. W.H. Freeman, NY, 1987.
- [21] Dewey John. *How We Think*, chapter "Natural Resources in the Training of Thought" Chapter 3, pages 29–44. D.C. Heath, Mass., 1910.
- [22] Hein George E. Constructivist learning theory. In Lesley College. Massachusetts USA, editor, *The Museum and the Needs of People*, Jerusalem, Israel, Jerusalem Israel, 15-22 October 1991. CECA (International Committee of Museum Educators).
- [23] *Conceptos Basicos Sobre Educacion Ambiental (Basic Concepts of Environmental Education)*, Buenos Aires, Argentina, 2000. Biblioteca del Congreso de la Nacion y Fundacion Vida Silvestre Argentina. Contenidos del "Curso de Capacitacion en Educacion Ambiental" 5 Septiembre - 31 Octubre de 2000.

- [24] I. Harel and S. Papert. *Constructionism*. Ablex Publishing Corporation, Norwood, NJ, 1991.
- [25] Edith Ackermann. *From Decontextualized to Situated Knowledge: Revisiting Piaget's Water-Level Experiments: Constructionist Learning*. Idit Harel, Cambridge, MA: MIT Media Laboratory, 1990.
- [26] Bogeholz Susanne. Teaching sustainable development: The influence of social background, nature experience and environmental knowledge. In *Komorek et al (Hg.): Research in Science Education Past, Present, and Future*, volume 1, pages 15–17, Kiel, Germany, 1999. European Science Education Research Association (E.S.E.R.A.).
- [27] Stone M. et Al. New technologies to support teaching for understanding. *International Journal of Education Research*, 35:483–501, 2001.
- [28] Maria Pilar Jimenez Aleixandre and Ramon Lopez Rodriguez. Designing a field code: Environmental values in primary school. a longitudinal study. *Environmental Education Research*, 7(1):5–22, 2001.
- [29] Myron Lucius Ashley. *Studies in Logical Theory*, chapter "The Nature of Hypothesis". Chapter 7, pages 143–183. University of Chicago, Chicago, edited by John Dewey edition, 1903.
- [30] Resnick Mitchel. Thinking like a tree (and other forms of ecological thinking). To be published in the *International Journal of Computers for Mathematical Learning*.
- [31] Sheehy Et.Al. How children solve environmental problems. *Environmental Education Research*, 6(2):109–126, 2000.
- [32] Lorschbach A. and Tobin K. Constructivism as a referent for science teaching. In *Research Matters to the Science Teacher, NARST Monography No. 5*, page 7, 1992.
- [33] Ackermann Edith. Piaget's constructivism, Papert's constructionism: What's the difference? Publication in progress, 2001.
- [34] Papert Seymour. What's the big idea? towards a pedagogy of idea power. *IBM Systems Journal*, 39(3 and 4):720–728, 2000.
- [35] Robert F. Tinker. Science for kids: The promise of technology. In Linda Roberts Sheingold Karen and Shirley Malcom, editors, *Technology for Teaching and Learning*, DC, 1991. AAAS.
- [36] Soloway Elliot Et.Al. Scaffolding in the small: Designing educational supports for concept mapping on handheld computers. In *CHI '02 Extended Abstracts on Human Factors in Computer Systems*, Minneapolis, Minnesota, USA, April 20–25 2002.

- [37] Elliot Soloway Amanda Pryor and the Hi-C Research Group. Foundations of science: Using technology to support authentic science learning. unknown publish data.
- [38] Resnick M. Berg R. and Eisenberg M. Beyond black boxes: Bringing transparency and aesthetics back to scientific investigation. *Journal of the Learning Sciences*, 9(1):7–30, 2000.
- [39] B.G. Wilson. Metaphors for instruction: Why we talk about learning environments. *Educational Technology*, 35(5):25–30, 1995.
- [40] Smith Brian K and Blankinship Erik. Imagery as data: Structures for visual model building. In *Proceedings of Computer Support for Collaborative Learning 99*, pages 549–557, 1999.
- [41] Chan Kara. Use of environmental teaching kits in hong kong. *The Environmentalist*, 20:113–121, 2000.
- [42] Environmental Protection Agency. Ground-level ozone (smog) information. <http://www.epa.gov/region01/eco/ozone/index.html>.
- [43] Powell Hugh. Lecture 4 - tropospheric chemistry and photochemical smog. <http://www.dur.ac.uk/d.h.powell/resources/ACLEC4/sld001.htm>, 2/6 01.
- [44] Environmental Protection Agency. Noise - introduction. <http://www.epa.vic.gov.au/Students/Noise/>.
- [45] Papert Seymour. *Mind-Storms Children, Computers, and Powerful Ideas*. Basic Books, USA, 1980.
- [46] Smith-Sebasto N.J. Potential guidelines for conducting and reporting environmental education research: Qualitative methods of inquiry. *Environmental Education Research*, 6(1):9–26, Feb. 2000.
- [47] Simon Fraser McLennan. *Logical Theory*, chapter "Typical Stages in the Development of Judgment". Chapter 6, pages 128–142. University of Chicago, Chicago, 1903. edited by John Dewey.
- [48] Pamela Courtenay-Hall. Textbooks, teachers, and full-colour vision: Some thoughts on evaluating environmental education 'performance'. *Canadian Journal of Environmental Education*, 3:27–40, 1998.
- [49] Strauss Anselm and Corbin Juliet. *Basics of Qualitative Research*. SAGE Publications, USA, 2nd edition, 1998.