

**A uniform syntax for phrasal movement:  
A case study of Dinka Bor**

by

Coppe van Urk

BA, Utrecht University (2008)  
MA, Utrecht University (2010)

**ARCHIVES**

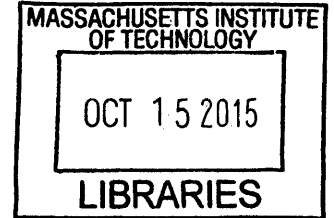

Submitted to the Department of Linguistics and Philosophy  
in partial fulfillment of the requirements for the degree of

Doctor of Philosophy

at the

MASSACHUSETTS INSTITUTE OF TECHNOLOGY

September 2015

© 2015 Coppe van Urk. All rights reserved.

The author hereby grants to MIT permission to reproduce and to distribute publicly paper and electronic copies of this thesis document in whole or in part in any medium now known or hereafter created.

**Signature redacted**

Author ...

.....  
Department of Linguistics and Philosophy  
August 14, 2015

**Signature redacted**

Certified by ...

.....  
David Pesetsky  
Ferrari P. Ward Professor of Linguistics  
Thesis supervisor

**Signature redacted**

Accepted by ...

.....  
David Pesetsky  
Head, Department of Linguistics and Philosophy



**A uniform syntax for phrasal movement:  
A case study of Dinka Bor**  
by  
Coppe van Urk

Submitted to the Department of Linguistics and Philosophy  
on August 14, 2015, in partial fulfillment of the  
requirements for the degree of  
Doctor of Philosophy

*Abstract*

This dissertation argues that all instances of phrasal movement are the result of Agree and Merge (Chomsky 1995, 2001), and, in addition to this, that the existence of different types of movement derives solely from variation in properties of the feature involved in the Agree relation. Guided by novel data from the Nilotic language Dinka Bor (South Sudan), I apply this view to three kinds of movement: A-movement,  $\bar{A}$ -movement, and intermediate movement steps of successive-cyclic dependencies. In addition, I present a novel argument, from patterns of pronoun copying, that all phrasal movement arises from Merge.



## Acknowledgements

I'm not sure I would have ended up in grad school if I hadn't been so lucky to cross paths with Ken Safir and Sharon Unsworth. Sharon was very kind to let me work on a few projects as an undergrad and I owe a lot to her ability to be simultaneously demanding and encouraging (my apologies that there is no acquisition in this dissertation!). Ken taught me a great deal in a short period of time about how to think about syntax and most of what I've done since has been an attempt to imitate him. Eric Reuland made a lot of things possible for me and was a great teacher and supervisor. I am indebted also to Bill Philip and Eddy Ruys, my first syntax teachers, and the first to make me aware of how exciting drawing lines on paper and labeling them is. Finally, I suspect I learned a lot more than I realize from Simon Cook and Syreetha Domen.

I had no real idea what I was doing when I applied to MIT, but in retrospect it was one of the best decisions I have ever made. I owe a great deal to David Pesetsky, whose approachability and warmth to a clueless visitor (for whom he bore no real responsibility) made clear that MIT was where I wanted to be. David was my advisor throughout my time at MIT and went above and beyond in this role in so many different ways it is hard to capture in a single paragraph. David has an unerring ability to sense when his advising is needed and I learned most of the worthwhile things I know from him, not only about syntax, but also about writing handouts, abstracts, and papers, teaching, advising, and life.

It has been a joy to have been able to work with Norvin Richards. I am not sure I would have gotten anywhere in my work on Dinka if it had not been for Norvin's encouragement and enthusiasm. Most of my ideas about Dinka have their genesis in discussions with Norvin, and he has an amazing capacity to see the connections between data and theory.

I learned a lot about how to be a linguist from Sabine Iatridou throughout grad school. Sabine never failed to push me towards the right questions and taught me how to be productively critical of my own work. I am also indebted to Sabine for her extensive care and advice on all the different parts of academic life.

I am very glad that Claire Halpert agreed to join my committee. Claire is someone I looked up to already as a fellow student and her work has been a model for me in many respects. Claire's optimism and generosity really helped me through the difficult task of writing a dissertation and her intuitions about data helped me out of several frustrating dead-ends.

I also feel fortunate to have been able to study Dinka and I am grateful for all the help I received to make it possible from the community in the Boston area, particularly from Mangok Bol, Moses Ajou, Mabiari Akoor Guot, the South Sudanese Education Fund, and everyone at the Grace Episcopal Church in Everett. Mangok Bol especially is one of the most insightful and inspiring people I know and I deeply admire his courage and resilience in the face of tremendous adversity.

MIT has been an incredibly stimulating and fun environment and I am grateful to everyone who was part of the MIT linguistics community in the past five years. I especially enjoyed classes

and conversations with Adam Albright, Edward Flemming, Danny Fox, Shigeru Miyagawa, Roger Schwarzschild, and Donca Steriade. Much of what makes MIT such a supportive and creative place to be is the students. I am thankful for all of ling-10, who had to put up with me the longest. I also got a lot out of conversations, whether linguistic or otherwise, with Sam Al-Khatib, Isa Kerem Bayırlı, Bronwyn Bjorkman, Kenyon Branan, Anthony Brohan, Jessica Coon, Iain Giblin, Jeremy Hartman, Yusuke Imanishi, Snejana Iovtcheva, Rafael Nonato, Despina Oikonomou, Erin Olson, Omer Preminger, Ezer Rasin, Kirill Shklovsky, Milena Sisovics, Benjamin Storme, and Yasu Sudo.

The last years of grad school are the toughest in many respects and there are a number of people who were there for me in significant ways. I wrote a lot of this dissertation in the company of Ted Levin, who had to listen to many of the worst iterations of the ideas found here. I am grateful for his insight and friendship, stonefruit pourovers, occasional boozy lunches, being bold, and doctoral boots. I thank Sam Zukoff for games of FIFA, spontaneous trips to Montreal, and cheesestrings. Paul Marty and Sam Steddy, my fellow eurotrash, were great roommates and even better Mario Kart opponents. Michelle Yuan has been a terrific officemate and friend, despite her love of cats, flexing, and rejecting high-fives. My thanks to Juliet Stanton for being a great 8th floor buddy, for work parties, defense cakes, and board games. I thank Athulya Aravind for never looking after her phone and for excellent life advice and podcast recommendations. Laura Kalin is the best person to face the job market with, and my favorite conference companion. I am also grateful to Aron Hirsch, Hadas Kotek, Chris O'Brien, and Michael Y. Erlewine for many good conversations and nights out.

Outside of linguistics, I thank my bio friends, particularly Boris, Jason, Joan, Lori, and the Shinglerickses. I feel incredibly fortunate for MK, my hiking, drinking, running, backpacking, snowboarding, PhDing partner, and my favorite two letters, for always encouraging the right things in me and for driving me everywhere. Finally, I am grateful for my family, to whom this thesis is dedicated, for their love and support throughout my academic life, even when it took me far away and I often had no idea where it was going to take me.

\*\*\*\*\*

*This work is made possible by an NSF Dissertation Improvement Grant, BCS-1440427. Any opinions, findings, and conclusions or recommendations expressed in this material are those of the author(s) and do not necessarily reflect the views of the National Science Foundation. I also benefited from support from the MIT Ken Hale Fund in earlier stages of the project.*

*Voor Chris, Klaas, en Wes*





## Table of contents

<b>Chapter 1: Introduction</b>	<b>15</b>
<b>1 Main claim</b>	<b>15</b>
<b>2 Overview of dissertation</b>	<b>18</b>
2.1 Chapter 2: Eliminating A/ $\bar{A}$ -positions . . . . .	18
2.2 Chapter 3–4: Dinka clause structure & The A/ $\bar{A}$ -distinction in Dinka . . . . .	19
2.3 Chapter 5: Intermediate movement in Dinka . . . . .	19
2.4 Chapter 6: Pronoun copying . . . . .	20
<b>Chapter 2: Eliminating A/<math>\bar{A}</math>-positions</b>	<b>23</b>
<b>1 Introduction</b>	<b>23</b>
<b>2 Two types of features</b>	<b>27</b>
2.1 Locality . . . . .	27
2.2 Categorical restrictions and pied-piping . . . . .	30
<b>3 Reconstruction for Principle C and case assignment</b>	<b>32</b>
<b>4 Weak Crossover, parasitic gaps, and the interpretation of chains</b>	<b>37</b>
4.1 Weak Crossover . . . . .	38
4.2 Parasitic gaps and depictives . . . . .	46
<b>5 Some consequences of a featural approach</b>	<b>51</b>
5.1 On the status of thematic positions . . . . .	52
5.2 A prediction of the featural approach . . . . .	53
<b>6 Summary</b>	<b>57</b>
<b>Chapter 3: Dinka clause structure</b>	<b>59</b>
<b>1 Background on Dinka</b>	<b>59</b>
<b>2 The Dinka left periphery</b>	<b>61</b>
2.1 V2 in Dinka . . . . .	61
2.2 Voice in Dinka . . . . .	64
2.3 On the treatment of Dinka voice . . . . .	68

2.4	Voice is independent of case . . . . .	71
2.5	The syntax of Oblique Voice clauses . . . . .	74
<b>3</b>	<b>The Dinka middle field and right periphery</b>	<b>78</b>
3.1	V2 in the verb phrase . . . . .	79
3.2	Genitive case and in situ subjects . . . . .	86
<b>4</b>	<b>Summary</b>	<b>92</b>
 <b>Chapter 4: The A/<math>\bar{A}</math>-distinction in Dinka</b>		<b>93</b>
<b>1</b>	<b>Introduction</b>	<b>93</b>
<b>2</b>	<b>Long-distance movement in Dinka</b>	<b>94</b>
2.1	Topicalization and relativization . . . . .	94
2.2	Topicalization and relativization involve movement . . . . .	98
<b>3</b>	<b>Agreement, case, and long-distance movement</b>	<b>102</b>
3.1	Long-distance movement, $\varphi$ -agreement, and case . . . . .	102
3.2	A composite probe on C . . . . .	106
<b>4</b>	<b>Movement in Dinka and binding</b>	<b>109</b>
4.1	Weak Crossover and anaphor binding . . . . .	109
4.2	Reconstruction for Principle C . . . . .	113
<b>5</b>	<b><math>\bar{A}</math>-movement with A-properties in other languages</b>	<b>116</b>
5.1	Austronesian and the A/ $\bar{A}$ -distinction . . . . .	117
5.2	Agreement and $\bar{A}$ -movement in Bantu . . . . .	121
<b>6</b>	<b>Summary</b>	<b>125</b>
 <b>Chapter 5: Intermediate movement in Dinka</b>		<b>127</b>
<b>1</b>	<b>Introduction</b>	<b>127</b>
<b>2</b>	<b>Successive cyclicity and embedded V2 in Dinka</b>	<b>129</b>
2.1	Embedded V2 in Dinka . . . . .	129
2.2	Embedded V2 and intermediate movement . . . . .	132
<b>3</b>	<b>Intermediate movement involves Agree</b>	<b>137</b>
3.1	Intermediate movement and probing by multiple features . . . . .	137
3.2	Competition between $\bar{A}$ -movements . . . . .	139

<b>4</b>	<b>V2 in the verb phrase</b>	<b>148</b>
4.1	V2 in ditransitives and causatives . . . . .	148
4.2	Verb phrase V2 and complement clauses . . . . .	155
<b>5</b>	<b>Intermediate movement in the verb phrase</b>	<b>161</b>
5.1	Verb phrase V2 and intermediate movement . . . . .	161
5.2	Multiple probes on <i>v</i> . . . . .	168
5.3	Object agreement and successive cyclicity . . . . .	175
<b>6</b>	<b>On the parallelism of CP and <i>v</i>P</b>	<b>176</b>
6.1	Extraction marking . . . . .	177
6.2	<i>Wh</i> -trapping and clausal pied-piping . . . . .	180
6.3	Scope trapping . . . . .	184
6.4	Stranding . . . . .	186
6.5	Downstep deletion in Kikuyu . . . . .	189
6.6	Inversion . . . . .	190
<b>7</b>	<b>Summary</b>	<b>192</b>
 <b>Chapter 6: Pronoun copying</b>		<b>193</b>
<b>1</b>	<b>Introduction</b>	<b>193</b>
<b>2</b>	<b>Resumption and argument doubling as pronoun copying</b>	<b>198</b>
2.1	Movement-derived instances of resumption . . . . .	198
2.2	Clitic doubling, subject doubling, and <i>wh</i> -copying . . . . .	204
<b>3</b>	<b>Pronoun copying in Dinka</b>	<b>213</b>
3.1	<i>Ké</i> -copying . . . . .	213
3.2	Copied <i>ké</i> is a pronoun . . . . .	215
3.3	<i>Ké</i> -copying tracks intermediate movement . . . . .	217
3.4	<i>Ké</i> -copying is spell-out of a copy . . . . .	219
3.5	Pronoun copying in Seereer . . . . .	221
<b>4</b>	<b>Asymmetries and gaps in pronoun copying</b>	<b>224</b>
4.1	A person-number asymmetry . . . . .	224
4.2	Gaps in pronoun copying . . . . .	232
<b>5</b>	<b>Pronoun copying as partial spell-out</b>	<b>237</b>
5.1	Plural marking in Dinka . . . . .	238
5.2	Why DPs copy as pronouns . . . . .	244

5.3	Partial spell-out, asymmetries, and gaps . . . . .	249
5.4	On the absence of copying at Spec-CP . . . . .	255
<b>6</b>	<b>Summary</b>	<b>256</b>
 <b>Chapter 7: Conclusion</b>		<b>259</b>
<b>1</b>	<b>Recap of dissertation</b>	<b>259</b>
<b>2</b>	<b>Some remaining issues</b>	<b>262</b>
2.1	On head movement . . . . .	262
2.2	What triggers movement . . . . .	264
 <b>References</b>		<b>267</b>

## Abbreviations for Dinka

1	=	1st person
2	=	2nd person
3	=	3rd person
ALL	=	allative
AP	=	antipassive
ASSOC	=	associative plural
C	=	complementizer
CS	=	construct state
D	=	declarative
DTR	=	ditransitive
ESS	=	essive
FUT	=	future
GEN	=	genitive
HAB	=	habitual
INCH	=	inchoative
INT	=	interrogative
INTR	=	intransitive
NEG	=	negation
NF	=	non-finite
OBLV	=	Oblique Voice
OV	=	Object Voice
P	=	preposition
P/PL	=	plural
PASS	=	passive
POSS	=	possessive
PRF	=	perfect
PST	=	past
S/SG	=	singular
SV	=	Subject Voice



## CHAPTER ONE

### INTRODUCTION

---

This dissertation examines the syntax of phrasal movement and the question of why there should be distinct types of phrasal movement, such as A-movement,  $\bar{A}$ -movement, and intermediate steps of successive-cyclic movement.<sup>1</sup> The main proposal that I will argue for is that all instances of phrasal movement involve Agree and Merge (Chomsky 1995, 2001) and that differences between movement types arise because the identity of the feature involved in Agree may vary. In this view, for example, differences in what phrases can participate in a particular type of movement or in what position can be targeted reflect only where the relevant feature may appear. In other words, all variation resides in the Agree relation. This approach provides an answer to why should there be various types of movement without needing to posit diverging syntactic mechanisms or distinct kinds of syntactic positions. Support for this view comes from the system of phrasal movement in the Nilotic language Dinka (South Sudan), in which no clear distinction is found between A- and  $\bar{A}$ -movement or between intermediate and final movement steps of successive-cyclic dependencies, a pattern that demonstrates that there cannot be radical differences between movement types.

#### 1 Main claim

There are many types of phrasal movement across languages, with a variety of effects and functions. The pairs in (1–4) illustrate some of the ways in which noun phrases can be displaced in English.

(1) *Raising:*

- a. It seems that **the world** is round.
- b. **The world** seems \_\_\_\_ to be round.





(2) *Passivization:*

- a. Someone broke **the lamp**.
- b. **The lamp** was broken \_\_\_\_.

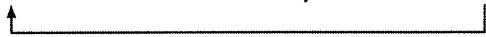

---

1. I set aside head movement for the most part, though see Chapter 7 (sec. 2.1) for some discussion.

- (3) **Wh-movement:**
- a. I thought that you had read **those books**.
- b. **Which books** did I think that you had read \_\_\_?
- 
- (4) **Topicalization:**
- a. I have never seen **these people** before.
- b. **These people**, I have never seen \_\_\_ before.
- 

As these examples make clear, different types of phrasal movement vary a great deal in how they affect the structure of the surrounding sentence and in their effects on interpretation. In English, passivization requires a participle and auxiliary (2b), and *wh*-movement triggers subject-auxiliary inversion (3b), while topicalization does not obviously alter the surrounding material at all (4b). Passivization demotes the thematic subject, while *wh*-movement changes a statement into a question. In the face of this morphosyntactic and semantic diversity, the question arises whether the examples in (1–4) are established by the same syntactic mechanisms and, in addition, why there should be distinct kinds of phrasal movement.

A major claim in minimalist syntax as well as in the Government & Binding framework is that the same mechanisms are at work in all of (1–4) (e.g. Chomsky 1981, 1995). Chomsky (1995, 2001) proposes that all instances of movement are the output of Merge, accompanied by a relation of feature checking/valuation. I adopt this idea here, specifically that all phrasal movement results from the successive application of Agree and Merge, as in (5).<sup>2</sup>

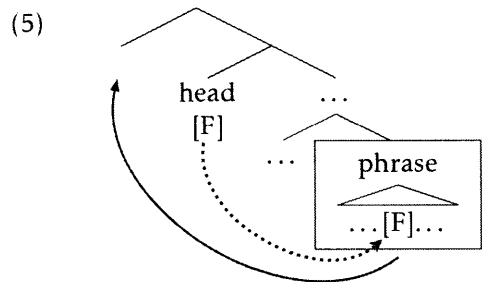

- Phrasal movement:**
- When a head is merged with a triggering feature F...
1. **Agree:** The trigger F **finds** the (closest) phrase bearing the same feature F.  
(dotted line)
  2. **Merge:** The trigger **attracts** the phrase.  
(solid line)

In the view represented by (5), phrasal movement occurs in two steps: a search relation initiated by a probe carrying a feature F resulting in an Agree relation, followed by Merge of the goal XP with the probing head.

2. An alternative view that is in principle compatible with the arguments developed in this thesis is to have Merge precede Agree (e.g. Bošković 2007). A possible advantage of such an approach is that may shed light on why Agree should trigger Merge. See Chapter 7 (sec. 2.2) for discussion.



If (5) indeed underlies all instances of movement in (1–4), there is one property that we might naturally expect to give rise to different movement types: the identity of the feature [F]. All things being equal, the positions created by Merge, regardless of what phrase and head are involved, should have the same properties, but we might expect the identity of [F] to differ and to find associated differences in the Agree relation. The main hypothesis of this dissertation is that this is the source of the variety found in phrasal movement, so that different types of movement, such as A- and  $\bar{A}$ -movement, correspond essentially to different types of features. I call this the *featural view of phrasal movement* (6).

(6) ***Featural view of phrasal movement:***

Differences between movement types derive from independent properties of the feature(s) involved in Agree.

An important consequence of (6) is that there can be no intrinsic differences across movement types in positions, mechanisms, or timing. Instead, differences between movement come about only because of independent properties of particular features (such as differences in their distribution, which carve out divergent sets of possible goals for Agree), for instance in how these interact with syntactic restrictions on Agree (such as Relativized Minimality).

The main objective of this dissertation is to justify the view in (6) for two major distinctions drawn between types of phrasal movement: the A/ $\bar{A}$ -distinction and the difference between final and intermediate movement steps of successive-cyclic dependencies. Applied to the A/ $\bar{A}$ -distinction, the hypothesis in (6) requires abandoning the idea that A- and  $\bar{A}$ -movement are distinguished by the position they target (e.g. Chomsky 1981, 1995; Mahajan 1990; Déprez 1990; Miyagawa 2010). In the first part of this dissertation (Chapter 2–4), I argue for this conclusion and show how the various properties of A- and  $\bar{A}$ -movement can be derived from the idea that they involve different *features*, without needing to posit the existence of A- and  $\bar{A}$ -*positions* with distinct properties. This approach also has ramifications for the treatment of intermediate movement steps of successive-cyclic dependencies. If all movement involves Agree and Merge, then such movement too must involve an Agree relation (e.g. Chomsky 1995; McCloskey 2002; Abels 2012). I will argue that this conclusion is correct also in Chapter 5, by showing that, in many instances, terminal and intermediate movement have the same syntactic effects. Finally, in Chapter 6, I present a new argument from patterns of pronoun copying that all instances of phrasal movement involve the same operation of Merge.

In arguing for the view of phrasal movement that emerges from (6), I draw primarily from an investigation of phrasal movement in the Nilotic language Dinka Bor (South Sudan), which will be the focus of much of this work. We will see that Dinka provides particular insight into the syntax of phrasal movement in a number of ways. Dinka fails to draw a clear distinction between varieties of movement traditionally thought to be different, including A- and  $\bar{A}$ -movement and intermediate movement steps of successive-cyclic dependencies and movement to the final landing site. This

will provide crucial evidence for the idea that different types of phrasal movement should be given a uniform treatment across languages and in the theory of grammar.

## 2 Overview of dissertation

This section summarizes the main claims of each chapter of the dissertation. The dissertation is organized into three parts: the first and most substantial part (Chapters 2–4) is concerned with the A/ $\bar{A}$ -distinction, the second part (Chapter 5) examines successive-cyclic movement, and the third part (Chapter 6) looks at pronoun copying and the Copy Theory of Movement.

### 2.1 Chapter 2: Eliminating A/ $\bar{A}$ -positions

The first major topic of this dissertation is the A/ $\bar{A}$ -distinction. In Chapter 2, I develop a featural approach to the A/ $\bar{A}$ -distinction, in which all differences between A- and  $\bar{A}$ -movement derive from properties of the attracting feature. I argue against the view that the A/ $\bar{A}$ -distinction is about properties of syntactic *positions* and so for eliminating the notions of A-positions and  $\bar{A}$ -positions.

I start the chapter by showing that we can capture the locality differences between A- and  $\bar{A}$ -movement by means of Relativized Minimality, if we assume that what distinguishes features triggering  $\bar{A}$ -movement is that they are *optional* features of XPs. As a result, these features may be absent on intervening phrases, so that the Agree relation that triggers movement can skip over them. This difference also makes sense of the restriction to nominals evident in A-movement, if the ability to trigger pied-piping requires a variable merge site, as in Cable's (2007, 2010) approach to pied-piping, something that is arguably only possible with optional features.

I extend the featural approach to the difference between A- and  $\bar{A}$ -movement in their interaction with reconstruction for Principle C. In particular, I adopt Takahashi and Hulse's (2009) notion of Wholesale Late Merger, according to which NPs may undergo Late Merge in case positions. In this view, the diverging behavior of A- and  $\bar{A}$ -movement with regard to reconstruction for Principle C ultimately derives from the fact that the features involved in A-movement also independently play a role in case assignment.

Finally, I argue that Agree relations may have different interpretive effects. In particular, following Sauerland (1998) and Ruys (2000), I propose that Agree for  $\bar{A}$ -movement triggers abstraction over choice functions, while Agree for A-movement is accompanied by abstraction over individuals. As Sauerland and Ruys point, this provides an account of Weak Crossover. In addition, I point out that this idea provides an explanation for the difference between A- and  $\bar{A}$ -movement in their ability to license parasitic gaps. I show that the view that Agree relations may trigger different kinds of abstraction makes sense of Pytkänen's (2008) observation that A-movement can license depictives in the same configurations in which  $\bar{A}$ -movement licenses parasitic gaps. We will see that, even when A- and  $\bar{A}$ -movement target the same position, we find this difference, so that we cannot account for this in positional terms.

## 2.2 Chapter 3–4: Dinka clause structure & The A/ $\bar{A}$ -distinction in Dinka

In Chapters 3 and 4, I turn to a prediction that emerges from this featural approach to the A/ $\bar{A}$ -distinction. If the A/ $\bar{A}$ -distinction derives from properties of the Agree relation implicated in A- and  $\bar{A}$ -movement, and if, in addition to this, heads can carry multiple probing features, we expect languages in which movement can be driven both types of features at the same time. In Chapter 3, I first provide some necessary background on Dinka clause structure. In Chapter 4, I then show that movement in Dinka has exactly this profile. All instances of movement are accompanied by  $\varphi$ -agreement (and changes in case), as in the examples of local and long-distance topicalization and relativization in (7a–d).

### (7) *Movement in Dinka is accompanied by case and $\varphi$ -agreement:*

- a. **Miir** à-càa \_\_\_\_ t̩iŋ.  
giraffe 3s-PRF.1SG see.NF  
'A giraffe, I have seen.'
- b. **K̩òc-k̩è** áa-c̩i Bòl ké yòok [CP k̩è nhiàr \_\_\_\_ Áyèn].  
people-these 3P-PRF.OV Bol.GEN 3PL find.OUT.NF c love.SV Ayen  
'These people, Bol has found out love Ayen.'
- c. Yè **k̩òc-kò** [CP Op é-k̩è-c̩i Áyèn ké gàam gàlám]?  
be people-which PST-3P-PRF.OV Ayen.GEN 3PL give.NF pen  
'Which people had Ayen given a pen to?'
- d. Ye **k̩òc-kò** [CP Op é-k̩è-yá ké tàak [CP é-k̩è-c̩i Áyèn ké  
be people-which PST-3P-HAB.2SG 3PL think.NF PST-3P-PRF.OV Ayen.GEN 3PL  
gàam gàlám]]?  
give.NF pen  
'Which people did (s)he think that Ayen had given a pen to?'

In addition, I demonstrate that long-distance movement in Dinka patterns with A-movement in terms of its effect on binding: it does not trigger Weak Crossover or require reconstruction for Principle C. On the basis of this, I propose that this type of movement in Dinka is established by features associated with A- and  $\bar{A}$ -movement at the same time, adopting the notion of a *composite probe* from Coon and Bale (2014). If the properties of A- and  $\bar{A}$ -movement derive only from properties of the triggering features, we can capture the observation that movement in Dinka is associated with both the benefits of A-movement and those of  $\bar{A}$ -movement. In this way, the lack of an A- and  $\bar{A}$ -distinction in Dinka provides an independent argument for a featural approach.

## 2.3 Chapter 5: Intermediate movement in Dinka

In Chapter 5, I turn to the topic of successive-cyclic movement. A distinction is often drawn between intermediate movement steps of a successive-cyclic dependency and movement to the final landing site (e.g. Chomsky 1973, 1977). Much work on the syntax of long-distance movement

has suggested fundamental differences in the way these two kinds of phrasal movement are triggered (e.g. Heck and Müller 2000, 2003; Chomsky 2001, 2013, *a.o.*), primarily to capture the fact that intermediate movement often has few visible morphosyntactic repercussions. Dinka provides clear evidence for the idea that all long-distance movement involves successive-cyclic movement through the edge of the clause and the edge of the verb phrase (Chomsky 1986 et seq.). Crucially, the Dinka facts also show that intermediate movement has the same morphosyntax as terminal movement and is established in the same way, so via Merge and Agree. In (8a–b), for instance, we see that intermediate movement to the edge of an embedded CP is accompanied by  $\varphi$ -agreement.

(8) *Intermediate movement affects V2 and  $\varphi$ -agreement:*

- a. Yè kòc-kó [CP Op é-kè-yá ké tàak [CP è \_\_\_ é-kè-cíi  
 be **people.cs-which** PST-PL-HAB.2SG 3PL think.NF C PST-PL-PRE.OV  
 Áyèn ké gâam gâlám]]?  
 Ayen.GEN 3PL give.NF pen  
 ‘Which people did (s)he think that Ayen had given a pen to?’
- b. Wòk yíi Bòl ké luêeel [CP è \_\_\_ é-kè-léet Áyèn ké].  
 we HAB.OV Bol.GEN 3PL say.NF C PST-PL-insult.OV Ayen.GEN 3PL  
 ‘Us, Bol says Ayen was insulting.’

In addition, I will demonstrate that intermediate movement has the same consequences as the final movement step for embedded V2, voice, and case. The syntax of intermediate movement then cannot be radically distinct from movement to the final landing site. In particular, I show that the right analysis of Dinka requires that intermediate movement is established by the same mechanisms as movement to the landing site: Merge triggered by an Agree relationship with a probe (Chomsky 1995; McCloskey 2002; Abels 2012).

#### 2.4 Chapter 6: Pronoun copying

Chapter 6 examines the third and last major topic of this dissertation, the realization of copies left by phrasal movement. Many languages have a process of verb copying associated with movement of verbs to the left periphery. I will argue that the counterpart to this with movement of DPs is *pronoun copying*. Crosslinguistically, there are many movement constructions in which a pronoun appears to mark the position of a full DP copy, including in resumption, *wh*-copying, clitic doubling, and subject doubling (e.g. Zaenen et al. 1981; Koopman 1982, 1984; Felser 2004; Harizanov 2014). On the basis of this, I propose that DP copies obligatorily undergo partial spell-out as pronouns when multiple copy spell-out occurs, under the view that pronouns represent the functional layer of a DP (Postal 1969; Elbourne 2001, 2005). Evidence for this view comes from asymmetries and gaps that arise in pronoun copying. My main example of this is *ké*-copying in Dinka: plural DPs are doubled by a 3rd person plural pronoun at every *v*P edge on the path of movement (9a–b).

(9) **Plural pronoun copying at Dinka verb phrase:**

- a. **Kêek** áa-cíi Áyèn [<sub>vP</sub> **ké** tíiŋ].  
 3PL 3P-PREF.OV Ayen.GEN 3PL see.NF  
 ‘Them, Ayen has seen.’
- b. Yè **kôc-kó** [<sub>CP</sub> yíi Ból [<sub>vP</sub> **ké** luêeel [<sub>CP</sub> è cíi Áyèn [<sub>vP</sub> **ké**  
 be **people-which** be.OV Bol.GEN 3PL say.NF C PREF.OV Ayen.GEN 3PL  
 tíiŋ]]]]]?  
 see.NF  
 ‘Which people does Bol say Ayen has seen?’

I will show that *ké*-copying reflects the spell-out of a copy left by intermediate movement, so that this process provides evidence for successive-cyclic movement to the *vP* edge. One of the results of this is that for all types of movement, including terminal A- and  $\bar{A}$ -movement and intermediate movement, we can find cases where the copy in the landing site of movement is spelled out as a pronoun. This provides an additional argument for the idea that all types of phrasal movement involve the same mechanisms.

More specifically, I argue that pronoun copying provides evidence that all instances of phrasal movement involve full copies created by Merge, as in the Copy Theory of Movement (Chomsky 1995 et seq.), because partial spell-out requires that movement leaves copies with an articulated structure. I provide evidence for this view from asymmetries and gaps in *ké*-copying and pronoun copying constructions across languages. Pronoun copying in Dinka is restricted to plurals and always spells out as third person plural *ké(ek)*, even when the antecedent is a 1st or 2nd person pronoun. I show that similar asymmetries and gaps in distribution are found across different types of pronoun copying configurations and argue that they can all be traced to the effects of partial spell-out. In some cases, the structure left by deletion of NP in a DP copy does not leave a structure that can be spelled out as a pronoun, creating gaps. Asymmetries in pronoun copying (where a copied pronoun partially matches its antecedent) arise when partial spell-out deletes some of the  $\varphi$ -features of the DP copy. In Dinka *ké*-copying, for instance, I propose that deletion targets the part of a pronoun that encodes person, leaving behind a structure that is always third person. In this way, pronoun copying offers evidence for a uniform syntax of phrasal movement and for the Copy Theory of Movement, as well as the view that person and number are introduced in separate projections in the DP.



## CHAPTER TWO

### ELIMINATING A/ $\bar{A}$ -POSITIONS

---

All approaches to phrasal displacement recognize a distinction between A- and  $\bar{A}$ -dependencies. In this chapter, I argue that the two types of displacement are distinguished solely by the features that drive them, and not by the position they target (e.g. Chomsky 1981, 1995; Mahajan 1990; Déprez 1990; Miyagawa 2010). This approach eliminates the notion of A- and  $\bar{A}$ -positions and maintains a uniform view of phrasal movement, in which all movement is established by Agree and Merge. In this view, differences between movement types derive only from properties of the Agree relation.

#### 1 Introduction

It has long been acknowledged that there is a distinction between long-distance dependencies such as *wh*-movement and topicalization and more local dependencies such as passivization and raising (e.g. Postal 1971; Chomsky 1977, 1981). Postal referred to these movement types as A-movements and B-movements, respectively, but, in current work, this is often referred to as the A/ $\bar{A}$ -distinction, with dependencies like *wh*-movement, relativization, and topicalization called  $\bar{A}$ -movement instead. An overview of commonly recognized differences between these two kinds of movement, taken from a recent review by Richards (2014:167–169), is given in (1). I will refer to the characteristics of A-movement as *A-properties*, and those of  $\bar{A}$ -movement as  *$\bar{A}$ -properties*.

- |                                     |   |
|-------------------------------------|---|
| (1) <i>A-properties:</i>            | <i><math>\bar{A}</math>-properties:</i> |
| ‣ Local                             | ‣ Long-distance                         |
| ‣ Restricted to nominals            | ‣ Not restricted to nominals            |
| ‣ No reconstruction for Principle C | ‣ Reconstruction for Principle C        |
| ‣ No Weak Crossover                 | ‣ Weak Crossover                        |
| ‣ New antecedents for anaphors      | ‣ No new antecedents for anaphors       |
| ‣ No parasitic gap licensing        | ‣ Parasitic gap licensing               |

Given the contrasts listed in (1), a major question in syntactic theory is whether A-properties and  $\bar{A}$ -properties arise from slight variations in an essentially uniform syntax, or whether they provide evidence for a more radical distinction among displacement processes. One answer of the latter sort posits a fundamental difference in the level of representation at which these dependencies are formed. In approaches like HPSG and LFG, for example, A-movement is modeled as a lexical alternation, while  $\bar{A}$ -movement involves a syntactic mechanism of feature percolation.

In this dissertation, I argue for the former view, that all types of phrasal movement are syntactic and established by the same operation (e.g. Merge or Move  $\alpha$ ), as in Chomsky (1981) and much subsequent work. More specifically, I adopt the idea that all instances of movement involve the procedure in (2) (Chomsky 1995, 2000, 2001): an Agree relation between a head and a phrase selects an appropriate target, and is followed by an operation of (internal) Merge.

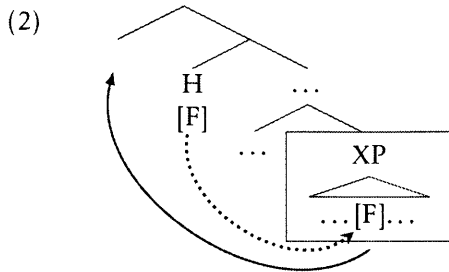

**Feature-driven Merge:**

When a head H is merged with a triggering feature F...

1. **Agree:** The trigger F finds the (closest) XP bearing the same feature F. (dotted line)
2. **Merge:** The trigger attracts XP. (solid line)

Internal to theories that view the A/ $\bar{A}$ -distinctions as products of a uniform syntax like (2), we can draw a distinction between two possible approaches.<sup>1</sup> One of the most common approaches to the A/ $\bar{A}$ -distinction is what I will refer to as the *positional approach*. In a positional approach, syntactic positions are classified into A-positions and  $\bar{A}$ -positions based on general properties of the head H in (2) that hosts the moved phrase. We can contrast the positional theory of the A/ $\bar{A}$ -distinction with what I call the *featural approach*. In a featural view, all differences between types of phrasal movement reflect properties only of the *attracting feature*, or the feature [F] in (2). These two approaches are summarized in (3).

(3) **Two approaches to the A/ $\bar{A}$ -distinction:**

1. **Positional approach:** A- and  $\bar{A}$ -properties derive from general properties of the head that hosts the moved phrase (the head H in 2).
2. **Featural approach:** A- and  $\bar{A}$ -properties derive from properties of the *attracting feature* (the feature [F] in 2).

In this chapter and the following two, I argue for the featural view of the A/ $\bar{A}$ -distinction. The task of this chapter is to show that a featural approach can make sense of the various A/ $\bar{A}$ -properties without a need for a separate notion of A- and  $\bar{A}$ -positions. In the following chapters, Chapter 3 and 4, I show that an important prediction of the featural approach is borne out in the Nilotic language Dinka. In particular, if the A/ $\bar{A}$ -distinction derives from the attracting feature, movement simultaneously driven by both types of features should exhibit properties of A-movement and of  $\bar{A}$ -movement at the same time. This characterizes phrasal movement in Dinka: all movement, whether local or long-distance, affects agreement, case, and binding in the same fashion. These facts then provide an independent argument for a featural view of the A/ $\bar{A}$ -distinction.

1. A third approach we might logically conceive of is one in which the A/ $\bar{A}$ -distinction reflects properties of the moving phrase, or the XP in (2). This is probably a non-starter, since the same XP can undergo A-movement and  $\bar{A}$ -movement in one derivation, but I will not explore this idea in detail here.



The positional approach has its origins in Chomsky's (1981) approach to the distinction between the two types of movement noted by Postal. Chomsky proposed that all instances of movement involve the same mechanism but are distinguished by what position is targeted. Chomsky therefore posited the existence of distinct sets of A- and  $\bar{A}$ -positions (1981:47), defining A-positions as those positions in which the head is capable of assigning a thematic role, or "potential thematic positions". At the time, Spec-IP was taken to be the thematic position for subjects in unergatives and transitives. The notion of "potential" thematic position thus rendered Spec-IP an A-position even when it is non-thematic, in passives, raising, and unaccusatives.<sup>2</sup>

However, since the adoption of the VP-internal subject hypothesis (e.g. Fukui and Speas 1986; Koopman and Sportiche 1991), it is widely assumed that the thematic position of subjects of unergatives and transitives is inside of the verb phrase. In this view, all thematic roles are assigned inside the verbal domain and Spec-IP never functions as a thematic position, removing the basis for the idea of a "potential" thematic position (though see Neeleman and Van der Koot 2010 for a recent version of this view). This problem also became a concern for objects in work on languages in which objects appear to require case-driven movement as well (e.g. Vanden Wyngaerd 1989; Mahajan 1990; Chomsky 1991, 1993). This gave rise to various attempts to find the grammatical property that unifies heads that host thematic positions and case positions, particularly in the literature on scrambling (e.g. Saito 1989; Webelhuth 1989; Déprez 1990; Mahajan 1990). One approach along these lines is found in Chomsky (1993) and Chomsky and Lasnik (1993), who propose the notion of *L-relatedness*. *L-relatedness* reflects whether a head carries an *L-feature*, defined as an lexical feature of the verb. In this view, heads like Tense and Agr are taken to host *L-features*, but not C (see also Roberts 1994 and Haegeman 1996). In recent work, this division has been tied to phases instead. Chomsky (2007, 2008) suggests that A- and  $\bar{A}$ -positions are defined by whether the head hosting the moved phrase is a phase head or not. Specifically, Chomsky proposes that all  $\bar{A}$ -movement is movement to the specifier of a phase head, such as C or *v*. A-movement, in contrast, is movement to a specifier of a non-phase head (T or V), driven by the need to value an (inherited) inflectional feature.<sup>3</sup> Another view of the A/ $\bar{A}$ -distinction based on the interaction of movement and phases is found in Miyagawa 2010.

What all of these approaches have in common is the claim that positions in a clause can be classified (perhaps exhaustively) into A-positions and  $\bar{A}$ -positions, and that there is a grammatical property of heads, independent of the feature [F] that initiates movement, that can be used to identify these positions.

---

2. Much of the work in accounting for the distribution of A/ $\bar{A}$ -properties was actually done by the idea that A- and  $\bar{A}$ -movement leave different kinds of traces. In particular, Chomsky proposed that A-movement leaves traces that act in essence like anaphors (i.e. they must be bound locally from an A-position), and  $\bar{A}$ -movement leaves traces that act like variables.

3. As pointed out and developed by Obata (2010) and Obata and Epstein (2011), this can be seen as a version of a featural view, since A- and  $\bar{A}$ -movement differ in the features that triggers movement. If we allow inflectional features that drive A-movement to stay on C in some languages, this approach ends up making some of the same predictions as the featural view I will defend, most prominently with regard to the Dinka data discussed in Chapter 4.

In this chapter, I argue against the central claim of the positional approach, that there is a need for a separate notion of A- and  $\bar{A}$ -positions, and develop the view that all differences between movement types derive only from properties of the *attracting feature*. In this view, no other properties of the head that hosts movement, such as its categorial features or ability to assign a thematic role, are relevant. Versions of this idea can be found in approaches that defined A-positions as positions in which case is assigned (e.g. Rizzi 1990; Müller 1995; see also Déprez 1990). The specific hypothesis that I will argue for is the idea that all variation resides in the operation of Agree. In this view, all movement is triggered by Agree and all differences between kinds of phrasal movement derive from the identity of the feature [F] that is the target of the Agree relation. I summarize this view in (4).

(4) ***Featural view of the A/ $\bar{A}$ -distinction:***

All differences between A- and  $\bar{A}$ -movement derive from the features involved in Agree.

In other words, I will claim that Agree relations may affect the syntax of movement in different ways, either because of syntactic constraints on Agree relations that may affect features differently or because of differences in the interpretive effects of Agree relations. The major advantage of this approach is that it allows for the notion of A-positions and  $\bar{A}$ -positions to be eliminated, so that all positions created by Merge are the same. Instead, the tree in (2) suffices to represent all movement.

The chapter is organized as follows. I develop the view in (4) by first showing how it can make sense of the locality differences between A- and  $\bar{A}$ -movement. In section 2, I propose that what distinguishes the features involved in A-movement, which I take to be  $\varphi$ -features in the general case, is that they are obligatory features of nominals, while the features that drive  $\bar{A}$ -movement are optional. This difference captures the locality profile of A- and  $\bar{A}$ -movement, assuming Rizzi's (1990 et seq.) Relativized Minimality. I then argue that Cable's (2007, 2010) approach to pied-piping can link the optionality of  $\bar{A}$ -features to their ability to trigger pied-piping, if both involve a variable merge site. In section 3, I show that another source of the A/ $\bar{A}$ -distinctions is that  $\varphi$ -probing interacts with other syntactic processes. I adopt the idea that the role of  $\varphi$ -agreement in case assignment is responsible for the distribution of reconstruction of Principle C, under Takahashi and Hulsey's (2009) Wholesale Late Merger account. In section 4, I propose that Agree relations may differ in their interpretive effects. Building on proposals by Sauerland (1998) and Ruys (2000), I suggest that differences in binding arise because  $\bar{A}$ -movement involves abstraction over choice functions, not individuals. This idea also accounts for the distribution of parasitic gaps if parasitic gaps reflect the creation of a conjoined predicate, as in Nissenbaum (2000). If A- and  $\bar{A}$ -movement involve distinct types of abstraction, then they create different predicates. This approach makes sense of Pytkänen's (2008) observation that depictives are licensed by intermediate A-movement in analogous configurations. A close examination of these patterns reveals that differences between A- and  $\bar{A}$ -movement persist even when they target specifiers of the same head, thus requiring an approach that cares only about the attracting feature and not about other features of the head.

In addition to this, I show in Chapters 3 and 4 that a featural approach makes a prediction about the A/ $\bar{A}$ -distinction that is borne out in the Nilotic language Dinka. In particular, if we can find movement types that are driven both by features usually involved in A-movement and features usually involved in  $\bar{A}$ -movement (for example, *Wh* and  $\varphi$ ), the resulting movements should be associated both with the properties of A-movement and those of  $\bar{A}$ -movement. I will show that is systematically true in Dinka, so that all phrasal movement displays a mix of A/ $\bar{A}$ -properties: movement can be long-distance, but, at the same time, is always visible for case assignment and binding. This system constitutes additional evidence that A- and  $\bar{A}$ -properties are not necessarily associated with different positions, but derive solely from the features involved in movement.

## 2 Two types of features

I will start this chapter by discussing what distinguishes the features involved in A-movement from those involved in  $\bar{A}$ -movement. I propose that the long-distance nature of  $\bar{A}$ -movement reflects the fact that the features driving it, like *Wh* and *Top(ic)*, are *optional*, so that they may be absent on phrases that could act as interveners. In contrast, the features that drive A-movement, like *person*, *number*, or *case*, are *obligatory* features, and so A-movement must be more bounded. In addition, I show that this difference makes sense of the restriction of A-movement to nominals. In Cable's (2007, 2010) approach to pied-piping, the ability to trigger pied-piping requires a variable merge site, something that is arguably only possible with an optional feature.

### 2.1 Locality

A prominent difference between A- and  $\bar{A}$ -movement is how they interact with locality. A key characteristic of  $\bar{A}$ -dependencies is their ability to in principle skip over an unbounded number of intervening nominals and intervening clauses, as in (5a), for example. In contrast, A-movements like passivization or raising are more restricted and usually cannot skip over such phrases (5b).<sup>4</sup>

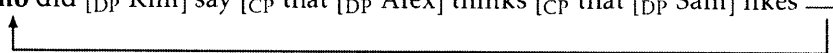
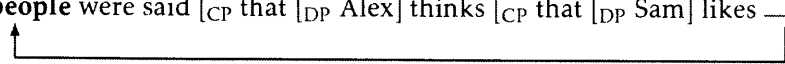
- (5) a. **Who** did [<sub>DP</sub> Kim] say [<sub>CP</sub> that [<sub>DP</sub> Alex] thinks [<sub>CP</sub> that [<sub>DP</sub> Sam] likes \_\_\_\_]]?  
  
 b. \***Those people** were said [<sub>CP</sub> that [<sub>DP</sub> Alex] thinks [<sub>CP</sub> that [<sub>DP</sub> Sam] likes \_\_\_\_]].  

In this section, I propose that this difference follows from the idea that all dependencies are subject to Relativized Minimality (Rizzi 1990), or, translated into probe-goal terms, the idea that Agree must target the closest suitable goal.

The notion of Relativized Minimality comes from Rizzi (1990), who argues that syntactic relations must always involve the closest eligible phrase. We can state Relativized Minimality roughly as in (6).

4. Though there is a rich literature on apparent exceptions to this, such as raising over experiencers or passivization over an intervening object (see McGinnis 1998, Anagnostopoulou 2003 and many others).

(6) **Relativized Minimality:**

A syntactic relation R must involve the closest XP capable of entering into R.  
(Rizzi 1990 et seq; see also Starke 2001)

Within a probe-goal framework, Relativized Minimality can be understood as a constraint on Agree, to the effect that Agree ignores XPs that do not carry an instance of the probing feature (Chomsky 2001). I call this *Agree with Closest* (7).

(7) **Agree with Closest:**

A probing feature F must Agree with the closest XP that bears F.

If all movement is triggered by Agree, then (7) will also act as a constraint on possible movement relations. As Rizzi points out, relativizing minimality constraints in this way provides an explanation of the long-distance nature of  $\bar{A}$ -movement. Consider, for example, an instance of *wh*-movement, which I take to be established by Agree for a feature *Wh*. *Wh*-features are optional features of phrases. Since (7) requires that a *Wh*-probe target the closest XP bearing a *Wh*-feature, a *Wh*-probe will skip DPs without *Wh* (8).

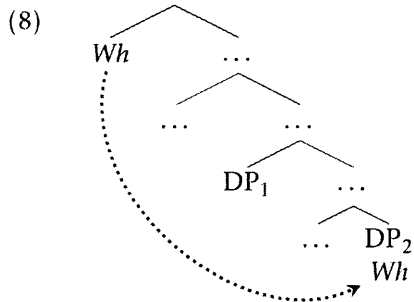

In accordance with the Relativized Minimality view, we see that *wh*-movement can no longer cross over an intervening noun phrase if it is also a *wh*-phrase (9), an observation that goes back to Kuno and Robinson (1972).<sup>5</sup>

(9) \***Who** did **who** say [<sub>CP</sub> that [<sub>DP</sub> Alex] thinks [<sub>CP</sub> that [<sub>DP</sub> Sam] likes \_\_\_]]?

In this view, the ability of *wh*-movement to cross intervening noun phrases is really a fact about the distribution of *Wh*, namely that DPs may lack a *Wh*-feature. I suggest that this is true of features that drive  $\bar{A}$ -movement, like *Wh*, *Rel*, or *Top*, more generally. To be precise, I propose that all features that trigger  $\bar{A}$ -movement are optional. This idea links the unbounded nature of  $\bar{A}$ -movement to independently observable properties of the distribution of the features that are involved. Because features driving  $\bar{A}$ -movement are optional, movement triggered by such a feature can be long-distance without violating minimality constraints on Agree.

5. Again, there is an extensive literature on apparent exceptions (e.g. Bolinger 1978, Kayne 1983, Pesetsky 1987).

A Relativized Minimality approach also allows us to make sense of the more bounded nature of A-movement. A-movement is commonly restricted to nominals. As a result, it is usually assumed that the features involved in A-movement are features that are an intrinsic part of nominal structure, like person, number, or case. Suppose that A-movement is driven by  $\varphi$ -features in the general case.  $\varphi$ -features are *obligatory* features of nominals, which must be merged within the extended nominal projection.<sup>6</sup> If this is correct, we can leverage the obligatory nature of  $\varphi$ -features to explain why A-movement has a more bounded character. For example, movement triggered by a  $\varphi$ -probe should never be able to skip over the closest DP, because  $\varphi$ -features are necessarily present on all DPs (10).

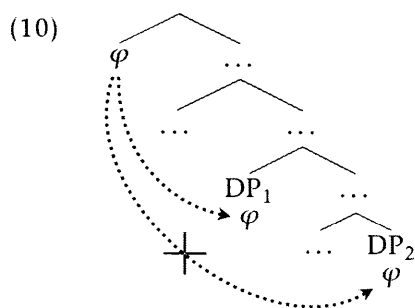

As a result, A-movement cannot skip an intervening noun phrase, just as *wh*-movement does not skip intervening *wh*-phrases. The apparent difference in locality between A- and  $\bar{A}$ -movement derives from constraints on the Agree relation involved. In both cases, phrasal movement targets the closest phrase matching the probing feature. The different locality profile that results can be traced back to the nature of the probing feature: features that trigger A-movement are obligatory, while features that establish  $\bar{A}$ -movement are only optionally present.

We can extend this view to the ability of  $\bar{A}$ -movement to cross intervening CP boundaries also. As alluded to above, A-movement cannot cross finite CPs in many languages, even in the absence of intervening DPs (11a), unlike  $\bar{A}$ -movement (11b).

(11) ***A-movement cannot cross finite CP in English:***

- a. \*She seems [<sub>CP</sub> \_\_\_ is certain to be smart].
- b. Who does it seem [<sub>CP</sub> \_\_\_ is certain to be smart]?

Following Rackowski and Richards (2005) and Halpert (2012, 2015), I propose that the contrast in (11a–b) is also due to Relativized Minimality. In particular, Rackowski and Richards and Halpert argue that the ungrammaticality of (11a) is an instance of the A-over-A Principle. In other words, they posit that closeness for the purposes of Relativized Minimality or Agree with Closest is calculated not just on c-command but also on *domination*. If this is correct, the CP in (11a–b) is a closer goal for Agree relations triggered by a higher head than any DP contained within it.

6. Though it is worth noting that there might be ways of merging a structurally reduced NP that lacks these features, as in pseudo-noun incorporation (e.g. Massam 2001; Levin 2015). Such processes are generally restricted across languages, but should in principle be able to allow A-movement to skip over an intervening nominal.

We can then understand the contrast in (11a–b), if CPs carry  $\varphi$ -features also, so that they must always be eligible goals for  $\varphi$ -probes. In contrast, *Wh*-features are optional on CPs just as they are on DPs, allowing *wh*-movement to safely cross a CP boundary. In accordance with this, *wh*-movement is blocked when the CP is interrogative (12).

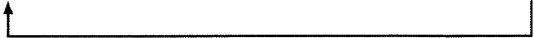
- (12) \*Who did Sam wonder [CP whether Kim likes \_\_\_]?  

See Halpert (2012, 2015) for a detailed proposal along these lines, with a particular focus on the distribution of so-called “hyperraising” constructions, or raising out of a finite CP (e.g. Harford Perez 1985; Ura 1994; Rodrigues 2004; Halpert 2012).<sup>7</sup>

If this kind of approach is on the right track, then all differences in locality can be attributed to restrictions on the Agree relation involved in A- and  $\bar{A}$ -movement. Note that the idea that A- and  $\bar{A}$ -movement are distinguished by the position they target does not obviously yield this result. In the next section, I show how this view can be extended to deal with pied-piping.

## 2.2 Categorical restrictions and pied-piping

Another prominent difference between A- and  $\bar{A}$ -movement is that A-movement is commonly restricted to nominals, as illustrated in (13a–b).<sup>8</sup>

- (13) **A-movement restricted to nominals:**
- a. \*<sub>[PP To Kim]</sub> seemed \_\_\_ <sub>[CP that it was raining]</sub>.
  - b. <sub>[PP To whom]</sub> did it seem \_\_\_ <sub>[CP that it was raining]</sub>?
  - c. <sub>[AdvP How clearly]</sub> did it seem \_\_\_ <sub>[CP that it was raining]</sub>?

This difference manifests itself in two, arguably related, ways. A-movement generally cannot pied-pipe other elements, where  $\bar{A}$ -movement can pied-pipe a range of items, such as the preposition in (13b). In addition to this, the phrase that triggers  $\bar{A}$ -movement need not be nominal in nature, such as the adverbial phrase in (13c), whereas A-movement is for the most part categorically restricted to DPs (and possibly CPs).

One half of this picture, that the phrase that triggers A-movement has to contain a nominal, can already be derived from the notion that A-movements are triggered by features intrinsic to nominals (and possibly CPs). If the relevant features only come from nominals, then such instances of phrasal movement can apply only to phrases with a nominal somewhere inside of them. That adverbs, adjectives, and PPs do not participate in A-movement, in this view, is because they are not merged with nominal features like  $\varphi$ .

7. Halpert argues that Multiple Agree enables hyperraising in Zulu, following Rackowski and Richards (2005). Others have suggested that hyperraising is possible when a CP is structurally reduced (e.g. Rodrigues 2004). Both proposals makes sense under a Relativized Minimality approach, if a reduced CP means an absence of  $\varphi$ -features. See also fn. 6.

8. A possible exception to this, though, is Locative Inversion, if at least some types of Locative Inversion involve movement of the PP to Spec-TP (e.g. Culicover and Levine 2001).

But how does this view extend to the difference in pied-piping? I will pursue the idea that the difference evident in (13a–b) reflects the same difference in the distribution of features that is responsible for the locality difference between A- and  $\bar{A}$ -movement. As above, I suggest that the factor that distinguishes A-movement from other movements is that it is driven by obligatory features of nominals, such as  $\varphi$ -features. In contrast, dependencies like *wh*-movement and relativization are triggered by optional properties of lexical items, such as *Wh* or Top(ic). I propose that it is the optional nature of features like *Wh* that enables pied-piping, by allowing for these features to be merged in multiple places.

To be precise, I adopt the approach to pied-piping in Cable (2007, 2010). Cable argues that pied-piping behavior reflects the fact that  $\bar{A}$ -movements are actually driven by heads with a variable merge site, so that they may attach at various points in the tree. For *wh*-movement, Cable posits a Q particle that enters into a semantic relation with the *wh*-phrase,<sup>9</sup> but may be merged in several places. The structure of the resulting QP is represented in (14).

(14) **QP in Cable (2007, 2010):**

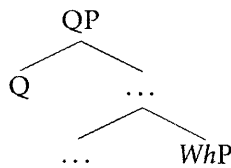

Cable's proposal is that this QP is actually the phrase that is targeted for movement, and not the *wh*-phrase. If Q is covert, any material merged in between Q and *Wh* will appear to undergo pied-piping. In this view then, the existence of pied-piping is really illusory.

In a QP approach, the difference between an example like (15a) and (15b) reflects the position of Q. If Q merges between the preposition and the DP, the preposition is stranded (15a). But, if Q merges above P, the preposition is contained within the QP undergoing movement, and so will appear to be pied-piped (15b).

(15) **Pied-piping reflects variable merge of Q:**

- a. [QP Q [DP which person]] did you give the ball [PP to \_\_\_]?
- b. [QP Q [PP to which person]] did you give the ball \_\_\_?

If this approach generalizes to other features involved in  $\bar{A}$ -movement, we can draw a link between the idea that  $\bar{A}$ -features are optional features and the pied-piping effect, in the following way. For pied-piping to happen in Cable's approach, the relevant head must be able to merge with a variety of categories in a variety of syntactic positions. If features implicated in A-movement are features that obligatory merge within a DP structure, it follows that A-movement should not display pied-piping: nominal features, such as  $\varphi$  or case, do not have a variable merge site, but are

9. As well as an Agree relation in some languages. This is responsible for the difference between languages like English, in which there are locality restrictions on pied-piping, and languages like Tlingit, in which there are not.

selected for and merged in specific positions in the extended nominal projection. I suggest that a feature can only trigger the pied-piping effect if it is not required to merge in any particular place but is able to merge with a variety of categories. As a consequence, any feature with a variable merge site must necessarily be an optional feature, exactly like Cable's Q particle. We can then link the unbounded nature of  $\bar{A}$ -dependencies to its ability to trigger pied-piping: both reflect optionality in whether the triggering feature is merged and where.<sup>10</sup>

We have seen now how some of the fundamental aspects of the A/ $\bar{A}$ -distinction, what phrases are targeted, the presence or absence of pied-piping, and differences in locality, can be made to follow from the idea that there are at least two classes of features that trigger movement, obligatory features of nominals, and optional features with a variable merge site. In addition, we saw that none of these differences obviously engage or require a separate notion of A- and  $\bar{A}$ -positions. In the remainder of this chapter, I show that the featural view outlined above can deal with the distribution of other A- and  $\bar{A}$ -properties also, without needing to appeal to the existence of A- and  $\bar{A}$ -positions.

### 3 Reconstruction for Principle C and case assignment

The previous section showed that differences in locality and pied-piping derive from distributional facts about the features that drive A- and  $\bar{A}$ -movement, and their interaction with Agree. In this section, I propose that another source of differences between A- and  $\bar{A}$ -movement is the fact that  $\varphi$ -agreement plays a role in other syntactic processes. In particular,  $\varphi$ -agreement is often held to play an important role in case assignment (e.g. George and Kornfilt 1981; Chomsky 2001). Following Takahashi and Hulsey (2009), I propose that the role of  $\varphi$ -probing in case licensing is responsible for differences in reconstruction for Principle C because it restricts the application of Wholesale Late Merger (WLM).

It is well-known that A- and  $\bar{A}$ -movement differ with regard to reconstruction for Principle C (e.g. Van Riemsdijk and Williams 1981; Freidin 1986; Lebeaux 1988; Chomsky 1995).  $\bar{A}$ -movement must reconstruct for Principle C (16a), but this is not required with A-movement (16b).

- (16) *Only  $\bar{A}$ -movement must reconstruct for Principle C:*
- a. \*Which side of Alex<sub>i</sub> does he<sub>i</sub> dislike \_\_\_ ?
  - b. That side of Alex<sub>i</sub> seemed to him<sub>i</sub> [\_\_\_ to be well-hidden].

I adopt the account of the contrast in (16a–b) developed by Takahashi and Hulsey (2009). Takahashi and Hulsey propose that NPs may undergo Late Merge, an option they call Wholesale Late Merger

10. It is important for this approach that Q and heads like it extend the projection they attach to. For example, if Q merges with a DP, it must count as part of the extended projection of the nominal. This is necessary to ensure that Q is not stranded if the DP undergoes A-movement before it is targeted for *wli*-movement. The assumption that the entire extended projection of a goal XP moves if the feature targeted is not on the highest head is independently necessary if features like person and number are introduced in separate functional projections (see Chapter 6), and needs to be distinguished from the pied-piping effect.



(WLM). In principle, this is available for any movement chain. However, they suggest that, when WLM applies in  $\bar{A}$ -movement, the derivation crashes, because the NP part of a DP always carries an unvalued Case feature that must be checked. In this view, the difference between A- and  $\bar{A}$ -movement derives from an independent property of the features involved, the idea that  $\varphi$ -agreement mediates case licensing (e.g. George and Kornfilt 1981; Chomsky 2000, 2001).

The operation of Wholesale Late Merger is a version of Late Merge, an operation proposed by Lebeaux (1988, 1998). Lebeaux suggests that some syntactic material can be merged countercyclically, based on the observation that some Principle C effects that would be observed in the base position of a moved phrase are absent if the offending proper name is contained in an adjunct to the moving element, as in (17a–b), but not if it is present in a complement (17c–d).

(17) **Absence of Principle C effects in adjuncts:**

- a. Which argument [that Kim<sub>i</sub> made] did she<sub>i</sub> believe \_\_\_?
- b. Which person [next to Kim<sub>i</sub>] does she<sub>i</sub> dislike \_\_\_?
- c. \*Which argument [that Kim<sub>i</sub> is a genius] did she<sub>i</sub> believe \_\_\_?
- d. \*Which side [of Kim<sub>i</sub>] does she<sub>i</sub> dislike \_\_\_?

To explain such contrasts, Lebeaux proposes that adjuncts may be merged to a phrase after *wh*-movement has taken place, countercyclically. As a result, in an example like (18a), *wh*-movement can precede merge of the adjunct (18b), allowing the adjunct to attach inside the copy left by movement only, as schematized in (18c).

(18) **Late Merge of adjunct:**

- a. Which argument [that Kim<sub>i</sub> made] did she<sub>i</sub> believe \_\_\_?

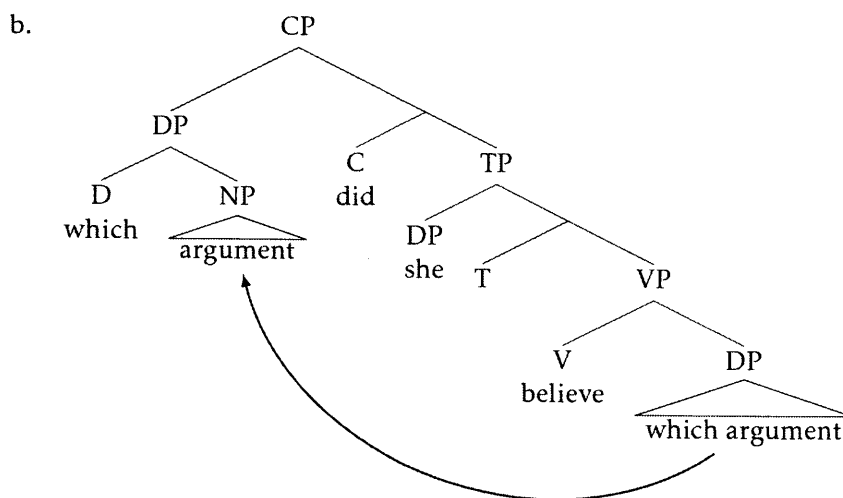

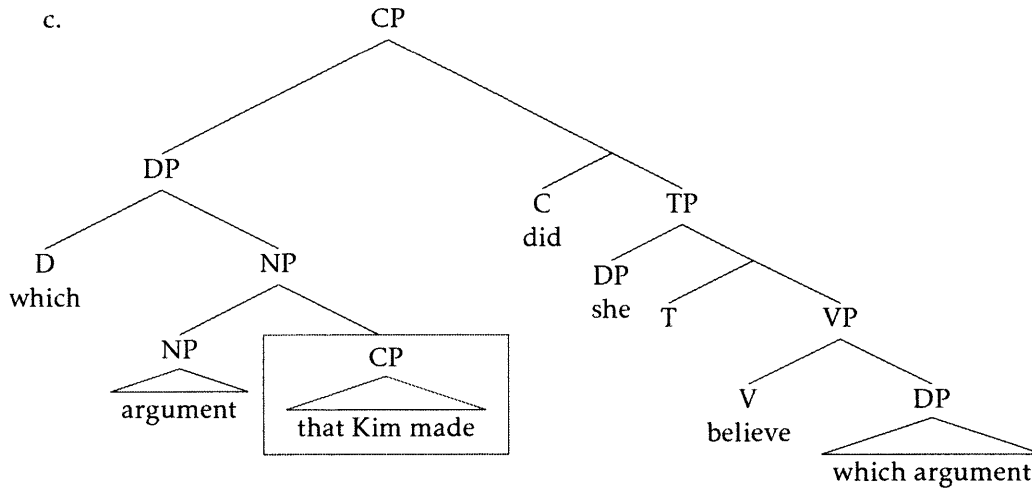

This operation is *Late Merge*. It ensures that material inside the adjunct need not matter for Principle C reconstruction, because this material may simply be absent in lower copies. In (18c), for instance, the proper name *Kim* is not present in the lower DP copy, and is never c-commanded by the pronoun *she*. Lebeaux accounts for the difference between adjuncts and complements by positing that Late Merge is not available for complements because these are selected for (and so must be merged early).

One problem for a Late Merge view is that it does not explain the absence of reconstruction for Principle C with A-movement, which does affect complements. To extend Lebeaux's account to A-movement, Takahashi (2006) and Takahashi and Hulsey (2009) propose that, instead of being restricted to adjuncts, there is nothing wrong in principle with Late Merge of complements, but that Late Merge is constrained instead by the condition that the resulting structure be interpretable at LF, following Fox (2002) and Bhatt and Pancheva (2004, 2007). This has the same consequences as a selection-based account for adjunct and complement CPs, but when combined with Fox's (1999) Trace Conversion approach to the semantics of movement chains, the idea that only interpretability at LF matters rules in Late Merge of an NP complement to a D head.

To see how Late Merge of a NP can still create an interpretable structure at LF, it is important to introduce the mechanism of Trace Conversion. Trace Conversion allows for the interpretation of movement chains under the Copy Theory of Movement, by converting the lower copy of a movement chain into a definite description bound by the higher copy. Trace Conversion is the combination of two operations: Variable Insertion and Determiner Replacement (19).

(19) **Trace Conversion:**

Variable Insertion: (Det) Pred  $\rightarrow$  (Det) [Pred  $\lambda y(y=x)$ ]

Determiner Replacement: (Det) [Pred  $\lambda y(y=x)$   $\rightarrow$  the [Pred  $\lambda y(y=x)$ ]

(Fox 2002:67)

Determiner Replacement converts the lower copy into a definite description, while Variable Insertion adds a  $\langle e,t \rangle$  predicate to be bound by the higher copy. This predicate combines with the NP restrictor by means of Predicate Modification to arrive at an interpretable LF. Takahashi and Hulseby point out that Trace Conversion has one important consequence for Late Merge under the LF interpretability view. If the NP restrictor of a DP copy is not merged, Variable Insertion will ensure that the resulting copy is nonetheless interpretable, because it supplies a suitable restrictor. The  $\langle e,t \rangle$  predicate inserted by Determiner Replacement can compose with the definite determiner in place of the NP. Takahashi and Hulseby call this option of applying Late Merge to the NP restrictor of a D head *Wholesale Late Merger*, or WLM. Wholesale Late Merger derives the absence of reconstruction for Principle C in A-movement chains because it allows for an NP to be merged only in a higher copy.

To see how this works, consider an A-movement example like (20a). In the lower copy, the NP restrictor need not be merged, because it will be rendered interpretable at LF by Variable Insertion. As a result, the DP may undergo A-movement without the NP, as in (20b).

(20) *Derivation of A-movement with WLM:*

a. That side of Alex<sub>i</sub> seemed to him<sub>i</sub> [\_\_\_ to be well-hidden].

b.

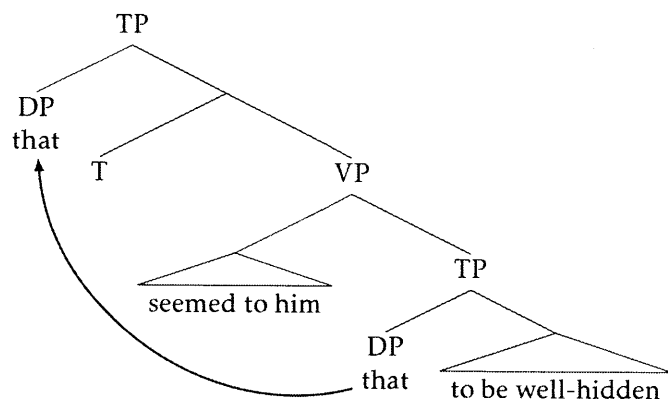

Wholesale Late Merge subsequently applies in the higher copy (21c). Trace Conversion converts the lower D to *the* and inserts an  $\langle e,t \rangle$  predicate, by the application of Variable Insertion. This renders the lower copy interpretable, because this predicate can compose with the inserted definite determiner. A Principle C effect is absent here for the same reason it is absent in (19): the offending material is not present in the lower copy. The pronoun *him* never c-commands the proper name *Alex* and so does not trigger a Principle C effect.

(21) *Trace Conversion in WLM chain:*

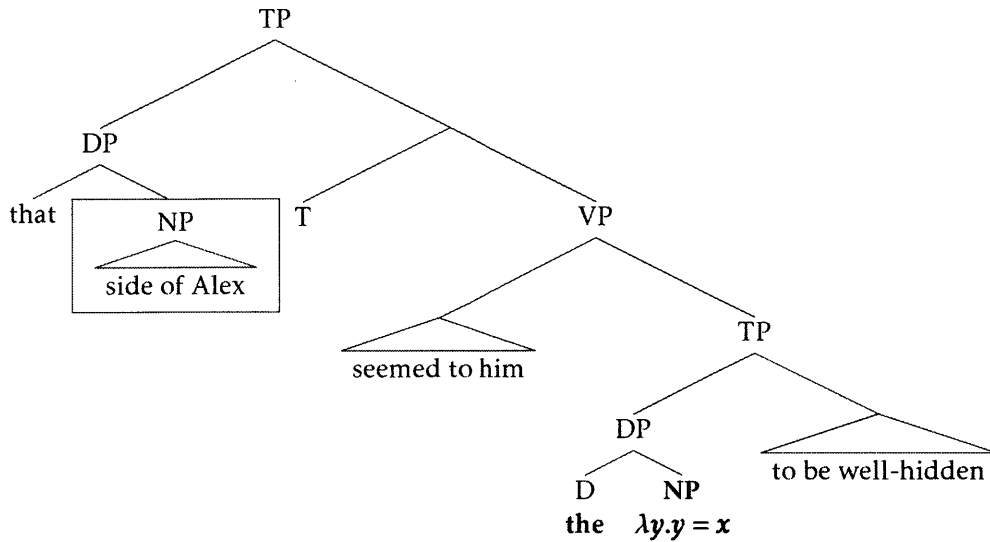

Within this model, a new explanation is needed for why complements cannot undergo Wholesale Late Merger in  $\bar{A}$ -movement. Takahashi and Hulsey (2009) suggest that this is the role of the Case Filter. Specifically, they propose that NPs carry an unvalued Case feature that must be checked, so that the NP has to be present before case assignment takes place. This rules out Wholesale Late Merger in  $\bar{A}$ -chains like (22a).

(22) *Derivation of  $\bar{A}$ -movement with WLM:*

- a. \*Which side of Alex<sub>i</sub> does he<sub>i</sub> dislike \_\_\_ ?
- b.

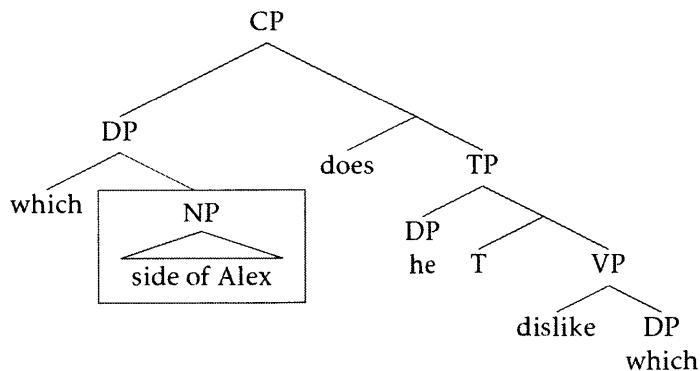

In (22b), the NP *side of Alex* cannot undergo WLM in Spec-CP, because it cannot be assigned case in this position. Its Case feature would then not be checked at any point in the derivation. As a result, the NP has to be merged before movement, in a lower copy. This has the effect that the NP has to

be c-commanded by the pronoun *he*, leading to a Principle C effect. In A-chains, this problem does not arise, because the Case feature may be valued in a higher copy.<sup>11</sup>

As Takahashi and Hulsey (2009) observe, one of the advantages of this account is that explains the distribution of reconstruction for Principle C without stipulating any properties specific to A- or  $\bar{A}$ -movement. The difference between the two falls out from how they interact with case, something which is motivated on independent grounds (though it requires a stipulation about where Case features are merged). As a result, this type of approach fits well within the featural approach to the A/ $\bar{A}$ -distinction that I am defending here, because the difference between A- and  $\bar{A}$ -movement ultimately derives from a property of the Agree relation involved in A-movement. Specifically, A-movement allows Wholesale Late Merger because  $\varphi$ -probing is also responsible for case assignment (e.g. George and Kornfilt 1981; Chomsky 2001).

#### 4 Weak Crossover, parasitic gaps, and the interpretation of chains<sup>12</sup>

One area in which the notion of distinct A- and  $\bar{A}$ -positions has often been invoked is in the study of binding effects. In this section, I turn to the interaction with A- and  $\bar{A}$ -movement with variable binding and anaphor binding, as well as the distribution of parasitic gaps. I argue that these effects have the same source and that all of these differences are due to interpretive effects associated with the Agree relation, and not because of the existence of A- and  $\bar{A}$ -positions. In particular, I propose that the Agree relations involved in A- and  $\bar{A}$ -movement differ in the type of abstraction they trigger. Following Sauerland (1998) and Ruys (2000), I adopt the idea that quantifiers quantify over choice functions, and that  $\bar{A}$ -movement always involves abstraction over choice functions. In contrast, I propose that A-movement always involves abstraction over individuals. As proposed by Sauerland (1998) and Ruys (2000), this provides an account of Weak Crossover: if pronouns denote variable over individuals, they cannot be bound by abstraction over choice functions. Following Ruys (2004), I suggest that the Weakest Crossover effects noted by Lasnik and Stowell (1991) are the result of coreference. This view also makes sense of the difference between A- and  $\bar{A}$ -movement in their ability to bind anaphors, if Condition A anaphors must be locally bound.

Support for this approach to crossover effects comes from the fact that it provides an account of the inability of A-movement to license parasitic gaps. If parasitic gaps reflect the formation of a conjoined predicate, as in Nissenbaum's (2000) approach, both gaps must be formed by the same type of abstraction. I show that this makes sense of Pylkkänen's observation that depictives are formed in the same way as parasitic gaps, but are licensed only by A-movement. This follows from the idea that A- and  $\bar{A}$ -movement form different types of predicates, with only A-movement involving abstraction over individuals.

---

11. Specifically, Takahashi and Hulsey propose that, in a raising derivation, the NP is merged in the higher Spec-*v*P, below the  $\varphi$ -probe on T, but above the experiencer. Another option would be to allow for a probe to access its specifier, so that the NP can be merged in the highest copy left by A-movement, Spec-TP.

12. My thanks to Aron Hirsch and Roger Schwarzschild for valuable discussion of this section.

#### 4.1 Weak Crossover

Another A/ $\bar{A}$ -property for which properties of A- and  $\bar{A}$ -positions have often been invoked is the distribution of Weak Crossover. It is well-known that A-movement of a quantified phrase differs from  $\bar{A}$ -movement with regard to whether a Weak Crossover effect is triggered (e.g. Postal 1971; Wasow 1972; Lasnik and Stowell 1991; Postal 1993) (23a–b).

(23)  *$\bar{A}$ -movement does not obviate WCO:*

- a. \*Her<sub>i</sub> friend saw every girl<sub>i</sub>.
- b. \*Who<sub>i</sub> did her<sub>i</sub> friend see \_\_\_?
- c. Every girl<sub>i</sub> seemed to her<sub>i</sub> friend [\_\_\_ to be the smartest].

I will pursue the idea that it is something about the semantics of quantificational  $\bar{A}$ -movement that gives rise to Weak Crossover (e.g. Lasnik and Stowell 1991; Safir 1996; Sauerland 1998; Ruys 2000). Specifically, I adopt a proposal by Sauerland (1998, 2004) and Ruys (2000), who both trace the Weak Crossover effect to the idea that quantifiers quantify over choice functions and not over individuals. I will claim that Agree with a movement-driving feature *Wh* is interpreted at LF as abstraction over choice functions, when the same configuration with  $\varphi$ -features gives rise to abstraction over individuals. In this view, the Weak Crossover effect is caused by the interpretation given to the Agree relations involved.

I will start by outlining the approach to Weak Crossover in Sauerland (1998) and Ruys (2000). To understand how it works, we first have to discuss how it treats *wh*-words. Both Sauerland (1998) and Ruys (2000) use as a point of departure Reinhart's (1992, 1998) treatment of in situ *wh*-phrases as wide scope indefinites. In Reinhart's framework, the wide scope of in situ *wh*-words is related to the ability of indefinites to take exceptional wide scope. To be precise, an in situ *wh*-word is taken to denote a choice function variable, which is bound by means of an operation of existential closure at the scopal position, analogous to Heim's (1982) treatment of wide scope indefinites. A syntactic configuration like (24a), with an in situ *wh*-word, then has an LF like (24b).

(24) *In situ wh-word in Reinhart (1992):*

- a. C<sub>Q</sub> ... which book ...
- b.  $\lambda p. \exists f(p = \lambda w \dots f(\text{book}) \dots \text{in } w)$

Ruys and Sauerland generalize this semantics to instances of *wh*-movement also. They propose that *wh*-words that undergo movement should be viewed as existential quantifiers over choice functions. The LF of a question like (25a) is then something like (25b), established by movement of the *wh*-word *which* (25c), acting as an existential quantifier.

(25) *Semantics of wh-movement in Sauerland (1998, 2004) and Ruys (2000):*

- a. Which book did you read?
- b.  $\lambda p. \exists f(p = \lambda w. \text{you read } f(\text{book}) \text{ in } w)$

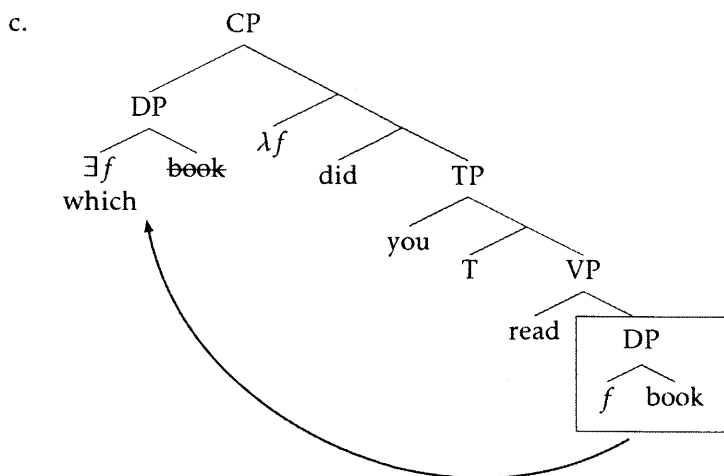

In *wh*-in situ configurations, this LF can be achieved by the operation of existential closure. In order for *wh*-movement to be associated with the same LF as *wh*-in situ, a number of operations have to apply, however. Distributed deletion at LF deletes the NP complement of *which* in the higher copy.<sup>13</sup> In addition to this, the occurrence of *which* in the lower copy is converted a choice function variable, abstracted over by *wh*-movement. I propose that this alteration to the lower copy is achieved by an operation I call Quantificational Copy Conversion (in analogy with Fox's (2002) Trace Conversion). It consists of an operation of Quantifier Replacement, which inserts a choice function variable in the place of the occurrence of the quantifier (26).

- (26) **Quantificational Copy Conversion:**  
 Quantifier Replacement: Quant Pred  $\rightarrow$  *f* Pred

Quantificational Copy Conversion plus scattered deletion allows for an LF for *wh*-movement in which *wh*-words quantify over choice functions.

As Ruys and Sauerland both point out, the advantage of a semantics like this is that it derives the presence of Weak Crossover with *wh*-movement. If *wh*-movement triggers abstraction over choice functions and pronouns denote variables over individuals, then *wh*-movement does not provide a way of binding the pronoun to the *wh*-phrase: it simply involves abstraction of the wrong type. I suggest that this is the source of the Weak Crossover effect. Following Sauerland and Ruys, I take non-*wh*-quantifiers to quantify over choice functions also, so that this problem arises in all Weak Crossover configurations. In this approach, all movement structures created by  $\bar{A}$ -movement must be interpreted by abstraction over choice functions. In other words, I suggest that the interpretation of  $\bar{A}$ -movement involves a rule along the lines of (27).

13. I take deletion at LF to be possible up to interpretability, at long as at least one occurrence of each head with lexical content is interpreted. Compare Landau's (2006) principle of P-Recoverability, discussed in Chapter 6.

(27) **Interpretation rule for  $\bar{A}$ -chains:**

In a movement structure formed by Agree for an  $\bar{A}$ -feature, adjoin a node  $\lambda f$  to the probing head.

The use of the term  $\bar{A}$ -feature assumes that there is a family of information-structural features that includes *Wh*, *Top*, *Rel*, and others, arranged in a hierarchy (see Rizzi 1990, Abels 2012a, and Chapters 4 and 5 for more detail). Given this, in movement configurations created by such features, the constraint in (27) forces the application of Quantificational Copy Conversion as well as deletion of the NP restrictor in all  $\bar{A}$ -movement constructions, in order to allow the structure to compose. It lies beyond the scope of this chapter to delve into the issue of how to apply a choice function analysis to all quantifiers, but for extensive discussion of the issues that arise and some possible solutions, see Sauerland (1998:ch. 5, 2004) and also Abels and Martí (2010), who argue for a choice function analysis of quantifiers based on split scope readings across intensional verbs.

As noted above, (27) ensures that each step of  $\bar{A}$ -movement is accompanied by abstraction over choice functions. In cases of successive-cyclic movement, each movement step will involve abstraction over choice functions. This is forced by (27), on the assumption that every intermediate movement step is also triggered by an Agree relation, as I argue in Chapter 5. If we posit an intermediate movement step to Spec-*vP* in an example like *which book did you read?*, for instance, we would have a derivation such as (28).

(28) **Interpretation of intermediate  $\bar{A}$ -movement:**

a. Which book did you read?

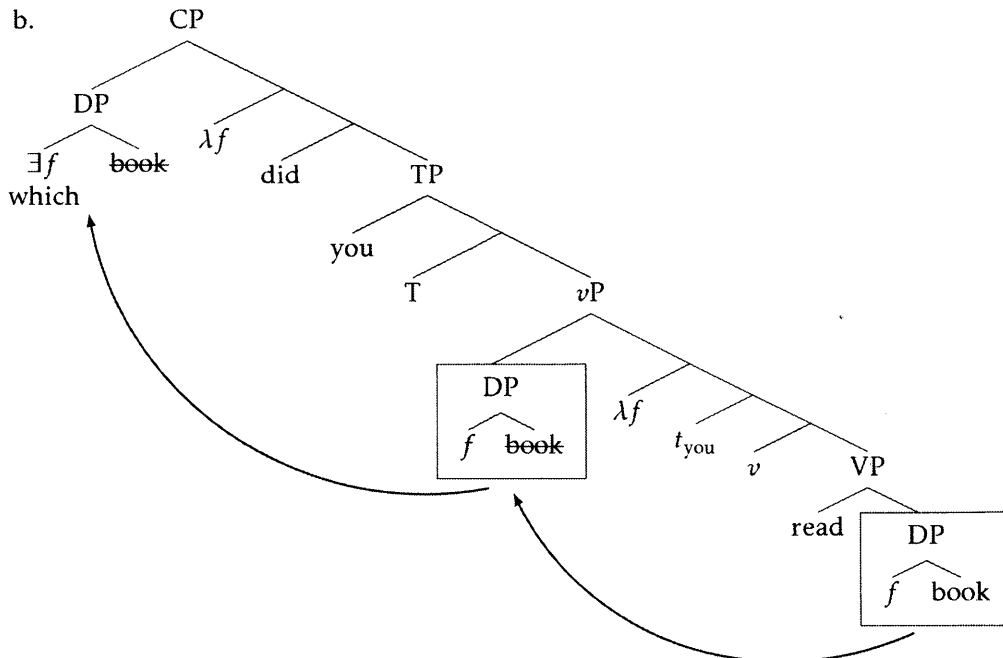



In this derivation, both movements trigger abstraction over choice functions, as a result of the Agree relation involved. Quantificational Copy Conversion applies to both lower copies and distributed deletion deletes the NP restrictor in all but the lowest copy. As a result, we end up with the same LF as we did without intermediate movement, namely (25b). Both movement steps involve abstraction over choice functions and so do not allow for novel binding relations to be established.

In contrast to  $\bar{A}$ -movement, I propose that all A-movement involves abstraction over individuals. This means that there has to be an interpretive rule for A-movement along the lines of (29), the counterpart to (27).

(29) ***Interpretation rule for A-chains:***

In a movement structure formed by Agree for  $\varphi$ -features, adjoin a node  $\lambda x$  to the probing head.

As in the discussion of reconstruction for Principle C, I assume that copies can be converted to definite descriptions using Trace Conversion. Trace Conversion is necessary to render interpretable movement that triggers abstraction over individuals.

(30) ***Trace Conversion:***

Variable Insertion: (Det) Pred  $\rightarrow$  (Det) [Pred  $\lambda y(y=x)$ ]

Determiner Replacement: (Det) [Pred  $\lambda y(y=x)$   $\rightarrow$  the [Pred  $\lambda y(y=x)$ ]

(Fox 2002:67)

This approach provides a way of viewing the ability of A-movement to license novel binding relations. To see how this works, consider the derivation of an example like (31a), given in (31b).

(31) ***A-movement followed by  $\bar{A}$ -movement:***

a. Which girl<sub>i</sub> seemed to her<sub>i</sub> friend [\_\_\_ to be smart]?

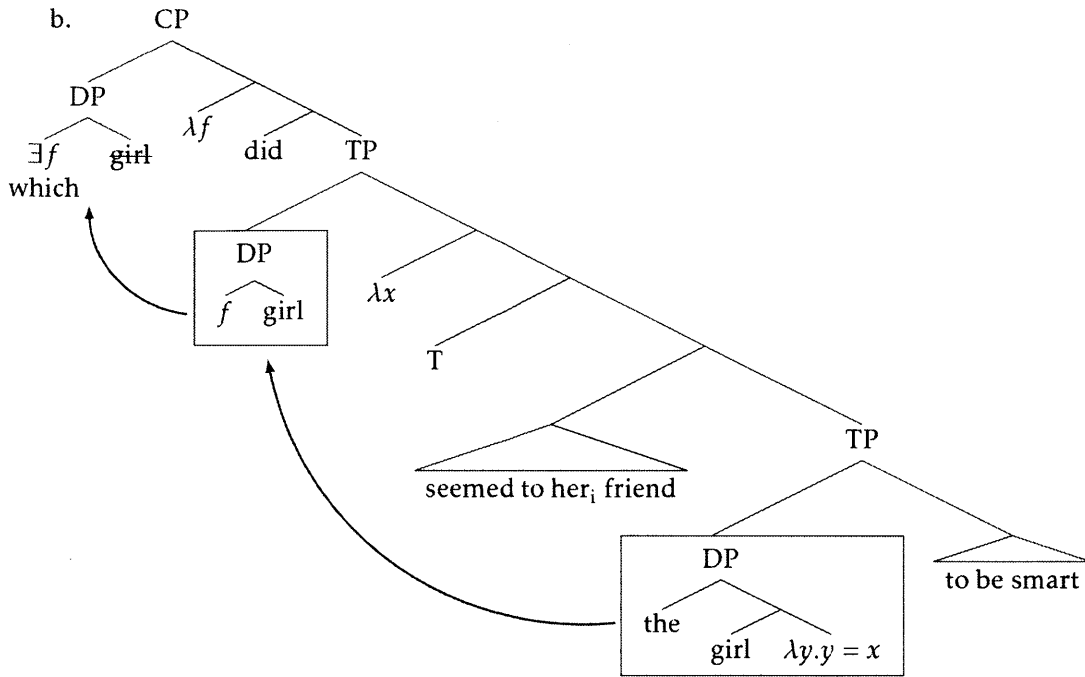

In this derivation, the first movement step to Spec-TP requires abstraction over individuals, because it is driven by  $\varphi$ -features on T. Trace Conversion applies to the lower copy. Determiner Replacement converts the occurrence of *which* in the lower copy to a definite determiner and Variable Insertion inserts an  $\langle e, t \rangle$  in the lower copy that introduces the individual variable to be bound by  $\lambda$ -abstraction. Because this movement involves abstraction over individuals, pronouns above the lowest copy can be bound to the copy residing in Spec-TP. *Wh*-movement to Spec-CP is interpreted using abstraction over choice functions. Quantificational Copy Conversion applies to the copy in Spec-TP. Because this converts the copy in Spec-TP into a phrase of type  $e$ , the resulting copy can still saturate the open predicate created by abstraction over individuals. Deletion of the NP restrictor in the highest copy then allows for *which* to take scope, deriving the correct LF.

In this proposal, the Weak Crossover difference between A- and  $\bar{A}$ -movement reflects the fact that they create different predicates. It is important then that all  $\bar{A}$ -movement involves abstraction over choice functions, including movement of referential DPs, as in topicalization examples like (32a–b).

(32) **Topicalization of referential DP:**

- a. This book, Alex never read \_\_\_\_.
- b. Sam, Alex likes \_\_\_\_.

I propose that such cases still involve abstraction over choice functions, but that the determiner ends up semantically reconstructing. Assuming that all referential phrases are headed by a definite

D (Elbourne 2005, 2013), such examples can have a derivation like (33b), on the assumption that a definite D has the same type as a choice function ( $\langle et, e \rangle$ ).

(33) **Topicalization of referential DP:**

a. This book, Alex never read.

b.

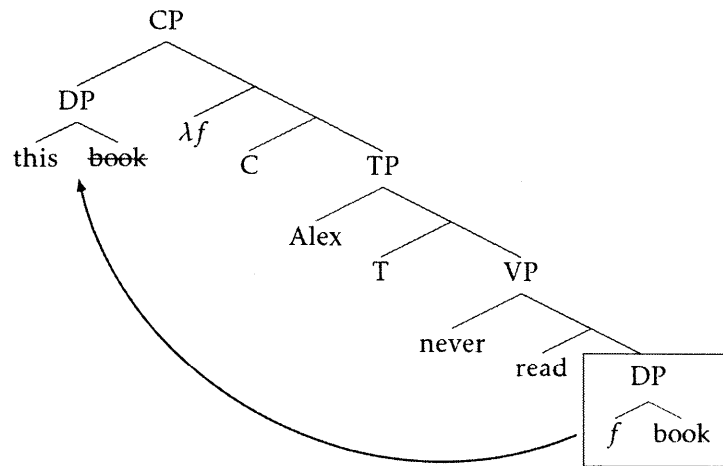

An alternative that is also compatible with what I say here is to treat definite determiners as existential quantifiers with a uniqueness presupposition, in which case they compose in the same way as other existential expressions, like *wh*-words or indefinites.

One possible challenge to the idea that all  $\bar{A}$ -movement involves abstraction over choice functions comes from Lasnik and Stowell's (1991) observation that not all  $\bar{A}$ -movements appear to display Weak Crossover effects. As pointed out by Lasnik and Stowell (1991), topicalization, non-restrictive relative clauses, parasitic gap constructions, and *tough*-movement do not appear to trigger the Weak Crossover effect (34a–d).<sup>14</sup>

(34) **No Weak Crossover with topicalization, tough-movement, or parasitic gaps:**

a. This book<sub>i</sub>, I expect its<sub>i</sub> author to buy \_\_\_\_.

b. Gerald, who his<sub>i</sub> mother loves \_\_\_\_, is a nice guy.

c. Who<sub>i</sub> will be easy [for us to get his<sub>i</sub> mother to talk to \_\_\_\_]?

d. Who<sub>i</sub> did you stay with \_\_\_\_ [before his<sub>i</sub> wife had spoken to \_\_\_\_]?

(Lasnik and Stowell 1991:691,698)

As noted by Ruys (2004), the absence of Weak Crossover with *tough*-movement is not surprising. *Tough*-movement involves a step of A-movement in the higher clause under any analysis, which

14. Variable binding differs in this regard from anaphor binding, which is why it is important to distinguish Weak Crossover effects with  $\bar{A}$ -movement from the inability to license anaphors.

allows a pronoun to be bound.<sup>15</sup> In addition, Ruys observes that the apparent amelioration effect with parasitic gaps has nothing to do with the  $\bar{A}$ -movement step in the infinitival adjunct. There are also no Weak Crossover effects in this configuration when the parasitic gap is absent (35a–c), suggesting that variable binding is possible in this configuration to begin with.<sup>16</sup>

(35) ***Weakest Crossover does not depend on parasitic gap:***

- a. Who<sub>i</sub> did you stay with \_\_\_ [before his<sub>i</sub> wife had spoken to \_\_\_]?
- b. Who<sub>i</sub> did you stay with \_\_\_ [without ever talking to him<sub>i</sub>]?  
(Ruys 2004:127)
- c. Who stayed with who<sub>i</sub> [without ever talking to him<sub>i</sub>]?

See Ruys (2004:sec. 2) for more discussion of the issues that arise with these examples.

I also follow Ruys (2004) in taking the admissible cases of coindexation with topicalization and non-restrictive relative clauses to be cases of coreference and not binding. As support for this, note that Weak Crossover amelioration is only found with referential phrases. Topicalization does not permit quantifiers to establish binding relations (36a–b), a fact first noted by Postal (1993:542).

(36) ***Topicalization of quantificational DP is subject to WCO:***

- a. Every other girl<sub>i</sub>, Alex claims \_\_\_ likes her<sub>i</sub> mother.
- b. \*Every other girl<sub>i</sub>, Alex claims her<sub>i</sub> mother likes \_\_\_.

Ruys also points to differences in the admissibility of a bound reading in pairs like (37a–b), where (37b) only permits a coreferential interpretation (it does not have the reading corresponding to *Even Winnie is liked by his own mother*).<sup>17</sup>

(37) ***Only coreferential reading with crossover in topicalization:***

- a. Even Winnie<sub>i</sub> thinks he<sub>i</sub> is smart.
- b. Even Winnie<sub>i</sub>, his<sub>i</sub> mother likes.  
(Ruys 2004:136)

For arguments to this effect for appositive relative clauses, see Safir (1986; 2004:86). On this basis, I propose that the apparent divide between referential and quantificational DPs noted by Lasnik and Stowell (1991) and Postal (1993) reflects the fact that referential phrases can enter into coreference relations when variable binding is not possible. In this view, we can take all instances of  $\bar{A}$ -movement to involve abstraction over choice functions.

---

15. Though, as Ruys points out, *tough*-movement requires a *licensing* account of Weak Crossover, which assumes that some mechanism is needed to license variable binding that is not possible in  $\bar{A}$ -chains (in this case, abstraction over individuals). An account that assumes variable binding is in principle always possible, but specifically prohibits co-indexing in crossover contexts might not expect *tough*-movement to lack the effect.

16. These patterns raise questions, however, about the role of *c*-command in variable binding and may suggest that linear order plays a role in determining possible binding configurations (e.g. Barker 2012).

17. See Ruys (2004:sec. 4) for more extensive discussion.

The Weak Crossover account developed above can be extended to explain how A-movement and  $\bar{A}$ -movement differ in how they affect binding of Condition A anaphors. Recall that A-movement may create new antecedents for local anaphors, but  $\bar{A}$ -movement cannot (38a–d).

(38) ***A-movement, but not  $\bar{A}$ -movement, binds anaphors:***

- a. He<sub>i</sub> seemed to himself<sub>i</sub> [\_\_\_ to be getting sick].
- b. \*Who<sub>i</sub> did it seem to herself<sub>i</sub> [that you should call \_\_\_ tomorrow]?
- c. \*Who<sub>i</sub> did Alex persuade herself<sub>i</sub> [that you call \_\_\_ tomorrow]?
- d. \*Who<sub>i</sub> do pictures of himself<sub>i</sub> prove [\_\_\_ had a moustache once]?

Anaphor binding is often treated differently from variable binding because there is no Weakest Crossover effect with anaphor binding. Topicalization of a referential DP over a coindexed anaphor is just as degraded as *wh*-movement (39a–b).

(39) ***Topicalization of referential DP cannot feed anaphor binding:***

- a. \*Alex<sub>i</sub>, it seemed to herself<sub>i</sub> [that you should call \_\_\_ tomorrow].
- b. \*Sam<sub>i</sub>, pictures of himself<sub>i</sub> prove [\_\_\_ had a moustache once].

In the previous section, I argued, following Ruys (2004), that Weakest Crossover effects with topicalization are due to the possibility of coreference with referential phrases. If correct, we can explain the absence of Weakest Crossover effects with anaphors by appealing to the notion that anaphors must be *bound* by their antecedents. If anaphors must be bound, the coreference option available to pronouns would be not available with anaphors. Suppose then that a statement along the lines of (40) is a part of the right theory of anaphors (40), which seems uncontroversial.

(40) ***Condition on anaphor binding:***

An anaphor must be bound in a local domain D.<sup>18</sup>

Assuming (40), all the cases in (38b–d) and (39a–b) can be treated as having the same source as the Weak Crossover effects discussed above. Anaphors, like pronouns, are variables over individuals and so can only be bound by movement that triggers abstraction over individuals. If every instance of  $\bar{A}$ -movement involves abstraction over choice functions,  $\bar{A}$ -movement will never allow for the binding of anaphors. Unlike with pronouns, this effect cannot be attenuated with the option of coreference.

In this section, I argued that A- and  $\bar{A}$ -movement create different types of predicates, following Sauerland (1998) and Ruys (2000). This provides an explanation of the Weak Crossover effect, and of the difference between A- and  $\bar{A}$ -movement in how they affect anaphors. In the next section, I provide further evidence for this view based on the distribution of parasitic gaps and depictives, which I show tracks this distinction.

18. I remain agnostic here both about how this condition is derived and the identity of the local domain, though see Safir (2014) and Charnavel and Sportiche (to appear) for recent discussion.

## 4.2 Parasitic gaps and depictives

In this section, I discuss the licensing of parasitic gaps, a classic property of  $\bar{A}$ -movement. I adopt Nissenbaum's (2000) account of parasitic gaps, according to which they are created by null operator movement and the conjunction of predicates. I then discuss Pylkkänen's (2008) observation that similar configurations are attested in A-movement in the licensing of depictives (see also Bruening 2015). I argue that a comparison of the two reveals that A- and  $\bar{A}$ -movement create different types of predicates. Only open predicates formed by the same types of movement can be conjoined.

A well-known difference between A- and  $\bar{A}$ -movement relates to the distribution of parasitic gaps. All instances of  $\bar{A}$ -movement are capable of licensing parasitic gaps (41a–b), but A-movement never can (41c–d).

(41) **Only  $\bar{A}$ -movement licenses parasitic gaps:**

- a. Which book did you read \_\_\_ [after buying \_\_\_]?
- b. That book, I picked up \_\_\_ yesterday [only to throw away \_\_\_ later].
- c. \*Every book was read \_\_\_ [after buying \_\_\_].
- d. \*That book was read \_\_\_ [after buying \_\_\_].

I adopt the approach to parasitic gaps developed by Nissenbaum (2000). Nissenbaum proposes that parasitic gap constructions appear because both intermediate successive-cyclic movement and null operator movement may create derived predicates. Parasitic gaps occur when such predicates are conjoined. In other words, parasitic gaps involve the configuration in (42).

(42) **Parasitic gap configuration in Nissenbaum (2000):**

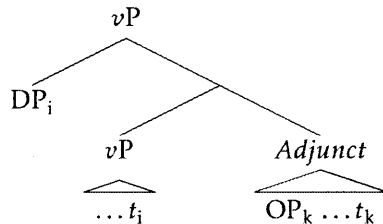

On the assumption that both intermediate movement and null operator movement result in  $\lambda$ -abstraction and so form open predicates, the  $vP$  and adjunct in (42) can be combined to yield a conjoined predicate.<sup>19</sup> This conjoined predicate composes with the DP copy at the  $vP$  edge, leading to the appearance of a parasitic gap.

In Nissenbaum's view, both null operator movement and intermediate  $\bar{A}$ -movement trigger abstraction over individuals. A problem that arises under this analysis, however, is that we in principle expect parasitic gaps to be able to appear in a range of configurations. Adjuncts like the one in (42) should be able to conjoin directly with the verb, which is also a predicate over

19. It is important that the adjunct can be inserted in between the point of abstraction and the DP. In addition to this, more needs to be said about how such predicates can be conjoined. See Nissenbaum (2000) for details.

individuals, or with predicates created by A-movement. In principle then, parasitic gaps should be licensed by thematic positions and A-movement as well.

Observe now that the proposal for Weak Crossover in section 4.1 gives us a reason why parasitic gaps might be limited to  $\bar{A}$ -movement. Suppose that null operator movement leads to abstraction over choice functions, just like all other instances of  $\bar{A}$ -movement. If so, the resulting open predicate would only be capable of being conjoined with another predicate formed by abstraction over choice functions (i.e. one formed by  $\bar{A}$ -movement). To be precise, I propose the structure in (43) for parasitic gaps. Movement of a null operator to the edge of the adjunct triggers abstraction over choice functions and intermediate  $\bar{A}$ -movement creates a  $vP$  predicate of the same type.

(43) *Parasitic gaps with abstraction over choice functions:*

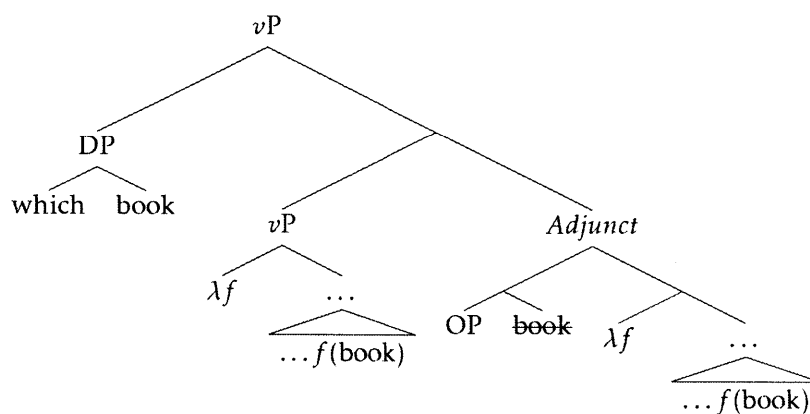

Importantly, I posit an NP restrictor that moves along with the null operator OP and is deleted under identity. It is important that the two gaps have the same restrictor to ensure that the choice function will pick out the same individual. I propose that the matching operation involved is the same one that has been invoked in the treatment of relative clauses (e.g. Carlson 1977; Sauerland 1998). In this view, the left periphery of a parasitic gap adjunct ends up looking essentially identical to the left periphery of a matching relative clause.<sup>20</sup>

If this approach is on the right track, A-movement does not license parasitic gaps because it involves a different type of abstraction, abstraction over individuals. As a result, A-movement creates predicates of the wrong type to be conjoined with predicates formed by null operator movement. For the same reason, parasitic gaps are not licensed by thematic positions. Heads that introduce arguments are of type  $\langle e,t \rangle$  (or  $\langle e,st \rangle$ ) and so not of the right type to license a null operator gap. In this way, the choice function account provides a potential explanation for the absence of parasitic gaps with A-movement. In addition, a prediction of this approach is that we expect to find conjoinable predicates that have an open individual argument whose distribution mirrors that of parasitic gaps, but can only be fed by A-movement and not by  $\bar{A}$ -movement.

20. Accordingly, parasitic gaps lack reconstruction effects, as extensively discussed by Nissenbaum (2000).

Pylkkänen (2008) observes that depictives have exactly this distribution (see also Bruening 2015). Depictives in the usual case can describe subjects or direct objects (44a), but typically cannot refer to indirect objects or obliques (44b–c).

(44) *Depictives can refer to subjects and direct objects:*

- a. Sam<sub>i</sub> hugged Ted<sub>k</sub> drunk<sub>i/k</sub>.
- b. Sam<sub>i</sub> gave Ted<sub>k</sub> coffee drunk<sub>i/\*k</sub>.
- c. Sam<sub>i</sub> danced with Ted<sub>k</sub> drunk<sub>i/\*k</sub>.

As Pylkkänen points out, however, A-movement may create novel interpretations for depictives. A-movement of an indirect object or the DP complement of a preposition allows for that nominal to be modified by a depictive (45a–c). In (45b), it is ambiguous whether the depictive is licensed by intermediate or final A-movement, but examples like (45c) show that intermediate A-movement by itself is capable of licensing a depictive.

(45) *Depictives are licensed by A-movement:*

- a. Ted<sub>k</sub> was danced with \_\_\_ drunk<sub>k</sub>.
- b. Ted<sub>k</sub> was given \_\_\_ coffee drunk<sub>k</sub>.
- c. Ted<sub>k</sub> seems [<sub>TP</sub> \_\_\_ to have been given \_\_\_ coffee drunk<sub>k</sub>].

Pylkkänen gives an analysis of these patterns that is analogous to Nissenbaum’s treatment of parasitic gaps. The depictive denotes a predicate with an open individual argument, which may be conjoined with an argument-introducing head like *v'* or *V*, to yield subject or object depictives. Relevant structures are given in (46) and (47).

(46) *Subject depictive:*

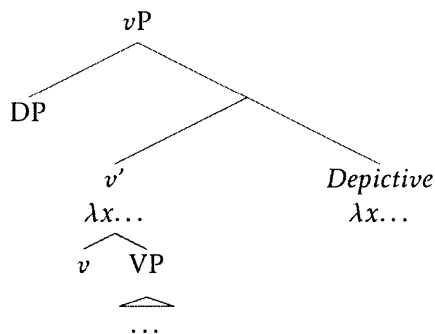

(47) *Object depictive:*

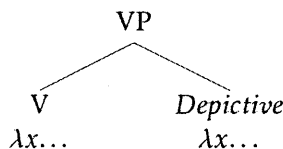

To deal with the fact that depictives can be licensed by A-movement too, Pylkkänen allows for the configuration in (46) to be created by intermediate A-movement as well (see also Bruening 2015). In this view, intermediate A-movement is accompanied by abstraction, just like intermediate  $\bar{A}$ -movement for parasitic gaps, creating a predicate that may combine with the depictive (48).<sup>21</sup>

21. The facts for adjunct control are essentially analogous to those described for depictives. DPs that cannot act as controllers in their thematic position can control PRO after A-movement. An analogous paradigm using outcome clauses, which typically require subject control, is given in (ia–c).



(48) *Intermediate A-movement licenses depictive:*

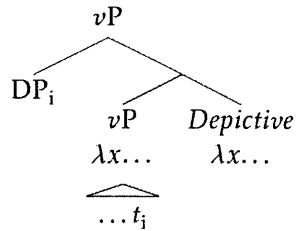

Following Pylkkänen (2008) and Bruening (2015), I assume that depictives adjoin to an intermediate projection in the verb phrase (and not, for instance, to T), because depictives also encode a relation of overlap between the event described by the depictive and the main event. This makes sense of the fact that intermediate A-movement can license a depictive, but we will also shortly see specific evidence that parasitic gaps and depictives are licensed in the same place.

As noted by Pylkkänen, what is striking about these facts is that the interpretation of depictives happens in configurations analogous to those in which parasitic gaps are licensed in Nissenbaum’s approach. However, just as A-movement cannot license parasitic gaps,  $\bar{A}$ -movement cannot give rise to novel interpretations of depictives (49a–b).

(49)  *$\bar{A}$ -movement does not license depictives:*

- a. Who<sub>k</sub> did Sam<sub>i</sub> give \_\_\_ coffee drunk<sub>i/\*k</sub>?
- b. Who<sub>k</sub> did Sam<sub>i</sub> dance with \_\_\_ drunk<sub>i/\*k</sub>?

Taken together, I suggest that these facts offer strong evidence that there is no real asymmetry between A- and  $\bar{A}$ -movement in whether they are capable of forming predicates that may be conjoined: they simply form predicates of different types. There is no need to posit differences in whether intermediate movement occurs or differences in the positions targeted by such intermediate movement steps (as Nissenbaum, Pylkkänen and Bruening suggest). Since  $\bar{A}$ -movement involves abstraction over choice functions, derived predicates created in this fashion can only be conjoined with predicates formed by another step of  $\bar{A}$ -movement. Conversely, predicates with an open individual argument, such as depictives, can conjoin only with other such predicates, such as those formed by argument-introducing heads or created by A-movement.

As Pylkkänen notes, we can find even specific evidence that the licensing of parasitic gaps and depictives does not reflect a difference in what position the two types of movement target. Parasitic gaps can in fact be licensed inside of depictives, as the example in (50) demonstrates (an observation Pylkkänen credits to David Pesetsky and Norvin Richards).

(i) *A-movement licenses adjunct control:*

- a. Sam<sub>i</sub> gave Ted<sub>k</sub> coffee, [only PRO<sub>i/\*k</sub> to refuse to drink it].
- b. Ted<sub>k</sub> was given \_\_\_ coffee, [only PRO<sub>k</sub> to refuse to drink it].
- c. Ted<sub>k</sub> seems [TP \_\_\_ to have been given \_\_\_ coffee, [only PRO<sub>k</sub> to refuse to drink it]].

If adjunct control is treated as a predicative structure, as argued at length by Landau (2013:sec. 6.2), for instance, these facts could be described in the same terms as the licensing of depictives.

- (50) *Parasitic gap in a depictive:*  
 Which country did he die for \_\_\_ [still loyal to \_\_\_]?  
 (Pylkkänen 2008:40)

This is evidence that a depictive is capable of adjoining in the same position as a parasitic gap adjunct. This possibility follows from the current account. Assuming null operator movement in the depictive and that the DP copy left by intermediate  $\bar{A}$ -movement can Merge below the base position of the subject, I propose the structure in (51).

- (51) *LF of parasitic gap in depictive:*

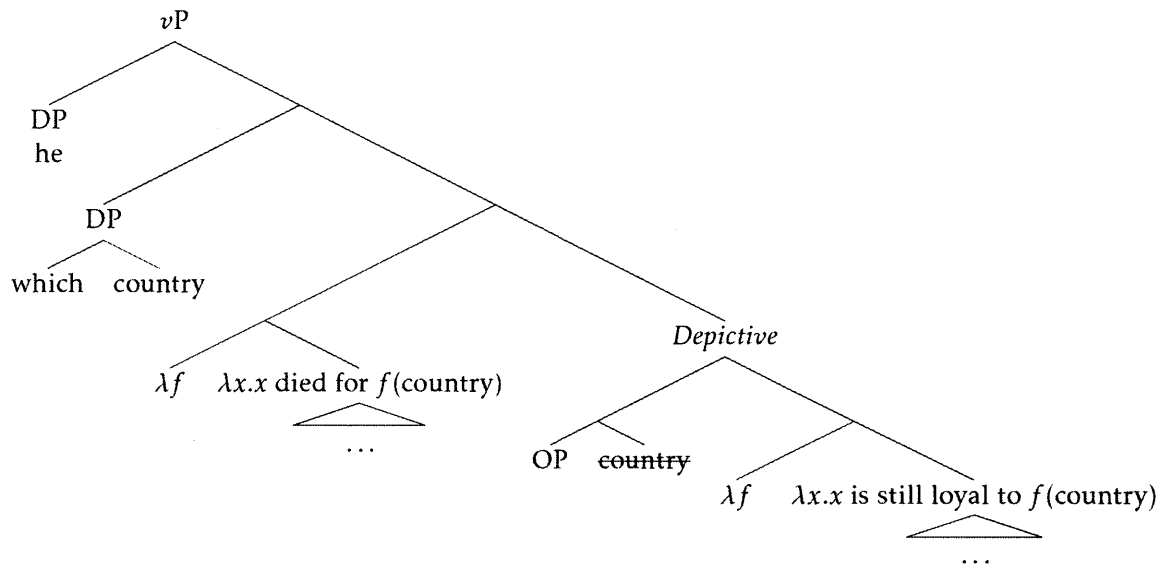

Null operator movement inside the depictive adds an open choice function argument in addition to the open individual argument. The verb phrase has an open individual argument, contributed by  $v$ . Intermediate  $\bar{A}$ -movement triggers abstraction over choice functions in addition to this. The resulting verb phrase can form a conjoined predicate with the depictive, because the two phrases share both open arguments. The  $\bar{A}$ -moved DP and thematic subject then fill these argument positions in turn.<sup>22</sup>

Examples like (50) demonstrate clearly that A- and  $\bar{A}$ -movement form distinct predicates. It is hard to see how we can account for such examples if null operator movement creates predicates of the same type as depictives. This point is particularly clear in examples like (52), in which the depictive is also licensed by intermediate movement.<sup>23</sup>

22. Note that Quantificational Copy Conversion will apply to the intermediate  $\bar{A}$ -copy, along with deletion of the NP restrictor, as a result of further movement to Spec-CP. What is left is a choice function variable that semantically reconstructs into the depictive and verb phrase and is bound to the higher copy of the *wh*-phrase.

23. Note, however, that, in order to account for such examples, we have to allow all abstraction to take place below the Merge site of both intermediate copies.

(52) *Parasitic gap in depictive licensed by intermediate movement:*

Which country was she warned \_\_\_ about \_\_\_ [still loyal to \_\_\_]?

Such examples provide evidence that the ability to license parasitic gaps or depictives is not derivative of the position targeted by movement. In these cases, parasitic gaps and depictives are licensed in the exact same position. In other words, the difference between A- and  $\bar{A}$ -movement remains intact even when they move to specifiers of the same  $\nu$  head. As a result, these facts teach us that intermediate A- and  $\bar{A}$ -movement cannot be distinguished solely by the positions they target. Instead, they should be distinguished only by what predicates they create, which we can link to the interpretive effects of the Agree relations involved.

In this way, the idea that A- and  $\bar{A}$ -movement involve different types of abstraction provides an explanation of Weak Crossover effects, the inability for  $\bar{A}$ -movement to effect anaphor binding, and the differing distribution of parasitic gaps and depictives noted by Pylkkänen (2008). The specific implementation I adopted here was to suggest that all  $\bar{A}$ -movement involves abstraction over choice functions, drawing on the account of Weak Crossover in Sauerland (1998) and Ruys (2000). In a featural approach to the A/ $\bar{A}$ -distinction, we can tie these different types of abstraction to the interpretation of different Agree relations at LF. Although some of these results can be encoded in a positional approach as well, the fact that a parasitic gap can be licensed in a depictive provides crucial evidence that syntactic position is irrelevant: the distinction between A- and  $\bar{A}$ -movement remains even when they target the same syntactic position.

## 5 Some consequences of a featural approach

In this chapter so far, I have shown that much of the A/ $\bar{A}$ -distinction can be accounted for without appealing to properties of syntactic positions, relying simply on the idea that these two types of movement are driven by different features. On this basis, I have argued that the notion of A- and  $\bar{A}$ -positions should be dispensed with. None of the proposals I have presented are obviously improved by positing incorporating distinct A- and  $\bar{A}$ -positions. In this section, I discuss some of the theoretical consequences of a featural approach to the A/ $\bar{A}$ -distinction. I first examine the status of thematic positions. Since only the features that trigger movement matter in the framework defended here, thematic positions can no longer be classified as A- or  $\bar{A}$ -positions. I show here that nothing is lost as a result of this. Most A/ $\bar{A}$ -properties emerge only in the context of movement, and, for the others, the proposals presented here extend without serious modification to the status of thematic positions.

I also outline a prediction of the featural approach, which is the focus of Chapters 3 and 4. On the basis of the distribution of relativized probing for person and number, I suggest that Agree may sometimes involve multiple features acting as a *composite probe* (Coon and Bale 2014). As a result, it should be possible for some movement types to involve multiple Agree relations. In a featural approach to the A/ $\bar{A}$ -distinction, this means that we might expect to find movements driven by  $\varphi$ -features and features like *Wh* at the same time. Such movement should be associated both with

the benefits of A-movement and those of  $\bar{A}$ -movement. After providing some background on Dinka clause structure in Chapter 3, I argue in Chapter 4 that this is the case in Dinka: all movement, local or long-distance, has the same repercussions for case, verb-second, and binding.

### 5.1 On the status of thematic positions

One of the consequences of a featural approach to the A/ $\bar{A}$ -distinction is that thematic positions can no longer be grouped together with either type of derived position. If all that distinguishes A- and  $\bar{A}$ -movement is the features involved in driving movement, it no longer makes sense to ask whether thematic positions are A- or  $\bar{A}$ -positions. In this section, I demonstrate nothing is lost because of this. The proposals I outlined for the properties that distinguish A- and  $\bar{A}$ -movement make the correct predictions for the behavior of thematic positions. For several of the A/ $\bar{A}$ -properties under discussion, this is not a concern to begin with, because they only emerge in the context of movement. This is true of constraints on locality, categorical restrictions, the availability of pied-piping, and reconstruction of Principle C.

When it comes to binding, it is usually assumed that both anaphor binding and variable binding pattern with A-movement. Although there are no obvious cases in which variable or anaphor binding is not permitted from a c-commanding base position,<sup>24</sup> there are proposals in which all binding requires movement, in order to establish the necessary abstraction relation (e.g. Heim and Kratzer 1998). Such a view is in principle compatible with what I say here, as long as all DPs that can initiate binding undergo at least a short step of A-movement. Under this view, thematic positions themselves do not pattern either with A-movement or with  $\bar{A}$ -movement.

However, the position that I will take here is that there are semantic mechanisms that allow for binding from thematic positions, taking thematic positions to pattern with A-movement. For the sake of concreteness, I adopt Büring's (2005) proposal for a  $\beta$ -operator, which achieves this, though my account should in principle be compatible with any mechanism along these lines. Büring proposes that a  $\beta$ -operator can freely merge in between a thematic position and the argument-introducing head, in a configuration like (53a).

(53) *Syntax and semantics of Büring's  $\beta$ -operator:*

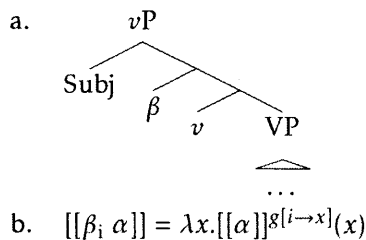

24. I set aside worries about whether c-command is truly what matters for binding (e.g. Safir 2004; Büring 2005; Barker 2012; Bruening 2014).

The  $\beta$ -operator is defined as in (53b), and allows for a pronoun to be bound from the base position of a DP. This operator allows for binding from thematic positions and is compatible with the approach to Weak Crossover and anaphor binding developed in section 4.1.<sup>25</sup>

Finally, as mentioned in section 4.2, thematic positions pattern with A-movement in licensing depictives, in examples like (54a–b). Unlike positions created by  $\bar{A}$ -movement, thematic positions do not license parasitic gaps (54c).

(54) *Thematic positions license depictives, not parasitic gaps:*

- a. I threw the ball<sub>i</sub> wet<sub>i</sub>.
- b. I<sub>i</sub> threw the ball drunk<sub>i</sub>.
- c. \*The book<sub>i</sub> bothered me [OP<sub>i</sub> while reading \_\_\_\_].

The pattern in (54a–c) follows from the account of parasitic gaps and depictives outlined in section 4.2. The behavior of depictives follows from the fact that verbs take individual arguments. As a result, we expect that the predicates that verbs form pattern with the predicates formed by A-movement, and not those formed by  $\bar{A}$ -movement.<sup>26</sup>

What should be clear is that nothing is obviously lost by no longer defining thematic positions as A- or  $\bar{A}$ -positions. For parasitic gaps and depictives, the behavior of thematic positions follows from the idea that only A-movement involves abstraction over individuals. When it comes to variable binding and anaphor binding, a separate mechanism is already necessary to make binding possible, whether it is a step of A-movement or Büring's  $\beta$ -operator. In any case, the behavior of thematic positions is compatible with a featural approach.

## 5.2 A prediction of the featural approach

In this section, I discuss another consequence of the featural approach to the A/ $\bar{A}$ -distinction: the possibility of movements driven by multiple types of features. If phrasal movement can be driven by a  $\varphi$ -probe and a probe like *Wh* at the same time and all A/ $\bar{A}$ -properties are actually properties of the probing features, we expect the resulting movements to display mixed behavior.

A number of authors, working on a variety of phenomena, have argued that multiple probing features may sometimes act in unison (e.g. Chomsky 2001:15–19; Bruening 2001:sec. 5.7; Pesetsky and Torrego 2001; Starke 2001; Haegeman 2013; Rezac 2013; Coon and Bale 2014; Kotek 2014; Deal 2014). I illustrate with person and number probes, which I will show can probe either separately or together. On this basis, I adopt Coon and Bale's (2014) proposal that two probing features can act as a *composite probe*, so that they select and target goals together.

---

25. Note that we do not even need to posit syntactic restrictions on the distribution of the  $\beta$ -operator. Because the Weak Crossover account relies on abstraction over choice functions, and the  $\beta$ -operator requires abstraction over individuals, it cannot introduce extra binding possibilities for  $\bar{A}$ -chains.

26. One question that I will leave open is how to analyze constructions for which it has been suggested that null operator gaps are conjoined with a thematic position, such as purpose clauses with object gaps, gapped degree phrases, or *tough*-movement (e.g. Nissenbaum and Schwarz 2011).

In many cases, it can be hard to tell whether person and number probe together or separately, because these features often occur together. If all relevant goals in the c-command domain of a head carry both person and number features, it is not clear whether person and number separately target the closest DP or together. Work on the distribution of  $\varphi$ -agreement crosslinguistically has shown, however, that there are languages with person and number probes relativized to specific features, such as [participant] and [plural] (e.g. Nevins 2007, 2011; Preminger 2011), or patterns of *omnivorous* agreement, which allows this question to be examined.

One example of an omnivorous person pattern comes from complementizer agreement in Nez Perce (Deal 2014). In contexts of  $\bar{A}$ -movement in Nez Perce, the complementizer displays agreement that is sensitive to particular person features. In (55a–b), for instance, the complementizer agrees with a 2nd person pronoun, regardless of whether it is the subject or object.

(55) *Omnivorous person in Nez Perce complementizer agreement:*

- a. ke-m kaa *pro*<sub>2SG</sub> 'e-cew'cew'-teetu Angel-ne  
 c-2 then 3<sub>OBJ</sub>-call-TAM Angel-ACC  
 'When you call Angel, ...'
- b. ke-m kaa Angel-nim hi-cew'cew'-teetu *pro*<sub>2SG</sub>  
 c-2 then Angel-NOM 3<sub>SUBJ</sub>-call-TAM  
 'When Angel calls you, ...'  
 (Nez Perce; Deal 2014:4)

We also find instances of omnivorous number, such as in the Kaqchikel Agent Focus Construction, as discussed in Preminger (2011). In the examples in (56a–b), for instance, we see that the plural DP must be targeted, whether it is a subject or object.<sup>27</sup>

(56) *Omnivorous number in Kaqchikel Agent Focus:*

- a. ja rje' x-e-tz'et-ö rja'  
 FOC them PRF-3<sub>PL</sub>-see-AF him  
 'It was them who saw him.'
- b. ja rja' x-e-tz'et-ö rje'  
 FOC him PRF-3<sub>PL</sub>-see-AF them  
 'It was him who saw them.'  
 (Kaqchikel; Preminger 2011:48)

These facts teach us that person and number probes can be relativized to specific features, but also that these two probes may select targets independently of one another.

If two probes can also be forced to select a goal together, however, we expect to find an omnivorous agreement pattern in which only 1st/2nd person plurals trigger an omnivorous pattern. Coon and Bale (2014) describe a pattern of omnivorous agreement in Mi'gmaq along these

27. See Preminger 2011 for discussion of how this interacts with person agreement.

lines, in which a [participant] probe and a [plural] probe necessarily act in concert, in contrast to the Nez Perce and Kaqchikel facts. In particular, Mi'gmaq has a subject agreement slot that displays omnivorous agreement only for 1st and 2nd person plurals. Consider first the examples in (57a–c). The bolded agreement suffix behaves as subject agreement when the object is 1st or 2nd person singular or 3rd person plural and so appears to show no omnivorous person or number effect.<sup>28</sup>

(57) *No omnivorous agreement with 1st/2nd singular or 3rd plural:*

- a. Mu nem-i'li-w-**g**.  
NEG see-1OBJ-NEG-3  
'She doesn't see me.'
  - b. Mu nem-u'ln-u-**eg**.  
NEG see-2OBJ-NEG-1EXCL  
'We<sub>EXCL</sub> doesn't see you<sub>SG</sub>.'
  - c. Mu nemi-a-w-**gw-ig**.  
NEG see-3OBJ-NEG-1INCL-3PL  
'We<sub>INCL</sub> don't see them.'
- (Mi'gmaq; Coon and Bale 2014:89)

However, Coon and Bale observe that an omnivorous pattern emerges with 1st and 2nd person plurals, or goals that are *both* [participant] and [plural]. When a 1st/2nd plural argument is around, like the 1st person exclusive in (58a–b), the subject agreement slot references it regardless of grammatical function.

(58) *Omnivorous agreement with 1st/2nd plural:*

- a. Mu nem-u'ln-u-**eg**  
NEG see-2OBJ-NEG-1EXCL  
'We<sub>EXCL</sub> don't see you<sub>SG</sub>.'
  - b. Mu nem-i'li-w-**eg**  
NEG see-1OBJ-NEG-1EXCL  
'You<sub>SG</sub> don't see us<sub>EXCL</sub>.'
- (Mi'gmaq; Coon and Bale 2014:92)

As Coon and Bale point out, comparing this pattern to the Nez Perce and Kaqchikel facts shows that two separate probes can sometimes necessarily act in unison. To achieve this, they propose that the [participant] and [plural] probe in Mi'gmaq act as a *fused* or *composite* probe, so that they must select a goal together. The resulting probe is insensitive to goals that carry just [participant] or [plural], but will agree with any pronoun that carries both features.

28. Though note that an additional suffix *-ig* appears with 3rd person plural in (57c), which does show an omnivorous number pattern. Following Coon and Bale, I take this to be a separate process.

Suppose then that such composite probes are possible, and that languages may choose to treat two probes on one head as composite.<sup>29</sup> If so, we expect to find other types of composite probes, such as composite probes consisting of a  $\varphi$ -probe and a probe that drives  $\bar{A}$ -movement. This is schematized in (59).<sup>30</sup>

(59) **Composite probe of  $\varphi$  and  $Wh$ :**

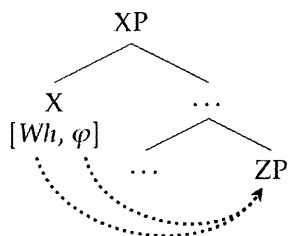

If A- and  $\bar{A}$ -properties are properties of the triggering features, as argued in this chapter and in this dissertation, then we make an important prediction about movement driven by a probe like (59). If phrasal movement can be triggered by such a composite probe, the resulting movement should be associated with both the benefits of A-movement and those of  $\bar{A}$ -movement, since these are conferred by the Agree relations involved.

To be precise, we expect movement of this type to have a specific profile. To begin with, the locality constraints on such movements should be those of  $\bar{A}$ -movement, in the featural view of Relativized Minimality outlined in section 2.1 (Rizzi 1990 et seq.). Just as Mi'gmaq omnivorous agreement may skip over goals that are only [participant] or only [plural], intervening DPs or CPs that carry only  $\varphi$ -features should not matter for such a probe (60).

(60) **Locality of composite probing:**

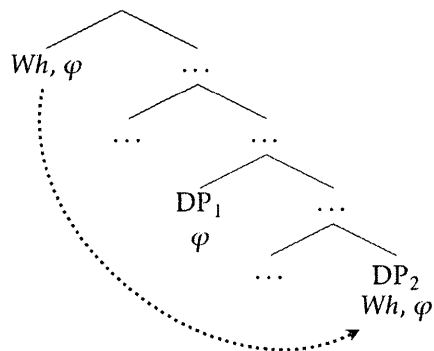

29. There are a number of other technical implementations that allow for two probes to act in unison, most of which are also compatible with what I say here (e.g. Chomsky 2001:15–19; Bruening 2001:sec. 5.7; Pesetsky and Torrego 2001; Haegeman 2012; Rezac 2013; Kotek 2014; Deal 2014).

30. I assume here that composite probes consist of probes merged on the same head. We could also imagine that heads cannot carry more than one feature, as long as there is some mechanism that forces two adjacent heads in the same extended projection to probe together.



A composite probe, like any other probe, looks for the closest phrase that carries matching features, which in this case is a goal with both  $\varphi$ -features and a *Wh*-feature.  $DP_1$  in (60) is not a relevant goal because it does not satisfy that description. At the same time, movements established by an Agree relation like (59) should act like A-movement for binding. Takahashi and Hulsey's (2009) Wholesale Late Merger approach to reconstruction for Principle C should allow for such chains to avoid obligatory reconstruction, since case can potentially be assigned to the NP in its landing site. In addition, intermediate copies left by such movement should be capable of involving either abstraction over choice functions or over individuals, and so no crossover effects should be found. In addition, such movement should be capable of licensing both parasitic gaps and depictives.<sup>31</sup>

It is worth noting that there has been a great deal of debate about whether scrambling instantiates mixed movement (e.g. Saito 1989; Webelhuth 1989; Mahajan 1990; Müller 1995). The type of movement I am concerned with here is crucially *long-distance* and has the information-structural effects of other kinds of  $\bar{A}$ -movement (e.g. question/relative clause formation, topicalization). Since scrambling with A-properties is clause-bounded and has a different set of interpretive effects, the syntax in (59) and (60) cannot be said to describe it. What I say in this dissertation is straightforwardly compatible with Mahajan's (1990) conclusion that there are two distinct operations of A-scrambling and  $\bar{A}$ -scrambling, or with the idea that scrambling orders are base-generated (e.g. Neeleman 1994). I will leave open the issue of how the conclusions argued for here bear on other possible accounts of scrambling, however.

In the next two chapters, I argue that the above describes phrasal movement in the Nilotic language Dinka. Chapter 3 outlines the basics of Dinka clause structure, which will set the stage for Chapter 4, in which I show that all long-distance and local movement in Dinka is driven by information-structural features and  $\varphi$ -agreement at the same time. As predicted by a featural approach, the resulting movements can be long-distance, but pattern with A-movement for binding. These facts then provide an argument in favor of a featural approach to A/ $\bar{A}$ -properties over a positional one.

## 6 Summary

In this chapter, I have argued that A- and  $\bar{A}$ -movement are distinguished only by the features that drive them and not the positions they target. I have shown that all that is needed to derive the A/ $\bar{A}$ -distinction is the idea that different types of features may establish phrasal movement. We can then eliminate the notions of A- and  $\bar{A}$ -positions, and rely strictly on independent properties of the features that happen to be associated with different syntactic positions.

In the next two chapters, I offer an argument for the featural approach advocated here, drawn from the behavior of phrasal movement in Dinka. I argue that the prediction outlined in section 5.2 is borne out in Dinka. I first show that movement in Dinka is driven by a composite probe, so

---

31. These last two predictions about parasitic gaps and depictives will turn out to be hard to definitively test, since Dinka allows neither.

that all long-distance movement is accompanied by  $\varphi$ -agreement. In accordance with a featural approach, these movements can be long-distance but pattern with A-movement when it comes to binding and reconstruction for Principle C. These facts then provide evidence that A/ $\bar{A}$ -properties are characteristics of features and not of syntactic positions.

## CHAPTER THREE

### DINKA CLAUSE STRUCTURE

---

In this chapter, I provide a basic description of the clause structure of Dinka, the Nilotic language that is the focus of much of this dissertation. The main purpose of this chapter is to provide background for the discussion of the A/ $\bar{A}$ -distinction in Chapter 4. I will show that the Dinka clause can be decomposed into three separate fields, whose syntax I describe in turn. I focus in particular on the treatment of a system of *extraction marking* in the left periphery, which I argue is analogous to subject vs. non-subject extraction marking in languages like English and French and functions as a reflex of movement. In addition, I provide an analysis of the two case alternations found in Dinka, found with subjects and obliques.

#### 1 Background on Dinka

Dinka (*Thuɔŋjäŋ*) is an Eastern Sudanic language within the Nilo-Saharan family (Greenberg 1966; Bender 2000). It is most closely related to Nuer and the Luo languages and, with these languages, constitutes the Western Nilotic group. Dinka is the most commonly spoken language of South Sudan, with at least 3 million speakers (Abu-Bakr and Abu-Manga 1997:3).

The earliest descriptive work on Dinka was undertaken by German and Italian scholars and missionaries in the 19th and early 20th century and resulted in several grammar sketches and dictionaries (Brun-Rollet 1862; Mitterutzner 1866; Beltrame 1870, 1880; Müller 1877; Schuchardt 1912; Westermann 1912). More research on Dinka was done in the middle of the 20th century by several European scholars (Nebel 1936, 1948, 1979; Tucker 1938; Trudinger 1942–44; Tucker and Bryan 1966; Tucker 1967, 1981; Roettger and Roettger 1989; Duerksen 1997).

In recent decades, this work has been followed up by extensive research on Dinka morphology and phonology (Andersen 1987, 1993, 1995, 2007; Malou 1988; Gilley 2003; Remijsen and Gilley 2008; Remijsen and Ladd 2008; Remijsen and Adong Manyang 2009; Ladd, Remijsen, and Adong Manyang 2009; Remijsen 2013). In addition, Torben Andersen has described several aspects of the syntax of the Agar dialect, including word order, the expression of case, the inventory of auxiliary verbs, number, and the encoding of directionality (Andersen 1991, 2002, 2007, 2012, 2014).

Dinka and its various dialects are spoken primarily in central South Sudan, along the White Nile and its tributaries (Malou 1988). The distribution of Dinka in South Sudan is illustrated on the map in Figure 1.



**Figure 1.**  
*Map of South Sudan, with the area in which Dinka is spoken highlighted.*

(Source used: Gulf/2000, Dr. Michael Izady.)

There are at least four major dialect groups of Dinka (Roettger and Roettger 1989; Duerksen 1997; Idris 2004): Northern (Padang), Western (Rek), Southern (Agar), and Eastern (Bor).<sup>1</sup> The data in this dissertation comes from fieldwork on the Bor dialect in the Dinka diaspora community in Boston.<sup>2</sup> Bor is a dialect in the Southern/South Eastern dialect group, which consists of at least four dialects: Bor, Hol, Nyaarweng, and Twic.

The same basic clause structure seems to be found across dialects. Dinka has a fairly strict word order, which can be characterized by the template in (1). See also Andersen (1991:292).

(1) *Dinka word order template:*

Topic	FiniteAux/Verb	Subject	Object1	NonfiniteAux/Verb	Object2	Adjuncts
Left periphery		Middle field		Right periphery		

I decompose the Dinka clause into three separate “fields”. The left periphery is mainly characterized by a V2 effect. It consists of a clause-initial position, which must be occupied by a nominal that serves as the topic or focus of the clause, followed by the highest verb or auxiliary. The left periphery is followed by the middle field, which is where the subject and object appear if not in topic/focus position, strictly in that order.<sup>3</sup> The right periphery is demarcated on the left by the verb cluster, which is where all verbs and auxiliaries go if they are not in second position. This verb cluster is followed by a second DP object, if one is present, and then all modifiers.

---

1. Sometimes these are called Northwestern, Northeastern, Southwestern, South Central, and South Eastern, splitting the large group of northern dialects into two distinct groups.

2. Many Dinka have been displaced in recent decades, because of civil war in Sudan and South Sudan, particularly young boys and girls. In 2001, around 4000 such “Lost Boys”, the majority of whom are Dinka, emigrated to the United States. The Sudanese Education Fund estimates that more than 200 of these refugees moved to the Boston area.

3. There is a third position in the middle field that I am ignoring for simplicity for the moment. It is located in between the subject and object, and it is where a copied pronoun can appear as a reflex of a process of multiple copy spell-out. This is described in detail in Chapter 6.

## 2 The Dinka left periphery

I start by outlining the properties of the left edge of the Dinka clause. Dinka V2 is tracked by an Austronesian-style voice system, so that the grammatical function of the initial nominal is indicated on the second-position verb or auxiliary. I propose that Dinka V2 involves head movement of the highest verb/auxiliary to C, coupled with the requirement that Spec-CP must be occupied. I then provide an analysis of Dinka voice, according to which it involves two components: subject vs. non-subject extraction plus an incorporated preposition that accompanies movement of PPs.

### 2.1 V2 in Dinka

Dinka clause structure in essence represents the combination of Germanic verb-second (Andersen 1991, 2002; Van Urk and Richards 2015) with an Austronesian-style voice system. Let me start by discussing verb-second. The verb always occupies second position, although it may be preceded by a variety of constituents. In neutral word order, the subject is clause-initial (2a). But nominals with any other grammatical function may also be fronted, with the verb immediately following (2b–c).

#### (2) *The verb is in second position:*

- a. Àyén à-cám cuḷin nẹ pǎal.  
Ayen 3s-eat.sv food P knife  
'Ayen is eating food with a knife.'
- b. Cuḷin à-céem Áyèn nẹ pǎal.  
food 3s-eat.ov Ayen.GEN P knife  
'Food, Ayen is eating with a knife.'
- c. Pǎal à-céemè Áyèn cuḷin.  
knife 3s-eat.oblv Ayen.GEN food  
'With a knife, Ayen is eating food.'

Just as in familiar V2 languages, when an auxiliary is present, it is the highest auxiliary that occupies second position. In (3a–c), the perfect auxiliary *cé* appears and, as a result, it sits in second position instead of the main verb *cám* ('eat').

#### (3) *The highest auxiliary is in second position:*

- a. Àyén à-cé cuḷin cáam nẹ pǎal.  
Ayen 3s-PRE.sv food eat.NF P knife  
'Ayen has eaten food with a knife.'
- b. Cuḷin à-cíi Áyèn cáam nẹ pǎal.  
food 3s-PRE.ov Ayen.GEN eat.NF P knife  
'Food, Ayen has eaten with a knife.'
- c. Pǎal à-cénè Áyèn cuḷin cáam.  
knife 3s-PRE.oblv Ayen.GEN food eat.NF  
'With a knife, Ayen has eaten food.'

This is the same verb-second pattern that is found in many Germanic languages, for instance. Some comparable examples from Dutch are presented below. In neutral sentences, the subject appears first, with the verb immediately following (4a). If an object or an oblique is topicalized to the beginning of the clause, the verb follows the displaced phrase instead (4b–c).

(4) **Verb-second in Dutch:**

- a. Kim **las** dat boek met een vergrootglas.  
Kim **read** that book with a magnifying.glass  
'Kim read that book with a magnifying glass.'
- b. [<sub>DP</sub> Dat boek] **las** Kim met een vergrootglas.  
that book **read** Kim with a magnifying.glass  
'That book, Kim read with a magnifying glass.'
- c. [<sub>PP</sub> Met een vergrootglas] **las** Kim dat boek.  
with a magnifying.glass **read** Kim that book  
'With a magnifying glass, Kim read that book.'

I suggest that, in Dinka, as argued also for the V2 systems of languages like Dutch and German, this V2 pattern arises because the highest verb or auxiliary undergoes head movement into the left periphery of the clause, and requires an XP in its specifier. More precisely, I propose that there is obligatory head movement to C in Dinka, and that the clause-initial position is Spec-CP, although nothing much hinges on the identity of the left-peripheral head for the purposes of the overall argument of the dissertation.

There are a number of indications, however, that the second position verb or auxiliary is indeed in the C domain. The first is the observation that it hosts a marker of clause type. As Andersen (1991) points out, there is a particle *a-* that appears on second position verbs and auxiliaries in declarative clauses. In (5a–c), the verb *câam* ('eat') is in second position and is marked with this prefix. (Note that this prefix marks tense and  $\varphi$ -agreement also.)

(5) **Declarative a- appears on second position verb:**

- a. Áyén à-càm cuḷin nẹ pǎal.  
Ayen **D.3s-eat.sv** food P knife  
'Ayen is eating food with a knife.'
- b. Cuḷin à-céem Áyèn nẹ pǎal.  
food **D.3s-eat.OV** Ayen.GEN P knife  
'Food, Ayen is eating with a knife.'
- c. Pǎal à-céemẹ Áyèn cuḷin.  
knife **D.3s-eat.OBLV** Ayen.GEN food  
'With a knife, Ayen is eating food.'

This prefix takes a different form in interrogative contexts, such as in the in-situ questions in (6a–c). In these examples, the *a-* that marks declarative contexts is absent, although tense and agreement information is retained.

(6) *Declarative marker is absent in questions:*

- a. Yii ɲà ɛ̣-kè-càm cuɲin nɛ̣ pɛ̣ɛɛl?  
ASSOC who PST-PL-eat.sv food P knives  
'Who all was eating food with knives?'
- b. Cuɲin ɛ̣-cɛ̣ɛm yii ɲà nɛ̣ pɛ̣ɛɛl?  
food PST-food.ov ASSOC who P knives  
'The food, who all was eating it with knives?'
- c. Pɛ̣ɛɛl ɛ̣-kè-cɛ̣ɛmɛ̣ yii ɲà ké cuɲin?  
knives PST-PL-eat.oblv ASSOC who 3PL food  
'Knives, who all was eating food with them?'

The presence of this particle suggests that the second position is in the left periphery of the clause, because it encodes information usually found in the C domain. A plausible view of this morpheme is as the C head that attracts the highest verb or auxiliary.

We also find environments in which the presence of a complementizer blocks V2. This is true of the interrogative complementizer *nàa* and the declarative complementizer (*n*)ɛ̣, for instance. When these C heads are present, verb-initial order emerges (7a–b).

(7) *Overt complementizers show V1 order:*

- a. Bòl à-gàì [CP nàa càm Áyèn cuɲin].  
Bol 3s-wonder.sv whether eat.sv Ayen.GEN food  
'Bol is wondering whether Ayen is eating food.'
- b. À-yùukù luéel [CP ɛ̣ cɛ̣ Áyèn cuɲin càm nɛ̣ pàal].  
3s-be.1PL say.nf C PRE.sv Ayen.GEN food eat.nf P knife  
'We say that Ayen has eaten food with a knife.'

A third argument for treating Dinka V2 as CP-level is that the position I identify as Spec-CP above serves as the escape hatch position, as I demonstrate in detail in Chapter 5. This is a function that is usually taken to be associated with Spec-CP (e.g. Chomsky 1977 et seq.).

One complication, which I discuss in Chapter 5 (section 2), is that V2 may co-occur with some complementizers as well. I suggest there that the Dinka C domain contains at least two C projections, where the position I call Spec-CP is the specifier of the lower one. The facts outlined above seem sufficient grounds to think that Dinka V2 does reflect movement of the verb/auxiliary up to a projection in the C domain, however, and so I will continue to refer to the clause-initial and verb-second position as Spec-CP and C, respectively. As mentioned above, none of the argumentation in this dissertation hinges on this analytical choice.

## 2.2 Voice in Dinka

Unlike in Germanic V2 languages, the phrase in the Dinka clause-initial position, or Spec-CP, is always nominal in form, surfacing in the unmarked absolutive case. In addition, Dinka V2 co-occurs with an Austronesian-style voice system. Specifically, as in many Austronesian languages, the grammatical function of the clause-initial noun phrase is indicated by morphology on the verb or auxiliary in C. The examples in (8a–c) demonstrate for the future auxiliary *bé*.

(8) **Grammatical function of initial nominal indicated on verb/auxiliary:**

- a. Páal à-**bé** dhuòŋ.  
knife 3s-**PRF.SV** break.INCH.NF  
'The knife will break.'
- b. Páal à-**bíi** Ból dhòŋ.  
knife 3s-**PRF.OV** Bol.GEN break.NF  
'The knife, Bol will break.'
- c. Páal à-**béné** Áyèn cuŋin cáam.  
knife 3s-**PRF.OBLV** Ayen.GEN food eat.NF  
'With a knife, Ayen will eat food.'

In (8a), the subject is in Spec-CP and the form of the future auxiliary is *bé*. I will refer to this *Subject Voice* (SV) morphology. As Andersen (1993, 2002, 2007) describes in detail, the SV form is the default form of any verb or auxiliary. In (8b), the direct object has been topicalized and the auxiliary surfaces as *bíi*, which I will call the *Object Voice* (OV) form. Finally, in (8c), the nominal in clause-initial position is an instrumental. This is indicated by *Oblique Voice* (OblV) morphology on the auxiliary, expressed by the suffix *-é/-né*, used for all nominals otherwise introduced by a preposition. I introduce this terminology to emphasize the similarities between Dinka and Austronesian voice systems. Andersen (1993, 2002, 2007), in his description of the Agar dialect, treats SV as the basic form, OV as the *non-topic subject* form and OblV as *circumstantial topic* morphology, already indicative of this parallel.<sup>4</sup>

Similar systems are found in many Austronesian languages. Malagasy, for instance, closely resembles Dinka in this respect. In Malagasy, one nominal always appears sentence-finally, indicating the “topic” of the clause, and its grammatical function is marked on the verb (9a–c).

(9) **Voice in Malagasy:**

- a. **Mamono** ny akoho amin'ny antsy ny mpamboly  
**sv.kill** DET chicken with-DET knife DET farmer  
'The farmer is killing chickens with the knife.'

---

4. The distribution of Oblique Voice marking seems subject to some cross-dialectal variation. Part of the Andersen's (1991, 2002) motivation for not describing Dinka as a voice system comes from the fact that the Agar dialect he describes does not employ Oblique Voice in examples like (8c). Instead, OV morphology is used. In Agar, the distinction encoded by the Oblique Voice marker *-é/-né* appears to be restricted to passives.



- b. **Vonoin'** ny mpamboly amin'ny antsy ny akoho  
**ov.kill** DET farmer with-DET knife DET chicken  
 'The chickens, the farmer is killing with the knife.'
- c. **Amonoan'** ny mpamboly ny akoho ny antsy  
**OBLV.kill** DET farmer DET chicken DET knife  
 'The knife, the farmer is killing the chickens with.'  
 (Malagasy; Pearson 2005:389–390)

Just as in Dinka, this morphology distinguishes subjects (9a), objects (9b), and nominals ordinarily introduced by prepositions (9c).<sup>5</sup> The only difference between Dinka and Malagasy is then that the relevant position is clause-final in Malagasy rather than clause-initial.

The similarity between these languages is further evident in the behavior of their voice systems in the context of movement. One of the well-known properties of Austronesian voice is that it creates restrictions on extraction. In Malagasy, for example, a nominal may only undergo relativization if the verb carries matching voice morphology (10a–c).

(10) *Extraction restrictions in Malagasy:*

- a. ny mpamboly [<sub>CP</sub> (izay) **mamono**/\***vonoina**/\***amonoana** ny akoho amin'ny  
 DET farmer c **sv.kill/ov.kill/OBLV.kill** DET chicken with-DET  
 antsy].  
 knife  
 'the farmer who is killing chickens with the knife'
- b. ny akoho [<sub>CP</sub> (izay) **vonoin'**/\***mamono**/\***amonoan'** ny mpamboly amin'ny  
 DET chicken c **ov.kill**/\***sv.kill/OBLV.kill** DET farmer with-DET  
 antsy].  
 knife  
 'the chickens which the farmer is killing with the knife'
- c. ny antsy [<sub>CP</sub> (izay) **amonoan'**/\***mamono**/\***vonoin'** ny mpamboly ny akoho].  
 DET knife c **OBLV.kill/sv.kill/ov.kill** DET farmer DET chicken  
 'the knife that the farmer is killing the chickens with'  
 (Malagasy; Pearson 2005:412–413)

As a result, subject relativization requires Subject Voice (10a), object relativization Object Voice, and relativization over an oblique Oblique Voice (10c).

The same restriction is evident in Dinka relativization, and parallel examples are given in (11a–c). As in Malagasy, the formation of a relative clause requires that the second position verb is in the voice corresponding to the grammatical function of the gap.

5. I have glossed the Malagasy examples according to my terminology for Dinka voice. Pearson (2001, 2005) describes these as *Actor Topic*, *Theme Topic*, and *Circumstantial Topic* and various other terminologies can be found in the Austronesian literature.

(11) *Extraction restrictions in Dinka:*

- a. móny [CP \_\_\_ **càm/\*céem/\*céemè** cuïin nè páal]  
man.cs **eat.sv/eat.ov/eat.oblv** food P knife  
'the man who is eating food with a knife'
- b. cuïin [CP \_\_\_ **céem/\*càm/\*céemè** môc nè páal]  
food **eat.ov/eat.sv/eat.oblv** man.gen P knife  
'the food that the man is eating with a knife'
- c. páal [CP \_\_\_ **céemè/\*càm/\*céem** môc cuïin]  
knife **eat.oblv/eat.sv/eat.ov** man.gen food  
'the knife that the man is eating food with'

This restriction is found with all movement to the left periphery in Dinka, as is often the case in Austronesian languages also.

Another similarity with Austronesian systems is the fact that voice has repercussions for case, creating case alternations across voices (Andersen 1991, 2002). For Dinka, I will argue that this reflects case assignment at Spec-CP.<sup>6</sup> As mentioned above, clause-initial phrases are necessarily nominals in the absolutive case. The examples in (12a–c) again show that the initial DP is always in the same form, regardless of grammatical function.

(12) *Initial nominal always absolutive regardless of grammatical function:*

- a. **Páal** à-bé dhuòoj.  
**knife** 3s-prf.sv break.inch.nf  
'The knife will break.'
- b. **Páal** à-bji Ból dhòoj.  
**knife** 3s-prf.ov Bol.gen break.nf  
'The knife, Bol will break.'
- c. **Páal** à-béné Áyèn cuïin câam.  
**knife** 3s-prf.oblv Ayen.gen food eat.nf  
'With a knife, Ayen will eat food.'

As in many Austronesian languages, this gives rise to case alternations. Subjects are in the unmarked or absolutive case when clause-initial (13a), like all nominals in that position. In all other voices, however, subjects are marked with genitive case (13b), otherwise found with possessors.

(13) *Case marking on subjects varies with voice:*

- a. **Áyèn** à-càm cuïin nè páal.  
**Ayen** 3s-eat.sv food P knife  
'Ayen is eating food with a knife.'

---

6. See also Chapter 4 (sec. 3).

- b. Cuñin à-céem **Áyèn** nè pǎal.  
 food 3s-eat.ov **Ayen.GEN** P knife  
 ‘Food, Ayen is eating with a knife.’

A similar alternation for subjects between an oblique and unmarked case is found in many Austronesian languages. In Tagalog and Atayal, for example, subjects undergo the same case alternation among voices, as in the examples in (14a–b) and (15a–b).

(14) *Case alternation with subjects in Tagalog:*

- a. Bumili **ang lalaki** ng bigas  
 sv-bought cs **man** GEN rice  
 ‘The man bought rice.’
- b. Binili **ng lalaki** ang bigas  
 ov-bought GEN **man** cs rice  
 ‘A man bought the rice.’  
 (adapted from Richards 2000:105)

(15) *Case alternation with subjects in Atayal:*

- a. M-anìq qulìh qu’ **Tali**.  
 sv-eat fish QU **Tali**  
 ‘Tali eats fish.’
- b. Niq-un **na’ Tali**’ qu’ qulìh qasa.  
 eat-ov GEN **Tali** QU fish that  
 ‘Tali ate the fish.’  
 (adapted from Liu 2004)

To capture this, I propose that Dinka C assigns case to the nominal that moves to Spec-CP, as discussed in detail also in Chapter 4. In accordance with this, we will see that movement to Spec-CP is always accompanied by  $\varphi$ -agreement and behaves like a mixed position for A- and  $\bar{A}$ -diagnostics.

In Chapter 4, I discuss this proposal in more detail and how movement to Spec-CP works precisely. In the rest of the chapter, I focus on the issue of how nominals that have been assigned case previously can be assigned case again at Spec-CP. I show that Dinka has several strategies that allow a nominal moving to Spec-CP to be assigned case. I claim that subjects are otherwise never case-licensed but receive an oblique case as a repair when not initial. Fronting a PP requires first removing the P layer, which I will show incorporates into the verb. I will first discuss the analysis of voice morphology in Dinka, however. Some work on Austronesian has suggested that it is voice that is responsible for differences in case relations (e.g. Aldridge 2004, 2008, 2012; Legate 2014). As I will show in the next section, the effects of voice and case can be dissociated in Dinka. Instead, I suggest treating Dinka voice as analogous to subject vs. non-subject extraction marking.

### 2.3 On the treatment of Dinka voice<sup>7</sup>

Many languages morphologically mark the distinction between subject and non-subject extraction in some fashion. In English, for instance, *wh*-movement of non-subjects is marked with *do*-support (16a–b). Another example is the French *que/qui* alternation (17a–b). The Sudanese language Moro signals non-subject movement with the *wh*-complementizer *nə* (18a–b), which undergoes optional doubling (Rose et al. 2014).

(16) **English T-to-C movement:**

- a. Who **did** Alex see?
- b. Who saw Alex?

(17) **French *que/qui* alternation:**

- a. Qui penses-tu [**que** Marie a rencontré]?  
who think-you that Marie has met  
'Who do you think Marie has met?'
- b. Qui penses-tu [**qui** a rencontré Marie]?  
who think-you that has met Marie  
'Who do you think has met Marie?'

(18) **Moro *wh*-concord:**

- a. ɲwədʒeki **nə**-Kuku **nə**-gətaðoŋo?  
who **wH**-Kuku **wH**-abandon  
'Who did Kuku abandon?'
  - b. ɲwədʒeki gətaðo Kuku?  
who abandon Kuku  
'Who abandoned Kuku?'
- (Rose et al. 2014)

In this section and the next, I argue that the distinction between Subject Voice and Object Voice in Dinka is a form of subject vs. non-subject extraction marking also. We will see first of all that the Oblique Voice contains the Object Voice within it, so that there is a basic opposition between Subject and Object Voice along the same lines as the processes exemplified above. In support of the idea that voice in Dinka is extraction marking, I show that voice in Dinka is dissociable from case licensing in contexts without movement. With this picture in place, I turn to the distribution of Oblique Voice, which I argue is established by a process of preposition incorporation that turns a PP into a nominal.

---

7. Some of the facts and conclusions in this section were earlier reported in joint work with Michael Y. Erlewine and Theodore Levin (Erlewine, Levin, and Van Urk, to appear).

The opposition between Subject Voice and Object Voice is at the core of the Dinka voice system. We can see this transparently with verbs. Consider, for instance, the forms of *câam* ('eat') (19a–c).

(19) *Voice morphology on câam:*

- a. Àyén à-càm cuïin nè pǎal.  
Ayen 3s-eat.sv food P knife  
'Ayen is eating food with a knife.'
- b. Cuïin à-céem Áyèn nè pǎal.  
food 3s-eat.ov Ayen.GEN P knife  
'Food, Ayen is eating with a knife.'
- c. Pǎal à-céemè Áyèn cuïin.  
knife 3s-eat.oblv Ayen.GEN food  
'With a knife, Ayen is eating food.'

As Andersen (1993) argues, the Subject Voice is the unmarked form. It has a shorter vowel than the non-finite form and, with verbs, is usually marked with a low tone.<sup>8</sup> The Object Voice is indicated with a longer vowel, a high tone and sometimes with vowel raising.<sup>9</sup> As evident in (19c), the Oblique Voice is formed by means of the suffix *-è* on the Object Voice stem.

At first glance, it appears that a different pattern is found with auxiliaries. The voice forms of the perfect auxiliary *cé* are given in (20a–c).

(20) *Voice morphology on cé:*

- a. Àyén à-cé cuïin câam nè pǎal.  
Ayen 3s-PRE.sv food eat.nf P knife  
'Ayen has eaten food with a knife.'
- b. Cuïin à-cíi Áyèn câam nè pǎal.  
food 3s-PRE.ov Ayen.GEN eat.nf P knife  
'Food, Ayen has eaten with a knife.'
- c. Pǎal à-cénè Áyèn cuïin câam.  
knife 3s-PRE.oblv Ayen.GEN food eat.nf  
'With a knife, Ayen has eaten food.'

There is again an opposition between Subject and Object Voice, in which Object Voice is marked with a longer vowel as well as vowel raising. But, with auxiliaries, the Oblique Voice appears to be signalled with the suffix *-nè* attaching to the Subject Voice form. I suggest that this difference between verbs and auxiliaries is only apparent, so that Oblique Voice always contains the Object

8. The only exception to this is with benefactive ditransitives, which have a falling tone (Andersen 1994).

9. For verbs, the rule is that, if the non-finite form contains the low vowel *a*, Object Voice is formed by vowel raising, usually to *ɛ* but also to *e* in contexts in which *ɛ* is not permitted. See Andersen (1993:9–10). One way of thinking about this is to say that Object Voice involves a floating [-low] feature.

Voice within it. To be precise, I posit a PF constraint on Dinka voice that bans the co-occurrence of Object Voice and the Oblique Voice suffix on auxiliaries (21).

(21) ***PF Constraint on Oblique Voice:***

\*Aux<sub>OV</sub>+Oblique Voice

To obey this PF constraint, Dinka Bor either converts the Object Voice form of an auxiliary into a Subject Voice one, giving rise to the Oblique Voice form in (20c), or it deletes the Oblique Voice suffix. As a result, the Oblique Voice form *cɛ̃nɛ̃* alternates with the Object Voice form *cɛ̃i* in clauses like (20c). This alternation is illustrated in (22a–b), and has no apparent effect on meaning.<sup>10</sup>

(22) ***Oblique Voice clauses allow Object Voice on auxiliaries:***

- a. Páal à-*cɛ̃nɛ̃* Áyèn cụịn cáam.  
knife 3s-**PRF.OBLV** Ayen.GEN food eat.NF  
'With a knife, Ayen has eaten food.'
- b. Páal à-*cɛ̃i* Áyèn cụịn cáam.  
knife 3s-**PRF.OV** Ayen.GEN food eat.NF  
'With a knife, Ayen has eaten food.'

In support of the idea that this variation is driven by the PF constraint in (21), observe that such an alternation is not possible with verbs (23a–b).

(23) ***No variation in Oblique Voice marking with verbs:***

- a. Páal à-*cɛ̃ɛmɛ̃* Áyèn cụịn.  
knife 3s-**eat.OBLV** Ayen.GEN food  
'With a knife, Ayen is eating food.'
- b. \*Páal à-*cɛ̃ɛm* Áyèn cụịn.  
knife 3s-**eat.OV** Ayen.GEN food  
'With a knife, Ayen is eating food.'

This makes sense if the PF constraint I posit is specific to auxiliaries. I propose then that the syntax of the Oblique Voice always involves the Object Voice with the addition of the suffix *-ɛ̃/-nɛ̃* (depending on whether the stem ends in a vowel or a consonant). I present an analysis of this suffix later in this chapter, setting it aside for now.

The relevant observation for now is that this means that there is a basic opposition between Subject Voice and Object Voice that is at the core of the Dinka voice system. This distinction falls along the same lines as subject vs. non-subject extraction marking in languages without voice. For example, long-distance movement, regardless of whether it is of a subject or object, is accompanied with Object Voice marking at the landing site (24a–b).

10. As we will see later in this chapter, examples like (22b) behave syntactically like Oblique Voice clauses.

(24) *Long-distance movement marked with Object Voice:*

- a. Kôc-kè áa-cíi Ból ké yôok [CP kè nhiàr \_\_\_ Àyén].  
people-these 3P-**PRE.OV** Bol.GEN 3PL find.out.NF c love.sv Ayen  
'These people, Bol has found out love Ayen.'
- b. Àyén à-cíi Ból yôok [CP kè nhiéer kôc-kè \_\_\_].  
Ayen 3S-**PRE.OV** Bol.GEN find.out.NF c love.ov people-these  
'Ayen, Bol has found out that these people love.'

At the same time, though, the distinction between Subject and Object Voice in Dinka has ramifications for case, unlike, for example, *do*-support in English. As mentioned previously, the nominal referenced by voice is in the unmarked absolutive case, resulting in case alternations. In particular, case marking on the subject is genitive otherwise (25a–b).

(25) *Case alternations with voice*

- a. Àyén à-cám cujìn nẹ pǎal.  
Ayen 3S-eat.sv food P knife  
'Ayen is eating food with a knife.'
- b. Cujìn à-céem Àyén nẹ pǎal.  
food 3S-eat.ov Ayen.GEN P knife  
'Food, Ayen is eating with a knife.'

This consequence for case seems problematic for a syntax in which Subject and Object Voice reflect extraction marking. In the next section, however, I will demonstrate that the mechanisms behind voice morphology can be shown to be independent of the mechanisms responsible for case.

#### 2.4 *Voice is independent of case*

One prominent view of voice morphology in Austronesian is that it reflects differences in the featural make-up of case-assigning heads, which drive case alternations (e.g. Aldridge 2004, 2008; Legate 2014). In this type of approach, genitive is often equated with ergative, for example, assigned by *v*. In this section, we will see that case marking throughout the clause is independent of voice. As noted previously, there are syntactic environments in Dinka in which V1 order is possible, and where no phrase overtly moves to Spec-CP. In these contexts, subjects surface as genitive, but the clause is marked with Subject Voice. This provides evidence that Object Voice does not reflect the presence of a genitive case assigner.

As in many V2 languages, there is a set of syntactic environments in Dinka in which V2 does not appear. In these environments, Dinka's underlying verb-initial order surfaces.<sup>11</sup> This V1 pattern is found obligatorily in *yes-no* questions and optionally in *wh*-in situ questions or after

11. Verb-initial order is common throughout Nilotic (e.g. Dimmendaal 2005: sec. 2).

some complementizers, like the finite complementizer *è*. All three environments involve full finite clauses, but differ from matrix finite declarative clauses in allowing V1 order (26a–c).

(26) *V1 order in yes-no and in situ questions and embedded clauses:*

- a. Cé Áyèn cujìn câam?  
 PRF.SV Ayen.GEN food eat.NF  
 ‘Has Ayen eaten the food?’
- b. Cám Bòl ηó?  
 eat.sv Bol.GEN what  
 ‘What is Bol eating?’
- c. À-yùukù luèel [è cé Áyèn cujìn câam].  
 3S-HAB.1PL say.NF C PRF.SV Ayen.GEN food eat.NF  
 ‘We say that Ayen has eaten the food.’

I propose that the V1 order arises because these clauses are headed by a C that does not require V2.<sup>12</sup> Observe now that such clauses display a *mismatch* of case and voice. Subjects are necessarily genitive, as in Object Voice and Oblique Voice clauses, but the initial verb/auxiliary displays Subject Voice morphology.<sup>13</sup> This mismatch is surprising under an analysis in which voice is responsible for case. If we take Object Voice/Oblique Voice morphology to reflect the presence of a functional head that assigns genitive to the subject, genitive subjects should not be able to surface in the absence of this morphology. It should not matter whether V2 is possible, since these clauses are big enough to host the requisite argument structure alternations. Instead, I propose that Subject Voice is simply the default, in the same way that marking for subject extraction is zero in many languages (such as in the English and Moro examples at the beginning of this section). If voice morphology is a by-product of extraction, the default is what we expect to see in environments without movement. This also fits well with Andersen’s (1993, 2007) conclusion, on the basis of the morphophonology of voice, that Subject Voice is the unmarked voice.

The V1 environments described above can also be used to probe the question of whether genitive case in Dinka has the distribution of ergative. In V1 contexts, we can see that the genitive case on in situ subjects shows no sensitivity to semantic properties of the verb, such as transitivity and unaccusativity. In a *yes-no* question, for example, genitive case appears on in situ subjects in unaccusatives (27a), unergatives (27b), and antipassives (27c).

(27) *Genitive case found with all verbs in V1 clauses:*

- a. Bè lèc dhuòoj?  
 FUT.SV stick.GEN break.NF  
 ‘Will the stick break?’

12. Another option is that some of the constructions involve silent operators that satisfy V2 but do not participate in the voice system, either because they are not nominal in nature or because they are base-generated in the left periphery and so have not undergone movement.

13. See also Andersen 1994:14.



- b. Thét Ból?  
 cook.SV Bol.GEN  
 'Is Bol cooking?'
- c. Bè Ból càam (è cuïin)?  
 FUT.SV Bol.GEN eat.AP.NF P food  
 'Will Bol eat food?'

This pattern is surprising if genitive is ergative, because it reveals that genitive obeys a nominative-accusative alignment and not an ergative one.

In addition to this, we can show that voice morphology is not responsible for case marking in other domains of the clause. Objects, when not fronted to clause-initial position, appear in the absolutive case in a position at the left edge of the verb phrase, as discussed in detail in section 3. We can see this in examples like (28), for instance.

(28) *In situ objects appear in absolutive at verb phrase edge:*

- Àyén à-cé [vP cuïin càam [PP nè páal]].  
 Ayen 3S-PREF.SV food eat.NF P knife  
 'Ayen has eaten food with a knife.'

We can demonstrate that the distribution of voice morphology is dissociable from this process of object licensing. We see this, for example, in clauses with long-distance movement. Recall that long-distance movement triggers Object Voice in the higher clause (29a). This does not affect the ability to license local objects (29b).

(29) *Object Voice clauses created by long-distance movement allow object licensing:*

- a. Kôc-kè áa-cíi Ból ké yôk [CP kè nhiàr \_\_\_ Àyén].  
 people-these 3P-PREF.OV Bol.GEN 3PL find.OUT.NF c love.SV Ayen  
 'These people, Bol has found out love Ayen.'
- b. Yè ηó [CP cíi Ból [vP Àyén lûuk [CP è bè \_\_\_ ηóoc]]]?  
 be what PREF.OV Bol.GEN Ayen persuade.NF c FUT.3SG buy.NF  
 'What has Bol persuaded Ayen to buy?'

If Subject Voice reflected *v*'s ability to assign case to the object, Object Voice should not co-occur with licensing of an in situ object in this way. In further support of this, I will show in Chapter 5 that objects that move to Spec-CP in the Object Voice transit through Spec-*v*P and behave like they are assigned case there, suggesting that the syntax of the *v*P is invariant across different voices.

Taken together, the facts discussed here demonstrate that there is no pattern of case marking in Dinka that correlates with voice morphology. Objects move to the same licensing position in the verb phrase regardless of voice. The genitive case on in situ subjects does not correlate with voice morphology. Finally, the case marking that appears on initial DPs, which I suggested above is also case assignment, is found in all voices, and does not reveal properties of any particular voice either.

The consequence of this is that the distribution of Subject and Object Voice in Dinka cannot be said to be any different from the cases of subject vs. non-subject extraction marking discussed at the beginning of section 2.2. On this basis, I propose that the Object Voice signals non-subject extraction marking in the same way that *do*-support does in English. I will not offer a specific proposal of the syntax of extraction marking, though see Pesetsky and Torrego (2001) and Erlewine (to appear) for some possibilities.

## 2.5 *The syntax of Oblique Voice clauses*

I now turn to Oblique Voice clauses. We saw above that such clauses involve movement of an oblique/adjunct to clause-initial position, and the suffix *-ɛ̄/-nɛ̄* on an Object Voice stem. I argue here that this suffix is the result of preposition incorporation, so that the nominal that is the complement of P can move to Spec-CP as a nominal and receive case.

The Oblique Voice appears when a nominal that is ordinarily contained within a PP moves to clause-initial position. The examples in (30a–c) demonstrate for the instrumental PP *nɛ̄ pǎal* ('with a knife'). The nominal complement of the preposition *nɛ̄* may move to Spec-CP, surfacing in the unmarked absolutive case. The preposition *nɛ̄* is omitted and the suffix *-ɛ̄* or *-nɛ̄* appears on the second position verb/auxiliary (30b–c).

### (30) *Oblique Voice with instrumental PP:*

- a. Àyén à-càm cuḷin **nɛ̄ pǎal**.  
Ayen 3s-eat.sv food P **knife**  
'Ayen is eating food with a knife.'
- b. Pǎal à-céem-**ɛ̄** Áyèn cuḷin.  
knife 3s-**eat.OBLV** Ayen.GEN food  
'With a knife, Ayen is eating food.'
- c. Pǎal à-cé-**nɛ̄** Áyèn cuḷin câam.  
knife 3s-**PRF.OBLV** Ayen.GEN food eat.NF  
'With a knife, Ayen has eaten food.'

The two allomorphs of the Oblique Voice suffix, *-nɛ̄* and *-ɛ̄*, are identical to the two allomorphs of the in situ preposition. As the examples in (31a–b) show, both *ɛ̄* and *nɛ̄* may head instrumental PPs, apparently without difference in meaning.

### (31) *Variation in form of instrumental P:*

- a. Àyén à-càm cuḷin **nɛ̄ pǎal**.  
Ayen 3s-eat.sv food P **knife**  
'Ayen is eating food with a knife.'
- b. Àyén à-càm cuḷin **ɛ̄ pǎal**.  
Ayen 3s-eat.sv food P **knife**  
'Ayen is eating food with a knife.'

The preposition *ɛ̃/nɛ̃* is Dinka's default preposition and it occurs in a wide variety of contexts. As (32a–b) show, it can serve as a directional preposition. In this context too, the complement can be promoted to Spec-CP in an Oblique Voice clause (32c).

(32) *Oblique Voice with directional preposition:*

- a. ʋɔ̃k áa-kàt ɛ̃ jɔ̃.  
cows 3P-run.SV P dog  
'The cows are running from the dog.'
- b. ʋɔ̃k áa-kàt nɛ̃ jɔ̃.  
cows 3P-run.SV P dog  
'The cows are running from the dog.'
- c. Jɔ̃ à-kéet-ɛ̃ ʋɔ̃k.  
dog 3s-run.OBLV COWS.GEN  
'The dog, the cows are running from.'

We see the same preposition used to mean *about* in (33a–b).

(33) *Oblique voice with about:*

- a. Bòl à-cé jáam nɛ̃ ákékòol.  
Bol 3s-PRE.SV talk.NF P story  
'Bol has talked about the story.'
- b. Ákékòol à-cé-nɛ̃ Bòl jáam.  
story 3s-PRE.OBLV Bol.GEN talk.NF  
'The story, Bol has talked about.'

A similar alternation is possible with temporal PPs, as in (34a–b).

(34) *Oblique Voice with temporal preposition:*

- a. Bòl à-cé Àyén t̃ĩɲ nɛ̃ ákól-ìc.  
Bol 3s-PRE.SV Ayen see.NF P afternoon-inside  
'Bol has seen Ayen at noon.'
- b. Ákól-ìc à-cé-nɛ̃ Bòl Àyén t̃ĩɲ.  
afternoon-inside 3s-PRE.OBLV Bol.GEN Ayen see.NF  
'At noon, Bol has seen Ayen.'

Another type of PP that allows formation of the Oblique Voice is the possessor PP. Such PPs can be headed by *ɛ̃* and *nɛ̃* (35a–b), and may feed formation of the Oblique Voice (35c).

(35) *Oblique voice with possessors:*

- a. Wóok cé [DP t̃ĩɲ ɛ̃ Bòl] t̃ĩɲ.  
1PL PRF.SV woman.CS P Bol.GEN see.NF  
'We have seen Bol's wife.'

- b. Wóok cé [DP tíi] nẹ̀ Ból] tíi.   
 1PL PRF.SV WOMAN.CS P Bol.GEN see.NF   
 ‘We have seen Bol’s wife.’
- c. Ból à-cẹ̀-nẹ̀ wóok tíik tíi.   
 Bol 3s-PRF.OBLV 1PL.GEN woman see.NF   
 ‘Bol, we have seen his wife.’

Possessors differ in one way from the cases we have seen so far. In situ possessors are marked with genitive case. When a possessor moves to Spec-CP in an Oblique Voice clause, however, it becomes absolutive. This demonstrates that movement to Spec-CP involves case assignment to the moved nominal, so that it appears in a different case.

Oblique Voice formation is blocked with more complex prepositions. In (36a–b), we see that the comitative preposition *kẹ̀nẹ̀* does not permit the Oblique Voice.

(36) *No Oblique Voice with comitative PP:*

- a. Ból à-thàt kẹ̀nẹ̀ Àyén.   
 Bol 3s-cook.sv with Ayen   
 ‘Bol is cooking with Ayen.’
- b. \*Àyén à-thẹ̀gr-ẹ̀ Ból.   
 Ayen 3s-cook.OBLV Bol.GEN   
 ‘Ayen, Bol is cooking with.’

Descriptively then, Oblique Voice formation involves a suffix on the verb in second position with the same allomorphs as Dinka’s default preposition and it is possible with those elements that can be introduced by this preposition.

One proposal that explains these observations is to analyze the Oblique Voice suffix as an incorporated preposition, which moves to adjoin to the second position verb/auxiliary. Because only nominals may move to Spec-CP and be assigned case there, this allows for the complement of P to move to Spec-CP.<sup>14</sup>

(37) *Derivation of Oblique Voice:*

- a. Jọ̀ à-kéet-ẹ̀ wọ̀k.   
 dog 3s-run.OBLV COWS.GEN   
 ‘The dog, the cows are running from.’

14. This is analogous to the formation of pseudopassives in English. One issue that arises is how case assignment at C is enabled by preposition incorporation exactly. I propose a case stacking analysis, as in Richards (2013) and Pesetsky (2014), subject to the condition that structural case cannot be added on top of oblique case, as argued for by Richards (2013) in detail. As a result, the oblique case marker, P, must be removed for structural absolutive case to be added to a nominal.

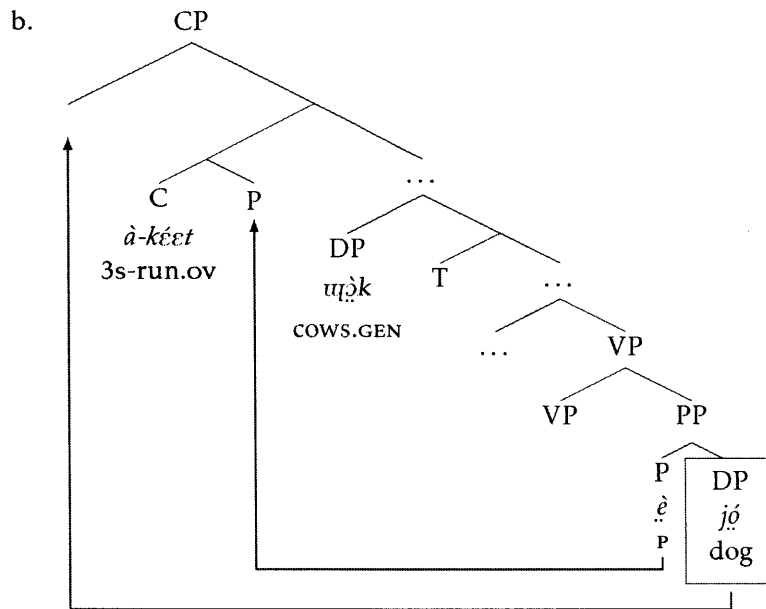

In this derivation, the P heading the directional PP moves to adjoin to the second position, C. I propose that this allows the complement DP to move to Spec-CP, which can only be occupied by nominals. It is important that this incorporation step target a higher functional projection than the verb, because the Oblique Voice suffix ends up on the highest verb/auxiliary and not necessarily on the main verb. I have posited incorporation into C in (37). In accordance with this, we will see that PPs in the Oblique Voice are still treated as PPs inside the *v*P and can never appear in object positions reserved for nominals. The above assumes that head movement can precede from a specifier or adjunct (*cf.* Travis 1984, Baker 1988).<sup>15</sup> I propose that the PP undergoes intermediate movement to Spec-*v*P first, as I show in detail in Chapter 5 (sec. 5.2).

Another possibility is that the Oblique Voice suffix reflects an applicative structure, so that it represents an Appl head that introduces an argument that is otherwise oblique as a nominal in its specifier. One problem for this is that we will see in Chapter 5 that extracted nominals in the Oblique Voice behave for the purposes of intermediate movement as if they are inside the *v*P, yet they do not behave like other nominals in this domain. The second reason why an applicative structure might be undesirable is that the Oblique Voice also surfaces in resumptive contexts. Dinka makes use of resumption with topicalization and relativization of PPs. In such constructions, the Oblique Voice is used. We see this for an instrumental PP in (38a) and a possessor in (38b).

(38) *Oblique Voice appears with resumption:*

- a. Páal à-céem-è Áyèn cuḡin nḡ yēen.  
 knife 3s-eat.OBLV Ayen.GEN food P 3SG  
 'With a knife, Ayen is eating food.'

15. Uriagereka (1988, 1995) documents instances of determiner incorporation in Galician in a comparable configuration.

- b. Bòl à-cé-nè wòók tiéεη-dè t̩iŋ.  
 Bol 3s-PRE.OBLV 1PL.GEN woman-SG.3SG see.NF  
 ‘Bol, we have seen his wife.’

This seems to suggest that the base position of the nominal in Spec-CP in an Oblique Voice clause is not in the specifier of an applicative head, but is just wherever the PP is ordinarily merged.<sup>16</sup>

The same lesson emerges from Dinka’s two locative cases, the allative and the essive (described in detail in Andersen 2012). These are marked with changes to the noun root, for example to mark a goal argument in (39a). When topicalizing such phrases, the resumptive proform *th̩in* is usually required and the clause is in the Oblique Voice (39b).

(39) *Oblique Voice with allative goal:*

- a. Bòl à-cé wòók tuòc uḡot.  
 Bol 3s-PRE.SV 1PL send.NF house.ALL  
 ‘Bol has sent us to the house.’
- b. uḡot à-cé-nè Bòl wòók tuòc th̩in.  
 house 3s-PRE.OBLV Bol.GEN 1PL send.NF in.it.ALL  
 ‘The house, Bol has sent us to.’

This shows clearly that the base position of such nominals is an oblique position, which may be marked with an oblique case.

It should be apparent that both an applicative analysis and a preposition incorporation story have their advantages and drawbacks. An applicative analysis suggests that the nominal in Spec-CP should be a nominal inside the verb phrase as well, which does not appear to be true. Under a preposition incorporation account, however, we need to posit an unusual head movement step. I adopt the preposition incorporation analysis here, which I will assume accompanies movement to Spec-CP in the Oblique Voice in the remainder of this dissertation, though nothing crucial hinges on this choice. What is important is only that the P layer of an oblique argument is removed by some syntactic mechanism, allowing for such nominals to be assigned case at Spec-CP.

### 3 The Dinka middle field and right periphery

In this section, I discuss the Dinka middle field and right periphery, with a focus on the middle field. The word order template given in the previous section is repeated in (40).

(40) *Dinka word order template:*

Topic	Finite Aux/Verb	Subject	Object1	Nonfinite Aux/Verb	Object2	Adjuncts
Left periphery		Middle field		Right periphery		

16. Under an incorporation story, we could potentially view these constructions as spell out of a lower copy.

As (40) makes clear, the middle field consists of two positions, one for in situ subjects and one for in situ objects. I first show that Dinka displays a V2 effect in the verb phrase, so that the highest DP must move to Spec-*v*P, the middle field object position in (40). I argue that these objects can be assigned case again at Spec-CP when they move there, because the same structural case is assigned in both places. I then examine the position of in situ subjects, which always appear in the genitive case, and the resulting case alternation. Similar “marked nominative” alternations are found in a number of related languages (e.g. Dixon 1979; König 2008). I offer an account according to which genitive reflects a repair, which licenses subjects not in a structural case position (see also Halpert 2012 and Imanishi 2014).

### 3.1 V2 in the verb phrase

In this section, I examine the left edge of the Dinka verb phrase. A V2 effect is found at the edge of transitive verb phrases, so that the first XP in the verb phrase must be a DP in the absolutive case. I propose that this reflects leftward movement of an object to Spec-*v*P for case licensing.

The edge of the verb phrase can be diagnosed by the position of a main verb in a clause that contains auxiliaries, as the examples in (41a–b) demonstrate. In (41a), the auxiliary *bé* is the highest verb/auxiliary and so it moves up to C. The verb *t̥i̯i̯ŋ* (‘see’) is therefore in its base position. Observe now that the main verb must be preceded by the nominal object (41b).

(41) **Direct object must precede in situ main verb:**

- a. *Y̥i̯i̯n bé* [<sub>vP</sub> *m̥i̯i̯r t̥i̯i̯ŋ*].  
 YOU FUT.SV giraffe see.NF  
 ‘You will see a giraffe.’
- b. \**Y̥i̯i̯n bé* [<sub>vP</sub> \_\_\_ *t̥i̯i̯ŋ m̥i̯i̯r*].  
 YOU FUT.SV see.NF giraffe  
 ‘You will see a giraffe.’

Any other material in the verb phrase, including adjuncts or adverbs, must appear finally, following the main verb, and cannot occur either before the in situ main verb or before the object. The examples in (42a–c) illustrate this for an instrumental PP and the examples in (43a–c) for a temporal adverb.

(42) **PPs cannot appear at edge of *v*P:**

- a. *Àyén à-cé* [<sub>vP</sub> *cu̯i̯i̯n cáam* [<sub>PP</sub> *nè p̥áal*]].  
 Ayen 3S-PRF.SV food eat.NF P knife  
 ‘Ayen has eaten food with a knife.’
- b. \**Àyén à-cé* [<sub>vP</sub> *cu̯i̯i̯n* [<sub>PP</sub> *nè p̥áal*] *cáam*].  
 Ayen 3S-PRF.SV food P knife eat.NF  
 ‘Ayen has eaten food with a knife.’

- c. \*Àyén à-cé [vP [PP **nè pǎal**] cuḡin câam].  
 Ayen 3s-PRF.SV P **knife** food eat.NF  
 'Ayen has eaten food with a knife.'

(43) *Adverbs cannot appear at edge of vP:*

- a. Àyén à-cé [vP cuḡin câam **ákól**].  
 Ayen 3s-PRF.SV food eat.NF **afternoon**  
 'Ayen has eaten food in the afternoon.'
- b. \*Àyén à-cé [vP cuḡin **ákól** câam].  
 Ayen 3s-PRF.SV food **afternoon** eat.NF  
 'Ayen has eaten food in the afternoon.'
- c. \*Àyén à-cé [vP **ákól** cuḡin câam].  
 Ayen 3s-PRF.SV **afternoon** food eat.NF  
 'Ayen has eaten food in the afternoon.'

These positioning facts also obtain when it is the main verb moves out of the verb phrase, showing that the position of the object is not dependent on the presence of the in situ verb. In such examples, the in situ object must still precede any adjunct material in the verb phrase (44a–d).

(44) *Object is vP-initial when verb moves out:*

- a. Àyén à-càm [vP cuḡin [PP **nè pǎal**]].  
 Ayen 3s-eat.sv food P **knife**  
 'Ayen is eating food with a knife.'
- b. \*Àyén à-càm [vP [PP **nè pǎal**] cuḡin].  
 Ayen 3s-eat.sv P **knife** food  
 'Ayen is eating food with a knife.'
- c. Àyén à-càm [vP cuḡin **ákól**].  
 Ayen 3s-eat.sv food **afternoon**  
 'Ayen is eating food in the afternoon.'
- d. \*Àyén à-càm [vP **ákól** cuḡin].  
 Ayen 3s-eat.sv **afternoon** food  
 'Ayen is eating food in the afternoon.'

These facts demonstrate that the object is always at the edge of the vP, regardless of whether the verb undergoes movement. We will see evidence for this throughout. The syntax of the vP edge is insensitive to verb movement.

I suggest that the position the direct object occupies is Spec-vP, because it is found at the edge of the verbal domain and is used to license objects (e.g. Wurmbrand 1998). We will also see in Chapter 5 that is the landing site of intermediate successive-cyclic movement, a property commonly ascribed to Spec-vP (e.g. Chomsky 1986 et seq.). I propose then that, in Dinka, the object of a transitive verb always moves to Spec-vP, in order to check case. I posit a  $\varphi$ -probe on *v*,



which triggers this movement and is responsible for assigning absolutive case to the object. As in the rest of this work, I treat the EPP property of  $v$  as a subfeature of the  $\varphi$ -probe. In this view, the structure of the verb phrase in an example like (45a) is (45b). The object of  $V$  moves to a specifier of  $v$  as a reflex of Agree with  $v$ , and the verb moves up to  $v$  (from which it undergoes subsequent movement if there is no auxiliary present).

(45) **Structure of transitive verb phrase:**

- a. Bòl à-cé [vP cuḡin câam].  
 Bol 3S-PRF.SV food eat.NF  
 'Bol has eaten food.'

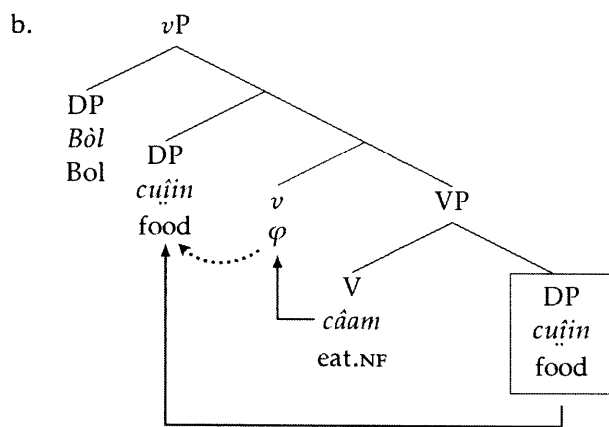

The tree in (45b) assumes that the subject is generated in the outer specifier of  $vP$  (e.g. Chomsky 1995; Kratzer 1996; Hale and Keyser 2002), and that it is merged after the probe on  $v$  triggers movement of the object. It is important here, as it will be throughout this dissertation, that the base position of the subject does not count for the purposes of satisfying the  $\varphi$ -probe on  $v$  and its EPP property. Indeed, the subject never affects the V2 property of the verb phrase. One way of capturing this is to say that  $v$  probes and triggers movement when it is merged, so that the subject is not present yet when the object moves.

An alternative approach to these facts is to decompose  $v$  into two separate heads, one that introduces the external argument and one that assigns case to the object, along the lines of Bowers (2010). I will label these Voice and  $v$  (cf. Pylkkänen 2002; Harley 2009, 2013). The Dinka verb phrase would then look like (46).

(46) **Verb phrase with decomposed vP:**

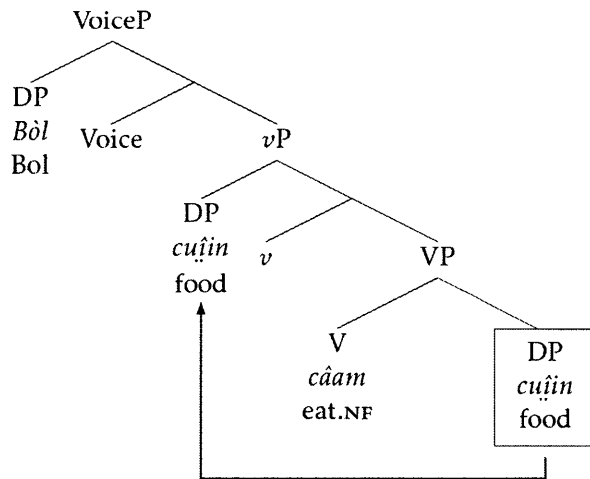

It will not matter for our purposes whether we adopt the structure in (45) or the more articulated structure in (46), as long as something exempts subjects from the calculus of V2 at Spec-*vP*. For this reason, I mostly abstract away from the base position of the subject when discussing *vP* syntax.

Let me now briefly discuss intransitives. Perhaps unsurprisingly, the V2 requirement does not affect intransitive verb phrases. Such verbs do not have a nominal object that may appear in Spec-*vP* (47a–b).

(47) **Intransitives lack V2 requirement:**

- a. Yḡin cé [vP \_\_\_\_ thàal].  
 you PRF.SV          cook.NF  
 ‘You have cooked.’
- b. Bòl à-bé [vP \_\_\_\_ lò].  
 Bol 3S-FUT.SV          go.NF  
 ‘Bol will go.’

In addition, adjuncts that appear with intransitives cannot move to Spec-*vP* as a substitute for a DP object. The examples in (48a–b) illustrate for the essive-marked adjunct *uḡòot* (‘in the house’). This adjunct has to appear after the verb cluster, just like adjuncts in transitives.<sup>17</sup>

(48) **No adjuncts before verb cluster in intransitives:**

- a. Yḡin cé [vP \_\_\_\_ thàal uḡòot].  
 you PRF.SV          cook.NF house.ESS  
 ‘You have cooked in the house.’

17. Note that the essive form *uḡòot* (‘house’) is identical to the absolutive (Andersen 2012), which I have indicated with parentheses in the gloss.

- b. \*Yiin cé [vP **uđòt** tháal].  
 you PRF.SV **house(.ESS)** COOK.NF  
 'You have cooked in the house.'

I propose that the impossibility of adjuncts moving to Spec-*vP* is due to the fact that *v* carries a  $\varphi$ -probe and only targets nominals. Importantly, the step of P-incorporation that removes the P layer of a PP targets C and so cannot facilitate such movement. This difference between transitives and intransitives demonstrate that the V2 property of the verb phrase may be violated if no nominal is present. This is reminiscent of Preminger's (2011) proposal that Agree is *fallible*, so that it is allowed to fail if no suitable goal is present. In accordance with this, we will see evidence in Chapter 5 and 6 from a process of pronoun copying that intransitive *vPs* nevertheless show evidence of a V2 property, as evident in contexts of intermediate movement.

Additional evidence for the claim the object undergoes movement comes from clauses that contain multiple auxiliaries. As Andersen (2007) points out, Dinka clauses may contain a range of auxiliary predicates. One type of example is given in (49a). In such clauses, the highest auxiliary, in this example the perfect auxiliary *cé*, moves up to C. All other auxiliaries join the lexical verb in what I will refer to as the *verb cluster*. The verb cluster, as in languages like Dutch and German, may not be interrupted by non-verbal material (49b–c).<sup>18</sup>

(49) *Clause with multiple auxiliaries contain a verb cluster:*

- a. Tiik à-cé [vP cuïin dâac tháal].  
 woman 3S-PRF.SV food do.quickly.NF COOK.NF  
 'The woman has cooked the food quickly.'
- b. Tiik à-cé [vP cuïin dâac tháal **áköl**].  
 woman 3S-PRF.SV food do.quickly.NF COOK.NF **afternoon**  
 'The woman has cooked the food quickly in the afternoon.'
- c. \*Tiik à-cé [vP cuïin dâac **áköl** tháal].  
 woman 3S-PRF.SV food do.quickly.NF **afternoon** COOK.NF  
 'The woman has cooked the food quickly in the afternoon.'

The Spec-*vP* position also cannot disturb the verb cluster. Direct objects, for instance, necessarily precede the first verb/auxiliary of the cluster, as in (49a). Other orders are ungrammatical (50a–b).

(50) *Spec-*vP* precedes verb cluster:*

- a. \*Tiik à-cé [vP \_\_\_ dâac **cuïin** tháal].  
 woman 3S-PRF.SV do.quickly.NF **food** COOK.NF  
 'The woman has cooked the food quickly.'

18. I will leave open the issue of whether there is an active process of verb cluster formation, as has been argued for Dutch and German. The structure I give for the Dinka verb phrase does not in principle require such a process, though something must prevent leftward adjunction of PPs and adverbs.

- b. \*Tiik à-cẹ́ [vP \_\_\_\_ dâac tháal cụịn].  
 woman 3s-PRE.SV do.quickly.NF COOK.NF food  
 ‘The woman has cooked the food quickly.’

Many of the auxiliary predicates that may appear in the verb cluster come from the class of predicates that Andersen (2007) refers to as “secondary auxiliaries”. These are predicates like *dâac* (‘do quickly’) or *pyâac* (‘have done recently’), which plausibly express meanings associated with *vP/VP*-adverbs in English. Andersen (2007:100, sec. 5) provides a detailed overview. These behave like auxiliaries in Dinka. They move to C and host voice morphology when the highest auxiliary in the clause, for instance (51a–b).

(51) *Secondary auxiliaries may appear in V2:*

- a. Bòl à-dòc cụịn câam.  
 Bol 3s-**do.quickly**.sv food eat.NF  
 ‘Bol is eating food quickly.’
- b. Cụịn à-dòc Bòl câam.  
 food 3s-**do.quickly**.ov Bol.GEN eat.NF  
 ‘Food, Bol is eating quickly.’

I will not discuss the syntax and semantics of these secondary auxiliaries in detail here, but there are at least two ways of treating them that are compatible with what I say here. The first is to analyze these secondary auxiliaries as realizations of functional heads in between V and *v*, assuming a more articulated verb phrase, along the lines of Cinque (1999). Another approach is to treat clauses with secondary auxiliaries as a type of serial verb construction, with multiple VPs. Both options are compatible with the idea that the object position described above is Spec-*vP*.

In accordance with this view of the verb phrase, we see that tense and aspectual material for the most part cannot appear in the verb cluster. As Andersen (2007) observes, neither the past tense particle nor the perfect auxiliary *cẹ́* ever show up in the verb cluster. One exception to this, however, is the future auxiliary *bẹ́*.<sup>19</sup> This auxiliary can appear in the verb cluster, such as in clauses with the negative auxiliary (52a).<sup>20</sup> In such clauses, the object must still precede the verb cluster (52b).

(52) *Future auxiliary may appear in verb cluster:*

- a. Ỵịn cẹ́ [vP ṃịr bẹ́ ṭịn].<sup>21</sup>  
 you NEG giraffe FUT see.NF  
 ‘You will not see a giraffe.’
- b. \*Ỵịn cẹ́ [vP bẹ́ ṃịr ṭịn].  
 you NEG FUT giraffe see.NF  
 ‘You will not see a giraffe.’

19. See also Andersen (2007:sec. 3) for discussion of the habitual auxiliary.

20. The perfect auxiliary has a suppletive negative form (Andersen 2007:95) and so never appears lower than C.

This seems problematic for the claim that the position of the object in (52a) is Spec-*vP*, given that future should be expressed in a higher position in the clause. There is good reason to think, however, that *bé* is more similar to a verbal future like the English *going-to* construction than a true future tense. First of all, Andersen (2007:98) points out that the future auxiliary has its source in a motion verb, the verb *bò* ('come').<sup>22</sup> In addition, its distribution is very different from Dinka's other tense marking, the past tense particle *é*. Past tense is typically encoded as a part of the declarative or interrogative particle, a prefix that appears on the verb/auxiliary in C. This particle then appears higher than any of Dinka's other auxiliaries, including the negative auxiliary *cé* and the perfect.

In contrast, the future auxiliary *bé* appears lower than the negative auxiliary, as in (52a), and cannot appear above the perfect auxiliary *cé*. This is demonstrated in (53a). When the perfect and future co-occur, the perfect appears above the future and the future is interpreted as its motion verb source (53b).

(53) **Future cannot appear above perfect:**

- a. \*Yïin bé mîir cé tîiŋ.  
 2SG FUT.SV giraffe PRF SEE.NF  
 Intended: 'You will have seen the giraffe.'
- b. Yïin cé mîir bé tîiŋ.  
 2SG PRF.SV giraffe FUT SEE.NF  
 'You have come to see the giraffe.'

These facts make it clear that the future auxiliary *bé* is not a true instantiation of T. Instead, I will treat it as a *vP*-internal head, in line with the observation that it can appear below Spec-*vP*. Specifically, I propose that *bé* is a restructuring verb that takes the lexical VP as its complement, similar to the *going-to* future in English. In this view, the structure of the verb phrase in an example like (52a), repeated in (54a), is really something like (54b), with movement of object of the main verb into Spec-*vP*.<sup>23</sup>

(54) **Structure of verb phrase with *bé*:**

- a. Yïin cè [<sub>vP</sub> mîir bé tîiŋ].  
 YOU NEG giraffe FUT SEE.NF  
 'You will not see a giraffe.'

21. As Andersen (2007) observes, the future auxiliary *bé* does not appear to have a non-finite form and appears in the same form as in the subject voice when it is in the verb cluster.

22. As Andersen remarks, vowel reduction to *é* may have played a part in several grammaticalization processes in Dinka.

23. There is presumably also movement of *bé* up to *v* in (54b), because *bé* would end up moving out of the verb phrase if it were the only auxiliary present.

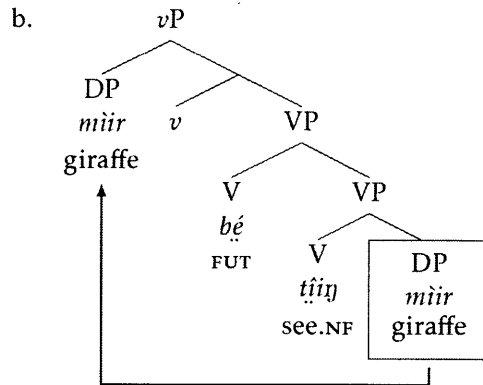

The verb cluster facts provide evidence that the surface position of transitive object is not adjacent to the verb, but reached by leftward movement. In this way, clauses with multiple auxiliaries make clear that Dinka objects obligatorily move for licensing.

We may wonder now what happens in the Object Voice, when objects appear in Spec-CP. We will see clear evidence in Chapter 5 for the claim that objects still move to Spec-*vP* in such voices, because intermediate movement to the *vP* edge satisfies V2 in a variety of contexts. As a result, I propose that objects in the Object Voice are assigned absolutive case twice, once by *v* and once by C. In the next section, I turn to the position of in situ subjects and the alternation between genitive and absolutive that occurs with them.

### 3.2 Genitive case and in situ subjects

In this section, I consider the question of what position in situ subjects appear in and how they come to be marked with genitive case. I show that genitive subjects undergo movement, but argue that this is unrelated to case assignment. Instead, I propose that subjects are not structurally licensed, but assigned case as a Last Resort repair, by the insertion of a silent preposition (*cf.* Halpert 2012; Imanishi 2014). I suggest that this proposal might make sense of the phenomenon of “marked nominative” that appears in a number of languages (e.g. König 2008).

As mentioned above, subjects can appear in the middle field, following the highest verb/auxiliary in the second position of the clause. This is true regardless of whether the verb is unaccusative, unergative, or transitive. The examples in (55a–c) demonstrate for a *yes-no* question (which displays V1 order, as discussed in the next section).

(55) **Genitive case found with all in situ subjects:**

- a. Bé l̥ɛc dhuðoŋ?  
 FUT.SV **stick.GEN** break.NF  
 ‘Will the stick break?’
- b. Thét Ból?  
 cook.sv **Bol.GEN**  
 ‘Is Bol cooking?’

- c. Bẹ́ Ból cà̀m (è̀ cù̀in)?  
 FUT.SV Bol.GEN eat.AP.NF P food  
 ‘Will Bol eat food?’
- d. Bẹ́ Áyèn kũ̀ur t̃ĩĩn?  
 FUT.SV Ayen.GEN mountain see.NF  
 ‘Will Ayen see a mountain?’

We see then that a subject in the middle field always immediately follows the highest verb/auxiliary and occurs in the genitive case, regardless of verb type.

These facts suggest that subjects move leftward to a position in the middle field, like Spec-TP. That the in situ subject position is not the base position of the subject is particularly evident with unaccusative subjects like (55a). Despite presumably being generated in the complement of V, such subjects must appear to the left of the main verb, higher also than secondary auxiliaries, for instance (56a–b).<sup>24</sup>

(56) *Unaccusative subjects appear above main verb and secondary auxiliaries:*

- a. Bẹ́ lẹ̀c dâac dhuôoŋ?  
 FUT.SV stick.GEN quickly.NF break.NF  
 ‘Will the stick break quickly?’
- b. Cẹ́ lẹ̀c bẹ́ dhuôoŋ?  
 NEG stick.GEN FUT break.NF  
 ‘Will the stick not break?’

I propose then that the subject obligatorily moves to an EPP position in the middle field, which I will identify as Spec-TP.<sup>25</sup>

The question that arises now is what exactly the nature of genitive case is. The genitive case found on subjects in the middle field is signaled by a tonal contour (see Andersen 2002 for detail and discussion). It is found elsewhere in the languages only in some prepositional phrases. To be precise, the genitive case is also assigned inside of possessor PPs (57a), and to the nominal in the *by*-phrase of a passive (57b).

(57) *Genitive case occurs in possessor PPs and by-phrases:*

- a. Wóok cẹ́ [DP t̃ĩĩn [PP è̀ Ból]] t̃ĩĩn.  
 1PL PRF.SV woman P Bol.GEN see.NF  
 ‘We have seen Bol’s wife.’

24. The fact that the subject of an unaccusative appears to move to a position outside the *v*P to be assigned genitive raises questions about whether unaccusatives have a V2 property associated with a *φ*-probe. I will assume that unaccusative *v*Ps lack a case-assigning *φ*-probe. However, as we will see in Chapter 5, there is evidence in Dinka that unaccusatives contain a *v*P phase.

25. One question that arises is how to derive Dinka’s underlying verb-initial order under this view.

- b. Cuḡin à-cám [pp nè Ból].  
 food 3s-eat.PASS P Bol.GEN  
 ‘Food is being eaten by Bol.’

The genitive case stands in opposition to Dinka’s other structural case, frequently called the absolutive in the Nilotic literature (e.g. Dimmendaal 1985, 2007), although no link with ergativity is intended. The absolutive appears on objects in Spec-*vP* (58a), as described in the previous section, on nominals in Spec-CP (58b), and inside a variety of PPs.

(58) *Absolutive in Spec-vP and clause-initial position:*

- a. Ból à-cé Àyén tḡḡ.  
 Bol 3s-PREF.SV Ayen see.NF  
 ‘Bol has seen Ayen.’  
 b. Ból à-cé Àyén tḡḡ.  
 Bol 3s-PREF.SV Ayen see.NF  
 ‘Bol has seen Ayen.’

The absolutive is the unmarked case (see also Andersen 2002): it is the citation form and also the case that appears in contexts in which we might expect to see a default case, such as on nominal predicates (59).

(59) *Absolutive appears on nominal predicates:*

- a. Ból èe bény.  
 Bol 3s.be chief  
 ‘Bol is a chief.’  
 b. Yè Ból bény?  
 be Bol.GEN chief  
 ‘Is Bol a chief?’

On the basis of these facts, Andersen (2002) concludes that the genitive should be viewed as an oblique case. This is surprising, since genitive on subjects does not pattern like ergative case, as is clear in the examination of unaccusatives, and ergative is the structural case for subjects that may display oblique-like behavior. In accordance with Andersen’s proposal, I suggest that movement to Spec-TP is purely driven by EPP and not case, and that Dinka T is inactive as a case licenser.<sup>26</sup> I posit that genitive case is assigned as a Last Resort to a caseless nominal, by insertion of a silent preposition (see also Stowell 1981, Halpert 2012, and Imanishi 2014). The derivation of an example like (60a) is then something like (60b).

---

26. We can link this to the observation that C does assign case, if we assume that the features of C-T are related (e.g. Stowell 1982; Chomsky 2008; Miyagawa 2010).



(60) *Genitive case found with all in situ subjects:*

- a. Bé lèc dhuôoŋ?  
FUT.SV stick.GEN break.NF  
'Will the stick break?'

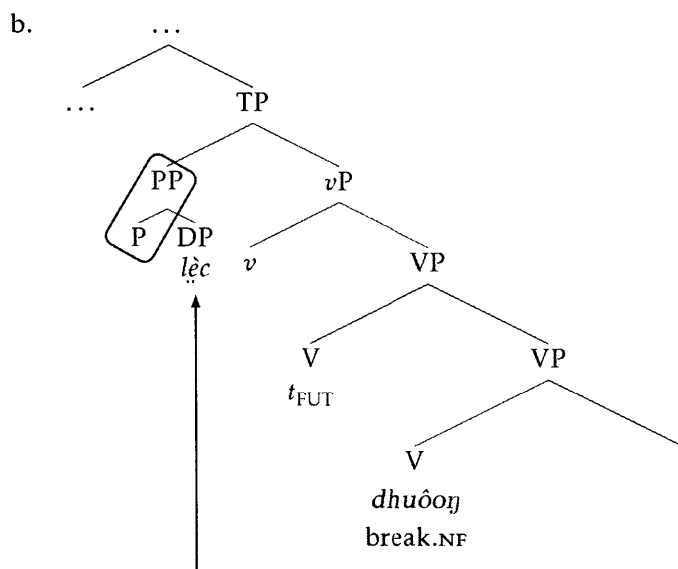

In this structure, the unaccusative subject is merged as the complement of V, which merges with the verbal future *bé*, analyzed as a restructuring verb here (as per discussion in section 3.1). The subject DP moves to Spec-TP to satisfy its EPP property. Because it is not assigned case there, a silent preposition is inserted which assigns genitive case as a Last Resort.

This view of genitive case follows Halpert (2012) in assuming that, in some languages, case morphology may be merged directly to a nominal to license it, if no other licensing strategy is available (see also Stowell 1981 and Imanishi 2014). In this approach, genitive case in Dinka functions as a type of repair. This notion is also found in work on the Person-Case Constraint. Rezac (2011) argues at length that PCC effects may be repaired by insertion of a preposition or a case layer. In French ditransitives, for example, a 1st or 2nd person direct object clitic is ungrammatical in the presence of an indirect object clitic (61a–b).

(61) *PCC holds in French ditransitives:*

- a. Je la leur ai présentée.  
I 3FS.CL 3P.CL have introduced  
'I have introduced her to them.'
- b. \*Je vous leur ai présenté.  
I 2P.CL 3P.CL have introduced  
'I have introduced you to them.'

As a repair, the indirect object may be exceptionally realized as a full PP or, for some speakers, as the locative clitic *y* (Couquaux 1975).

(62) *Indirect object may be realized as PP or locative clitic:*

- a. Je vous ai présenté à eux hier.  
I 2P.CL have introduced to them yesterday  
'I have introduced you to them.'
- b. %Je vous y ai présenté.  
I 2P.CL LOC have introduced  
'I have introduced you to them.'

Crucially, this represents a repair, because these strategies are not available when the PCC would not be violated, as the examples in (63a–b) attest.<sup>27</sup>

(63) *Repairs unavailable when PCC not violated:*

- a. \*Je l' ai présentée à eux.  
I 3FS.CL have introduced to them  
'I have introduced her to them.'
- b. \*Je la y ai présentée.  
I 3FS.CL LOC have introduced  
'I have introduced her to them.'

Rezac (2011) documents similar repairs in Chinook, Basque, and Finnish, and proposes that, in these cases, K or P structure is added as a Last Resort to license a DP.

The advantage of treating genitive case as a repair of this sort is that it explains why it looks like an oblique case. Under this view, genitive is actually strictly a *prepositional* case, assigned only within PPs. The absolutive is Dinka's true structural case. As a result, it is the case we expect to see in default contexts, like the citation form and on nominal predicates. We can also make sense of the case alternation found with subjects from this perspective: subjects either get structural case in Spec-CP or receive an oblique case as a repair. Finally, in this view of Dinka, absolutive at Spec-CP and Spec-*v*P correspond essentially to nominative and accusative.<sup>28</sup>

The analysis proposed here can provide a general account of the phenomenon of "marked nominative" across Nilotic languages. As noted by many Nilotic scholars (e.g. Creider 1989; Dimmendaal 2005, 2007; König 2006, 2008), there is a marked case for non-initial subjects which disappears under fronting in many languages in the Nilotic family. This is usually called "marked nominative" (Dixon 1979; König 2006). The examples below illustrate, drawn from Pări (Andersen 1988), Turkana (Dimmendaal 1985), and Datooga (Kiessling 2007). (Glosses for case are mine.)

27. The full PP in (63a) is acceptable if there is stress on the pronoun. Crucially, this is not necessary in (62a).

28. As in Legate's (2008) Low-Abs languages, a morphological default spells out both nominative and accusative at PF.

(64) *Subject alternates in case in Pãri:*

- a. úbúr á-pùot dháag-è  
Ubur.ABS PERF-beat woman-OBL  
'The woman beat Ubur.'
- b. dháagò ùbúr á-púod`-è  
woman.ABS Ubur.ABS PERF-beat-3SG  
'The woman beat Ubur.'
- (Andersen 1988:292,294)

(65) *Subject alternates in Turkana:*

- a. k-à-ram-i' ηesi' ayɔŋ`.  
P-1SG-beat-ASP 3SG.OBL me.ABS  
'He/she will beat me.'
- b. ηesi` ε-sak-i' a-bɛru`.  
3SG.ABS 3-look.for-ASP woman.ABS  
'He/she is looking for the woman.'
- (Dimmendaal 1985:133,136)

(66) *Subject alternates in Datooga:*

- a. gwándà gádéemgá jèedá dũgwa.  
s3-be.there women.OBL among cattle.ABS  
'The women were among the cattle.'
- b. gádéemgà gwándà jèedá dũgwa.  
women.ABS s3-be.there among cattle.ABS  
'As for the women, they were among the cattle.'
- (Kiessling 2007:71)

I suggest that these instantiate the same phenomenon: repairs to license a subject that would otherwise fail to acquire case. One major difference between most Nilotic languages and Dinka, though (evident in the Turkana and Datooga examples above, for instance), is that they are verb-initial and not V2. As a result, the (a) sentences, in which the non-initial subject appears in the oblique case, actually represent the unmarked word order. I propose then that these languages differ from Dinka in that C does not carry a  $\varphi$ -probe in clauses without  $\bar{A}$ -movement, so that there is simply no case assigner at all in the left periphery of such sentences.<sup>29</sup> As a result, the only option for subject licensing in clauses with unmarked order is to insert a silent preposition.

My proposal for "marked nominative" across Nilotic makes sense of the fact that this case always alternates with absolutive as a result of  $\bar{A}$ -movement. In addition, oblique case is found under prepositions in a number of Nilotic languages, particularly for possessors (König 2006, 2008;

29. Another option could be to say that unmarked verb-initial clauses are actually TPs, on the assumption that Dinka's V2 property forces the presence of a CP layer. This would similarly result in the absence of a case-assigning C in verb-initial clauses.

Dimmendaal 2007). In Maasai, strikingly, the complement of the only preposition *t-* is always in the oblique case (Koopman 2005). Moreover, Dimmendaal (2007) argues at length that “marked nominative” marking across these languages has its historical origins in genitive and instrumental marking, which fits well with the claim that these are actually PPs. Finally, we see these facts also in “marked nominative” languages outside of Nilotic. Many Berber languages show the case alternation, for example, and, across these languages, oblique case is found with prepositions also (König 2006). Ahland (2012) notes the morphophonological similarity between “marked nominative” and the preposition series in Gumuz dialects.

What should be clear in any case is that the alternation between an unmarked case initially and an oblique case like genitive for non-initial subjects is independent of voice morphology, as many of the languages described above lack a system analogous to voice. If a different mechanism lies behind these alternations, it should also work for Dinka. One possible alternative is to view “marked nominative” or genitive simply as a nominative, assigned at Spec-TP, and allow for languages to treat nominative case as a marked structural case. In this, C, T, and *v* all function as case assigners in Dinka. The advantage of such a proposal is that it explains why subjects undergo leftward movement. In addition, this proposal does not explain the case alternation that characteristically accompanies the presence of a “marked nominative” case. It is unclear why such a case should disappear under fronting in so many languages if it represents a structural nominative.

#### 4 Summary

In this chapter, I provided an overview of the basic clause structure of Dinka. I demonstrated that voice morphology in Dinka is independent of case and reflects subject/non-subject extraction marking. In addition, we saw that there is a V2 effect both at the edge of the clause and at the edge of the verb phrase. Because this V2 effect requires nominals in the absolutive case specifically, I proposed that C and *v* function as case assigners in Dinka. I then showed how the Dinka case system allows nominals of various grammatical functions to participate in the case alternations that this renders necessary: in the case of obliques, via preposition incorporation, and in the case of subjects, by means of a repair that assigns genitive case to a caseless subjects.

## CHAPTER FOUR

### THE A/ $\bar{A}$ -DISTINCTION IN DINKA

---

In this chapter, I examine the A/ $\bar{A}$ -distinction in the Nilotic language Dinka. I show that movement can be driven by a  $\varphi$ -probe and an  $\bar{A}$ -probe simultaneously. As a result of this, all long-distance movement in Dinka displays properties both of A- and of  $\bar{A}$ -movement. These facts demonstrate that languages need not draw a clearcut distinction between A- and  $\bar{A}$ -movement: they need not display morphosyntactic differences, target disparate positions, or be ordered in any particular way. This provides support for the main proposal of this dissertation, that differences between types of phrasal movement derive only from the Agree relation.

#### 1 Introduction

As discussed in the previous chapter, an important consequence of a featural approach to A- and  $\bar{A}$ -movement is that it in principle allows for there to be instances of phrasal movement that are driven by both types of features at the same time. If Agree can involve multiple probes acting in concert, there should be instances of movement that involve both  $\varphi$ -features and an  $\bar{A}$ -feature. If A- and  $\bar{A}$ -properties are properties of the probing feature, as argued in Chapter 2, such movements should display the benefits both of A- and of  $\bar{A}$ -movement. (*cf.* Weibelhuth 1989; Mahajan 1990).

This chapter argues that this situation is found in Dinka. We will see that, in Dinka, there is no clear distinction between A- and  $\bar{A}$ -movement. Instead, all movement, local or long-distance, targets the same syntactic positions and has the same effects on the morphosyntax, for example in its repercussions for case, agreement, binding, verb-second, and voice. I propose that this happens because the head that introduces  $\bar{A}$ -features in Dinka, C, also carries a  $\varphi$ -probe, whereas these features are distributed across different heads in a language like English (and so always operate independently). Following previous work on the interactions between multiple probes on the same head (e.g. Coon and Bale 2014), I adopt the idea that two probing features on the same head may be forced to converge on the same goal. I posit that  $\bar{A}$ -probes in Dinka always act in unison with a  $\varphi$ -probe in this fashion, resulting in the absence of a clear distinction between A- and  $\bar{A}$ -movements. Instead, as we will see,  $\bar{A}$ -movements like relativization and topicalization display a mix of A- and  $\bar{A}$ -properties. In particular, although they have the locality profile of  $\bar{A}$ -movement, relativization and topicalization can feed  $\varphi$ -agreement, case assignment, and binding, and are not subject to Weak Crossover or reconstruction for Principle C. These facts represent an independent argument for the idea that differences between movement types derive solely from the features involved in the Agree relation.

The chapter is organized as follows. In the next section, I outline the properties of two types of long-distance movement that target Spec-CP in Dinka: topicalization and relativization. At first glance, these look like typical  $\bar{A}$ -movements: they are potentially unbounded, but island-sensitive and signal changes in information structure. However, in section 3, I demonstrate that all movement types targeting Spec-CP are also driven by a  $\varphi$ -probe: movement is always associated with changes in case and agreement, affecting case and agreement relations in the rest of the clause. In accordance with this, as predicted by a featural approach, such movement behaves for the purposes of binding like A-movement, as demonstrates in section 4. I conclude from these facts that there are not necessarily radical differences between different types of phrasal movement: A- and  $\bar{A}$ -movement need not involve morphosyntactic positions, target disparate positions, or be ordered in a particular way. This follows from the idea that all differences between movement types reside in the Agree relation involved and so constitutes an argument for this approach. In section 5, I discuss a number of other languages that may have similar types of movement. I propose that the conclusions argued for here can shed light on the difficulties the A/ $\bar{A}$ -distinction runs into in many Austronesian languages (e.g. Guilfoyle, Hung, and Travis 1992; Richards 2000; Pearson 2001), as well as the effects of long-distance movement on agreement in Bantu languages.

## 2 Long-distance movement in Dinka

I will start by outlining the properties of long-distance movement. As described in the previous chapter, Dinka is a V2 language, so that Spec-CP must always be occupied. Spec-CP is occupied by the subject in the neutral order and otherwise by an  $\bar{A}$ -element, like a topic or a relative clause operator. I show that movement to the Spec-CP position has all the hallmarks of  $\bar{A}$ -movement: it may skip over intervening noun phrases and clause boundaries, is island-sensitive and allows reconstruction.

### 2.1 Topicalization and relativization

In this section, I introduce two types of long-distance movement that target the Spec-CP position in Dinka: topicalization and relativization. Some examples are given in (1a–b).

(1) *Long-distance dependencies target Spec-CP:*

- a. **Cuḡin** à-yàa      tàak      [<sub>CP</sub> kè céem Áyèn \_\_\_\_ ].  
 food 3S-HAB.1SG think.NF      c eat.OV Ayen.GEN  
 ‘The food, I think Ayen is eating.’
- b. tíŋ      [<sub>CP</sub> **Op** cíi      Ból \_\_\_\_ tíŋŋ]  
 woman                  PREF.SV Bol      see.NF  
 ‘the woman that Bol has seen’

Movement to Spec-CP is long-distance, island-sensitive, and allows reconstruction. At first glance then, such movements look like ordinary  $\bar{A}$ -movement: they have familiar information-structural consequences and may skip intervening noun phrases and clause boundaries.

Let us first discuss what I have loosely referred to so far as *topicalization*. I use this term to refer to displacement of a non-subject to Spec-CP, with a variety of information-structural consequences, not limited to topicality. Topicalization is in principle unbounded and may skip intervening noun phrases as well as finite clause boundaries, as the examples in (2a–b) attest.

(2) **Topicalization may cross noun phrases and clause boundaries:**

- a. **Páal** à-céemè Áyèn cuḡin \_\_\_\_.  
**knife** 3s-eat.OBLV Ayen.GEN food  
 ‘With a knife, Ayen is eating food.’
- b. **Cuḡin** à-yàa tàak [CP kè céem Áyèn \_\_\_\_].  
**food** 3s-HAB.1SG think.NF c eat.OV Ayen.GEN  
 ‘The food, I think Ayen is eating.’

The information-structural consequences of topicalization are similar to the effects of fronting to Spec-CP in Germanic V2 (e.g. Frascarelli and Hinterhölzl 2007). When a non-subject nominal moves to Spec-CP, it functions as a topic or focus. That subject-initial orders indeed reflect the neutral order is demonstrated by the dialogue in (3). If the prompt is a neutral question like *Yè ηό piàth?* (‘What’s new?’), only a Subject Voice response is felicitous.

(3) **Subject-initial order is neutral:**

- A: Yè ηό piàth?  
 be what is.good  
 ‘What’s new?’
- B: **Áyén** à-cé uḡòot uḡòc.  
**Ayen** 3s-PRF.SV house buy.NF  
 ‘Ayen bought a house.’
- B: **#uḡòot** à-cíi Áyèn uḡòc.  
**house** 3s-PRF.OV Ayen.GEN buy.NF  
 ‘A house, Ayen bought.’

At the same time, what I am calling topicalization can serve a variety of functions. Movement to Spec-CP can be used to signal a topic, like the given topic in the dialogue in (4).<sup>1</sup>

1. It may also signal other types of topic, such as an aboutness topic (in Frascarelli and Hinterhölzl’s terminology).

(4) *Fronting can indicate given topic:*

A: Yè ɲà cɛ̃ **cụịn** câam?  
be who PRF.SV **food** eat.NF  
'Who has eaten the food?'

B: **Cụịn** à-c̣ị Bôl câam.  
**food** 3S-PRF.OV Bol.GEN eat.NF  
'The food, Bol has eaten.'

In addition, fronting can be used to indicate focus. In the dialogue in (5), for example, the object is moved to Spec-CP to signal answer focus.

(5) *Fronting can indicate answer focus:*

A: Yè ɲó c̣ị Bôl câam?  
be **what** PRF.OV Bol.GEN eat.NF  
'What has Bol eaten?'

B: **Cụịn** à-c̣ị Bôl câam?  
**food** 3S-PRF.OV Bol.GEN eat.NF  
'It is the food that Bol has eaten.'

As evident in these two dialogues, this type of fronting is not obligatory, just as in Germanic V2 languages. In (4), for instance, the subject is in focus, but does not have to appear in Spec-CP (though it can). Although there are clearly distinct information-structural processes at work here, I will continue to use the term "topicalization" to refer to movement of this sort, because the same syntax is involved in all of these instances. It is important to note, though, that movement in (4) and (5) may involve distinct triggers.

As further support for the idea that these word order alternations reflect manipulations of information structure, note that we can distinguish topicalization structures from passives. Dinka has a passive as well, in which the subject can only appear in a *by*-phrase (6a–b).

(6) *Topicalization is distinct from passive:*

a. **Cụịn** à-c̣ị Áyèn \_\_\_ câam ṇɛ̣ p̣aal.  
**food** 3S-PRF.OV Ayen.GEN eat.NF P knife  
'The food, Ayen has eaten with a knife.'

b. **Cụịn** à-c̣ị \_\_\_ câam ṇɛ̣ p̣aal ṇɛ̣ Áyèn.  
**food** 3S-PRF.PASS eat.NF P knife P Ayen.GEN  
'The food was eaten with a knife by Ayen.'

On this basis, I will treat topicalization as the result of movement driven by an information-structural feature, such as a Topic or Focus feature.

The second type of long-distance dependency that I focus on here is relativization. As noted by Andersen (1991:sec. 6), relative clause formation in Dinka involves obligatory movement to Spec-



CP of the relative clause, with concomitant changes in voice morphology (as well as in agreement morphology on the second position verb/auxiliary). The examples in (7a–d) demonstrate this. In (7a–b), we see that an object relative requires that the Spec-CP position be empty, with the clause in Object Voice. Similarly, the examples in (7c–d) demonstrate that subject relatives must be in the Subject Voice.<sup>2</sup>

(7) *Relativization requires empty Spec-CP:*

- a. tíŋ            [CP \_\_\_ cíi    Bòl    tíiŋ]  
       woman.CS            PRF.OV Bol.GEN see.NF  
       ‘the woman that Bol has seen’
- b. \*tíŋ            [CP Bòl cé            tíiŋ]  
       woman.CS    Bol (3s)-PRF.SV see.NF  
       ‘the woman that Bol has seen’
- c. tíŋ            [CP \_\_\_ cé    Bòl tíiŋ]  
       woman.CS            PRF.SV Bol see.NF  
       ‘the woman that has seen Bol’
- d. \*tíŋ            [CP Bòl cíi    tíiŋ]  
       woman.CS    Bol PRF.OV see.NF  
       ‘the woman that has seen Bol’

I mark the silent Spec-CP position with a null operator for ease of exposition, without intending to commit to any particular analysis of relative clauses. What I say in this chapter should be compatible with any theory of relativization, though we will see some evidence to suggest a raising analysis may be appropriate. Relativization has the locality profile of  $\bar{A}$ -movement. It may skip intervening clause boundaries and noun phrases, regardless of case marking, as shown in the *wh*-cleft examples in (8a–c).

(8) *Relativization may cross noun phrases and clause boundaries:*

- a. Yè ŋó    [CP Op cíi    Bòl    \_\_\_ tíiŋ]?  
       be **what**            PRF.OV Bol.GEN    see.NF  
       ‘What has Bol seen?’
- b. Yè ŋà    [CP Op yíi    tàak,    [CP cíi    Bòl    \_\_\_ tíiŋ]]?  
       be **who**            HAB.2SG think.NF    PRF.OV Bol.GEN    see.NF  
       ‘Who do you think Bol has seen?’
- c. Yè ŋó    [CP Op cíi    Bòl    Àyén lùuk            [CP è bẹ    \_\_\_ ɥĩɔɔc]]?  
       be **what**            PRF.OV Bol.GEN Ayen persuade.NF    C FUT.3SG    buy.NF  
       ‘What has Bol persuaded Ayen that she should buy?’

2. In these examples, the noun *tíŋ* (‘woman’) is in one of two *construct states* (cs), forms of the noun used whenever the noun is modified by certain elements, such as relative clauses. There are two such construct states, each associated with a class of DP-internal modifiers. See Andersen (2007) for detailed discussion.

As evident in the examples in (8a–c), relativization is commonly used to form *wh*-clefts. Dinka has two strategies for forming *wh*-questions: *wh*-clefts and *wh*- in situ (9a–b).

(9) *Wh-cleft alternates with wh- in situ:*

- a. Yè **ŋó** [<sub>CP</sub> Op **c̣i** Ból \_\_\_ **ṭiŋ**]?  
 be **what** PRF.OV Bol.GEN see.NF  
 ‘What has Bol seen?’
- b. **Cé** Ból **ŋó** **ṭiŋ**?  
 PRF.SV Bol **what** see.NF  
 ‘What has Bol seen?’

These two strategies alternate freely. Both are possible out of the blue and both are attested in texts. Because relative clauses and questions both lack the declarative prefix *a-*, *wh*-clefts can look very similar to in situ questions, as evident in the examples in (10a–b).

(10) *Clefted and in situ wh-subject:*

- a. Yè **ŋà** [<sub>CP</sub> Op **cé** **c̣uŋin** **c̣am**]?  
 be **who** PRF.SV food eat.NF  
 ‘Who has eaten food?’
- b. **ŋà** **cé** **c̣uŋin** **c̣am**?  
**who** PRF.SV food eat.NF  
 ‘Who has eaten food?’

That examples like (10a) are biclausal is mainly evident in the use of the copula, which may be inflected separately from the verb (e.g. with the past tense prefix). There is no associated difference in meaning, however. *Wh*-clefts lack the existence presupposition and the exhaustivity presupposition that are usually associated with clefts (e.g. Higgins 1976). As a result, I translate them as questions with *wh*-movement throughout.

## 2.2 Topicalization and relativization involve movement

In this section, I establish that topicalization and relativization involve movement, using *wh*- in situ as a point of comparison. We will see that both topicalization and relativization are island-sensitive and allow reconstruction. In addition to this, we will see in Chapter 5 that all of these movement types consistently trigger reflexes of intermediate movement at the edge of every clause and every verbal domain, furnishing an additional argument for movement in these constructions.

Movement to Spec-CP is island-sensitive. As in many languages, adjuncts are islands for extraction in Dinka. One type of adjunct clause is introduced by *wuŋin* (‘because/when’) (11a). As the examples in (11b–c) show, relativization or topicalization out of such a clause is ungrammatical.

(11) *Adjunct clauses are islands for extraction:*

- a. Àdít à-cé jàal [CP wuín cii Màyèn tònny kuêem].  
 Adit 3s-PREF.SV leave.NF when PREF.OV Mayen.GEN pot break.NF  
 ‘Adit left when Mayen broke the pot.’
- b. \*Yè ñó [CP Op cii Ádít jàal [CP wuín cii Màyèn \_\_\_ kuêem]]?  
 be what PREF.OV Adit.GEN leave.NF when PREF.OV Mayen.GEN break.NF  
 ‘(lit.) What did Adit leave [because Mayen broke \_\_\_]?’
- c. \*Tònny à-cii Ádít jàal [CP wuín cii Màyèn \_\_\_ kuêem].  
 pot 3s-PREF.OV Adit.GEN leave.NF when PREF.OV Mayen.GEN break.NF  
 ‘(lit.) The pot, Adit left because Mayen broke \_\_\_.’

We can contrast this with *wh-* in situ, which, as discussed above, alternates with *wh-*clefts. In situ *wh-* words are insensitive to islands and can take scope out of an adjunct island, as demonstrated by the example in (12).

(12) *Wh- in situ is possible in an adjunct clause:*

- Cé Ádít jàal [CP wuín cii Màyèn ñó kuêem]?  
 PREF.SV Adit.GEN leave when PREF.OV Mayen.GEN what break.NF  
 ‘(lit.) What did Adit leave when Mayen broke \_\_\_?’

The same contrasts emerge with extraction out of relative clauses, which also constitute islands. Topicalization or relativization out of a relative clause is impossible, as illustrated in (13a–c).

(13) *Relative clauses are islands for extraction:*

- a. Àyèn à-cé [DP ràan [CP mèr tònny]] tiiŋ.  
 Ayen 3s-PREF.SV person.CS decorate.SV pot see.NF  
 ‘Ayen has seen someone who is decorating a pot.’
- b. \*Yè ñó [CP Op cii Àyèn [DP ràan [CP mèr \_\_\_]] tiiŋ]?  
 be what PREF.OV Ayen.GEN person.CS decorate.SV see.NF  
 ‘(lit.) What has Ayen seen someone [who is decorating \_\_\_]?’
- c. \*Tònny à-cii Àyèn [DP ràan [CP mèr \_\_\_]] tiiŋ.  
 pot 3s-PREF.OV Ayen.GEN person.CS decorate.SV see.NF  
 ‘(lit.) A pot, Ayen has seen someone who is decorating \_\_\_.’

*Wh-* in situ again provides a minimal contrast, because an in situ *wh-* word can freely scope out of a relative clause (14).

(14) *Wh- in situ is possible in a relative clause:*

- Cé Àyèn [DP ràan [CP mèr ñó]] tiiŋ?  
 PREF.SV Ayen.GEN person.CS decorate.SV what see.NF  
 ‘(lit.) What has Ayen seen someone who is decorating \_\_\_?’

These facts demonstrate that long-distance dependencies targeting Spec-CP are island-sensitive.

To further show that Dinka long-distance dependencies are movement-derived, we can look at reconstruction effects, using the reflexive element *ròt/ròth* ('self'/'self.PL').<sup>3</sup> *Ròt* is a local anaphor, subject to Condition A, which allows both reflexive and reciprocal readings (I focus on the reflexive use here). It may be suffixed with a possessive clitic, matching the antecedent in  $\varphi$ -features. The examples in (15a–c) show that this anaphor must be bound by a c-commanding antecedent within the smallest TP in which it is contained. It does not tolerate binding across a CP boundary (15b), even if the anaphor is topicalized to the edge of the lower CP (15c), and requires c-command (15d).

(15) *Reflexive is subject to Condition A:*

- a. **Ròor<sub>i</sub>** áa-nhiàr **ròth-kén<sub>i</sub>**.  
**men** 3P-love.SV **self.PL-PL.3PL**  
 'The men<sub>i</sub> love themselves<sub>i</sub>.'
- b. \*À-yíi **Ból** tàak [CP kè wòok cé **ròt-dé<sub>i</sub>** nhiàar].  
 3S-HAB.OV **Bol.GEN** think.NF C 1PL PRF.SV **self-sg.3sg** love.NF  
 '(lit.) Bol<sub>i</sub> thinks we have loved himself<sub>i</sub>.'
- c. \*À-yíi **Ból** tàak [CP kè **ròt-dé<sub>i</sub>** cùukù nhiàar].  
 3S-HAB.OV **Bol.GEN** think.NF C **self-sg.3sg** PRF.1PL love.NF  
 '(lit.) Bol<sub>i</sub> thinks that, himself<sub>i</sub>, we have loved.'
- d. \*Mánh è **Ból<sub>i</sub>** à-nhiàr **ròt-dé<sub>i</sub>**.  
 brother.CS P **Bol.GEN** 3P-love.SV **self-sg.3sg**  
 'Bol's<sub>i</sub> brother loves himself<sub>i</sub>.'

We can use this reflexive to show that movement to Spec-CP may reconstruct for local, long-distance, and intermediate binding. In (16a), the topicalized reflexive is bound by the local pronominal subject (visible in the subject marking on the perfect auxiliary). The reflexive also reconstructs for binding by the local subject if it has moved long-distance (16b). Finally, an intermediate subject on the path of movement may also bind the reflexive (16c).<sup>4</sup>

---

3. These reconstruction facts allow us to rule out a base-generation approach along the lines of Adger and Ramchand (2005), who argue that some long-distance dependencies are island-sensitive not because of they make use of movement but because of successive-cyclic Agree.

4. The same pattern of reconstruction is found in English (Barss 1986; Lasnik and Saito 1992).

(16) *Reflexive reconstructs for binding:*

- a. Ròt-dé<sub>i</sub> à-cè<sub>i</sub> nhiâar.  
self-SG.3SG 3S-PREF.3SG love.NF  
'Herself/himself, she/he has loved.'
- b. Ròt-dé<sub>i</sub> à-yùukù tàak [CP è cè<sub>i</sub> nhiâar].  
self-SG.3SG 3S-HAB.1PL think.NF C PREF.3SG love.NF  
'Herself/himself, we say that she/he has loved.'
- c. Ròt-dé<sub>i</sub> à-cè<sub>i</sub> tàak [CP è cùukù nhiâar].  
self-SG.3SG 3S-PREF.3SG think.NF C PREF.1PL love.NF  
'Herself/himself, she/he has thought that we have loved.'

We can use this reflexive to demonstrate that there are reconstruction effects in Dinka relativization also. As the examples in (17a–b) illustrate for *wh*-clefts, relativization allows reconstructed interpretations of the anaphor.<sup>5</sup>

(17) *Relativization reconstructs for reflexive binding:*

- a. Yè thúrâi-kó è ròth-kén<sub>i</sub> [CP Op cìi kòc<sub>i</sub> ké tìiŋ]?  
be pictures-which.PL P self.PL-PL.3PL PREF.OV people.GEN 3PL see.NF  
'Which pictures of themselves<sub>i</sub> have the people<sub>i</sub> seen?'
- b. Yè thúrâi-kó è ròth-kén<sub>i</sub> [CP Op yá ké luéel [CP è cìi  
be pictures-which.PL P self.PL-PL.3PL HAB.2SG 3PL say.NF C PREF.OV  
kòc<sub>i</sub> ké tìiŋ]]?  
people.GEN 3PL see.NF  
'Which pictures of themselves<sub>i</sub> do you say that people<sub>i</sub> have seen?'

The same reconstruction pattern is possible with topicalization (18a–b).

(18) *Topicalization reconstructs for reflexive binding:*

- a. Thúrâi è ròth-kén<sub>i</sub> áa-cìi kòc<sub>i</sub> ké tìiŋ.  
pictures P self.PL-PL.3PL 3P-PREF.OV people.GEN 3PL see.NF  
'The pictures of themselves<sub>i</sub>, the people have seen.'
- b. Thúrâi è ròth-kén<sub>i</sub> áa-yá ké luéel [CP è cìi kòc<sub>i</sub> ké tìiŋ].  
pictures P self.PL-PL.3PL 3P-HAB.2SG 3PL say.NF C PREF.OV people.GEN 3PL see.NF  
'Pictures of themselves<sub>i</sub>, you think that the people<sub>i</sub> have seen.'

I take these facts as evidence that these are instances of long-distance movement. Displacement to Spec-CP in Dinka has all the properties of  $\bar{A}$ -movement in other languages: it can skip over intervening nominals and clause boundaries, has consequences for information structure, is island-

5. As evident in these examples and the corresponding cases of topicalization, movement of plurals is associated with a process of multiple copy spell-out at the verb phrase edge. The 3rd person plural pronoun *ké* appears at every verb phrase on the path of movement. I discuss this process in detail in Chapter 6.

sensitive, and allows reconstruction.<sup>6</sup> As noted previously, Chapter 5 offers additional evidence for this, by showing that all instances of displacement are accompanied by overt reflexes of intermediate successive-cyclic movement at the edge of every clause and verb phrase.

### 3 Agreement, case, and long-distance movement

So far, movement to Spec-CP in Dinka looks just like familiar instances of long-distance  $\bar{A}$ -movement: it is driven by the need to mark changes in information structure in a broad sense and shows the locality profile of  $\bar{A}$ -dependencies. In this section, however, I show that Dinka long-distance movement also affects  $\varphi$ -agreement and case assignment. On this basis, I propose that movement in Dinka is accompanied by multiple Agree relations, Agree for an  $\bar{A}$ -feature like *Wh* and Agree with a  $\varphi$ -probe. I implement this using the notion of a composite probe from Coon and Bale (2014).

#### 3.1 Long-distance movement, $\varphi$ -agreement, and case

Case assignment and  $\varphi$ -agreement interact with long-distance movement to Spec-CP in Dinka. Every instance of topicalization or relativization, regardless of whether it is local or long-distance, results in  $\varphi$ -agreement with the dislocated phrase as well as case assignment.

Unlike in many other V2 languages, movement to Spec-CP is accompanied by  $\varphi$ -agreement. This agreement appears on a prefix which attaches to the verb/auxiliary in V2 position. Andersen (1991) called this prefix the *declarative particle* and it also expresses tense. It contrasts with an interrogative particle that shows up in interrogative and relative clauses, as discussed previously. Some examples of subject-initial declarative sentences, with the declarative particle highlighted in bold, are given in (19a–c).

(19) *Agreement with clause-initial subject:*

- a. Ỵin **Ø-cé** ṃir ṭiŋ.  
you 2-PREF.SV giraffe see.NF  
'You have seen a giraffe.'
- b. Ṃòc à-cé ỵin ṭiŋ.  
man 3S-PREF.SV you see.NF  
'The man has seen you.'
- c. Ṛòòr **áa-cé** ỵin ṭiŋ.  
men 3P-PREF.SV you see.NF  
'The men have seen you.'

In these examples, the prefix on the perfect auxiliary *cé*, which occupies verb-second position, expresses the  $\varphi$ -features of the clause-initial subject. In (19a–c), we see the three forms of the

6. In addition, these facts suggest that at least one of the structure available to relativization in Dinka is a raising structure.

declarative particle in present tense declarative sentences. In (19a), the prefix is null, because the 2nd person singular subject *ỵin* is in Spec-CP (the paradigm of this prefix is reminiscent of English subject-verb agreement: 1st and 2nd person pronouns always trigger a null affix). In (19b–c), however, the subject is 3rd person, and the declarative particle is overt, distinguishing between 3rd person singular and plural, respectively.

As noted above,  $\varphi$ -agreement on this particle does not track the subject, but always targets the DP in Spec-CP. Parallel examples with topicalization of an object are given in (20a–c).

(20) **Agreement with initial object:**

- a. *Ỵin*  $\emptyset$ -*c̣ji* *m̄oc* *ṭjiŋ*.  
 you 2-PRF.OV man.GEN see.NF  
 ‘You, the man has seen.’
- b. *M̄ir* *à-c̣a* *ṭjiŋ*.  
 giraffe 3s-PRF.1SG see.NF  
 ‘A giraffe, I have seen.’
- c. *M̄ièr* *áa-c̣a* *ké ṭjiŋ*.  
 giraffes 3P-PRF.1SG 3PL see.NF  
 ‘Giraffes, I have seen.’

These examples demonstrate that  $\varphi$ -agreement targets the DP in Spec-CP and not the subject. In (20a), the declarative particle is null, because the clause-initial object is 2nd person, and not *à-*, as it would be if the 3rd person singular subject *m̄oc* (‘the/a man’) governed agreement. Similarly, in (20b–c), the particle reflects the features of the 3rd person object and not of the non-initial subject.

It is worth noting that there is an additional agreement process in Dinka that does exclusively target the subject. In (20b–c), we see that the non-initial 1st person singular subject is represented in the *c̣a* form of the perfect auxiliary. This agreement is suffixal and only targets pronominal subjects that are not in Spec-CP. This is a separate process from  $\varphi$ -agreement targeting the initial DP, and either involves a series of subject clitics attaching to T or a process of subject agreement on T that ignores lexical subjects and requires *pro*-drop. In any case, this process does not interact with  $\bar{A}$ -movement and so we can set aside the issue here.

As mentioned above, the prefix on the 2nd position is also sensitive to tense and takes two forms, depending on whether the clause is declarative or interrogative/relative. The present and past tense paradigms for the declarative particle are given in (21).

(21) **Paradigms of the declarative particle:**

PRES	SG	PL	PAST	SG	PL
1st/2nd	$\emptyset$ -	$\emptyset$ -	1st/2nd	é-	é-kè-
3rd	à-	áa-	3rd	é-	áa-kè-

It will be useful to distinguish the declarative paradigms of this prefix from the paradigms found in interrogative and relative clauses. I refer to these forms as the *interrogative particle*. The paradigms

for the interrogative particle are essentially formed by omitting the *a(a)*- found in (21), which presumably marks declarative. The resulting paradigms can be seen in (22).

(22) *Paradigms of the interrogative particle:*

PRES	SG	PL	PAST	SG	PL
1st/2nd	∅-	∅-	1st/2nd	é-	é-kè-
3rd	∅-	∅-	3rd	é-	é-kè-

As evident here, some  $\varphi$ -agreement contrasts are lost on the interrogative particle. In the present tense, no  $\varphi$ -featural distinctions are retained and the exponent of the prefix is always null. However,  $\varphi$ -agreement survives with plural nominals of all persons in the past tense, which trigger *é-kè-* and not *é-*. We can use this to show that relativization, like topicalization, triggers  $\varphi$ -agreement on the second position verb/auxiliary (see also Andersen 2014:257). The examples in (23a–c) are past tense *wh*-clefts with a plural *wh*-phrase. We see that agreement at the Spec-CP position marked by *Op* references the  $\varphi$ -features of the *wh*-phrase (23a–b), even when it has undergone long-distance movement (23c).

(23) *Relativization triggers  $\varphi$ -agreement at C:*

- a. Yè kôɔc-kó [CP *Op* é-kè-thèt]?  
 be people.cs-which.PL PST-3P-cook.sv  
 ‘Which people were cooking?’
- b. Yè kôɔc-kó [CP *Op* é-kè-cii Áyèn ké gàam gàlà]m]?  
 be people.cs-which.PL PST-3P-PRF.OV Ayen.GEN 3PL give.NF pen  
 ‘Which people had Ayen given a pen to?’
- c. Ye kôɔc-kó [CP *Op* é-kè-yá ké tàak [CP é-kè-cii  
 be people.cs-which.PL PST-3P-HAB.2SG 3PL think.NF PST-3P-PRF.OV  
 Áyèn ké gàam gàlà]m]]?  
 Ayen.GEN 3PL give.NF pen  
 ‘Which people did (s)he think that Ayen had given a pen to?’

This means that all long-distance  $\bar{A}$ -movement is accompanied by  $\varphi$ -agreement with C, even though  $\varphi$ -processes usually strictly target the closest nominal. As evident in the embedded clause (23c), this is even true of intermediate movement (the *é-kè-* prefix on the auxiliary in the lower clause is the result of intermediate movement to the initial position of the embedded clause). I return to this in more detail in Chapter 5.

In addition to  $\varphi$ -agreement, long-distance movement triggers case assignment, as also pointed in Chapter 3. The nominal in Spec-CP always occurs in the absolutive case (24a–c).



(24) *Clause-initial nominal has absolutive case:*

- a. **Àyén** à-cé cuḷin câam nè pǎal.  
**Ayen** 3s-PRF.SV food eat.NF P knife  
'Ayen has eaten food with a knife.'
- b. **Cuḷin** à-cíi Àyèn câam nè pǎal.  
**food** 3s-PRF.OV Ayen.GEN eat.NF P knife  
'Food, Ayen has eaten with a knife.'
- c. **Pǎal** à-cénè Àyèn cuḷin câam.  
**knife** 3s-PRF.OBLV Ayen.GEN food eat.NF  
'With a knife, Ayen has eaten food.'

This is true of subjects, objects, and adjuncts (like the instrumental in 24c) and is found with all long-distance movement. As discussed in Chapter 3, I treat this as case assignment because it involves nominals that do not appear in the absolutive when they do not move to Spec-CP, such as subjects and PPs. PPs, for example, lose their prepositional marking when fronted. The examples in (25a–d) demonstrate that the instrumental preposition *nè* is lost if its complement is topicalized.

(25) *Topicalized PPs become nominal:*

- a. **Bòl** à-thèt nè tòony.  
**Bol** 3s-cook.sv P pot  
'Bol is cooking with a pot.'
- b. **Tòony** à-thégtè Bòl.  
**pot** 3s-cook.OBLV Bol.GEN  
'A pot, Bol is cooking with.'
- c. **Àyén** à-cé cuḷin câam nè pǎal.  
**Ayen** 3s-PRF.SV food eat.NF P knife  
'Ayen ate food with a knife.'
- d. **Pǎal** à-cénè Àyèn cuḷin câam.  
**knife** 3s-PRF.OBLV Ayen.GEN food eat.NF  
'With a knife, Ayen ate food.'

A similar alternation is found with subjects, which occur in the genitive case when they are not in clause-initial position (26a–b).

(26) *Subjects show a case alternation:*

- a. **Àyén** à-cé cuḷin câam nè pǎal.  
**Ayen** 3s-PRF.SV food eat.NF P knife  
'Ayen has eaten food with a knife.'
- b. **Cuḷin** à-cíi **Àyèn** câam nè pǎal.  
**food** 3s-PRF.OV **Ayen.GEN** eat.NF P knife  
'Food, Ayen has eaten with a knife.'

The effects of case assignment are clear with topicalization, but it seems likely that relativization involves the same case alternations underlyingly. The Spec-CP position of a relative clause is empty, but the  $\varphi$ -agreement facts in (23a–c) and concomitant voice alternations suggest that the silent DP that occupies this position, whether null operator or copy, is also in the absolutive case. It is important to note that these changes to  $\varphi$ -agreement and voice appear *internal* to the relative clause, and are independent of the presence of cleft structure.

To sum up, long-distance movement in Dinka is accompanied by  $\varphi$ -agreement and case assignment, unlike in many other languages. I suggest that these two observations are linked, taking case assignment to be a reflex of  $\varphi$ -agreement (George and Kornfilt 1981; Chomsky 2000, 2001). These facts demonstrate that long-distance movement in Dinka is not driven purely by features like Top, Foc, or Rel. Instead, movement in Dinka simultaneously affects information structure and case and agreement patterns.

### 3.2 A composite probe on C

We have seen so far that movement in Dinka, even when driven by information-structural considerations, also involves a relation of  $\varphi$ -agreement. To capture this, I develop the idea in this section that movement in Dinka is triggered by multiple probing features at the same time, both by an  $\bar{A}$ -probe like Rel or Top/Foc and by a  $\varphi$ -probe. I propose that C in Dinka carries both a  $\varphi$ -probe and a catch-all  $\bar{A}$ -probe, satisfied by any type of  $\bar{A}$ -feature, adopting the idea that there is a hierarchy to features involved in  $\bar{A}$ -movement (e.g. Rizzi 1990, 1997; Abels 2012a). I posit that the  $\varphi$ -probe and  $\bar{A}$ -probe act as a *composite probe*, a notion I borrow from Coon and Bale (2014), so that they must select a target together. This approach captures the correlation between movement and  $\varphi$ -agreement in Dinka.

As mentioned above, I propose that Dinka C carries features driving  $\bar{A}$ -movement as well as a  $\varphi$ -probe. These features are then introduced on the same head in Dinka (27), where they are distributed across different heads in languages like English (28).<sup>7</sup>

(27) **Dinka:**

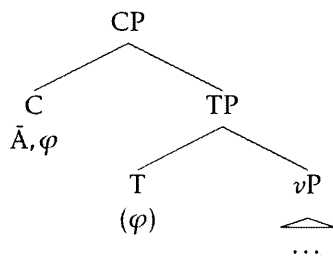

(28) **English:**

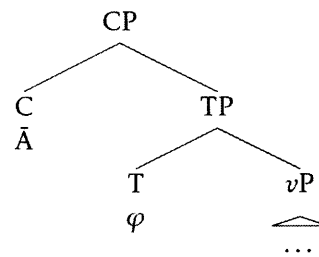

I suggest that  $\bar{A}$ -features are always introduced in the left periphery, but that the locus of  $\varphi$ -agreement can vary, since these features do not affect the interpretation of the clause.<sup>8</sup> As a result,

7. As indicated in (27), we could also take there to be a  $\varphi$ -probe on T in Dinka, responsible for the process of subject agreement/cliticization briefly discussed in the previous section (and possibly for the assignment of “marked nominative”/genitive).

8. See Miyagawa 2010 for an alternative view.

we expect to find at least the two languages in (27) and (28). In addition to this, I propose that, in Dinka, the probing features on C form a *composite probe*, in the sense of Coon and Bale (2014), so that they act in effect as one probe. As a result, these features select and target a goal in unison.<sup>9</sup>

Importantly, I propose that the  $\bar{A}$ -probe on C is a catch-all probe, satisfied by any feature that could drive  $\bar{A}$ -movement, such as *Wh*, *Rel*, or *Top*. This requires adopting the idea that  $\bar{A}$ -features exist in a hierarchy (Rizzi 1997, 2004; Abels 2012a), much like  $\varphi$ -features (e.g. Harley and Ritter 2002). The precise shape of such a hierarchy does not matter much for our purposes (though see Abels 2012a for discussion), as long as it contains a feature that dominates all  $\bar{A}$ -features relevant for Dinka, which I will take to be at least *Top*, *Foc*, and *Rel* (29).

(29) **Hierarchy of  $\bar{A}$ -features:**

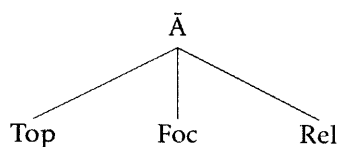

If such a hierarchy constrains the distribution of  $\bar{A}$ -features, we can imagine that  $\bar{A}$ -probes may differ in their featural make-up. We can draw an analogy to  $\varphi$ -probing, for which similar variation has been proposed. As discussed in Chapter 2 (sec. 5.2),  $\varphi$ -probes may either be flat, so that they are satisfied by any bundle of  $\varphi$ -features regardless of value, or relativized to a specific type of  $\varphi$ -feature, such as [participant] or [plural] (e.g. Nevins 2007; Preminger 2011; Coon and Bale 2014). Applying this idea to the hierarchy in (29), I propose that, in Dinka, C always carries a flat  $\bar{A}$ -probe (30), which may be satisfied equally by *Top*, *Foc*, and *Rel*, instead of more relativized probes, such as *Rel* in the tree in (31).<sup>10</sup>

(30) **Flat probe on C:**

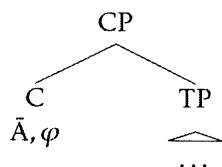

(31) **Articulated probes on C:**

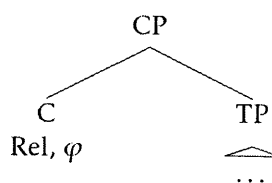

This view of the Dinka left periphery captures the fact that any instance of  $\bar{A}$ -movement is accompanied by  $\varphi$ -agreement and that there is never more than one instance of  $\bar{A}$ -movement to the same clause edge. Because the  $\varphi$ -probe acts in unison with an  $\bar{A}$ -probe, it ignore closer DPs that lack a  $\bar{A}$ -feature, as in the configuration in (32).

9. If it is optional whether two probes on the same head form a composite probe, we might expect to find languages like (27) in which the  $\bar{A}$ -probe and  $\varphi$ -probe probe separately. This is plausibly the case in languages with complementizer agreement like Nez Perce (Deal 2014) and West Flemish (Haegeman 1990).

10. In such a view, there would presumably be different varieties of C, each carrying a different relativized  $\bar{A}$ -probe. Alternatively, we could allow for multiple relativized  $\bar{A}$ -probes on the same head, although this predicts that we should find the same situation with relativized  $\varphi$ -probes (e.g. separate [participant] and [author] probes carried by the same head).

(32)

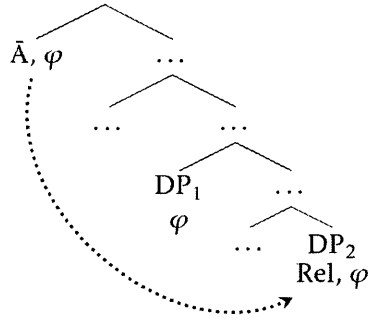

A composite probe, like any other probe, looks for the closest phrase that carries matching features, in this case is a goal with both  $\varphi$ -features and an  $\bar{A}$ -feature.  $DP_1$  in (32) is not a relevant goal because it does not satisfy that description. The notion of a composite probe explains why  $\varphi$ -agreement in Dinka accompanies long-distance movement and is not limited to the closest nominal.

In addition to this, this approach sets a limit of one instance of  $\bar{A}$ -movement per left periphery. If all movement requires Agree, and the  $\bar{A}$ -probe on C is satisfied by any  $\bar{A}$ -feature, then no features will remain on C to initiate  $\bar{A}$ -movement after one goal with an  $\bar{A}$ -feature is attracted. This explains the ungrammaticality of examples like (33a–b), which illustrate that topicalization is impossible if relativization must also take place.

(33) **Relativization cannot co-occur with topicalization:**

- a. \*t̩iŋ            [CP Bòl cé            t̩iŋ]
- woman.cs    Bol (3s)-PRF.SV see.NF
- ‘the woman that Bol has seen’
- b. \*t̩iŋ            [CP Bòl cíi            t̩iŋ]
- woman.cs    Bol PRF.OV see.NF
- ‘the woman that has seen Bol’

The idea of a composite probe, consisting of a  $\varphi$ -probe and a flat  $\bar{A}$ -probe, then captures the restrictions on  $\bar{A}$ -movement in Dinka:  $\bar{A}$ -movement is limited to nominals, and only one instance is possible in a given clause.

One question that arises is how to treat neutral Subject Voice clauses. Recall that, in these clauses, the subject appears in Spec-CP, and does not need to signal a topic or a focus. This seems to suggest that such subjects do not carry an  $\bar{A}$ -feature. I propose that a composite probe may default to a goal that constitutes a partial match, if fully matching goal is available. See Chapter 5 (sec. 5.2) for an explicit calculus for situations without a complete match for the composite probe.

I have shown in this section that movement in Dinka is driven by  $\bar{A}$ -features and  $\varphi$ -features at the same time. As discussed in Chapter 2 (sec. 5.2), a featural approach to the A/ $\bar{A}$ -distinction makes an important prediction about such a system. In particular, if A- and  $\bar{A}$ -properties derive from the Agree relation involved, movement driven by both kinds of Agree relation should be

associated with A- and  $\bar{A}$ -properties. We have already seen how this works out for the locality profile of movement in Dinka: movement can skip intervening DPs and CPs, like  $\bar{A}$ -movement can, because a composite probe looks for goals bearing both types of features. But movement to Spec-CP in Dinka should simultaneously behave like A-movement for the purpose of binding, if a lack of Weak Crossover violations, the ability to bind anaphors, and the availability of Wholesale Late Merger derive from the presence of an Agree relation in  $\varphi$ -features. In the next section, I examine these predictions in turn and argue that they are borne out.

## 4 Movement in Dinka and binding

We have seen so far that movement to Spec-CP in Dinka has many of the familiar properties of  $\bar{A}$ -movement, although it involves an Agree relation in  $\varphi$ -features as well. Under a featural approach to the A/ $\bar{A}$ -distinction, we expect that it should look like A-movement in other respects, particularly when it comes to binding. In this section, I show that this is what we find when we examine Weak Crossover, anaphor binding, and reconstruction for Principle C in Dinka. Importantly, these properties consistently co-occur, so that movement may show properties of A-movement and properties of  $\bar{A}$ -movement at the same time (*cf.* Webelhuth 1989; Mahajan 1990).

### 4.1 Weak Crossover and anaphor binding

In Chapter 2 (sec. 4.1), I argued that the difference between A- and  $\bar{A}$ -movement in terms of their ability to initiate variable binding and anaphor binding derives from the interpretive effects of the Agree relation involved. In particular, I proposed that only chains created by  $\varphi$ -probing may trigger abstraction over individuals. In contrast, Merge initiated by Agree for an  $\bar{A}$ -feature is accompanied by abstraction over choice functions, giving rise to Weak Crossover, following Sauerland (1998) and Ruys (2000), as well as an inability to bind anaphors. This approach predicts that both options should be available for movement that involves both types of Agree relation. In Dinka then, movement to Spec-CP should be able to make use of abstraction over individuals or abstraction over choice functions.<sup>11</sup> In accordance with this, we will see that movement in Dinka generally lacks Weak Crossover effects and allows anaphors to be bound by long-distance movement.

Let me first show that Dinka displays Weak Crossover with QR. The example in (34a) demonstrates that Dinka has a universal quantifier *ébéén* ('every') which can bind pronouns. Variable binding by this quantifier is subject to Weak Crossover. An object quantifier cannot QR to bind into the subject (although inverse scope is permitted in such configurations), in this case to bind the possessive pronoun *-dè* (34b).

---

11. I assume that, if abstraction over individuals accompanies movement to Spec-CP, a short step of QR is available to render the resulting LF interpretable.

(34) *Weak Crossover in Dinka:*

- a. **Dhùk ébén<sub>i</sub>** à-cé thók-dè<sub>i/k</sub> tiiŋ.  
**boy every** 3S-PRF.SV goat.CS-SG.3SG see.NF  
'Every boy has seen his goat.'
- b. Thók-dè<sub>k/\*i</sub> à-cé **dhùk ébén<sub>i</sub>** kâac.  
goat.CS-SG.3SG 3S-PRF.SV **boy every** bite.NF  
'His<sub>k/\*i</sub> goat has bitten every boy<sub>i</sub>.'

However, such violations can be obviated by topicalizing the binder to Spec-CP (35a), unlike with topicalization of quantificational phrases in languages like English (Postal 1993; see also Chapter 2, sec. 4.1). The same amelioration is observed with *wh*-clefts (35b).<sup>12</sup>

(35) *No WCO with movement to Spec-CP:*

- a. **Dhùk ébén<sub>i</sub>** à-cíj thók-dè<sub>i</sub> \_\_\_ kâac.  
**boy every** 3S-PRF.OV goat.CS-SG.3SG bite.NF  
'Every boy<sub>i</sub>, his<sub>i</sub> goat bit.'
- b. Yè **dhùŋ-ó<sub>i</sub>** [<sub>CP</sub> Op cíj thók-dè<sub>i</sub> \_\_\_ kâac]?  
be **boy.CS-which** PRF.OV goat.CS-SG.3SG bite.NF  
'Which boy<sub>i</sub> did his<sub>i</sub> goat bite?'

It is worth noting that topicalization does not plausibly involve a scrambling step of the object over the subject, as has been suggested for ameliorations of Weak Crossover in German (e.g. Wiltschko 1998). In addition, these facts obtain regardless of whether the movement is local or long-distance. The example in (36a) attests that even long-distance movement of an embedded nominal to Spec-CP allows it to initiate variable binding, in this case into the matrix subject.

(36) *No WCO with long-distance movement to Spec-CP:*

- a. **Mòc ébén<sub>i</sub>** à-yíi tiéey-dè<sub>i</sub> luéel [<sub>CP</sub> è \_\_\_ thèt].  
**man every** 3S-HAB.OV woman-SG.3SG say.NF c cook.SV  
'Every man<sub>i</sub>, his<sub>i</sub> wife says is cooking.'
- b. Yè **ŋà** [<sub>CP</sub> Op yíi tiéey-dè<sub>i</sub> luéel [<sub>CP</sub> è níéer Bòl \_\_\_]]?  
be **who** HAB.OV wife-SG.3SG say.NF c love.OV Bol.GEN  
'Who does his wife say Bol loves?'

12. Note that clefts do show sensitivity to Weak Crossover in other languages:

(i) *Wh-clefts show Weak Crossover in English:*

- a. Who<sub>i</sub> is it [<sub>CP</sub> that \_\_\_ likes her<sub>i</sub> mother]?  
b. \*Who<sub>i</sub> is it [<sub>CP</sub> that her<sub>i</sub> mother likes \_\_\_]?

Movement to Spec-CP then clearly differs from familiar cases of  $\bar{A}$ -movement, because it is never subject to Weak Crossover. Instead, long-distance movement in Dinka shares with A-movement the property of being able to supply novel antecedents for variable binding.

A similar picture emerges with anaphor binding, which I proposed also requires abstraction over individuals. As described previously, Dinka has a Condition A anaphor that must be bound in the smallest TP in which it is contained. Unlike in English, however, this anaphor can be bound at Spec-CP both by local and long-distance topicalization (37a–b).<sup>13</sup>

(37) *Dinka anaphor can be bound from Spec-CP:*

- a. **Bòl<sub>i</sub>** à-cíi [DP àkékòol-tí è ròt-dè<sub>i</sub>] \_\_\_ píòolic.  
**Bol** 3S-PRF.OV story-that P **self-sg.3sg** criticize.NF  
 ‘Bol, that story about himself has criticized.’
- b. **Bòl<sub>i</sub>** à-cíi [DP thùrá è ròt-dè<sub>i</sub>] nyòoth [CP kè cùukù \_\_\_ tìiŋ].  
**Bol** 3S-PRF.OV picture P **self-sg.3sg** show.NF C PRF.1PL see.NF  
 ‘Bol, a picture of himself has shown that we have seen.’

Topicalization then patterns with A-movement in creating new antecedents for anaphor binding.

It is worth noting that, although long-distance movement allows a nominal to bind an anaphor contained within the subject, anaphor binding seems to be subject to a Strong Crossover effect in Dinka. The anaphor cannot c-command a lower copy of its binder, so that an object cannot move to bind a subject anaphor, for instance (38a–b).

(38) *Anaphor cannot be subject bound by movement:*

- a. \***Ròòor<sub>i</sub>** áa-cíi ròth-kén<sub>i</sub> ké tìiŋ.  
**men** 3S-PRF.OV **self.PL-PL.3PL** 3PL see.NF  
 ‘The men, themselves have seen.’
- b. \*Yè **kòoc-kó<sub>i</sub>** [CP Op cíi ròth-kén<sub>i</sub> ké tìiŋ].  
 be **people.cs-which** PRF.OV **self.PL-PL.3PL** 3PL see.NF  
 ‘Which people have themselves seen?’

McGinnis (2004) argues that anaphors differ cross-linguistically in whether they are subject to Strong Crossover with A-movement. Rizzi (1986), for example, observes that A-movement in Italian differs from A-movement in English in this respect. Passivization or raising of an antecedent over an anaphor is prohibited (39a–b).

(39) *Italian passivization and raising do not feed anaphor binding:*

- a. \***Gianni<sub>i</sub> si<sub>i</sub>** è stato affidato \_\_\_.  
**Gianni self** was been entrusted  
 ‘Gianni was entrusted to himself.’

13. See Charnavel and Sportiche (to appear) for evidence that anaphors inside *picture-of*-NPs are locally bound.

- b. \*Gianni<sub>i</sub> si<sub>i</sub> sembra [\_\_\_ non fare il suo dovere].  
 Gianni self seems not do.NF the his duty  
 ‘Gianni seems to himself not to do this duty.’  
 (Italian; Rizzi 1986:70,76)

As McGinnis points out, similar behavior is found in Albanian, in which passivization of a direct object over an indirect object does not facilitate anaphor binding (40).

(40) *Passivization in Albanian does not feed anaphor binding:*

- \*Drita<sub>i</sub> iu tregua vetes<sub>i</sub> \_\_\_ prej artistit.  
 Drita.NOM CL SHOW.NACT self.DAT by the.artist  
 ‘Drita was shown herself by the artist.’  
 (Albanian; Massey 1992:71)

McGinnis proposes that what differentiates these cases from English, in which anaphors do not display Strong Crossover, is that they necessarily involve derivations in which the anaphor and the binder occupy a specifier of the same head at some point, leading to what she calls “Lethal Ambiguity”. I will not go into the details of her proposal here, but, if the empirical generalization she proposes is correct, then we expect movement over a subject anaphor to create the same problem, if subjects are generated in Spec-*v*P.<sup>14</sup> Movement across the subject should then involve an intermediate movement step to a specifier of the same *v* head.<sup>15</sup> As a result, the same Lethal Ambiguity issue arises.

In fact, as McGinnis observes, the pattern described for Dinka above is found in many languages that allow A-scrambling of objects over subjects. In Georgian, for instance, scrambling of an object across the subject allows the object to bind an anaphor inside the subject, but not a subject anaphor itself (41a–b).

(41) *Georgian A-scrambling shows Strong Crossover for anaphor binding:*

- a. Nino-s<sub>i</sub> [<sub>DP</sub> tavis<sub>i</sub> deida] \_\_\_ xaṭav-s.  
 Nino-ACC self.POSS aunt.NOM draw-PRES  
 ‘Nino, her aunt is drawing.’  
 b. \*Vano-s<sub>i</sub> tavis<sub>i</sub> tav-i<sub>i</sub> \_\_\_ xaṭav-s.  
 Vano-ACC self.POSS self-NOM draw-PRES  
 ‘Vano, himself is drawing.’  
 (Georgian; McGinnis 2004:55)

Similar facts have been reported for scrambling in German, Hindi, Korean, and Japanese (for references, see McGinnis 2004:55). I conclude from this that A-movement across a subject typically,

14. This Strong Crossover effect may then provide evidence for the first option for the structure of the verb phrase discussed in section 3.1 of Chapter 3.

15. See Chapter 5 for extensive evidence for this movement step in Dinka.



perhaps even always, shows a Strong Crossover effect for anaphor binding. With regard to anaphor binding, Dinka long-distance movement then patterns with A-movement, just as we saw for Weak Crossover effects.

#### 4.2 Reconstruction for Principle C

Another difference between A-movement and  $\bar{A}$ -movement with regard to binding is found with Principle C effects. In Chapter 2, I adopted the idea that this is because of the availability of Wholesale Late Merger in A-movement, following Takahashi and Hulse (2009). In Dinka, however, I have argued that  $\bar{A}$ -movement co-occurs with case assignment. As a result, just in this instance, Wholesale Late Merger should be able to accompany movement driven by an  $\bar{A}$ -feature, since the Case feature on the NP can still be valued in the position targeted.

In accordance with this, we find that movement to Spec-CP in Dinka again patterns with A-movement in being able to avoid reconstruction for Principle C. Let me first show that, as in many languages, coreference relations are restricted by Principle C in Dinka. The examples in (42a–b) demonstrate.

(42) *Dinka shows Principle C effects:*

- a. \**pro*<sub>i</sub> à-cé mánh è Màyéni còl.  
           3s-PRF.SV brother.CS P Mayen call.NF  
           ‘He<sub>k/\*i</sub> has called a brother of Mayen<sub>i</sub>.’
- b. \**Yéen*<sub>i</sub> à-cé mánh è Màyéni còl.  
           3sg 3s-PRF.SV brother.CS P Mayen call.NF  
           ‘He<sub>k/\*i</sub> has called a brother of Mayen<sub>i</sub>.’
- c. [DP Mèth-è [CP cé yéen<sub>i</sub> t<sub>ij</sub>]] à-nhiàr Bòl<sub>i</sub>.  
           child-this PRF.SV 3sg see.NF 3s-love.sv Bol  
           ‘This child that has seen him<sub>i</sub> loves Bol<sub>i</sub>.’

In (42a–b), an initial pronoun c-commands a proper name and so may not be coreferential with it, regardless of whether the pronoun is null or overt.<sup>16</sup> However, if the pronoun does not c-command the proper name (42c), coreference is fine, demonstrating that this is not a linear precedence effect.

Violations of Principle C as in (42a–b) can be fixed by moving the phrase that contains the proper name to Spec-CP. As (43a) shows, topicalization does not require reconstruction for Principle C, and patterns just like *wh*-clefts (43b).

16. *Pro*-drop in Dinka is restricted to clause-initial position and exclusively targets 3rd person DPs, giving rise to a partial *pro*-drop pattern of sorts. It may seem initially plausible to link this to the fact that only 3rd person DPs trigger overt agreement, but this cannot be the full story. There are clauses in which no overt agreement is found for 3rd person DPs (interrogative clauses, for example). In such environments, the same partial *pro*-drop pattern is found.

(43) *No reconstruction for Principle C:*

- a. [DP Mánh è Màyèn kù Àyén<sub>i</sub>] cìikè<sub>i</sub> \_\_\_ tìij.  
 brother.CS P Mayen.GEN and Ayen PRE.3PL see.NF  
 ‘The brother of Mayen and Ayen<sub>i</sub>, they<sub>i</sub> have seen.’
- b. Yè [DP mánh è Màyèn kù Àyén<sub>i</sub>-ó] [CP Op cìikè<sub>i</sub> \_\_\_ tìij]?<sup>17</sup>  
 be brother.CS P Mayen.GEN and Ayen-which PRE.3PL see.NF  
 ‘Which brother of Mayen and Ayen<sub>i</sub> have they<sub>i</sub> seen?’

This is true regardless of whether movement is local or long-distance, as in the examples in (44a–b).

(44) *No reconstruction for Principle C with long-distance movement:*

- a. [DP Mánh è Màyèn kù Àyén<sub>i</sub>] à-yùukù tàak [CP cìikè<sub>i</sub> \_\_\_ tìij].  
 brother P Mayen.GEN and Ayen 3S-HAB.1PL think.NF PRE.3PL see.NF  
 ‘The brother of Mayen and Ayen<sub>i</sub>, we think they<sub>i</sub> have seen.’
- b. Yè [DP mánh-ó è Màyèn kù Àyén<sub>i</sub>] [CP Op yùukù tàak [CP cìikè<sub>i</sub> \_\_\_ tìij]?  
 be brother.CS-which P Mayen.GEN and Ayen HAB.1PL think PRE.3PL  
 see.NF  
 ‘Which brother of Mayen and Ayen<sub>i</sub> do we think have they<sub>i</sub> seen?’

I propose that reconstruction is optional in these cases because WLM is possible in Spec-CP. Concretely, this means that a derivation like (45a–b) is possible for an example like (43a). In this derivation, the DP is topicalized to Spec-CP without an NP complement (the determiner in this case happens to be null, but this does not matter). This step is represented in (45a).

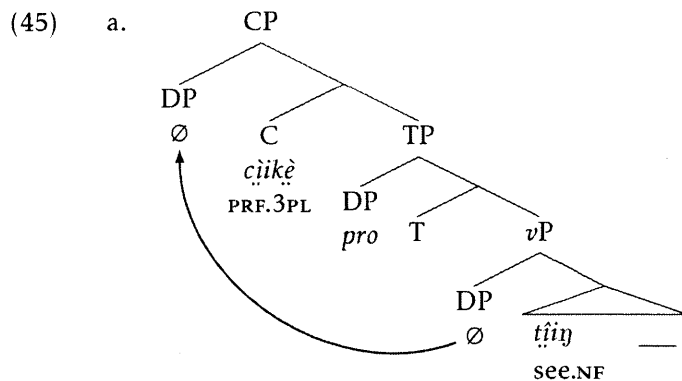

17. As evident in this example, demonstrative elements like -ó (‘which’) have some freedom of attachment within the noun phrase. They may attach directly to the head noun or cliticize onto the last phrase within the DP. Thus, (43b) has a variant in which -ó attaches to head noun (without any discernible effect on the conference judgement).

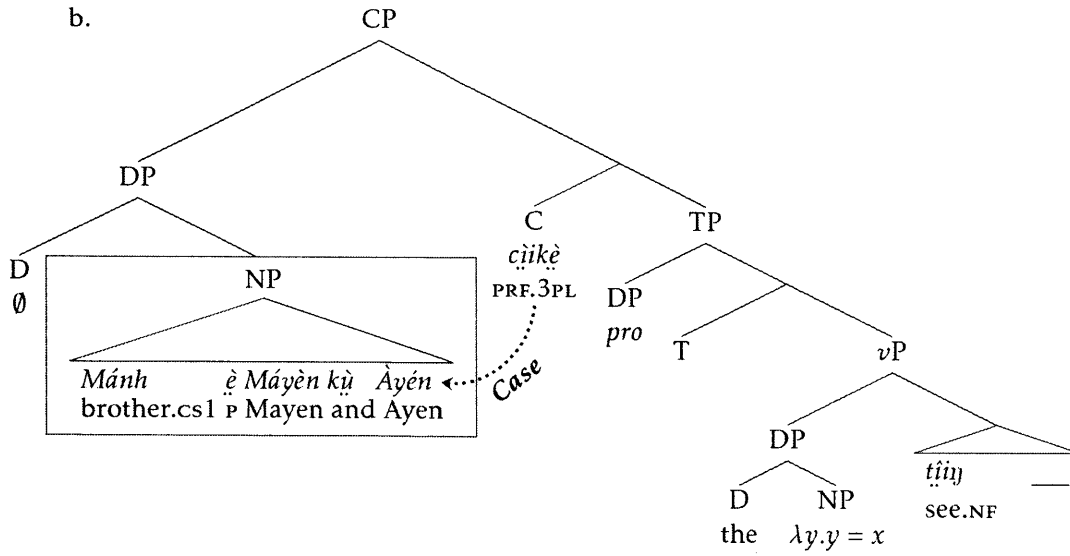

The whole NP containing the coherent proper name may then undergo Wholesale Late Merger in Spec-CP (45b), with Trace Conversion applying to the lower copy. WLM does not run afoul of the Case Filter, because C assigns case to the DP in Spec-CP and so the Case feature of the NP undergoing Late Merge still ends up valued.<sup>18</sup>

Another piece of evidence that Spec-CP in Dinka does not behave like an  $\bar{A}$ -position for binding comes from the interaction of Principle C with anaphor binding. Recall that Dinka's Condition A anaphor can be moved to Spec-CP as long as it can reconstruct for binding (46a–b).

(46) *Reflexive may move and reconstruct for binding:*

- a. Ròt-dè<sub>i</sub> à-cè<sub>i</sub> nhiàar.  
self-SG.3SG 3S-PRF.3SG love.NF  
'Herself/himself, she/he has loved.'
- b. Ròt-dè<sub>i</sub> à-yùukù tàak [CP è cè<sub>i</sub> nhiàar].  
self-SG.3SG 3S-HAB.1PL think.NF C PRF.3SG love.NF  
'Herself/himself, we say that she/he has loved.'

Movement of the anaphor is constrained by Principle C, however. If the anaphor is bound by a non-pronominal DP, it cannot move to a c-commanding position (47a–b).

(47) *Anaphor triggers Principle C:*

- a. Bòl à-nhiàr ròt-dè<sub>i</sub>.  
Bol 3S-love.sv self-SG.3SG  
'Bol loves himself.'

18. As detailed in Chapter 3, I assume that the entire DP is also assigned case at Spec-*vP* and thus ends up being assigned case multiple times. This should not affect the availability of WLM.

- b. \*Ròt-dè<sub>i</sub> à-nhiéer Ból<sub>i</sub>.  
**self-sg.3sg** 3s-love.ov **Bol.GEN**  
 ‘Himself, Bol loves.’

The contrast between pronouns and proper names in this respect is particularly clear in (48a–c). An embedded pronominal subject can bind an anaphor and be coreferent with a c-commanding proper name (48a). If that anaphor is topicalized, however, then the proper name c-commanding the subject pronoun (*Ból*) can no longer be coreferent with the pronoun and the anaphor (48b–c).

(48) *Principle C effect with anaphors affects coreference relations:*

- a. À-yíi Ból<sub>i/k</sub> luéeel [<sub>CP</sub> è nhiéer<sub>i</sub> ròt-dè<sub>i</sub>].  
 3s-HAB.OV **Bol.GEN** say.NF c **love.3sg self-sg.3sg**  
 ‘Bol says that he loves himself.’
- b. \*Ròt-dè<sub>i</sub> à-yíi Ból<sub>i</sub> luéeel [<sub>CP</sub> è nhiéer<sub>i</sub>].  
**self-sg.3sg** 3s-HAB.OV **Bol.GEN** say.NF c **love.3sg**  
 ‘Himself, Bol says that he loves.’
- c. Ròt-dè<sub>k</sub> à-yíi Ból<sub>i</sub> luéeel [<sub>CP</sub> è nhiéer<sub>k</sub>].  
**self-sg.3sg** 3s-HAB.OV **Bol.GEN** say.NF c **love.3sg**  
 ‘Himself, Bol says that he loves.’

These facts serve as a clear illustration that movement in Dinka is different from instances of pure A- or  $\bar{A}$ -movement. The patterns in (47a–b) and (48a–c) have no analog in either type of movement, because it combines properties of A-movement (an anaphor inducing a Principle C effect) with properties of  $\bar{A}$ -movement (an anaphor moving over a c-commanding antecedent).

To sum up briefly, movement in Dinka behaves for the purposes of binding like A-movement, even though it has the locality profile of  $\bar{A}$ -movement. I showed that long-distance movement in Dinka differs from long-distance movement in other languages in being accompanied by  $\varphi$ -agreement. The resulting mixed behavior then provides an argument that the features that distinguish A-movement derive from the Agree relation that it involves.

## 5 $\bar{A}$ -movement with A-properties in other languages

In this chapter so far, I have argued that Dinka provides evidence that a prediction of a featural approach is correct: there are languages in which the co-occurrence of  $\varphi$ -probing and  $\bar{A}$ -probing gives rise to movements with A- and  $\bar{A}$ -properties. In this section, I show that similar facts are found in a number of language families. I start by showing that this view has the potential to shed light on the long-standing issue in the literature on Austronesian voice systems of whether voice involves  $\bar{A}$ -movement or A-movement (e.g. Guilfoyle, Hung, and Travis 1992; Richards 2000; Pearson 2001, 2005), borne out of the observation that long-distance movement systematically

affects case in these languages. I then discuss evidence from Bantu languages that  $\bar{A}$ -movement may co-occur with  $\varphi$ -agreement (e.g. Kinyalolo 1991; Carstens 2003; Henderson 2006). We will see that Dinka can be seen as the combination of the Austronesian pattern (case alternations with voice morphology) and Bantu ( $\varphi$ -agreement with long-distance movement), suggesting that these systems underlyingly have a similar syntax.

### 5.1 Austronesian and the A/ $\bar{A}$ -distinction

A long-standing question in the literature on Western Austronesian voice systems like Malagasy or Tagalog is whether voice signals the presence of  $\bar{A}$ -movement (e.g. Richards 2000; Pearson 2001, 2005) or A-movement (e.g. Guilfoyle, Hung, and Travis 1992; Aldridge 2004, 2008). This section suggests that treating these systems like Dinka may explain why this has proven difficult to resolve.

In all voice systems, voice indicates the grammatical function of a nominal in the unmarked case form, as in Dinka. We can see this, for instance, in Malagasy, in which voice tracks the XP in sentence-final position, always a DP in the unmarked case. The examples in (49a–c), repeated from Chapter 3, illustrate.

(49) *Voice in Malagasy indicates grammatical function of sentence-final nominal:*

- a. Mamono ny akoho amin'ny antsy **ny mpamboly**  
sv.kill DET chicken with-DET knife **DET farmer**  
'The farmer is killing chickens with the knife.'
- b. Vonoin' ny mpamboly amin'ny antsy **ny akoho**  
ov.kill DET farmer with-DET knife **DET chicken**  
'The chickens, the farmer is killing with the knife.'
- c. Amonoan' ny mpamboly ny akoho **ny antsy**  
OBLV.kill DET farmer DET chicken **DET knife**  
'The knife, the farmer is killing the chickens with.'  
(Malagasy; Pearson 2005:389–390)

As in Dinka, this gives rise to case alternations, because nominals may appear in different cases when not in sentence-final position.

Voice morphology can be fed by long-distance movement, just like in Dinka. Pearson (2005) shows for Malagasy that the sentence-final position may be the target of long-distance topicalization, as the examples in (50a–b) attest.<sup>19</sup>

(50) *Long-distance movement to sentence-final position in Malagasy:*

- a. Heverin-dRabe [<sub>CP</sub> mandidy ny mofo amin'ny antsy] **ny vehivavy**  
ov.think-Rabe sv.cut DET bread with-DET knife **DET woman**  
'The woman, Rabe thinks is cutting the bread with the knife.'

19. As Pearson points out, we can tell that the bolded phrases in (50a–b) can be in the matrix clause by the positioning of the *yes-no* particle *ve*, which immediately precedes the noun phrase in sentence-final position.

- b. Heverin-dRabe [<sub>CP</sub> didian' ny vehivavy amin'ny antsy] **ny mofo**  
 ov.think-Rabe      ov.cut DET woman with-DET knife **DET bread**  
 'The bread, Rabe thinks the woman is cutting with the knife.'  
 (Malagasy; Pearson 2005:434)

In these systems then, we also see that local and long-distance movement generally require the moving phrase to be a nominal, with effects on case and voice.

In accordance with this, there is evidence that many Western Austronesian languages display similar behavior to Dinka with regard to binding. Movement of a quantifier to sentence-final position is not sensitive to Weak Crossover in Malagasy, as the examples in (51a–b) show. Voice alternations have a similar effect in Tagalog (51c–d), and in Acehnese (51e–f).

(51) *Absence of Weak Crossover in Malagasy and Tagalog:*

- a. \*Nanorka [<sub>DP</sub> **ny vehivavy rehetra<sub>i</sub>**] ny **vadiny<sub>i</sub>**  
 PST.SV.kiss      DET woman all      DET spouse.3  
 'Their<sub>i</sub> spouse(s) kissed all the women<sub>i</sub>.'
- b. Norohan' ny **vadiny<sub>i</sub>** [<sub>DP</sub> **ny vehivavy rehetra<sub>i</sub>**]  
 PST.OV.kiss DET spouse.3      DET woman all  
 'All the women<sub>i</sub>, their<sub>i</sub> spouse(s) kissed'  
 (Malagasy; Pearson 2005:427)
- c. \*Nagmamahal ang **kanyang<sub>i</sub>** ama ng **bawat anak<sub>i</sub>**.  
 sv.love      CS his      father GEN every child  
 'His<sub>i</sub> father loves every child<sub>i</sub>.'
- d. ?Minamahal ng **kanyang<sub>i</sub>** ama ang **bawat anak<sub>i</sub>**.  
 ov.love      GEN his      father CS every child  
 'Every child<sub>i</sub>, his<sub>i</sub> father loves.'  
 (Tagalog; Richards 2000)
- e. **Tieptiep aneuk<sub>i</sub>** mak droe-**jih<sub>i</sub>** lindong.  
 every child mother self-3<sub>FAM</sub> protect  
 'Every child, his/her<sub>i</sub> mother protects.'
- f. **Karap mandum mured<sub>i</sub>** gurè droe-**jih<sub>i</sub>** peu-runoe.  
 almost all      student teacher self-3<sub>FAM</sub> CAUS-learn  
 'Almost all the students<sub>i</sub>, their<sub>i</sub> own teachers taught.'  
 (Acehnese; Legate 2014:50)

We also find an absence of Weak Crossover with *wh*-movement, as in the examples from Tagalog and Atayal in (52a–b).

(52) *Absence of Weak Crossover in Tagalog and Atayal:*

- a. **Sino<sub>i</sub>** ang s-in-ampal nang asawa **niya<sub>i</sub>**?  
**who** CS slap.OV GEN spouse 3SG.GEN  
'Who did his<sub>i</sub>/her<sub>i</sub> spouse slap?'  
(Tagalog; Kaufman 2009:37)
- b. **Ima<sub>i</sub>** ku tuting-un ni **yaya nia<sub>i</sub>**?  
**who** ABS hit-PV ERG other 3SG.GEN  
'Who<sub>i</sub> did his<sub>i</sub> mother hit?'  
(Atayal; Huang and Lin 2012)

As in Dinka, movement for voice also does not necessarily reconstruct for Principle C. In Malagasy, a Principle C violation like (53a) can be fixed by moving the DP the offending proper name is contained in to the sentence-final position (53b).

(53) *No reconstruction for Principle C in Malagasy:*

- a. \*Nanamby [<sub>DP</sub> ny zana-**dRakoto<sub>i</sub>**] ariary folo **izy<sub>i</sub>**;  
PST.SV.hire DET child.LNK-**Rakoto** ariary ten 3SG  
'He<sub>i</sub> hired Rakoto<sub>i</sub>'s child for ten ariary.'
- b. **Notambazany<sub>i</sub>** ariary folo [<sub>DP</sub> ny zana-**dRakoto<sub>i</sub>**]  
PST.OV.hire.3SG ariary ten DET child.LNK-**Rakoto**  
'Rakoto<sub>i</sub>'s child, he<sub>i</sub> hired for ten ariary.'  
(Malagasy; Pearson 2005:425)

The same obviation of Principle C effects is found in Acehnese (Legate 2014). Acehnese does not allow a pronominal subject to c-command a coreferential proper name contained in the object (54a), unless the object DP is topicalized (54b).

(54) *No reconstruction for Principle C with Object Voice in Acehnese:*

- a. \*Ka **awaknyan<sub>i</sub>** jaga [<sub>DP</sub> mie **aneuk-aneuk miet<sub>i</sub>** nyan].  
PERF 3PL care.for cat **child-child small** DEM  
'They have taken care of the children's cat.'
- b. [<sub>DP</sub> Mie **aneuk-aneuk miet<sub>i</sub>** nyan] **awaknyan<sub>i</sub>** poh \_\_\_\_.  
cat **child-child small** DEM 3PL hit  
'The children's cat, they have hit.'  
(Acehnese; Legate 2014:49)

One apparent difference between some Western Austronesian systems and Dinka relates to reflexives. As discussed previously, Dinka reflexives can be topicalized, but only if their antecedent is pronominal. Reflexives trigger a Principle C effect with respect to coreferential proper names. This is not true across voice systems. In Tagalog, for instance, an object reflexive can be bound by a lexical DP subject in the Subject Voice and Object Voice (55a–b).

(55) *Tagalog reflexive allows Object Voice when bound by lexical DP:*

- a. Nagmamahal si Juan sa kanyang sarili.  
sv.love cs Juan cs his self  
'Juan loves himself.'
- b. Minamahal ni Juan ang kanyang sarili.  
ov.love GEN Juan cs his self  
'Juan loves himself.'
- (Tagalog; Richards 2000:107)

If this voice alternation reflects topicalization (e.g. Richards 2000), this pattern diverges from the Dinka one. However, there are Austronesian voice systems that display the Dinka pattern. In Balinese, a reflexive may be topicalized, but only if its binder is a pronominal (56a–b).<sup>20</sup>

(56) *Balinese reflexive can move over pronoun:*

- a. **Ia<sub>i</sub>** ningalin **awakne<sub>i</sub>**  
**3sg** sv.see **self**  
'She/he saw herself/himself.'
- b. **Awakne<sub>i</sub>** tingalin-**a<sub>i</sub>** \_\_\_\_  
**self** ov.see-**3sg**  
'Herself/himself, she/he saw.'
- (Balinese; Wechsler and Arka 1998:406)

As Wechsler and Arka (1998) observe, topicalization is impossible if the reflexive is bound by a lexical DP, such as the indefinite *cicing* ('a dog') in (57a–b).

(57) *Balinese reflexive cannot c-command lexical DP:*

- a. **Cicing<sub>i</sub>** ngugut **awakne<sub>i</sub>**  
**dog** sv.bite **self**  
'A dog bit itself.'
- b. \***Awakne<sub>i</sub>** gugut **cicing<sub>i</sub>** \_\_\_\_  
**self** ov.bite **dog**  
'Itself, a dog bit.'
- (Balinese; Wechsler and Arka 1998:407)

I will not explore the issue of what is responsible for this difference, but I speculate it reflects a difference in the syntax of the reflexive in Balinese and Dinka, on the one hand, and in languages like Tagalog, on the other.

It should be clear that many Austronesian voice systems have a lot in common with Dinka. Apparent instances of  $\bar{A}$ -movement typically co-occur with changes in case and binding relations

---

20. My thanks to Ted Levin for bringing these facts to my attention.



and so it is hard to draw a sharp distinction between A- and  $\bar{A}$ -movement. I propose that, in these systems, just as in Dinka,  $\bar{A}$ -features are introduced on the same head as a feature driving A-movement, and long-distance movement is driven by a composite probe. One notable difference between Dinka and the systems described above is that changes in voice correlate with changes in overt  $\varphi$ -agreement in Dinka. We might then postulate covert  $\varphi$ -agreement in these languages, with the same repercussions for case and binding. In the next section, we will see that many Bantu languages display a  $\varphi$ -agreement pattern similar to what is found in Dinka, but without similar changes in case morphology.

## 5.2 Agreement and $\bar{A}$ -movement in Bantu

In many Bantu languages,  $\bar{A}$ -movement to the left edge of the clause is accompanied by  $\varphi$ -agreement (Nsuka 1982; Kinyalolo 1991; Carstens 2003, 2005; Henderson 2006). Kinyalolo (1991), for instance, describes agreement patterns in Kilega which closely resemble the agreement facts found in Dinka. The examples in (58a–b) show this for *wh*-movement. Kilega allows both in situ and fronted *wh*-phrases. When the *wh*-phrase fronts, it governs  $\varphi$ -agreement on the following verb instead of the subject (58a–b).<sup>21</sup>

### (58) *Wh-movement accompanied by $\varphi$ -agreement in Kilega:*

- a. Bábo bíkulu b-á-kás-íl-é mwámí **bíkí** mu-mwílo?  
 2that 2woman 2SA-ASP-give-ASP-FV 1chief **8what** 18-3village  
 ‘What did those women give the chief in the village?’
- b. **Bíkí** bí-á-kás-íl-é bábo bíkulu mwámí mu-mwílo?  
**8what 8RM-ASP-give-ASP-FV** 2that 2woman 1chief 18-3village  
 ‘What did the woman give the chief in the village?’  
 (Kilega; Kinyalolo 1991:21)

As in Dinka, this process is insensitive to grammatical function. Any type of *wh*-phrase will trigger  $\varphi$ -agreement (59a–b).

### (59) *Agreement with wh-phrases insensitive to grammatical function:*

- a. Názi ú-ku-kít-ag-a búbo?<sup>22</sup>  
 1who **1RM-PROG-DO-HAB-FV** 14that?  
 ‘Who (usually) does that?’
- b. Kúni **ku-ta-bá-ku-yan-ág-á** mukindi?  
 16where **16RM-NEG-2SA-PROG-play-HAB-FV** 18-7night  
 ‘Where don’t they (usually) play at night?’  
 (Kilega; Kinyalolo 1991:20,58)

21. Following Kinyalolo, I gloss the agreement prefix that co-occurs with an  $\bar{A}$ -operator as RM for *relative marker* (see also fn. 22).

In addition, these changes in agreement patterns are found with a range of  $\bar{A}$ -movement constructions. In (60a–c), we see  $\varphi$ -agreement with the relative operator in relative clauses.

(60) *Agreement accompanies relativization:*

- a. Mwána [<sub>CP</sub> Op **ú**-ku-kit-ág-á búbo] á-ku-yan-á na mbwá  
 1child 1RM-PROG-DO-HAB-FV 14that 1SA-PROG-play-FV with 9dog  
 ku-mbúga.  
 17-outside  
 ‘The child who usually does that is playing with the dog outside.’
- b. Bitondo [<sub>CP</sub> Op **bí**-ku-ténd-a úzo mwána] ta-bí-lí.  
 8word 8RM-PROG-say-FV 1that 1child NEG-8SA-be  
 ‘The words that that child is saying are not good.’
- c. mwána [<sub>CP</sub> Op **u**-mu-k-énd-a ná-gé ku-Ngando]  
 1child 1RM-2PL-FUT-GO-FV with-AGR 17-Ngando  
 ‘the child with whom you will go to Ngando’  
 (Kilega; Kinyalolo 1991:23)

Finally, topicalization also co-occurs with by  $\varphi$ -agreement, as shown for objects and locatives in (61a–b). As in Dinka, the same agreement series as in subject-initial clauses is employed.<sup>23</sup>

(61) *Agreement accompanies object and locative topicalization:*

- a. Maku ta-**má**-ku-sol-ág-á mutu wéneéné.  
 6beer NEG-6SA-PROG-drink-HAB-FV 1person alone  
 ‘No one usually drinks beer alone.’
- b. Mu-zizo nyumbá **mu**-á-nyám-é bána wálúbí.  
 18-10that 10house 18SA-ASP-sleep-FV 2child one.day  
 ‘There will sleep children in those houses tomorrow.’  
 (Kilega; Kinyalolo 1991:18,28)

Similar kinds of interaction between  $\bar{A}$ -movement and  $\varphi$ -agreement are found across Bantu (e.g. Bokamba 1981; Nsuka 1982; Carstens 2003; Henderson 2006, 2011; Buell et al. 2011). There are at least two common sources of variation in these patterns, which I will briefly discuss. Bantu

22. The  $u$ -agreement noun class 1 prefix that surfaces in this example is distinct from the agreement found with noun class 1 subjects that are not *wh*-phrases. This difference is what leads Kinyalolo to distinguish the relative marker from subject agreement in clauses without  $\bar{A}$ -movement. Without other noun classes, the two agreement series are identical, as evident, for instance, in (60b). This has often been treated as an anti-agreement effect, because person distinctions are lost (e.g. Kinyalolo 1991; Henderson 2013).

23. These constructions are usually discussed as subject-object reversal and locative inversion and not always treated as topicalization (e.g. Ndayiragije 1999). In Kilega, as Henderson (2006:743) notes, at least object fronting can be long-distance, strongly implicating  $\bar{A}$ -movement. However, these processes cannot always be long-distance and often have interpretive effects on the subject (as evident in (61a–b), Kilega subjects must be understood as non-specific in these constructions). I will not investigate these differences in detail here, though see Henderson 2006, 2011 for some discussion.

languages differ in how agreement with  $\bar{A}$ -operators interacts with subject agreement. In the Kilega examples above, subject agreement is replaced, but the two types of agreement often co-occur as well. In (62a–b), from Kinande and Lingala,  $\bar{A}$ -agreement appears on a separate relative complementizer.

(62)  *$\bar{A}$ -agreement may co-occur with subject agreement:*

- a. Ekihi **ky-o** Kambala a-langira?  
 7what 7RM-REL 1Kambala 1SA-saw  
 ‘What did Kambale see?’  
 (Kinande; Schneider-Zioga 2007:10)
- b. mukanda **mú-ye** baasi ba-tind-aki awa  
 5letter 5RM-REL 2women 2SA-send-PST here  
 ‘the letter that the women sent here’  
 (Lingala; Bokamba 1981:39)

In addition to this,  $\varphi$ -agreement may behave differently across constructions. Some Bantu languages allow only relative clauses in which the relative operator is not agreed with, as in Kirundi (63a) (though see Henderson 2011:747 for discussion), or only topicalization constructions without agreement, as in Makhuwa (63b).

(63) *Variation in agreement across  $\bar{A}$ -movement types:*

- a. ibitabo [<sub>CP</sub> Op Yohani a-ta-á-somye]  
 8books 1John 1SA-NEG-PST-read.PERF  
 ‘the books that John didn’t read’  
 (Kirundi; Ndayiragije 1999:419)
- b. eshímá elá o-hoó-cá Yuúra  
 9shima 9DEM 1SA-PERF.DJ-eat Yura  
 ‘This shima, Yura ate.’  
 (Makhuwa; Van der Wal 2009:177)

Like Dinka, Bantu languages then often do not display a distinction between dependencies that affect  $\varphi$ -agreement and those that do not. I propose then that features driving  $\bar{A}$ -movement are bundled together with a  $\varphi$ -probe, as argued also by Kinyalolo (1991), Carstens (2003, 2005) and Henderson (2006, 2011), among others. One of the things Bantu languages teach us is that a  $\varphi$ -probe may co-occur only with some  $\bar{A}$ -probes, as the examples in (63a–b) demonstrate, as we might expect if different types of  $\bar{A}$ -movement are established by different probing features.<sup>24</sup>

If Dinka and Bantu are indeed similar in this way, the approach to the A/ $\bar{A}$ -distinction developed here makes the strong predictions that Bantu should display the same behavior with regard to other A-properties such as reconstruction for Principle C or Weak Crossover. There is some

24. See also discussion in section 3 of Chapter 5.

initial indication that this may be so, though a thorough investigation of this prediction remains necessary. Wasike (2007) observes that Lubukusu clefts lack Weak Crossover effects (64a–b).

(64) *No Weak Crossover in Lubukusu clefts:*

- a. **Naanu<sub>i</sub>** ni-y-e [DP maayi **wewe<sub>i</sub>**] a-a-siim-a?  
**who** PRED-1RM-PRON 1mother 3sg 1-PRES-love-FV  
 ‘Who<sub>i</sub> does his/her<sub>i</sub> mother love?’
- b. **Naanu<sub>i</sub>** ni-y-e [DP maayi **wewe<sub>i</sub>**] a-a-par-a [CP a-li Wafula  
**who** PRED-1RM-PRON 1mother 3sg 1-PRES-think-FV 1-SUB 1Wafula  
 a-a-siim-a]?  
 1-PRES-love-FV  
 ‘Who<sub>i</sub> does his/her<sub>i</sub> mother think that Wafula loves?’  
 (Lubukusu; Wasike 2007:301)

Similar facts are described for Lusaamia in Obata and Epstein (2011), as demonstrated by the example in (65).<sup>25</sup>

(65) *No Weak Crossover in Lusaamia:*

- Wina<sub>i</sub>** yi [DP embwa **eyae<sub>i</sub>**] i-ya-khera?  
**1who** 1RM 9dog **9his** 9SA-PRES-love  
 ‘Who<sub>i</sub> does his<sub>i</sub> dog love?’  
 (Carstens p.c., cited in Obata and Epstein 2011:143)

From this discussion, it should be clear that, as remarked by many linguists,  $\varphi$ -agreement in Bantu does not obviously distinguish between A- and  $\bar{A}$ -movement. The interaction of  $\varphi$ -agreement and long-distance movement found across Bantu closely resembles the Dinka patterns.

In this section, I have shown that the case alternations that co-occur with long-distance movement in Dinka are commonly found in Austronesian languages with voice systems, with similar repercussions for binding though without alternations in  $\varphi$ -agreement. Bantu languages display the same alternations in  $\varphi$ -agreement, but without changes in case (and possibly with similar consequences for binding). This provides additional evidence for the claim that languages need not sharply distinguish A- and  $\bar{A}$ -movements.

One way of viewing Dinka is as the combination of Austronesian case alternations with the Bantu system of agreement. Because Austronesian languages often do not display subject-verb agreement and Bantu languages often lack overt case (though see Halpert 2012), an interesting possibility is that all three systems have the same underlying syntax. In this view, Austronesian-voice systems would covertly display the same agreement patterns that are found in Bantu and Bantu languages would underlyingly have the same case relations as in Austronesian. This option

25. See also Henderson 2006 (p. 138–139), as well as Bresnan 1998 for a different view of Weak Crossover in Chichewa.

is particularly attractive if case is treated as a reflex of  $\varphi$ -agreement (e.g. George and Kornfilt 1981; Chomsky 2000, 2001). An alternative approach that I will not explore in detail here could be to distinguish between multiple types of A-movement, depending on whether a  $\varphi$ -probe, a case probe or both features at the same time are involved. Since both  $\varphi$ -features and case are present on every nominal, movement relations sensitive to these features should display similar locality profiles. A possible prediction of this view is that the various A-properties may be distributed unequally across Bantu and Austronesian (if reconstruction for Principle C is tied to case assignment, for example). I will leave open for now the issue of how to capture exactly the similarities between Dinka, Bantu, and Austronesian.

## 6 Summary

In this chapter, I showed that a key prediction of the featural approach to the A/ $\bar{A}$ -distinction is borne out: if movement is accompanied both by Agree relations for  $\varphi$ -features and  $\bar{A}$ -features, it is associated both with A- and  $\bar{A}$ -properties. In particular, we saw that phrasal movement in Dinka combines properties of  $\bar{A}$ -movement (locality and effects on information structure) with properties of A-movement (visibility for case, agreement, and binding). These facts tell us that there are not necessarily radical differences between A- and  $\bar{A}$ -movement, because they need not involve morphosyntactic differences, target disparate positions, or be ordered in a particular way. Instead, these facts provide evidence that differences between A- and  $\bar{A}$ -movement reduce to independent properties of the triggering features.

In the next chapter, I turn to the second major topic of this dissertation: intermediate movement steps of successive-cyclic dependencies. One of the consequences of the central hypothesis of this dissertation, that all differences between movement types derive from the Agree relation, is that intermediate movement must involve an Agree relation also. In Chapter 5, I demonstrate that intermediate movement in Dinka targets the same positions that movement to the final landing site does and has the same morphosyntactic repercussions. On this basis, I argue that intermediate movement too must be driven by a composite probe, and so must be a feature-driven operation (e.g. Chomsky 1995; McCloskey 2002; Abels 2012).



**CHAPTER FIVE**  
**INTERMEDIATE MOVEMENT IN DINKA**

---

In this chapter, I argue that intermediate steps of successive-cyclic dependencies also involve an Agree relation. I show that intermediate movement in Dinka has the same effects on the morphosyntax as final movement steps, so that intermediate movement, like all other instances of movement, must be triggered by a composite probe also, and therefore by Agree (Chomsky 1995; McCloskey 2002; Abels 2012). In addition, I present novel evidence that intermediate movement targets the edge of every clause and every verb phrase (Chomsky 1986 et seq.).

**1 Introduction**

In addition to the difference between A-movement and  $\bar{A}$ -movement, a distinction is often drawn between movement to the final landing site and intermediate movement steps of a longer successive-cyclic chain, such as step ① in (1).

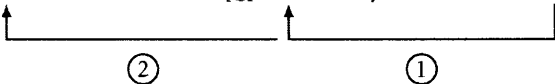
- (1) **Which books** did I think [<sub>CP</sub> — that you had read —]?  

The idea that such movement steps exist goes back at least to Chomsky (1973) and much evidence has accrued for this view since, from a wide variety of languages (e.g. Chung 1982; Clements et al. 1983; Torrego 1984; Henry 1995; McCloskey 2000, 2001). The first task of this chapter is to present data from Dinka in support of the claim that long-distance movement must involve a series of such movement steps to the edge of every clause and every verb phrase, as proposed by Chomsky (1986 et seq.). Dinka provides converging evidence from multiple sources for the idea that clauses consist of two phasal domains, CP and *v*P, as in Chomsky (2001).

At the clausal level, evidence for intermediate movement comes from the interaction of V2 and long-distance movement. Dinka allows V2 in embedded complement clauses and I show that long-distance movement across a clause boundary must transit through each Spec-CP position along the way (see Thiersch 1978 for similar effects in German). Long-distance movement satisfies V2 at each juncture, with concomitant effects on voice and on  $\varphi$ -agreement. Similar evidence for intermediate movement is found at the *v*P edge. Long-distance movement may satisfy the V2 property of the verb phrase, as long as it is capable of valuing all the features on *v*. Independent evidence for movement to the *v*P edge comes from a process of multiple copy spell-out involving plural pronouns, discussed in detail in Chapter 6. In Dinka, we then find reflexes of successive

cyclicity at CP and  $v$ P at the same time, offering support for the idea that clauses universally decompose into these two locality domains (Chomsky 2001).

The second question that this chapter is concerned with is whether intermediate movement steps involve the same syntactic mechanisms as movement to the final landing site. In many languages, intermediate movement steps have few morphosyntactic repercussions and may require somewhat sophisticated diagnostics to detect (e.g. Fox 1999, 2000). As a result of this, many researchers have proposed special mechanisms for intermediate movement, such as adjunction to a maximal projection in Chomsky (1986), for example. But the idea that intermediate movement is exceptional is found in more recent work also. A number of approaches posit a different kind of trigger for intermediate movement (e.g. Heck and Müller 2000, 2003; Bošković 2007; Chomsky 2013; Georgi 2014) or an intrinsic difference in timing (Chomsky 2000; Georgi 2014).

Much of this work (with the exception of Georgi 2014) is based on languages like English, in which  $\bar{A}$ -movement has little effect on the morphosyntax in any case.<sup>1</sup> A good test case for whether intermediate movement is similar to terminal movement is in languages like Dinka, or in Austronesian and Bantu languages, in which  $\bar{A}$ -movement affects more than just the left periphery, but has repercussions for case and agreement. When we look at languages like this, it becomes clear that intermediate movement may look exactly like movement to the final landing site. I demonstrate this in detail for Dinka in the current chapter, but similar facts have been described for Austronesian languages (e.g. Rackowski and Richards 2005 on Tagalog) and Bantu (e.g. Schneider-Zioga 2007 on Kinande).

Based on these Dinka patterns, this chapter argues that intermediate movement is established by the same means as any other type of phrasal movement, namely by Agree and Merge. In this model, intermediate movement, like A-movement and  $\bar{A}$ -movement, is feature-driven Merge, following Chomsky (1995), McCloskey (2002), and Abels (2012). The argument for this view comes from the observation that Dinka does not draw a clear distinction between terminal and intermediate movement. Instead, intermediate movement in Dinka has the same morphosyntactic effects as all other instances of movement. Intermediate movement has predictable repercussions for V2, voice, and  $\varphi$ -agreement. On this basis, I conclude that intermediate movement is triggered by probing features on intermediate phase heads (Chomsky 1995; McCloskey 2002; Abels 2012). To be precise, I argue that the right analysis of the interaction of the left periphery with intermediate movement in Dinka requires that it is driven by a *composite probe*, consisting of a  $\varphi$ -probe and an  $\bar{A}$ -probe, just as I posited for final movement to Spec-CP in Chapter 4. We will see that this proposal makes sense of the reflexes of intermediate movement in Dinka as well as the interplay of intermediate movement and object licensing at the  $v$ P edge. Just as I have argued for A-movement and  $\bar{A}$ -movement, the difference between intermediate and terminal movement resides only in the nature of the feature that triggers it.

---

1. Except for T-to-C movement, which is mirrored by the *that*-trace effect in intermediate movement.



The chapter is organized as follows. Section 2 demonstrates that Dinka allows embedded V2 in finite complement clauses and that we can use this to show that long-distance movement involves intermediate movement steps to each Spec-CP position on the path of movement. In section 3, I propose that intermediate movement in Dinka must also be driven by a composite probe and show how this derives the patterns of interaction between V2 and intermediate movement. Section 4 examines the V2 effect found in the verb phrase in more detail, setting the stage for section 5. In section 5, I use the V2 effect to demonstrate that intermediate movement must stop off at intermediate Spec-*v*P positions and I derive this from the logic of probing outlined in section 3. Section 6 examines the issue of whether CP and *v*P truly constitute parallel domains. I review the distribution of reflexes of successive-cyclic movement across languages and show that each effect can be found both at the CP and *v*P edge. I conclude that clauses universally decompose into a CP and *v*P phase (Chomsky 1986 et seq.).

## 2 Successive cyclicity and embedded V2 in Dinka

One of the striking features of Dinka is the morphosyntactic evidence it provides for the idea that long-distance movement is successive-cyclic and targets the edge of every clause and the edge of every verb phrase (Chomsky 1973, 1977, 1986 et seq.). I will start this chapter by examining the effects of intermediate movement on the edge of the clause. We will see that intermediate movement satisfies the EPP property of C obligatorily, thus letting us track the path of movement directly. In support of this, Dinka displays intermediate  $\varphi$ -agreement with phrases undergoing long-distance movement.

### 2.1 *Embedded V2 in Dinka*

This section examines embedded V2 in finite complement clauses. This will provide us with the relevant background for an investigation the effects of intermediate movement on voice and V2 in the CP domain. We will see that Dinka has several complementizers that allow or sometimes even require embedded V2, and some complementizers that do not. On this basis, I propose that Dinka has multiple C projections, the lowest of which encodes V2.

Dinka allows embedded V2 in complement clauses. For example, embedded V2 may be found in complement clauses headed by the complementizer *è/nè*.<sup>2</sup> This complementizer allows the same range of voice alternations that are found in matrix clauses, as the examples in (2a–c) demonstrate.

#### (2) *Embedded clauses headed by è/nè may be V2:*

- a. À-yùukù luèeel [CP è Àyén à-cé cuïin câam nè pãal].  
 3S-HAB.1PL say.NF C Ayen 3S-PREF.SV food eat.NF P knife  
 ‘We say that Ayen has eaten food with a knife.’

---

2. The same form as Dinka’s general purpose preposition, likely the source of this complementizer.

- b. À-yùùkù luéel [CP è cuïn à-cíi Áyèn câam nè páal].  
 3S-HAB.1PL say.NF c food 3S-PRF.OV Ayen.GEN eat.NF P knife  
 ‘We say that, food, Ayen has eaten with a knife.’
- c. À-yùùkù luéel [CP è páal à-cénè Áyèn cuïn câam].  
 3S-HAB.1PL say.NF c knife 3S-PRF.OBLV Ayen.GEN food eat.NF  
 ‘We say that, with a knife, Ayen has eaten food.’

In addition, as noted in Chapter 2, clauses headed by è may display V1 order. In such clauses, no nominal is moved to Spec-CP and the clause appears in the default Subject Voice (3).

(3) *Clauses headed by è may be V1:*

- À-yùùkù luéel [CP è cé Áyèn cuïn câam nè páal].  
 3S-HAB.1PL say.NF c PRF.SV Ayen.GEN food eat.NF P knife  
 ‘We say that Ayen has eaten food with a knife.’

Embedded V2 is not restricted to any particular type of embedding verb. V2 is usually an option for declarative finite complement CPs. Another complementizer that appears in such clauses is *kè*, which is found with verbs like *yòòk* (‘find out’) and *tàak* (‘think’). *Kè* must be followed by a V2 clause (4a–c), and does not allow V1 order (4d), unlike è.<sup>3</sup>

(4) *Complementizer kè only allows V2:*

- a. À-cùùkù yòòk [CP kè mòc bé ríj tháal uòòt].  
 3S-PRF.1P find.out.NF c man FUT.SV meat cook.NF house.ESS  
 ‘We have found out that the man will cook meat in the house.’
- b. À-cùùkù yòòk [CP kè ríj bíi môc tháal uòòt].  
 3S-PRF.1P find.out.NF c meat FUT.OV man.GEN cook.NF house.ESS  
 ‘We have found out that, meat, the man will cook in the house.’
- c. À-cùùkù yòòk [CP kè uòòt bènè môc ríj tháal thìn].  
 3S-PRF.1P find.out.NF c house FUT.OBLV man.GEN meat cook.NF in.it.ESS  
 ‘We have found out that, in the house, the man will cook meat.’
- d. \*À-cùùkù yòòk [CP kè bé môc ríj tháal uòòt].  
 3S-PRF.1P find.out.NF c FUT.SV man.GEN meat cook.NF house.ESS  
 ‘We have found out that the man will cook meat in the house.’

Dinka also has a number of complementizers that never allow for V2. One class of these suppresses V2 because the complementizer itself affects voice. Clauses headed by *wúin* (‘when/because’) or *tè* (‘when’), for example, are in the Oblique Voice (5a–b).<sup>4</sup>

3. As the examples in (4a–c) reveal, the V2 position of clauses introduced by *kè* lacks the *à*- prefix found in matrix declaratives. Instead, it is marked the same way as relative clauses and interrogatives. As noted in Chapter 3 (sec. 2.1), such clauses only show overt  $\varphi$ -agreement in the past tense.

4. Recall that Oblique Voice on auxiliaries may be expressed with just Object Voice morphology, as in (5a).

(5) *Complementizers wuïn and tẹ affect Voice:*

- a. Bòl à-cẹ piọu miết [CP wuïn cíi yéen Àyén tịi].  
Bol 3s-PRF heart tastes.good.NF because PRF.OV 3SG.GEN Ayen see.NF  
'Bol has been happy because he has seen Ayen.'
- b. Bòl ée piọu miết [CP tẹ é-céemẹ yéen cujìn].  
Bol 3s.PST heart tastes.good.NF when PST-eat.OBLV 3SG.GEN food  
'Bol was happy when he was eating food.'

These complementizers behave as if they are themselves raised oblique arguments, moving from their base position to the left periphery.

Other complementizers suppress V2 but do not affect voice. The interrogative complementizer *nàa* must be followed by a V1 clause in the default voice (6a–b).

(6) *Interrogative complementizer nàa requires V1:*

- a. Bòl à-gài [CP nàa cà m Àyén cujìn].  
Bol 3s-wonder.sv whether eat.sv Ayen.GEN food  
'Bol is wondering whether Ayen is eating food.'
- b. \*Bòl à-gài [CP nàa Àyén (à-)cà m cujìn].  
Bol 3s-wonder.sv whether Ayen (3s-)eat.sv food  
'Bol is wondering whether Ayen is eating food.'

Dinka differs in this regard from languages which have been analyzed as having TP-level V2, such as Icelandic or Yiddish (e.g. Diesing 1990, 2014; Rögnvaldsson and Þráinsson 1990; Iatridou and Kroch 1993; Þráinsson 2007). In both languages, no complementizer is followed by V1 order. Compare, for instance, the examples in (7a–b) with (6a).

(7) *Icelandic and Yiddish complementizers are not followed by V1:*

- a. Hann spyr [CP hvort Jón taki bækurnar].  
he asks if Jon takes books.the  
'He asks if Jon will take the books.'  
(Icelandic; Þráinsson 2007:397)
- b. Ikh veys nit [CP tsi ot dos bukh hot Maks geleyen].  
I know not whether PRT the book has Max read  
'I don't know whether Max has read the book.'  
(Yiddish; Diesing 1990:66)

Because some complementizer do require V1 order, I will continue to treat V2 in Dinka as CP-level, but I will posit a more articulated left periphery, in the spirit of Rizzi (1997). In particular, I split the C domain into two projections: Fin, responsible for hosting V2 and the locus of movement-driving features in Dinka, and Force. The variation we have seen in how different complementizers

interact with V2 may then be captured by allowing for them to be either Fin or Force heads, as schematized in (8).

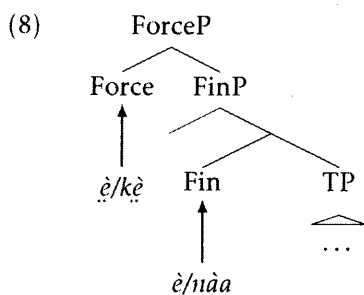

We can capture the interaction of V2 with complementizers much in the same way as in Den Besten’s (1981) analysis of Dutch V2. Den Besten proposes that overt complementizers block V2, because it is the C head that attracts the verb that must be preceded by an overt XP. We can import this analysis into Dinka by ascribing a similar role to Fin. I suggest that the complementizer *kè*, which must precede a V2 clause, instantiates Force, while *è* may instantiate either Force or Fin. This derives the optionality of V2, because it means *è* is optionally followed by the V2-creating Fin.

It is important to note that the larger conclusion I argue for in this chapter, that intermediate movement is feature-driven, does not hinge on whether (8) is the correct treatment of the interaction of V2 with Dinka’s complementizers. An alternative could be to treat Dinka V2 as TP-level. In this view, all the functions traditionally associated with C would be carried out by T in Dinka. For example, this would require that TP is a phase in Dinka, rather than or in addition to CP. As I show in section 6, there is good evidence that the clause constitutes a domain boundary across languages. If TP were the phase in Dinka, this could suggest that languages may vary as to where this domain boundary is drawn exactly. I will mostly abstract away from the structure in (8) and will continue to refer to the position targeted by movement (Spec-FinP in ??) as Spec-CP.

## 2.2 Embedded V2 and intermediate movement

This section examines how embedded V2 interacts with long-distance movement. We will see that every Spec-CP position that lies on the path of movement must be occupied by the moving phrase. In other words, a phrase undergoing long-distance movement does so by means of intermediate movement operations to the edge of each intervening clause. Not only does this provides novel evidence for the claim that long-distance movement is successive-cyclic (Chomsky 1973 et seq.), it demonstrates that Dinka draws no distinction between final and intermediate movement steps of successive-cyclic dependencies. On the basis of this observation, I will argue that intermediate movement too is established by Agree (Chomsky 1995; McCloskey 2002; Abels 2012).

We saw in the previous section that finite complement clauses may display V2. Now consider how embedded V2 interacts with extraction. I illustrate with long-distance relativization in a *wh*-cleft. Observe that long-distance relativization across a CP edge requires first moving to Spec-CP of that clause, so that topicalization of another DP to that position is blocked (9a–f). (In these

examples, I box the relevant intermediate edge positions for expository purposes, which I will do throughout this chapter.)

(9) *Intermediate Spec-CP must be empty:*

- a. Yè **ɲà** [<sub>CP</sub> Op yùukù luêeel [<sub>CP</sub> è      cé      cuïin câam]]?  
 be **who** HAB.1PL say.NF C PRF.SV food eat.NF  
 ‘Who do we say has eaten food?’
- b. \*Yè **ɲà** [<sub>CP</sub> Op yùukù luêeel [<sub>CP</sub> è **cuïin** (á)-cíi      câam]]?  
 be **who** HAB.1PL say.NF C food (3s)-PRF.OV eat.NF  
 ‘Who do we say has eaten food?’
- c. Yè **ɲó** [<sub>CP</sub> Op yùukù luêeel [<sub>CP</sub> è      cíi Ból      câam]]?  
 be **what** HAB.1PL say.NF C PRF.OV Bol.GEN eat.NF  
 ‘What do we say Bol has eaten?’
- d. \*Yè **ɲó** [<sub>CP</sub> Op yùukù luêeel [<sub>CP</sub> è **Ból** cé      câam]]?  
 be **what** HAB.1PL say.NF C Bol PRF.SV eat.NF  
 ‘What do we say Bol has eaten?’
- e. Yè **tè-nó** [<sub>CP</sub> Op yùukù luêeel [<sub>CP</sub> è      cíi wók càam     ]]?  
 be **place-which** HAB.1PL say.NF C PRF.OV we.GEN eat.NF  
 ‘Where do we say that we have eaten \_\_\_?’
- f. \*Yè **tè-nó** [<sub>CP</sub> Op yùukù luêeel [<sub>CP</sub> è **cuïin** (à)-cíi wók càam     ]]?  
 be **place-which** HAB.1PL say.NF C food (3s)-PRF.OV we.GEN eat.NF  
 ‘Where do we say that we have eaten food \_\_\_?’

These examples show that long-distance *wh*-movement is only possible if the moving phrase first moves to the Spec-CP position of the lower CP, as in the grammatical (9a), (9c), and (9e), regardless of the grammatical function of the extracted element. Topicalization of a different DP to Spec-CP of the lower clause yields ungrammaticality, as (9b), (9d), and (9f) illustrate.

These patterns are due to movement from the embedded clause. In (10), we see that  $\bar{A}$ -movement in the higher clause can co-occur with embedded V2.

(10) *Movement in matrix clause has no effect on embedded V2:*

- Yè **ɲà** [<sub>CP</sub> Op yé      luêeel [<sub>CP</sub> è **wók** cé cuïin câam]].  
 be **who** HAB.SV say.NF C 1PL PRF.SV food eat.NF  
 ‘Who says that we have eaten food?’

Also evident in (9a–f) is that intermediate movement has repercussions for voice. Voice in the clause from which extraction takes place matches the grammatical function of the extracted nominal, so that movement of an embedded subject requires Subject Voice in the embedded clause, for example. In higher clauses, the effect of movement on voice is different. Long-distance

movement to Spec-CP results in Object Voice in higher clauses, regardless of the voice of the embedded clause. This is obscured by the subject clitic in (9a–f), but, in (11), we see that long-distance movement of an embedded subject triggers Object Voice in the matrix clause.

(11) *Long-distance movement is marked with Object Voice in higher clauses:*

Yè kôɔc-kó [CP Op é-kè-yíi Ból ké luéel [CP è \_\_\_ é-kè-cèk]]?  
 be people-which PST-PL-HAB.OV Bol.GEN 3PL say.NF c PST-PL-be.short  
 ‘Which people did Bol think were short?’

Recall that this was one of the arguments for treating Object Voice as marking of non-subject extraction in Chapter 3 (sec. 2.2).

The same facts are found with the complementizer *kè*. The examples in (12a–d) demonstrate with topicalization out of the complement clause of *yòok* (‘find out’).

(12) *Long-distance movement satisfies V2 in CPs with *kè*:*

- a. **Kôɔc-kè** áa-cíi Ból ké *yòok* [CP *kè* \_\_\_ *nhiàr* \_\_\_ Àyén].  
**people-these** 3P-PRF.OV Bol.GEN 3PL find.out.NF c love.sv Ayen  
 ‘These people, Bol has found out love Ayen.’
- b. \***Kôɔc-kè** áa-cíi Ból ké *yòok* [CP *kè* **Àyén** *nhiéer* \_\_\_].  
**people-these** 3P-PRF.OV Bol.GEN 3PL find.out.NF c Ayen love.ov  
 ‘These people, Bol has found out love Ayen.’
- c. **Àyén** à-cíi Ból *yòok* [CP *kè* \_\_\_ *nhiéer* *kôɔc-kè* \_\_\_].  
**Ayen** 3S-PRF.OV Bol.GEN find.out.NF c love.ov people-these  
 ‘Ayen, Bol has found out that these people love.’
- d. \***Àyén** à-cíi Ból *yòok* [CP *kè* **kôɔc-kè** *nhiàr* \_\_\_].  
**Ayen** 3S-PRF.OV Bol.GEN find.out.NF c people-these love.ov  
 ‘Ayen, Bol has found out that these people love.’

These examples illustrate that intermediate movement to Spec-CP is not dependent on the complementizer or on the type of long-distance movement. Extraction from an embedded clause in Dinka always involves first moving to the edge of that clause.

The effect of intermediate movement is evident in all intermediate clauses. If movement crosses two finite CPs, evidence of intermediate movement is found at each Spec-CP position. The examples in (13a–d) demonstrate for movement of an embedded object across two clause boundaries. Only the example in which no overt DP occupies the edge of either intermediate clause is grammatical (13a). Every permutation in which an overt DP occupies an intermediate Spec-CP is ungrammatical (13b–d).

(13) *Intermediate movement satisfies V2 in each intermediate clause:*

- a. Yè **ɲà** [<sub>CP</sub> Op yùukù tàak [<sub>CP</sub> kè \_\_\_ yïi Bòl luèeel [<sub>CP</sub> è \_\_\_ cùukù  
 be **who** HAB.1PL think.NF C HAB.OV Bol.GEN say.NF C PRF.1PL  
 tîiŋ]]]]?  
 see.NF  
 ‘Who do we think that Bol says that we have seen?’
- b. \*Yè **ɲà** [<sub>CP</sub> Op yùukù tàak [<sub>CP</sub> kè (Bòl) cé luèeel [<sub>CP</sub> è \_\_\_ cùukù tîiŋ]]]]?  
 be **who** HAB.1PL think.NF C Bol PRF.SV say.NF C PRF.1PL see.NF  
 ‘Who do we think that Bol says that we have seen?’
- c. \*Yè **ɲà** [<sub>CP</sub> Op yùukù tàak [<sub>CP</sub> kè \_\_\_ cíi Bòl luèeel [<sub>CP</sub> è (wòk) cé  
 be **who** HAB.1PL think.NF C PRF.OV Bol.GEN say.NF C we PRF  
 tîiŋ]]]]?  
 see  
 ‘Who do we think that Bol said that we have seen?’
- d. \*Yè **ɲà** [<sub>CP</sub> Op yùukù tàak [<sub>CP</sub> kè (Bòl) cé luèeel [<sub>CP</sub> è (wòk) cé  
 be **who** HAB.1PL think.NF C Bol PRF.SV say.NF C we PRF.SV  
 tîiŋ]]]]?  
 see.NF  
 ‘Who do we think that Bol said that we have seen?’

These facts show that Dinka long-distance movement involves intermediate movement not just to the local CP edge, but to each Spec-CP position on the path of movement.

Further support for the idea that a copy or trace of the moving phrase satisfies V2 at each Spec-CP position in (13a) comes from the interaction of movement and  $\varphi$ -agreement. Like terminal movement to Spec-CP, intermediate movement triggers  $\varphi$ -agreement on the second position verb/auxiliary. This is illustrated in (14a–b), in which both long-distance relativization and long-distance topicalization of a plural DP trigger  $\varphi$ -agreement at the edge of the embedded clause.

(14) *Intermediate movement triggers  $\varphi$ -agreement:*

- a. Yè kòoc-kó [<sub>CP</sub> Op é-kè-yá ké tàak [<sub>CP</sub> è \_\_\_ é-kè-cíi  
 be people.cs-which PST-PL-HAB.2SG 3PL think.NF C PST-PL-PRF.OV  
 Áyèn ké gâam gâlám]]]?  
 Ayen.GEN 3PL give.NF pen  
 ‘Which people did (s)he think that Ayen had given a pen to?’
- b. Wòk yïi Bòl ké luèeel [<sub>CP</sub> è \_\_\_ é-kè-léet Áyèn ké].  
 we HAB.OV Bol.GEN 3PL say.NF C PST-PL-insult.OV Ayen.GEN 3PL  
 ‘Us, Bol says Ayen was insulting.’

Note that clauses crossed by long-distance movement are marked with the interrogative particle (*é-kè* in 14a–b), and not with the declarative particle (this would be *áa-kè*). This is true even in

long-distance topicalization, as in (14b). As a result,  $\varphi$ -agreement with intermediate movement is only evident with movement of a plural out of a past tense clause (the interrogative particle is always null in the present tense). This could be taken as evidence that the features involved in intermediate movement differ from those implicated in terminal movement, as in Abels 2012b.

On the basis of the V2 and  $\varphi$ -agreement facts, I propose that embedded clauses in Dinka are *phases* (Chomsky 2001, 2008), so that movement out of them is only possible if the moving phrase first moves to the *phase edge*, Spec-CP. This intermediate movement step satisfies the V2 property of C. At the relevant stage of the derivation, the embedded Spec-CP position is overtly occupied, by a copy of the moving phrase. The only difference between such clauses and embedded clauses without extraction out of them is that the DP that occupies Spec-CP undergoes further movement. Note that, in terms of the articulated left periphery adopted in section 2.1, this means that the lower of the two C heads I posit for Dinka, Fin, acts as the phase head.

That a copy or trace can satisfy V2 has also been shown for German by Thiersch (1978). German allows embedded V2 in complements to bridge verbs. As Thiersch points out, extraction from such clauses requires V1 order (15a–b).

(15) *Extraction satisfies V2 in German:*

- a. **Wen** sagt Johan [CP \_\_\_ sehe er]?  
**who.ACC** says Johan see.SBJ he  
 ‘Who does Johan say that he is seeing?’
- b. \***Wen** sagt Johan [CP **er** sehe]?  
**who.ACC** says Johan he see.SBJ he  
 ‘Who does Johan say that he is seeing?’  
 (German; Thiersch 1978:135)

This is linked to intermediate movement, because movement in the matrix clause still requires V2 in the complement. The pairs in (16a–b) and (16c–d) demonstrate. In (16a–b), movement of a PP from an embedded clause requires V1. The pattern of grammaticality reverses with movement within the matrix clause: embedded V2 is required and embedded V1 impossible (16c–d).<sup>5</sup>

(16) *V1 order due to extraction:*

- a. **In welche Schule** sagte Leo [CP \_\_\_ sei er gegangen]?  
**to which school** said Leo is.SBJ he went  
 ‘To which school did Leo say he went?’
- b. \***In welche Schule** sagte Leo [CP **er** sei gegangen]?  
**to which school** said Leo he is.SBJ went  
 ‘To which school did Leo say he went?’

---

5. My thanks to Susi Wurmbrand for these minimal pairs.



- c. \***In welcher Sprache** sagte Leo [<sub>CP</sub> sei er gegangen]?  
**in which language** said Leo is.SBJ he went  
 ‘In which language did say he went?’
- d. **In welcher Sprache** sagte Leo [<sub>CP</sub> er sei gegangen]?  
**in which language** said Leo he is.SBJ went  
 ‘In which language did say he went?’  
 (German; Susi Wurmbrand, p.c.)

Both the Dinka and the German pattern show that intermediate movement is capable of satisfying V2. This is not only an argument for successive-cyclic derivations (Chomsky 1977 et seq.), but also an argument for the idea that such derivations involve movement. V2 requires the presence of a phrase and so these facts suggest that the moving phrase, whether as a copy or in the form of a trace, occupies intermediate positions.

### 3 Intermediate movement involves Agree

In the previous section, I showed that intermediate movement in Dinka has the same effects on the morphosyntax as movement to the final landing site. Dinka does not distinguish between them for the purposes of V2, voice, or the selection of targets for  $\varphi$ -agreement. In Chapter 4, I argued that all movement to Spec-CP in Dinka is driven by a composite probe, consisting of an  $\bar{A}$ -probe and a  $\varphi$ -probe. In this section, I extend this idea to intermediate movement, so that it too is established by Agree.

#### 3.1 Intermediate movement and probing by multiple features

An important characteristic that intermediate movement in Dinka shares with all other phrasal movement is that it displays A-properties as well as  $\bar{A}$ -properties. Intermediate movement has the locality profile of  $\bar{A}$ -movement: it can cross intervening clause boundaries and noun phrases. At the same time, it is visible for  $\varphi$ -agreement and presumably for case assignment, since only nominals in the absolutive case otherwise may be targeted for  $\varphi$ -agreement and affect voice.

To capture this, I suggest that intermediate movement to Spec-CP, like final movement to Spec-CP, is driven by a *composite probe*, or by a  $\varphi$ -probe and an  $\bar{A}$ -probe acting in unison.

(17) **Dinka intermediate C:**

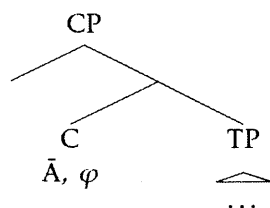

As argued also in Chapter 4, I take the  $\bar{A}$ -probe to be a catch-all probe for  $\bar{A}$ -features, which will target the closest phrase bearing any  $\bar{A}$ -features, such as Rel or Top.

As with movement to the final landing site, this allows for a DP undergoing intermediate successive-cyclic movement to be targeted for  $\varphi$ -agreement in favor of closer goals that just bear  $\varphi$ -features. The same logic of probing used in Chapter 4 for movement to the final landing site applies. The  $\varphi$ -probe and  $\bar{A}$ -probe form a composite probe on C in the sense of Coon and Bale (2014) (see also Starke 2001). As a result, the composite probe ignores closer DP goals that lack an  $\bar{A}$ -feature, as schematized in (18).

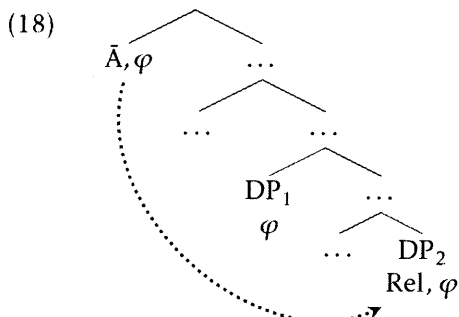

This requires that intermediate movement steps are established by Agree for an  $\bar{A}$ -feature, just like terminal instances of  $\bar{A}$ -movement, following Chomsky (1995), McCloskey (2002), and Abels (2012b), among others. To be precise, I adopt the framework for intermediate successive-cyclic movement developed by Abels (2012b). Abels proposes that all phase heads are merged with uninterpretable instances of all movement-driving features, like the  $\bar{A}$ -probe above. It is important in this type of approach that Agree is *fallible*, in that it may fail without crashing the derivation (Abels 2003, 2012b; Preminger 2011). This allows for probing features to be present on intermediate heads without appeal to lookahead.

In an approach to intermediate movement like this, all C heads are merged with an  $\bar{A}$ -probe. This means that an example like (19) involves an Agree relation with C in both clauses.

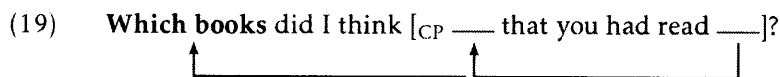

If there is no *wh*-phrase in the probing domain of a C head, then C's  $\bar{A}$ -probe will fail and remain unvalued. This is harmless, because Agree can fail without inducing ungrammaticality. In this view, intermediate movement makes use of the same syntactic mechanisms as movement to the final landing site, Agree and Merge. The only difference resides in the nature of the probing feature: uninterpretable in the case of intermediate movement, and interpretable in the final movement step (see Abels 2012b for details).

An important prediction of this approach is that intermediate movement can have the same morphosyntactic repercussions on the left periphery as terminal movement. This is what I suggest happens in Dinka. As mentioned previously, I capture the similarities between terminal and intermediate movement in Dinka by proposing that the features driving intermediate movement

probe in unison with the  $\varphi$ -probe, acting as a composite probe. As a result, intermediate movement triggers  $\varphi$ -agreement on C and satisfies the V2 property associated with the Spec-CP position.

We have now explained why a phrase undergoing intermediate movement is preferentially attracted to Spec-CP when the relevant competitor bears only  $\varphi$ -features. In addition, as noted before, this account explains why only one instance of movement driven by an  $\bar{A}$ -feature is permitted per clause. In the next section, I examine competition between different types of  $\bar{A}$ -movement in more detail, and argue that it is best modeled by Agree.

### 3.2 Competition between $\bar{A}$ -movements

In this section, I argue that the idea that intermediate movement involves Agree captures competition between overlapping  $\bar{A}$ -movements. In Dinka, and in many other languages, there are constraints on whether different  $\bar{A}$ -dependencies can nest or cross (e.g. Pesetsky 1982). As in Chapter 4, I model this by assuming that there is a hierarchy to  $\bar{A}$ -features (Rizzi 1997, 2004; Abels 2012a), and allowing for variation in whether movement is established by a catch-all  $\bar{A}$ -probe, satisfied by any type of  $\bar{A}$ -feature, or specific  $\bar{A}$ -features. Under the view that both intermediate and final movement involve Agree, this approach provides a straightforward explanation for the fact that, across languages, intermediate and terminal  $\bar{A}$ -movement are treated identically for constraints on overlapping dependencies (see also Abels 2012a).

In section 2.2, I showed that intermediate movement to Spec-CP is incompatible with other instances of movement to Spec-CP. For example, long-distance relativization out of an embedded CP prevents topicalization to Spec-CP of that clause, as (20a–b) attest.

(20) **Intermediate movement to Spec-CP blocks topicalization:**

- a. \*Yè ɲà [CP Op yùukù luêeel [CP è cuɲin (à)-cɲi \_\_\_ câam]]?  
 be **who** HAB.1PL say.NF C food (3s)-PRF.OV eat.NF  
 ‘Who do we say has eaten food?’
- b. \*Yè tɛ-nó [CP Op yùukù luêeel [CP è cuɲin (à)-cɲi wóok câam \_\_\_]]?  
 be **place-which** HAB.1PL say.NF C food (3s)-PRF.OV WE.GEN eat.NF  
 ‘Where do we say that we have eaten food \_\_\_?’

It does not matter whether these dependencies are crossing, as in (20a) (the topicalizing object originates lower than the subject trace), or nesting, as in (20b) (the topicalizing object is higher than the adjunct trace).

Any two instances of movement driven by  $\bar{A}$ -features compete in this fashion in Dinka. We already saw this for movement to the same clause edge in Chapter 4. Recall that topicalization and relativization cannot target the same Spec-CP position, as illustrated in (21a–d) for subject and object relatives.

(21) *Relativization cannot co-occur with topicalization to the same Spec-CP:*

- a. tíŋ [CP Op cíi Bòl — tíŋ]  
 woman PRF.OV Bol.GEN see.NF  
 ‘the woman that Bol has seen’
- b. \*tíŋ [CP Op Bòl cé — — tíŋ]  
 woman Bol PRF.SV see.NF  
 ‘the woman that Bol has seen’
- c. tíŋ [CP Op cé — Bòl tíŋ]  
 woman PRF.SV Bol see.NF  
 ‘the woman that has seen Bol’
- d. \*tíŋ [CP Op Bòl cíi — — tíŋ]  
 woman Bol PRF.OV see.NF  
 ‘the woman that has seen Bol’

Regardless of whether the movement are crossing or nesting, topicalization and relativization cannot target the same left periphery.

This is part of a general pattern. There can never be any overlap between two separate  $\bar{A}$ -dependencies (I use overlap to refer to dependencies that either cross or nest). The example in (22a) demonstrates that two instances of topicalization may not cross. In (22b), we see that topicalization cannot overlap with relativization, and (22c) shows the same for nested instances of relativization.

(22) *No overlapping  $\bar{A}$ -dependencies:*

- a. \*Kòòc-kè áa-cíi Bòl ké yòòk [CP kè Àyén nhiéer — —].  
 people-these 3P-PRF.OV Bol.GEN 3PL find.out.NF C Ayen love.OV  
 ‘These people, Bol has found out love Ayen.’
- b. \*Kítáp à-gééi Bòl [CP yè ñà [CP Op cé — — ʉ̀̀̀̀̀̀]].  
 book 3S-wonder.ov Bol.GEN be who PRF.SV buy.NF  
 ‘The book, Bol is wondering who has bought.’
- c. \*Yè ñó [CP Op gééi Bòl [CP yè ñà [CP Op cé — — ʉ̀̀̀̀̀̀]]]?  
 be what wonder.ov Bol.GEN be who PRF.SV buy.NF  
 ‘What is Bol wondering who has bought?’

In sections 4 and 5, when I discuss verb phrase V2, we will see that intermediate movement may create additional specifiers beyond the one that overtly satisfies V2, so that the effects in (22a–c) do

not derive from constraints on V2. Instead, I claim that these contrasts arise because of the flat  $\bar{A}$ -probe I posit on C, which forces different types of  $\bar{A}$ -phrases to compete for the attention of one probe. Recall that I assume that different types of  $\bar{A}$ -features may intervene for one another (Pesetsky 1982), and, following Rizzi (1997, 2004; see also Abels 2012a), that features like Top and Rel are part of a hierarchy of  $\bar{A}$ -features like (23).

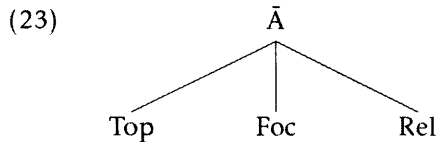

In addition, I suggested in the previous chapter that  $\bar{A}$ -probes may either be flat, so that they are satisfied by any  $\bar{A}$ -feature, or relativized to a specific type of  $\bar{A}$ -feature, such as *Wh* or Top. If movement in Dinka involves a flat  $\bar{A}$ -probe, there can only be one instance of movement driven by an  $\bar{A}$ -feature to a Spec-CP position per clause, regardless of whether intermediate or terminal movement is involved. Consider, for example, an example such as (24), in which an intermediate movement step to establish long-distance relativization of the embedded subject blocks topicalization of the embedded object.

- (24) \*Yè **ɲà** [<sub>CP</sub> Op yùukù luéel, [<sub>CP</sub> è **cụịn** (à)-c̣ịi \_\_\_ c̣aam]]?  
 be **who** HAB.1PL say.NF c food (3s)-PRF.OV eat.NF  
 ‘Who do we say has eaten food?’

The relevant stage of the derivation is in (25).

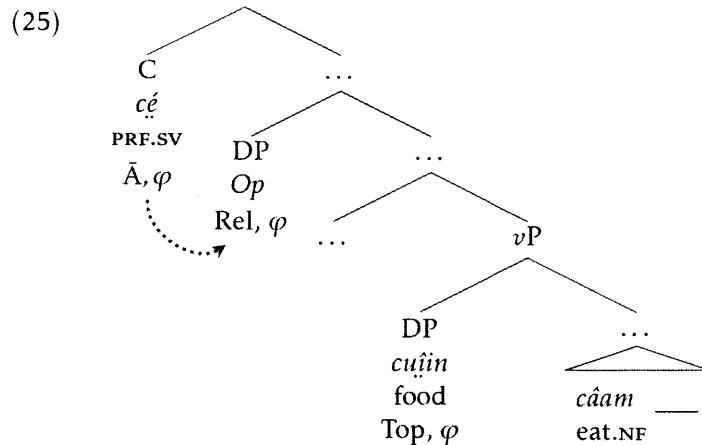

The embedded C is merged with a flat  $\bar{A}$ -probe. This probe is satisfied equally by the Rel feature on the subject and the Top feature on the object, because both features are dependents of the  $\bar{A}$ -node in the hierarchy in (23). Because the subject is the closest goal, C targets it for Agree, both for its  $\bar{A}$ -features and for  $\varphi$ -features, because C is a composite probe. The relative operator subject is then attracted to Spec-CP, where it satisfies V2 and triggers Subject Voice on the perfect auxiliary. At

this point, all features on C are valued. As a result, there can be no subsequent topicalization of the object *cuñin* ('food') to a second specifier of C.

Treating both intermediate and terminal movement as driven by Agree allows for a straightforward explanation of why they behave the same way with regard to the admissibility of overlapping dependencies in Dinka. I suggest that this is not just true in Dinka, but a general fact about successive-cyclic dependencies. Much the same situation obtains in English, for instance. *Wh*-movement and topicalization generally cannot target the same edge (26a–b).<sup>6</sup>

(26) ***Wh*-movement and topicalization cannot target the same edge:**

- a. \*I wonder [<sub>CP</sub> who, that book, bought yesterday].
- b. \*She asked [<sub>CP</sub> which friend, this guitar, I gave to].

Pesetsky (1982) shows that this carries over to intermediate movement as well. Topicalization cannot take place in clauses out of which *wh*-movement happens (27a–b), and *wh*-movement cannot occur to a clause edge that is targeted by intermediate movement in topicalization (27c–d).

(27) ***Wh*-movement and topicalization do not overlap:**

- a. ??Which violins did you say [<sub>CP</sub> that, these sonatas, you could play \_\_\_ on \_\_\_]?
- b. \*Which sonatas did you say [<sub>CP</sub> that, these violins, you could play \_\_\_ on \_\_\_]?
- c. ??These violins, I know [<sub>CP</sub> which sonatas you can play \_\_\_ on \_\_\_].
- d. \*These sonatas, I know [<sub>CP</sub> which violins you can play \_\_\_ on \_\_\_].

In addition, Pesetsky points out that there is a contrast between crossing and nesting  $\bar{A}$ -dependencies, as evident in these examples also. The nesting dependencies in (27a) and (27c) are much better than the crossing cases in (27b) and (27d).

Both the contrast between nesting and crossing and the inadmissibility of overlapping dependencies follow if  $\bar{A}$ -movement in English is driven by a flat  $\bar{A}$ -probe on C, as in Dinka (see also Kitahara 1994, 1997; Richards 1997, 2001).<sup>7</sup> Overlapping  $\bar{A}$ -dependencies are ungrammatical for the same reason as in Dinka: only one  $\bar{A}$ -phrase can be attracted by the  $\bar{A}$ -probe on C.<sup>8</sup> The contrast between nesting and crossing dependencies derives from Relativized Minimality. In a nesting derivation, like (27a), the  $\bar{A}$ -probe on the embedded C attracts the closest phrase, the topic *these*

6. See Haegeman 2003 for discussion of how fronted adjuncts interact with  $\bar{A}$ -movement.

7. It is worth noting that nesting dependencies are close to acceptable if the lower clause is infinitival, as Pesetsky 1982 points out. In addition, nesting dependencies in *tough*-movement are grammatical. This may suggest that there is something special about the left edge of non-finite clauses in English that allows for overlapping  $\bar{A}$ -movements. I will take the examples in (27a–d) to represent the basic pattern.

8. It is not crucial that topicalization and *wh*-movement target the same position. The same contrasts are predicted if there are two  $\bar{A}$ -probes, distributed across the left periphery.

*sonatas*. The matrix C then has to attract the *wh*-phrase *which violins*, in violation of Relativized Minimality or Agree with Closest (because *these sonatas* acts as a defective intervener). Crossing derivations, in contrast, involve two such violations, because probing by the embedded C also has to target the  $\bar{A}$ -phrase that is farthest away.

As pointed out by Rizzi (1997, 2004), Italian differs in this respect. *Wh*-movement and topicalization may target the same clause edge, occurring in either order (28a–b).

(28) **Topicalization and *wh*-movement may target the same edge in Italian:**

- a. Mi domando, [<sub>CP</sub> il premio Nobel, a chi lo potrebbero dare].  
 I wonder the prize Nobel to whom it could give  
 ‘I wonder, the Nobel Prize, to whom they could give it.’
- b. ?Mi domando [<sub>CP</sub> a chi, il premio Nobel, lo potrebbero dare].  
 I wonder to whom the prize Nobel it could give  
 ‘I wonder to whom, the Nobel Prize, they could give it.’  
 (Italian; Rizzi 1997:289)

Importantly, this difference carries over to intermediate movement. If *wh*-movement and topicalization target left peripheries in different clauses, the two  $\bar{A}$ -phrases can originate in the same clause, creating overlapping dependencies. The examples in (29a–b) demonstrate.

(29) **Topicalization and *wh*-movement can overlap in Italian:**

- a. ?Non so [<sub>CP</sub> come pensi [<sub>CP</sub> che, a Gianni, gli dovremmo parlare]].  
 not know how think.2SG that to Gianni to.him should talk  
 ‘I don’t know how you think that, to Gianni, we should talk to him.’
- b. ?Non so [<sub>CP</sub> a chi pensi [<sub>CP</sub> che, queste cose, le dovremmo dire]].  
 not know to whom think.2SG that these things them should say  
 ‘I don’t know to whom you think that, these things, we should say them.’  
 (Italian; Rizzi 2004:232)

As argued by Abels (2012a), we can capture these patterns if  $\bar{A}$ -probes can be relativized to specific features, just as in  $\varphi$ -agreement, like Top or *Wh*. In this view, Italian C merges with specific probes for Top and *Wh*, instead of a flat  $\bar{A}$ -probe, as represented in (30). As a result, probing for these features can proceed separately and we expect these dependencies to be able to cross freely.<sup>9</sup>

---

9. I will leave open the question of whether these probes are distributed across multiple heads, as in cartographic approaches, for instance. This should not affect the conclusions defended here.

(30) *Articulated probes on Italian C:*

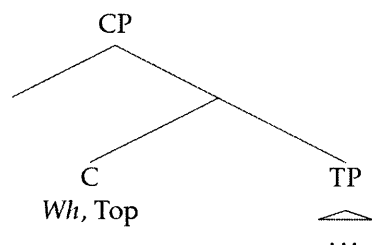

See Rizzi (1990, 1997, 2004) and Abels (2012a) for extensive discussion of how this view extends to other types of  $\bar{A}$ -movement in Italian. What should be clear is that treating  $\bar{A}$ -features as part of a hierarchy of features, as in Rizzi (1990 et seq.; Abels 2012a), lets us capture variation across languages in whether different types of  $\bar{A}$ -movement compete.

We can also find other V2 languages that pattern like Dinka, and these patterns provide some evidence that the ungrammaticality of overlapping  $\bar{A}$ -movements can be independent from V2. In Icelandic and Faroese, embedded V2 clauses that are subject-initial interact differently with intermediate movement than clauses with topicalization inside of them. Regardless of whether the resulting dependencies are nesting or crossing, extraction out of a clause is incompatible with topicalization in the same clause (e.g. Zaenen and Maling 1977; Práinsson 1979:472; Holmberg and Platzack 1995; Vikner 1995; Hrafnbjargarson et al. 2010). The examples in (31a–b) demonstrate for Icelandic.

(31) *No wh-movement from clauses with topicalization in Icelandic:*

- a. \***Hver**<sub>i</sub> sagði hann [<sub>CP</sub> að þessar bækur hefði \_\_\_<sub>i</sub> ekki gefið Kára]?  
**who.NOM** said he that these.ACC books.ACC had not given Kári.DAT  
 ‘Who did he say had not given Kari these books?’
- b. \***Hverjum**<sub>i</sub> sagði hann [<sub>CP</sub> að þessar bækur hefði hann ekki gefið \_\_\_<sub>i</sub>]  
**who.DAT** said he that these.ACC books.ACC had he not given  
 ‘Who did he say that he had given these books?’  
 (Icelandic; Hrafnbjargarson et al. 2010)

In (31a), topicalization of an object is impossible in a clause out of which subject extraction has taken place (a crossing derivation). In (31b), we see that topicalization is still ungrammatical if the *wh*-moved element originates lower, in this case as the indirect object (a nesting derivation). Similar facts are found in Faroese (32a–b).

(32) *No wh-movement from clauses with topicalization in Faroese:*

- a. \***Hvør**<sub>i</sub> segði hann [<sub>CP</sub> at hessar bøkur hevði \_\_\_<sub>i</sub> ikki givið Káru]?  
**who.NOM** said he that these.ACC books.ACC had not given Kári.DAT  
 ‘Who did he say had not given Kari these books?’



- b. \***Hvørjum**<sub>i</sub> segði hann [<sub>CP</sub> at hessar bókur hevði hann ikki givið \_\_\_\_<sub>i</sub>]  
**who.DAT** said he that these.ACC books.ACC had he not given  
 ‘Who did he say that he had given these books?’  
 (Faroese; Hrafnbjargarson et al. 2010)

In contrast, subject-initial V2 is compatible with intermediate movement in both languages, as illustrated by (33a–b). In both examples, the subject moves to satisfy V2, apparently without disturbing intermediate *wh*-movement of the object.

(33) **Extraction out of subject-initial V2 clause is grammatical:**

- a. **Hvað**<sub>i</sub> sagði hann [<sub>CP</sub> að hann gæti ekki sungið \_\_\_\_<sub>i</sub>]?  
**what.ACC** said he that he could not sing  
 ‘What did he say he could not sing?’  
 (Icelandic; Hrafnbjargarson et al. 2010)
- b. **Hva**<sub>i</sub> segði hann [<sub>CP</sub> at hann dugdi ikki at syngja \_\_\_\_<sub>i</sub>]?  
**what.ACC** said he that he could not to sing  
 ‘What did he say he could not sing?’  
 (Faroese; Hrafnbjargarson et al. 2010)

Descriptively speaking, Icelandic and Faroese display the same patterns of extraction as Dinka when it comes to competing  $\bar{A}$ -movements, even though intermediate movement does not satisfy V2. Topicalization and *wh*-movement do not overlap. Unlike in Dinka, subject-initial V2 is compatible with extraction across it. I posit that what differentiates Dinka from both Icelandic and Faroese is that intermediate movement targets a position above the V2 site, so that there are two landing sites for  $\bar{A}$ -movement in the left periphery of an embedded clause. In addition, I propose that both topicalization and intermediate *wh*-movement are driven by flat probes, so that these two types of movement cannot overlap. The ungrammaticality of nesting and crossing derivations follows in the same way as above. However, if subject-initial V2 only involves A-movement of the subject, intermediate movement to a higher landing site should not disturb subject-initial V2. In support of this idea, observe that, in Icelandic at least, the same facts are found when *wh*-movement and topicalization target the same edge: only subject-initial V2 is grammatical (34a–b).

(34) **Wh-movement and topicalization cannot target same edge:**

- a. Þeir vissu [<sub>CP</sub> hvern amma hefði hitt í bænum].  
 they knew who.ACC grandma had met in town  
 ‘They knew who grandma had met in town.’
- b. \*Hann spurði [<sub>CP</sub> hvar í gær hefði hann hitt hana].  
 he asked where yesterday had he met her  
 ‘He asked where, yesterday, he had met her.’  
 (Icelandic; Maling 1980:72, Hrafnbjargarson et al. 2009:28)

These facts demonstrate then that the ungrammaticality of subject-initial V2 in contexts of intermediate movement, as in Dinka, may have a separate source from the ungrammaticality of examples like (34b).

This approach to probing for  $\bar{A}$ -features predicts that we should find V2 languages in which intermediate movement and topicalization can co-occur, if that language has relativized probes for  $\bar{A}$ -movement, in the same way that we find variation between English and Italian. Diesing (1990) argues that this situation is found in Yiddish. Long-distance movement is possible out both of embedded V2 clauses that are subject-initial and out of clauses with topicalization (35a–b).

(35) *Yiddish allows extraction from all V2 clauses:*

- a. **Vemen** hot er nit gevolt [<sub>CP</sub> az ot di bikher] zoln mir gebn]?  
**who.DAT** has he not wanted c PRT the book should we give  
 ‘To whom did he not want us to give the books?’
- b. **Vos** hot er nit gevolt [<sub>CP</sub> az mir] zoln leynen]?  
**what** has he not wanted c we should read  
 ‘What did he not want us to read?’  
 (Yiddish; Diesing 1990:62,71)

I propose that  $\bar{A}$ -movement in Yiddish is driven by relativized probes, as in Italian, in this case *Wh* and *Top*, so that these  $\bar{A}$ -dependencies can overlap.<sup>10</sup> This variation in the interaction of V2 and intermediate movement mirrors variation found in non-V2 languages.

An important generalization that emerges from the discussion of competing  $\bar{A}$ -movements in this section is that, although languages may differ in the featural makeup of  $\bar{A}$ -probes, the behavior of terminal and intermediate movement is consistently the same. Whether two movements can land at the same clause edge is predictive of whether the same dependencies can overlap while targeting different clauses. The same point is made at length by Abels (2012a) in his discussion of Italian, who uses this observation to argue against the notion of a cartographic template. A particularly striking examples of this is found in Bulgarian. As discussed in Rudin (1988) and Richards (1997, 2001), Bulgarian has multiple *wh*-movement constructions. Multiple instances of *wh*-movement obligatorily cross when targeting the same edge (36a), and cannot nest (36b).<sup>11</sup>

10. Variation in the admissibility of topicalization in clauses with other instances of  $\bar{A}$ -movement in them has been reported for both Yiddish and Icelandic (e.g. Lowenstamm 1977; Rögnvaldsson 1984; Diesing 1990), so that these languages may turn out to be more similar than concluded here. The fact that the Dinka pattern involves one flat  $\bar{A}$ -probe on C rather than the interplay of two  $\bar{A}$ -probes in the same clause, as in the related patterns described below, might explain why there does not seem to be a similar gradience to the Dinka effects.

11. Though more complicated patterns arise when there are more than two *wh*-words, an issue I set aside here.

(36) **Bulgarian multiple *wh*-movement must be crossing:**

a. **Koj kogo** \_\_\_ vižda \_\_\_?  
 who whom sees

'Who sees whom?'

b. \***Kogo koj** \_\_\_ vižda \_\_\_?  
 whom who sees

'Who sees what?'

(Bulgarian; Rudin 1988:472–473)

As pointed out by Richards (1997) the same facts obtain when two instances of *wh*-movement target *different* edges. Crossing dependencies are grammatical (37a), but nesting dependencies are not (37b), resulting in the reverse pattern from English.<sup>12</sup>

(37) **Bulgarian multiple *wh*-movement to different edges must cross:**

a. **Koj se** opitvat da razberat [<sub>CP</sub> **kogo** \_\_\_ e ubil \_\_\_]?  
 who SELF try to find.out whom AUX killed

'Who are they trying to find out whom killed?'

b. \***Kogo se** opitvat da razberat [<sub>CP</sub> **koj** \_\_\_ e ubil \_\_\_]?  
 who SELF try to find.out whom AUX killed

'Whom are they trying to find out who killed?'

(Bulgarian; Richards 1997:41)

If this generalization is correct, that intermediate and terminal movement display the same behavior when it comes to the admissibility of nesting and crossing dependencies, it provides an argument for the idea that the mechanisms involved in these movement types is the same. This observation receives an explanation if all movement steps of successive-cyclic dependencies involve Agree and Merge, with variation in the Agree relations involved responsible for constraints on intervention.

In this section, I showed that Dinka draws no clear distinction between intermediate movement and terminal movement in terms of the effects on the morphosyntax: both feed  $\varphi$ -agreement, the satisfaction of V2, and voice. I developed a model of the interaction of intermediate movement and V2 which captures why intermediate movement in Dinka must satisfy the V2 property of the clause edge, drawing on the idea that  $\bar{A}$ -probes may be flat or relativized to particular features (Rizzi 1997, 2004; Abels 2012a). Importantly, this approach treats intermediate movement the

12. Note that Bulgarian allows extraction out of *wh*-islands. See Richards (1997:ch. 2) for discussion and also for a way of deriving the preference for crossing in Bulgarian.

same way as other instances of movement, as feature-driven Merge (Chomsky 1995; McCloskey 2002; Abels 2012b). In the rest of this chapter, I turn to the syntax of intermediate movement through the *v*P edge, from which I will show the same lessons can be drawn.

#### 4 V2 in the verb phrase

In this section, I examine the distribution of V2 in the Dinka verb phrase, which will play a major role not only in the rest of this chapter, but also in the next chapter. In Chapter 3, I showed that a V2 effect is found in transitive verb phrases, so that the object must move to Spec-*v*P and be assigned absolutive case there. In this section, I demonstrate that this V2 effect surfaces in a variety of contexts, including ditransitives, causatives, and in the context of CP objects. Discussion of these constructions will set the stage for the discussion of intermediate movement in section 5, in which we will see that long-distance movement in Dinka requires intermediate movement steps to the edge of every verb phrase, in the same way that it requires intermediate movement to the CP edge.

##### 4.1 V2 in ditransitives and causatives

In this section, I examine ditransitive verb phrases. The V2 effect that surfaces with transitive verb phrases affects such verb phrases as well. I propose that Dinka has two underlying ditransitive structures, which more or less map onto the English dative alternation. In particular, I offer evidence that Dinka's dative alternation involves an asymmetric alternation in the sense of Bruening (2001a). In both ditransitive structures, the highest DP object must move to Spec-*v*P and receive absolutive case.

As with transitive verbs, the left edge of a ditransitive verb phrase must be occupied by a DP object in the absolutive case. As pointed out by Creider (1989), this results in word order alternations with ditransitives that take two nominal objects, like *gâam* ('give'). With such verbs, either object can appear in Spec-*v*P (38a–b). The other object appears after the main verb, but is also in the absolutive case.

(38) *One object appears before the verb cluster:*

- a. Yîin cé [vP Àyén gâam cáa].  
 you PRF.SV Ayen give.NF milk  
 'You have given Ayen milk.'
- b. Yîin cé [vP cáa gâam Àyén].  
 you PRF.SV milk give.NF Ayen  
 'You have given milk to Ayen.'

More precisely, exactly one object *must* move to Spec-*v*P. It is never possible for Spec-*v*P to be empty (39a–b), just as with transitive verbs.

(39) *Spec-vP cannot be empty:*

- a. \*Yîin cĕ [vP \_\_\_ gàam cáa Àyén].  
 you PRF.SV give.NF milk Ayen  
 'You have given Ayen milk.'
- b. \*Yîin cĕ [vP \_\_\_ gàam Àyén cáa].  
 you PRF.SV give.NF Ayen milk  
 'You have given Ayen milk.'

It is also impossible for both objects to occur before the verb cluster, as the pair in (40a–b) attests.

(40) *Only one object can occur before the verb cluster:*

- a. \*Yîin cĕ [vP cáa Àyén gàam].  
 you PRF.SV milk Ayen give.NF  
 'You have given Ayen milk.'
- b. \*Yîin cĕ [vP Àyén cáa gàam].  
 you PRF.SV Ayen milk give.NF  
 'You have given Ayen milk.'

The word order alternation in (38a–b) is independent of whether the verb undergoes movement up to C, as evident in the present progressive. We see this in examples like (41a–b), in which the verb moves to the left periphery but both object orders are still possible inside the verb phrase.

(41) *Object alternation does not depend on verb movement:*

- a. Yîin gàm [vP Àyén cáa].  
 you give.sv Ayen milk  
 'You are giving Ayen milk.'
- b. Yîin gàm [vP cáa Àyén].  
 you give.sv milk Ayen  
 'You are giving milk to Ayen.'

As in my discussion of transitive verb phrases in Chapter 3 (sec. 3.1), I propose that, in all of these cases, a DP object moves to Spec-*vP* to be case-licensed by *v*. This is further evidence then that the specifier of a case-assigning *v* is an EPP position in Dinka.

In contrast, the object that is not in Spec-*vP* does not undergo any movement. Regardless of whether it is the direct or indirect object, the lower object must always be adjacent to the main verb. This object immediately follows the verb cluster, for example, and cannot intervene between an auxiliary and the main verb (42a–d).

(42) *The second object cannot interrupt the verb cluster:*

- a. Yîin cĕ [vP Àyén dàac gàam cáa].  
 you PRF.SV Ayen do.quickly.NF give.NF milk  
 'You have quickly given Ayen milk.'

- b. \*Yi̱in cé̱ [vP Àyén dâac cáa gàam].  
 you PRF.SV Ayen do.quickly.NF milk give.NF  
 ‘You have quickly given Ayen milk.’
- c. Yi̱in cé̱ [vP cáa dâac gàam Àyén].  
 you PRF.SV milk do.quickly.NF give.NF Ayen  
 ‘You have quickly given milk to Ayen.’
- d. \*Yi̱in cé̱ [vP cáa dâac Àyén gàam].  
 you PRF.SV milk do.quickly.NF Ayen give.NF  
 ‘You have quickly given milk to Ayen.’

In addition, adjunct material must follow all objects and cannot intervene between the second object and the verb cluster (43a–d).

(43) *Adjuncts must follow second object of ditransitive:*

- a. Yi̱in cé̱ [vP Bòl gàam cáa ákól].  
 you PRF.SV Bol give.NF milk afternoon  
 ‘You have given Bòl milk in the afternoon.’
- b. \*Yi̱in cé̱ [vP Bòl gàam ákól cáa].  
 you PRF.SV Bol give.NF afternoon milk  
 ‘You have given Bòl milk in the afternoon.’
- c. Yi̱in cé̱ [vP cáa gàam Bòl ákól].  
 you PRF.SV milk give.NF Bol afternoon  
 ‘You have given milk to Bol in the afternoon.’
- d. \*Yi̱in cé̱ [vP cáa gàam ákól Bòl].  
 you PRF.SV milk give.NF afternoon Bol  
 ‘You have given milk to Bol in the afternoon.’

That the verb and the lower object must be adjacent follows if the lower object is the complement of V and does not undergo any movement. If correct, Dinka ditransitives must allow for either the goal or the theme to merge as the complement of V. To capture this, I propose two distinct underlying structures for Dinka ditransitives, one in which the goal merges in the specifier of an applicative phrase and one in which the goal is introduced in covert PP structure (Marantz 1993; Bruening 2001a). To motivate these structures, I will show that, despite the surface symmetry, postverbal indirect objects behave as PPs while postverbal *direct* objects do not.

The Dinka ditransitive alternation is reminiscent of the dative alternation in a number of respects. For example, if the goal is a location, it is marked with allative case and no word order alternation is possible. We see this with the verb *tuðɔc* (‘send’) (44a–b).

(44) *Locative objects cannot appear in Spec-vP:*

- a. Bòl à-cé [vP Àyén tuðɔc uʔɔt].  
Bol 3S-PRE.SV Ayen send.NF house.ALL  
'Bol has sent Ayen to the house.'
- b. \*Bòl à-cé [vP uʔɔt tuðɔc Àyén].  
Bol 3S-PRE.SV house send.NF Ayen  
'Bol has sent Ayen to the house.'

As is well-known, the dative alternation displays a similar contrast (45a–b).

(45) *Locative goals limited to prepositional dative:*

- a. Kim sent Alex to the house.  
b. \*Kim sent the house Alex.

In accordance with this parallel, we see that the object in Spec-*vP* always c-commands the second object. The higher object can bind into the lower object, but never the other way around, regardless of which object is first. This is illustrated in (46a–d). In (46a), we see that an indirect object in Spec-*vP* can bind a pronoun contained in the direct object. The same binding relation is impossible if the direct object occupies Spec-*vP* (46b). In (46c), the direct object binds a pronoun inside of a relative clause modifying the indirect object. This is ungrammatical if the indirect object has moved to Spec-*vP* (46d).

(46) *Object in Spec-vP can bind into lower object:*

- a. uʔɛɛn é-cé [vP nyà ébén<sub>i</sub> lɛɛk ákékòol-dè<sub>i</sub>].  
1SG PST-PRE.SV girl every tell.NF story-SG.3SG  
'I had told every girl<sub>i</sub> her<sub>i</sub> story.'
- b. \*uʔɛɛn é-cé [vP ákékòol-dè<sub>i</sub> lɛɛk nyà ébén<sub>i</sub>].  
1SG PST-PRE.SV story-SG.3SG tell.NF girl every  
'I had told every girl<sub>i</sub> her<sub>i</sub> story.'
- c. uʔɛɛn é-cé [vP kítáap ébén<sub>i</sub> gâam [DP rán [CP é-gàr yéen<sub>i</sub>]]].  
1SG PST-PRE.SV book every give.NF person PST-write.SV 3SG  
'I had given every book<sub>i</sub> to the person who wrote it<sub>i</sub>.'
- d. \*uʔɛɛn é-cé [vP [DP rán [CP é-gàr yéen<sub>i</sub>]] gâam kítáap ébén<sub>i</sub>].  
1SG PST-PRE.SV person PST-write.SV 3SG give.NF book every  
'I had given every book<sub>i</sub> to the person who wrote it<sub>i</sub>.'

This suggests that the different orders reflect two different base-generated structures.

In addition to this, we can find evidence that a postverbal indirect object is associated with PP structure, just as in the prepositional dative, although this PP structure is covert in Dinka. The relevant argument comes from the distribution of resumption. Dinka allows resumptive pronouns

in PPs and in island contexts. This means that, outside of islands, resumption is limited to PPs. Transitive objects, for example, cannot be resumed (47a–b).

(47) *Direct objects cannot be resumed:*

- a. Yè ηό [CP cíi róor tíiη]?  
 be what PRF.OV MEN.GEN see.NF  
 ‘What have the men seen?’
- b. \*Yè ηό [CP cíi róor yêen tíiη]?  
 be what PRF.OV MEN.GEN 3SG see.NF  
 ‘What have the men seen?’

In contrast, resumption is possible with a range of PPs, like possessors or nominals contained in a comitative or instrumental PP.<sup>13</sup> Some examples are given in (48a–c).

(48) *Resumption targets possessors and PPs:*

- a. Yè ηà [CP céemè Ból cujin-dè]?  
 be who eat.OBLV Bol.GEN food-SG.3SG  
 ‘Whose food is Bol eating?’
- b. Yè ηό [CP céemè Ból cujin nê yêen]?  
 be what eat.OBLV Bol.GEN food P 3SG  
 ‘What is Bol eating with?’
- c. Yè ηà [CP céemè Ból cujin kènê yêen]?  
 be who eat.OBLV Bol.GEN food with 3SG  
 ‘Who is Bol eating with?’

In addition to PPs of various types, there is exactly one type of absolutive object that may also be resumed, the postverbal indirect object of a ditransitive. This is demonstrated by the examples in (49a–b). When an indirect object follows the verb and the direct object appears in Spec-*vP*, an indirect object may be a resumptive pronoun (49a). If the indirect object is in Spec-*vP*, resumption is impossible (49b).

(49) *Resumption may target a postverbal indirect object:*

- a. Yè ηà [CP cíi Ból [<sub>vP</sub> kitáp yiêen yêen]]?  
 be who PRF.OV Bol book give.NF 3SG  
 ‘Who has Bol given a book to?’
- b. \*Yè ηà [CP cíi Ból [<sub>vP</sub> yêen yiêen kitáp]]?  
 be who PRF.OV Bol 3SG give.NF book  
 ‘Who has Bol given a book to?’

13. We can see that possessors are also PPs in the case of non-pronominal possessors, which are introduced by the preposition *ê*. On this basis, I assume that pronominal possessor clitics like *-dê* in (48a) also contain PP structure, even if they lack this preposition overtly.



In contrast, the direct object in a ditransitive always behaves like a transitive object. It can never be resumed, regardless of position (50a–b).

(50) **Resumption can never involve direct object:**

- a. \*Yè ɲó [CP cíi Ból [vP Àyén yiéɛn yêen]]?  
 be what PRF.OV Bol Ayen give.NF 3sg  
 ‘What has Bol given Ayen?’
- b. \*Yè ɲó [CP cíi Ból [vP yêen yiéɛn Àyén]]?  
 be what PRF.OV Bol 3sg give.NF Ayen  
 ‘What has Bol given Ayen?’

These resumption facts provide evidence that a postverbal indirect object has a different status than a postverbal direct object. Specifically, I take this to indicate that postverbal indirect objects are introduced by a covert P that assigns absolutive case.

The above suggests an asymmetric treatment of Dinka ditransitives, along the lines of Marantz (1993) and Bruening (2001a) for English.<sup>14</sup> In an asymmetric approach, the double object construction involves an applicative head that introduces the indirect object. In the prepositional dative, the indirect object is introduced low instead, in a PP. I adopt these structures for Dinka. I propose the syntax in (51b) for an example like (51a), in which the indirect object appears in Spec-*vP*.

(51) **Verb phrase with indirect object in Spec-*vP*:**

- a. Ỵin cé [vP Àyén gâam cáa].  
 you PRF.SV Ayen give.NF milk  
 ‘You have given Ayen milk.’

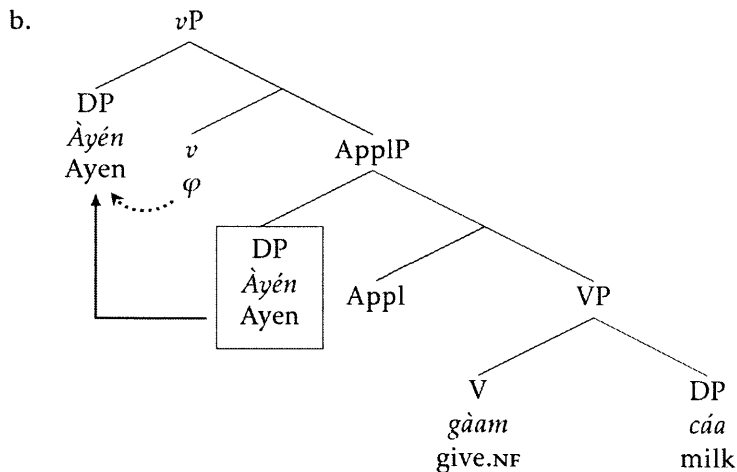

14. See Harley (1997, 2002) for a different view, in which both the double object construction and the dative alternation involves PP structure.

In this structure, the indirect object is introduced as a DP in the specifier of Appl. It is the closest DP to *v*, and so is case-licensed and attracted by the  $\varphi$ -probe on *v*. I posit that the direct object is licensed lower, either by Appl or directly by V (nothing hinges on this choice).

Following Marantz (1993) and Bruening (2001a), I adopt a different structure for the prepositional dative, in which the goal is a PP complement to the verb and the direct object is introduced in Spec-VP. We then end up with a syntax like (52b) for examples like (52a).

(52) **Verb phrase with direct object in Spec-*v*P:**

- a. Y̱in cé [vP *cáa* *gàam* *Àyén*].  
 you PRF.SV milk give.NF Ayen  
 'You have given milk to Ayen.'

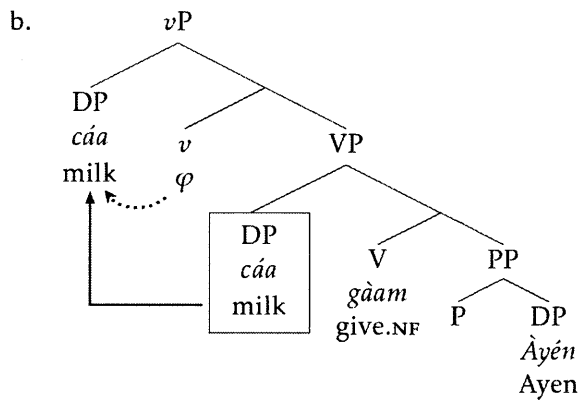

In this derivation, the indirect object is licensed by a (silent) P, while the direct object is case-licensed by *v* in Spec-*v*P. This approach to the dative alternation is asymmetric and fits well with the resumption pattern documented above.<sup>15</sup> If resumptive pronouns only appear in PPs, as I have claimed, these structures correctly limit resumption in ditransitives to postverbal indirect objects. In addition, this proposal makes sense of the binding and positioning facts, as long as adjuncts attach to the right. In this view, the V2 property of ditransitive verb phrases is analogous to the V2 property of transitive verb phrases: an object obligatorily moves to Spec-*v*P for licensing. The only difference is that ditransitives license an additional object in the verb phrase as well, either by means of applicative structure or silent PP structure.

In section 5, we will see that the way these ditransitive structures interact with intermediate movement provides evidence for the idea that long-distance movement must stop off at Spec-*v*P. Before getting to this, however, I discuss how V2 in the verb phrase affects the distribution of complement clauses.

15. It is worth noting, though, that the Dinka alternation does not appear to display interpretive asymmetries along the lines of Oehrle (1976), an issue I will leave open here.

## 4.2 Verb phrase V2 and complement clauses

The V2 effect that appears at the edge of the Dinka verb phrase also surfaces with verbs that embed complement clauses. In this section, I describe some of these patterns and show that a variety of strategies are employed to satisfy V2 in verb phrases with complement clauses, including raising-to-object, movement of the CP, and clausal expletives.

I will start by looking at verbs that embed finite CPs. Unlike with DP objects, transitive verbs that embed a CP object most naturally occur in the Object Voice (53a–b), with no (overt) element in Spec-CP and the CP appearing finally.

### (53) *Object Voice is preferred with finite CPs:*

- a. À-**cíi** Ból yòok [CP kè Àyén bé jàal].  
 3S-**PRE.OV** Bol.GEN find.out.NF c Ayen FUT.SV leave.NF  
 ‘Bol has found out that Ayen will leave.’
- b. À-**yíi** Ból luéel [CP è bé Àyèn jàal].  
 3S-**HAB.OV** Bol.GEN say.NF c FUT.SV Ayen.GEN leave.NF  
 ‘Bol says that Ayen will leave.’

Although Subject Voice is dispreferred with such verbs, this can be overridden by extraction, such as subject relativization. In such examples, Spec-*vP* is empty and the CP is again final (54a–b).

### (54) *Subject Voice possible with subject extraction:*

- a. Yè **ɲà** [CP cé [<sub>vP</sub> \_\_\_ yòok [CP kè Àyén bé jàal]]]?  
 be **who** PRE.SV find.out.NF c Ayen FUT.SV leave.NF  
 ‘Who has found out that Ayen will leave?’
- b. Yè **ɲà** [CP yé [<sub>vP</sub> \_\_\_ luéel [CP è bé Àyèn jàal]]]?  
 be **who** HAB.SV say.NF c FUT.SV Ayen.GEN leave.NF  
 ‘Who says that Ayen will leave?’

A similar pattern is found with CP complements in Tagalog, where Object Voice also functions as the neutral order (Norvin Richards, p.c.). These facts are surprising from the perspective of V2. We might imagine that CP objects cannot move to Spec-*vP*, forcing the V2 property of the verb phrase to remain unsatisfied. At Spec-CP, however, the subject should be able to move to satisfy V2.

When we turn to verbs that take both a CP and a DP object, we see the same puzzle arise with Spec-*vP*. Although there is a DP object around that can overtly occupy Spec-*vP* (55a), it is also possible to leave Spec-*vP* and Spec-CP empty, in an Object Voice clause (55b).

### (55) *CP object allows DP object not to move to Spec-*vP*:*

- a. Ból à-**cé** [<sub>vP</sub> Dèen] luòk [CP è bé Àyèn jàal].  
 Bol 3S-**PRE.SV** Deng persuade.NF c FUT.SV Ayen.GEN leave.NF  
 ‘Bol has persuaded Deng that Ayen will leave.’

- b. À-cíi Ból [<sub>vP</sub> \_\_\_ luḡḡk Dèeŋ [<sub>CP</sub> è bé Áyèn jàal]].  
 3S-PRF.OV BOL.GEN persuade.NF Deng c FUT.SV Ayen.GEN leave.NF  
 ‘Bol has persuaded Deng that Ayen will leave.’

These facts demonstrate that CP objects allow for Spec-*vP* to be empty, even when there is a suitable DP object around that could move to Spec-*vP*, as in (55a). This suggests that it is not the case that V2 can be left unsatisfied, but rather that CPs may covertly occupy these positions. To be precise, following Van Urk and Richards (2015), I propose that CP objects may occupy Spec-*vP* and Spec-CP, just like DP objects, but are banned from appearing there overtly. In this view, the initial derivation of a verb phrase with a CP object, as in (56a), may proceed just as with a DP object (56b).

(56) **Structure of verb phrase with CP object:**

- a. Yè ñà [<sub>CP</sub> cé [<sub>vP</sub> \_\_\_ yḡḡk [<sub>CP</sub> kè Áyèn bé jàal]]]?  
 be who PRF.SV find.out.NF c Ayen FUT.SV leave.NF  
 ‘Who has found out that Ayen will leave?’

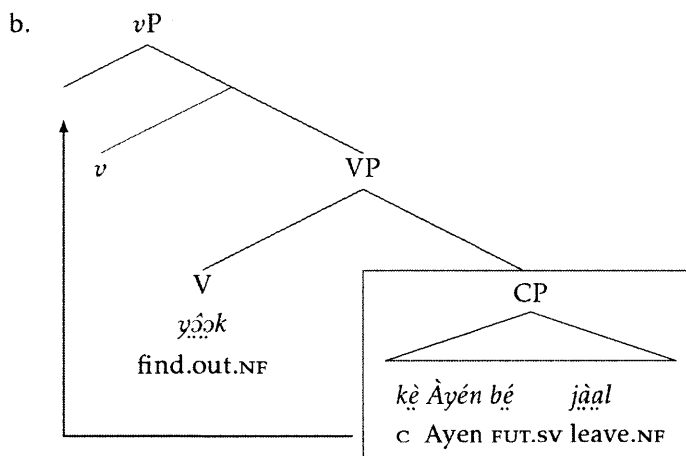

In this structure, the CP moves to Spec-*vP* to satisfy V2, just like a DP object. However, I posit a Dinka-specific constraint which bans CPs from overtly appearing in Spec-*vP* or Spec-CP. For the sake of concreteness, this constraint is stated in (57).

(57) **Dinka CP constraint:**

CPs must appear finally.

The pressure for CPs to appear peripherally manifests itself in a number of other languages also as well, such as Dutch, German, Malagasy, or Malayalam (e.g. Aravind 2015; Potsdam and Edmiston 2015), but I will not explore here how (57) could be made to derive from more general crosslinguistic principles. To ensure that the structure in (56b) obeys the constraint in (57), I

propose that Dinka deletes the CP copy in Spec-*v*P at PF, pronouncing only the lower copy.<sup>16</sup> The same thing happens at Spec-CP if the CP moves to that position: a copy of the CP satisfies V2, but is deleted at PF to avoid a violation of (57). As a result of this, apparent violations of V2 are allowed in the presence of a CP object.

The derivation in (56b) suggests that CP may value the  $\varphi$ -probe on *v* and be assigned absolutive case. To account for this, I posit that CPs in Dinka may be merged with a “DP shell”, in the sense of Hartman (2012), which allows them to move to positions ordinarily reserved for noun phrases. Support for this view comes from the observation that not all verbs that embed CPs allow for surface violations of V2 at Spec-CP or Spec-*v*P. The verb *g̃ai* (‘wonder’), for instance, only allows the Subject Voice (58a–b).

(58) *Some verbs with CP objects only allow Subject Voice:*

- a. Bòl à-cé̃ g̃aĩ [CP nàa bé̃ Áyèn j̃ãal].  
 Bol 3s-PRF.SV wonder.NF whether FUT.SV Ayen.GEN leave.NF  
 ‘Bol has wondered whether Ayen will leave.’
- b. \*À-c̃ĩ Bòl g̃aĩ [CP nàa bé̃ Áyèn j̃ãal].  
 3s-PRF.OV Bol.GEN wonder.NF whether FUT.SV Ayen.GEN leave.NF  
 ‘Bol has wondered whether Ayen will leave.’

This is not because *g̃ai* embeds interrogative CPs, because other verbs that embed interrogatives do allow Object Voice, such as *thĩec̃* (‘ask’) (59a–b).

(59) *Object Voice possible with interrogative CP:*

- À-c̃ĩ Bòl thĩec̃ [CP nàa bé̃ Áyèn j̃ãal].  
 3s-PRF.OV Bol.GEN ask.NF whether FUT.SV Ayen.GEN leave.NF  
 ‘Bol has asked whether Ayen will leave.’

Instead, what distinguishes verbs that allow CP movement from those that do not is whether the verb can take a DP object.<sup>17</sup> As the examples in (60a–c) demonstrate, only *g̃ai* cannot independently occur with a DP.<sup>18</sup>

(60) *G̃ai cannot take DP object:*

- a. W̃ók cé̃ [vP ỹiic̃ ỹòok̃].  
 1PL PRF.SV truth find.out.NF  
 ‘We have found out the truth.’

16. There are a number of other ways to achieve the same effect. We could say that CPs create rightward specifiers, or that they undergo extraposition. Nothing much hinges on this choice.

17. My thanks to Claire Halpert for pointing me in this direction.

18. In Van Urk and Richards (2015), we suggested that the distinguishing factor had to do with the finiteness of the embedded CP. Whether the embedding verb can embed a DP object turns out to crosscut this distinction, so that there are non-finite CPs that can cause surface violations of V2.

- b. Wôok cé [vP yêen thiêec].  
 1PL PRF.SV 3SG ask.NF  
 ‘We have asked it.’
- c. \*Wôok cé [vP yêen gâai].  
 1PL PRF.SV 3SG wonder.NF  
 ‘We have wondered it.’

I propose then that Dinka allows complement CPs to be merged with a covert DP shell in order to allow them to merge with verbs that select for DPs (see Hartman 2012). This DP layer enables the CP to move to Spec-*vP* and Spec-CP, even though it cannot overtly appear there.<sup>19</sup> This happens with verbs like *yôok* and *thiêec* because they select DPs. In contrast, I posit that a verb like *gâai* (‘wonder’) selects for CPs only, which cannot move to Spec-*vP* without a DP shell.

Some verbs come in both types. The verb *thiêec* (‘ask’), for instance, has an intransitive version that patterns with *gâai* and only allows Subject Voice (61a–b).

(61) *Transitivity determines behavior of CP objects:*

- a. Wôok cé thiêc [CP nâa bé Áyèn jâal].  
 1PL PRF.SV ask.INTR.NF whether FUT.SV Ayen.GEN leave.NF  
 ‘We have asked whether Ayen will leave.’
- b. \*À-cùukù thiêc [CP nâa bé Áyèn jâal].  
 3S-PRF.1PL ask.INTR.NF whether FUT.SV Ayen.GEN leave.NF  
 ‘We have asked whether Ayen will leave.’

Similar alternations are found with ditransitive verbs, which often come in two types. In the ditransitive form, two DPs are selected, and Object Voice is the most natural (62a). But it is also possible for these verbs to carry transitive morphology, in which case only one of its arguments can appear in an object position (62b–c).

(62) *Verbs with DP and CP objects appear with ditransitive or transitive morphology:*

- a. À-cíi Bôl [vP \_\_\_ luôok Dèeŋ] [CP è bé Áyèn jâal].  
 3S-PRF.OV Bol.GEN persuade.DTR.NF Deng C FUT.SV Ayen.GEN leave.NF  
 ‘Bol has persuaded Deng that Ayen will leave.’
- b. Bôl à-cé [vP Àyèn lûuk [CP è bè jâal]].  
 Bol 3S-PRF.SV Ayen persuade.NF C FUT.3SG leave.NF  
 ‘Bol has persuaded Ayen that she should leave.’
- c. À-cíi Bôl [vP \_\_\_ lûuk è Dèeŋ] [CP è bé Áyèn jâal].  
 3S-PRF.OV Bol.GEN persuade.NF P Deng C FUT.SV Ayen.GEN leave.NF  
 ‘Bol has persuaded Deng that Ayen will leave.’

19. See also Halpert 2015 for a similar treatment of CP movement in English.

One potential way of viewing the covert DP shell I posit here is as a covert CP expletive, associated with the CP. With this perspective in mind, it is worth noting that the 3rd person singular pronoun *yêen* may function as a clausal expletive in Dinka and shows a similar distribution. For example, *yêen* can appear in Spec-CP in Object Voice in examples like (63a–b).

(63) **Overt pronominal expletive in Spec-CP with CP object:**

- a. **Yêen** à-c̣ịi Bôl yôok [CP ḳè Àyèn ḅé j̣àal].  
 3SG 3S-PREF.OV Bol.GEN find.out.NF c Ayen FUT.SV leave.NF  
 ‘Bol has found out that Ayen will leave.’
- b. **Yêen** à-ỵịi Bôl luéeeel [CP è ḅé Àyèn j̣àal].  
 3SG 3S-HAB.OV Bol.GEN say.NF c FUT.SV Ayen.GEN leave.NF  
 ‘Bol says that Ayen will leave.’

Because 3rd person pronouns can undergo *pro*-drop, this raises the possibility that there is a covert CP expletive in the examples with apparent V2 violations described above. In accordance with this, the CP expletive can also appear in Spec-*v*P, for example in the Subject Voice (64a–b).

(64) **Clausal expletive can appear in Spec-*v*P:**

- a. Yè ηà [CP c̣é **yêen** yôok [CP ḳè Àyèn ḅé j̣àal]]?  
 be who PREF.SV 3SG find.out.NF c Ayen FUT.SV leave.NF  
 ‘Who has found out that Ayen will leave?’
- b. Yè ηà [CP yé **yêen** luéeeel [CP è ḅé Àyèn j̣àal]]?  
 be who HAB.SV 3SG say.NF c FUT.SV Ayen.GEN leave.NF  
 ‘Who says that Ayen will leave?’

However, *pro*-drop in Dinka is restricted to Spec-CP and is not allowed in Spec-*v*P (65a–b).

(65) **Pro-drop only possible in Spec-CP:**

- a. (Yêen) à-c̣ùuḳù ṭịịj̣.  
 3SG 3S-PREF.1PL see.NF  
 ‘Her/him, we have seen.’
- b. Wôk c̣é \*(yêen) ṭịịj̣.  
 1PL PREF.SV 3SG see.NF  
 ‘We have seen her/him.’

It is hard to see then how the covert expletive account could explain the apparent violations of V2 in the verb phrase when there is a CP object around (as in 54a–b).

In addition to this, CPs doubled by the pronominal expletive are islands for extraction, unlike complement clauses not doubled by an overt pronoun, as the examples in (66a–b) illustrate.

(66) *CPs with overt expletive are islands:*

- a. Yè ηà [CP cùukù [vP \_\_\_ yòok [CP kè bíi Àyén t̩iη]]?  
be who PRF.SV find.out.NF C FUT.OV Ayen.GEN see.NF  
'Who have we found out that Ayen has seen?'
- b. \*Yè ηà [CP cùukù [vP yéen yòok [CP kè bíi Àyén t̩iη]]?  
be who PRF.SV 3SG find.out.NF C FUT.OV Ayen.GEN see.NF  
'Who have we found out that Ayen has seen?'

Taken together, these facts suggest that CPs undergo movement themselves, as I have suggested here, and are not doubled by a covert expletive.<sup>20</sup> I assume this from now on.

In the discussion above, we saw that Dinka utilizes multiple strategies to ensure that Spec-*vP* is occupied in the context of complement CP: either the DP object is moved, the CP itself moves in a DP shell, or a clausal expletive is inserted. Another strategy is found with the causative verb *c̩k̩k̩* ('make'). This verb embeds a reduced verb-initial complement clause.<sup>21</sup> In addition, because the causative is a transitive verb, it requires a DP at the left edge of its verb phrase. Because the causative lacks a local DP object, this has to be done by movement to Spec-*vP* from within the complement clause, such as of the embedded subject in (67a). It is not possible for the Spec-*vP* position of the causative verb phrase to be left empty (67b).

(67) *Causative verb phrase has V2 effect:*

- a. Tiik à-cé [vP mòc c̩k̩k̩ [TP còl mèt̩h]].  
woman 3S-PRF.SV man make.NF call.SV child  
'The woman made the man call the child.'
- b. \*Tiik à-cé [vP \_\_\_ c̩k̩k̩ [TP còl mòc mèt̩h]].  
woman 3S-PRF.SV make.NF call.SV man.GEN child  
'The woman made the man call the child.'

We can tell that the complement clause of the causative is reduced because it lacks V2 and cannot host the declarative/interrogative particle. The examples in (68a–b) demonstrate this for the present and past tense forms of this particle.

(68) *Causative complement does not allow tense:*

- a. \*Tiik à-cé [vP mòc c̩k̩k̩ [TP à-còl mèt̩h]].  
woman 3S-PRF.SV man make.NF 3S-call.SV child  
'The woman made the man call the child.'

20. One worry that may arise is whether CPs that undergo movement should allow extraction out of them. Note that DPs objects that move to Spec-*vP* allow possessor extraction out of them. We can then independently see that this type of movement does not lead to freezing effects in Dinka.

21. Recall that Dinka is underlyingly verb-initial.



- b. \*Tiik à-cé [vP mòc còk [TP é-còl mèth]].  
 woman 3s-PRF.SV man make.NF PST-call.SV child  
 ‘The woman made the man call the child.’

I propose that the  $v$  head in the causative verb phrase carries a  $\varphi$ -probe, which attracts a DP from the embedded clause. As we will see in the next section, one of the striking properties of the causative is that this V2 property can be satisfied by intermediate movement across the causative.

The V2 effect found in the Dinka verb phrase is then satisfied in a number of different ways in the context of clausal objects. I argued here that CPs may sometimes move, though with subsequent deletion of the higher copy at PF, that a pronominal expletive may be employed, and that a DP may be attracted from the embedded clause.

To sum up this section briefly, we have seen that the V2 requirement of the Dinka verb phrase appears in a variety of contexts, including ditransitives, causatives, and with verbs that CP objects. In the next section, I show that this V2 property may be satisfied by intermediate movement, so that the syntax of the verb phrase is parallel to the syntax of the clause edge in a number of respects. Importantly, the interaction of object licensing and intermediate movement provides evidence for the featural treatment of intermediate movement outlined in section 3.

## 5 Intermediate movement in the verb phrase

In this section, I show that long-distance movement in Dinka involves intermediate movement steps to the edge of every verb phrase on the path of movement. This offers additional evidence, alongside the facts presented in section 2, for the notion of successive-cyclic movement (Chomsky 1973 et seq.), and specifically for the idea that verb phrases, in addition to clauses, constitute a cyclic domain (Chomsky 1986 et seq.; see also Fox 1999, Nissenbaum 2000, Cozier 2006, Buell 2012). We will see that intermediate movement may satisfy the V2 property of  $v$ , as it satisfies the V2 property of C. In addition, there is a multiple copy spell-out process at the  $v$ P edge, discussed in detail in Chapter 6, that provides independent support for the presence of intermediate copies at the  $v$ P edge.

### 5.1 Verb phrase V2 and intermediate movement

This section offers evidence for intermediate movement to the edge of the verb phrase by demonstrating that every Spec- $v$ P position on the path of movement is occupied by a copy of the moving phrase, with repercussions for V2 as well as a process of multiple copy spell-out I call *ké*-copying.

To examine the effects of intermediate movement on V2 at the edge of the verb phrase, we have to look at constructions in which a moving phrase competes with a DP object that can appear in Spec- $v$ P. Although they display a V2 effect, simple transitives, for instance, do not reveal anything about intermediate movement and verb phrase V2. When the object of a transitive moves to Spec-

CP, the Spec-*vP* position of the verb phrase must naturally be left empty, as in the relativization and topicalization examples in (69a–b).

(69) *Objects move from Spec-vP:*

- a. Yè **ŋó** [CP **cíi** Ból [vP \_\_\_\_ **cáam**]]?  
 be **what** PRF.OV Bol.GEN eat.NF  
 ‘What has Bol eaten?’
- b. **Cuɪn** à-**cíi** Áyèn [vP \_\_\_\_ **cáam** nè **páal**].  
**food** 3S-PRF.OV Ayen.GEN eat.NF P knife  
 ‘Food, Ayen has eaten with a knife.’

I propose that the object moves to Spec-*vP* as a result of an Agree relation with the  $\varphi$ -probe on *v* and then to Spec-CP, but we cannot tell just from (69a–b) whether this movement happens and whether it is necessary to escape the verb phrase.

When we examine constructions like ditransitives, however, we see that movement of an object out of the verb phrase must always be preceded by movement to Spec-*vP*. Ditransitives allow both objects to occupy Spec-*vP*, but this optionality disappears if one of the objects moves out of the verb phrase. If we relativize the theme, the goal must be postverbal and Spec-*vP* empty (70a–b). Similarly, movement of the goal requires that the theme be postverbal (70c–d).

(70) *Object extraction must come from Spec-vP:*

- a. Yè **ŋó** [CP **cíi** môc [vP \_\_\_\_ **yiêɛn** Áyèn]]?  
 be **what** PRF.OV man.GEN give.NF Ayen  
 ‘What has the man given Ayen?’
- b. \*Yè **ŋó** [CP **cíi** môc [vP (**Áyèn**) **yiêɛn**]]?  
 be **what** PRF.OV man.GEN Ayen give.NF  
 ‘What has the man given Ayen?’
- c. Yè **ŋà** [CP **cíi** môc [vP \_\_\_\_ **yiêɛn** **kitàap**]]?  
 be **who** PRF.OV man.GEN give.NF book  
 ‘Who has the man given the book to?’
- d. \*Yè **ŋà** [CP **cíi** môc [vP (**kitàap**) **yiêɛn**]]?  
 be **who** PRF.OV man.GEN book give.NF  
 ‘Who has the man given the book to?’

That V2 satisfaction at Spec-*vP* is a reflex of intermediate movement is supported in particular by ditransitives that involve two DP objects, but do not allow word order alternations. The verb *jáany* (‘warn’), for instance, only allows the indirect object to appear in Spec-*vP* (71a). The direct object must be postverbal (71b). In other words, this verb lacks the prepositional dative order.

(71) *Some ditransitives do not show alternations:*

- a. Bòl à-cé [vP Dèŋ jâany ákól].  
Bol 3S-PREF.SV Deng warn.NF sun  
'Bol has warned Deng about the sun.'
- b. \*Bòl à-cé [vP ákól jâany Dèŋ].  
Bol 3S-PREF.SV sun warn.NF Deng  
'Bol has warned Deng about the sun.'

However, when the direct object undergoes topicalization or relativization, Spec-*v*P must be empty (72a–d), just as in (70a–d).

(72) *Movement of direct object requires empty Spec-*v*P:*

- a. Ákól à-cùukù [vP \_\_\_ jâany Dèŋ].  
sun 3S-PREF.1PL warn.NF Deng  
'The sun, we have warned Deng about.'
- b. \*Ákól à-cùukù [vP (Dèŋ) jâany].  
sun 3S-PREF.1PL Deng warn.NF  
'The sun, we have warned Deng about.'
- c. Yè ŋó [CP cùukù [vP \_\_\_ jâany Dèŋ]].  
be what PREF.1PL warn.NF Deng  
'What have we warned Deng about?'
- d. \*Yè ŋó [CP cùukù [vP (Dèŋ) jâany]].  
be what PREF.1PL Deng warn.NF  
'What have we warned Deng about?'

These facts demonstrate that moving out of the verb phrase requires moving to its edge. In addition, an object undergoing intermediate movement satisfies V2 in the verb phrase, just as it does at the clause edge. If movement to Spec-*v*P is triggered just by  $\varphi$ -agreement, and independent of intermediate movement, it is unclear what rules out the ungrammatical (72b) and (72d). As we will see when we discuss adjunct extraction, it is in principle possible for intermediate movement to create additional specifiers of *v*, so that we cannot rely on a restriction on the number of specifiers *v* may have.<sup>22</sup>

Further evidence for the claim that intermediate movement to the *v*P edge is required comes from movement out of complement clauses. Particularly relevant to the current discussion is the behavior of long-distance movement with the causative verb *còk* ('make'). Recall that this verb attracts a DP from inside its complement to its Spec-*v*P position (73a–b).

22. Such a proposal would be odd to begin with if subjects are generated in Spec-*v*P, because we would then have to restrict *v* to no more than two specifiers.

(73) *Causative has V2 property:*

- a. Tiik à-cé [<sub>vP</sub> m̀̀c c̀̀k [TP c̀̀l m̀̀h]].  
woman 3S-PREF.SV **man** make.NF call.SV child  
'The woman made the man call the child.'
- b. Tiik à-cé [<sub>vP</sub> m̀̀h c̀̀k [TP c̀̀l m̀̀c]].  
woman 3S-PREF.SV **child** make.NF call.OV man.GEN  
'The woman made the child be called by the man.'

Just as with ditransitives, if we extract from within the complement of a causative, the moving phrase satisfies the V2 property of the causative verb phrase, regardless of whether it is the embedded object (74a) or embedded subject (74c). No other DP is able to move to the Spec-*vP* position, as (74b) and (74d) show.

(74) *Long-distance extraction must move through causative Spec-*vP*:*

- a. Yè ɲ̀ [CP c̀̀i Áyèn [<sub>vP</sub> \_\_\_\_ c̀̀k [TP céém B̀l]]]?  
be **what** PREF.OV Ayen.GEN make.NF eat.OV Bol.GEN  
'What has Ayen made Bol eat?'
- b. \*Yè ɲ̀ [CP c̀̀i Áyèn [<sub>vP</sub> B̀l] c̀̀k [TP cà̀m/céém]]]?  
be **what** PREF.OV Ayen.GEN Bol make.NF eat.SV/eat.OV  
'What has Ayen made Bol eat?'
- c. Yè ɲ̀ [CP c̀̀i B̀l [<sub>vP</sub> \_\_\_\_ c̀̀k [TP cà̀m cù̀in]]]?  
be **who** PREF.OV Bol.GEN make.NF eat.SV food  
'Who has Bol made eat the food?'
- d. \*Yè ɲ̀ [CP c̀̀i B̀l [<sub>vP</sub> cù̀in] c̀̀k [TP cà̀m/céém]]]?  
be **who** PREF.OV Bol.GEN food make.NF eat.SV/eat.OV  
'Who has Bol made eat the food?'

This is clear evidence that Spec-*vP* serves a landing site for intermediate movement, in the same way that Spec-CP does. Long-distance movement necessarily stops off at the causative Spec-*vP*, with repercussions for V2.

More complicated patterns emerge when we turn to the interaction of extraction from finite CPs and DP objects, depending on whether the CP object is merged with a DP shell or not. I illustrate with the verb *l̀̀k* ('persuade'). The first pattern that is important is found if the verb is transitive in form, so that the local DP object is the only object that can occupy Spec-*vP* and the CP, by hypothesis, is not merged with a DP shell. Extraction from such CPs has no effect on V2 at the higher *vP* edge, so that the DP object still must satisfy V2 (75a–b). Recall that the same verb can select for a CP with a DP shell, which is capable of moving to Spec-*vP*. In this case, long-distance movement out of a CP forces the higher Spec-*vP* position to be empty (75b), otherwise optional.

(75) *Two patterns with extraction from CP in ditransitive:*

- a. Yè **ŋó** [CP *cíi* Bòl [vP **Àyén** *lùuk* [CP *è bè* \_\_\_ *ɥǒc*]]?  
 be **what** PRF.OV Bol.GEN Ayen persuade.NF C FUT.3SG buy.NF  
 ‘What has Bol persuaded Ayen to buy?’
- b. \*Yè **ŋó** [CP *cíi* Bòl [vP \_\_\_ *lùuk* Àyén [CP *è bè* \_\_\_ *ɥǒc*]]?  
 be **what** PRF.OV Bol.GEN persuade.NF Ayen C FUT.3SG buy.NF  
 ‘What has Bol persuaded Ayen to buy?’
- c. Yè **ŋó** [CP *cíi* Bòl [vP \_\_\_ *luòk* Àyén [CP *è bè* \_\_\_ *ɥǒc*]]?  
 be **what** PRF.OV Bol.GEN persuade.DTR.NF Ayen C FUT.3SG buy.NF  
 ‘What has Bol persuaded Ayen to buy?’
- d. \*Yè **ŋó** [CP *cíi* Bòl [vP **Àyén** *luòk* [CP *è bè* \_\_\_ *ɥǒc*]]?  
 be **what** PRF.OV Bol.GEN Ayen persuade.DTR.NF C FUT.3SG buy.NF  
 ‘What has Bol persuaded Ayen to buy?’

Van Urk and Richards (2015) propose that these patterns arise because *v* must Agree with a CP in order to “unlock” it for extraction (see also Rackowski and Richards 2005). As a result, it is the CP that will value the  $\varphi$ -features on *v* if capable, as in (75c), and never the moving DP. Specifically, it is proposed there that the  $\bar{A}$ -features on C act as an intervener for probing from a higher *v*, so that the moving  $\bar{A}$ -phrase cannot be favored by a composite probe. This explains why there is no V2 satisfaction with intermediate movement in (75a): the CP selected by the transitive form of *lùuk* cannot move to Spec-*v*P. I refer the reader to Van Urk and Richards 2015 for extensive discussion of how this model of long-distance movement works.

The effects of intermediate movement are evident in every intermediate *v*P position, not just the lowest one. If we embed a ditransitive under a causative, movement out of the most embedded *v*P must pass through both *v*P edges. The examples in (76a–d) illustrate for relativization of the direct object.

(76) *Intermediate movement affects all intermediate vPs:*

- a. Yè **ŋó** [CP *cíi* Àyén [vP \_\_\_ *còk* [TP *dác* Bòl [vP \_\_\_ *yièŋ* Dèŋ]]]]?  
 be **what** PRF.OV Ayen.GEN make.NF quickly.OV Bol.GEN give.NF  
 Deng  
 ‘What has Ayen made Bol give Deng quickly?’
- b. \*Yè **ŋó** [CP *cíi* Àyén [vP \_\_\_ *còk* [TP *dác* Bòl [vP **Dèŋ** *yièŋ*]]]]?  
 be **what** PRF.OV Ayen.GEN make.NF quickly.OV Bol.GEN Deng  
 give.NF  
 ‘What has Ayen made Bol give Deng quickly?’

- c. \*Yè ɲó [CP cii Áyèn [vP Bòl] còk [TP dác [vP \_\_\_ yiɛɛn Dèeɛ]]]?  
 be what PREF.OV Ayen.GEN Bol make.NF quickly.ov give.NF  
 Deng  
 ‘What has Ayen made Bol give Deng quickly?’
- d. \*Yè ɲó [CP cii Áyèn [vP Bòl] còk [TP dác [vP Dèeɛ] yiɛɛn]]]?  
 be what PREF.OV Ayen.GEN Bol make.NF quickly.ov Deng give.NF  
 ‘What has Ayen made Bol give Deng quickly?’

We can put these patterns together with the facts discussed in section 2 to show V2 satisfaction by intermediate movement to Spec-CP and Spec-*v*P in the same derivation. If we embed a causative in a complement CP, for example, extraction from the complement of the causative satisfies V2 at Spec-*v*P of the causative and then subsequently at the intermediate Spec-CP (77a–d).

(77) *Intermediate movement through Spec-*v*P and then Spec-CP:*

- a. Yè ɲó [CP yùukù luèeel [CP è \_\_\_ cii Bòl [vP \_\_\_ còk [TP céem Ayèn]]]]]?  
 be what HAB.1PL say.NF C PREF.OV Bol.GEN make.NF eat.OV  
 Ayen.GEN  
 ‘What do we say that Bol has made Ayen eat?’
- b. \*Yè ɲó [CP yùukù luèeel [CP è \_\_\_ cii Bòl [vP Ayén] còk [TP càem]]]?  
 be what HAB.1PL say.NF C PREF.OV Bol.GEN Ayen make.NF eat.SV  
 ‘What do we say that Bol has made Ayen eat?’
- c. \*Yè ɲó [CP yùukù luèeel [CP è Bòl] (à)-cé [vP \_\_\_ còk [TP céem Ayèn]]]?  
 be what HAB.1PL say.NF C Bol (3s)-PREF.SV make.NF eat.OV  
 Ayen.GEN  
 ‘What do we say that Bol has made Ayen eat?’
- d. \*Yè ɲó [CP yùukù luèeel [CP è Bòl] (à)-cé [vP Ayén] còk [TP càem]]]?  
 be what HAB.1PL say.NF C Bol (3s)-PREF.SV Ayen make.NF eat.SV  
 ‘What do we say that Bol has made Ayen eat?’

We can also reverse the order of these positions, and extract from a finite CP embedded under a causative. Again, the only grammatical option is the one in which each intermediate edge is empty overtly (78a). All permutations in which an independent instance of movement satisfies the V2 property of one of these intermediate positions is ungrammatical (78b–d).

(78) *Intermediate movement through Spec-CP and then Spec-vP:*

- a. Yè **ŋó** [CP cùùkù [vP \_\_\_ còòk [TP luéel Ból [CP è \_\_\_ cíi Áyèn  
 be **what** PRF.1PL make.NF say.OV Bol.GEN C PRF.OV AyeN.GEN  
 câam]]]?  
 eat.NF  
 ‘What have we made Bol say that AyeN has eaten?’
- b. \*Yè **ŋó** [CP cùùkù [vP \_\_\_ còòk [TP luéel Ból [CP è **Áyèn** (à)-cé  
 be **what** PRF.1PL make.NF say.OV Bol.GEN C AyeN (3s)-PRF.SV  
 câam]]]?  
 eat.NF  
 ‘What have we made Bol say that AyeN has eaten?’
- c. \*Yè **ŋó** [CP cùùkù [vP **Ból** còòk [TP luéel [CP è \_\_\_ cíi Áyèn câam]]]?  
 be **what** PRF.1PL Bol make.NF say.SV C PRF.OV AyeN.GEN eat.NF  
 ‘What have we made Bol say that AyeN has eaten?’
- d. \*Yè **ŋó** [CP cùùkù [vP **Ból** còòk [TP luéel [CP è **Áyèn** (à)-cé câam]]]?  
 be **what** PRF.1PL Bol make.NF say.SV C AyeN (3s)-PRF.SV eat.NF  
 ‘What have we made Bol say that AyeN has eaten?’

Consistently then, long-distance extraction across an edge prevents other instances of movement to that edge, providing clear evidence that long-distance movement in Dinka involves successive-cyclic derivations.

Just as  $\varphi$ -agreement provides converging evidence for intermediate movement through Spec-CP, we can find independent evidence that  $vP$  constitutes a cyclic domain. This evidence comes from a process I call *ké*-copying (see also Andersen 2002 and Van Urk and Richards 2015). *Ké*-copying refers to the fact that plural DPs are doubled by the 3rd person plural pronoun *ké* in each Spec- $vP$  position they pass through (79a–b).

(79) *Plural DPs are doubled by pronoun in Spec-vP:*

- a. Yè **ŋà** [CP cíi Ból [vP \_\_\_ t̩iŋ]]?  
 be **who** PRF.OV Bol.GEN see.NF  
 ‘Who has Bol seen?’
- b. Yè **kôoc-kó** [CP cíi Ból [vP **ké** t̩iŋ]]?  
 be **people-which** PRF.OV Bol.GEN 3PL see.NF  
 ‘Which people has Bol seen?’

In Chapter 6, I argue at length that this is the result of multiple copy spell-out, so that this pronoun diagnoses the presence of a copy left by intermediate movement to Spec- $vP$ .

*Ké*-copying obtains at each  $vP$  edge on the path of movement, so that long-distance extraction involves multiple instances of *ké* (80a–b).

(80) *Ké-copying targets each verb phrase edge:*

- a. Yè **ɲà** [CP *yíi* Bòl [vP *luéèel* [CP *è cǐi* Áyèn [vP *tǐiŋ*]]]]]?  
 be **who** HAB.OV Bol.GEN say.NF C PRF.OV Ayen.GEN see.NF  
 ‘Who does Bol say Ayen has seen?’
- b. Yè **kôc-kó** [CP *yíi* Bòl [vP *ké luéèel* [CP *è cǐi* Áyèn [vP *ké tǐiŋ*]]]]]?  
 be **people-which** HAB.OV Bol.GEN 3PL say.NF C PRF.OV Ayen.GEN 3PL  
 see.NF  
 ‘Which people does Bol say Ayen has seen?’

*Ké-copying* provides supporting evidence for the presence of intermediate movement to Spec-*vP* in all the environments discussed here. In addition, *ké-copying* allows us to see that there is intermediate movement to the *all* verb phrases on the path of movement, even when intermediate movement does not interact with an overt V2 effect. In (80b), for example, *ké-copying* reveals the presence of an intermediate copy before the matrix verb *luéèel* (‘say’), which otherwise lacks a DP object that could overtly satisfy V2.

Similarly, we can use *ké-copying* to show that there is intermediate movement to the edge of intransitive verb phrases. When a plural adjunct undergoes movement out of the verb phrase, it participates in *ké-copying* (81).

(81) *Ké-copying at intransitive verb phrase:*

- Yè **thèek-kó** [CP *bíi* pèèl [vP *ké dhuòŋ*]]]?  
 be **times-which** FUT.OV knives 3PL break.NF  
 ‘At which times will the knives break?’

In this section, we have seen evidence from V2 effects and a process of multiple copy spell-out that long-distance movement in Dinka requires intermediate movement to the edge of every verb phrase along the way. I propose that *vP*, like CP, is a phase, as in Chomsky (2001, 2008), so that movement to its edge is necessary to escape it. As a reflex of this successive-cyclic movement step, the V2 property of the Dinka *vP* may be satisfied.

## 5.2 Multiple probes on *v*

In the previous section, we saw that Dinka requires intermediate movement to every Spec-*vP* position on the path of movement. In addition, I showed that intermediate movement has the same repercussions for V2 as terminal movement does. This is another demonstration that Dinka treats intermediate movement and terminal movement the same way, providing support for the idea that intermediate movement involves the same syntax. In addition, we saw that intermediate movement to the *vP* edge will block other instances of movement to the same edge.<sup>23</sup> In this section, I propose

23. Though (75a) is an exception, because the local object moves to Spec-*vP* alongside intermediate movement to the same edge (as can be diagnosed by *ké-copying*). A similar case is described in this section, with adjunct extraction.



that this pattern is found because intermediate movement to Spec-*v*P, like movement to Spec-CP, is driven by a composite probe.

As further evidence for the view that intermediate and terminal movement have the same effect on Dinka morphosyntax, we can show that they are subject to the same restrictions. Recall that only objects, and not adjunct material like instrumentals or locatives, may move to Spec-*v*P to satisfy V2. If we move such an adjunct out of a transitive *v*P, by means of relativization or topicalization, the direct object must still appear in Spec-*v*P (82a–b). Intermediate movement of the adjunct cannot satisfy V2 (82c–d).

(82) *Adjuncts do not satisfy V2 in intermediate movement:*

- a. Yè **ḡó** [CP **c̣íi** Ból [vP **cuḡin** tháal]]?  
 be **what** PRF.OV BOL.GEN food cook.NF  
 ‘What has Bol cooked food with?’
- b. **Pǎal** à-c̣énè Áyèn [vP **cuḡin** câam].  
**knife** 3S-PRF.OBLV AYEN.GEN food eat.NF  
 ‘With a knife, Ayen has eaten food.’
- c. \*Yè **ḡó** [CP **c̣íi** Ból [vP \_\_\_ tháal cuḡin]]?  
 be **what** PRF.OV BOL.GEN cook.NF food  
 ‘What has Bol cooked food with?’
- d. \***Pǎal** à-c̣énè Áyèn [vP \_\_\_ câam cuḡin].  
**knife** 3S-PRF.OBLV AYEN.GEN food eat.NF  
 ‘With a knife, Ayen has eaten food.’

It is not the case that these adjuncts do not move through the *v*P edge, as Van Urk and Richards (2015) point out. Plural adjuncts participate in *ké*-copying, so we can see that there is an intermediate copy of these phrases at the *v*P edge even if it does not satisfy V2 (83a–b).

(83) *Adjunct extraction triggers ké-copying:*

- a. Yè **uḡaan-kó** [CP **c̣íi** Ból [vP **ké** Áyèn tuḡoc]]?  
 be places-which PRF.OV BOL.GEN 3PL Ayen send.NF  
 ‘Which places has Bol sent Ayen to?’
- b. Yè **tóonỵ ḳé** **ḍii** [CP **c̣íi** Ból [vP **ké** cuḡin tháal]]?  
 be pots QUANT.PL HOW PRF.OV BOL.GEN 3PL food cook.NF  
 ‘How many pots has Bol cooked food with?’

I suggest that this is evidence that *v* carries two movement-driving features: one flat  $\bar{A}$ -probe which drives intermediate movement, and a  $\varphi$ -probe, associated with case assignment to DP objects. In derivations such as (83a–b), these probes attract two separate phrases, because there is no one goal that carries both features. In this way, these adjunct extraction facts reveal that intermediate

movement is driven by multiple movement-driving features, and not just by  $\varphi$ -agreement, just like intermediate movement to Spec-CP.

Let me show how this works with a few illustrative derivations. As described above, I propose that  $v$  carries a flat  $\bar{A}$ -probe as well as a  $\varphi$ -probe (84).

(84) **Probes on  $v$ :**

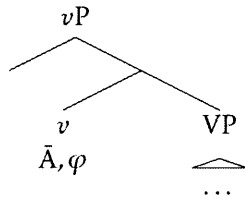

The flat  $\bar{A}$ -probe on  $v$  serves to trigger intermediate movement to the  $v$ P edge.<sup>24</sup> If (84) represents the featural specification of  $v$ , then intermediate movement of an object satisfies V2, using the logic of Agree I proposed for C in section 3.1. As before, suppose that the  $\bar{A}$ -probe and the  $\varphi$ -probe form a composite probe, in the sense of Coon and Bale (2014). As a result, if there is a DP with an  $\bar{A}$ -feature in the c-command domain of  $v$ , the  $\varphi$ -probe and  $\bar{A}$ -probe on  $v$  jointly target it.

To see how this approach works when intermediate movement satisfies V2, consider extraction in ditransitives, such as in the double object construction. I take the double object construction to be (at least) one source of (85a), by means of the derivation in (85b).

(85) **Intermediate movement of goal in double object construction:**

- a. Yè **ŋà** [<sub>CP</sub> cíi m̄oc [<sub>vP</sub> \_\_\_ yiêɛn kítáp]]?  
 be **who** PRF.OV man.GEN give.NF book  
 ‘Who has the man given the book to?’

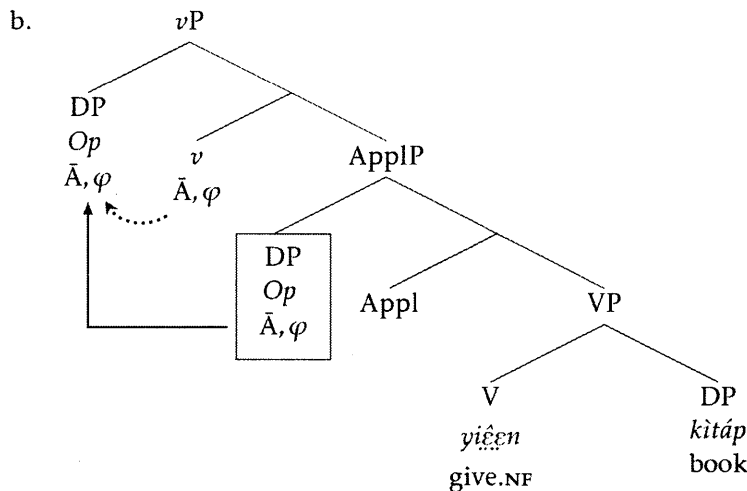

24. Because  $v$  does not host terminal  $\bar{A}$ -movement, we need to make a distinction between  $\bar{A}$ -probes that only trigger intermediate movement, such as on  $v$  and on intermediate C, and  $\bar{A}$ -probes that establish the final movement step in a movement dependency. I posit then that the  $\bar{A}$ -probe on  $v$  is uninterpretable and unvalued (Abels 2012b), so that  $\bar{A}$ -movement to a specifier of  $v$  cannot terminate there.

In this derivation, the goal is merged as the highest object in Spec-AppIP and is the closest target for the composite  $\bar{A}$ -probe and  $\varphi$ -probe on  $v$ . As a result, both probes are valued on the goal DP and it is attracted to a specifier of  $v$ .

The question that arises now is what happens in a double object construction when the theme, the lower object, carries an  $\bar{A}$ -feature. I propose the derivation in (86).

(86) **Intermediate movement of theme in double object construction:**

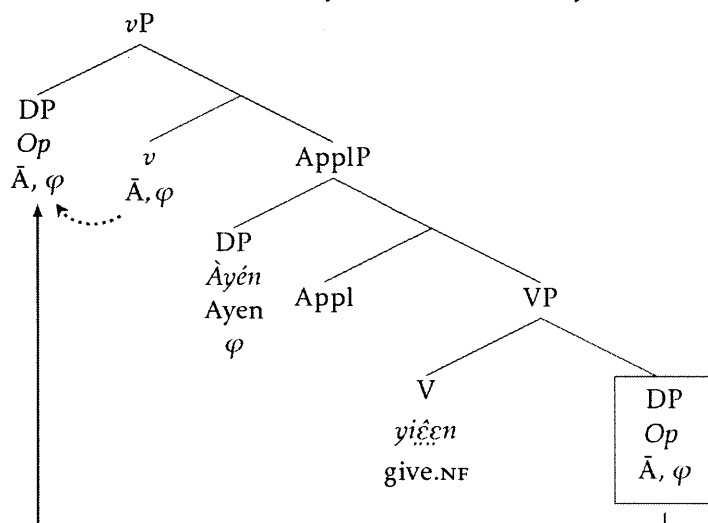

Because the lower object carries both features that make up the composite probe on  $v$ ,  $v$  initiates an Agree relation with the theme. As a result, the theme moves to Spec- $v$ P and satisfies all the needs of  $v$ . This explains why the object that does not undergo movement cannot occupy Spec- $v$ P, regardless of whether it is the higher or lower object.

In this approach, there is no derivation with intermediate movement of an object of a ditransitive in which the other object moves to Spec- $v$ P, which is the correct result. One open issue is how the indirect object is licensed in a derivation like (86), since  $v$  is its usual case assigner. One possibility might be that the  $\varphi$ -probe  $v$  can enter into a Multiple Agree relation, and so assigns absolutive to all the DP objects inside the verb phrase.<sup>25</sup> In any case, the idea that intermediate movement satisfies all the features of  $v$  successfully derives the V2 patterns in ditransitives. In addition, the same story extends to the causative facts.

In order to extend this proposal to adjunct extraction, we need to be more explicit about the logic of composite probing. As discussed previously, in such derivations, intermediate movement does not satisfy V2, and the probes on  $v$  attracts two separate XPs. I propose that adjuncts cannot enter into  $\varphi$ -agreement with  $v$  because they are not nominals, but PPs (and, importantly, incorporation

25. In addition, we need a process of verb cluster formation to ensure that the unmoved object in a derivation like (86) still follows the main verb when a secondary auxiliary is present.

of P happens later, as suggested in Chapter 3).<sup>26</sup> Since  $\varphi$ -agreement is restricted to nominals in Dinka, PPs cannot be attracted to Spec- $v$ P by its  $\varphi$ -probe. The syntax of the verb phrase in an example of adjunct extraction like (87a) is then something like (87b).

(87) *Derivation of adjunct extraction:*

- a. **Pǎal** à-cɛ̀nɛ̀ Áyèn [vP **cụịn**] cáam.  
 knife 3S-PRF.OBLV Ayen.GEN food eat.NF  
 ‘With a knife, Ayen has eaten food.’

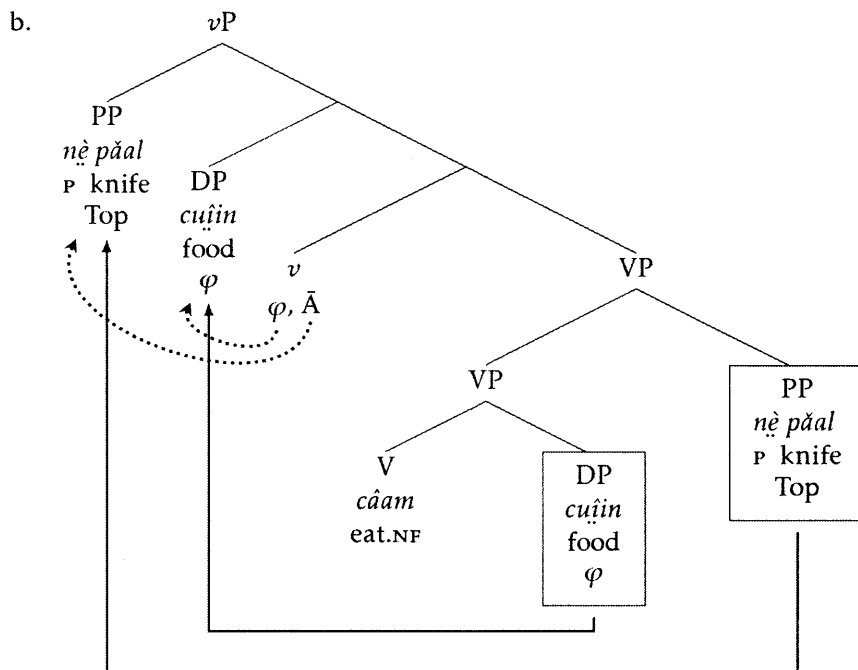

In the structure in (87b), there is no goal that can fully satisfy the composite probe on  $v$ . The presence of a P prevents its DP complement from being visible for  $\varphi$ -agreement, and the object lacks an  $\bar{A}$ -feature. The  $\varphi$ -probe on  $v$  targets the object and attracts it to an inner specifier of  $v$ .

I propose that, in situations where there is no goal that satisfies all the features of a composite probe, Agree with partially matching goals is possible. A similar suggestion is made by Coon and Bale (2014), because agreement in Mi'gmaq also defaults to the closest goal (the subject) if there is no plural participant around. To achieve this, Coon and Bale propose an algorithm for selecting the best possible goal, of which I adopt a modified version here. To be precise, I propose the principle of Best Match in (88).<sup>27</sup>

26. Specifically, as outlined in Chapter 3 (sec. 2.4), prior to movement to Spec-CP, the P head of the instrumental PP cliticizes onto T, yielding Oblique Voice marking. This allows for the DP to be agreed with and assigned absolutive case by C.

27. Coon and Bale offer a more complex calculus, which is also compatible with what I say here, though see fn. 30.

(88) **Best match:**

An active probe P enters into an Agree relation with the closest syntactic object that matches in the most features. (cf. Coon and Bale 2014:99)

Best Match tells a probe (whether composite or not) to target the closest phrase in the set of XPs that match the probe most closely. If the probe is composite, and there is an XP that carries all of the relevant features, Best Match forces an Agree relation between the two elements. But Best Match also allows for Agree relations when all available goals partially match the probe.

One environment in which Best Match is necessary is an ordinary transitive sentence (89a), in which a DP object moves to Spec-*v*P to be assigned case. In my proposal, *v* is a composite probe consisting of  $\varphi$ -features and a flat  $\bar{A}$ -probe, even though there is no XP in the sentence with an  $\bar{A}$ -feature.

(89) **Derivation of a transitive with composite probe on *v*:**

- a. Àyén à-cé **cuḷin** câam nẹ pǎal.  
Ayen 3S-PRE.SV **food** eat.NF P knife  
'Ayen has eaten food with a knife.'

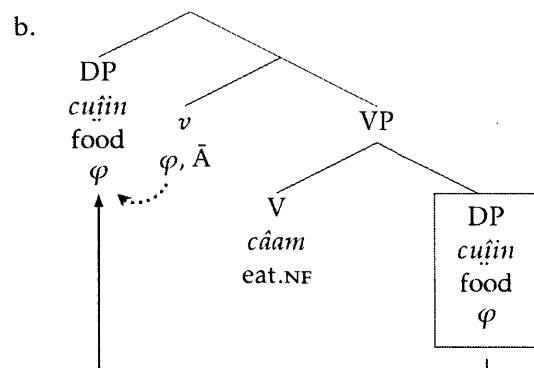

Although there is no goal that constitutes a complete match for *v*, the DP object is a *partial* match, because it carries  $\varphi$ -features. What Best Match captures is that such a partial match is better than no match at all. In compliance with Best Match, *v* then enters into an Agree relation with the object.

I suggest that Best Match also extends to the more complex case of adjunct extraction, the derivation of which is repeated in (90).

(90) *Derivation of adjunct extraction:*

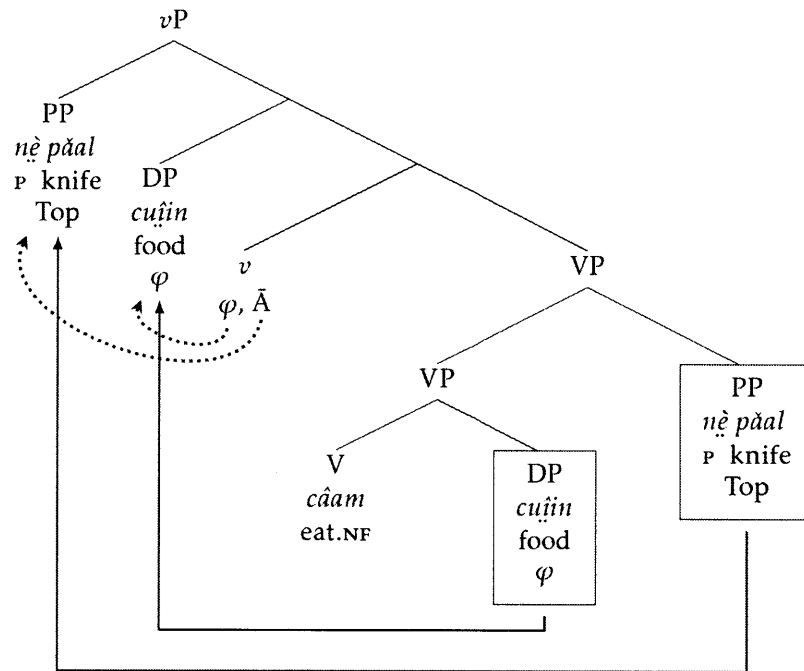

As in the transitive example in (89a–b), none of the XPs in (90b) are a full match for  $v$ . However, there are two phrases, the DP object and the topicalizing PP, that constitute a partial match. In such a configuration, Best Match allows  $v$  to Agree with one of the partially matching goals, such as the PP. Suppose that  $v$  Agrees with the PP and attracts it to a specifier. However, at this point,  $v$  still has unvalued  $\varphi$ -features. I suggest that the probe on  $v$  remains active because of this and can enter into another Agree relation. The DP object is now the best goal as dictated by Best Match. The lower PP copy is ignored, under the assumption that only the head of a chain is active for intervention.<sup>28</sup> The DP is attracted to another specifier of  $v$ , tucking-in under the PP (Richards 1997).<sup>29</sup> In this way, the idea that probing obeys a principle like Best Match can explain why intermediate movement will satisfy V2 when it can but result in a V3 structure otherwise.<sup>30</sup>

28. See, for example, Chomsky 2000, Béjar and Rezac 2003, Anagnostopoulou 2003, Holmberg and Hróarsdóttir, 2003, and Sigurðsson and Holmberg 2008.

29. More needs to be said about why the order of specifiers formed by multiple probing of  $v$  is fixed, with the phrase undergoing intermediate movement always appearing in a higher specifier.

30. There is an important difference in what happens in configurations with partial matches in the Mi'gmaq pattern described by Coon and Bale and in the Dinka pattern I am interested in here. In Mi'gmaq, the composite [plural]-[participant] defaults to the closest goal bearing any  $\varphi$ -features at all. This leads Coon and Bale to a more complex calculus of how to compare partially matching goals, according to which any goal that is not a full match is assigned the same rank. What this achieves is that a DP that only carries a [participant] feature is not favored over a closer DP that carries neither [participant] or [plural]. This calculus is compatible with what I say here, because I proposed instead that the probe on  $v$  in Dinka is able to initiate Agree again, based on the fact that it carries unvalued features still. I posit that there is no such Multiple Agree in Mi'gmaq, because all the goals under comparison carry person

To sum up this section, I showed how the idea that  $v$  carries a composite probe can capture the interplay of V2 and intermediate movement in the Dinka verb phrase, adopting the principle of Best Match to regulate configurations in which only partial matches are available to a probe. Importantly, this analysis relied on the idea that there are multiple movement-driving features on intermediate  $v$ , and that intermediate movement, like other instances of phrasal movement, involves an Agree relation.

### 5.3 Object agreement and successive cyclicity

Let me conclude this section by briefly discussing the covert  $\varphi$ -agreement I posit on Dinka  $v$ . In this chapter so far, I have argued that intermediate movement values  $\varphi$ -features on C as well as on  $v$  along the way, and have used the distribution of this effect to argue for the idea that intermediate movement is feature-driven. At C, we saw the overt consequences of this syntax for  $\varphi$ -agreement. At the verb phrase level, however, this effect on  $\varphi$ -agreement is covert. We might then expect to find languages in which overt object agreement is affected by successive-cyclic movement across it, in the same way that  $\varphi$ -agreement at C is in Dinka. In this section, I show that this pattern is attested in a number of languages, including Kiribati, Fijian, and Hungarian.

Sabel (2013) investigates object agreement in Kiribati and Fijian. Sabel shows that long-distance movement in both languages affects object agreement on the verbs on the path of movement. I will illustrate with Kiribati. Kiribati has an object agreement suffix that appears on the verb and agrees with the object DP or CP. In (91a), we see that the matrix verb carries 3rd person singular agreement, for the object CP, and the embedded verb 3rd person plural agreement, tracking its DP object. In cases of long-distance movement, object agreement on all intermediate verbs targets the moving phrase. In (91b–c), we see that, if the embedded DP object undergoes movement, all verbs must show 3rd person plural agreement.

(91) *Object agreement in Kiribati tracks intermediate movement:*

- a. Ti ata-i-a [CP bwa e tangir-i-ia Meeiri ao Tien Rui].  
1PL KNOW-TR-3SG that 3SG loves-TR-3PL Meeri and Tien Rui  
'We know that Rui loves Meeri and Tien.'
- b. **Meeiri ao Tien** aika ti ata-i-ia [CP bwa e tangir-i-ia \_\_\_ Rui].  
**Meeri and Tien** FM 1PL KNOW-TR-3PL that 3SG loves-TR-3PL Rui  
'It is Meeri and Tien that we know that Rui loves.'
- c. \***Meeiri ao Tien** aika ti ata-i-a [CP bwa e tangir-i-ia \_\_\_ Rui].  
**Meeri and Tien** FM 1PL KNOW-TR-3SG that 3SG loves-TR-3PL Rui  
'It is Meeri and Tien that we know that Rui loves.'

(Kiribati; Sabel 2013:17–18)

---

and number features. As a result, Agree with a DP that does not carry [participant] or [plural] will still provide a value for person and number (overtly registered in the morphology), thereby deactivating the probe.

As Sabel points out, these facts provide evidence for successive-cyclic movement to the edge of the verb phrase. If  $v$  carries a probe responsible for initiating intermediate movement as well as a  $\varphi$ -probe, we can derive these facts in the same way as the Dinka pattern. These two probes form a composite probe which targets the moving phrase.

Hungarian may display a similar pattern of interaction between movement and object agreement (e.g. Kiss 1987; Den Dikken 2006, 2009). In (92), we see that long  $\bar{A}$ -movement may be accompanied by changes in agreement on intermediate verbs as well as accusative case on the moving phrase. (See Den Dikken 2009 for extensive discussion of this and related patterns.)

(92) *Long movement in Hungarian may trigger changes in case and agreement:*

Téged mondta-lak [<sub>CP</sub> hogy szeretné-lek [<sub>CP</sub> hogy elnök leygél]].

you.ACC said-1SG→2 that would.like-1SG→2 that president be.2SG

'It is you that I said that I would like to be president.'

(Hungarian; Den Dikken 2009:13)

These agreement patterns then provide overt instantiations of the pattern I posited obtains in Dinka underlyingly. As a result, they offer further evidence for the notion of intermediate movement through  $vP$  edges and the idea that  $\varphi$ -agreement may piggyback on feature-driven successive-cyclic movement.

In this section, we have seen that intermediate movement to the edge of  $vP$  patterns the same way as terminal movement to the  $vP$  edge: it is visible to the  $\varphi$ -probe on  $v$  and may satisfy V2. A consistent picture then emerges from the study of how intermediate movement affects Spec-CP and Spec- $vP$  in Dinka: all phrasal movement has the same status in the morphosyntax. To capture this, I propose that intermediate movement, like all other movement in Dinka, is triggered by an Agree relation with the attracting head.

## 6 On the parallelism of CP and $vP$

In the rest of the chapter, I would like to examine the consequences of the facts described here for phase theory. One of the main lessons to emerge from the discussion of Dinka in this chapter is that CP and  $vP$  are parallel domains. In Dinka, both host intermediate movement, V2, and trigger case assignment. As I have emphasized here, this provides evidence for Chomsky's (1986 et seq.) proposal that CP and  $vP$  represent the two cyclic domains, or phases, that make up clauses. If this is on the right track, we expect that the picture that characterizes Dinka, reflexes of successive cyclicity may be found at either edges, is true across languages also.

In this section, I demonstrate that there is a high degree of symmetry between CP and  $vP$  in the distribution of reflexes of successive-cyclic movement. Specifically, we will see that, for almost all of the effects that have been tied to intermediate movement, we can find instances of the effect both at the CP and the  $vP$  edge. This result is summarized in the table in (93).



(93) *Reflexes of successive cyclicity at CP and vP:*

	CP	vP
1. $\varphi$ -agreement	Dinka, Kinande, Wolof, ...	Kiribati, Fijian, ...
2. V2 satisfaction	Dinka, German	Dinka
3. Multiple copy spell-out	German, Seereer, ...	Dinka
4. Extraction marking	Irish, Seereer, ...	Defaka, Malay, ...
5. <i>Wh</i> -trapping/clausal pied-piping	Basque, Quechua	Trinidadian English, Ewe
6. Scope trapping	English, ...	English, ...
7. Stranding	West Ulster English, Polish	Dutch, Polish
8. Downstep deletion	(Kikuyu?)	Kikuyu
9. Inversion	Belfast English, Spanish, Italian, ...	Mòcheno

We have already seen that intermediate movement may interact with  $\varphi$ -agreement and V2 at both edges, using data from Dinka and the languages reviewed in the previous section. Other instances of  $\varphi$ -agreement at CP are found in Kinande and Wolof (Torrence 2005; Schneider-Zioga 2007). In addition, I discussed a pattern of pronoun copying at the vP edge, *ké*-copying, that I argue in detail represents multiple copy spell-out in Chapter 6. As a result, *ké*-copying constitutes the vP counterpart to *wh*-copying.<sup>31</sup> I discuss the effects in 4 through 9 in turn, showing that, consistently, the same symmetrical picture emerges with these as well.

### 6.1 *Extraction marking*

I will start with one of the most famous reflexes of successive-cyclic movement, the appearance of morphemes that seem to mark specifically that movement has taken place. A well-known example is Irish (e.g. McCloskey 1979, 2001, 2002). Irish complementizers take different forms depending on whether  $\bar{A}$ -movement to the clause edge has taken place. We can see this in the contrast between (94a), an embedded clause without movement, and (94b), a CP in a relative clause.<sup>32</sup>

(94) *Two different complementizers in Irish:*

- a. Creidim [CP **gu-r** inis sé bréag].  
believe.1SG C.DCL-PAST tell he lie  
'I believe that he told a lie.'

31. I also describe a pronoun copying pattern found at the CP edge that is very similar to *ké*-copying, from Baier's (2014) work on Seereer.

32. Note that Irish also has an extraction-marking complementizer that appears in resumption, which I abstract away from here (but see McCloskey 2002 for detailed discussion, for example).

- b. an fhilíocht [<sub>CP</sub> a chum sí \_\_\_\_]  
 the poetry c.EXT composed she  
 ‘the poetry that she composed’  
 (McCloskey 2002:185–186)

Importantly, the extraction complementizer also appear at intermediate CP edges, so that long-distance movement is accompanied by a trail of such complementizers, as in (95).

(95) *Extraction complementizer appears in intermediate clauses:*

- an t-ainm [<sub>CP</sub> a hinnseadh dúinn [<sub>CP</sub> a bhí \_\_\_\_ ar an áit]]  
 the name c.EXT was-told to-us c.EXT was on the place  
 ‘the name that we were told was on the place’  
 (McCloskey 2002:185)

This is often cited as evidence that there is movement both to the final and intermediate clause edge in long-distance dependencies.

Other languages display similar patterns. Baier (2014) describes the syntax of an extraction suffix *-u* that appears on the verb in the Senegalese language Seereer. This suffix appears with *wh*-movement of subjects and objects, for instance (96a–b).

(96) *Extraction suffix in Seereer:*

- a. an jaw-**u** maalo?  
 who cook-EXT rice  
 ‘Who cooked rice?’  
 b. xar Jegaan a jaw-’-**u**?  
 who Jegaan 3SG cook-PST-EXT  
 ‘What did Jegaan cook?’  
 (Seereer; Baier 2014:5,7)

As Baier observes, this suffix appears on all verbs on the path of a long-distance dependency (97), and so has the same distribution as the Irish complementizer described above.

(97) *Seereer extraction suffix appears on all intermediate verbs:*

- a. mban a xalaat-**u** [<sub>CP</sub> yee ten Jegaan a fon-**u** a Yande]?  
 when 3SG think-EXT c 3SG Jegaan 3SG kiss-EXT OBJ Yande  
 ‘When does he think Jegaan kissed Yande?’  
 b. xar xalaat-**o** [<sub>CP</sub> yee ten Jegaan a ga’-**u**]?  
 what think-2SG.EXT c 3SG Jegaan 3SG see-EXT  
 ‘What do you think Jegaan saw?’  
 (Seereer; Baier 2014:9)

Both in Seereer and in Irish then, a dedicated morpheme appears to indicate movement to the edge of the clause.

We can also find such morphemes at the *vP* edge. Bennett et al. (2012) describe a *vP*-level extraction morpheme in the Ijoid language Defaka. In Defaka, the morpheme *kè* appears at the end of the verb with movement out of the verb phrase. *Wh*-movement or focus movement of the subject is not accompanied by this suffix (98a), but movement of an object or adjunct PP is (98b–c).

(98) *Defaka -kè appears with non-subject extraction:*

- a. ì kò Bòmá ésé-kà-rè  
I FOC.SBJ Boma see-FUT-NEG  
'It is me that will not see Boma.'
- b. tári ndo Àmànyà ómgbìnyà sònò àmà-kè \_\_\_ kí'á 'tè?  
who FOC Amaya shirt buy give-EXT market P  
'Who did Amaya buy a shirt for at the market?'
- c. [PP ándù kikià] ndò à èbèrè rì bòi-mà-kè  
canoe under FOC the dog RE hide-NFUT-EXT  
'It is under the canoe that the dog is hiding.'  
(Defaka; Bennett et al. 2012:294,296)

As a result, Bennett et al. analyze *-kè* as a marker of intermediate movement to the *vP* edge. In accordance with this, the suffix appears on all intermediate verbs, with extraction of embedded subjects or objects, for example (99a–b).

(99) *Defaka -kè appears on all intermediate verbs:*

- a. Bruce ndò Bòmá jíri-kè [CP \_\_\_ á ésé-mà]  
Bruce FOC Boma know-EXT her see-NFUT  
'It is Bruce that Boma knows saw her.'
- b. áyá jíkà ndò Bòmá ì biè-kè [CP ì ísò \_\_\_ sònó-mà-kè]  
new house FOC Boma I ask-EXT I ISO buy-NFUT-EXT  
'It is a new house that Boma asked me if I'm going to buy.'

Defaka *-kè* is then the counterpart of Seereer *-u* at the edge of the verb phrase.

Another pattern that has been treated as extraction marking at the verb phrase level is voice marking in Malay/Indonesian languages (e.g. Saddy 1991, 1992; Cole and Hermon 1998; Sato 2012). Malay/Indonesian has an opposition between Subject Voice and Object Voice signaled by the prefix *meN-*. This voice marking is usually analyzed as a *vP*-level morpheme (Cole et al. 2008; Sato 2012; cf. Rackowski and Richards 2005), because, unlike in Dinka, voice marking is lower than tense or aspect marking.

Voice has much the same distribution as Dinka. In Malay, for example, *meN-* appears optionally with movement of subjects, but cannot appear with movement of DPs out of the verb phrase (100b).

(100) *MeN- cannot appear with movement out of the vP:*

- a. siapa (**mem**)-beli buku itu?  
who (**sv**)-bought book that  
'Who bought that book?'
- b. apa Ali (**\*mem**)-beri pada Fatimah?  
what Ali (**\*sv**)-gave to Fatimah  
'What did Ali give to Fatimah?'  
(Malay; Cole and Hermon 1998:231)

Intermediate verbs must have the OV form, even with extraction of embedded subjects (101).

(101) *MeN- cannot appear on intermediate verbs:*

- siapa Bill (**\*mem**)-beritahu ibunya [CP yang \_\_\_ (**men**)-yintai Fatimah]?  
who Bill (**\*sv**)-tell mother.his that (**sv**)-love Fatimah  
'Who does Bill tell his mother that loves Fatimah?'

We then find symmetry in the distribution of extraction markers that are sensitive to both terminal and intermediate movement: we find instances of these morphemes at the clause edge (Irish and Seereer) and at the verb phrase edge (Defaka and Malay/Indonesian).

## 6.2 *Wh-trapping and clausal pied-piping*

Another piece of evidence for intermediate movement steps comes from the interaction of intermediate successive-cyclic movement with pied-piping of CPs and vPs (e.g. Hermon 1985; Ortiz de Urbina 1989, 1993; Arregi 2003; Cozier 2006; Buell 2012).

Intermediate movement to the CP edge is evident in languages with clausal pied-piping. In languages like Quechua and Basque (e.g. Hermon 1985; Ortiz de Urbina 1989, 1993; Arregi 2003), *wh*-words pied-pipe complement clauses. Importantly, intermediate movement to the CP edge still takes place inside of such CPs (102a–b).<sup>33</sup>

(102) *Clausal pied-piping in Quechua and Basque:*

- a. [CP **Ima-ta** wawa \_\_\_ miku-chun-taj] Maria muna-n?  
**what-ACC** child.NOM eat-SUBJ-Q Maria want-PR.3  
'What does Maria want that the child eat?'  
(Imbabura Quechua; Hermon 1985:151)
- b. [CP **Se** idatzi rabela Jonek] pentzate su?  
**what** written has Jon.ERG you-think  
'What do you think Jon wrote?'  
(Basque; Arregi 2003:118)

33. Though see Arregi 2002 on *wh*-movement in Basque.

Such facts demonstrate that there is a step of *wh*-movement to the intermediate CP edge before movement to the matrix left periphery.

Intermediate movement plus clausal pied-piping is also found in relativization out of German infinitives (Ross 1967). The examples in (103a–c) demonstrate. The relative pronoun *den* may pied-pipe an infinitival clause, after moving to the left periphery of that clause.

(103) ***Pied-piping of infinitives in German relative clauses:***

- a. der Hund, [<sub>CP</sub> **den** ich zu finden zu versuchen angefangen habe]  
the dog        **which** I to find to attempt begun have  
'the dog, which I began to attempt to find'
  - b. der Hund, [<sub>CP</sub> [<sub>CP</sub> **den** zu finden] ich zu versuchen angefangen habe]  
the dog                **which** to find I to attempt begun have  
'the dog, which I began to attempt to find'
  - c. der Hund, [<sub>CP</sub> [<sub>CP</sub> **den** zu finden zu versuchen] ich angefangen habe]  
the dog                **which** to find to attempt I begun have  
'the dog, which I began to attempt to find'
- (German; Heck 2008:109)

See also Huhmarniemi (2012) for widespread effects of this sort in Finnish, and Heck (2008: sec. 2.3) for detailed discussion of clausal pied-piping.<sup>34</sup>

At first glance, there appears to be no symmetry in this domain, because a proposed crosslinguistic generalization for pied-piping is that *v*Ps cannot be pied-piped (Cable 2007, 2010; Heck 2008, 2009). As evident in examples (104a–b) and (105a–b) from English and Dutch, nouns and prepositions can be pied-piped by *wh*-movement. Verbs, however, cannot, as in (104c) and (105c).<sup>35</sup>

(104) ***No pied-piping of verbs in English:***

- a. [<sub>DP</sub> Whose pictures] should I buy?
- b. [<sub>PP</sub> With what] should I buy them?
- c. \*<sub>[VP</sub> Buy what] should I?

(105) ***No pied-piping of verbs in Dutch:***

- a. [<sub>DP</sub> Wie zijn foto's] moet ik kopen?  
who his pictures must I buy  
'Whose pictures should I buy?'
- b. [<sub>PP</sub> Met wie] moet ik dansen?  
with who must I dance  
'Who should I dance with?'

34. Clausal pied-piping is typically restricted to nominalized or infinitival clauses. But this does not diminish the point that the effects of intermediate movement are visible when pied-piping of a clause is possible.

35. See Cable (2007, 2010) and Heck (2008, 2009) for accounts of this asymmetry.

- c. \*<sub>[VP</sub> Wat kopen] moet ik?  
       what buy     must I  
       (lit.) 'Buy what should I?'

However, although *wh*-phrases cannot trigger verb phrases in isolation, an effect I will call *wh*-trapping may emerge when *wh*-movement co-occurs with an independent instance of VP-fronting, as shown by Cozier (2006) and Buell (2012). In such environments, we find clear evidence for intermediate movement to the *v*P edge.

Cozier (2006) describes an interaction between intermediate movement to the *v*P edge and predicate clefting in Trinidadian English. Trinidadian English has a cleft construction, which is the focus of this argument. This can be used to focus subject and objects (106a–b). But, unlike in many other varieties of English, it is also possible to cleft a bare copy of the verb, in a predicate clefting construction (106c). (I indicate the base position of a predicate cleft with italics.)

(106) *Trinidadian English allows clefting of subjects, object, and predicates:*

- a. Was Tim [that \_\_\_ did give his car to Misha].  
 b. Is **a car** [that Tim did give \_\_\_ to Misha].  
 c. Is **walk** [that Tim did *walk*].  
       (Trinidadian English; Cozier 2006:656,657,660)

Cozier establishes that predicate clefts involve  $\bar{A}$ -movement in Trinidadian English: they can be unbounded (107a), but are island-sensitive (107b).

(107) *Predicate clefting is unbounded but sensitive to islands:*

- a. Is **talk** [he tell me [that she *talk* about Ricky]].  
 b. \*Is **talk** [he tell me [why she *talk* about Ricky]].  
       (Trinidadian English; Cozier 2006:663)

Cozier argues that predicate clefting is phrasal movement, even though material following the verb must be stranded (108a–b). This is based on the observation that low adverbs to the left of the verb can be moved in a predicate cleft (108c–d).<sup>36</sup>

(108) *Predicate cleft pied-pipes material to the left:*

- a. \*Is **walk to work** [that Tim *walking* (to work)].  
 b. \*Is **sing the song** [that Tim did *sing* (the song)].  
 c. Is **briefly touch** [he did *touch* upon that matter].  
 d. Is **cleverly avoid** [he *avoid* the question].  
       (Trinidadian English; Cozier 2006:662,666)

---

36. Note that these adverbs must originate in the lower verb phrase, because they cannot modify the cleft clause.

Importantly, *wh*-words that have undergone intermediate movement to the edge of the verb phrase can be pied-piped as well, as in (109a–b). This must be pied-piping, because multiple XPs cannot appear in the cleft position otherwise (109c).

- (109) **Predicate cleft may pied-pipe *wh*-words:**
- a. Is **what** **fix** [he did *fix* \_\_\_ yesterday]?
  - b. Is **who** **fix** [he did *fix* the car for \_\_\_]?
  - c. \*Is **Mel** **what** [that he did give \_\_\_ to \_\_\_]?  
(Trinidadian English; Cozier 2006:668,670)

Cozier proposes that *wh*-words end up at the left edge of the verb phrase because of intermediate movement and are dragged along by predicate clefting. In support of this, he observes that only *wh*-words that are generated inside the *v*P can be pied-piped, as in (109a–b). Subjects and high adjuncts cannot (110a–c).

- (110) ***Wh*-subjects and adjuncts cannot be pied-piped:**
- a. \*Is **who** **talk** [\_\_\_ *talking* about she]?
  - b. \*Is **when** **fix** [he did *fix* the car \_\_\_]?
  - c. \*Is **why** **fix** [he *fix* the car \_\_\_]?  
(Trinidadian English; Cozier 2006:670,679)

But these asymmetries disappear when the *wh*-words comes from an embedded clause. In this case, predicate clefting of the matrix verb can drag along the embedded subject (111a), object (111b), or a *v*P-external adjunct (111c).

- (111) **Pied-piping asymmetries disappear with long-distance movement:**
- a. Is **who** **tell** [Tim *tell* you [that he give the car to \_\_\_]]?
  - b. Is **who** **tell** [Tim *tell* you [that \_\_\_ give the car to she]]?
  - c. Is **when** **say** [she *say* [she go call back \_\_\_]]?  
(\*matrix reading)  
(Trinidadian English; Cozier 2006:681,683)

In this way, *wh*-phrases that undergo intermediate movement can become trapped in a *v*P that undergoes movement, providing evidence for the idea that there is successive-cyclic movement to every verb phrase edge.

A similar pattern is documented by Buell (2012) in Ewe. In Ewe, nominalized *v*Ps may be fronted in the progressive and prospective aspect. This type of *v*P fronting may pied-pipe *wh*-phrases, as long as they are generated inside the verb phrase. As in Trinidadian English, objects can be pied-piped by the *v*P (112a), but subjects and adjuncts cannot (112b–c).

(112) *Objects but not subjects and high adjuncts can be pied-piped:*

- a. [<sub>vP</sub> Núkà d̀ù-r̀m] ǹè-l̀è?  
**what** eat-PROG 2SG-be.at  
 ‘What are you eating?’
- b. \*<sub>vP</sub> Àmékà dzó] gé l̀è?  
**who** leave PROSP be.at  
 ‘Who is about to leave?’
- c. \*<sub>vP</sub> Núkàt̀à dzó-r̀m] ǹè-l̀è?  
**why** leave-PROG 2SG-be.at  
 ‘Why are you leaving?’  
 (Ewe; Buell 2012:4,7)

In addition, as in Trinidadian English, intermediate *wh*-phrases that have undergone long-distance movement can be pied-piped (113).

(113) *Movement of intermediate vP can pied-pipe wh-phrase:*

- [<sub>vP</sub> Núkà dí-r̀m] ǹè-l̀è [<sub>CP</sub> bé má-d̀à \_\_\_\_] ?  
**what** want-PROG 2SG-be.at that 1SG.FUT-prepare  
 ‘What do you want me to make?’  
 (Ewe; Buell 2012:19)

Not only do these facts provide independent evidence for intermediate movement to the edge of each verb phrase, they show that both intermediate movement through CP and through *vP* may interact with pied-piping, again highlighting the symmetries between these domains.

### 6.3 *Scope trapping*

The effects of intermediate successive-cyclic movement are also evident in the interaction of Late Merge with *c*-command conditions on Principle C and variable binding, as pointed out by Lebeaux (1998) and Fox (1999). This effect is sometimes called *scope trapping*.

As suggested also in Chapter 2, adjuncts may undergo Late Merge to a *wh*-phrase in Spec-CP, so that there is no violation of Principle C (114a). Lebeaux (1998) observes that Late Merge may be forced to occur earlier, by including a bound pronoun in the adjunct that must be bound by a quantifier. In (114b), for instance, Late Merge of the adjunct in matrix Spec-CP is impossible because the pronoun *he* must be *c*-commanded by *every student*. As a result, the adjunct must be merged lower than the pronoun *she*, inducing a Principle C effect.



- (114) **The applicability of Late Merge may be constrained by variable binding:**
- a. [DP Which argument that John<sub>i</sub> made] did he<sub>i</sub> believe?
  - b. \*[DP Which of the papers that he<sub>i</sub> gave to Ms. Brown<sub>k</sub>] did she<sub>k</sub> hope that every student<sub>i</sub> will revise \_\_\_?  
(Fox 1999:173)

As observed by Lebeaux and Fox, the competing constraints that Principle C and variable binding impose may be used to show that there are intermediate Spec-CP positions at which Late Merge can apply. Consider the contrast between (115a) and (115b).

- (115) **Late Merge may apply in intermediate positions:**
- a. \*[DP Which of the papers that he<sub>i</sub> gave to Ms. Brown<sub>k</sub>] did she<sub>k</sub> hope that every student<sub>i</sub> will revise \_\_\_?
  - b. [DP Which of the papers that he<sub>i</sub> gave to Ms. Brown<sub>k</sub>] did every student<sub>i</sub> hope that she<sub>k</sub> will revise \_\_\_?  
(Fox 1999:173)

The grammaticality of (115b) demonstrates that there is an intermediate position in long-distance movement at which Late Merge can apply. In particular, the intermediate position lies between the quantifier *every student* and the pronoun *she*, and so interpreting the adjunct there satisfies both the conditions on variable binding and those on Principle C. Importantly, Late Merge at matrix Spec-CP would prevent variable binding and merging the adjunct in the base position should violate Principle C. Such cases then indicate that there are intermediate landing sites in long-distance movement.

Fox (1999) uses such effects to argue for an intermediate landing site at the *vP* edge. He points out to contrasts such as (116a–b).

- (116) **Late Merge may apply at *vP* edge:**
- a. [DP Which of the papers that he<sub>i</sub> asked Ms. Brown<sub>k</sub> for] did every student<sub>i</sub> [<sub>*vP*</sub> get her<sub>k</sub> to grade \_\_\_]?
  - b. \*[DP Which of the papers that he<sub>i</sub> asked Ms. Brown<sub>k</sub> for] did she<sub>k</sub> [<sub>*vP*</sub> get every student<sub>i</sub> to grade \_\_\_]?  
(Fox 1999:174)

In the grammatical (116a), the only intermediate position that can satisfy both variable binding and Principle C is in between the subject quantifier and the object, thus providing evidence for a landing site for long-distance movement at the *vP* edge.

We can manipulate these examples slightly to provide evidence for an intermediate Spec-CP position. Consider the pair in (117a–b), where the only difference is in the matrix indirect object and the embedded subject.

(117) **Late Merge may apply at CP edge:**

- a. [DP Which of the papers that he<sub>i</sub> asked Ms. Brown<sub>k</sub> for] did you tell every student<sub>i</sub> [CP she<sub>k</sub> liked \_\_\_]?
- b. \*[DP Which of the papers that he<sub>i</sub> asked Ms. Brown<sub>k</sub> for] did you tell her<sub>k</sub> [CP every student<sub>i</sub> liked \_\_\_]?

The admissibility of (117a) suggests that there is an intermediate position between indirect objects and embedded subjects, which I propose is Spec-CP.

The same picture as above then emerges from an examination of scope trapping effects: both Spec-CP and Spec-*v*P are implicated to the same degree as intermediate landing sites.<sup>37</sup>

#### 6.4 Stranding

Another well-known reflex of successive-cyclic movement is stranding in intermediate positions (e.g. du Plessis 1977; McCloskey 2000; Barbiers 2002; Koopman 2010). A commonly cited example is *all*-stranding in West Ulster English, described by McCloskey (2000). In West Ulster English, complex *wh*-phrases such as *what all* may strand *all* under *wh*-movement (118a–b). Alongside stranding in the base position, it is possible to strand *all* in an intermediate position (118c).

(118) **All-stranding in West Ulster English:**

- a. **What all** did he say [CP he wanted \_\_\_]?
- b. **What** did he say [CP he wanted **all**]?
- c. **What** did he say [CP **all** he wanted \_\_\_]?  
(West Ulster English; McCloskey 2000:61)

As McCloskey points out, this provides evidence for intermediate landing sites in long-distance movement. The complex *wh*-phrase *what all* moves to an intermediate position, and subsequent movement of *what* to matrix Spec-CP strands *all* in the intermediate landing site.

McCloskey argues that intermediate stranding in (118c) occurs in the intermediate Spec-CP, because the stranded *all* must follow material in the matrix verb phrase. This is demonstrated by the examples in (119a–c).

(119) **Stranded all must follow matrix *v*P-material:**

- a. **What all** did he say to him that he wanted to buy \_\_\_]?
- b. ?**What** did he say to him [CP **all** that he wanted to buy \_\_\_]?
- c. \***What** did he say **all** to him [CP that he wanted to buy \_\_\_]?  
(West Ulster English; McCloskey 2000:63)

---

37. One question is whether we can find configurations similar to the grammatical examples in (116a) and (117a) which are inadmissible because of the absence of an intermediate position in between the relevant DPs. This is what we expect if long-distance movement follows a punctuated path. I set aside this worry here, because it should be clear in any case that scope trapping provides no reason to posit an asymmetry between CP and *v*P as cyclic domains.

These facts then offer an argument for successive-cyclic movement through Spec-CP.

As before, we can find similar patterns at the *vP* edge. As pointed out by Barbiers (2002) and Koopman (2010), a similar pattern is found in Dutch, with stranding of the quantifier *allemaal* (120a–b). However, in Dutch, it is clear that this stranding occurs at the edge of intermediate *vP*, because the stranded quantifier must precede the intermediate verb (120c).<sup>38</sup>

(120) *Stranded allemaal in Dutch occurs at intermediate vP:*

- a. Wat heeft hij gezegd [<sub>CP</sub> dat hij **allemaal** wil hebben]?  
 what has he said that he **all** wants have.NF  
 ‘What all has he said that he wants to have?’
- b. Wat heeft hij **allemaal** gezegd [<sub>CP</sub> dat hij \_\_\_ wil hebben]?  
 what has he **all** said that he wants have.NF  
 ‘What all has he said that he wants to have?’
- c. \*Wat heeft hij gezegd [<sub>CP</sub> **allemaal** dat hij \_\_\_ wil hebben]?  
 what has he said **all** that he wants have.NF  
 ‘What all has he said that he wants to have?’  
 (Dutch; adapted from Koopman 2010:268)

Barbiers (2002) observes that this is a general process in Dutch, which allows for a range of items to be stranded at the intermediate *vP* edge under movement. Prepositions, for example, can be pied-piped (121a), stranded in the base position (121b), or at an intermediate *vP* edge (121c). As above, stranding in an intermediate Spec-CP is impossible (121d).

(121) *Preposition stranding at intermediate vP in Dutch:*

- a. **Waarmee** had jij dan gedacht [<sub>CP</sub> dat je de vis \_\_\_ zou moeten  
 where.with had you then thought that you the fish would have.to.NF  
 snijden]?  
 cut.NF  
 ‘With what had you then thought that you would have to cut the fish?’
- b. **Waar** had jij dan gedacht [<sub>CP</sub> dat je de vis **mee** \_\_\_ zou moeten  
**where** had you then thought that you the fish **with** would have.to.NF  
 snijden]?  
 cut.NF  
 ‘With what had you then thought that you would have to cut the fish?’

38. One difference between Dutch and West Ulster English is that *allemaal* seems to have to be stranded, although it can form a constituent with an in situ *wh*-phrase or the demonstrative *dat* (‘that’). But this complication does not arise with the other stranding patterns described here.

- c. **Waar** had jij dan **mee** gedacht [<sub>CP</sub> dat je de vis \_\_\_ zou moeten **where** had you then **with** thought that you the fish would have.to.NF snijden]?  
cut.NF  
'With what had you then thought that you would have to cut the fish?'
- d. \***Waar** had jij dan gedacht [<sub>CP</sub> **mee** dat je de vis \_\_\_ zou moeten **where** had you then thought **with** that you the fish would have.to.NF snijden]?  
cut.NF  
'With what had you then thought that you would have to cut the fish?'  
(Dutch; adapted from Barbiers 2002:49)

The same facts obtain in the *wat-voor* split. The remnant DP can be pied-piped (122a), stranded in the base position (122b), or stranded at an intermediate *vP* edge (122c). As before, stranding in Spec-CP is ungrammatical (122d).

(122) *Stranding in wat-voor split:*

- a. **Wat voor bal** had jij dan gedacht [<sub>CP</sub> dat Ed \_\_\_ zou kopen]?  
**what for ball** had you then thought that Ed would buy.NF  
'What kind of ball had you then thought that Ed would buy?'
- b. **Wat** had jij dan gedacht [<sub>CP</sub> dat Ed **voor bal** zou kopen]?  
**what** had you then thought that Ed **for ball** would buy.NF  
'What kind of ball had you then thought that Ed would buy?'
- c. **Wat** had jij dan **voor bal** gedacht [<sub>CP</sub> dat Ed \_\_\_ zou kopen]?  
**what** had you then **for ball** thought that Ed would buy.NF  
'What kind of ball had you then thought that Ed would buy?'
- d. \***Wat** had jij dan gedacht [<sub>CP</sub> **voor bal** dat Ed \_\_\_ zou kopen]?  
**what** had you then thought **for ball** that Ed would buy.NF  
'What kind of ball had you then thought that Ed would buy?'  
(Dutch; adapted from Barbiers 2002:49)

Another stranding effect similar to the ones described here is found in Polish. Wiland (2010) points out that left-branch extraction in Polish allows for the NP out of which extraction takes place to be stranded in intermediate positions, including the edge of *vP* and the edge of CP.

The distribution of stranding phenomena then not only provide additional support for the notion of successive-cyclic movement through the *vP* edge, they show that there is symmetry between CP and *vP* in the possibility of stranding under intermediate movement.

## 6.5 Downstep deletion in Kikuyu

In Kikuyu, there is an interaction between movement and tonal downstep that provides an argument for successive cyclicity (e.g. Clements et al. 1983; Clements 1984; Murphy 2015). In particular,  $\bar{A}$ -movement is signaled by the absence of a tonal downstep process that usually occurs postverbally.

In sentences without extraction, verbs trigger the realization of a following high tone, at a lower pitch, as on the final object in (123a), also raising intermediate low tones to high. As (123b) shows, this tonal change is absent in sentences with movement.

(123) **Postverbal tonal downstep is absent with movement:**

- a. Kariokí á-t'ém-íré **mo-tě**.  
 Karioki SM-cut-T **3-tree**  
 'Karioki cut the tree.'
- b. Nó-o o-tém-íré **mo-te**?  
 FOC-who PP-cut-T **3-tree**  
 'Who cut a tree?'  
 (Kikuyu; Murphy 2015:2)

Importantly, the absence of downstep is absent in all clauses on the path of movement (Clements et al. 1983; Clements 1984), so that this process provides evidence for the presence of intermediate movement. We see this in the examples in (124a–b), in which tonal downstep both from the matrix verb and the embedded verb is absent. This is evident, for instance, in the complementizer and the final object.

(124) **Tonal downstep absent in every clause on the path of movement:**

- a. Kamaú é:-ré Ka:náké [<sub>CP</sub> **áte** Káriókí á-tém-íré **mó-tě**].  
 Kamau tell-T Kanaka **that** Karioki SP-cut-T **3-tree**  
 'Kamau told Kanake that Karioki cut the tree.'
- b. Nó-o Kámaú é:-ré Ka:náké [<sub>CP</sub> **áte** o-tém-íré **mo-te**?]  
 FOC-who Kamau tell Kanake **that** PP-cut-T **3-tree**  
 'Who did Kamau tell Kanake cut the tree?'  
 (Kikuyu; Murphy 2015:3,4)

See Murphy (2015) for detailed description of the tonal processes involved, which lies beyond the scope of this section. The important point, however, is that these tonal patterns provide evidence for intermediate landing sites, as they suggest that there is movement in each clause.

A question that arises is whether the Kikuyu pattern is another instance of extraction marking, in which the absence of tonal downstep represents an extraction morpheme similar to Irish *aL*. Murphy (2015) provides a different analysis that is worth reviewing briefly here. In particular, following Clements and Ford's (1979) examination of tone in Kikuyu and closely related languages,

Murphy analyzes downstep as a floating low tone associated with verbs, which must dock on a following phrase. He then proposes that the reason why this floating tone is absent in clauses with movement is that movement leaves an intermediate copy at the *vP* edge, which the floating tone attaches to. Subsequent copy deletion removes the evidence of downstep, leading to the alternations described above.

If Murphy's (2015) analysis is on the right track, tonal downstep in Kikuyu provides a novel source of evidence for intermediate copies and specifically for intermediate copies at the *vP* edge. As Murphy points out, his proposal requires an intermediate landing site immediately following the verb and before other verb phrase material. Under this interpretation of Kikuyu downstep, there is no clear counterpart to this process that requires a copy at the CP edge. This is perhaps not surprising, given that the pattern appears to be specific to Kikuyu in the first place. In addition, the Kikuyu data are not incompatible with the presence of intermediate copies at the CP edge also.<sup>39</sup>

### 6.6 *Inversion*

Another reflex of successive-cyclic movement found in a number of languages is inversion (e.g. Kayne and Pollock 1978; Torrego 1984; Henry 1995). This pattern is found in a number of Romance languages, Belfast English. I illustrate with Belfast English (Henry 1995). In Belfast English, *wh*-movement triggers T-to-C movement, just as in many other varieties of English. However, T-to-C movement occurs in every clause on the path of movement (125a–b).

(125) ***Inversion in Belfast English:***

- a. Who did John hope [<sub>CP</sub> would he see \_\_\_]?
  - b. What did Mary claim [<sub>CP</sub> did they steal \_\_\_]?
- (Belfast English; Henry 1995:109)

Such facts provide evidence that there is movement to the intermediate CP edge and so have been taken as evidence for successive-cyclic movement.

One type of inversion effect at the *vP* edge is documented by Cognola (2013) in work on the Germanic dialect *Mòcheno*, spoken in northern Italy. *Mòcheno* allows both OV and VO orders in the verb phrase, as in the examples in (126a–b), without difference in meaning (Cognola 2008:80).

(126) ***Mòcheno allows VO and OV order:***

- a. Gester    hone    [<sub>vP</sub> a puach **kaft**].  
           yesterday have-1sg    a book    **bought**  
           'Yesterday, I bought a book.'

---

39. In fact, Murphy (2015: sec. 5.1) suggests that tonal changes in constructions involving partial *wh*-movement imply a copy at the CP edge also. It seems to me, however, that the copy he posits in his crucial examples (his 76a–c) could equally reside at the *vP* edge. These options could be teased apart by examining contexts with additional material following the intermediate verbs, potentially revealing symmetry in Kikuyu downstep as well.

- b. Gester hone [<sub>vP</sub> **kaft** a puach].  
 yesterday have-1sg **bought** a book  
 ‘Yesterday, I bought a book.’  
 (Mòcheno; Cognola 2008:81)

However, as Cognola discusses in detail, in the context of *wh*-movement, only VO syntax is possible. The examples in (127a–b) illustrate for subject extraction and (127c–d) for *wh*-movement of an indirect object.

(127) *Inversion in the vP with wh-movement in Mòcheno:*

- a. **Ber** hòt [<sub>vP</sub> **kaft** s puach]?  
**who** has **bought** the book  
 ‘Who bought the book?’
- b. \***Ber** hòt [<sub>vP</sub> s puach **kaft**?]  
**who** has the book **bought**  
 ‘Who bought the book?’
- c. **En bem** hòt-se [<sub>vP</sub> **kaft** de zaitung]  
**to whom** has-she **bought** the newspaper  
 ‘Who has she bought a newspaper?’
- d. \***En bem** hòt-se [<sub>vP</sub> de zaitung **kaft**]  
**to whom** has-she the newspaper **bought**  
 ‘Who has she bought a newspaper?’  
 (Mòcheno; Cognola 2013:7)

Mòcheno provides an instance of inversion at the verb phrase level, essentially analogous to inversion at the CP level in Romance languages (which also often allow inversion without movement). Like the other effects discussed here then, instances of inversion are found both at the CP edge and the *vP* edge, offering evidence that these domains are parallel.

To sum up this section briefly, I have reviewed a variety of effects associated with successive-cyclic movement and how they are distributed across languages. We have seen that there is a high degree of symmetry between CP and *vP*, so that, for any particular reflex of intermediate movement, we can find instances of the effect both at the left periphery of clauses and at the left periphery of the verb phrase. I conclude then that, both within Dinka and across languages, there are no grounds for positing an asymmetry between CP and *vP* in this respect (contra, for instance, Rackowski and Richards 2005 or Den Dikken 2009). Instead, I take this as evidence that clauses universally decompose into two cyclic domains: CP and *vP* (Chomsky 2001 et seq.).<sup>40</sup>

---

40. One effect that could be distributed asymmetrically is the licensing of parasitic gaps, under Nissenbaum’s (2000) theory of parasitic gap licensing, in which parasitic gaps require intermediate movement. An interesting question is whether are CP adjuncts that can also license parasitic gaps. One candidate may be *if*-clauses, which for some

## 7 Summary

This chapter has demonstrated that Dinka does not draw radical distinctions between final and intermediate movement steps in a successive-cyclic dependency. As I argued in Chapter 4, all instances of movement interact in the same way with V2, voice,  $\varphi$ -agreement, and case. As a result of this, intermediate movement satisfies the V2 property of the clause and the verb phrase along the way, allowing us to see clearly that both CP and  $v$ P constitute cyclic domains which require movement to their edge (Chomsky 1986 et seq.). These facts demonstrate that intermediate movement involves the same syntactic mechanisms as all other instances of phrasal movement, Agree and Merge (Chomsky 1995; McCloskey 2002; Abels 2012), and thus provide evidence for the featural view of phrasal movement defended in this dissertation.

---

speakers permit parasitic gaps (ia), and which can appear in the left periphery of the clause. Examples like (ib) may then suggest that parasitic gaps can be licensed by intermediate movement in the C domain also.

- (i) *Parasitic gaps in if-clauses:*
- a. This is the professor that Kim says that you must not say hello to \_\_\_ if you run into \_\_\_.
  - b. This is the professor that Kim says that, if you run into \_\_\_, \_\_\_ won't say hello to you.  
(modified from Engdahl 1983:11)



## CHAPTER SIX

### PRONOUN COPYING

---

This chapter turns to the third and last major topic of this dissertation, pronoun copying and the realization of copies. The main thesis of this dissertation is that all phrasal movement involves Agree and Merge. So far, I have primarily presented arguments that all phrasal movement requires Agree, and that differences between movement types derive from differences in the Agree relation. In this chapter, I offer an argument for the claim that all phrasal movement is established by Merge, and for the *Copy Theory of Movement* (Chomsky 1995 et seq.) as a model of phrasal movement. This argument is drawn from a pattern of pronoun copying at the edge of the Dinka verb phrase and the distribution of pronoun copying constructions across languages more generally. I show that the asymmetries and gaps in pronoun copying require that movement leaves copies with an articulated internal structure, which can undergo partial spell-out as pronouns.

#### 1 Introduction

It is well-known that languages may sometimes spell out multiple copies of a verb when the verb undergoes movement to the left periphery. Some examples from Hebrew, Nupe, and Russian are given in (1a–c).

- (1) *Verb copying in Hebrew, Russian, and Nupe:*
- a. **lirkod**, Gil lo **yirkod** ba-xayim.  
**dance.INF** Gil not **will-dance** in-the-life  
'As for dancing, Gil will never dance.'  
(Hebrew; Landau 2006:32)
  - b. **Citat'** Ivan eë **citaet**, no nicego ne ponimaet.  
**read.INF** Ivan 3FS.ACC **reads** but nothing not understands  
'Ivan DOES read it, but he doesn't understand a thing.'  
(Russian; Abels 2001:1)
  - c. **Bi-ba** Musa à **ba** nakàn sasi èsun làzi yin o  
**RED-cut** Musa FUT **cut** meat some tomorrow morning PRT FOC  
'It is CUTTING that Musa will do to some meat tomorrow morning.'  
(Nupe; Kandybowicz 2007:83)

These constructions are found in a wide variety of languages (for an overview, see Kandybowicz 2007:80, for example). As pointed out by a number of authors (e.g. Landau 2006; Kandybowicz

2007), the productivity of verb copying provides evidence that syntactic movement involves literal copies of the moved element.

We might wonder then why we do not similarly find widespread *noun* copying constructions for movement of DPs. After all, the syntax of phrasal movement provided most of the motivation for the Copy Theory of Movement in the first place (Chomsky 1995:ch. 3, sec. 3.5). There is one type of multiple copy spell-out, however, that is consistently found with movement of DPs. In a wide range of constructions, including resumption, *wh*-copying, clitic doubling, and subject doubling, pronouns appear to act as spell-outs of a full DP. For example, it has long been acknowledged that there is a type of resumptive pronoun whose behavior is indistinguishable from a gap (e.g. Zaenen et al. 1981; Engdahl 1982, 1985; Demirdache 1991; McCloskey 2006; Kandybowicz 2007; Sichel 2014; Harizanov 2014; cf. Asudeh 2012). *Wh*-copying constructions in German and Passamaquoddy have the profile of movement (e.g. Fanselow and Mahajan 2000; Felser 2004; Bruening 2006; Pankau 2013). Similarly, work on the syntax of clitic doubling languages like Greek and Bulgarian has come to the conclusion that doubled clitics act at LF like full copies rather than pronominals (e.g. Anagnostopoulou 2003; Harizanov 2014; cf. Cuervo 2003). In addition to this, a number of languages have constructions with multiple subject positions, in which the subject is doubled by a pronoun (e.g. Van Craenenbroeck and Van Koppen 2002; Holmberg and Nikanne 2008).

In this chapter, I argue on this basis that the counterpart to verb copying for phrasal movement of a DP is *pronoun copying*. To be precise, I defend the claim in (2), that a full copy of a DP like *the book* may, under certain conditions, be spelled out at PF as a pronoun (3).

(2) Multiple copy spell-out of a DP yields a pronoun.

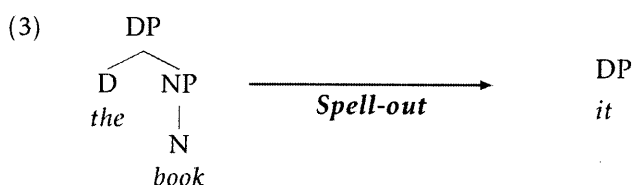

If (2) is correct, we expect to find at least three configurations in which multiple copy spell-out causes one copy in a movement chain to be realized as a pronoun. The pronoun could be the realization of a lower copy of the DP (4a), the pronoun could mark the highest position (4b), or a pronoun could spell out a copy in some intermediate position (4c).

(4) **Three configurations of pronoun spell-out:**

- a. Lowest copy: [ ... *the book* ... *it* ... ]
- b. Highest copy: [ ... *it* ... *the book* ... ]
- c. Intermediate copy: [ ... *the book* ... *it* ... <~~*the book*~~> ... ]

As pointed out above, previous work has suggested that (4a) and (4b) correspond to some cases of resumption and clitic doubling, respectively. In addition to this, a number of languages, including dialects of Dutch, Finnish, and Tunisian Arabic, have been argued to have constructions in which a

pronoun spells out a copy of the subject, either as the higher copy (4b) or as the lower copy (4a) (Van Craenenbroeck and Van Koppen 2002; Holmberg and Nikanne 2008; Jlassi 2013). *Wh*-copying has been put forward as a possible instantiation of either (4b) and (4c), since there are conflicting views about which copy the pronoun spells out (e.g. Fanselow and Mahajan 2000; Fanselow and Ćavar 2001; Felser 2004; Pankau 2013).

In this chapter, I present a novel instance of (4c), from Dinka. In Dinka, long-distance movement requires multiple spell-out of copies at the *vP* edge. Specifically, intermediate copies of plural nominals are always spelled out as the third person plural pronoun *ké(ek)* (5a–b), so that movement of such phrases effectively leaves a trail of copied pronouns.

(5) *Plural pronoun copying at Dinka verb phrase:*

- a. **Ké(ek)** áa-cíi Áyèn [<sub>vP</sub> **ké(ek)** t̩iŋ].  
 3PL 3P-PRF.OV Ayen.GEN 3PL see.NF  
 ‘Them, Ayen has seen.’
- b. Yè **kôc-kò** [<sub>CP</sub> y̩i Ból [<sub>vP</sub> **ké(ek)** luéel [<sub>CP</sub> è cíi Áyèn [<sub>vP</sub> **ké(ek)** be **people-which** be.OV Bol.GEN 3PL say.NF C PRF.OV Ayen.GEN 3PL t̩iŋ]]]]]?  
 see.NF  
 ‘Which people does Bol say Ayen has seen?’

I will argue that, in an example such as (5b), the pronoun *ké* is the spell-out of a full copy of the *wh*-phrase *kôc-kò* (‘which people’) in intermediate Spec-*vP* position. The motivation for this analysis comes from the observation that dependencies with *ké*-copying are indistinguishable from other movement dependencies in Dinka. In addition, copied instances of *ké* may appear where no lexical DP or pronoun may ever appear. Specifically, copied pronouns can violate the V2 property of the verb phrase, unlike non-copied nominals, but like other intermediate copies.

On the basis of these facts, I propose that all the configurations in (4a–c) are in fact attested. In this view, there is no asymmetry between movement of noun phrases and movement of verbs. For both, we can find a range of copying constructions.<sup>1</sup> The only difference lies in the form of the copied element. The question that arises then is why multiple copy spell-out should necessarily yield a pronoun. Particularly within the Copy Theory of Movement, this is unexpected, because it seems to suggest that DP copies are reduced in some form, possibly like traces (see, for example, Van Koppen 2005 for such a suggestion). I will show, however, that the correct analysis of pronoun copying nonetheless requires that DP copies have articulated internal structure.

As McCloskey (2006) observes, one way of viewing the claim that pronouns may realize gaps is as a consequence of two ideas. One influential view of pronouns is that they are the realization of a DP without an NP,<sup>2</sup> or the realization of the functional layer of a DP (e.g. Postal 1969; Elbourne

1. Although I do not know of an instance of verb copying like (4c), in which verbs mark an intermediate position. I leave open the issue of whether this is a real gap and, if so, what is responsible for it.  
 2. Or a DP with elision of the NP as in Elbourne’s (2001) treatment of E-type pronouns.

2001, 2005). In this theory of pronouns, a pronoun like *it* is effectively an intransitive version of the definite determiner *the*. In unrelated work, various authors working on the realization of copies have suggested that copies may undergo distributed or scattered deletion, so that subparts of some copies may be deleted if PF or LF considerations force it (e.g. Chomsky 1995; Bobaljik 2002; Landau 2006).

McCloskey points out that putting these two ideas together might yield resumptive pronouns that act like gaps. In particular, suppose that partial deletion removes the NP part of a copy. The structure that results from this would be a pronoun, if pronouns represent the functional layer of the DP (6a–b).

(6) ***Partial spell-out of a copy yields a pronoun:***

- a. [DP the ] → *it*
- b. [DP the [~~NP book~~] ] → *it*

I call this the *partial spell-out* view of pronoun copying. I will propose that this mechanism lies behind all of the instances of pronoun copying discussed above. The advantage of this approach is that it allows us to maintain a uniform view of copies left by movement: both movement of verbs and of DPs leaves full copies, but partial deletion applies to a DP copy for independent reasons.

One of the goals of this chapter is to argue for such a partial spell-out view, on the basis of matching asymmetries and gaps found in pronoun copying constructions across languages. For example, copied pronouns vary across languages in whether they display a *feature mismatch* when the antecedent is another pronoun. In Dinka, the copied pronoun is necessarily third person and only matches pronominals in number. As (7a–b) illustrate, 1st and 2nd person pronouns must be copied by the 3rd person plural pronoun instead of an identical pronoun.

(7) ***Copied pronouns in Dinka only match in number:***

- a. **Wôok** c̣ịi Bôl ḳêek/\*wôok ṭịịŋ.  
 1PL PRF.OV Bol.GEN 3PL/1PL see.NF  
 ‘Us, Bol has seen.’
- b. **Wêek** c̣ịi Bôl ḳêek/\*wêek ṭịịŋ.  
 2PL PRF.OV Bol.GEN 3PL/2PL see.NF  
 ‘You all, Bol has seen.’

Facts similar to those in (7a–b) are found in resumptive constructions in Nupe (Kandybowicz 2007), and in subject doubling in Finnish and Tunisian Arabic (Holmberg and Nikanne 2008; Jlassi 2013). At the same time, in other pronoun copying constructions, the copied pronoun matches pronouns fully, both in person and in number features, such as in Yoruba or Seereer (Adesola 2010; Baier 2014), as well as in clitic doubling constructions. The examples in (8a–b) illustrate for Yoruba, in which subject extraction is accompanied by pronoun copying.

(8) *Yoruba resumptive subjects match in  $\varphi$ -features:*

- a. Èmi ni [<sub>CP</sub> mo ra àpò].  
1SG be 1SG buy bag  
'I was the one who bought a bag.'
- b. Eyin ni [<sub>CP</sub> e ra àpò].  
2PL be 2PL buy bag  
'You are the people who bought a bag.'
- (Yoruba; Adesola 2010:82)

Languages vary then in whether copied pronouns match pronominal antecedents in number or in both person and number. Not only does this provide evidence that person and number may be encoded separately in the DP, I suggest that it is revealing of the mechanism behind pronoun copying. To be precise, I propose that we can understand this asymmetry if languages may vary with regards to whether person is introduced in the part of the DP that undergoes deletion. As a result, some languages delete person in pronoun copying, yielding pronouns that only match in number, and some do not, yielding fully matching pronoun copies instead.

In addition to this, evidence for partial spell-out comes from *gaps* in pronoun copying, or cases when some antecedents fail to trigger pronoun copying. For example, Van Craenenbroeck and Van Koppen (2002) observe that subject doubling in Brabant Dutch is only possible with pronouns (9a), and not with lexical DPs (9b).

(9) *Subject doubling only with pronominal subjects in Brabant Dutch:*

- a. Zij komt zij.  
she comes she  
'She will come.'
- b. \*Die vrou komt zij.  
that woman comes she  
'That woman will come.'
- (Brabant Dutch; Van Craenenbroeck and Van Koppen 2002:56)

I argue that these are instances when the structure deleted as a result of partial spell-out does not necessarily leave behind enough structure to create a pronoun. As a result, pronoun copying occurs only with a restricted set of antecedents.

In the broader context of this dissertation, this chapter functions as an additional argument for successive-cyclic derivations (Chomsky 1973 et seq.) and the idea that all instances of phrasal movement involve the same Merge operation (Chomsky 1995 et seq.). The perspective on pronoun copying that I will outline favors a movement analysis over other ways of modeling long-distance dependencies, such as feature percolation (e.g. Gazdar 1981; Bouma, Malouf, and Sag 2001; Neeleman and Van de Koot 2010), because it relies on the idea that movement involves copies with an articulated internal structure. My treatment of pronoun copying also provides evidence that

features like Case, person, and number, are hosted on separate projections in the nominal domain and offers insight into how these are organized relative to each other.

The chapter is organized as follows. Section 2 reviews previous work on cases of pronoun copying and argues that resumption, clitic doubling, subject doubling, and *wh*-copying all represent constructions in which pronouns realize more articulated DP copies. In section 3, I turn to the phenomenon of *ké*-copying in Dinka and show that this pattern comes about because an intermediate copy of successive-cyclic movement through *v*P is realized as a pronoun. Section 4 starts with the observation that pronoun copying in Dinka tolerates a person mismatch and goes on to show that this is a systematic point of variation across pronoun copying constructions. In section 5, I develop the partial spell-out view and demonstrate how it captures the key properties of Dinka pronoun copying. I generalize this model to all instances of pronoun copying, drawing on Landau's (2006) treatment of copy deletion, and present an account of both the person-number asymmetry as well as the presence of gaps in pronoun copying. Finally, I briefly discuss the issue of why no language appears to display multiple copy spell-out at the CP and *v*P edge simultaneously.

## 2 Resumption and argument doubling as pronoun copying

In this section, I argue that some instances of resumption, as well as clitic doubling, subject doubling, and *wh*-copying represent spell-out of a copy as a pronoun (e.g. Zaenen et al. 1981; Engdahl 1985; Harizanov 2014; Sichel 2014). From these patterns, I conclude that pronouns may act as realizations of both the lowest and the highest copy of a chain. I suggest that spell-out of the lowest copy is instantiated by some cases of resumption, while spell-out of the highest copy is found in clitic doubling, some instances of subject doubling, and *wh*-copying.

### 2.1 *Movement-derived instances of resumption*

It is well-known that there are resumptive constructions that pattern like movement dependencies (e.g. Zaenen et al. 1981; Koopman 1982, 1984; Sells 1984; Engdahl 1985). McCloskey (2006) and Asudeh (2012), for example, explicitly recognize a distinction between two types of resumptive pronouns: ones whose syntactic behavior is essentially that of a bound pronoun and those whose syntactic distribution is that of a gap or trace.<sup>3</sup>

A classic example of a language with the first type of resumptive structure is Irish (McCloskey 1979, 1990, 2002, 2006). Irish resumption can clearly be distinguished from movement, because it is insensitive to islands and fails movement diagnostics. The examples in (10a–c) demonstrate, for example, that Irish resumptive pronouns can occur inside islands. Resumptive pronouns can be used in a *wh*-island (10a), a relative clause island (10b), and an adjunct island (10c).

---

3. Asudeh refers to these as “syntactically active resumptives” and “syntactically inactive resumptives,” respectively.

(10) *Resumptive pronouns in Irish are not sensitive to islands:*

- a. **teach** nach n-aithneochthá [CP cá rabh se]  
**house** NEG.C recognize.COND where was **it**  
'a house that you wouldn't recognize where it was'
- b. **seanchasóg** ar dócha go bhfuil [DP an táilliúir [CP a dhein í]] sa chré  
**old-jacket** c probable c is the tailor c made **it** in-the earth  
fadó  
long-ago  
'an old jacket that the tailor who made it has probably been in the grave for ages'
- c. **Néree Caron**, nach bhfuil ann ach tamall beag [CP ó bhí sí dóigheamhail  
**Néree Caron** NEG.C is in-it but time small since was **she** beautiful  
feiceálach]  
attractive  
'Néree Caron, who it is only a short time since she was beautiful and attractive'  
(Irish; McCloskey 2006:99,100)

In addition, Irish resumption does not trigger Weak Crossover effects, unlike movement in the same environment (11a–b).

(11) *Irish resumption does not show WCO:*

- a. \***an fear**<sub>i</sub> a d'fhág a<sub>i</sub> bhean \_\_\_\_  
**the man** c left his wife  
'the man<sub>i</sub> that his<sub>i</sub> wife left'
- b. **an fear**<sub>i</sub> ar fhág a<sub>i</sub> bhean é  
**the man** c left his wife **him**  
'the man<sub>i</sub> that his<sub>i</sub> wife left'  
(Irish; McCloskey 1990:236,237)

However, not all resumptive pronouns can be sharply distinguished from movement in this way. Koopman (1982, 1984), for instance, observes that resumptive pronouns in Vata act like gaps. In Vata, movement of subjects must be accompanied by a resumptive in subject position, both when the local subject is extracted (12a–b), and with movement of an embedded subject (12c–d).

(12) *Vata subject extraction requires resumptive pronoun:*

- a. **àlól** ò lē sáká lá?  
**who he** eat rice WH  
'Who is eating rice?'
- b. \***àlól** \_\_\_\_ lē sáká lá?  
**who** eat rice WH  
'Who is eating rice?'

- c. àlɔ̀ ñ gùgù [CP nā ò yì] lá?  
**who** you think that **he** arrive WH  
 ‘Who do you think arrived?’
- d. \*àlɔ̀ ñ gùgù [CP nā \_\_\_ yì] lá?  
**who** you think that arrive WH  
 ‘Who do you think arrived?’  
 (Vata; Koopman 1982:128)

Unlike in Irish, resumption in Vata obeys islands. A Vata resumptive pronoun cannot be found in a Complex NP island (13a) or a *wh*-island (13b), for example.

(13) *Vata resumptives are island-sensitive:*

- a. \*àlɔ̀ ñ ni [DP zē mēmē gbù ò di-ḡḡ mé] yì lá?  
**who** you NEG-A reason it-it for **he** cut-REL it know WH  
 ‘Who don’t you know why he cut it?’
- b. \*àlɔ̀ ñ nylá nyini [CP nā ò di mé] lá?  
**who** you wonder that **he** cut it WH  
 ‘Who do you wonder whether he cut it?’  
 (Vata; Koopman and Sportiche 1986:369,370)

Vata resumptives also show Weak Crossover effects, so that a pronoun contained in the matrix subject in (14) cannot be bound by the resumed *wh*-phrase.

(14) *Vata resumption shows WCO:*

- \*àlɔ̀<sub>i</sub> ò<sub>i</sub> nɔ́ gùgù [CP nā ò mli] lá?  
**who** his mother think that **he** left WH  
 ‘Who did his mother think left?’  
 (Vata; Koopman and Sportiche 1982:143)

Similar facts have been noted for Swedish (Zaenen et al. 1981; Engdahl 1982, 1985). In Swedish, a resumptive pronoun is employed to rescue certain *that*-trace violations, as Engdahl (1982, 1985) shows. The example in (15) demonstrates.

(15) *Resumption in Swedish:*

- Vilket ord** visste ingen [CP hur **det** stavas]?  
**which word** knew no.one how **it** is.spelled  
 ‘Which word did no one know how it is spelled?’  
 (Swedish; Engdahl 1985:8)

As in Vata, these resumptives pattern like gaps. We can see this in a number of ways. First of all, resumption in Swedish is island-sensitive and cannot cross a relative clause island (16a).



In addition, resumption is able to license parasitic gaps (16b). Finally, Swedish ATB extraction may involve a TP with a resumptive pronoun in it coordinated with a TP containing a gap (16c), suggesting the two are alike.

(16) *Swedish resumptives pattern like gaps:*

- a. \***Vilken bil** åt du lunch med [<sub>DP</sub> någon [<sub>CP</sub> som körde **den**]]?  
**which car** ate you lunch with someone that drove **it**  
 ‘Which car did you have lunch with someone who drove it?’
- b. Det var **den fången** som läkarna inte kunde avgöra [<sub>CP</sub> om **han** verkligen var  
 this is **the prisoner** that the-doctors not could decide if **he** really was  
 sjuk] [<sub>CP</sub> utan att tala med \_\_\_ personligen].  
 ill without to talk with in person  
 ‘This is the prisoner that the doctors couldn’t determine if he was ill without talking  
 to \_\_\_ in person.’
- c. Det finns **vissa ord** som [<sub>TP</sub> jag ofta träffar på \_\_\_] men [<sub>TP</sub> inte minns  
 there are **certain words** that I often meet but not remember  
 hur **de** stavas]  
 how **they** are-spelled  
 ‘There are certain words that I often come across but never remember how they are  
 spelled.’  
 (Swedish; Engdahl 1985:7,8,10)

On the basis of these facts, a number of authors, including Koopman (1982, 1984), Zaenen et al. (1981), and Engdahl (1982, 1985), conclude that a resumptive pronoun may sometimes have the status of a phonetically realized trace.

Another reason why some instances of resumption have been analyzed as movement is that resumptive pronouns may show reconstruction effects. Work by Aoun et al. (2001) and Sichel (2014) on resumptive pronouns in Lebanese Arabic and Hebrew uses such facts to argue for a movement derivation of resumption. Aoun et al. (2001) are concerned with resumption of weak pronouns in Lebanese Arabic. At first glance, these resumptive pronouns seem to pattern like the Irish ones. They can occur inside a variety of islands, including adjunct islands (17a), *wh*-islands (17b), and Complex NP islands (17c).

(17) *Lebanese Arabic resumptive weak pronouns are island-insensitive:*

- a. **kəll muttahame** tfeəzaʔto [<sub>CP</sub> lamma ḥabasuw-a]  
**each suspect** surprised.2PL when imprisoned.3PL-**her**  
 ‘Each suspect, you were surprised when they imprisoned her.’
- b. **kəll muttahame** badkun taʔrfo [<sub>CP</sub> miin ḥabas-a]  
**each suspect** want.2PL know.2PL who imprisoned.3SM-**her**  
 ‘Each suspect, you want to know who imprisoned her.’

- c. **kəll muttahame** btaʕfo [DP l-muhaame [CP yalli rah ydeefiʕ ʕann-a]]  
**each suspect** know.2PL the-attorney that FUT defend.3SM of-her  
 ‘Each suspect, you know the attorney that will defend her.’  
 (Lebanese Arabic; Aoun et al. 2001:390,391)

However, Aoun et al. point out that these resumptive pronouns may nonetheless show the hallmarks of movement. In particular, resumption in Lebanese Arabic allows reconstruction for variable binding. In the examples in (18a–b), the antecedent DP *təlmiiz-a l-kəs-leen* (‘her bad student’) contains a pronoun which may be bound by a quantificational DP that only c-commands the resumptive pronoun.

(18) *Lebanese Arabic resumptives reconstruct for variable binding:*

- a. **təlmiiz-a<sub>i</sub> l-kəs-leen** ma baddna nʕabbir [DP wala mʕallme<sub>i</sub>] [CP ʔanno  
**student-her the-bad** NEG want.1PL tell.1PL no teacher that  
 l-mudiira ʃaħaʔət-o mn l-madrased  
 the-principal.SF expelled.3SF-him from the-school  
 ‘Her<sub>i</sub> bad student, we don’t want to tell any teacher<sub>i</sub> that the principal expelled him  
 from school.’
- b. **təlmiiz-a<sub>i</sub> l-kəs-leen** ma baddna nʕabbir [DP wala mʕallme<sub>i</sub>] [CP ʔanno  
**student-her the-bad** NEG want.1PL tell.1PL no teacher that  
 l-mudiir baddo yʔeebl-o baʕd l-frʕa]  
 the-principal.SF want.3SM meet.3SM-him after the break  
 ‘Her<sub>i</sub> bad student, we don’t want to tell any teacher<sub>i</sub> that the principal wants to meet  
 him after the break.’  
 (Lebanese Arabic; Aoun et al. 2001:392)

These facts are surprising if the resumptive pronoun is just a pronoun, but we can make sense of them if the pronoun spells out a lower copy, containing the bound pronoun also. That these reconstruction effects are indeed achieved by movement is supported by the observation that reconstruction becomes impossible when the resumptive pronoun is located inside of an island, as the examples in (19a–b) illustrate for a *wh*-island and an adjunct island, respectively.

(19) *Lebanese Arabic resumptives do not reconstruct into islands:*

- a. \***təlmiiz-a<sub>i</sub> l-kəs-leen** ma badda taʕrif [DP wala mʕallme<sub>i</sub>] [CP lee  
**student-her the-bad** NEG want.3SF know.3SF no teacher why  
 l-mudiira ʃaħaʔət-o mn l-madrased  
 the-principal expelled.3SF-him from the-school  
 ‘Her<sub>i</sub> bad student, no teacher<sub>i</sub> wants to know why the principal expelled him from  
 school.’

- b. \***təlmiiz-a<sub>i</sub>** **l-kəs-leen** ma zəʕlit [DP wala mʕallme<sub>i</sub>] [CP laʔanno l-mudiira  
**student-her the-bad** NEG upset.3SF no teacher because the-principal  
 ʃaħatət-o mn l-madrased  
 expelled.3SF-him from the-school  
 ‘Her<sub>i</sub> bad student, no teacher<sub>i</sub> was upset because the principal expelled him from  
 school.’  
 (Lebanese Arabic; Aoun et al. 2001:393)

McCloskey (2006) and Asudeh (2012) note that this pattern suggests that Lebanese Arabic allows both types of resumption discussed above. In this view, reconstruction effects are obtained by a movement derivation in which the resumptive pronoun spells out a lower copy of the antecedent DP. Island-insensitivity instead comes from a base-generated structure in which the resumptive is a true pronoun, bound from outside the island by the antecedent DP.

Similar conclusions are argued for in Sichel’s (2014) discussion of resumptive pronouns in Hebrew. Sichel observes that obligatory resumptive pronouns in Hebrew allow reconstruction for a variety of effects, including anaphor binding (20a), idiom interpretation (20b), and variable binding (20c).<sup>4</sup>

(20) *Reconstruction of obligatory resumptives in Hebrew:*

- a. **ha-šmu’a al acmo<sub>i</sub>** [CP še-dani<sub>i</sub> xašaš mimena] hufca al yedey rani.  
**the-rumor about himself** c-dani feared from.it was.spread by Rani  
 ‘The rumour about himself<sub>i</sub> that Dani<sub>i</sub> feared was spread by Rani.’
- b. **ha-ec** [CP še-hu tipes alav]  
**the-tree** that-he climbed on.it  
 ‘the high position that he took’
- c. **ha-šmu’a al acmo<sub>i</sub>** [CP še-[DP kol more<sub>i</sub>] xašaš mimena] hufca  
**the-rumor about himself** that- every teacher feared of.it was.spread  
 al yedey ha-axot.  
 by the-nurse  
 ‘The rumor about himself<sub>i</sub> that every teacher<sub>i</sub> feared was spread by the nurse.’  
 (Hebrew; Sichel 2014:661)

As Sichel argues, this provides evidence that some resumptive pronouns in fact mask the presence of a more articulated copy of the antecedent DP.

I conclude then that there is a type of movement-derived resumption that has the structure in (21). What resumption teaches us then is pronouns may under certain conditions realize the lowest copy in an  $\bar{A}$ -movement chain (Zaenen et al. 1981; Koopman 1982, 1984; Engdahl 1982, 1985; Sells

4. Much of the discussion in Sichel 2014 centers on the observation that *optional* resumptive pronouns show a different pattern of behavior: they do not tolerate reconstruction. See Sichel 2014 for reasons why competition between derivations may yield this result.

1984; McCloskey 2006; Sichel 2014; see also Salzmann 2006 on Swiss German and Kandybowicz 2007 on Nupe).

(21) *Representation of movement-derived resumption:*

[ ... *the book* ... (<~~the book~~>) ... *it* ... ]

One question that arises is what precisely drives multiple copy spell-out in the various constructions discussed here. It seems clear that various factors are at play. In Vata and Swedish, as well as Nupe or Yoruba, resumptive pronouns are inserted to remedy *that*-trace violations. In Swiss German, Salzmann (2006) shows that resumptives serve to realize oblique case morphology. The need to express case has also been held responsible for movement-like resumption in Slavic (e.g. Pesetsky 1998; Gračanin-Yuksek 2010; Hladnik 2015). In Hebrew, movement-derived resumptives are also clitics (Sichel 2014:665), suggesting that multiple copy spell-out may be driven by the need of some functional heads to host a clitic. What they all have in common is the repair: spelling out a copy as a pronoun.

2.2 *Clitic doubling, subject doubling, and wh-copying*

In this section, I discuss a variety of constructions in which a pronoun acts like a copy of a DP it c-commands. I first examine clitic doubling, which a number of authors have shown behaves like an A-movement chain (e.g. Anagnostopoulou 2003; Harizanov 2014). I also discuss patterns of subject doubling in Finnish (Holmberg and Nikanne 2008), which I compare to subject doubling in dialects of Dutch (e.g. Van Craenenbroeck and Van Koppen 2002; Holmberg and Nikanne 2008). Finally, I examine *wh*-copying, which has also been claimed to instantiate this configuration (e.g. Fanselow and Mahajan 2000; Fanselow and Ćavar 2001; Felser 2004; Bruening 2006).

In work on clitic doubling in Greek, Alexiadou and Anagnostopoulou (1997, 2000) show that clitic doubling has an effect on binding relations that is unexpected if clitics are just pronouns. A systematic property of clitic doubling, for example, is that it alleviates Weak Crossover. In Greek, as in many languages, subjects can bind into objects, but objects cannot bind into a subject (22a–b).

(22) *Greek objects cannot bind into subjects:*

- a. [<sub>DP</sub> **Kathe mitera**<sub>i</sub>] *sinodhapse* [<sub>DP</sub> *to* **pehdi tis**<sub>i</sub>].  
       **every mother** accompanied    the child **hers**  
       ‘Every mother<sub>i</sub> accompanied her<sub>i</sub> child.’
- b. \*<sub>[DP</sub> I **mitera tu**<sub>i</sub>] *sinodhapse* [<sub>DP</sub> **to** **kathe pedhi**<sub>i</sub>].  
       the mother **his** accompanied    **the every child**  
       ‘His<sub>i</sub> mother accompanied every child<sub>i</sub>.’  
       (Greek; Anagnostopoulou 2003:207)

However, Alexiadou and Anagnostopoulou observe that clitic doubling of the object allows the object to bind into the subject. When an accusative clitic doubles the object (otherwise an optional operation), both binding configurations in (22a–b) are permitted (23a–b).

(23) *Clitic doubling allows an object to bind into a subject:*

- a. [DP Kathe mitera<sub>i</sub>] **to** sinodhese [DP to pehdi tis<sub>i</sub>].  
 every mother 3MS.ACC accompanied the child hers  
 ‘Every mother<sub>i</sub> accompanied her<sub>i</sub> child.’
- b. [DP I mitera tu<sub>i</sub>] **to** sinodhese [DP to kathe pedhi<sub>i</sub>].  
 the mother his 3MS.ACC accompanied the every child  
 ‘His<sub>i</sub> mother accompanied every child<sub>i</sub>.’  
 (Greek; Anagnostopoulou 2003:207)

As Alexiadou and Anagnostopoulou point out, we can make sense of these facts if doubling clitics act as full copies of their associate. If subjects are first merged in a position below the position targeted by the clitic, then the c-command relation between the clitic position and the base position of the subject is sufficient for a binding relation to be possible. If a clitic is just a pronoun, it is not so clear why it should extend the binding domain of its associate.

Harizanov (2014) documents similar data in Bulgarian and also argues that clitic doubling results from A-movement with conversion of the top copy to a clitic. In Bulgarian, both accusative and dative objects may be clitic-doubled (24a–b).

(24) *Bulgarian allows clitic doubling of direct and indirect objects:*

- a. Decata **ja** obiçat **neja**.  
 the.kids 3FS.ACC love her  
 ‘The kids love her.’
- b. Marija **mu** izprati pismo **na rabotnika**.  
 Maria 3MS.DAT sent letter to the.worker  
 ‘Maria sent a letter to the worker.’  
 (Bulgarian; Harizanov 2014:1036)

Harizanov demonstrates that Bulgarian doubling clitics, as in Greek, act like full copies of the associate they double. Bulgarian ditransitives permit both a ACC-DAT and a DAT-ACC order (25a–b). In both orders, the first object can bind into the second one (25a–b), but the second object cannot bind into the first one (25c–d).

(25) *First object of a ditransitive can bind into second one:*

- a. Petår vårna **vsjaka kola**<sub>i</sub> [PP na sobstvenika **i**<sub>i</sub>] vçera.  
 Peter returned every car to the.owner its yesterday  
 ‘Peter returned every car to its owner yesterday.’

- b. Ivan izprati **na vsjaka žena<sub>i</sub>** [<sub>DP</sub> **nejnija<sub>i</sub>** ček] včera.  
 Ivan sent **to every woman her** check yesterday  
 ‘Ivan sent every woman her check yesterday.’
- c. \*Petăr vărna [<sub>PP</sub> na sobstvenika **i<sub>i</sub>**] **vsjaka kola<sub>i</sub>** včera.  
 Peter returned to the.owner **its every car** yesterday  
 ‘Peter returned every car<sub>i</sub> to its<sub>i</sub> owner yesterday.’
- d. \*Ivan izprati [<sub>DP</sub> **nejnija<sub>i</sub>** ček] **na vsjaka žena<sub>i</sub>** včera.  
 Ivan sent **her** check **to every woman** yesterday  
 ‘Ivan sent every woman her check yesterday.’  
 (Bulgarian; Harizanov 2014:1054)

As Harizanov observes, however, clitic doubling of the lower object allows it to bind into the higher one. In (26a), clitic doubling of the direct object allows it to bind into the indirect object (compare 25c). In (26b), clitic doubling of the indirect object lets it bind a pronoun in the direct object (compare 25d).

(26) *Variable binding is possible from the clitic site in Bulgarian:*

- a. Petăr **ja** vărna [<sub>PP</sub> na sobstvenika **i<sub>i</sub>**] vsjaka kola<sub>i</sub> včera.  
 Peter **3FS.ACC** returned to the.owner its every car yesterday  
 ‘Peter returned every car<sub>i</sub> to its<sub>i</sub> owner yesterday.’
- b. Ivan **i** izprati [<sub>DP</sub> **nejnija<sub>i</sub>** ček] na vsjaka žena<sub>i</sub> včera.  
 Ivan **3FS.DAT** sent her check to every woman yesterday  
 ‘Ivan sent every woman her check yesterday.’  
 (Bulgarian; Harizanov 2014:1055)

This suggests that the doubled clitic is actually a full copy of the associate in an A-movement chain, because then the quantifiers in (26a–b) simply c-command the higher object from the position of the clitic.<sup>5</sup>

Cuervo (2003) describes similar facts in Spanish. In Spanish ditransitives, the dative indirect object always follows the accusative direct object. In addition, the indirect object may optionally be clitic-doubled. Only when it is clitic-doubled may the dative bind into the accusative (27a–b).<sup>6</sup>

(27) *Variable binding is possible from the clitic site in Spanish:*

- a. \*Valeria presentó [<sub>DP</sub> **su<sub>i</sub>** respectivo paciente] **a cada cirujano<sub>i</sub>**.  
 Valeria introduced **his** respective patient **to each surgeon**  
 ‘Valeria introduced his<sub>i</sub> respective patient to each surgeon<sub>i</sub>.’

5. See Harizanov 2014 for additional arguments that the relation between the clitic and the associate is one of A-movement.

6. Cuervo (2003) analyzes this as a dative alternation, in which the clitic is the spell-out of an agreeing Appl head. A disadvantage of this account, however, is that it has to posit an obligatory leftward movement step for the direct object in examples like (27b), which necessarily reconstructs. It is not clear what would motivate this.

- b. ?Valeria **le** presentó [<sub>DP</sub> su<sub>i</sub> respectivo paciente] a cada cirujano<sub>i</sub>.  
 Valeria **3MS.DAT** introduced his respective patient to each surgeon  
 ‘Valeria introduced his<sub>i</sub> respective patient to each surgeon<sub>i</sub>.’  
 (Spanish; Cuervo 2003:131)

See Cuervo 2003 for similar contrasts relating to other c-command diagnostics, such as anaphor binding and scope.<sup>7</sup>

On the basis of these facts, I adopt the view that clitic doubling is A-movement with spell-out of the highest copy as a clitic (Anagnostopoulou 2003; Harizanov 2014; cf. Sportiche 1996). In Harizanov’s proposal, this is achieved by the obligatory application of morphological merger (Marantz 1988), which converts the label of a full copy into a clitic. I will develop a different approach to pronoun copying, based on the asymmetries and gaps I discuss in section 4, but my account will preserve the intuition that, in constructions like clitic doubling, it is the desire of a functional head to merge with a clitic that drives clitic doubling.

Pronominal spell-out of the highest copy is not limited to clitics. Another construction that can involve this configuration is subject doubling. In a number of languages, subjects may be doubled by a pronoun, with a variety of information-structural consequences (e.g. Van Craenenbroeck and Van Koppen 2002; Poletto 2008; Vangsnes 2008; see Barbiers 2008:10–11). In colloquial Finnish (Holmberg and Nikanne 2008), subject doubling involves a clause-initial pronoun and a low subject, as in the examples in (28a–b).

(28) *Initial pronoun may double subject in Finnish:*

- a. **Se** on **Jari** lopettanut tupakoinnin.  
 3SG has **Jari** quit smoking  
 ‘Jari has quit smoking.’
- b. **Ne** sai **kaikki lapset** samat oireet.  
 3PL got **all children** same symptoms  
 ‘All the children got the same symptoms.’
- c. **Me** ollaan **me-kin** lopettanut tupakoinnin.  
 1PL are-1PL **1PL-too** quit smoking  
 ‘We have quit smoking, too.’  
 (Finnish; Holmberg and Nikanne 2008:326)

Holmberg and Nikanne note that this doubling “is typically used to express an all-new sentence about a familiar subject” (325). The doubled pronoun occupies a left-peripheral position that must

7. Cuervo’s main reason for analyzing (27a–b) as a dative alternation is that clitic doubling of the dative makes binding from the accusative into the dative degraded. See Harizanov 2014 for discussion of similar facts in Bulgarian and how an A-movement account of clitic doubling handles these contrasts.

be occupied by an overt XP in Finnish (Holmberg and Nikanne 2002, 2008). The pronoun has exactly the distribution of other phrasal constituents in Finnish and so is unlikely to be a clitic.<sup>8</sup>

It is harder to use diagnostics from binding or reconstruction to argue that these constructions too involve spell-out of a full copy.<sup>9</sup> However, the fact that these pronouns are phrasal and do not trigger Principle C effects is already an indication that these are not ordinary pronouns. In addition, Holmberg and Nikanne show that doubling pronouns have access to the features of the lower subject. Finnish has a number of quirky cases for subjects, including the adessive and the genitive. When a doubling pronoun is used with such a subject, it may match it in case (29a–b).

(29) *Finnish subject doubling shows case matching:*

- a. **Niilä** on **kaikilla lapsilla** samat oireet.  
**3PL.ADE** has **all-ADE** **children-ADE** same symptoms  
 ‘All the children have the same symptoms.’
- b. **Se-n** pitäisi **Marja-n** lopettaa tupakointi.  
**3SG-GEN** should **Marja-GEN** quit smoking  
 ‘Marja should quit smoking.’  
 (Holmberg and Nikanne 2008:330)

This makes sense if the pronoun is the realization of a copy of the subject, because then it would have access to the same Case features that the subject does. Following Holmberg and Nikanne, I take these constructions to involve pronominal spell-out of a copy, like clitic doubling, but targeting a subject occupying multiple subject positions.<sup>10</sup>

A third construction that may involve top copy spell-out as a pronoun is *wh*-copying. It is well-known that, in a number of languages, *wh*-movement can be accompanied by *wh*-copying, so that a copy of the *wh*-phrase appears in all Spec-CP positions on the path of movement. Such constructions are found in German, Frisian, and Passamaquoddy, for example (30a–b).

(30) *Examples of wh-copying:*

- a. **Wen** glaubst du [<sub>CP</sub> **wen** sie getroffen hat]?  
**who** believe you **who** she met has  
 ‘Who do you believe she has met?’  
 (German; Felser 2004)

8. Holmberg and Nikanne (2002) show that Finnish has two left-peripheral phrasal positions, Spec-FP and Spec-CP. Spec-FP is always occupied, either by the subject, an expletive, a doubling pronoun, or a topicalized constituent. The constituent in Spec-FP may be preceded by an XP in Spec-CP, such as a *wh*-phrase. Doubling pronouns obey these generalizations exactly. In fact, Finnish even allows subject trebling, in which a doubling pronoun also appears in Spec-CP (though this is impossible if another XP appears in Spec-CP).

9. Although we might expect to find a similar facilitation effect for variable binding into intervening adverbials.

10. This pattern is only found with subjects, although a variety of elements can move to clause-initial positions (Holmberg and Nikanne 2002). This is presumably because both the clause-initial position and the lower subject position must be overtly occupied. As a result, multiple copy spell-out is only necessary when the subject is in both positions.



- b. **Wêr** tinke jo [<sub>CP</sub> **wêr't** Jan wennet]?  
**where** think you **where-c** Jan lives  
 'Where do you think that Jan lives?'  
 (Frisian; Hiemstra 1986:99)
- c. **Tayuwe** kt-itom-ups [<sub>CP</sub> **tayuwe** apc kt-ol-i malsanikuwam-ok]?  
**when** 2-say-DUB **when** again 2-thus-go store-LOC  
 'When did you say you're going to go to the store?'  
 (Passamaquoddy; Bruening 2006:26)

Following Fanselow and Mahajan (2000), Fanselow and Ćavar (2001), Felser (2004), and Bruening (2006), I take such constructions to be derived by long-distance *wh*-movement, with pronunciation of multiple copies.<sup>11</sup> In accordance with this, the *wh*-phrases typically match in form, as shown for German in (31a–b) and Passamaquoddy in (31c–d).

(31) *Copied wh-phrases match:*

- a. **Warum** glaubst du [<sub>CP</sub> **warum** sie das getan hat]?  
**why** believe you **why** she that done has  
 'Why do you believe she has done this?'
- b. **Wovon** glaubst du [<sub>CP</sub> **wovon** sie träumt]?  
**of.what** believe you **of.what** she dreams  
 'What do you believe that she dreams of?'
- c. %**An wen** glaubst du [<sub>CP</sub> **an wen** sie denkt]?  
**of whom** believe you **of whom** she thinks  
 'Who do you believe that she thinks of?'  
 (German; Felser 2004)
- d. **Wen** Mali wewitaham-a-c-il [<sub>CP</sub> **wen** kisi-niskam-uk]?  
**who** Mary (3)-remember-DIR-3CONJ-POBV **who** PERF-dance.with-1CONJ  
 'Who does Mary remember that I danced with?'
- e. **Wen-il** Mali wewitaham-a-c-il [<sub>CP</sub> **wen-il** kisi-niskam-uk]?  
**who-obv** Mary (3)-remember-DIR-3CONJ-POBV **who-obv** PERF-dance.with-1CONJ  
 'Who does Mary remember I danced with?'  
 (Passamaquoddy; Bruening 2006:36,38)

The most productive *wh*-copying pattern involves only pronominal *wh*-phrases, though sometimes copying of a preposition is tolerated (31c) (Fanselow and Ćavar 2001; Felser 2004). As a result, the data shown so far is ambiguous as to which copy is the result of multiple copy spell-out. There are cases, however, in which one of the the *wh*-phrases can be complex, though there is some

11. As Felser (2004) and Bruening (2006) show, *wh*-copying of the kind discussed here should be distinguished from what is sometimes called *partial wh-copying*. Partial *wh*-copying typically involves an invariant *wh*-word in the matrix phrase, like *was* ('what') in German and *keq* ('what') in Passamaquoddy. Following these authors, I take partial *wh*-copying to reflect an indirect dependency, as in Dayal 1994.

disagreement about which copy can be the complex one. All authors agree that it is not admissible for both *wh*-phrases to be complex (32a–b).

(32) *Both wh-phrases cannot be complex:*

- a. \***Wessen Studenten** denkst du [<sub>CP</sub> **wessen Studenten** wir kennen]?  
**whose students** think you **whose students** we know  
 ‘Whose students do you think that we know?’
- b. \***Wieviel Studenten** denkst du [<sub>CP</sub> **wieviel Studenten** wir kennen]?  
**how.many students** think you **how.many students** we know  
 ‘How many students do you think that we know?’  
 (German; Fanselow and Ćavar 2001)

Fanselow and Ćavar (2001) offer several examples in which the lower *wh*-phrase is complex (33a–b), and Bruening (2006) suggests that the same is possible in Passamaquoddy.

(33) *Lower wh-phrase may be complex:*

- a. **Wen** denkst du [<sub>CP</sub> **wen von den Studenten** man einladen sollte]?  
**who** think you **who of the students** one invite should  
 ‘Which of the students do you think that one should invite?’
- b. **Wieviel** sagst du [<sub>CP</sub> **wieviel Schweine** ihr habt]?  
**how.many** say you **how.many pigs** you have  
 ‘How many pigs do you say that you have?’  
 (German; Fanselow and Ćavar 2001)

If this is correct, then *wh*-copying can also be thought of as the realization of a higher copy in a movement dependency as a pronoun, in this case as a *wh*-pronominal. Pankau (2013) argues instead, however, that it is actually only the higher *wh*-phrase that may be complex (I will discuss some examples like this shortly) and suggests that German examples like (33a–b) involve subextraction out of a scrambled DP in the lower clause.<sup>12</sup> However, Koster (2009) and Boef (2013) cite similar examples for *wh*-copying speakers of Dutch, which does not allow scrambling over the subject of the relevant type (34).

(34) *Complex lower wh-phrase in Dutch wh-copying:*

- a. **Hóeveel** zeg je [<sub>CP</sub> **hoeveel varkens** je gezien hebt]?  
**how.many** say you **how.many pigs** you seen have  
 ‘How many pigs are you saying that you have seen?’  
 (Dutch; Koster 2009:11)

12. In other words, an example like (33b) would have a structure like [<sub>CP</sub> *wieviel*<sub>i</sub> ... [<sub>CP</sub> *wieviel*<sub>i</sub> ... [<sub>DP</sub> *t*<sub>i</sub> *Schweine*] ... ]].

- b. **Wie** denk je [<sub>CP</sub> **welke man** ik gisteren gezien heb]?  
**who** think you **which man** I yesterday seen have  
 ‘Which man do you think I saw yesterday?’  
 (Dutch; Boef 2013:34)

It seems likely then that at least some instances of *wh*-copying do involve a higher *wh*-pronominal doubling a lower complex *wh*-phrase. I will assume from now on that this is true at least for some *wh*-copying cases, though it is worth noting that nothing hinges on this for the purposes of the overall conclusions defended here.

In this section so far, I have discussed three different constructions, clitic doubling, subject doubling, and *wh*-copying, that can all be thought of instances of movement in which the highest copy is spelled out as a pronoun. Schematically, the movement chains discussed here all have the representation in (35).

- (35) **Representation of clitic doubling, subject doubling, and *wh*-copying:**  
 [ ... *it* ... (<~~the book~~>) ... *the book* ... ]

All of these constructions involve a pronoun spelling out a higher copy, sometimes with deleted intermediate copies (this is plausibly the case in *wh*-copying, if we assume intermediate copies at the *vP* edge). As in the previous section, various factors appear to be responsible for multiple copy spell-out. In instances of clitic doubling, a copy is realized as a pronoun in order for a functional head to host a clitic. In subject doubling, what appears to be responsible for multiple copy spell-out is the requirement that some functional heads have an overt specifier. Doubling pronouns in Finnish, for instance, occupy a position that must generally contain an overt XP. Similar pressure may be at work in *wh*-copying, though an alternative could be to think of *wh*-copying as reflecting a need to realize *wh*-morphology in intermediate C positions.

I have argued so far that pronouns may realize both the top and the bottom copy in a movement chain. We might wonder at this point to what extent these options are symmetrical. Although it should be clear that A- and  $\bar{A}$ -movement chains can both involve pronoun copying (for example, clitic doubling and resumption), not all possible configurations of pronoun copying are attested. For instance, there is no true counterpart to movement-derived resumption that looks like (35) (in which the full DP appears in the base position and the pronoun in the highest position). Similarly, we could wonder whether there is a variant of clitic doubling in which the lowest copy is the clitic.<sup>13</sup> On the other hand, some of the other copying configurations I describe here do display symmetry. Anyadi and Tamrazian (1993) observe, for instance, that there are speakers of German who, in *wh*-copying constructions, allow for the higher *wh*-phrase to be the complex one (36a–b).

13. Clitic doubling of subjects seems to represent this configuration (for example, subject clitics in Fiorentino and Trentino, as in Brandi and Cordin 1989), though I do not know of an analogous case with objects.

(36) *Some German speakers allow for highest wh-phrase to be complex:*

- a. **Welchem Mann** glaubst du [<sub>CP</sub> **wem** sie das Buch gegeben hat]?  
**which.DAT man** believe you **who.DAT** she the book given has  
'Which man do you think that she has given the book to?'
- b. **Mit welchem Werkzeug** glaubst du [<sub>CP</sub> **womit** Ede das Auto repariert hat]?  
**with which.DAT tool** think you **what-with** Ede the car repaired has  
'With which tool do you think that Ede has repaired the car?'
- (German; Anyadi and Tamrazian 1993:4)

A wide range of such examples are found in Pankau 2013 as well, who claims that these configurations are productive for a range of speakers.

We can also find subject doubling languages in which the doubling pronoun occupies the lower subject position. Van Craenenbroeck and Van Koppen (2002) describe such a pattern in Wambeek Dutch. In Wambeek Dutch, a subject topic is accompanied by a doubling pronoun in a lower subject position, as the examples in (37a–b) attest.<sup>14</sup> This pattern is restricted to matrix clauses in which no other XP appears in Spec-CP.

(37) *Subject doubling in Wambeek Dutch:*

- a. **Dei vrou** gui zij nuir oish.  
**that woman** go **she** to home  
'That woman is going home.'
- b. **Alle manne** meege **zaailn** ie binn.  
**all men** may **they** here inside  
'All men come in.'
- (Wambeek Dutch; Van Craenenbroeck and Van Koppen 2002:56,64)

We can view this as the mirror image of the Finnish facts described by Holmberg and Nikanne (2008). In both cases, there are two subject positions (Spec-TP and a higher Spec position) and, in one, the DP is realized as a pronoun.

The symmetry evident in these constructions as well as the wide range of examples in which a pronoun appears to act as a copy of a lexical DP suggests that pronoun copying should not be viewed as marginal or restricted to a particular syntactic context. Rather, the picture that emerges is one in which spelling out a copy as a pronoun is a legitimate option in many languages to solve syntactic problems created by the need for a head to attract a clitic or to have an overt specifier. In accordance with this, any complete theory of phrasal movement and how it treats copies should be able to accommodate these patterns.

In the next section, I present more evidence for the view that pronouns may realize DP copies, drawn from a pattern of pronoun copying in Dinka. In addition, we will see that, like the German facts in (36a–b), this pattern involves pronominal spell-out of *intermediate* copies, rather than

---

14. See also Jlassi 2013 for a pattern of subject doubling in Tunisian Arabic.

the highest or lowest copy. This will provide further support for my claim that pronouns may in principle realize any of the copies that make up a movement chain, and that all types of phrasal movement are established by the same mechanisms.

### 3 Pronoun copying in Dinka

This section argues that pronouns may also realize copies in intermediate positions, based on a pronoun copying pattern at the edge of the Dinka verb phrase. In Dinka, long-distance movement of a plural noun phrase is always accompanied by the appearance of the 3rd person plural pronoun *ké(ek)* at the edge of each verb phrase on the path of movement, a process I refer to as *ké-copying*. In this section, I discuss the properties of this phenomenon and present evidence that it results from the spell-out of an intermediate copy.

#### 3.1 *Ké-copying*

As noted in the previous chapter, movement of a plural nominal in Dinka triggers the appearance of the 3rd person plural pronoun *ké(ek)* at the edge of the *vP*. This happens with all instances of long-distance movement, regardless of whether it is topicalization, as in (38a), or relativization, as in (38b–c).

(38) *Movement of plural nominal triggers pronoun copying:*

- a. **Kèek** áa-cíi Áyèn [<sub>vP</sub> **ké** t̩iŋ].  
 3PL 3P-PRF.OV Ayen.GEN 3PL see.NF  
 ‘Them, Ayen has seen.’
- b. Bòl à-cẹ̀ **ròoor** [<sub>CP</sub> cẹ̀ [<sub>vP</sub> **ké** làat]] t̩iŋ.  
 Bol 3S-PRF.SV **men** PRF.3SG 3PL insult.NF see.NF  
 ‘Bol has seen the men he has insulted.’
- c. Yè **kôoc-kò** [<sub>CP</sub> cíi Bòl [<sub>vP</sub> **ké** t̩iŋ]]?  
 be **people-which** PRF.OV Bol.GEN 3PL see.NF  
 ‘Which people has Bol seen?’

This effect displays a number asymmetry, because it is limited to plural nominals. Movement of a singular noun is not accompanied by a copied pronoun in the same position (39a). In fact, adding a singular pronoun at the *vP* edge just leads to ungrammaticality (39b).<sup>15</sup>

(39) *No pronoun copying with movement of a singular noun:*

- a. Yè **ŋà** [<sub>CP</sub> cíi Bòl [<sub>vP</sub> t̩iŋ]]?  
 be **who** PRF.OV Bol.GEN see.NF  
 ‘Who has Bol seen?’

15. This pattern cares about whether the noun is formally plural. Coordinated DPs, for example, participate in *ké-copying*.

- b. \*Yè ɲà [CP cii Ból [vP yé(en) tii]]?  
 be **who** PRF.OV BOL.GEN 3SG see.NF  
 ‘Who has Bol seen?’

This kind of pronoun copying is not restricted to the local *vP*, but happens successively in cases of long-distance extraction. A copied 3rd person plural pronoun appears at every *vP* edge on the path of movement, as the examples in (40a–b) demonstrate.

(40) *Ké-copying targets each verb phrase edge:*

- a. Yè ɲà [CP yii Ból [vP luéel [CP è cii Áyèn [vP tii]]]]?  
 be **who** HAB.OV BOL.GEN say.NF C PRF.OV AyeN.GEN see.NF  
 ‘Who does Bol say Ayen has seen?’
- b. Yè kôc-kò [CP yii Ból [vP ké luéel [CP è cii Áyèn [vP ké  
 be **people-which** HAB.OV BOL.GEN 3PL say.NF C PRF.OV AyeN.GEN 3PL  
 tii]]]]?  
 see.NF  
 ‘Which people does Bol say Ayen has seen?’

In addition, pronoun copying is obligatory, so that omitting either instance of *ké(ek)* in an example like (40b) is ungrammatical (41a–c).<sup>16</sup>

(41) *Omitting ké(ek) is ungrammatical:*

- a. \*Yè kôc-kò [CP yii Ból [vP luéel [CP è cii Áyèn [vP ké  
 be **people-which** HAB.OV BOL.GEN say.NF C PRF.OV AyeN.GEN 3PL  
 tii]]]]?  
 see.NF  
 ‘Which people does Bol say Ayen has seen?’
- b. \*Yè kôc-kò [CP yii Ból [vP ké luéel [CP è cii Áyèn [vP  
 be **people-which** HAB.OV BOL.GEN 3PL say.NF C PRF.OV AyeN.GEN  
 tii]]]]?  
 see.NF  
 ‘Which people does Bol say Ayen has seen?’
- c. \*Yè kôc-kò [CP yii Ból [vP luéel [CP è cii Áyèn [vP tii]]]]?  
 be **people-which** HAB.OV BOL.GEN say.NF C PRF.OV AyeN.GEN see.NF  
 ‘Which people does Bol say Ayen has seen?’

I refer to this phenomenon as *ké-copying* and I will argue that it reflects the realization of intermediate copies left by successive-cyclic movement. This is thus a pronoun copying configuration, just

16. There appears to be some variation between speakers in this regard, since *ké-copying* has been described as optional for some (see Andersen 1991:276–277).

like the constructions discussed in section 2. The rest of this section motivates the different aspects of this analysis, starting with the proposal that *ké*-copying involves copying of a pronoun.

### 3.2 Copied *ké* is a pronoun

Like all Dinka pronouns, the third person pronoun has a full version (*kêek*) and a phonologically reduced form (*ké*), with a short vowel and no coda consonant (42a–b).

(42) *Pronouns have full and reduced forms:*

- a. Ròòor áa-cé ké t̩iŋ.  
men 3P-PRF.SV 3PL see.NF  
'The men have seen them.'
- b. Ròòor áa-cé kêek t̩iŋ.  
men 3P-PRF.SV 3PL see.NF  
'The men have seen them.'

Although the full form may convey emphasis, these pronouns can be used interchangeably in most instances. Both can be coordinated, for instance (43a–b) (cf. Cardinaletti and Starke 1999; Déchaine and Wiltschko 2002).

(43) *Full and reduced pronouns can both be coordinated:*

- a. Bòl à-cé Àyén kù kêek t̩iŋ.  
Bol 3S-PRF.SV Ayen and 3PL see.NF  
'Bol has seen Ayen and them.'
- b. Bòl à-cé Àyén kù ké t̩iŋ.  
Bol 3S-PRF.SV Ayen and 3PL see.NF  
'Bol has seen Ayen and them.'

We see the same variation in pronoun copying, so that both the reduced and full form may accompany any particular instance of movement (44a–d), without a clear difference in interpretation.

(44) *Ké-copying may involve full or reduced form:*

- a. Yè kôoc-kò [CP c̩i Bòl ké t̩iŋ]?  
be **people-which** PRF.OV Bol.GEN 3PL see.NF  
'Which people has Bol seen?'
- b. Yè kôoc-kò [CP c̩i Bòl kêek t̩iŋ]?  
be **people-which** PRF.OV Bol.GEN 3PL see.NF  
'Which people has Bol seen?'
- c. Kêek áa-c̩i Áyèn ké t̩iŋ.  
3PL 3P-PRF.OV Ayen.GEN 3PL see.NF  
'Them, Ayen has seen.'

- d. **Kêek** áa-cíi Áyèn **kêek** t̩iŋ.  
 3PL 3P-PRF.OV Ayen.GEN 3PL see.NF  
 ‘Them, Ayen has seen.’

This variation extends to long-distance movement. If we have multiple instances of *ké*-copying, any number of them may appear as the full form of the pronoun, apparently without constraints (45a–c).

(45) *No constraints on full/reduced forms in ké-copying:*

- a. Yè **kòɔc-kò** [CP yíi Ból [vP **kêek** luéel [CP è cíi Áyèn [vP **kêek**  
 be **people-which** HAB.OV Bol.GEN 3PL say.NF C PRF.OV Ayen.GEN 3PL  
 t̩iŋ]]]]]?  
 see.NF  
 ‘Which people does Bol say Ayen has seen?’
- b. Yè **kòɔc-kò** [CP yíi Ból [vP **ké** luéel [CP è cíi Áyèn [vP **kêek**  
 be **people-which** HAB.OV Bol.GEN 3PL say.NF C PRF.OV Ayen.GEN 3PL  
 t̩iŋ]]]]]?  
 see.NF  
 ‘Which people does Bol say Ayen has seen?’
- c. Yè **kòɔc-kò** [CP yíi Ból [vP **kêek** luéel [CP è cíi Áyèn [vP **ké**  
 be **people-which** HAB.OV Bol.GEN 3PL say.NF C PRF.OV Ayen.GEN 3PL  
 t̩iŋ]]]]]?  
 see.NF  
 ‘Which people does Bol say Ayen has seen?’

This similarity in form suggests that copied *ké* is an instance of the 3rd person plural pronoun. Another piece of evidence for this is that we can show that copied *ké* is a free-standing element, like regular pronouns, and not the realization of object agreement. Copied *ké* often immediately precedes a verb at the start of the verb cluster, as in (46a). This does not have to be the case, however. Copied *ké* can surface also before an object in Spec-*vP* when a plural adjunct moves out of the *vP* (46b), as noted in Chapter 5 as well (sec. 5.2). In fact, copied *ké* can be followed by nothing at all, when the verb moves up to second position (46c).

(46) *Copied pronoun is free-standing:*

- a. Yè **kòɔc-kò** [CP cíi Ból [vP **ké(ek)** t̩iŋ]]]?  
 be **people-which** PRF.OV Bol.GEN 3PL see.NF  
 ‘Which people has Bol seen?’
- b. Yè **ɲáɲ-kò** [CP cíi Ból [vP **ké(ek)** Àyén tuòɔc]]]?  
 be **places-which** PRF.OV Bol.GEN 3PL Ayen send.NF  
 ‘Which places has Bol sent Ayen to?’



- c. Yè kòòc-kò [CP nhiéer Ból [vP ké(ek)]]?  
 be **people-which** love.OV Bol.GEN 3PL  
 ‘Which people does Bol love?’

These facts demonstrate that *ké* is not object agreement on the verb, since it does not have to appear before the verb. *Ké* also is not the realization of a functional head in the extended projection of the verb, because then it should move along with the verb when the verb moves into the left periphery.

### 3.3 *Ké-copying tracks intermediate movement*

Having established then that *ké*-copying signals the presence of a true pronoun, let me show that it tracks intermediate movement. *Ké*-copying reliably appears with movement of any plural noun phrase that undergoes intermediate successive-cyclic movement to the verb phrase edge, regardless of grammatical function. For example, plural VP-modifiers trigger *ké*-copying, just like objects (47a–b).

#### (47) *Ké-copying with plural modifiers:*

- a. Yè ɲáɲ-kò [CP cíi Ból [vP ké Àyén tuòc]]?  
 be **places-which** PRF.OV Bol.GEN 3PL Ayen send.NF  
 ‘Which places has Bol sent Ayen to?’
- b. Yè tóony ké díi [CP cíi Ból [vP ké cujin thaal]]?  
 be **pots** QUANT.PL **how** PRF.OV Bol.GEN 3PL food cook.NF  
 ‘How many pots has Bol cooked food with?’

Like objects, such modifiers trigger successive *ké*-copying when undergoing long-distance movement, as the examples in (48a–b) attest.

#### (48) *Successive ké-copying with plural modifiers:*

- a. Yè ɲáɲ-kò [CP yá [vP ké luéel [CP è cíi Ból [vP ké Àyén  
 be **places-which** HAB.2SG 3PL say.NF C PRF.OV Bol.GEN 3PL Ayen  
 tuòc]]]]?  
 send.NF  
 ‘Which places do you say that Bol has sent Ayen to?’
- b. Yè tóony ké díi [CP yá [vP ké luéel [CP è cíi Ból [vP ké cujin  
 be **pots** QUANT.PL **how** HAB.2SG 3PL say.NF C PRF.OV Bol.GEN 3PL food  
 thaal]]]]?  
 cook.NF  
 ‘How many pots do you say that Bol has cooked food with?’

All plural modifiers trigger *ké*-copying in this fashion. A plural temporal adjunct, for instance, also requires a copied *ké* (49a), as does a plural instrumental (49b).<sup>17</sup>

(49) *Ké-copying with plural modifiers:*

- a. Yè **thèek-kò** [CP *cíi* Bòl [vP **ké** b̩̀ jàal]]?  
 be **times-which** PRF.OV BOL.GEN 3PL GO.NF leave.NF  
 ‘At which times has Bol left?’
- b. Yè **kàṅó** [CP *cíi* Bòl [vP **ké** b̩̀ jàal]]?  
 be **what.things** PRF.OV BOL.GEN 3PL GO.NF leave.NF  
 ‘What has Bol used to leave with?’

Importantly, the only plural arguments that do not trigger *ké*-copying with  $\bar{A}$ -movement within a clause are subjects. A plural subject in Spec-CP, for example, cannot be doubled by a copied *ké* (50a). In addition, relativization of a subject may not be accompanied by *ké*-copying (50b).

(50) *Subjects are not doubled by a plural ké locally:*

- a. Ròoor áa-cé (\*ké) ỳ̩in t̩̀ì̩ŋ.  
 men 3P-PRF.SV 3PL you see.NF  
 ‘The men have seen you.’
- b. Yè **kòoc-kò** [CP *cé* (\*ké) cù̩in câam]?  
 be **people-which** PRF.SV 3PL food eat.NF  
 ‘Which people have eaten food?’

These facts make sense if subjects are generated in Spec-*vP* (or higher). Since they are generated at the *vP* edge, there is no need for them to undergo intermediate movement to escape the *vP* domain. This fits well with the observation that subjects do not count for *vP*-level V2 in Dinka generally, previously discussed in Chapter 2 (sec. 3.1).

In support of this, we see that subjects do trigger *ké*-copying when they are undergoing long-distance movement. When a subject moves long-distance, a copied *ké* is still banned at the *vP* edge the subject is generated at, but *ké*-copying is obligatory at every subsequent verb phrase (51a–b).

(51) *Plural subjects are doubled by ké in higher clauses:*

- a. Ròoor áa-yùukù [vP **ké** tàak [CP *cé* [vP (\*ké) ỳ̩in t̩̀ì̩ŋ]]].  
 men 3P-HAB.1PL 3PL think.NF PRF.SV 3PL you see.NF  
 ‘The men, we think have seen you.’
- b. Yè **kòoc-kò** [CP yùukù [vP **ké** tàak [CP *càm* [vP (\*ké) cù̩in]]]]?  
 be **people-which** HAB.1PL 3PL think.NF eat.SV 3PL food  
 ‘Which people do we think are eating food?’

17. This could suggest that a full temporal PP is generated lower than *wh*-words like *when*, which are usually taken to be generated outside of the verb phrase. There is certainly a clear difference in Dinka between *why* and its plural counterpart *for which reasons*. The latter can be only expressed periphrastically (e.g. *What things made Bol leave?*).

A particularly striking piece of evidence for the structural sensitivity of *ké*-copying comes from extraction out of clausal subjects. The verb *nhóm m̄̄ar* ('to forget') embeds a finite clause that can surface as an (extraposed) clausal subject. In a reversal of the pattern in (51a–b), long-distance movement from an extraposed clausal subject requires *ké*-copying in the lower clause, but the *absence* of *ké*-copying in the higher clause (52).

(52) *No ké-copying in higher clause with extraction out of clausal subject:*

Yè k̄̄oc-kò [CP cé [vP (\*ké) w̄̄ok mū̄or nh̄̄im [CP é-kè-c̄̄uk̄̄ù ké t̄̄ī̄y]]]?  
 be **people-which** PRF.SV 3PL 1PL lose.NF heads PST-PL-PRF.1PL 3PL see.NF  
 'Which people have we forgotten that we had seen?'

This contrast follows if *ké*-copying reflects intermediate movement to Spec-*vP*. Subjects are outside the domain of verb phrase V2 and so movement out of a clausal subject should not require stopping off at the *vP* edge.

We can conclude from these facts that *ké*-copying is a consequence of intermediate movement to the edge of the verb phrase. *Ké*-copying functions as evidence for successive-cyclic derivations (Chomsky 1977 et seq.), because it is sensitive precisely to those movement steps. Also, as noted in the previous chapter, *ké*-copying targets the same position that I argued is targeted for intermediate movement on the basis of EPP effects, the left edge of the verb phrase, and so provides converging evidence for the view of intermediate movement developed in that chapter.

### 3.4 *Ké-copying is spell-out of a copy*

Let me finally provide some arguments for the claim that *ké*-copying is the realization of an intermediate copy. It is important to show, first of all, that dependencies with *ké*-copying behave like all other instances of movement in Dinka. Because *ké*-copying is limited to plurals, we can compare movement with *ké*-copying to movement without it, by comparing movement of a plural to a movement of a singular. As the examples in (53a–b) demonstrate, both types of movement are sensitive to islands.

(53) *Ké-copying is island-sensitive:*

- a. \*Yè ŋó [CP c̄̄ī̄ Áyèn [DP ràan [CP m̄̄er \_\_\_]] t̄̄ī̄y]?  
 be **what** PRF.OV Ayen.GEN person.cs1 decorate.sv see.NF  
 'What has Ayen seen someone [who is decorating it]?'  
 b. \*Yè k̄̄oc-kò [CP c̄̄ī̄ Ból (ké) [DP ràan [CP cé ké cū̄in cáam]]  
 be **people-which** PRF.OV Bol.GEN (3PL) person.cs1 PRF.SV 3PL food eat.NF  
 t̄̄ī̄y]?  
 see.NF  
 'Which people has Bol seen someone who has eaten food with them?'

Neither extraction with pronoun copying or without it can escape a relative clause island.

In further support of the idea that the syntax of movement is the same regardless of whether *ké*-copying takes place, observe that whether movement reconstructs is independent of *ké*-copying. As we saw in Chapter 4, using Dinka's Condition A anaphor, movement may reconstruct for local (54a), long-distance (54b), and intermediate binding (54c).

(54) *Movement reconstructs for anaphor binding:*

- a. Ròt-dé<sub>i</sub> à-cè<sub>i</sub> nhiâar.  
self-SG.3SG 3S-PRF.3SG love.NF  
'Herself/himself, she/he has loved.'
- b. Ròt-dé<sub>i</sub> à-yùukù tàak [CP è cè<sub>i</sub> nhiâar].  
self-SG.3SG 3S-HAB.1PL think.NF C PRF.3SG love.NF  
'Herself/himself, we say that she/he has loved.'
- c. Ròt-dé<sub>i</sub> à-cè<sub>i</sub> tàak [CP è cùukù nhiâar].  
self-SG.3SG 3S-PRF.3SG think.NF C PRF.1PL love.NF  
'Herself/himself, she/he has thought that we have loved.'

We find the same facts with *ké*-copying. When *ròth* ('self.PL'), the plural version of the anaphor, topicalizes, it is accompanied by *ké*-copying just like other plural DPs. In such constructions, the anaphor can still reconstruct to the same positions, as the examples in (55a–c) attest.

(55) *Ké-copying allows reconstruction:*

- a. Ròth-kén<sub>i</sub> áa-nhiárkè<sub>i</sub> kèek.  
self-PL.3PL 3P-love.3PL 3PL  
'Themselves, they love.'
- b. Ròth-kén<sub>i</sub> áa-yùukù ké luéel [CP è nhiárkè<sub>i</sub> kèek].  
self-PL.3PL 3P-be.1PL 3PL say.NF C love.3PL 3PL  
'Themselves, we say that they love.'
- c. Ròth-kén<sub>i</sub> áa-yìikè<sub>i</sub> ké luéel [CP è nhiéer Ból kèek].  
self-PL.1PL 3P-be.3PL 3PL say.NF C love.OV Bol.GEN 3PL  
'Themselves, they say that Bol loves.'

There is no discernible effect of *ké*-copying then on the interpretation of long-distance movement. This follows if copied *ké* simply diagnoses the location of an intermediate copy of successive-cyclic movement.

There is another piece of evidence that suggests that *ké* should be treated as the result of multiple copy spell-out. This argument comes from the observation that copied *ké(ek)* violates an otherwise strict V2 requirement on the verb phrase. As we saw in Chapter 2 (sec. 3.1) and also Chapter 5 (sec. 4), only one DP may overtly appear at the left edge of the Dinka verb phrase. The sole exception to this in Dinka is the process of *ké*-copying. As we have already seen, when a copied *ké* is left by adjunct extraction, it precedes a nominal object that occupies Spec-*vP* (56a–b).

(56) *Ké may appear before object in violation of V2:*

- a. Yè **ɥáán-kò** [CP **cíi** Ból [vP **ké** Àyén tuòɔc]]?  
 be **places-which** PRF.OV Bol.GEN 3PL Ayen send.NF  
 ‘Which places has Bol sent Ayen to?’
- b. Yè **tóony ké** **díi** [CP **cíi** Ból [vP **ké** cuïn thaal]]?  
 be **pots QUANT.PL how** PRF.OV Bol.GEN 3PL food cook.NF  
 ‘How many pots has Bol cooked food with?’

This suggests that copied *ké* is the result of a special mechanism, because no other phrase can ever appear in this position. Dinka does not allow other nominals, adjuncts, or adverbs to surface in between an in situ subject and an object in Spec-*vP*. As a result of this, there is a clear contrast between copied and independent instances of *ké(ek)*. Independent uses of the third person plural pronoun obey the V2 restriction: they may only appear at the *vP* edge by themselves (57a), and not alongside another object (57b).

(57) *Independent ké(ek) cannot occur between subject and object:*

- a. Ból à-cé [vP **ké(ek)** yiɛɛn kitáap].  
 Bol 3S-PRF.SV 3PL give.NF book  
 ‘Bol has given them a book.’
- b. \*Ból à-cé [vP **ké(ek)** kitáap yiɛɛn].  
 Bol 3S-PRF.SV 3PL book give.NF  
 ‘Bol has given them a book.’

We can make sense of this if copied *ké* is the realization of an intermediate copy, because, as I argued in Chapter 5 (sec. 5.2), intermediate successive-cyclic movement allows for the creation of an additional specifier at the *vP* edge, if the moving phrase is not capable of satisfying V2 (because it is a PP that cannot be targeted for  $\varphi$ -agreement). I encoded this observation by positing two probes on *v* that can initiate movement: a  $\varphi$ -probe and a probe for intermediate  $\bar{A}$ -movement. This view then explains why copied *ké* is capable of violating the V2 requirement: an intermediate copy of a modifier only makes use of the  $\bar{A}$ -probe on *v*, and a DP object is attracted by the  $\varphi$ -probe.

### 3.5 Pronoun copying in Seereer

I have shown in this section that *ké*-copying in Dinka is the realization of a copy left by intermediate successive-cyclic movement to the *vP* edge. This provides evidence that pronouns may spell out full copies in intermediate positions and hence for the hypothesis that pronouns represent one of the ways in which a DP may surface.

A strikingly similar pattern to the Dinka one is described by Baier (2014) for the Senegalese language Seereer (Atlantic). In Seereer, copied pronouns accompany movement across a clause boundary. These copied pronouns appear just after the complementizer (58a–b).<sup>18</sup>

(58) *Pronoun copying in Seereer:*

- a. **Xar** foog-o [CP yee **ten** Yande a-lay-u [CP yee **ten** Jegaan a-ga'-u]]?  
**what** think-2SG.EXT c **3SG** Yande 3-say-EXT c **3SG** Jegaan 3-see-EXT  
 'What do you think Yande said Jegaan saw?'
- b. **Aniin** foog-o [CP yee **den** Yande a-lay-u [CP yee **den** Jegaan a-ga'-u]]?  
**who.PL** think-2SG.EXT c **3PL** Yande 3-say-EXT c **3PL** Jegaan 3-see-EXT  
 'Who all do you think Yande said Jegaan saw?'
- (Seereer; Baier 2014)

Pronoun copying in Seereer targets a different domain edge (the edge of CP) and does not show a number asymmetry, as the examples above attest. Seereer pronoun copying is similar to *ké*-copying in many respects, however. Like *ké*-copying, it is an obligatory reflex of long-distance movement. In addition, as Baier shows, Seereer pronoun copying is movement-derived. Movement with copied pronouns is island-sensitive and so cannot cross a *wh*-island, for example (59).

(59) *Seereer pronoun copying is island-sensitive:*

- \***Xar** and-o [CP ndax **ten** Ami a-ga'-u \_\_\_\_]  
**what** know-2SG.FOC c.INT **3SG** Ami 3-see-FOC  
 'What do you know whether Ami saw \_\_\_\_?'
- (Seereer: Baier 2014)

As in Dinka, movement with pronoun copying may reconstruct. The examples in (60a–b) illustrate that these dependencies may reconstruct for long-distance (60a), and intermediate binding (60b).

(60) *Seereer pronoun copying shows reconstruction:*

- a. [DP **xoox um<sub>i</sub>**] *pro* a-nqalaat-u [CP yee **ten** Yande<sub>i</sub> a-ga'-u \_\_\_\_]  
**REFL 3SG 3PL 3-think.PL-FOC** c **3SG** Yande 3-see-FOC  
 'It's herself<sub>i</sub> that they think Yande<sub>i</sub> saw \_\_\_\_.'
- b. [DP **xoox den<sub>i</sub>**] *pro<sub>i</sub>* a-nqalaat-u [CP yee **ten** Yande a-ga'-u \_\_\_\_]  
**REFL 3PL 3PL 3-think.PL-FOC** c **3SG** Yande 3-see-FOC  
 'It's themselves<sub>i</sub> that they<sub>i</sub> think Yande saw \_\_\_\_.'
- (Seereer: Baier 2014)

18. There is an interesting similarity here to the Dinka patterns of intermediate movement to the clause edge in Chapter 5, which also implicate a position just below the complementizer.

These Seereer facts then provide another configuration in which pronouns are used to realize a DP copy in an intermediate position and so lend further weight to the claim that this is one way in which intermediate copies may be treated. In addition, the comparison between Dinka and Seereer will prove fruitful in developing a theory of why pronouns may come to realize more articulated copies. In particular, we will see in section 4 that the two languages differ in how closely copied pronouns match their antecedent DP. This variation is mirrored by variation in other environments that I have argued involve pronominal spell-out, such as resumption and subject doubling.

A question raised by the comparison of Dinka and Seereer, however, is whether there are languages that spell out a copy at both the CP and *v*P edge. I am not aware of such a system. For Seereer, this is probably due to the fact that only the CP edge behaves like it has an EPP property. Plausibly then, the trigger for multiple spell-out is absent in the Seereer *v*P. In Dinka, however, the two domains are highly parallel and both have the V2 property. I return to this issue in section 5.4 and suggest that a different process takes place at Spec-CP.

The patterns described in this section provide additional evidence for the claim at the heart of this chapter: that pronouns may realize full copies of lexical DPs. The Dinka and Seereer facts discussed here mean that all three patterns of pronoun copying that are logically possible are attested. Pronominal spell-out of a lower copy is found in resumption in many languages and subject doubling in Wambeek Dutch (Van Craenenbroeck and Van Koppen 2002). Pronominal realization of the highest copy is the source of clitic doubling, subject doubling in Finnish (Holmberg and Nikanne 2008), as well as some types of *wh*-copying in Dutch, German, and Passamaquoddy (Fanselow and Čavar 2001; Felser 2004; Bruening 2006; Boef 2013). Finally, spell-out of an intermediate copy as a pronoun happens in Dinka and Seereer as well as in German *wh*-copying, as described by Anyadi and Tamrazian (1993) and Pankau (2013). This is summarized in (61).

- (61) **Three configurations of pronoun spell-out:**
- a. **Lowest copy:** Resumption, subject doubling (Wambeek Dutch)
  - b. **Highest copy:** Clitic doubling, subject doubling (Finnish), *wh*-copying
  - c. **Intermediate copy:** *Kê*-copying, *wh*-copying (German), Seereer pronoun copying

In addition, pronoun copying is possible with all types of phrasal movement: it can be the result of  $\bar{A}$ -movement, A-movement, and intermediate movement. This is further evidence then that all varieties of phrasal movement involve the same mechanisms.

Having established that pronoun copying is a phenomenon found in many languages which manifests itself in a wide variety of environments, we are ready to turn to the question of how copy deletion converts a fully articulated DP into a pronoun. I will argue that pronouns represent the most minimal form a DP can take, under the view that pronouns represent the functional layer of a DP (Postal 1969; Elbourne 2001, 2005). If the aim of copy deletion is to delete as much material as possible, this forces DP copies to spell out as pronouns in contexts of multiple copy spell-out.

Before developing this proposal, I outline the empirical motivation for a partial spell-out approach. I first show that there is variation across pronoun copying constructions when spelling out a copy of another pronoun. In pronoun copying constructions of all three types listed in (61), in Dinka, but also Nupe, Finnish, and Tunisian Arabic, the copied pronoun only *partially* matches pronominal antecedents. To be precise, in all these languages, copied pronouns only match in number, not in person. Alongside this, we find languages with identical copying constructions in which the copied pronoun always shows *full* matching, for both person and number. I will argue later in this chapter that this is reflective of an asymmetry between person and number, namely that number is introduced above person. In addition to this, I show that some pronoun copying patterns have *gaps*, in that not all antecedents are capable of triggering copying. This is true of singulars in Dinka, but also found in other pronoun copying patterns, like German *wh*-copying (Pankau 2013). I will suggest that these are situations in which the DP structure left by deletion is not enough to spell out as a pronoun, either because a pronoun expressing those features is absent or because all the available pronouns spell out more structure.

#### 4 Asymmetries and gaps in pronoun copying

In this section, I first show that pronoun copying constructions vary in their behavior when realizing a copy of a pronoun. In Dinka and a number of other languages, the copied pronoun does not express person and surfaces with default third person always. In other pronoun copying constructions, however, copied pronouns always fully match their antecedents, including in person features. In addition, I will show that some pronoun copying constructions display gaps, so that some antecedents fail to trigger pronoun copying. In section 5, I trace both of these effects to partial spell-out. The asymmetry between person and number I derive from the idea that person merges below number in pronouns, and may be merged in the part of the copy that undergoes deletion. The existence of gaps I derive from the idea that deletion need not leave a structure that can be spelled out as a pronoun, sometimes resulting in a failure of pronoun copying.

##### 4.1 A person-number asymmetry

In this section, I argue for the generalization that copied pronouns always match in number, but not necessarily in person. I will show that, in Dinka and a number of other languages, copied pronouns only partially spell out copies of other pronouns. In particular, *ké*-copying matches an antecedent pronoun only in number. We will see that, alongside this pattern, we can find languages in which copied pronouns always match in all features, including person. Importantly, however, a third logically possible type of copied pronoun, sensitive to person only, appears to be unattested.

One of the surprising aspects of Dinka *ké*-copying is that it displays an asymmetry between person and number features. In particular, when we examine instances in which pronouns undergo pronoun copying, we find that *ké*-copying is insensitive to person. When a 1st or 2nd person plural



pronoun is topicalized across the *v*P edge, it triggers pronoun copying, but of the third person plural pronoun *ké(ek)* (62a–b), like 3rd person DPs.

(62) *Ké-copying does not match person:*

- a. **Wóok** c̣ii Áyèn [<sub>vP</sub> **ké(ek)** ṭiiŋ].  
**1PL** PRF.OV Ayen.GEN **3PL** see.NF  
 ‘Us, Ayen has seen.’
- b. **Wêek** c̣ii Áyèn [<sub>vP</sub> **ké(ek)** ṭiiŋ].  
**2PL** PRF.OV Ayen.GEN **3PL** see.NF  
 ‘You all, Ayen has seen.’
- c. **Kêek** áa-c̣ii Áyèn [<sub>vP</sub> **ké(ek)** ṭiiŋ].  
**3PL** 3P-PRF.OV Ayen.GEN **3PL** see.NF  
 ‘Them, Ayen has seen.’

Using a copied pronoun with matching person features is in fact impossible (63a–b).

(63) *Copied pronouns cannot be 1st or 2nd person:*

- a. \***Wóok** c̣ii Áyèn [<sub>vP</sub> **wó(ɔk)** ṭiiŋ].  
**1PL** PRF.OV Ayen.GEN **1PL** see.NF  
 ‘Us, Ayen has seen.’
- b. \***Wêek** c̣ii Áyèn [<sub>vP</sub> **wé(ek)** ṭiiŋ].  
**2PL** PRF.OV Ayen.GEN **2PL** see.NF  
 ‘You all, Ayen has seen.’

1st and 2nd person plural pronouns pattern like 3rd person plural nominals in every respect for *ké*-copying. As a further illustration of this, we see that long-distance movement of these pronouns triggers pronoun copying at each edge (64a–b).

(64) *1st/2nd person pronouns can trigger successive ké-copying:*

- a. **Wóok** yii Ból [<sub>vP</sub> **ké** luêeel [<sub>CP</sub> è c̣è [<sub>vP</sub> **ké** ṭiiŋ]]].  
**1PL** HAB.OV Bol.GEN **3PL** say.NF C PRF.3SG **3PL** see.NF  
 ‘Us, Bol says that he has seen.’
- b. **Wêek** yii Ból [<sub>vP</sub> **ké** luêeel [<sub>CP</sub> è c̣è [<sub>vP</sub> **ké** ṭiiŋ]]].  
**2PL** HAB.OV Bol.GEN **3PL** say.NF C PRF.3SG **3PL** see.NF  
 ‘You all, Bol says that he has seen.’

If we take third person to be the default value of person, we can describe this pattern as matching in number only.

This pattern is not limited to Dinka, but is in fact commonly found in pronoun copying constructions. The other two logically possible configurations of pronoun copying can also display this insensitivity to person. Kandybowicz (2007) documents a similar effect in Nupe resumption.

In Nupe, long-distance subject extraction must leave behind a resumptive pronoun in the lower subject position (65).

(65) *Nupe long-distance subject extraction requires resumptive with long-distance:*

**Bagi-zi** Musa gàn [<sub>CP</sub> gànán \*(a:) nì enyà] o.  
**man-PL** Musa say c 3PL beat drum FOC  
 ‘Musa said that THE MEN beat a drum.’  
 (Nupe; Kandybowicz 2007:124)

As in Vata, this type of resumption patterns like movement. It is island-sensitive, for example, and so is impossible out of a *wh*-island (66a), or a subject island (66b).

(66) *Nupe resumption is island-sensitive:*

- a. \***Zě** Musa kpe [<sub>CP</sub> ké u: si] o.  
**who** Musa know what 3SG buy FOC  
 ‘Who does Musa know what bought?’
- b. \***Etsu** [<sub>CP</sub> gànán u: doko] tán Musa o.  
**chief** c 3SG buy horse pain Musa FOC  
 ‘That THE CHIEF bought a horse pained Musa.’  
 (Nupe; Kandybowicz 2007:132)

Importantly, as Kandybowicz points out, the Nupe resumptive pronoun is also insensitive to the person features of pronominal antecedents. Movement of a 1st or 2nd person singular pronominal subject must use the 3rd person singular resumptive (67a–b):

(67) *1st/2nd person singular subjects resumed by 3rd person singular:*

- a. **Mi** Musa gàn [<sub>CP</sub> gànán u:/\*mi: pa eci] o.  
 1SG Musa say c 3SG/1SG pound yam FOC  
 ‘Musa said that I pounded a yam.’
- b. **Wo:** Musa gàn [<sub>CP</sub> gànán u:/\*wo: pa eci] o.  
 2SG Musa say c 3SG/2SG pound yam FOC  
 ‘Musa said that YOU pounded a yam.’  
 (Nupe; Kandybowicz 2007:134)

Similarly, 1st and 2nd person plural pronouns are necessarily resumed by the 3rd person plural (68a–b).

(68) *1st/2nd person plural subjects resumed by 3rd person plural:*

- a. **Yi:** Musa gàn [<sub>CP</sub> gànán a:/\*yi:/\*u: pa eci] o.  
 1PL Musa say c 3PL/1PL/3SG pound yam FOC  
 ‘Musa said that WE pounded a yam.’

- b. **Ye:** Musa gán [CP gánán a:/\*wo:/\*u: pa eci] o.  
 2PL Musa say c 3PL/2PL/3SG pound yam FOC  
 ‘Musa said that YOU ALL pounded a yam.’  
 (Nupe; Kandybowicz 2007:134)

As in Dinka then, the copied pronoun has to match the antecedent DP in number features, but surfaces with a default person value when realizing a copy of a pronoun. We also see in the comparison between Dinka and Nupe that the absence of pronoun copying with singular is a fact specific to Dinka. In Nupe, singular number is still matched on a 3rd person singular pronoun.

The facts from Nupe demonstrate that the number matching pattern is not limited to intermediate copying, but is also found when the copied pronoun spells out the lowest copy. We also find the number-matching pattern in the third pronoun copying configuration, in which the pronoun is the realization of the highest copy. Recall that colloquial Finnish allows a subject to be doubled by a clause-initial pronoun (Holmberg and Nikanne 2008). Some examples are repeated in (69a–b).

(69) *Initial pronoun may double subject in Finnish:*

- a. **Se** on Jari lopettanut tupakoinnin.  
 3SG has Jari quit smoking  
 ‘Jari has quit smoking.’
- b. **Ne** sai kaikki lapset samat oireet.  
 3PL got all children same symptoms  
 ‘All the children got the same symptoms.’  
 (Finnish; Holmberg and Nikanne 2008:326)

As Holmberg and Nikanne point out, the doubled subject need not match in person. Instead, the 3rd person singular may be used to double 1st and 2nd person singular pronouns (70a–b), and, for some speakers, the 3rd person plural pronoun can be used to double 1st and 2nd person plural pronouns (70c–d).

(70) *Finnish subject doubling can be person-insensitive:*

- a. **Se** ole-n minä-kin lopettanut tupakoinnin.  
 3SG are-1SG 1SG-too quit smoking  
 ‘I have quit smoking, too.’
- b. **Se** ole-t sinä-kin lopettanut tupakoinnin.  
 3SG are-2SG 2SG-too quit smoking  
 ‘You have quit smoking, too.’
- c. **Ne** ollaan me-kin lopettanut tupakoinnin.  
 3PL are.1PL 1PL-too quit smoking  
 ‘We have quit smoking, too.’

- d. **Ne** ollette **te-kin** lopettanut tupakoinnin.  
**3PL** are.2PL **2PL-too** quit smoking  
 ‘You all have quit smoking, too.’  
 (Finnish; Holmberg and Nikanne 2008:327,328)

Unlike in Dinka or Nupe, this is not obligatory. For all speakers, 1st and 2nd person pronouns may be doubled by an identical initial pronoun as well, as the examples in (71a–b) evidence.

(71) *Finnish subject doubling may match in person:*

- a. **Me** ollaan **me-kin** lopettanut tupakoinnin.  
**1PL** are.1PL **1PL-too** quit smoking  
 ‘We have quit smoking, too.’
- b. **Te** ollette **te-kin** lopettanut tupakoinnin.  
**2PL** are.2PL **2PL-too** quit smoking  
 ‘You all have quit smoking, too.’  
 (Finnish; Holmberg and Nikanne 2008:328)

Finnish subject doubling then allows at least two levels of matching: number only and both person and number. Importantly, there is an asymmetry here between person and number. Although mismatches in person are tolerated, matching in number is *obligatory*. The third person singular, for instance, cannot be used to double any of the plurals, as the examples in (72a–c) show. Similarly, the 1st and 2nd person singular pronouns cannot double their respective plurals (72d–e).

(72) *Finnish subject doubling is never number-insensitive:*

- a. \***Se** ollaan **me-kin** lopettanut tupakoinnin.  
**3SG** are.1PL **1PL-too** quit smoking  
 ‘We have quit smoking, too.’
- b. \***Se** ollette **te-kin** lopettanut tupakoinnin.  
**3SG** are.2PL **2PL-too** quit smoking  
 ‘You all have quit smoking, too.’
- c. \***Se** on **ne-kin** lopettanut tupakoinnin.  
**3SG** be.3PL **3PL-too** quit smoking  
 ‘They have quit smoking, too.’  
 (Finnish; Holmberg and Nikanne 2008:328)
- d. \***Minä** ollaan **me-kin** lopettanut tupakoinnin.  
**1SG** are.1PL **1PL-too** quit smoking  
 ‘We have quit smoking too.’

- e. \***Sinä** ollette **te-kin** lopettanut tupakoinnin.  
 2SG are.2PL 2PL-too quit smoking  
 'We have quit smoking too.'  
 (Finnish; Urpo Nikanne, p.c.)

That this pattern of person-insensitivity shows up in a wide range of pronoun copying constructions provides evidence that these constructions should be given a unified treatment. The similarities between Finnish, Nupe, and Dinka are striking, given the very different functions that pronoun copying fulfils in all of these languages.

These facts also provide an important insight into the mechanism behind spelling out a pronoun as a copy. The number-matching patterns point to a crosslinguistic asymmetry between person and number in pronoun copying. In the Finnish facts, we see that, even though Finnish allows different levels of matching, the doubling pronoun can be person-insensitive, but never number-insensitive. This is revealing of a larger generalization, that copied pronouns cannot match in person without matching in number. As further support for this, we will see that, in some languages, copied pronouns that must match in person always. In each case, the copied pronoun has to match in number as well.

For all of the configurations described above, we can find instances of the same construction in other languages in which the copied pronoun must match in person. We saw this already within one language, in Finnish subject doubling, but we find this variation across languages too. In Finnish, a pronoun spelling out a higher copy may optionally match in person. But we also find pronoun copying that must always display full matching.

In particular, full matching for all features of the antecedent DP is typical of clitic doubling.<sup>19</sup> I will demonstrate first for Greek clitic doubling. In Greek, genitive and accusative arguments may undergo clitic doubling (see Anagnostopoulou 2003 for an overview), as in (73).

- (73) *Greek clitic doubling with genitives and accusatives:*  
 (tu) (to) edhosa tu Jani to vivlio.  
 3MS.GEN 3NS.ACC gave.1SG the.GEN Janis.GEN the.ACC book.ACC  
 'I gave John the book.'  
 (Greek; Anagnostopoulou 2006:43)

As already evident in (73), Greek doubling clitics match their associate DP in case, person, number, and gender. This is obligatory, as the examples below show for case (74a),<sup>20</sup> person (74b), gender (74c), and number (74d). In these examples, an emphatic pronoun is used, in order to make clitic doubling natural with a pronominal associate.

19. An interesting question is whether there are clitic doubling languages in which the clitic does not match pronominal associates in person. I do not know of such a case, but my approach predicts that this pattern could exist.

20. I compare accusative with genitive, the other possible clitic, though a mismatch would likely be expressed with a default case (i.e. nominative). Nominative clitics are absent, already illustrating the impossibility of this mismatch.

(74) *Greek clitic doubling does not tolerate mismatches:*

- a. **ton/\*tu**            ksero            **afton.**  
3MS.ACC/3MS.GEN know.1SG.PR 3MS.ACC  
'I know HIM.'
- b. **me/\*ton**            kseris            **emena.**  
1SG.ACC/3MS.ACC know.2SG.PR 1SG.ACC  
'You know ME.'
- c. **tin/\*ton**            ksero            **aftin.**  
3FS.ACC/3MS.ACC know.1SG.PR 3FS.ACC  
'I know HER.'
- d. **tis/\*tin**            ksero            **aftes.**  
3FP.ACC/3FS.ACC know.1SG.PR 3FP.ACC  
'I know THEM (fem.).'  
(Greek; Sabine Iatridou, p.c.)

The same conclusion is illustrated for Bulgarian clitic doubling in (75a–d).

(75) *Bulgarian clitic doubling does not tolerate mismatches:*

- a. Az **go/\*mu**            poznavam **nego.**  
1SG 3MS.ACC/3MS.DAT know.1SG 3MS.ACC  
'I know HIM.'
- b. Ti **me/\*go**            poznavash **mene.**  
2SG 1SG.ACC/3MS.ACC know.2SG 1SG.ACC  
'You know ME.'
- c. Az **ja/\*go**            poznavam **neja.**  
1SG 3FS.ACC/3MS.ACC know.1SG 3FS.ACC  
'I know HER.'
- d. Az **gi/\*go**            poznavam **tjax.**  
1SG 3PL.ACC/3MS.ACC know.1SG 3PL.ACC  
'I know THEM.'  
(Bulgarian; Snejana Iovtcheva, p.c.)

These examples are representative for clitic doubling, which does not tolerate mismatches.<sup>21</sup>

Recall that in Nupe, long-distance subject movement requires a number-matching resumptive pronoun in subject position (Kandybowicz 2007). A similar resumptive pattern is found in Yoruba (Adesola 2010). In Yoruba, movement of a subject also requires a resumptive pronoun (76a–b).

---

21. One interesting question is whether there is a featural mismatch in languages in which clitic doubling is subject to Kayne's Generalization, so that the associate DP is followed by a special preposition (e.g. *a* in dialects of Spanish, *pe* in Romanian, and *šel* in Hebrew; Steriade 1980; Jaeggli 1982, 1986; Borer 1984). Depending on how the preposition is analyzed (i.e. as a case marker or as a preposition, cf. Jaeggli 1982, 1986), this could be seen as a case mismatch.

(76) *Yoruba subject extraction requires resumptive pronoun:*

- a. **Ta** ni [<sub>CP</sub> \*(**ó**) ra àga]?  
who be 3SG buy chair  
'Who bought a chair?'
- b. **Olú ati Adé** ni [<sub>CP</sub> Òjó sọ [<sub>CP</sub> pé \*(**wón**) ra iṣu]].  
Olu and Ade be Ojo say that 3PL buy yams  
'It was Olu and Ade that Ojo said \_\_\_ bought some yams.'  
(Yoruba; Adesola 2010:68,81)

Unlike in Nupe, this resumptive pronoun must spell out all of the features of a pronoun it is copying. As (77a–d) demonstrate, the resumptive pronoun matches in both person and number.<sup>22</sup>

(77) *Yoruba resumptive subjects match in  $\varphi$ -features:*

- a. **Èmi** ni [<sub>CP</sub> **mo** ra àpò].  
1SG be 1SG buy bag  
'I was the one who bought a bag.'
- b. **Àwa** ni [<sub>CP</sub> **a** ra àpò].  
1PL be 1PL buy bag  
'We were the people who bought a bag.'
- c. **Ìwo** ni [<sub>CP</sub> **o** ra àpò].  
2SG be 2SG buy bag  
'You were the one who bought a bag.'
- d. **Eyin** ni [<sub>CP</sub> **e** ra àpò].  
2PL be 2PL buy bag  
'You are the people who bought a bag.'  
(Yoruba; Adesola 2010:82)

This pattern is then minimally different from the Nupe one, but with matching in person also.

We can find similar variation in pronoun spell-out of intermediate copies. We saw above that *ké*-copying only matches pronouns in number. We can compare Dinka to Seereer, which displays a pronoun copying pattern at the CP edge. Unlike in Dinka, these copied pronouns match fully, so that 1st and 2nd person pronouns are doubled by identical pronouns, as in (78), for example.

(78) *Pronoun copying matches in person in Seereer:*

- Mi** foog-o [<sub>CP</sub> yee **mi**/\***ten** ret-u Dakar]?  
1SG think-2SG.EXT c 1SG/3SG go-FOC Dakar  
'It's me who you think went to Dakar.'  
(Seereer; Baier 2014)

22. Adesola observes that it is also possible to leave an expletive in the subject position, which, in Yoruba, is the 3rd person singular pronoun. This could also be analyzed as a "bare resumptive" in the sense of Adger (2011).

Two options then emerge for copied pronouns with pronominal antecedents, regardless of configuration: matching in number only, or matching in both person and number. I summarize these results in the table below (79).

(79)	<i>Number</i>	<i>Person</i>	<i>Person+number</i>
<b>Lowest copy (resumption)</b>	Nupe	*	Yoruba
<b>Highest copy (subject doubling)</b>	Finnish	*	Finnish
<b>Intermediate copy</b>	Dinka	*	Seereer

Importantly, there appear to be no pronoun copying patterns in which the copied pronoun only matches in person. As a result, we can restate this table as a generalization about pronoun copying, as in (80).

- (80) **Generalization about person and number in pronoun copying:**  
 If a copied pronoun matches in person, it matches in number.

This is one of the asymmetries that will motivate my treatment of pronoun copying as partial spell-out, which I argue is directly reflective of partial spell-out. In particular, I propose that this asymmetry follows from the fact that person is introduced below number in the DP. As a result, partial deletion may remove person features without affecting number, but not the other way around. This is evidence that pronoun copying comes about by means of partial spell-out, and also for the notion that person and number may be introduced separately in the DP.

#### 4.2 Gaps in pronoun copying

Having established that there is a person-number asymmetry in the behavior of pronoun copying across languages, I now turn to a different type of asymmetry evident in pronoun copying in Dinka and a number of other copying constructions. In particular, pronoun copying sometimes displays *gaps*, in that some antecedent DPs fail to trigger pronoun copying. I will argue that the existence of gaps also follows naturally from the mechanism of partial spell-out. Specifically, I suggest that partial deletion may delete too much of a DP copy, so that no copied pronoun can be created.

As mentioned previously, one surprising property of Dinka pronoun copying is the fact that it is limited to plurals (81a). There is no pronoun copying with movement of singular DPs (81b).

- (81) **Dinka pronoun copying is limited to plurals:**
- a. Yè kòoc-kó [CP cíi Ból [vP ké t̩iɪ]]?  
 be **people-which** PRF.OV BOL.GEN 3PL see.NF  
 ‘Which people has Bol seen?’
- b. Yè ñà [CP cíi Ból [vP (\*yé) t̩iɪ]]?  
 be **who** PRF.OV BOL.GEN 3SG see.NF  
 ‘Who has Bol seen?’



This asymmetry extends to pronouns as well. Although plural pronouns of all persons participate in *ké*-copying, there is no pronoun copying with singular pronouns (82a–b).

(82) *No pronoun copying with singular pronouns:*

- a. **ʋɛ̀ɛn** **c̣i**    **ṃɔc**    [<sub>VP</sub> (\*à) ṭiɲ].  
**1SG** **PRF.OV** **MAN.GEN**    **1SG** **SEE.NF**  
‘Me, the man has seen.’
- b. **Ỵiɲ** **c̣i**    **ṃɔc**    [<sub>VP</sub> (\*ỵi) ṭiɲ].  
**2SG** **PRF.OV** **MAN.GEN**    **2SG** **SEE.NF**  
‘You, the man has seen.’

I suggest that this gap arises because of the mechanism of partial spell-out. In particular, I will propose that the 3rd person singular pronoun in Dinka spells out both person and number, while the 3rd person plural spells out only plural. Because pronoun copying in Dinka deletes the part of the DP that encodes person, no suitable pronoun can spell out the remaining DP structure.

That pronoun copying may display gaps of this sort is also suggested by data from German *wh*-copying, as described by Pankau (2013). Pankau (2013:ch. 3) argues at length that *wh*-copying in German requires matching both in case and  $\varphi$ -features. As noted previously, copied *wh*-phrases carry the same case as the full DP (83a–c).

(83) *Wh-copying involves case matching:*

- a. **Wem** glaubst du [<sub>CP</sub> **wem** deine Eltern \_\_\_ vertrauen]?  
**who.DAT** believe you    **who.DAT** your parents    trust  
‘Who do you think your parents trust?’
- b. **Wen** glaubst du [<sub>CP</sub> **wen** deine Eltern \_\_\_ gesehen haben]?  
**who.ACC** believe you    **who.ACC** your parents    seen    have  
‘Who do you think your parents saw?’
- c. **Wer** glaubst du [<sub>CP</sub> **wer** ihn \_\_\_ getötet hat]?  
**who.NOM** believe you    **who.NOM** him    killed has  
‘Who do you think killed him?’  
(German; Pankau 2013:177)

That this case matching follows from copy spell-out is particularly clear when we look at verbs that can show variation in what case they assign, like the verb *lehren* (‘to learn/teach’), which may assign both accusative and dative to its indirect object (84a–b).

(84) *‘Lehren’ takes dative or accusative object:*

- a. Er lehrt **ihm** die lateinische Sprache.  
he teaches **him.DAT** the Latin    language  
‘He teaches him the Latin language.’

- b. Er lehrt **ihn** die lateinische Sprache.  
 he teaches **him.ACC** the Latin language  
 ‘He teaches him the Latin language.’  
 (German; Pankau 2013:66)

As Pankau notes, extraction of such an indirect object with *wh*-copying still requires the same case on both *wh*-phrases (85a–d).

(85) ***Wh-copying must involve case matching:***

- a. **Wen** glaubst du [<sub>CP</sub> **wen** er \_\_\_ die lateinische Sprache lehren wird]?  
**who.ACC** believe you **who.ACC** he the Latin language teach will  
 ‘Who do you believe he teaches the Latin language?’
- b. **Wem** glaubst du [<sub>CP</sub> **wem** er \_\_\_ die lateinische Sprache lehren wird]?  
**who.DAT** believe you **who.DAT** he the Latin language teach will  
 ‘Who do you believe he teaches the Latin language?’
- c. \***Wen** glaubst du [<sub>CP</sub> **wem** er \_\_\_ die lateinische Sprache lehren wird]?  
**who.ACC** believe you **who.DAT** he the Latin language teach will  
 ‘Who do you believe he teaches the Latin language?’
- d. \***Wem** glaubst du [<sub>CP</sub> **wen** er \_\_\_ die lateinische Sprache lehren wird]?  
**who.DAT** believe you **who.ACC** he the Latin language teach will  
 ‘Who do you believe he teaches the Latin language?’  
 (German; Pankau 2013:66)

Whether *wh*-copying involves matching in  $\varphi$ -features also is harder to investigate, because *wh*-pronominals are necessarily 3rd person and, as Pankau points out, only have a masculine and a neuter form in German. The paradigm for German *wh*-pronouns is given in (86).

(86) ***German wh-pronouns (Pankau 2013:60):***

	SG			PL
	MASC	FEM	NEUT	
NOM	<i>wer</i>	-	<i>was</i>	-
ACC	<i>wen</i>	-	<i>was</i>	-
DAT	<i>wem</i>	-	<i>was</i>	-

Using this paradigm, all we appear to be able to determine is that a copied *wh*-pronoun must match a higher masculine *wh*-phrase in gender, as in (87).

(87) ***Copied wh-pronoun matches in gender:***

- a. \***Wen** glaubst du [<sub>CP</sub> **was** sie \_\_\_ gesehen hat]?  
**who** believe you **what** she seen has  
 ‘Who do you think she has seen?’

- b. **Wen** glaubst du [<sub>CP</sub> **wen** sie \_\_\_ gesehen hat]?  
**who** believe you **who** she seen has  
 ‘Who do you think she has seen?’  
 (German; Pankau 2013:59)

However, as Pankau shows, an interesting pattern emerges with complex *wh*-phrases. The agreement restriction in (87a–b) carries over to complex *wh*-phrases.

(88) *Copied wh-pronoun matches complex wh-phrase in gender:*

- a. \***Welchen** Mann glaubst du [<sub>CP</sub> **was** sie \_\_\_ gesehen hat]?  
**which man** believe you **what** she seen has  
 ‘Which man do you think she has seen?’  
 b. **Welchen Mann** glaubst du [<sub>CP</sub> **wen** sie \_\_\_ gesehen hat]?  
**which man** believe you **who** she seen has  
 ‘Which man do you think she has seen?’  
 (German; Pankau 2013:59)

The key observation is now that a conflict arises with complex *wh*-phrases that are overtly marked for feminine or plural. The copied *wh*-pronoun should agree in gender, but there is no agreeing pronoun in the paradigm in (86). The result is that *wh*-copying is obligatorily absent, as the examples in (89a–b) attest for extraction of a singular feminine.

(89) *Feminine complex wh-phrase prohibits wh-copying:*

- a. \***Welche Frau** glaubst du [<sub>CP</sub> **wen** er \_\_\_ eingeladen hat]?  
**which woman** believe you **who.MASC.ACC** he invited has  
 ‘Which woman do you think he has invited?’  
 b. \***Welche Frau** glaubst du [<sub>CP</sub> **was** er \_\_\_ eingeladen hat]?  
**which woman** believe you **who.NEUT.ACC** he invited has  
 ‘Which woman do you think he has invited?’  
 (German; Pankau 2013:63)

These facts suggest that *wh*-copying must involve matching in gender and plural, in addition to case, and that a gap arises as a result, just as in Dinka *ké*-copying. We can understand this gap if *wer* and *was* are not default forms, but specified for masculine and neuter, respectively. Then there would be no *wh*-pronominal that can spell out the *wh*-phrases in (89a–b) without a mismatch in gender features, leading to an absence of *wh*-copying.

We can find more evidence for the view that the ungrammaticality of (89a–b) follows from the requirement that copied *wh*-pronouns match in number and gender. Pankau observes that speakers who allow relative pronouns in *wh*-copying may employ these instead in these configurations (90a–b). Importantly, relative pronouns *do* come in feminine and plural forms, unlike the *wh*-pronouns.

(90) *Copied relative pronouns alleviate gender mismatch:*

- a. **Welche Frau** glaubst du [CP **die** er \_\_\_ eingeladen hat]?  
**which woman** believe you **who.FEM.SG** he invited has  
'Which woman do you think he has invited?'
- b. **Welche Frauen** glaubst du [CP **die** er \_\_\_ eingeladen hat]?  
**which women** believe you **who.PL** he invited has  
'Which women do you think he has invited?'
- (German; Pankau 2013:62)

In these contexts then, the gap disappears, because there are pronouns available that can express the number and gender of the relevant *wh*-copies.

There is a third gap that can appear with pronoun copying, in fact commonly found in *wh*-copying. Many researchers working on *wh*-copying have noted that, for many speakers, *wh*-copying is limited to *wh*-pronominals (e.g. Fanselow and Mahajan 2000:220–221; Felser 2004:550; Pankau 2013:46–47). Such speakers allow (91a), but disallow copying with complex *wh*-phrases (91b–c).

(91) *Some speakers only tolerate copying with pronouns:*

- a. **Wen** glaubst du [CP **wen** sie \_\_\_ liebt]?  
**who** believe.2SG you **who** she loves  
'Which man do you think she loves?'
- b. \***Welchen Mann** glaubst du [CP **wen** sie \_\_\_ eingeladen hat]?  
**which man** believe.2SG you **who** man she invited had  
'Which man do you think she has invited?'
- c. **Welchen Mann** glaubst du [CP dass sie \_\_\_ eingeladen hat]?  
**which man** believe.2SG you that man she invited had  
'Which man do you think she has invited?'
- (German; Pankau 2013:1,47)

Van Craenenbroeck and Van Koppen (2002) show that similar variation exists across dialects of Dutch with regard to subject doubling constructions. In the Wambeek variety discussed in 2.2, both complex and pronominal subjects can be doubled by a pronoun (92a–b).

(92) *Subject doubling with complex and pronominal subjects in Wambeek Dutch:*

- a. **Dei vrou** gui zij.  
**that woman** go **she**  
'That woman is going.'
- b. **Zij** gui zij.  
**she** go **she**  
'She is going.'
- (Wambeek Dutch; Van Craenenbroeck and Van Koppen 2002:56)

But in other Dutch dialects, such as the Lapscheure or Brabant dialect, only pronouns participate in copying and never complex DPs. Examples from the Brabant dialect in (93a–b) demonstrate.<sup>23</sup>

(93) *Subject doubling only with pronominal subjects in Brabant Dutch:*

a. \***Die vrou** komt **zij**.  
**that woman** comes **she**  
'That woman will come.'

b. **Zij** komt **zij**.  
**she** comes **she**  
'She will come.'

(Brabant Dutch; Van Craenenbroeck and Van Koppen 2002:56)

In these pronoun copying constructions then, a gap arises with complex *wh*-phrases. Multiple copy spell-out is only possible if both DPs are pronouns.

To sum up this section briefly, I discussed three cases of pronoun copying in which not all antecedents are able to trigger copying. In the next section, I use these effects and the person-number asymmetry highlighted in section 4.1 to argue for a partial spell-out view. I suggest that gaps arise because deletion need not leave behind a structure that can be spelled out as a pronoun. In the case of Dinka *ké*-copying, this is because the 3rd person singular pronouns spell out a larger structure. In the case of German *wh*-copying, the gap arises because there is no *wh*-pronoun specified for feminine or plural. Finally, for instances of pronoun copying which do not permit complex antecedents, I propose that all pronouns realize a larger structure than what is present in a DP copy, so that only antecedent pronouns themselves may participate in copying.

## 5 Pronoun copying as partial spell-out

In this section, I develop a partial spell-out approach to pronoun copying, which I will argue is capable of deriving pronoun copying and the asymmetries documented in section 4. My point of departure for this account is Dinka *ké*-copying, and the asymmetries and gaps associated with it. I start by investigating the expression of number across Dinka, which will motivate the idea that there is an asymmetry between the 3rd person singular and plural pronoun. This asymmetry will turn out to be responsible for most of the unusual properties associated with *ké*-copying. I then propose a model of copy deletion, adopting ideas by Landau (2006), that renders NP deletion obligatory in the context of multiple copy spell-out, forcing DPs to copy as pronouns. This NP deletion view can derive the asymmetries and gaps associated with pronoun copying. Finally, I examine the question of why *ké*-copying should be absent from the CP edge.

---

23. As Van Craenenbroeck and Van Koppen note, interesting differences emerge between the strong and weak pronouns in pronoun copying too. The copied pronoun is always strong, while dialects vary as to whether the antecedent can be. I hope that this variation could be made to follow from a partial spell-out approach like the one I outline in the rest of this chapter.

### 5.1 Plural marking in Dinka

The asymmetries and gaps associated with pronoun copying in Dinka provide direct insight into the mechanisms behind pronoun copying. As demonstrated in section 3 and 4, unlike in many other languages, pronoun copying in Dinka has a special relationship with plurality. Only plural noun phrases trigger a copied pronoun, never singular DPs (94a–b).

(94) ***Kê-copying is limited to plurals:***

- a. Yè kôc-kó [CP cíi Ból [vP ké t̥iɪj]]?  
 be **people-which** PRF.OV BOL.GEN 3PL see.NF  
 ‘Which people has Bol seen?’
- b. Yè ɲà [CP cíi Ból [vP (\*yé) t̥iɪj]]?  
 be **who** PRF.OV BOL.GEN 3SG see.NF  
 ‘Who has Bol seen?’

In addition, when the antecedent is a pronoun, only the plurality of the pronoun is expressed on the copied pronoun.

Because it manifests both a feature asymmetry and a gap, this pattern is a good test case for a theory of pronoun copying. In this section, I draw a parallel between the sensitivity of pronoun copying to number and the way plural is marked across paradigms in Dinka. In particular, I show that the same morpheme, *k(e)*, functions as plural inflection in a range of morphosyntactic environments. In contrast, although some paradigms have a regular way of marking singular, none of these have cross-paradigmatic uses. I argue that this provides insight into what is special about the 3rd person plural pronoun. To be precise, I propose that *k(e)* is a general spell-out of plural, unspecified for morphosyntactic context, so that we can maintain a view in which the 3rd person plural pronoun spells out only plural. Singular lacks such a morpheme and so I suggest that the insertion rules for the 3rd person singular pronoun all make reference to person. If partial spell-out removes all but the part of the copy that encodes number (i.e. the Num(ber) head), this view explains why only the third person plural pronoun can appear in copying configurations.

Let me first motivate the idea that *k(e)* is a general plural marker in Dinka, employed in a variety of paradigms. The first of these paradigms I also discussed in Chapter 4 (sec. 3.1). Recall that the second position verb/auxiliary comes with a prefix called the declarative or interrogative particle, which expresses  $\varphi$ -agreement with the nominal in Spec-CP, tense, and clause type. The paradigms of this particle are repeated in (95) and (96).

(95) ***Declarative particle:***

PRES	SG	PL
1st/2nd	∅-	∅-
3rd	à-	áa-

PAST	SG	PL
1st/2nd	é-	é- <u>kè</u> -
3rd	é-	áa- <u>kè</u> -

(96) *Interrogative particle:*

PRES	SG	PL
1st/2nd	∅-	∅-
3rd	∅-	∅-

PAST	SG	PL
1st/2nd	é-	é- <u>kè</u> -
3rd	é-	é- <u>kè</u> -

One of the regularities in this paradigm is that, in the past tense, plural is always expressed by the prefix *kè*, which comes after the past tense prefix. This is the only regular process of inflection marking number, though there are some irregular ways of distinguishing singular and plural, such as the contrast between *à-* and *áa-* in the declarative present.

The pronominal paradigms also provide evidence that *k(e)* is associated with plural in Dinka. In independent pronominals, plural is marked with a final *-k*, as highlighted in the paradigm for pronouns in the absolutive case in (97). This final consonant stands in opposition to the final *-n* found with singular pronouns.

(97) *Dinka pronouns (absolutive case):*

	SG	PL
1st	ɪŋɛɛn	wɔ̀ɔ̀ <u>k</u>
2nd	yɪ̃in	wéek
3rd	yèen	kéek

Although there is regular marking for singulars here, this final *-n* does not show up as singular marking in any other paradigm.

A similar pattern is found with pronominal possessors. These attach as enclitics to nouns. Although they do not regularly form singular and plural pronominals, they use *k(e)* as a regular spell-out for number agreement. Some examples of number agreement are given in (98a–b), where we see that these possessor enclitics have a different initial consonant depending on the number of the possessum.

(98) *Possessor clitics agree in number with possessum:*

- a. kitàam-dù  
book.cs-sg.2sg  
'your book'
- b. kítèɛp-kù  
books.cs-pl.2sg  
'your books'

This number inflection is regular. Possessor clitics take the prefix *d-* for singular nouns and *k-* for plural nouns. The full paradigm appears in (99).

(99) ***Pronominal possessor paradigm:***

	SG	PL
1SG	-diè	- <u>ci</u> è
2SG	-dù	- <u>kù</u>
3SG	-dè	- <u>kè</u>
1PL	-dà	- <u>ku</u> à
2PL	-duón	- <u>ku</u> ón
3PL	-dén	- <u>kén</u>

Again, we see that *k(e)* does work as a regular plural morpheme. The only apparent exception, the 1st person singular enclitic with plural agreement, *ciè*, is the result of a palatalization rule targeting *ki* sequences that is specific to the Bor dialect (in other dialects, such as Nyaarweng, this rule is not found and the enclitic is *-kiè*).

Dinka has a third pronominal paradigm, for subject clitics that attach to the second position verb or auxiliary. These pronominal clitics are used whenever a pronominal subject is not in clause-initial position (100a–b).

(100) ***Pronominal non-initial subjects are expressed by clitics:***

- a. Wóok nhìar pên.  
we love.sv town  
'We love the town.'
- b. Pên à-nhiéer Ból.  
town 3s-love.ov Bol.GEN  
'The town, Bol loves.'
- c. Pên à-nhiárkù.  
town 3s-love.1PL  
'The town, we love.'

As evident in the examples above, these clitics affect the second position verb/auxiliary in a number of ways (Andersen 1993). Subject clitics trigger allomorphy in the verb or auxiliary they attach to. The verb *nhiéer* in (100b), for example, becomes *nhíar* in (100c) when followed by the 1st person plural enclitic *-kù*. Singular clitics are even more complicated and marked solely by changes to the root. I will not cover this system in detail in here, but see Andersen (1993) for an extensive overview. Suffice it to say that there are number of phonological changes that create the resulting paradigms, but we can set aside most of these here. What is important for our purposes is that all the plural forms involve an enclitic with an initial *k-*. Several example paradigms of verbs in Dinka Bor illustrating this are given below.



(101) *Subject clitic paradigm for c̄aam ('eat'):*

	SG	PL
1st	c̄aam	c̄ám- <u>k̄ù</u>
2nd	c̄ám	c̄ám- <u>k̄è</u>
3rd	c̄èem	c̄ám- <u>k̄è</u>

(102) *Subject clitic paradigm for kuéen ('read'):*

	SG	PL
1st	kuéen	kuèn- <u>k̄ù</u>
2nd	kuén	kuèn- <u>k̄è</u>
3rd	kuéen	kuèn- <u>k̄è</u>

(103) *Subject clitic paradigm for ḡôor ('write'):*

	SG	PL
1st	ḡàar	ḡét- <u>k̄ù</u>
2nd	ḡar	ḡét- <u>k̄è</u>
3rd	ḡéer	ḡét- <u>k̄è</u>

(104) *Subject clitic paradigm for pīiŋ ('hear/listen'):*

	SG	PL
1st	pīèeŋ	pīiŋ- <u>k̄ù</u>
2nd	pīiŋ	pīéiŋ- <u>k̄è</u>
3rd	pīiŋ	pīiŋ- <u>k̄è</u>

In these paradigms, we can see that, as mentioned above, the singular forms are marked only by changes in the verb root, either in tone, vowel length, or vowel quality. The plural forms may also be marked by such alternations (see Andersen 1993), but also always involve a regular process of plural marking using an enclitic starting with a *k-*.

Another set of items with plural and singular inflection are Dinka's enclitic demonstratives. Dinka has distal, proximal, and *wh*-demonstratives. Like the possessors, these inflect for the number of the noun. There is no consistent way of marking singular across these forms, but the plural is always formed by adding an initial *k-* to the singular base (105).

(105) *Dinka demonstratives:*

	SG	PL
WH	-ò	- <u>kò</u>
PROX	-è	- <u>kè</u>
DIST	-tì	- <u>kuì</u>

There is good evidence then that *k(e)* functions as a general spell-out of plural in Dinka. None of the five paradigms described here mark singular in the same way. Not all of them even have

regular singular inflection. In contrast, plural consistently uses the same inflection. There is no regular marking for plural in any of these paradigms that does not involve *k(e)*.

It is important to note that, outside of these paradigms, there are instances in which plural is not marked by *k(e)*. In the examples presented above, we can already see this in the present tense paradigm of the declarative particle and in the possessor clitics. The present tense declarative paradigm, for instance, marks the opposition between 3rd person singular and plural by a change in vowel length and in tone (*à* vs. *áa*). A much bigger pool of variation is found with Dinka nouns, which have been claimed to only have irregular plural marking (Ladd et al. 2009; Andersen 2014). Almost all Dinka nouns pluralize by changes to the root, either in tone, length, voice, or vowel quality. Some example pairs for a number of nouns are given in (106).

(106) ***Dinka noun pairs:***

SG	PL	Meaning
nhòm	nhìim	'head'
kitáap	kitéep	'book'
páal	pěeel	'knife'
riḵou	riḵp	'nail'
ciin	cìn	'hand'
kèr	kéet	'shoulder'
nyáaŋ	nyiëeŋ	'crocodile'

As these pairs show, plural is marked in a large variety of ways. In detailed studies of Dinka plurals, Ladd et al. (2009) and Andersen (2014) conclude that the number of a noun cannot be deduced from its phonological form. Whether this conclusion is right does not matter for our purposes, but it is worth noting that it could mean that *k(e)* represents the only regular form of plural inflection in Dinka.

We have seen so far that *k(e)* is used in a number of different paradigms to encode plural. On the basis of this, I propose that *k(e)* is the default spell-out of the feature [plural] in Dinka, unspecified for morphosyntactic context (107).

(107) ***A spell-out rule for plural:***

[plural] → *k(e)*

In contrast, singular does not have any overt cross-paradigmatic marking. I propose that this is because it lacks an elsewhere form, so that it has the (partial) set of spell-out rules in (108).<sup>24</sup>

(108) ***Spell-out rules for singular:***

[singular] → *d-* / \_\_\_ possessor clitic

[singular] → *-n* / pronoun \_\_\_

24. An alternative to (108) would be to say that there is a null elsewhere form for singular. This would also work for the proposal that I will develop.

With this understanding of number in place, we can link the asymmetry between singular and plural evident in (107) and (108) to the asymmetry in *ké*-copying. I suggest that the 3rd person plural pronoun *ké(ek)* is also derived by the rule in (107). In other words, I propose that, unlike the other pronouns, the 3rd person plural pronoun is the spell-out only of a number feature.<sup>25</sup> This results in an asymmetry in the pronoun inventory that mirrors the asymmetry between singular and plural across the language. The pronoun paradigm is repeated in (109).

(109) *Dinka pronouns (unmarked case):*

	SG	PL
1st	uŋɛn	wɔk
2nd	yɪn	wêek
3rd	yêen	kêek

A set of spell-out rules compatible with the idea outlined above is given in (110).<sup>26</sup>

(110) *Suggested spell-out rules for Dinka pronouns:*

- [1] → uŋɛ
- [1] → wɔ / \_\_\_\_ [plural]
- [2] → yɪ
- [2] → we / \_\_\_\_ [plural]
- [3] → ye / \_\_\_\_ [singular]
- [3] → ∅
- [plural] → k(e)
- [singular] → -n / [person] \_\_\_\_

These rules capture the asymmetry I posit between the 3rd person plural pronoun and the 3rd person singular. The pronoun *ké(ek)* is the only one in the paradigm that spells out number in isolation (its person component is null). In contrast, all the other pronouns consist of an overt person and number affix, where the person morphemes in isolation may also serve as the reduced pronouns. The singular component of pronouns always references person (and has no elsewhere form), where the 3rd person plural pronoun represents the elsewhere form for plural.

Another way of encoding this asymmetry between the 3rd person singular and the 3rd person plural pronoun is to make use of the nanosyntactic notion that morphemes may spell out phrases (e.g. Starke 2010). Under such a view, we could take the 3rd person plural pronoun to realize just

25. There are at least two ways of deriving the full form *kêek* that are compatible with this. The simplest way is probably to say that it is a phonologically-conditioned allomorph of [plural], which ends up suppressed in other paradigms because of constraints on the size of the affixal or clitic material. An alternative is to take seriously the apparent doubling of plural marking and propose that the full form of a pronoun obeys a CVVC template, which triggers copy epenthesis. As Andersen (1993) shows, Dinka does place restrictions of this type on some lexical categories. Lexical verbs, for example, must have a coda and their base form (the non-finite form) cannot have a short vowel.

26. The tones represent case and I assume come from the spell-out rules for case morphology. It is also possible that the absolutive contour is underlying or default, particularly if unmarked case is taken to reflect the absence of case.

a Number phrase, while other pronouns realize a larger structure, including person information. This yields equivalent results, as far as I can tell.

This view of Dinka pronouns derives the properties of *ké*-copying if we assume that pronoun copying in Dinka realizes only number. Because only *ké(ek)* spells out number alone, it is the only pronoun capable of surfacing in copying. This creates the gap with singular DPs and leads to a feature mismatch with 1st and 2nd person pronouns. In the next section, I turn to the question of what forces partial deletion and what is responsible for the fact that Dinka deletes all but the part of the DP that encodes number in intermediate copies.

## 5.2 Why DPs copy as pronouns

Much recent work proposes that number is encoded by a dedicated Num(ber) head in the extended nominal projection (e.g. Abney 1987; Carstens 1991; Ritter 1991; Déchaine and Wiltschko 2002; Kramer 2009, and many others). In this view, DPs consist at least of the structure in (111).<sup>27</sup>

### (111) Structure of DPs:

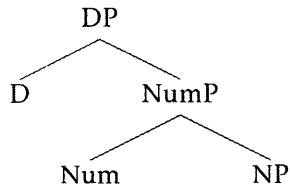

Following Moskal (to appear), I adopt an analogous structure for pronouns, replacing the NP with a (functional) head that encodes person. In this view, the core of a pronoun is a phrase that encodes person, which I call PersP.<sup>28</sup> PersP merges with the same extended projection as NP (112).

### (112) Structure of pronouns:

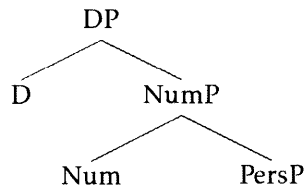

Importantly, this structure puts the locus of number above person. This is motivated by the observation that, when pronouns can be decomposed into person and number, number affixes come between person and case affixes.<sup>29</sup> In Turkish, for instance, the plural suffix *-lar/-ler* is used

27. We may additionally posit a K head above D (e.g. Lamontagne and Travis 1987; Bittner 1994; Bittner and Hale 1996a,b; Levin 2015).

28. See Gruber 2013 for an explicit proposal of what the internal structure and semantic content of such a PersP might be.

29. This is reminiscent of Greenberg's (1963:95) Universal 39:

(i) **Greenberg's Universal 39:**

Where morphemes of both number and case are present and both follow or both precede the noun base, the expression of number always comes between the noun base and the expression of case.

to form the 3rd person plural pronoun and comes between the suppletive 3rd person form *on* and case suffixes (113a). A similar pattern is found in Kayardild (113b).

(113) *Number suffixes on pronouns come before case and after person:*

- a. on-lar-ı  
3PL-PL-ACC  
'them'  
(Turkish)
- b. ŋa-l-da  
1-PL-NOM  
'we'  
(Kayardild; Evans 1995:202)

Assuming these structures are correct for DP and pronouns, suppose that pronoun copying is the result of NP deletion. In a copy of a lexical DP, the structure that is left behind consists of D, and Num (114).

(114) *Structure of DPs with deletion:*

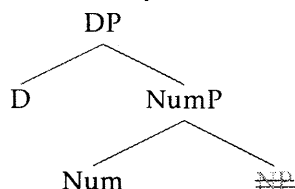

Because these heads are all presents in pronouns also, as evident in (113), the resulting structure can be spelled out as a pronoun. This yields pronoun copying, as long as there are pronouns that are capable of spelling out just D and Num, as I will claim.

I first focus on the question of why deletion of NP should be obligatory. The point of departure for my proposal comes from Landau's (2006) treatment of verb copying in Hebrew, which provides an explicit set of constraints on copy deletion that can deliver multiple spell-out. Landau is concerned with cases such as (115), in which fronting of the verb requires two instances of the verb be spelled out.

(115) *Verb copying in Hebrew:*

- lirkod**, Gil lo **yirkod** ba-xayim.
- dance.INF** Gil not **will-dance** in-the-life
- 'As for dancing, Gil will never dance.'
- (Hebrew; Landau 2006:1)

As mentioned in the introduction, such verb copying constructions are commonly found with instances of verb fronting. To derive the existence of such patterns, Landau proposes the principles

of P-recoverability and Economy of Pronunciation, defined in in (116) and (117), to constrain pronunciation of copies.

(116) ***P-Recoverability:***

In a chain  $\langle X_1, \dots X_i, \dots X_n \rangle$ , where some  $X_k$  is associated with phonetic content,  $X_k$  must be pronounced.

(Landau 2006:31)

(117) ***Economy of Pronunciation:***

Delete all chain copies at PF up to P-recoverability.

(Landau 2006:30)

Taken together, these two principles force deletion of all copies except for one in most instances. P-Recoverability is satisfied once one copy is fully spelled out. At that point, Economy of Pronunciation will force deletion of all other copies. However, P-Recoverability allows for situations of multiple copy spell-out by means of the notion of “association with phonetic content”, Landau’s definition of which is given in (118).

(118) *X is associated with phonetic content iff:*

- a. X has phonetic content, or
- b. X is in a position specified with some phonological requirement

(Landau 2006:31)

The clause in (118b) allows for copies that reside in particular syntactic positions to resist deletion even when they have no unique phonetic content, if that position comes with a unique phonological requirement. In the case of verb copying, Landau suggests that the lowest copy of the verb must be realized to satisfy the phonological requirement that tense morphology needs to be hosted on the verb. He proposes that one of the copies of the verb is in T and is subject to the Stray Affix Filter. As a result, so P-Recoverability is only satisfied if this copy is spelled out rather than deleted.<sup>30</sup>

I adopt Landau’s principles here and suggest that the various factors driving pronoun copying can be thought of phonological requirements in the sense of (118). We can think of pronoun copying driven by cliticization, as in clitic doubling constructions or some cases of resumption, in this way, for example. In particular, I posit that cliticization reflects the need of a functional head to undergo morphological merger with a clitic (e.g. Harizanov 2014). In addition, I propose that the EPP property of Spec-TP as well as the V2 property of  $v/C$  in V2 languages may function as a phonological requirement in the sense of (118).<sup>31</sup> These properties can then yield multiple copy spell-out under Landau’s P-Recoverability principle.

---

30. It is also necessary for there to be a phonological requirement associated with the higher copy, because otherwise Economy of Pronunciation will deliver covert movement.

31. One way to make this more concrete could be to adopt a phonological view of the EPP (Richards 2001; Boeckx 2003; Richards, to appear). Richards (to appear), for instance, argues that the EPP reduces to something like the Stray Affix Filter.

Multiple copy spell-out of DPs diverges from verb copying in an important respect, however. In the case of verb copying, the copies under consideration are heads, if potentially complex ones, and not phrases. As a result, in order to satisfy a phonological requirement in the sense of (118), multiple copy spell-out needs to involve all of the relevant copies (assuming that complex heads act as a unit for spell-out). An interesting possibility emerges when multiple copy spell-out targets a multi-word phrase, such as a complex DP. In principle, Economy of Pronunciation should be able to delete some of the material in a phrasal copy, as long as it leaves a prosodic unit capable of satisfying the phonological requirement driving multiple copy spell-out. In fact, Economy of Pronunciation should render this obligatory, because it deletes as much material as possible, and so should limit multiple copy spell-out of a phrasal constituent to a “minimal” one, or a single prosodic word.<sup>32</sup> It is this difference between heads and phrases that I will hold responsible for the asymmetry between nouns and verbs that is apparent when we compare verb copying and pronoun copying: verbs copy as verbs, but DPs copy as pronouns. I suggest that what unifies these is that they represent the most minimal form a verb or DP can take in compliance with Economy of Pronunciation.

Support for this view of the difference between verb copying and pronoun copying comes from the prediction that we should see noun copying if it is possible to move a noun out of a more complex DP by itself. Trinh (2011) argues that this happens in Vietnamese. To be precise, Trinh shows that, in Vietnamese, a noun can be topicalized while stranding the rest of the DP, including numerals and classifiers. In such instances, the lower copy of the noun may undergo multiple copy spell-out (119a–b).

(119) *Noun copying in Vietnamese:*

- a. **ban** thi no se gap [<sub>DP</sub> hai nguoi **ban** cua John]  
**friend** TOP he will meet two CLASS **friend** of John  
 ‘Friend, he will meet two friends of John.’
- b. **vo** thi no se gap [<sub>DP</sub> hai nguoi **vo** cua John]  
**wife** TOP he will meet two CLASS **wife** of John  
 ‘Wife, he will meet two wives of John.’  
 (Vietnamese; Trinh 2011:80)

This is evidence that nothing in principle rules out noun copying and further support for the idea that pronoun copying occurs specifically with phrasal movement.<sup>33</sup>

32. The proposal that copy deletion aims to delete as much as possible seems similar to the idea that ellipsis is constrained by MaxElide (Takahashi and Fox 2005; Merchant 2008; Hartman 2011). If constraints on ellipsis correspond closely to constraints on deletion, as Landau (2006) suggests, Economy of Pronunciation and MaxElide could perhaps be viewed as the same constraint, modulo the role of Parallelism domains.

33. Similarly, multiple copy spell-out in the context of movement of a verb phrase should result in subdeletion of one of the copies. This configuration could be represented by instances of *vP*-movement that involve verb copying, like the Polish example in (i):

Let me turn now to the question of why pronouns are the most minimal form of DPs. For verb copying, it is clear why the verb is the most minimal realization multiple copy spell-out can enforce. It is not so obvious, however, why a pronoun should necessarily constitute the most minimal form of a DP copy, however. For a DP like *the book*, for example, we might imagine that there are at least the two deletion options schematized in (120).

- (120) **Spell-out options for the book:**  
 a. ~~the~~ **book**  
 b. **it** ~~book~~

I suggest that an important difference between the deletion options in (120a–b) is that the deletion operation in (120b), NP deletion, is independently found in NP ellipsis.<sup>34</sup> In addition, Elbourne (2001, 2005) proposes that (120b) corresponds essentially to the representation of E-type pronouns. If this is correct, then NP deletion differs from the deletion configuration in (120a) in being used elsewhere in the grammar. Suppose then that the deletion operations available for subdeletion correspond closely to the deletion/ellipsis operations employed elsewhere (see also Landau 2006 for this suggestion, and Chomsky 1995:202). Because there is no process of D-ellipsis, the deletion option in (120a) cannot be considered. As a result, the only way in which a DP copy can be reduced under pressure from Economy of Pronunciation is by means of NP deletion.

I draw a distinction between constraints on subdeletion and deletion of full copies. More specifically, I suggest that the above holds only of subdeletion and does not prevent *full* deletion of a copy in a movement chain. This is necessary, for example, to deal with deletion in chains established by head movement. If heads are not independently deletable, then copies left by head movement should often trigger multiple copy spell-out, for example in V-to-T movement. There is no process of V-ellipsis to allow for deletion of V in V-to-T movement. In this view, the set of available deletion operations consists of *full copy deletion* in addition to ellipsis operations (121).

- (121) **Available deletion operations:**  
 1. Full copy deletion  
 2. Ellipsis operations

---

(i) **Polish vP-fronting accompanied by verb copying:**  
 Kupić kwiaty (to) Maria kupiła, ale nie kupiła prezentu.  
 to.buy flowers PRT Mary bought but not she.bought present  
 ‘As for buying flowers, Mary bought them, but she didn’t buy a present.’  
 (Polish: Bondaruk 2009:65)

34. Another potential way of distinguishing the two options in (120a–b) is to appeal to the idea that deletion prefers to target maximal projection rather than heads. Deletion in (120a) must involve deletion only of the D head (because deleting DP would also delete the rest of the copy). In contrast, (120b) corresponds to deletion of a maximal projection and so could be said to delete more. Note that we cannot outright ban deletion of heads without deletion of the maximal projection, because we need it for copy deletion in chains left by head movement.



This distinction will allow for deletion of copies left by head movement, even when there is no corresponding ellipsis operations. For DP copies, this means that there are two relevant deletion operations, full deletion and NP deletion (122).

(122) *Available deletion operations for DP copies:*

1. DP deletion
2. NP deletion

These options correspond exactly to the two options for DP chains I have argued for here: single copy spell-out and multiple copy spell-out with secondary copies realized as pronouns. We then have an explanation for the asymmetry verbs and nouns display in the context of multiple copy spell-out. DP deletion is not an option in such cases, because it would leave unsatisfied the phonological requirement responsible for multiple spell-out. Unlike with verbs, however, there is a permissible operation of subdeletion, NP deletion. The application of NP deletion is forced by Economy of Pronunciation, since the resulting phrase is still capable of satisfying P-Recoverability. As a result, multiple copy spell-out in the context of DP movement necessarily yields a pronoun.

Assuming subdeletion to be limited to phrases in this way, I will now show that this NP deletion view can explain the properties of pronoun copying that I described in section 4. I will start by demonstrating how it accounts for the gaps and asymmetries found with *ké*-copying in Dinka and then turn to how it captures variation in pronoun copying across languages.

### 5.3 *Partial spell-out, asymmetries, and gaps*

The previous section motivated the idea that DPs that undergo multiple copy spell-out must undergo NP deletion. I will now argue that this view is able to derive all the key properties of pronoun copying. I start by showing how NP deletion derives the existence of gaps. If partial spell-out involves NP deletion in the structures outlined above, we expect to find gaps in those cases where there is no relevant pronoun that only spells out number (Dinka *ké*-copying) and when there is no suitable pronoun that can match the features of the structure left by deletion (German *wh*-copying and pronoun-only copying). I extend this approach to the person-number asymmetry documented in section 4.1 by claiming that PersP may be deleted in the same way as an NP in some languages. In contrast, NumP is never deleted, and so copied pronouns always match in number.

I demonstrate the basics of a partial spell-out approach by showing how NP deletion explains the gap found with *ké*-copying. I posit that a plural DP copy left by movement to the *v*P edge is associated with a phonological requirement that something be spelled out (courtesy of the V2 property of *v*). Because of Economy of Pronunciation, NP deletion obligatorily applies (123).

(123) *Structure of plural DP copy with NP deletion:*

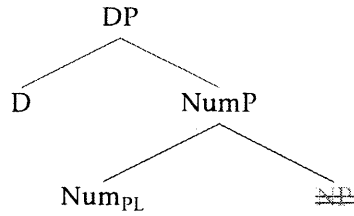

The remaining structure is shared with pronouns, with the exception of the PersP at the core of a pronoun. As a result, the structure in (123) can be spelled out as a pronoun as long as there are pronouns that only realize D+Num structure. Because the Dinka insertion rules for the 3rd person plural pronoun *ké* reference only a plural Number head, this condition is met and (123) can be spelled out as *ké(ek)* (124).

(124) *Structure of plural DP copy with NP deletion:*

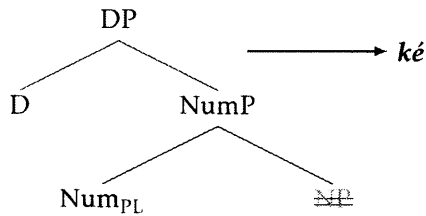

We can also understand why *ké*-copying does not care about the complexity of the DP antecedent. One of the properties of *ké*-copying is that it behaves the same way regardless of whether the antecedent is itself of a pronoun or a complex DP. I propose that all of the dependents of the noun, including arguments and adjectives, are merged below the functional layer of a DP.<sup>35</sup> As a result, NP deletion removes all this material. A simplex DP, as in (124), then yields the same structure as a DP with a more internal structure, for example one with a PP argument (125).

(125) *Structure of complex DP copy with NP deletion:*

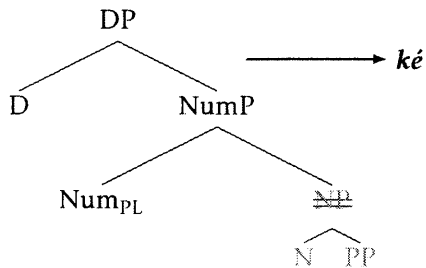

In addition, this proposal explains the absence of pronoun copying with singular DPs. NP deletion applies to a singular copy as well, leaving D and a singular Num, as represented in (126).

35. Another option is that subdeletion applies to such material, since it is never necessary to satisfy the phonological requirement associated with multiple copy spell-out. If so, the constraints on subdeletion must make this possible.

(126) **Structure of singular DP copy with NP deletion:**

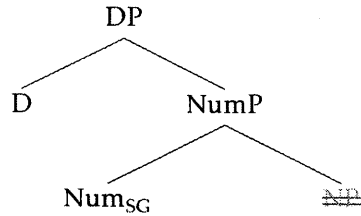

The insertion rules I posited for Dinka pronouns, however, cannot create a pronoun from this structure. The relevant rules are repeated in (127).

(127) **Relevant spell-out rules for 3rd person singular pronoun:**

- [3] → *ye* / \_\_\_\_ [singular]  
 [singular] → *-n* / [person] \_\_\_\_

Both insertion rules that create the 3rd person singular pronoun *yéen* make explicit reference to person. Because there is no projection that encodes person in (126), no pronoun can be created from this structure. There is no general (overt) spell-out for singular in Dinka in the way that there is for plural and so the structure in (126) can only receive a null spell-out.

It is important here that copy deletion rules are myopic in this respect. In order for gaps in pronoun copying to be admissible, it is crucial that the attempt to spell out the structure in (126) still satisfies the phonological requirement imposed by V2, even though no overt form results. Note, however, that this conclusion is presumably generally necessary for V2 in Dinka, given that V2 can be satisfied by *pro*-drop (specifically, by *pro*-drop of 3rd person pronouns in Spec-CP). See Richards (2015) for a similar kind of blindness in the mapping from syntax-to-PF.

Although not necessarily as morphologically obvious as in Dinka, I propose that, in languages that lack the singular gap, all 3rd person pronouns spell out only the Number head. This is what differentiates a language like Nupe or Finnish from Dinka. I posit that Nupe *u:* and Finnish *se*, for instance, come about by means of an insertion rule of the form in (128).<sup>36</sup>

(128) **Spell-out rules for 3rd person singular pronouns in Nupe and Finnish:**

- [singular] → *u:*  
 [singular] → *se*

As a result, pronoun copying is possible with singular as well as with plural DP copies and no gap is found.<sup>37</sup>

36. We can capture the variation for speakers of Finnish when it comes to plural pronouns by allowing variation in whether the 3rd person plural pronoun spells out only number or both person and number.

37. Another option for treating the difference between Dinka and other pronoun copying languages is to allow for 3rd person to reside in D. Dinka lacks indefinite and definite determiners and so could be viewed as a language without an overt D. If D is where 3rd person is encoded in the usual case, this could help explain why the Dinka pattern is so uncommon. (Although it is worth noting that at least Nupe also lacks articles.)

This approach can be extended to the gap found with feminine and plural *wh*-phrases in German *wh*-copying. In this case, NP deletion leaves behind Num and D, as well as projections encoding *Wh* and gender. Because there is no suitable *wh*-pronoun that matches all of these features, no pronoun can be created from the resulting structure and a null spell-out results.<sup>38</sup> In addition to this, we can derive the fact that pronoun copying may sometimes only be possible when realizing a copy of another pronoun, as for some speakers of languages with *wh*-copying and subject doubling in dialects of Dutch. For these grammars, I propose that the spell-out rules for all pronouns require reference to the PersP at the core of pronouns but absent in DPs. As a result, a copied pronoun can never be created out of copies of lexical DPs, but only out of copies of pronouns. This gap then reflects the fact that the structure I have posited depart slightly from the idea that pronouns realize the functional layer of a DP. This is almost true in my treatment of pronouns, except they realize one additional projection, PersP. It is this difference that can prevent pronoun copying with lexical DPs.

Now I turn to the issue of how this approach to pronoun copying captures the asymmetry between person and number evident in Dinka *ké*-copying and in a number of other languages. Recall that languages vary in whether copied pronouns match pronouns in person as well as number, but or just in number. We can capture this by allowing the core of a pronoun, PersP, to be deleted optionally as well.

In the structure of pronouns defended above, pronouns consist at their core of a phrase that encodes person (Moskal, to appear), as in (129).

(129) *Structure of pronouns:*

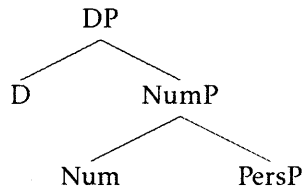

Suppose that languages vary as to the categorial status of PersP. I propose that, in (129), Person is a functional projection, analogous to Number, so that pronouns simply lack an NP component. However, suppose that the person part of a pronoun can also be treated as an NP. I will refer to this kind of person projection as NP<sub>PERS</sub>, as in (130).

---

38. One question that arises here is whether we should expect to find a plain feminine or plural pronoun in these constructions instead. There are a couple of options for ruling this out. We could stipulate that the insertion rules for German pronouns make reference to PersP, therefore banning them from pronoun copying configurations in general. Another option is that *wh*-copying requires the realization of operator morphology, for example if we take to need to realize this morphology to function as the phonological requirement in the sense of Landau's (2006) P-Recoverability.

(130) *Structure of pronouns with NP<sub>PERS</sub>:*

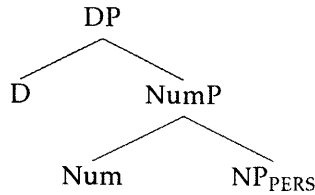

I suggest that, in a language in which (130) is the structure of a pronoun, NP deletion applies in pronouns too. As a result, only the NumP component of a pronoun survives in multiple copy spell-out, yielding an absence of person features (131).

(131) *Structure of pronoun with PersP deletion:*

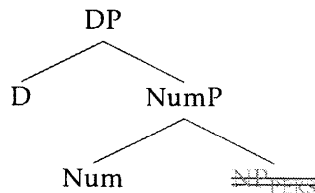

This means that pronouns will behave like nouns for the purposes of pronoun copying. In Dinka, this means that they will trigger *ké*-copying if plural and no copying if singular. In a language like Nupe or Finnish, the result is an absence of person matching across the board. If person is encoded in a functional projection (PersP), no NP deletion occurs and copied pronouns express all the features of the pronominal copy. I take this to be the case in Seereer, Yoruba, and languages with clitic doubling like Greek and Bulgarian. In this way, the view that pronoun copying results from NP deletion explains the existence of asymmetries and gaps in many such patterns.

One question is whether we can find independent differences between pronouns in these languages that support the PersP/NP<sub>PERS</sub> distinction I posit. I want to suggest that suppletion patterns might be one such difference. Moskal (to appear) shows that pronouns and nouns differ crosslinguistically in the suppletion patterns they allow. Pronouns commonly supplete both for plural and case, as in the Latvian examples in (132).

(132) *Latvian pronouns supplete for plural and case:*

<b>1st</b>	SG	PL
NOM	es	mēs
DAT/ACC	man/mani	mums/mūs
<b>2nd</b>	SG	PL
NOM	tu	jūs
DAT/ACC	tev/tevi	jums/jūs

(Mathaissen 1997, cited in Moskal, to appear:2)

In contrast, nouns supplete only for number for the most part. In Dinka, for example, the plurals for *mòc* ('man') and *tiik* ('woman') are suppletive (133).

(133) *Dinka nouns may supplete for number:*

SG	PL	
mòc	ròòor	'man'
tiik	diàar	'woman'

Moskal (to appear) presents an account of this difference between pronouns and lexical DPs that makes crucial use of the idea that PersP is a functional head. To be precise, she proposes that an NP is formed by merging *n* with a noun root, while PersP is just a functional head which is not categorized by *n*. Because *n* is assumed to be a phase head, Case features end up not sufficiently local to the NP root to trigger suppletion (see also Embick 2010, Bobaljik 2012).

In the context of the variation I posited above in how person is encoded in pronouns, this makes the prediction that, in NP<sub>PERS</sub> languages, pronouns should behave like nouns with regard to suppletion. In other words, pronouns should fail to supplete for case. This prediction seems to be borne out at least in the sample of languages considered here. In Dinka, pronouns only supplete for number and, like other nouns, mark case only by differences in tonal contour. Nupe lacks case marking and so vacuously satisfies this prediction. Finnish is also compatible with this prediction, because its pronouns are non-suppletive, as evident in the paradigms for 1st and 2nd person pronouns given in (134).

(134) *Finnish pronouns do not supplete for case:*

	1sg	2sg
NOM	minä	sinä
GEN	minu-n	sinu-n
ACC	minu-t	sinu-t
PART	minu-a	sinu-a
ADESS	minu-lla	sinu-lla
ILLAT	minu-un	sinu-un

(Eliseev 1993:100)

In contrast, there is suppletion for case with both Greek and Bulgarian pronouns, although Seereer and Yoruba both also lack case. Suppletion could then potentially serve as an independent diagnostic for the PersP/NP<sub>PERS</sub> distinction proposed above.<sup>39</sup>

To sum up briefly, I argued that partial spell-out derives the key properties of pronoun copying, in a way that makes sense of its distribution and the asymmetries and gaps that accompany it. The analysis defended here crucially requires that movement leave copies with internal structure, as in the Copy Theory of Movement (Chomsky 1995 et seq.) and that number and person are introduced

39. We might also expect this distinction to correlate with the admissibility of DPs like *us linguists*, for which it has been suggested that the pronoun is serving as a determiner. Dinka, however, appears to allow such constructions.

in separate functional projection in the DP (e.g. Carstens 1991; Ritter 1991; Kramer 2009, and others). Pronoun copying then provides a novel source of evidence for these approaches.

#### 5.4 On the absence of copying at Spec-CP

Before concluding this chapter, I will examine the question of why pronoun copying is absent at the CP edge. *Ké*-copying offers evidence for successive-cyclic movement through the *vP* edge, just as *wh*-copying and pronoun copying in Seereer offer evidence for successive-cyclic movement to the edge of CP. One question that arises from the perspective of successive cyclicity is whether we should expect to find languages in which there is pronoun copying both at the CP edge and the *vP* edge. This issue is particularly relevant for Dinka, in which CP and *vP* show highly parallel behavior. If the V2 property of *v* is responsible for *ké*-copying, the V2 property of C might be expected to have the same effect. However, *ké*-copying in Spec-CP is ungrammatical (135).

(135) *No ké-copying at Spec-CP:*

Yè kòɔc-kò [CP yùukù ké luèeel [CP è (\*ké) càṃ cuṣin]]?  
 be people-which HAB.1PL 3PL say.NF C 3PL eat.sv food  
 ‘Which people do we say are eating food?’

In this section, I suggest that the absence of *ké*-copying at C is caused by the fact that C hosts  $\varphi$ -agreement with the nominal that moves through its edge. This is an independent difference between C and *v*. I propose that this  $\varphi$ -agreement prefix may serve to satisfy the phonological requirement associated with the V2 property of C, in the same way that *ké*-copying satisfies it for *v*. In support, I point out that the distribution of the subject resumption is also tied to  $\varphi$ -agreement.

As described in Chapter 4 and 5, C hosts  $\varphi$ -agreement with the nominal that moves to it. We find this both with final and intermediate steps of successive-cyclic movement, as evident in the examples of long-distance relativization and topicalization in (136a–b).

(136)  *$\varphi$ -agreement at C with terminal and intermediate movement:*

- a. Yè kòɔc-kò [CP Op é-kè-yá ké tàak [CP è \_\_\_ é-kè-cíi  
 be people.cs1-which PST-PL-HAB.2SG 3PL think.NF C PST-PL-PRF.OV  
 Áyèn ké gâam gàlàṃ]]?  
 Ayen.GEN 3PL give.NF pen  
 ‘Which people did (s)he think that Ayen had given a pen to?’
- b. Ròoor áa-yùukù ké tàak [CP \_\_\_ é-kè-cíi Áyèn ké t̩iŋ].  
 men 3P-HAB.1PL 3PL think.NF PST-PL-PRF.OV Ayen.GEN 3PL see.NF  
 ‘The men, we think Ayen has seen.’

The presence of this agreement is an independent difference between the edge of the clause and the edge of the verb phrase, where no overt agreement is ever found. I suggest then that this  $\varphi$ -agreement prefix can serve to satisfy the phonological requirement imposed by the V2

property of an intermediate C in the same way that *ké*-copying does at *v*. Importantly, it is just the presence of a prefix that has to satisfy V2 here, because the actual form of the prefix is often null (as in the present tense in (136)). In support of the idea that  $\varphi$ -agreement interacts with an EPP or V2 property in this fashion, it is worth considering the parallel between Dinka pronoun copying and the Nupe, Vata, and Swedish subject resumption pattern discussed previously. In all three languages, a resumptive pronoun must appear in subject position with certain instances of extraction. If this is caused by the EPP property of Spec-TP, we can take these patterns to be driven by a similar phonological requirement as *ké*-copying. Observe that all three languages lack subject-verb agreement. This makes sense if pronoun copying is only necessary when  $\varphi$ -agreement cannot satisfy the EPP requirement of a functional head.

The above discussion suggests that there are likely Dinka-internal reasons why *ké*-copying is only necessary at the CP edge. However, it is worth noting that we have not seen any reason to think it is not possible for a language to display multiple copy spell-out at both the CP and *v*P edge. At the same time, in the model of multiple copy spell-out advocated here, we can see why such a system would be rare. Such a system is only possible if both the CP and *v*P edge display something like the EPP property, and such languages are not at all common. It should be clear, for instance, why we do not expect to find pronoun copying at the edge of the verb phrase in a language like Seereer or German: neither has an obvious EPP position at the edge of *v*P.

## 6 Summary

In this chapter, I suggested that pronoun copying is the counterpart to verb copying for movement of DPs, based on Dinka *ké*-copying as well as a variety of other pronoun copying constructions. I demonstrated that pronoun copying tolerates asymmetries and gaps, which I argued implicate a partial spell-out approach. If correct, this analysis constitutes an argument in favor of the Copy Theory of Movement (Chomsky 1995 et seq.), because it requires DP copies to have an articulated internal structure. Also, *ké*-copying functions as an additional piece of evidence for successive-cyclic derivations, because it provides evidence for a step of intermediate movement through the *v*P edge (Chomsky 1986 et seq.). In addition, the approach to pronoun copying defended here shows that person and number are introduced in separate projections within a DP, because they can be separated in copying constructions. Within the context of this dissertation, these facts offer further evidence that phrasal movement has a uniform syntax. We saw in this chapter that pronoun copying is found with A-movement as well as  $\bar{A}$ -movement and also as a reflex of intermediate movement steps. This serves as an argument that all three movement types employ the same mechanism of Merge, as well as Agree.

One issue that I have not explored is the potential connection between the view of pronoun copying developed here and the proposal that copies may resemble pronouns in some respects (e.g. Postal 1998; Van Koppen 2005; Takahashi and Hulsey 2009). One challenge for treating copies as pronouns is that material in the NP may undergo reconstruction to positions marked by copied



pronouns, as with anaphors in Dinka, for instance. But, as I have pointed out, in a partial spell-out view, copies end up looking much like E-type pronouns (Elbourne 2001, 2005). The data described here then also fit well with the proposal that copies are interpreted as definite descriptions, as in Trace Conversion and related approaches (e.g. Fox 1999; Takahashi and Hulsey 2009; Johnson 2012). This could explain why copied pronouns appear insensitive to quantificational aspects of the full DP copy, such as whether it is indefinite or D-linked.<sup>40</sup>

In any case, I hope to have shown in this chapter that pronoun copying is one of the ways in which a DP copy may be realized. If this is on the right track, then the syntax of gaps is not as opaque as sometimes thought. As with verb copying, the internal structure of gaps becomes transparent in a range of syntactic contexts and offers direct insight into the structure of DPs, providing evidence that all displacement of DPs involves Merge and the formation of copies with an articulated internal structure.

---

40. Configurations in which a plain pronoun realize a higher copy, as in some instances of subject doubling and in clitic doubling, could be challenging under this view. However, it is worth noting that these are all plausibly instances of A-movement. Perhaps these movements are all followed by a covert step of QR.



## CHAPTER SEVEN CONCLUSION

This dissertation has argued that phrasal movement has a uniform syntax. Specifically, all phrasal movement involves the application of Agree and Merge (1).

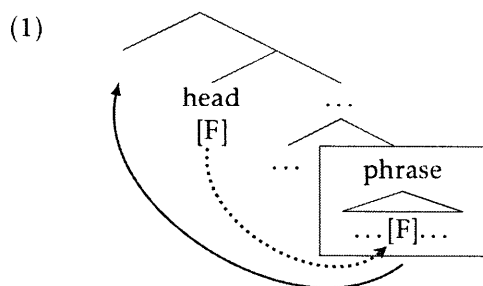

### *All phrasal movement:*

When a head is merged with a triggering feature F...

1. *Agree:* The trigger F **finds** the (closest) phrase bearing the same feature F. (dotted line)
2. *Merge:* The trigger **attracts** the phrase. (solid line)

In addition to this, I have pursued the hypothesis that the existence of different types of phrasal movement derives from the properties of the features that can be targeted by Agree. As a consequence, we can eliminate notions like A-position or  $\bar{A}$ -position as primitives of the grammar and maintain a much more restrictive view of the syntax of movement.

### 1 Recap of dissertation

I built my argument for the claim that phrasal movement has a uniform syntax in three parts. The first two major parts of the dissertation, Chapters 2 through 5, were concerned with motivating the claim that all movement involves the application of Agree (in other words, that all movement is feature-driven).

Chapter 2 started by arguing for a featural view of the A/ $\bar{A}$ -distinction, repeated in (2).

#### (2) *Featural view of the A/ $\bar{A}$ -distinction:*

All differences between A- and  $\bar{A}$ -movement derive from the features involved in Agree.

In this view, the only difference between *wh*-movement and movement to Spec-TP (in English, for example), is that the first involves a *Wh*-probe and the second a  $\varphi$ -probe. All concomitant differences in binding, reconstruction, or case follow just from differences between *Wh*-features and  $\varphi$ -features.

I proposed that what distinguishes features involved in A-movement is that they are obligatory features of nominals, while the features that drive  $\bar{A}$ -movement are optional. This difference captures the locality profile of A- and  $\bar{A}$ -movement, assuming Rizzi's (1990 et seq.) Relativized Minimality. Cable's (2007, 2010) approach to pied-piping can link the optionality of  $\bar{A}$ -features to their ability to trigger pied-piping, if both involve a variable merge site. That there should be no obligatory reconstruction for Principle C in A-movement I derived from Takahashi and Hulse's (2009) notion of Wholesale Late Merger, which allows for Late Merge of NPs in case positions. In addition, I adopted an account of Weak Crossover that draws on the idea all quantifiers quantify over choice functions (Sauerland 1998, 2004; Ruys 2000; Abels and Martí 2010). Support for the idea that A- and  $\bar{A}$ -movement trigger different kinds of abstraction comes from the distribution of parasitic gap licensing and depictives, drawing on Nissenbaum (2000) and Pylkkänen (2008).

After introducing Dinka clause structure in Chapter 3, Chapter 4 motivated the proposal that A- and  $\bar{A}$ -properties are properties of probing features by showing that there are systems in which movement is driven by both types of probe at the same time. Specifically, in Dinka (though possibly also in a number of Austronesian and Bantu languages), all long-distance movement is not just driven by information-structural considerations, but also by a  $\varphi$ -probe. As a result, all movement has the same morphosyntactic repercussions, including for case, agreement, verb-second, and voice. In accordance with this, I demonstrated that all long-distance movement in Dinka has the benefits usually associated with A-movement: there are no Weak Crossover effects, reconstruction for Principle C is not obligatory, and anaphors can be bound under movement. The existence of such systems strongly suggests that there cannot be radical differences between A- and  $\bar{A}$ -movement. Borrowing the notion of a composite probe from Coon and Bale's (2014) work on  $\varphi$ -agreement in Mi'gmaq, I showed how a featural view along the lines of (2) allows for long-distance movement with A-properties.

In Chapter 5, I extended this approach to intermediate movement steps of successive-cyclic dependencies, which has often been argued to arise by means of a special syntactic mechanism (e.g. Gazdar 1981; Pollard and Sag 1993; Heck and Müller 2000, 2003; Chomsky 2001, 2013; Neeleman and Van der Koot 2010). Languages in which movement is driven by a composite probe are the right languages to look at to investigate this claim, because the repercussions of  $\bar{A}$ -movement on the morphosyntax of the left periphery are limited in other systems in any case.

Starting with Dinka, I demonstrated that intermediate movement looks exactly like movement to the final landing site in Dinka and has predictable repercussions for case and agreement, verb-second, and voice, both at the edge of CP and at the edge of  $\nu$ P. I argued for an approach to these patterns in which intermediate movement too can be established by a composite probe (of both an  $\bar{A}$ -probe and a  $\varphi$ -probe). Part of the argument for this claim came from the observation that intermediate movement in Dinka allows for the creation of an additional specifier at the edge of a domain (beyond the one required by V2), just in case the phrase undergoing intermediate movement is incapable of valuing the  $\varphi$ -features of the composite probe. The right calculus for

this effect requires that there is a movement-driving feature on intermediate C and *v* responsible just for intermediate movement.

In addition to this, I discussed the distribution of overlapping (e.g. nesting or crossing)  $\bar{A}$ -dependencies in Dinka and other languages. On the basis of variation across languages, I proposed, following Rizzi (1990, 2004) and Abels (2012a), that  $\bar{A}$ -probes may be flat or relativized to specific  $\bar{A}$ -features, like *Wh* or *Top*, in analogy with much work on  $\varphi$ -probing (e.g. Nevins 2007; Preminger 2011; Coon and Bale 2014; Deal 2014). I made the point that, across languages, the admissibility of nesting and crossing  $\bar{A}$ -movements is insensitive to the distinction between terminal and intermediate movement. In other words, intermediate movement is subject to the same intervention effects as terminal movement. On the proposal that variation in the extent to which  $\bar{A}$ -movements intervene for one another reflects variation in the featural specification of probes, this requires that intermediate movement involve the same Agree relation as movement to the final landing site.

Not only do these patterns motivate treating intermediate movement like terminal movement, I showed that the Dinka facts provide direct evidence for the claim that CP and *v*P constitute parallel cyclic domains, so that all long-distance dependencies involve successive-cyclic movement steps to the edge of each domain (Chomsky 1986 et seq.). In Dinka, the two edges are exactly parallel: at both, intermediate movement preferentially satisfies V2, and feeds  $\varphi$ -agreement (though covertly at *v*). In addition, I described a pronoun copying effect at the *v*P edge in Dinka, documented in detail in Chapter 6, that directly reveals the presence of intermediate copies at each *v*P edge.

The third and last major part of this dissertation developed an argument that all instances of phrasal movement make use of the same mechanism of Merge, as in the Copy Theory of Movement (Chomsky 1995 et seq.). To be precise, I argued that pronouns may act as realizations of DP copies in the context of multiple copy spell-out, regardless of the complexity of the DP. I first showed that in a wide range of constructions, including A-movement,  $\bar{A}$ -movement, and intermediate movement, pronouns has been shown to be capable of occupying the position of gaps and behaving at LF like full copies (e.g. Zaenen et al. 1981; Koopman 1982, 1984; Engdahl 1985; Kandybowicz 2007; Holmberg and Nikanne 2008; Harizanov 2014; Sichel 2014). On the assumption that pronouns reflect the functional layer of a DP (e.g. Postal 1969; Elbourne 2001, 2005), I proposed that these constructions result from partial spell-out of a DP after NP deletion (e.g. McCloskey 2006).

I proposed that DPs copy as pronouns because copy deletion deletes as much material as possible (e.g. Landau 2006), so that a phrasal copy is necessarily reduced to its most “minimal” form, in this case a pronoun. The idea behind this idea is that the trigger for multiple copy spell-out requires only the presence of a phrase and so is equally satisfied by a full copy as well as a pronoun. This is responsible for the asymmetry in multiple copy spell-out between verbs and DPs: verbs copy as verbs, but DPs copy as pronouns. I further showed that the partial spell-out view is able to account for several asymmetries and gaps in the distribution of pronoun copying, focusing primarily on *ké*-copying in Dinka. Pronoun copying in Dinka is limited to plurals and displays only number-matching (1st and 2nd person pronouns copy as 3rd person). We saw that such asymmetries and gaps are found across pronoun copying constructions. In particular, in Nupe and

Finnish as well, copied pronouns are number-matching only. In addition, gaps in pronoun copying occur in German *wh*-copying as well (Pankau 2013). I then argued that these patterns result from partial spell-out. Gaps occur when copy deletion does not leave enough structure to spell out a pronoun. In the case of Dinka, I showed that the pronoun copying gap with singular results from an asymmetry between the 3rd person plural pronoun and the 3rd person singular pronoun: the 3rd person singular spells out more structure than is left by NP deletion. Finally, I accounted for matching asymmetries between person and number by proposing that these features are encoded in different locations in the DP. To be precise, I proposed that a projection encoding person is at the core of a pronoun and that languages may differ as to whether it can undergo NP deletion. In contrast, number is always introduced on a functional head and never undergoes deletion.

The main message of Chapter 6 then is that all movement leaves copies and specifically copies with an articulated internal structure. In the context of the view of phrasal movement developed here, this motivates the second step I propose is involved in all phrasal movement, the application of Merge.

## 2 Some remaining issues

There are a number of issues relevant to the syntax of movement that I have not touched upon in this dissertation. I briefly discuss two: whether head movement has the same status as phrasal movement, and what mechanism is responsible for triggering Merge after an Agree relation between a head and a phrase.

### 2.1 On head movement

One question that has guided a great deal of research is whether the syntax of phrasal movement is the same as the syntax of head movement, or whether head movement too involves just Agree and Merge. Whether head movement and phrasal movement should both be treated in the syntax has been a topic of debate in recent work (e.g. Chomsky 2000, 2001; Matushansky 2006; Roberts 2010; Hartman 2011; Adger 2013; Hall 2015). Arguments for a syntactic view of head movement are given by Matushansky (2006), Roberts (2010), Hartman (2011), and Gribanova (2014), among others.<sup>1</sup> Critical discussion of these arguments can be found in Adger (2013), Messick and Thoms (to appear), and Hall (2015).

One way of viewing head movement that is directly compatible with the syntax of phrasal movement in this dissertation comes from Matushansky (2006). Matushansky proposes that head movement involves movement of a head to a specifier, followed by the application of morphological merger. In this view, the first two steps of head movement are the same, except the target is a head: Agree for a feature [F], followed by Merge (3).

---

1. See Pesetsky and Torrego 2001, Roberts 2010 and Bjorkman 2011 for arguments that head movement requires Agree.



## 2.2 What triggers movement

Another issue that I have not discussed in detail is what factor determines whether Agree applies together with Merge or not, since there are clearly instances of Agree without Merge. In Chomsky (1995, 2000, 2001), a distinction was drawn essentially for this reason between “strong” features (probes who trigger the application of Merge) and “weak” features (probes that do not). Throughout this dissertation, I have steered away from this issue and assumed that there is some way of predicting which probes will trigger Merge and which will not. I would like to now briefly discuss some approaches that have emerged in recent work, starting with the approach to the EPP in Bošković (2007).

Bošković (2007) suggests that reversing the application of Agree and Merge may explain why Merge takes place. In particular, he proposes that movement always involves a situation in which the moving phrase itself carries a probe that must target the head to which movement takes place. Merge in effect serves to establish the right c-command relations for Agree. The syntax of phrasal movement that results is schematized in (6).

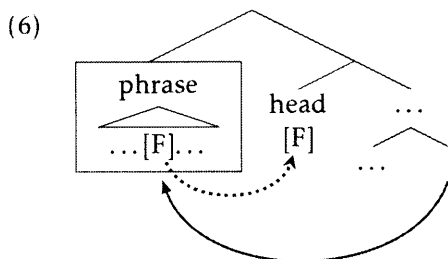

In this derivation, Merge happens *first* and allows the probe [F] on the moving phrase to c-command the head, and therefore Agree with it. It is commonly assumed in any case that there are features to be valued/checked on the moving phrase that render it active for Agree, such as Case or *Wh*, so that we can take these features to be the probes that establish (6).

In this approach, Merge occurs to facilitate Agree, rather than as a consequence of it. This view of phrasal movement involves the same two operations as the syntax that I have assumed so far (e.g. 7), and so many of the results obtained in this dissertation carry over to this alternative. However, this approach diverges from the one defended here in how it treats intermediate movement steps of successive-cyclic dependencies. In particular, because Merge happens first, it does not need to be followed by Agree. Bošković in fact suggests that this is what drives intermediate movement. In his approach, Merge occurs automatically, as long as the probe on the moving phrase remains unsatisfied.<sup>2</sup> As a result, intermediate movement does not involve Agree. Although this is a virtue in some respects (intermediate movement comes for free), I showed in Chapter 5 that intermediate movement steps have the same morphosyntactic repercussions as terminal movement, and are

2. This yields densely successive-cyclic derivations, with intermediate movement to each phrasal edge. But there are ways of constraining this to phase edges too.



accompanied by Agree relations. It is unclear then, for instance, how this view accounts for the observation that terminal and intermediate movement have the same effect on the admissibility of overlapping  $\bar{A}$ -dependencies (as discussed in sec. 3.2 of that chapter).

A variant of this proposal, also discussed by Bjorkman and Zeijlstra (2014), in effect combines the syntax in (7) with Bošković's view. In particular, suppose that phrasal movement involves Agree both before and after the application of Merge. One potential issue in Bošković's account is that Merge is almost unconstrained in its application. But we could imagine taking a different approach, in which Merge to facilitate Agree is limited to heads and phrases between which Agree has already taken place. In this view, phrasal movement occurs when a goal XP is targeted for Agree and the probing head carries features that could satisfy a probe on the XP.

Movement would then involve two stages, represented in (7) and (8).

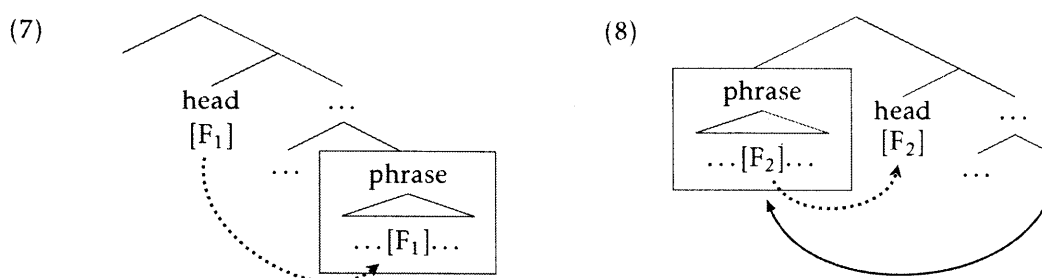

A head with a feature  $F_1$  enters into an Agree relation with a phrase (7). If an XP is targeted for Agree by a head that carries a feature  $F_2$  that could value a probe  $F_2$  on the XP, Merge occurs followed by Agree for  $F_2$  (8).<sup>3</sup> This approach to phrasal movement is compatible with the conclusions argued for here, because it requires Agree for Merge to take place, but preserves the main insight behind Bošković's (2007) account.

Another approach to what triggers movement is found in Richards (2010, 2015). Richards proposes that there is a general prosodic constraint on syntactic relations, Probe-Goal Contiguity, which requires two elements that stand in an Agree relation to be prosodically contiguous (9).

(9) **Probe-Goal Contiguity:**

Given a probe  $\alpha$  and a goal  $\beta$ ,  $\alpha$  and  $\beta$  must be dominated by a single  $\phi$  (= prosodic phrase).  
(adapted from Richards 2015:133)

Satisfying contiguity can be done in two ways: (i) by means of operations on existing prosodic phrasing, which regroups two elements into the same prosodic phrase, and (ii) through movement, which creates contiguity. Richards suggests that these two options correspond to Agree without Merge and Agree with Merge. In this approach, whether an Agree relation triggers Merge is predictable from how a language projects prosodic phrasing in a syntactic derivation and the operations that are allowed to act on this phrasing.

3. Bjorkman and Zeijlstra reverse the directionality of these Agree relations, but this does not matter for our purposes.

Such an approach is also compatible with everything I have said here, because Probe-Goal Contiguity should be capable of driving A-movement,  $\bar{A}$ -movement, and intermediate movement equally. In addition, it makes the interesting prediction that there should always be a predictable mapping from prosodic phrasing to the effects of Agree. See Richards 2015 for the details of this theory and how it applies in a wide range of contexts. It should be clear then that there are at least two promising directions for how Merge is triggered that are compatible with my general approach.

There is much more to be said about the syntax of phrasal movement, and of movement in general. I hope to have shown, however, that the idea that all movement involves the application of Agree and Merge affords an explanation of why there should be a number of different types of phrasal movement, with diverging syntactic and semantic properties.

## References

- Abels, Klaus. 2001. The predicate cleft construction in Russian. In *Formal Approaches to Slavic Linguistics 9*, ed. by Steven Franks and Michael Yadroff, 1–19. Michigan Slavic Publications.
- Abels, Klaus. 2003. *Successive cyclicity, anti-locality, and adposition stranding*. Doctoral dissertation, UConn.
- Abels, Klaus. 2007. Towards a restrictive theory of (remnant) movement. In *Linguistic Variation Yearbook 7*, ed. by Jeroen van Craenenbroeck and Johan Rooryck, 53–120. John Benjamins.
- Abels, Klaus. 2012a. The Italian left periphery: A view from locality. *Linguistic Inquiry* 43:229–254.
- Abels, Klaus. 2012b. *Phases: An essay on cyclicity in syntax*. Mouton de Gruyter.
- Abels, Klaus, and Luisa Martí. 2010. A unified approach to split scope. *Natural Language Semantics* 18:435–470.
- Abney, Steven. 1987. *The English noun phrase in its sentential aspect*. Doctoral dissertation, MIT.
- Abu-Bakr, Yousif El-Khalifa, and Abu-Manga, Al-Amin. 1997. Language situation and planning in the Sudan. Paper presented at the Intergovernmental Conference on Language Policies in Africa, Harare (Zimbabwe), 17–21 March 1997.
- Adesola, Oluseye. 2010. The non-agreeing subject resumptive pronoun in Yoruba. In *Topics in Kwa syntax*, ed. by James Essegbey, 65–89. Springer.
- Adger, David. 2011. Bare resumptives. In *Resumptive pronouns at the interfaces*, ed. by Alain Rouveret, 343–366. John Benjamins.
- Adger, David. 2013. *The syntax of substance*. MIT Press.
- Adger, David, and Gillian Ramchand. 2005. Merge and Move: *Wh*-dependencies revisited. *Linguistic Inquiry* 36:161–193.
- Ahland, Colleen Anne. 2012. *A grammar of Northern and Southern Gumuz*. Doctoral dissertation, University of Oregon.
- Aldridge, Edith. 2004. *Ergativity and word order in Austronesian languages*. Doctoral dissertation, Cornell University.
- Aldridge, Edith. 2008. Phase-based account of extraction in Indonesian. *Lingua* 1118:1440–1469.
- Aldridge, Edith. 2012. Antipassive and ergativity in Tagalog. *Lingua* 122:192–203.
- Alexiadou, Artemis, and Elena Anagnostopoulou. 1997. Toward a uniform account of scrambling and clitic doubling. In *German: Syntactic problems — problematic syntax*, ed. by Werner Abraham and Elly van Gelderen, 142–161. Max Niemeyer Verlag.
- Alexiadou, Artemis, and Elena Anagnostopoulou. 2000. Clitic doubling and (non)-configurationality. In *Proceedings of the NELS 30*, ed. by Masako Hirotsu, Andries Coetzee, Nancy Hall, and Ji-yung Kim, 17–28. GLSA.
- Anagnostopoulou, Elena. 2003. *The syntax of ditransitives: Evidence from clitics*. Mouton de Gruyter.
- Andersen, Torben. 1987. The phonemic system of Agar Dinka. *Journal of African Languages and Linguistics* 9:1–27.
- Andersen, Torben. 1988. Ergativity in Pãri: A Nilotic OVS language. *Lingua* 75: 289–324.
- Andersen, Torben. 1991. Subject and topic in Dinka. *Studies in Language* 15:265–294.

- Andersen, Torben. 1993. Vowel quality alternation in Dinka verb inflection. *Phonology* 10:1–42.
- Andersen, Torben. 1995. Morphological stratification in Dinka: On the alternations of voice quality, vowel length, and tone in the morphology of transitive verbal roots in a monosyllabic language. *Studies in African Linguistics* 23:1–64.
- Andersen, Torben. 2002. Case inflection and nominal head marking in Dinka. *Journal of African Languages and Linguistics* 23:1–30.
- Andersen, Torben. 2007. Auxiliary verbs in Dinka. *Studies in Language* 31:89–116.
- Andersen, Torben. 2012. Spatial roles and verbal directionality in Dinka. *Journal of African Languages and Linguistics* 33:143–179.
- Andersen, Torben. 2014. Number in Dinka. In *Number — Constructions and semantics: Case studies from Africa, Amazonia and Oceania*, ed. by Anne Storch and Gerrit Dimmendaal, 221–263. John Benjamins.
- Anyadi, Stefanie, and Armine Tamrazian. 1993. *Wh*-movement in Armenian and Ruhr German. *UCL Working papers in Linguistics* 5:1–22.
- Aoun, Joseph, Choueiri, Lina, and Norbert Hornstein. 2001. Resumption, movement, and derivational economy. *Linguistic Inquiry* 32:371–403.
- Aravind, Athulya. 2015. Minimality and *wh*-licensing in Malayalam. Syntax Square, MIT.
- Arregi, Karlos. 2002. *Focus on Basque movements*. Doctoral dissertation, MIT.
- Arregi, Karlos. 2003. Clausal pied-piping. *Natural Language Semantics* 11:115–143.
- Asudeh, Ash. 2012. *The logic of pronominal resumption*. Oxford University Press.
- Baier, Nico. 2014. Spell-out, chains, and long distance *wh*-movement in Seereer. Paper presented at CLS 50, Chicago.
- Baker, Mark. 1988. *Incorporation: A theory of grammatical function changing*. University of Chicago Press.
- Barbiers, Sjef. 2002. Remnant stranding and the theory of movement. In *Dimensions of movement: From features to remnants*, ed. by Artemis Alexiadou, Elena Anagnostopoulou, Sjef Barbiers, and Hans-Martin Gaertner, 47–69. John Benjamins.
- Barbiers, Sjef. 2008. Microvariation in syntactic doubling: An introduction. In *Microvariation in syntactic doubling*, ed. by Sjef Barbiers, Olaf Koenenman, Marika Lekakou, and Margreet van der Ham, 1–36. Brill.
- Barss, Andrew. 1986. *Chains and anaphoric dependence: On reconstruction and its implications*. Doctoral dissertation, MIT.
- Beltrame, Giovanni. 1870. *Grammatica della lingua denka*. Guiseppi Civelli.
- Beltrame, Giovanni. 1880. *Grammatica e vocabolario della lingua denka*. Stabilimento Guiseppe Civelli.
- Bender, M. Lionel. 2000. Nilo-Saharan. In *African languages: An introduction*, ed. by Bernd Heine and Derek Nurse, 43–73. Cambridge University Press.
- Bennett, Will, Akinbiyi Akinlabi, and Bruce Connell. 2012. Two subject asymmetries in Defaka focus constructions. In *Proceedings of WCCFL 29*, ed. by Jaehoon Choi, E. Alan Hogue, Jeffrey

- Punske, Deniz Tat, Jessamyn Schertz, and Alex Trueman, 294–302. Cascadilla Proceedings Project.
- den Besten, Hans. 1981. On the interaction of root transformations and lexical deletive rules. *Groninger Arbeiten zur Germanistischen Linguistik* 1–3:1–78.
- Bhatt, Rajesh, and Roumyana Pancheva. 2004. Late merger of degree clauses. *Linguistic Inquiry* 35:1–45.
- Bhatt, Rajesh, and Roumyana Pancheva. 2007. Degree quantifiers, position of merger effects with their restrictors, and conservativity. In *Direct compositionality*, ed. by Chris Barker and Pauline Jacobson, 306–335. Oxford University Press.
- Bittner, Maria. 1994. *Case, scope, and binding*. Kluwer.
- Bittner, Maria, and Ken Hale. 1996a. The structural determination of case and agreement. *Linguistic Inquiry* 27:1–68.
- Bittner, Maria, and Ken Hale. 1996b. Ergativity: Toward a theory of a heterogeneous class. *Linguistic Inquiry* 27:531–604.
- Bjorkman, Bronwyn. 2011. *BE-ing default: The morphosyntax of auxiliaries*. Doctoral dissertation, MIT.
- Bjorkman, Bronwyn, and Hedde Zeijlstra. 2014. Upward Agree is superior. *LingBuzz*, lingbuzz/002350.
- Bobaljik, Jonathan. 2002. A-chains at the PF interface: Copies and ‘covert’ movement. *Natural Language & Linguistic Theory* 20:197–267.
- Boeckx, Cedric. 2003. *Islands and chains: Resumption as stranding*. John Benjamins.
- Boef, Eefje. 2013. *Doubling in relative clauses: Aspects of morphosyntactic microvariation in Dutch*. Doctoral dissertation, Utrecht University.
- Bokamba, Eyamba. 1981. *Aspects of Bantu Syntax*. Manuscript, University of Illinois, Urbana-Champaign.
- Bolinger, Dwight. 1978. Asking more than one thing at a time. In *Questions*, ed. by Henry Hiz, 107–150. Reidel.
- Borer, Hagit. 1984. *Parametric syntax*. Foris.
- Bošković, Željko. 2007. On the locality and motivation of Move and Agree: An even more minimal theory. *Linguistic Inquiry* 38:589–644.
- Bouma, Gosse, Rob Malouf, and Ivan Sag. 2001. Satisfying constraints on extraction and adjunction. *Natural Language & Linguistic Theory* 19:1–65.
- Bowers, John. 2010. *Arguments as relations*. MIT Press.
- Brandi, Luciana, and Patrizia Cordin. 1989. Two Italian dialects and the null subject parameter. In *The null subject parameter*, ed. by Osvaldo Jaeggli and Ken Safir, 111–142. Springer.
- Bresnan, Joan. 1998. Morphology competes with syntax: Explaining typological variation in Weak Crossover effects. In *Is the best good enough? Optimality and competition in syntax*, ed. by Pilar Barbosa, Danny Fox, Paul Hagstrom, Martha McGinnis, and David Pesetsky, 59–92. MIT Press.

- Brody, Michael. 2000. Mirror Theory: Syntactic representation in perfect syntax. *Linguistic Inquiry* 31: 29–56.
- Browning, Marguerite. 1987. *Null operator constructions*. Doctoral dissertation, MIT.
- Bruening, Benjamin. 2001a. QR obeys superiority: ACD and frozen scope. *Linguistic Inquiry* 32:233–273.
- Bruening, Benjamin. 2001b. *Syntax at the edge: Cross-clausal phenomena and the syntax of Passamaquoddy*. Doctoral dissertation, MIT.
- Bruening, Benjamin. 2006. Differences between *wh*-scope marking and *wh*-copy constructions in Passamaquoddy. *Linguistic Inquiry* 37:25–49.
- Bruening, Benjamin. 2014. Precede-and-command revisited. *Language* 90:342–388.
- Bruening, Benjamin. 2015. Depictive secondary predicates, light verb *give*, and theories of double object constructions. Manuscript, University of Delaware.
- Brun-Rollet, Antoine. 1862. Vokabulieren der Dinka, Nuehr und Schilluk Sprachen. *Mitteilungen aus Justus Perthes' Geographischer Anstalt über wichtige neue Erforschungen auf dem Gesamtgebiete der Geographie*, Ergänzungsband 2, Heft 7:25–30.
- Buell, Leston. 2012. A first look at Ewe VP fronting and derivation by phase. *LingBuzz*, [lingbuzz/001486](http://lingbuzz/001486).
- Buell, Leston, Kristina Reidel, and Jenneke van der Wal. 2011. What the Bantu languages can tell us about word order and movement. *Lingua* 121:689–701.
- Büring, Daniel. 2005. *Binding theory*. Cambridge University Press.
- Cable, Seth. 2007. *The grammar of Q: Q-particles and the nature of Wh-fronting, as revealed by the Wh-questions of Tlingit*. Doctoral dissertation, MIT.
- Cable, Seth. 2010. *The grammar of Q: Q-particles, wh-movement, and pied-piping*. Oxford University Press.
- Cardinaletti, Anna, and Michal Starke. 1999. The typology of structural deficiency. In *Clitics and other functional categories in European languages*, ed. by Henk van Riemsdijk, 145–234. Mouton de Gruyter.
- Carlson, Greg. 1977. *Reference to kinds in English*. Doctoral dissertation, UMass Amherst.
- Carstens, Vicki. 1991. *The morphology and syntax of determiners in Kiswahili*. Doctoral dissertation, UCLA.
- Carstens, Vicki. 2003. Rethinking complementizer agreement: Agree with a Case-checked goal. *Linguistic Inquiry* 34:393–412.
- Carstens, Vicki. 2005. Agree and EPP in Bantu. *Natural Language & Linguistic Theory* 23: 219–279.
- Charnavel, Isabelle, and Dominique Sportiche. To appear. Anaphor binding domains. *Linguistic Inquiry*.
- Chomsky, Noam. 1973. Conditions on transformations. In *A festschrift for Morris Halle*, ed. by Stephen Anderson and Paul Kiparsky, 232–286. Holt, Rinehart & Winston.
- Chomsky, Noam. 1977. On *wh*-movement. In *Formal syntax*, ed. by Adrian Akmajian, Peter Culicover, and Thomas Wasow, 71–132. Academic Press.

- Chomsky, Noam. 1981. *Lectures on government and binding*. Foris.
- Chomsky, Noam. 1986. *Barriers*. MIT Press.
- Chomsky, Noam. 1991. Some notes on economy of derivation and representation. In *Principles and parameters in comparative syntax*, ed. by Robert Freidin, 417–454. MIT Press.
- Chomsky, Noam. 1993. A minimalist program for linguistic theory. In *The view from Building 20*, ed. by Kenneth Hale and Samuel Jay Keyser, 1–52. MIT Press.
- Chomsky, Noam. 1995. *The minimalist program*. MIT Press.
- Chomsky, Noam. 2000. Minimalist inquiries: The framework. In *Step by step: Essays on minimalist syntax in honor of Howard Lasnik*, ed. by R. Martin, D. Michaels, and J. Uriagereka, 89–155. MIT Press.
- Chomsky, Noam. 2001. Derivation by phase. In *Ken Hale: A life in language*, ed. by M. Kenstowicz, 1–52. MIT Press.
- Chomsky, Noam. 2007. Approaching UG from below. In *Interfaces + recursion = language?*, ed. by Uli Sauerland and Hans-Martin Gärtner, 1–29. Mouton de Gruyter.
- Chomsky, Noam. 2008. On phases. In *Foundational issues in linguistic theory: Essays in honor of Jean-Roger Vergnaud*, ed. by Robert Freidin, Carlos P. Otero, and Maria Luisa Zubizarreta, 133–166. MIT Press.
- Chomsky, Noam. 2013. Problems of projection. *Lingua* 130:33–49.
- Chomsky, Noam, and Howard Lasnik. 1993. The theory of principles and parameters. In *Syntax: An international handbook of contemporary research*, ed. by Joachim Jacobs, Arnim von Stechow, Wolfgang Sternefeld, and Theo Vennemann, 506–569. Walter de Gruyter.
- Chung, Sandra. 1982. Unbounded dependencies in Chamorro grammar. *Linguistic Inquiry* 13:39–77.
- Clements, George. 1984. Binding domains in Kikuyu. *Studies in the Linguistic Sciences* 14:37–56.
- Clements, George, and Kevin Ford. 1979. Kikuyu tone shift and its synchronic consequences. *Linguistic Inquiry* 10:179–210.
- Clements, George, James McCloskey, Joan Maling, and Annie Zaenen. 1983. String-vacuous rule application. *Linguistic Inquiry* 14:1–17.
- Cinque, Guglielmo. 1999. *Adverbs and functional heads: A cross-linguistic perspective*. Oxford University Press.
- Cognola, Federica. 2008. OV/VO syntax in Mòcheno declarative clauses. *Rivista di Grammatica Generativa* 33:79–93.
- Cognola, Federica. 2013. *Wh*-long extraction in Mòcheno and the derivation of OV word order in West Germanic. Paper presented at the 28th Comparative Germanic Workshop.
- Cole, Peter, and Gabriella Hermon. 1998. The typology of WH movement: WH questions in Malay. *Syntax* 1:221–258.
- Coon, Jessica, and Alan Bale. 2014. The interaction of person and number in Mi'gmaq. *Nordlyd* 40:85–101.

- Couquaux, Daniel. 1975. Une règle de réanalyse en français. *Recherches linguistiques de Vincennes* 4:32–72.
- Cozier, Franz. 2006. The co-occurrence of predicate clefting and *wh*-questions in Trinidad Dialectal English. *Natural Language & Linguistic Theory* 24:655–688.
- van Craenenbroeck, Jeroen, and Marjo van Koppen. 2002. Subject doubling in Dutch dialects. In *Proceedings of ConSOLE IX*, ed. by Marjo van Koppen, Erica Thrift, Erik Jan van der Torre and Malte Zimmermann, 54–67.
- Creider, Chet. 1989. *The syntax of Nilotic languages: Variations and themes*. Dietrich Reimer Verlag.
- Cuervo, Maria Cristina. 2003. *Datives at large*. Doctoral dissertation, MIT.
- Culicover, Peter, and Robert Levine. 2001. Stylistic inversion in English: A reconsideration. *Natural Language & Linguistic Theory* 19:283–310.
- Dayal, Veneeta. 1994. Scope marking as indirect *wh*-dependency. *Natural Language Semantics* 2:137–170.
- Deal, Amy Rose. 2014. Properties of probes: Evidence from Nez Perce complementizer agreement. Presentation at NELS 45, MIT.
- Déchaine, Rose-Marie, and Martina Wiltschko. 2002. Decomposing pronouns. *Linguistic Inquiry* 33:409–442.
- Demirdache, Hamida. 1991. *Resumptive chains in restrictive relatives, appositives and dislocation structures*. Doctoral dissertation, MIT.
- Déprez, Vivian. 1989. *On the typology of syntactic positions and the nature of chains*. Doctoral dissertation, MIT.
- Diesing, Molly. 1990. Verb movement and the subject position in Yiddish. *Natural Language & Linguistic Theory* 8:41–79.
- Diesing, Molly. 2014. The upper functional domain in Yiddish. In *Focus on Germanic typology*, ed. by Werner Abraham, 195–210. Akademie Verlag.
- den Dikken, Marcel. 2006. When Hungarians agree (to disagree): The fine art of “ $\varphi$ ” and “art.” Manuscript, CUNY Graduate Center.
- den Dikken, Marcel. 2009. On the nature and distribution of successive cyclicity. Manuscript, CUNY Graduate Center.
- Dimmendaal, Gerrit. 1983. *The Turkana language*. Foris.
- Dimmendaal, Gerrit. 1985. Prominence hierarchies and Turkana syntax. *Proceedings of ACAL 14*, 127–148. Foris.
- Dimmendaal, Gerrit. 2005. Head marking, dependent marking, and constituent order in the Nilotic area. In *Studies in African linguistic typology*, ed. by F. K. Erhard Voeltz, 71–92. John Benjamins.
- Dimmendaal, Gerrit. 2007. Marked nominative systems in Eastern Sudanic and their historical origin. Paper presented at Workshop on Grammar and Processing of Verbal Arguments, Leipzig, 20–21 April 2007.
- Dixon, Robert M.W. 1979. Ergativity. *Language* 55:59–138.



- Duerksen, John. 1997. Dinka dialects: A preliminary report. *Occasional papers in the study of Sudanese languages* 7:1–18.
- Elbourne, Paul. 2001. E-type anaphora as NP-deletion. *Natural Language Semantics* 9:241–288.
- Elbourne, Paul. 2005. *Situations and individuals*. MIT Press.
- Elbourne, Paul. 2013. *Definite descriptions*. Oxford University Press.
- Engdahl, Elisabet. 1982. Restrictions on unbounded dependencies in Swedish. In *Readings on unbounded dependencies in Scandinavian languages*, ed. by Elisabet Engdahl and Eva Ejerhed, 151–174. Almqvist and Wiksell.
- Engdahl, Elisabet. 1985. Parasitic gaps, resumptive pronouns, and subject extractions. *Linguistics* 23:3–44.
- Engdahl, Elisabet. 1986. *Constituent questions: The syntax and semantics of questions with special reference to Swedish*. Reidel.
- Erlewine, Michael Y. 2014. *Movement out of focus*. Doctoral dissertation, MIT.
- Erlewine, Michael Y., Theodore Levin, and Coppe van Urk. To appear. Ergativity and Austronesian-type voice systems. In *Oxford Handbook of Ergativity*, ed. by Jessica Coon, Diane Massam, and Lisa Travis. Oxford University Press.
- Evans, Nicholas. 1995. *A grammar of Kayardild*. Walter de Gruyter.
- Fanselow, Gisbert, and Damir Ćavar. 2001. Remarks on the economy of pronunciation. In *The rise of competition in syntax: A synopsis*, ed. by Gereon Müller and Wolfgang Sternefeld, 107–150. De Gruyter.
- Fanselow, Gisbert, and Anoop Mahajan. 2000. Towards a minimalist theory of *wh*-expletives, *wh*-copying, and successive cyclicity. In *Wh-scope marking*, ed. by Uli Lutz, Gereon Müller, and Arnim von Stechow, 195–230. John Benjamins.
- Faraci, Robert. 1974. *Aspects of the grammar of infinitives and for-phrases*. Doctoral dissertation, MIT.
- Felser, Claudia. 2004. *Wh*-copying, phases, and successive cyclicity. *Lingua* 114:543–574.
- Freidin, Robert. 1986. Fundamental issues in the theory of binding. In *Studies in the acquisition of anaphora*, ed. by Barbara Lust, 151–188. Reidel.
- Fox, Danny. 1999. Reconstruction, binding theory, and the interpretation of chains. *Linguistic Inquiry* 30:157–196.
- Fox, Danny. 2000. *Economy and scope*. MIT Press.
- Fox, Danny. 2002. Antecedent-contained deletion and the copy theory of movement. *Linguistic Inquiry* 33:63–96.
- Fox, Danny, and David Pesetsky. 2005. 24.952 class notes, MIT.
- Frascarelli, Mara, and Roland Hinterhölzl. 2007. Types of topics in German and Italian. In *On information structure, meaning and form*, ed. by K. Schwabe and S. Winkler, 87–116. John Benjamins.
- Fukui, Naoki, and Margaret Speas. 1986. Specifiers and projection. In *MIT Working Papers in Linguistics* 8, 128–172.

- Funakoshi, Kenshi. 2014. *Syntactic head movement and its consequences*. Doctoral dissertation, University of Maryland.
- Gazdar, Gerald. 1981. Unbounded dependencies and coordinate structure. *Linguistic Inquiry* 12:155–184.
- George, Leland, and Jaklin Kornfilt. 1981. Finiteness and boundedness in Turkish. In *Binding and filtering*, ed. by F. Heny, 105–127. MIT Press.
- Georgi, Doreen. 2014. *Opaque interactions of Agree and Merge: On the nature and order of elementary operations*. Doctoral dissertation, Universität Leipzig.
- Gilley, Leoma. 2003. The feature of stress in Nilotic. *Frankfurter Afrikanistische Blätter* 15:99–120.
- Gracǎnin-Yuksek, Martina. 2010. On a matching effect in headed relative clauses. In *Formal Approaches to Slavic Linguistics 18*, ed. by Wayles Browne, Adam Cooper, Alison Fisher, Esra Kesici, Nikola Predolac, and Draga Zec, 193–209. Ann Arbor: Michigan Slavic Publications.
- Greenberg, Joseph. 1966. *The languages of Africa*. Mouton & Co.
- Gribanova, Vera. 2014. Discourse-driven head movement, VSO and ellipsis in Russian. Paper presented at NELS 45, MIT.
- Gruber, Bettina. 2013. *The spatiotemporal dimensions of person: A morphosyntactic account of indexical pronouns*. Doctoral dissertation, Utrecht University.
- Guilfoyle, Eithne, Henrietta Hung, and Lisa Travis. 1992. Spec of IP and Spec of VP: Two subjects in Austronesian languages. *Natural Language & Linguistic Theory* 10:375–414.
- Haegeman, Liliane. 1996. The typology of syntactic positions: L-relatedness and the A/Ā distinction. In *Minimal ideas: Syntactic studies in the minimalist framework*, ed. by Werner Abraham, Samuel David Epstein, Höskuldur Þráinsson, and C. Jan-Wouter Zwart, 141–165. John Benjamins.
- Haegeman, Liliane. 2003. Notes on long adverbial fronting and the left periphery. *Linguistic Inquiry* 34:640–649.
- Haegeman, Liliane. 2012. *Adverbial clauses, main clause phenonema, and composition of the left periphery*. Oxford University Press.
- Hale, Ken, and Samuel J. Keyser. 2002. *Prolegomenon to a theory of argument structure*. MIT Press.
- Hall, David. 2015. *Spelling out the noun phrase: Interpretation, word order, and the problem of 'meaningless movement'*. Doctoral dissertation, Queen Mary University of London.
- Harford Perez, Carolyn. 1985. *Aspects of complementation in three Bantu languages*. Doctoral dissertation, University of Wisconsin-Madison.
- Harley, Heidi, and Elizabeth Ritter. 2002. A feature-geometric analysis of person and number. *Language* 78:482–526.
- Halpert, Claire. 2012. *Argument licensing and agreement in Zulu*. Doctoral dissertation, MIT.
- Halpert, Claire. 2015. Raising parameters. Presentation at GLOW 38, Paris.
- Harizanov, Boris. 2014. Clitic doubling at the syntax-morphophonology interface. *Natural Language & Linguistic Theory* 32:1033–1088.

- Harley, Heidi. 1997. If you have, you can give. In *Proceedings of the 15th West Coast Conference on Formal Linguistics*, ed. by Brian Agbayani and Sze-Wing Tang, 193–207. CSLI.
- Harley, Heidi. 2002. Possession and the double object construction. *Yearbook of Linguistic Variation* 2:29–68.
- Harley, Heidi. 2009. The morphology of nominalizations and the syntax of *vP*. In *Quantification, definiteness and nominalization*, ed. by Anastasia Giannakidou and Monika Rathert, 321–343. Oxford University Press.
- Harley, Heidi. 2013. External arguments and the Mirror Principle: On the distinctness of Voice and *v*. *Lingua* 125:34–57.
- Hartman, Jeremy. 2011. The semantic uniformity of traces: Evidence from ellipsis parallelism. *Linguistic Inquiry* 42:367–388.
- Hartman, Jeremy. 2012. *Varieties of clausal complementation*. Doctoral dissertation, MIT.
- Heck, Fabian. 2008. On pied-piping: *Wh*-movement and beyond. Walter de Gruyter.
- Heck, Fabian. 2009. On certain properties of pied-piping. *Linguistic Inquiry* 40:75–111.
- Heck, Fabian, and Gereon Müller. 2000. Successive cyclicity, long-distance superiority, and local optimization. *Proceedings of WCCFL 19*, ed. by Roger Billerey and Brook Danielle Lillehaugen, 218–231. Cascadilla Press.
- Heck, Fabian, and Gereon Müller. 2003. Derivational optimization of *wh*-movement. *Linguistic Analysis* 33:97–148.
- Heim, Irene. 1982. *The semantics of definite and indefinite noun phrases*. Doctoral dissertation, UMass Amherst.
- Heinat, Fredrik. 2008. *Probes, pronouns and binding in the Minimalist Program*. VDM Verlag.
- Henderson, Brent. 2006. *The syntax and typology of Bantu relative clauses*. Doctoral dissertation, University of Illinois at Urbana-Champaign.
- Henderson, Brent. 2011. Agreement, locality, and OVS in Bantu. *Lingua* 121:742–753.
- Henderson, Brent. 2013. Agreement and person in anti-agreement. *Natural Language & Linguistic Theory* 31:453–481.
- Henry, Alison. 1995. *Belfast English and Standard English: Dialect variation and parameter setting*. Oxford University Press.
- Hermon, Gabriella. 1985. *Syntactic modularity*. Foris.
- Hiemstra, Inge. 1986. Some aspects of *wh*-questions in Frisian. *North-Western European Language Evolution* 8:97–110.
- Hladnik, Marko. 2015. *Mind the gap: Resumption in Slavic relative clauses*. Doctoral dissertation, Utrecht University.
- Holmberg, Anders and Urpo Nikanne. 2002. Expletives, subjects, and topics in Finnish. In *Subjects, expletives and the EPP*, ed. by Peter Svenonius, 71–105. Oxford University Press.
- Holmberg, Anders, and Urpo Nikanne. 2008. Subject doubling in Finnish: The role of deficient pronouns. In *Microvariation in syntactic doubling*, ed. by Sjeff Barbiers, Olaf Koenenman, Marika Lekakou, and Margreet van der Ham, 325–349. Brill.

- Holmberg, Anders, and Christer Platzack. 1995. *The role of inflection in Scandinavian syntax*. Oxford University Press.
- Hrafnbjargarson, Gunnar Hrafn, and Anna-Lena Wiklund. 2009. General embedded V2: Icelandic A, B, C, etc. *Working Papers in Scandinavian Syntax* 84:21–51.
- Hrafnbjargarson, Gunnar Hrafn, Kristine Bentzen, and Anna-Lena Wiklund. 2010. Observations on extraction from V2 clauses in Scandinavian. *Nordic Journal of Linguistics* 33:299–309.
- Huang, Zong-Rong, and Kuo-Chiao Jason Lin. 2012. Placing Atayal on the ergativity continuum. LSA 2012.
- Huettner, Alison. 1989. *Adjunct infinitives in English*. Doctoral dissertation, UMass Amherst.
- Huhmarniemi, Saara. 2012. *Finnish A'-movement: Edges and islands*. Doctoral dissertation, University of Helsinki.
- Idris, Hélène Fatima. 2004. Modern developments in the Dinka language. *Göteborg Africana Informal Series* 3.
- Iatridou, Sabine, and Anthony Kroch. 1993. The licensing of CP-recursion and its relevance to the Germanic verb-second phenomenon. *Working Papers in Scandinavian Syntax* 50:1–24.
- Imanishi, Yusuke. 2014. *Default ergative*. Doctoral dissertation, MIT.
- Jaeggli, Osvaldo. 1982. *Topics in Romance syntax*. Foris.
- Jaeggli, Osvaldo. 1986. Three issues in the theory of clitics: Case, doubled NPs, and extraction. In *The syntax of pronominal clitics*, ed. by Hagit Borer, 15–42. Academic Press.
- Jlassi, Mohamed. 2013. *The multiple subject construction in Arabic: Evidence from subject doubling in Tunisian Arabic*. Doctoral dissertation, University of Newcastle Upon Tyne.
- Johnson, Kyle. 2012. Towards deriving differences in how *Wh* Movement and QR are pronounced. *Lingua* 122:529–553.
- Kandybowicz, Jason. 2007. *The grammar of repetition: Nupe grammar at the syntax-phonology interface*. John Benjamins.
- Kaufman, Daniel. 2009. Nominalism and its consequences: A Tagalog case study. *Theoretical Linguistics* 35:1–49.
- Kayne, Richard. 1983. Connectedness. *Linguistic Inquiry* 14:223–249.
- Kayne, Richard, and Jean-Yves Pollock. 1978. Stylistic inversion, successive cyclicity, and Move NP in French. *Linguistic Inquiry* 9:595–622.
- Keine, Stefan. 2014. Improper Agree. Manuscript, UMass Amherst.
- Keine, Stefan, and Ethan Poole. 2015. Intervention in *tough*-constructions. Presentation at GLOW 38, Paris.
- Kiessling, Roland. 2007. The “marked nominative” in Datooga. *Journal of African Languages and Linguistics* 28:149–191.
- Kinyalolo, Kasangati. 1991. *Syntactic dependencies and the SPEC-head agreement hypothesis in KiLega*. Doctoral dissertation, UCLA.
- Kiss, Katalin. 1987. *Configurationality in Hungarian*. Reidel.

- Kitahara, Hasitsugu. 1994. *Target  $\alpha$ : A unified theory of movement and structure building*. Doctoral dissertation, MIT.
- Kitahara, Hasitsugu. 1997. *Elementary operations and optimal derivations*. MIT Press.
- König, Christa. 2006. Marked nominative in Africa. *Studies in Language* 30:655–732.
- König, Christa. 2008. *Case in Africa*. Oxford University Press.
- Koopman, Hilda. 1982. Control from COMP and comparative syntax. *Linguistic Review* 2:365–391.
- Koopman, Hilda. 1984. *The syntax of verbs: From verb movement in the Kru languages to Universal Grammar*. Foris.
- Koopman, Hilda. 2005. On the parallelism of DPs and clauses: Evidence from Kisongo Maasai. In *Verb first: On the syntax of verb-initial languages*, ed. by Andrew Carnie, Heidi Harley, and Sheila Ann Dooley, 281–302. John Benjamins.
- Koopman, Hilda. 2010. On Dutch *allemaal* and West Ulster English *all*. In *Structure preserved: Studies in syntax for Jan Koster*, ed. by Jan-Wouter Zwart and Mark de Vries, 267–276. John Benjamins.
- Koopman, Hilda, and Dominique Sportiche. 1986. A note on long extraction in Vata and the ECP. *Natural Language & Linguistic Theory* 4:357–374.
- Koopman, Hilda, and Dominique Sportiche. 1991. The position of subjects. *Lingua* 85: 211–258.
- van Koppen, Marjo. 2005. *One Probe — Two Goals: Aspects of agreement in Dutch dialects*. Doctoral dissertation, Utrecht University.
- Koster, Jan. 2009. IM not perfect: The case against copying. Manuscript, University of Groningen.
- Kotek, Hadas. 2014. *Wh-fronting in a two-probe system*. *Natural Language & Linguistic Theory* 32:1105–1143.
- Kramer, Ruth. 2009. *Definite markers, phi-features, and agreement: A morphosyntactic investigation of the Amharic DP*. Doctoral dissertation, UCSC.
- Kratzer, Angelika. 1996. Severing the external argument from its verb. In *Phrase structure and the lexicon*, ed. by Johan Rooryck and Laurie Zaring, 109–137. Kluwer.
- Kratzer, Angelika. 2009. Making a pronoun: Fake indexicals as windows into the properties of pronouns. *Linguistic Inquiry* 40:187–237.
- Kratzer, Angelika, and Junko Shimoyama. 2002. Indeterminate pronouns: The view from Japanese. In *Proceedings of the Third Tokyo Conference on Psycholinguistics*, ed. by Yukio Otsu, 1–25. Hituzi Syobo.
- Kuno, Susumu, and Jane Robinson. 1972. Multiple *Wh* questions. *Linguistic Inquiry* 3:463–487.
- Ladd, D. Robert, Bert Remijsen, and Caguor Adong Manyang. 2009. On the distinction between regular and irregular inflectional morphology: Evidence from Dinka. *Language* 85:659–670.
- Lamontagne, Greg, and Lisa Travis. 1987. The syntax of adjacency. In *Proceedings of the WCCFL 6*, 173–186. CSLI Publications.
- Landau, Idan. 2006. Chain resolution in Hebrew V(P) fronting. *Syntax* 9:32–66.
- Landau, Idan. 2013. *Control in generative grammar: A research companion*. Cambridge University Press.

- Larson, Richard. 1988. Light predicate raising. In *Lexicon Working Papers 27*. MITPWL.
- Lasnik, Howard, and Mamoru Saito. 1992. *Move  $\alpha$* . MIT Press.
- Lasnik, Howard, and Tim Stowell. 1991. Weakest Crossover. *Linguistic Inquiry* 22:687–720.
- Lebeaux, David. 1988. *Language acquisition and the form of grammar*. Doctoral dissertation, UMass Amherst.
- Lebeaux, David. 1998. *Where does binding theory apply?* Technical report. NEC Research Institute.
- Legate, Julie Anne. 2008. Morphological and abstract Case. *Linguistic Inquiry* 39:55–101.
- Legate, Julie Anne. 2014. *Voice and v: Lessons from Acehnese*. MIT Press.
- Levin, Theodore. 2015. *Licensing without case*. Doctoral dissertation, MIT.
- Liu, Adlay Kun-long. 2004. *On relativization in Squliq Atayal*. Master's thesis, National Tsing Hua University.
- Lowenstamm, J. 1977. Relative clauses in Yiddish: A case for movement. *Linguistic Analysis* 3:197–216.
- Mahajan, Anoop. 1990. *The A/ $\bar{A}$ -distinction and movement theory*. Doctoral dissertation, MIT.
- Maling, Joan. 1980. Inversion in embedded clauses in Modern Icelandic. *Íslenskt mál* 2:175–193.
- Malou, Job. 1988. *Dinka vowel system*. SIL, University of Texas at Arlington.
- Marantz, Alec. 1993. Implications of asymmetries in double object construction. In *Theoretical aspects of Bantu grammar*, ed. by Sam Mchombo, 113–150. CSLI Publications.
- Massey, Victoria Walker. 1992. *Compositionality and constituency in Albanian*. Doctoral dissertation, University of North Carolina, Chapel Hill.
- Massam, Diane. 2001. Pseudo noun incorporation in Niuean. *Natural Language & Linguistic Theory* 19:153–197.
- Matushansky, Ora. 2006. Head movement in linguistic theory. *Linguistic Inquiry* 37:69–109.
- McCloskey, Jim. 1979. *Transformational syntax and model-theoretic semantics: A case study in Modern Irish*. Reidel.
- McCloskey, Jim. 1990. Resumptive pronouns, A-bar binding and levels of representation in Irish. *The syntax and semantics of Modern Celtic languages*, ed. by Randall Hendrick. Academic Press.
- McCloskey, Jim. 2000. Quantifier float and *wh*-movement in an Irish English. *Linguistic Inquiry* 31:57–84.
- McCloskey, Jim. 2001. The morphosyntax of *wh*-extraction in Irish. *Journal of Linguistics* 37:67–100.
- McCloskey, Jim. 2002. Resumption, successive cyclicity, and the locality of operations. In *Derivation and explanation in the Minimalist Program*, ed. by Samuel David Epstein and T. Daniel Seely, 184–226. Blackwell.
- McCloskey, Jim. 2006. Resumption. In *The Blackwell Companion to Syntax*, ed. by Martin Everaert and Henk van Riemsdijk, 94–117. Blackwell.
- McGinnis, Martha. 1998. *Locality in A-movement*. Doctoral dissertation, MIT.
- McGinnis, Martha. 2004. Lethal ambiguity. *Linguistic Inquiry* 35:47–95.

- Merchant, Jason. 2008. Variable island repair under ellipsis. In *Topics in ellipsis*, ed. by Kyle Johnson, 132–153. Cambridge University Press.
- Messick, Troy, and Gary Thoms. To appear. Ellipsis, economy and the (non)uniformity of traces. *Linguistic Inquiry*.
- Miterrutzner, Johannes Chrysostomus. 1866. *Die Dinka-Sprache in Central-Afrika; Kurze Grammatik, Text und Wörterbuch*. A. Weger.
- Miyagawa, Shigeru. 2010. *Why Agree? Why Move?* MIT Press.
- Moskal, Beata. To appear. Limits on allomorphy: A case study in nominal suppletion. *Linguistic Inquiry*.
- Müller, Friedrich. 1877. Die Sprache der Dinka. In *Grundriss der Sprachwissenschaft, I. Band, II. Abteilung: die Sprachen der wollhaarigen Rassen*, 48–58. Alfred Hölder.
- Müller, Gereon. 1995. *A-bar syntax: A study in movement types*. Mouton de Gruyter.
- Murphy, Andrew. 2015. Movement-conditioned downstep deletion in Kikuyu. Manuscript, Universität Leipzig.
- Ndayiragije, Juvénal. 1999. Checking economy. *Linguistic Inquiry* 30:399–444.
- Nebel, Arthur. 1936. *Dinka dictionary*. Instituto Missioni Africane.
- Nebel, Arthur. 1948. *Dinka Grammar (Rek-Malual dialect) with texts and vocabulary*. Instituto Missioni Africane.
- Nebel, Arthur. 1979. *Dinka-English, English-Dinka dictionary*. Editrice Missionaria Italiana.
- Neeleman, Ad. 1994. Scrambling as a D-Structure phenomenon. In *Studies on scrambling: Movement and non-movement approaches to free word order phenomena*, ed. by Norbert Corver and Henk van Riemsdijk, 387–429. Mouton de Gruyter.
- Neeleman, Ad, and Hans van de Koot. 2010. A local encoding of syntactic dependencies and its consequences for the theory of movement. *Syntax* 13:331–372.
- Nevins, Andrew. 2007. The representation of third person and its consequences for person-case effects. *Natural Language & Linguistic Theory* 25:273–313.
- Nevins, Andrew. 2011. Multiple Agree with clitics: Person complementarity vs. omnivorous number. *Natural Language & Linguistic Theory* 29:939–971.
- Nissenbaum, Jon. 2000. *Investigations of covert phrase movement*. Doctoral dissertation, MIT.
- Nissenbaum, Jon, and Bernhard Schwarz. 2011. Parasitic degree phrases. *Natural Language Semantics* 19:1–38.
- Nsuka Nkutsi, Francois. 1982. *Les Structures fondamentales du relatif dans les langues Bantoues*. Musée Royal de l’Afrique Centrale.
- Obata, Miki. 2010. *Root, successive-cyclic and feature-splitting Internal Merge: Implications for feature-inheritance and transfer*. Doctoral dissertation, University of Michigan.
- Obata, Miki, and Samuel David Epstein. 2011. Feature-splitting Internal Merge: Improper movement, intervention, and the A/A’ distinction. *Syntax* 14:122–147.
- Oehrle, Richard. 1976. *The grammatical status of the English dative alternation*. Doctoral dissertation, MIT.

- Ortiz de Urbina, Jon. 1989. *Parameters in the grammar of Basque: A GB approach to Basque syntax*. Foris.
- Ortiz de Urbina, Jon. 1993. Feature percolation and clausal pied-piping. In *Generative studies in Basque linguistics*, ed. by José Ignacio Hualde and Jon Ortiz de Urbina, 189–219. John Benjamins.
- Ouhalla, Jamal. 1993. Subject-extraction, negation and the antiagreement effect. *Natural Language & Linguistic Theory* 11:477–518.
- Pankau, Andreas. 2013. *Replacing copies: The syntax of wh-copying in German*. Doctoral dissertation, Utrecht University.
- Pearson, Matthew. 2001. *The clause structure of Malagasy: A minimalist approach*. Doctoral dissertation, UCLA.
- Pearson, Matthew. 2005. The Malagasy subject/topic as an  $\bar{A}$ -element. *Natural Language & Linguistic Theory* 23:381–457.
- Pesetsky, David. 1982. *Paths and categories*. Doctoral dissertation, MIT.
- Pesetsky, David. 1987. Wh-in-situ: Movement and unselective binding. In *The representation of (in)definiteness*, ed. by Eric Reuland and Alice ter Meulen, 98–129. MIT Press.
- Pesetsky, David. 1998. Some optimality principles of sentence pronunciation. In *Is the best good enough?*, ed. by Pilar Barbosa, Danny Fox, Paul Hagstrom, Martha McGinnis, and David Pesetsky, 337–383. MIT Press.
- Pesetsky, David. 2014. *Russian case morphology and the syntactic categories*. MIT Press.
- Pesetsky, David, and Esther Torrego. 2001. T-to-C movement: Causes and consequences. In *Ken Hale: A life in language*, ed. by Michael Kenstowicz, 355–426. MIT Press.
- Phillips, Colin. 1995b. Ergative subjects. In *Grammatical relations: Theoretical approaches to empirical issues*, ed. by Clifford Burgess, Katarzyna Dziwirek, and Donna Gerdts, 341–357. CSLI Publications.
- du Plessis, Hans. 1977. Wh movement in Afrikaans. *Linguistic Inquiry* 8:723–726.
- Poletto, Cecilia. 2008. Doubling as splitting. In *Microvariation in syntactic doubling*, ed. by Sjeff Barbiers, Olaf Koenenman, Marika Lekakou, and Margreet van der Ham, 37–68. Brill.
- Postal, Paul. 1969. On so-called ‘pronouns’ in English. In *Modern readings in transformational grammar*, ed. by David Reibel and Sanford Schane, 201–224. Prentice-Hall.
- Postal, Paul. 1971. *Cross-over phenomena*. Holt, Rinehart and Winston.
- Postal, Paul. 1993. Remarks on Weak Crossover effects. *Linguistic Inquiry* 24:539–556.
- Postal, Paul. 1998. *Three investigations of extraction*. MIT Press.
- Potsdam, Eric, and Dan Edmiston. 2015. Extraposition in Malagasy. Paper presented at AFLA 22.
- Preminger, Omer. 2011. *Agreement as a fallible operation*. Doctoral dissertation, MIT.
- Pylkkänen, Liina. 2008. *Introducing arguments*. MIT Press.
- Rackowski, Andrea, and Norvin Richards. 2005. Phase edge and extraction: A Tagalog case study. *Linguistic Inquiry* 36:565–599.



- Reinhart, Tanya. 1992. *Wh-in-situ: An apparent paradox*. In *Proceedings of the 8th Amsterdam Colloquium*, ed. by Paul Dekker and Martin Stokhof, 483–492. Institute for Logic, Language and Computation, University of Amsterdam.
- Reinhart, Tanya. 1998. *Wh-in-situ in the framework of the Minimalist Program*. *Natural Language Semantics* 6:29–56.
- Remijsen, Bert. 2013. Tonal alignment is contrastive in falling contours in Dinka. *Language* 89:297–327.
- Remijsen, Bert, and Leoma Gilley. 2008. Why are three-level vowel length systems rare? Insights from Dinka (Luanyjang dialect). *Journal of Phonetics* 26:318–344.
- Remijsen, Bert, and D. Robert Ladd. 2008. The tone system of the Luanyjang dialect of Dinka. *Journal of African Languages and Linguistics* 29:173–213.
- Remijsen, Bert, and Caguor Adong Manyang. 2009. Luanyjang Dinka. *Journal of the International Phonetic Association* 39:113–124.
- Reuland, Eric. 2001. Primitives of binding. *Linguistic Inquiry* 32:439–492.
- Reuland, Eric. 2011. *Anaphora and language design*. MIT Press.
- Rezac, Milan. 2011. *Phi-features and the modular architecture of language*. Springer.
- Rezac, Milan. 2013. Case and licensing: Evidence from ECM+DOC. *Linguistic Inquiry* 44:299–319.
- Richards, Norvin. 1994. Head-binding. In *Proceedings of WCCFL 12*, ed. by Erin Duncan, Donka Farkas, and Philip Spaelti, 421–437. CSLI.
- Richards, Norvin. 1997. *What moves where when in which language?* Dissertation, MIT.
- Richards, Norvin. 2000. Another look at Tagalog subjects. In *Formal issues in Austronesian linguistics*, ed. by Ileana Paul, Vivianne Phillips, and Lisa Travis, 105–116. Kluwer.
- Richards, Norvin. 2001. *Movement in language: Interactions and architectures*. Oxford University Press.
- Richards, Norvin. 2013. Lardil “case stacking” and the timing of case assignment. *Syntax* 16:42–76.
- Richards, Norvin. 2015. *Contiguity theory*. Manuscript, MIT.
- van Riemsdijk, Henk, and Edwin Williams. 1981. NP-structure. *The Linguistic Review* 1:171–217.
- Ritter, Elizabeth. 1991. Two functional categories in noun phrases: Evidence from Modern Hebrew. In *Syntax and semantics 26*, ed. by Susan Rothstein, 37–62. San Diego: Academic Press.
- Rizzi, Luigi. 1986. On Chain Formation. In *The syntax of pronominal clitics*, ed. by Hagit Borer, 65–96. Academic Press.
- Rizzi, Luigi. 1990. *Relativized Minimality*. MIT Press.
- Rizzi, Luigi. 1997. The fine structure of the left periphery. In *Elements of grammar*, ed. by Liliane Haegeman, 281–337. Springer.
- Rizzi, Luigi. 2004. Locality and left periphery. In *Structures and beyond: The cartography of syntactic structures*, ed. by Adriana Belletti, 223–251. Oxford University Press.
- Roberts, Ian. 1994. Two types of verb movement in Romance. In *Verb Movement*, ed. by Norbert Hornstein and David Lightfoot, 207–242. Cambridge University Press.
- Roberts, Ian. 2010. *Agreement and head movement*. MIT Press.

- Rodrigues, Cilene. 2004. *Impoverished morphology and A-movement out of case domains*. Doctoral dissertation, University of Maryland.
- Roettger, Lisa, and Larry Roettger. 1989. A Dinka dialect survey. *Occasional papers in the study of Sudanese languages* 6:1–64.
- Rögnvaldsson, Eiríkur. 1984. Icelandic word order and það-insertion. *Working Papers in Scandinavian Syntax* 8:1–21.
- Rögnvaldsson, Eiríkur, and Höskuldur Þráinsson. 1990. On Icelandic word order once more. In *Modern Icelandic syntax*, ed. by Joan Maling and Annie Zaenen, 3–40. Academic Press.
- Rooryck, Johan, and Guido Vanden Wyngaerd. 2011. *Dissolving binding theory*. Oxford University Press.
- Rose, Sharon, Farrell Ackerman, George Gibbard, Peter Jenks, Laura Kertz, and Hannah Rohde. 2014. In-situ and ex-situ *wh*-question constructions in Moro. *Journal of African Languages and Linguistics* 35:91–125.
- Ross, John Robert. 1967. *Constraints on variables in syntax*. Doctoral dissertation, MIT.
- Rudin, Catherine. 1988. On multiple questions and multiple *wh*-fronting. *Natural Language & Linguistic Theory* 6:445–501.
- Ruys, Eddy. 2000. Weak crossover as a scope phenomenon. *Linguistic Inquiry* 31:513–539.
- Ruys, Eddy. 2004. A note on Weakest Crossover. *Linguistic Inquiry* 35:124–140.
- Sabel, Joachim. 2013. Configurationality, successive cyclic movement and object agreement in Kiribati and Fijian. *Linguistische Berichte* 233:3–22.
- Saddy, Douglas. 1991. *Wh*-scope mechanisms in Bahasa Indonesia. In *MIT Working Papers in Linguistics 15*, ed. by Lisa Cheng and Hamida Demirdache, 183–218. MITWPL.
- Saddy, Douglas. 1992. A versus A-bar movement and WH fronting in Bahasa Indonesia. Manuscript, University of Queensland, Australia.
- Safir, Ken. 1986. Relative clauses in a theory of binding and levels. *Linguistic Inquiry* 17:663–689.
- Safir, Ken. 1996. Derivation, representation, and resumption: The domain of Weak Crossover. *Linguistic Inquiry* 27:313–339.
- Safir, Ken. 2004. *The syntax of (in)dependence*. MIT Press.
- Safir, Ken. 2014. One True Anaphor. *Linguistic Inquiry* 45:91–124.
- Saito, Mamoru. 1989. Scrambling as semantically vacuous  $\bar{A}$ -movement. In *Alternative conceptions of phrase structure*, ed. Mark Baltin and Anthony Kroch, 182–200. University of Chicago Press.
- Salzmann, Martin. 2006. Resumptive pronouns and matching effects in Zurich German relative clauses as distributed deletion. *Leiden Papers in Linguistics* 6:17–50.
- Sato, Yosuke. 2012. Successive cyclicity at the syntax-morphology interface: Evidence from Standard Indonesian and Kendal Javanese. *Studia Linguistica* 66:32–57.
- Sauerland, Uli. 1998. *The meaning of chains*. Doctoral dissertation, MIT.
- Sauerland, Uli. 2004. The interpretation of traces. *Natural Language Semantics* 12:63–127.

- Schäfer, Florian. 2012. The passive of reflexive verbs and its implications for theories of binding and case. *Journal of Comparative Germanic Linguistics* 15:213–268.
- Schlenker, Philippe. 2005. Non-redundancy: toward a semantic reinterpretation of binding theory. *Natural Language Semantics* 13:1–92.
- Schneider-Zioga, Patricia. 2007. Anti-agreement, anti-locality and minimality: The syntax of dislocated subjects. *Natural Language & Linguistic Theory* 25:403–446.
- Schuchardt, Hugo. 1911. Bari and Dinka. *Wiener Zeitschrift für die Kunde des Morgenlandes* 26:11–41.
- Sells, Peter. 1984. *Syntax and semantics of resumptive pronouns*. Doctoral dissertation, UMass Amherst.
- Sichel, Ivy. 2014. Resumptive pronouns and competition. *Linguistic Inquiry* 45:655–693.
- Sportiche, Dominique. 1996. Clitic constructions. In *Phrase structure and the lexicon*, ed. by Johan Rooryck and Laurie Ann Zaring, 213–276. Kluwer.
- Starke, Michal. 2001. *Move dissolves into Merge: A theory of locality*. Doctoral dissertation, University of Geneva.
- Starke, Michal. 2009. Nanosyntax: A short primer to a new approach to language. *Nordlyd* 36:1–6.
- von Stechow, Arnim. 2000. Some remarks of choice functions and LF-movement. In *Reference and anaphoric relations*, ed. by Klaus von Heusinger and Lars Egli, 193–228. Springer.
- Steriade, Donca. 1980. Clitic doubling in the Romanian WH constructions and the analysis of topicalization. Paper presented at CLS.
- Stowell, Tim. 1981. *Origins of phrase structure*. Doctoral dissertation, MIT.
- Stowell, Tim. 1982. The tense of infinitives. *Linguistic Inquiry* 13:561–570.
- Takahashi, Shoichi. 2006. *Compositionality and identity*. Doctoral dissertation, MIT.
- Takahashi, Shoichi and Danny Fox. 2005. MaxElide and the rebinding problem. In *Proceedings from SALT XV*, ed. by Effi Georgala and Jonathan Howell, 223–240. CLC Publications.
- Takahashi, Shoichi, and Sarah Hulsey. 2009. Wholesale Late Merger: Beyond the A/ $\bar{A}$ -distinction. *Linguistic Inquiry* 40:387–426.
- Thiersch, Craig. 1978. *Topics in German syntax*. Doctoral dissertation, MIT.
- Torrego, Esther. 1984. On inversion in Spanish and some of its effects. *Linguistic Inquiry* 15:103–129.
- Torrence, Harold. 2005. *On the distribution of complementizers in Wolof*. Doctoral dissertation, UCLA.
- Travis, Lisa. 1984. *Parameters and effects of word order variation*. Doctoral dissertation, MIT.
- Trinh, Tue. 2011. *Edges and linearization*. Doctoral dissertation, MIT.
- Tucker, Archibald N. 1938. *Rules for Dinka spelling and word division*. London.
- Tucker, Archibald N. 1967. *The Eastern Sudanic languages*. International African Institute.
- Tucker, Archibald N. 1981. Le Dinka (Agar). in *Les langues dans le monde ancien et moderne*, ed. by Jean Perrot, 293–308. CNRS.

- Tucker, Archibald N., and Margaret A. Bryan. 1966. *Linguistic analyses: The non-Bantu languages of North-Eastern Africa*. Oxford University Press.
- Trudinger, Ronald. 1942–44. *Compiled English-Dinka Dictionary*. Sudan Interior Mission.
- Þráinsson, Höskuldur. 1979. *On complementation in Icelandic*. Garland.
- Þráinsson, Höskuldur. 2007. *The syntax of Icelandic*. Cambridge University Press.
- Ura, Hiroyuki. 1994. *Varieties of raising and the feature-based phrase structure theory*. Doctoral dissertation, MIT.
- Uriagereka, Juan. 1988. *On government*. Doctoral dissertation, UConn.
- Uriagereka, Juan. 1995. Aspects of the syntax of clitic placement in Western Romance. *Linguistic Inquiry* 26:79–123.
- van Urk, Coppe, and Norvin Richards. 2015. Two components of long-distance extraction: Successive cyclicity in Dinka. *Linguistic Inquiry* 46:113–155.
- Vanden Wyngaerd, Guido. 1989. Object Shift as an A-Movement rule. *MIT Working Papers in Linguistics* 11, 256–271.
- Vangsnes, Øystein Alexander. 2008. On peripheral doubling in Scandinavian. In *Microvariation in syntactic doubling*, ed. by Sjef Barbiers, Olaf Koenenman, Marika Lekakou, and Margreet van der Ham, 419–442. Brill.
- Vicente, Luis. 2007. *The syntax of heads and phrases: A study of verb (phrase) fronting*. Doctoral dissertation, Leiden University.
- Vikner, Sten. 1995. *Verb movement and expletive subjects in the Germanic languages*. Oxford University Press.
- Wasike, Aggrey Khaoya. 2007. *The left periphery, wh- in-situ and A-bar movement in Lubukusu and other Bantu languages*. Doctoral dissertation, Cornell University.
- Wasow, Thomas. 1972. *Anaphoric relations in English*. Doctoral dissertation, MIT.
- Webelhuth, Gert. 1989. *Syntactic saturation phenomena and the Modern Germanic Languages*. Doctoral dissertation, UMass Amherst.
- Wechsler, Stephen, and I Wayan Arka. 1998. Syntactic ergativity in Balinese: Argument structure based theory. *Natural Language & Linguistic Theory* 16:387–441.
- Westermann, Diedrich. 1912. Short vocabularies of the Dinka, Golo and Zande Languages. *Mitteilungen des Seminars für orientalische Sprachen* 15:151–154.
- Williams, Edwin. 2003. *Representation theory*. MIT Press.
- Wiltschko, Martina. 1998. Superiority in German. In *Proceedings of WCCFL 16*, ed. by Emily Curtis, James Lyle, and Gabriel Webster, 431–446. CSLI.
- Wurmbbrand, Susi. 1998. *Infinitives*. Doctoral dissertation, MIT.
- Zaenen, Annie, Engdahl, Elisabet, and Joan Maling. 1981. Resumptive pronouns can be syntactically bound. *Linguistic Inquiry* 12:679–692.
- Zaenen, Annie, and Joan Maling. 1977. TOPIC-position. Paper presented at the LSA.