

MIT Open Access Articles

*Modularity, context-dependence, and
insulation in engineered biological circuits*

The MIT Faculty has made this article openly available. **Please share**
how this access benefits you. Your story matters.

Citation: Del Vecchio, Domitilla. "Modularity, Context-Dependence, and Insulation in Engineered Biological Circuits." Trends in Biotechnology 33.2 (2015): 111–119.

As Published: <http://dx.doi.org/10.1016/j.tibtech.2014.11.009>

Publisher: Elsevier

Persistent URL: <http://hdl.handle.net/1721.1/110379>

Version: Author's final manuscript: final author's manuscript post peer review, without publisher's formatting or copy editing

Terms of use: Creative Commons Attribution-NonCommercial-NoDerivs License



Modularity, context dependence, and insulation in engineered biological circuits

Domitilla Del Vecchio
Department of Mechanical Engineering, MIT
77 Massachusetts Ave, Cambridge
ddv@mit.edu

September 15, 2014

Abstract. The ability of linking systems together such that they behave as predicted once interacting with each other is an essential requirement for the forward engineering of robust synthetic biological circuits. Unfortunately, because of context dependencies, parts and functional modules often behave unpredictably once interacting in the cellular environment. In this paper, we review some recent advances toward establishing a rigorous engineering framework for insulating parts and modules from their context to improve modularity. Overall, a synergy between engineering better parts and higher-level circuit design that overcome the physical limitations of available parts will be important to resolve the problem of context dependence.

Modularity and context-dependence in engineered biological systems

Synthetic biology, that is, the use of molecular biology techniques to forward engineer cellular behavior, is a rising branch of biological research [1]. One aim of the field is to gather a better understanding of natural systems by re-wiring their subsystems and exporting them to new settings. The ability of re-designing living systems has especially potential in the biotechnology industry, promising a number of breakthroughs in human health and the environment. Designing living systems does not simply rely on the engineering of parts, such as proteins or genetic sequences. In contrast, it essentially requires the ability of linking parts together to create sophisticated functionalities. Linking parts together to achieve a predictable behavior is

a major challenge of the field. In this paper, we review some of the latest advances toward establishing a rigorous engineering framework to overcome this challenge.

As the engineering of biological systems progresses from building simple functional modules to creating large sophisticated systems, a bottom-up approach to design becomes desirable [1, 2, 3]. Within a bottom-up design process, basic parts, such as promoters, terminators, ribosome binding sites, and gene coding sequences, are assembled together to create simple functional modules, such as toggle switches [4], oscillators [5, 6, 7], and cascades [8]. These modules are then combined with each other to obtain more complicated systems, such as the artificial tissue homeostasis system proposed to regulate the concentration of β cells in the pancreas [9] or the synthetic payload delivery device that delivers macromolecules in the cytoplasm of cancer cells *in vitro*. [10].

When designing systems bottom-up it is fundamental that basic parts and functional modules keep their essential properties unchanged once they are part of a larger system. This *modularity* assumption allows reliable prediction of the behavior of a system from the behavior of the composing building blocks and has been critical in many other engineering disciplines, including for the development of large-scale integrated circuits in Electronics [11]. In fact, modularity spares the need to co-optimize or even re-design building blocks once interacting with each other, and thus makes the design process scalable, systematic, and substantially faster. In biological engineering, unfortunately, the progress has been hampered by the fact that the salient properties of both basic parts and functional modules depend on their context, which includes the surrounding parts and modules [12]. Here, we review some of the main reasons of this *context dependence* focusing on rigorous engineering solutions that have been recently proposed to *insulate* parts and functional modules from their context, thus enforcing modularity.

Basic parts and functional modules have key properties that should stay unchanged upon composition. Promoters' activity, ribosome binding sites' strength, and terminators' efficiency should be independent of the genetic context. Similarly, the period and amplitude of an oscillator, the switching time of a toggle switch, the sensitivity of a cascade, should not depend on the surrounding systems. If the robustness of a module's features were implied by the robustness of the composing basic parts, we could simply focus on making robust parts. Unfortunately, as it will be illustrated later, modularity of basic parts does not imply modularity of the circuit they compose. Hence, we will make a distinction between modularity of basic parts and modularity of functional modules.

Modularity of basic parts

A basic part's salient feature is often affected by the genetic sequences surrounding it due to unknown structural interactions between adjacent genetic sequences and factors. For example, the efficiency and position of transcriptional termination markedly depends on the sequences upstream of the terminator [13]. The activity of a promoter depends on the sequences that surround it, in particular, the sequences upstream of the -35 site and downstream of the -10 site affect transcription initiation and promoter escape, respectively [14]. The strength of a ribosome binding site is affected by interactions with the 5' UTR sequence and by complicated secondary structures that form across the 5' UTR sequence and the initial gene coding sequence [15] (Figure 1A). These facts confound system design because, for example, the same combination of promoter and ribosome binding site will result in different and unpredictable protein production rates depending on the specific gene being expressed.

Mitigating context dependence of basic parts is subject of intense engineering efforts and promising solutions have recently appeared. These solutions usually aim at reducing possible structural interactions through the use of insulators that spatially separate key parts from each other (Figure 1B). In particular, to render a promoter transcriptional activity independent of the genetic context, a promoter cassette can be expanded to include standard adjoining sequences upstream of the -35 box and downstream of the -10 box. A library of promoter cassettes containing these adjoining sequences were tested across different genetic contexts showing that promoter activity can be more reliably predicted when the genetic context is changed [16]. To decouple the properties of the promoter from those of the ribosome binding site, the 5' UTR sequence can be physically separated from the ribosome binding site to avoid unpredictable interference between these two. This can be obtained by inserting either a rybozyme or a CRISPR target sequence between the 5' UTR sequence and the ribosome binding site [17, 18, 19]. Testing of constructs with different UTR sequences demonstrated that insertion of a CRISPR target sequence substantially reduces variability in protein production rate [18]. Similarly, employment of rybozymes in NOT gates showed robustness to the genetic context [17]. Finally, the complicated interference due to secondary structure across the 5' UTR and initial gene coding sequence can be further mitigated by the introduction of a standard translation initiation element that contains two Shine-Dalgarno sequences as opposed to containing one only [20].

These results establish a solid basis for insulation of basic parts from

their genetic context and at the same time raise a number of questions for future research. These include the scalability of these approaches to systems with many genes and the possibility of interactions between the synthetic RNA processing and the natural RNA processing of the host.

Modularity of functional modules: The effects of loads

At the higher level of the circuit abstraction hierarchy, functional modules, such as cascades, toggle switches, and oscillators, are subject to context dependencies even when the parts they are composed of behave robustly across different contexts. In this section, we examine one such cause of context dependence, that is, the effect of loads on a module’s output, and illustrate engineering solutions for its mitigation. To understand the problem of loads in a biological circuit, consider as an example the activator-repressor clock by [6] shown in Figure 2AB. To connect the clock to a downstream system, we can use the activator protein A as a regulator for some gene in the downstream system (Figure 2C). Protein A regulates the expression of a gene in the downstream system by binding to operator sites in the promoter controlling this gene. The resulting reversible binding reactions between A and these operator sites temporarily sequester A from the reactions that make the clock, leading to delays that can disrupt the clock’s function (Figure 2D).

Several researchers have reported experimental results documenting the effects of loads on a circuit’s salient features. It was found that the temporal response of a genetic cascade was substantially slowed down by the presence of target operator sites for the cascade output protein [21]. The steady state input/output response of the cascade was also changed by these operator sites, leading to phenomena such as ultrasensitivity and thresholding [22, 23]. Signal transduction circuits are also subject to loading effects. In fact, experiments performed on signaling cascades both *in vitro* and *in vivo* reported substantial delays in the cascade temporal response and changes in the cascade’s steady state due to the presence of target proteins [24, 25, 26, 27]. Further computational studies have uncovered that the amplitude and period of oscillations in genetic clocks depend on the presence and concentration of operator sites for the clock’s proteins [28]; these sites can even cause clock’s failure [29]. The salient features of a genetic toggle switch, such as the switching time and the duration of the stimulus required for flipping the state, is also largely impacted by the presence of

operator sites for the circuit proteins [30, 31]. Hence, if the output protein of a functional module is used as a regulator in a downstream system, the module’s salient features change. This change, that is, the effects of loads on the output protein, have the undesirable consequence that the downstream system fails to be regulated as expected and this fact hinders system design.

We next review a “signals and systems” engineering approach that has been proposed to formalize the problem of loads and make load mitigation amenable to rigorous solutions. “Signals and systems” is a well-established discipline of Electrical Engineering that is dedicated to understand how physical (mostly electrical) systems process signals, a physical quantity that carries information [32]. In biological circuits, a system is a set of biological processes that create, destroy, or modify proteins and smaller molecules. Within these systems, we typically view the amounts (number or concentration) of a molecule as the signal carrier, although different signal carriers are possible and have been proposed [33]. Some signals can be *inputs* or *outputs* of a system and they represent the concentration of the input or output molecules, respectively, of the system. For example, for a genetic activation cascade, the input molecule can be a transcription factor that activates the expression of the first gene in the cascade. The output molecule is a protein produced by a gene in the cascade, which can be used to regulate genes outside of the cascade. For a two-component signaling system [34] the input molecule is often the enzyme, a kinase, for example, that activates the substrate protein, while the output molecule is often the product of the enzymatic reaction, for example, the phosphorylated protein, since it can be used to regulate targets outside of the system.

We will say that system S_1 is *connected* to system S_2 if the output molecule of S_1 regulates some process in S_2 . In this case we will also say that S_2 is *downstream* of S_1 , thus viewing the information as traveling *from* system S_1 *to* system S_2 . When system S_1 is connected to system S_2 , the issue of load arises due to the additional reaction fluxes to which the output molecule of S_1 is subjected to when system S_2 is present. These additional reaction fluxes have been called *retroactivity* to precisely identify the physical origin of loads in biological systems. Accordingly, a system’s concept that explicitly accounts for retroactivity has been proposed [35, 36]. Related but different system concepts have been proposed by systems theorists much earlier [37, 38]. Within this system’s concept, in addition to the input and output signals, we have two additional signals that travel from downstream to upstream (Figure 3A). Signal “ s ” is termed the retroactivity to the output of the system and represents the additional reaction flux to which the output molecule of the system is subjected to when it serves as an input to a down-

stream system. For the clock example, s is the net reaction flux resulting from the reversible binding between the activator A and the downstream system’s operator sites. Signal “ r ” is termed the retroactivity to the input and represents the additional reaction flux that the system imposes on its upstream system when these two are connected. These retroactivity signals are conceptually similar to the current flowing between two electrical terminals when connected to each other and to the fluid flow between two tanks when these are connected through a pipe. An extensive treatment of how to determine the effects of retroactivity in genetic circuits based on this framework can be found in [30].

In order to mitigate retroactivity effects, it has been proposed to employ *insulation devices* [35, 39]. An insulation device is placed between an upstream and a downstream system such that the load (retroactivity s) is transferred to the insulation device (Figure 3B). The insulation device should have three key properties:

- (i) the output y of the insulation device should be practically independent of retroactivity s (load mitigation);
- (ii) it should have a negligible retroactivity to the input r (it applies negligible load to its upstream system);
- (iii) provided (i) and (ii) are satisfied, the output y should be approximately proportional to the input u (proportionality).

By virtue of these three properties, the upstream system’s output signal is transferred to the downstream system input signal despite loading and, as a consequence, the downstream system is properly regulated.

Load mitigation (i) can be obtained by employing disturbance attenuation ideas that have been developed by control theory for making the output signal of any system robust to disturbances [40]. The core concept of disturbance attenuation for mitigating the effect of retroactivity s is depicted in the block diagram of Figure 4A. The input u of the insulation device is compared to the output y of the insulation device to form the error e . This error is then amplified through a gain G , summed to the contribution of retroactivity s (the disturbance) to obtain the output y . This diagram gives the equation

$$y = G(u - Ky) + s \quad \Rightarrow \quad y = \frac{Gu}{(1 + GK)} + \frac{s}{(1 + GK)},$$

from which it follows that when the gain G is very large (independent of the specific value), we have that $y \approx u/K$, which is independent of retroactivity

s . This concept can be made more concrete by re-writing this block diagram as in Figure 4B, which can be interpreted as follows. For the output y of the insulation device to be practically independent of the retroactivity s , we should (a) amplify the input through a large gain G and (b) apply a similarly large negative feedback gain G' on the output.

A biomolecular process that can realize both (a) and (b) is a phosphorylation cycle (Figure 4C), which, when the amounts of inactive protein substrate y_{in} and phosphatase p are sufficiently high, can function as an insulation device [35]. Specifically, the output protein y is generated by the inlet phosphorylation flux (proportional to the concentration of the substrate y_{in}) and is decreased by the outlet dephosphorylation flux (proportional to the concentration of the phosphatase p). When the demand for the output protein y increases due to load, the large inlet flux quickly generates more y , while the large outlet flux guarantees that no more y than required to track the concentration of the input u is generated. This system has been implemented using the NRI/NRII TCS system of *E. coli*, in which the authors showed that increased phosphatase and substrate amounts make, as predicted from theory, the system's response independent of load [41]. However, the authors also showed that increasing these amounts make the temporal response of the device substantially slower. This violates the proportionality requirement (iii) since the device introduces delays in the critical path from the upstream to the downstream system.

This limitation was overcome by employing multiple stages of phosphorylation, instead of just one, and by discovering a more general design principle for retroactivity attenuation realizable by molecular processes that do not necessarily have the explicit input amplification and negative feedback structure shown in Figure 4B. The core idea of this design principle is based on separation of time scales. Basically, if the characteristic time scales of the processes in the insulation device are much faster than the rate of change of the input u , then the effects of retroactivity s are mitigated [42]. This is because any load-induced delays occur at the faster time scale of the insulation device and therefore they are negligible for the operation of the slower flanking modules. Based on this principle, if the upstream and downstream systems are genetic circuits, with characteristic slow time scales dictated by gene expression, an intervening insulation device can be designed employing a number of processes, including phosphorylation, phosphotransfer, methylation, or their combinations, since they have relatively faster time scales. A particular instance of an insulation device, called the load driver, was constructed based on this principle in yeast cells employing a two-stage YPD1/SKN7 phosphotransfer cascade [43]. This device has a remarkable

ability of attenuating retroactivity, applies no substantial load to its upstream system, and has an extremely fast response, therefore satisfying all three requirements of an insulation device.

In general, obtaining a device that applies a negligible load to its upstream system (ii) and has the proportionality property (iii) rely on a careful modeling study of the specific molecular process chosen for the insulation device. For example, for covalent modification cycles and their composition, conditions on the parameters that guarantee these features have been extensively studied [34, 35, 44].

When creating future systems composed of multiple modules, a designer will have to examine each interconnection one at the time through available modeling tools (see, for example [30, 31, 45]) in order to assess potential loading problems. In case loading problems are found, an insulation device, composed of processes orthogonal to those of already inserted insulation devices, will be chosen from a library. Prior to insertion of the insulation device in the experimental system, simulation and modeling studies will be employed to determine suitable gains and timescales that allow the three key requirements of an insulation device (i)-(iii).

For this approach to be scalable, libraries of orthogonal load drivers will have to be developed. The possibility of creating multiple orthogonal load drivers is provided by the existence of hundreds of orthogonal two-component signaling motifs [46] and by the fact that multiple such motifs can be simultaneously implemented within the same cell with minimal crosstalk [47]. However, scaling up the size of synthetic circuits will require to overcome another central cause of context dependence, which arises from competition by synthetic circuits for a limited amount of cellular resources, the subject of the next section.

Modularity of functional modules: The effects of resource sharing

Synthetic circuits use cellular resources, such as transcription/translation machinery, enzymes, and ATP, which are found in limited amounts and are shared with the host circuitry (Figure 5). As the size of synthetic circuits increases, the depletion of these resources, chiefly RNA polymerase and ribosomes, can become a bottleneck for both cell growth and circuit performance [48, 49, 50, 51, 52]. Expression of extraneous genes imposes a load on transcriptional/translational resources, which can affect cell growth [51] and the production of other proteins in the cell [53]. Changes on cell growth and

gene expression levels have very subtle consequences on the operation of gene circuits. Growth rate change during circuit operation leads to variations in protein dilution rates, which, in turn, bring about unexpected phenotypes such as bistability [54]. Further computational studies have found that, because modules share limited amounts of transcriptional/translational resources, the expression levels of proteins in seemingly unconnected modules become surprisingly coupled [55, 56] and the dynamical behavior of simple activation cascades becomes unpredictable [57]. Counter-intuitive interactions have also been experimentally observed when different modules share common enzymes, whose scarcity leads to interesting synchronized behavior [58]. All these effects make a module’s salient properties poorly predictable and, as a result, confound system design.

Most engineering efforts have focused on mitigating the impact of synthetic circuits on cell fitness, while the problem of decoupling modules’ behavior from each other remains largely open. Solutions have aimed at creating a pool of highly specific transcriptional/translational resources that would be exclusively used by synthetic circuits. As far as transcriptional resources are concerned, RNA polymerase from phage T7 allows, to some extent, to decouple transcription from the host resources [59]. More recently, several other RNA polymerases have been identified from other phages or from directed evolution experiments [60, 61, 62]. Due to the high transcription efficiency of these polymerases, toxicity is often an issue and hence their concentration should be limited. To this end, a system has been fabricated that allows allocating a core RNA polymerase to different genes through the aid of suitably designed sigma factors. The total amount of active RNA polymerase is limited by the expression level of the core RNA polymerase, whose concentration is kept below the toxicity threshold. Mechanisms for implementing both negative and positive regulation of the core RNA polymerase are also provided [63]. These could serve as a versatile platform for implementing future algorithms to decouple synthetic modules’ behavior from each other.

As far as translational resources are concerned, orthogonal ribosomes (O-ribosomes) have been proposed as a mechanism to decouple translation of endogenous mRNA from translation of the mRNA of synthetic circuits [64, 65]. O-ribosomes specifically translate their cognate O-mRNA, which is not recognized by endogenous ribosomes. This is realized by an altered Shine-Dalgarno sequence in the leading sequence of the O-mRNA, which is recognized exclusively by the O-ribosomes. While orthogonal ribosomes can in principle mitigate the impact of over-expressing synthetic circuits’ mRNAs on cell fitness, the question of how to diminish the couplings among

different synthetic modules that share O-ribosomes remains largely open.

Concluding remarks and future perspectives

Context-dependence affects both basic parts and functional modules, wherein modularity of parts does not imply modularity of the modules they constitute. While substantial progress has been made for insulating basic parts from their genetic context and functional modules from the systems they connect to, the problem of insulating synthetic systems from the host is still a major problem. Orthogonal RNA polymerases and ribosomes can, to some extent, mitigate the load on host's transcription/translation resources applied by synthetic circuits, but they cannot eliminate the subtle couplings among synthetic circuits due to competition for limited resources. These lead to unpredictable behavior and, as a consequence, confound system design. Although, in principle, one could decouple the functionality of modules by having a set of transcription/translation resources specifically dedicated to each synthetic module, in practice this will hardly be realizable as the number of modules increases.

Other engineering areas have faced similar challenges due to physical limitations of the parts being used. These limitations have often been surmounted by shifting the attention from designing better parts to using the available parts in clever designs that could as a whole lead to overcome the part's physical limitations. A memorable example is that of the first transcontinental telephone line, in which amplifiers placed along the line to prevent signal attenuation would cause unacceptable signal distortion. To solve this problem, engineers at the time (1920s) were focusing on improving the physical properties of the amplifiers, hitting the limits of what was physically possible. The breakthrough in this problem came when H. S. Black demonstrated that placing these amplifiers in a carefully designed feedback loop would lead to a new amplifier, later called the negative feedback amplifier, that was essentially immune to distortion [66].

It is therefore sensible to assume that advancements into finding suitable solutions to the context dependence issue will require joint efforts between researchers that focus on building better parts, pushing the boundaries of physics, and researchers that invent circuit design approaches to overcome the fundamental physical limitations of such parts.

References

- [1] D. E. Cameron, C. J. Bashor, and J. J. Collins, “A brief history of synthetic biology,” *Nature Reviews Microbiology*, vol. 12, pp. 381–390, 2014.
- [2] P. Purnick and R. Weiss, “The second wave of synthetic biology: from modules to systems,” *Nature reviews. Molecular cell biology*, vol. 10, pp. 410–22, 2009.
- [3] A. L. Slusarczyk, A. Lin, and R. Weiss, “Foundations for the design and implementation of synthetic genetic circuits,” *Nature Reviews Genetics*, vol. 13, pp. 406–420, 2012.
- [4] T. Gardner, C. Cantor, and J. Collins, “Construction of the genetic toggle switch in *Escherichia Coli*,” *Nature*, vol. 403, pp. 339–342, 2000.
- [5] M. B. Elowitz and S. Leibler, “A synthetic oscillatory network of transcriptional regulators,” *Nature*, vol. 403, pp. 339–342, 2000.
- [6] M. R. Atkinson, M. A. Savageau, J. T. Meyers, and A. J. Ninfa, “Development of genetic circuitry exhibiting toggle switch or oscillatory behavior in *Escherichia coli*,” *Cell*, vol. 113, pp. 597–607, 2003.
- [7] J. Stricker, S. Cookson, M. R. Bennett, W. H. Mather, L. S. Tsimring, and J. Hasty, “A fast, robust and tunable synthetic gene oscillator,” *Nature*, vol. 456, pp. 516–519, 2008.
- [8] S. Hooshangi, S. Thiberge, and R. Weiss, “Ultrasensitivity and noise propagation in a synthetic transcriptional cascade,” *Proceedings of the National Academy of Sciences*, vol. 102, pp. 3581–3586, 2005.
- [9] M. Miller, M. Hafner, E. Sontag, N. Davidsohn, S. Subramanian, P. Purnick, D. Lauffenburger, and R. Weiss, “Modular design of artificial tissue homeostasis: robust control through synthetic cellular heterogeneity,” *PLoS computational biology*, vol. 8, p. e1002579, 2012.
- [10] J. H. Huh, J. T. Kittleson, A. P. Arkin, and J. C. Anderson, “Modular design of artificial tissue homeostasis: robust control through synthetic cellular heterogeneity,” *ACS Synthetic Biology*, vol. 2, pp. 418–424, 2013.
- [11] D. Schilling and C. Belove, *Electronic Circuits: Discrete and Integrated*. McGraw Hill, 1968.

- [12] S. Cardinale and A. P. Arkin, “Contextualizing context for synthetic biology identifying causes of failure of synthetic biological systems,” *Biotechnology Journal*, vol. 7, p. 856866, 2012.
- [13] L. E. Macdonald, R. K. Durbin, J. J. Dunn, and W. T. McAllister, “Characterization of two types of termination signal for bacteriophage t7 rna polymerase,” *J. Mol. Biol.*, vol. 238, pp. 145–158, 1994.
- [14] V. A. Rhodius, V. K. Mutalik, and C. A. Gross, “Predicting the strength of up-elements and full-length *e. coli* σ E promoters,” *Nucleic Acids Res.*, vol. 0.1093/nar/gkr1190, 2012.
- [15] S. Kosuria, D. B. Goodman, G. Cambray, V. K. Mutalik, Y. Gaog, D. E. A. P. Arkin and, and G. M. Church, “Composability of regulatory sequences controlling transcription and translation in *escherichia coli*,” *Proc. National Academy of Science*, vol. 110, no. 34, pp. 14024–14029, 2013.
- [16] J. H. Davis, A. J. Rubin, and R. T. Sauer, “Design, construction and characterization of a set of insulated bacterial promoters,” *Nucleic Acids Research*, vol. 39, no. 3, pp. 1131–1141, 2010.
- [17] C. Lou, B. Stanton, Y.-J. Chen, B. Munsy, and C. A. Voigt, “Ribozyme-based insulator parts buffer synthetic circuits from genetic context,” *Nat. BIotechnology*, vol. 30, no. 11, p. 1137?1142, 2012.
- [18] L. Qi, R. E. Haurwitz, W. Shao, J. A. Doudna, and A. P. Arkin, “Rna processing enables predictable programming of gene expression,” *Nat. BIotechnology*, vol. 30, no. 10, pp. 1002–1006, 2012.
- [19] C. J. Bashor and J. J. Collins, “Insulating gene circuits from context by rna processing,” *Nat. BIotechnology*, vol. 30, no. 11, pp. 1061–1062, 2012.
- [20] V. K. Mutalik, J. C. Guimaraes, G. Cambray, C. Lam, M. J. Christoffersen, Q.-A. Mai, A. B. Tran, M. Paull, J. D. Keasling, A. P. Arkin, and D. Endy, “Precise and reliable gene expression via standard transcription and translation initiation elements,” *Nat. Methods*, vol. 10, no. 4, pp. 354–360, 2013.
- [21] S. Jayanthi, K. Nilgiriwala, and D. Del Vecchio, “Retroactivity controls the temporal dynamics of gene transcription,” *ACS Synthetic Biology*, vol. DOI: 10.1021/sb300098w, 2013.

- [22] T.-H. Lee and N. Maheshri, “A regulatory role for repeated decoy transcription factor binding sites in target gene expression,” *Mol. Syst. Biol.*, p. 576, 2012.
- [23] R. C. Brewster, F. M. Weinert, H. G. Garcia, D. Song, M. Rydenfelt, and R. Phillips, “The transcription factor titration effect dictates level of gene expression,” *Cell*, no. 6, pp. 1312–1323, 2014.
- [24] P. Jiang, A. C. Ventura, E. D. Sontag, A. J. Ninfa, and D. Del Vecchio, “Load-induced modulation of signal transduction networks,” *Science Signaling*, vol. 4, p. ra67, 2011.
- [25] A. C. Ventura, P. Jiang, L. V. Wassenhove, D. Del Vecchio, S. D. Merajver, and A. J. Ninfa, “Signaling properties of a covalent modification cycle are altered by a downstream target,” *Proc. Natl. Acad. Sci., USA*, vol. 107, pp. 10032–10037, 2010.
- [26] Y. Kim, Z. Paroush, K. Nairz, E. Hafen, G. Jiménez, and S. Y. Shvartsman, “Substrate-dependent control of mapk phosphorylation in vivo,” *Mol. Sys. Biol.*, vol. 7, p. 467, 2011.
- [27] Y. Kim, M. Coppey, R. Grossman, L. Ajuria, G. Jiménez, Z. Paroush, and S. Y. Shvartsman, “Mapk substrate competition integrates patterning signals in the drosophila embryo,” *Curr. Biol.*, vol. 20, pp. 446–451, 2010.
- [28] M. R. Bennett, D. Volfson, L. Tsimring, and J. Hasty, “Transient dynamics of genetic regulatory networks,” *Biophysical Journal*, vol. 92, pp. 3501–3512, 2007.
- [29] S. Jayanthi and D. Del Vecchio, “Tuning genetic clocks employing DNA binding sites,” *PLoS ONE*, vol. 7, p. e41019, 2012.
- [30] A. Gyorgy and D. Del Vecchio, “Modular composition of gene transcription networks,” *PLOS Computational Biology*, vol. DOI: 10.1371/journal.pcbi.1003486, 2014.
- [31] S. M. Lyons, W. Xu, J. Medford, and A. Prasad, “Loads bias genetic and signaling switches in synthetic and natural systems,” *PLOS Computational Biology*, vol. DOI: 10.1371/journal.pcbi.1003533, 2014.
- [32] A. V. Oppenheim, A. S. Willsky, and S. Hamid, *Signals and Systems*. Pearson, 2nd ed., 1996.

- [33] J. R. Kelly, A. J. Rubin, J. H. Davis, C. M. Ajo-Franklin, J. Cumbers, M. J. Czar, K. de Mora, A. L. Gliberman, D. D. Monie, and D. Endy, “Measuring the activity of biobrick promoters using an in vivo reference standard,” *Journal of Biological Engineering*, vol. 3, p. 4, 2009.
- [34] A. Goldbeter and D. E. Koshland, “An amplified sensitivity arising from covalent modification in biological systems,” *Proc. National Academy of Sciences*, vol. 78, pp. 6840–6844, 1981.
- [35] D. Del Vecchio, A. J. Ninfa, and E. D. Sontag, “Modular cell biology: Retroactivity and insulation,” *Molecular Systems Biology*, vol. 4:161, 2008.
- [36] J. Saez-Rodriguez, A. Kremling, and E. Gilles, “Dissecting the puzzle of life: modularization of signal transduction networks,” *Computers and Chemical Engineering*, vol. 29, pp. 619–629, 2005.
- [37] H. Paynter, *Analysis and design of engineering systems*. Cambridge, Mass.: M.I.T. Press, 1961.
- [38] J. W. Polderman and J. C. Willems, *Introduction to Mathematical Systems Theory. A Behavioral Approach. 2nd ed.* New York: Springer-Verlag, 2007.
- [39] D. Del Vecchio and R. M. Murray, *Biomolecular Feedback Systems*. Princeton, 1st ed., 2014.
- [40] K. J. Åström and R. M. Murray, *Feedback Systems: An Introduction for Scientists and Engineers*. Princeton University Press, 2008.
- [41] K. Nilgiriwala, P. M. Rivera-Ortiz, J. Jimenez, and D. Del Vecchio, “A tunable amplifying buffer in *e. coli*,” *ACS Synthetic Biology, Conditionally Accepted*, 2014.
- [42] S. Jayanthi and D. Del Vecchio, “Retroactivity attenuation in biomolecular systems based on timescale separation,” *IEEE Trans. Aut. Control*, vol. 56, pp. 748–761, 2011.
- [43] D. Mishra, P. M. Rivera-Ortiz, A. Lin, D. Del Vecchio, and R. Weiss, “A load driver device to engineer modularity in biological circuits,” *Nat. Biotechnology, To Appear*, 2014.
- [44] H. R. Ossareh, A. C. Ventura, S. D. Merajver, and D. Del Vecchio, “Long signaling cascades tend to attenuate retroactivity,” *Biophysical Journal*, vol. 100, no. 7, pp. 1617–1626, 2011.

- [45] K. H. Kim and H. M. Sauro, “Measuring retroactivity from noise in gene regulatory networks,” *Biophysical Journal*, vol. 100, pp. 1167–1177, 2011.
- [46] M. T. Laub and M. Goulian, “Specificity in two-component signal transduction pathways,” *Annu. Rev. Genet.*, vol. 41, pp. 121–145, 2007.
- [47] W. R. Whitaker, S. Davis, A. P. Arkin, and J. E. Dueber, “Engineering robust control of two-component system phosphotransfer using modular scaffolds,” *Proc. Natl. Acad. Sci. U. S. A.*, vol. 109, pp. 18090–18095, 2012.
- [48] S. Klumpp and T. Hwa, “Growth-rate-dependent partitioning of rna polymerases in bacteria,” *Proc Natl Acad Sci USA*, vol. 105, pp. 20245–20250, 2008.
- [49] F. Moser, N. J. Broers, S. Hartmans, A. Tamsir, R. Kerkman, J. A. Roubos, R. Bovenberg, and C. A. Voigt, “Genetic circuit performance under conditions relevant for industrial bioreactors,” *ACS Synth Biol*, vol. 1, pp. 555–564, 2012.
- [50] J. Carrera, G. Rodrigo, V. Singh, B. Kirov, and A. Jaramillo, “Empirical model and in vivo characterization of the bacterial response to synthetic gene expression show that ribosome allocation limits growth rate,” *Biotechnol J*, vol. 6, pp. 773–783, 2011.
- [51] M. Scott, C. W. Gunderson, E. M. Mateescu, Z. Zhang, and T. Hwa, “Interdependence of cell growth and gene expression: Origins and consequences,” *Science*, vol. 330, pp. 1099–1102, 2010.
- [52] S. Cardinale, M. P. Joachimiak, and A. P. Arkin, “Effects of genetic variation on the *e. coli* host-circuit interface,” *Cell Reports*, vol. 4, pp. 231–237, 2013.
- [53] J. Vind, M. A. Sorensen, M. D. Rasmussen, and S. Pedersen, “Synthesis of proteins in *escherichia coli* is limited by the concentration of free ribosomes. expression from reporter genes does not always reflect functional mRNA levels,” *J. Mol. Biol.*, vol. 231, p. 678?688, 1993.
- [54] C. Tan, P. Marguet, and L. You, “Emergent bistability by a growth-modulating positive feedback circuit,” *Nature chemical biology*, vol. 5, no. 11, pp. 842–848, 2009.

- [55] W. H. Mather, J. Hasty, L. S. Tsimring, and R. J. Williams, “Translational cross talk in gene networks,” *Biophysical Journal*, vol. 104, pp. 2564–2572, 2013.
- [56] A. Gyorgy and D. Del Vecchio, “Limitations and trade-offs in gene expression due to competition for shared cellular resources,” in *Proc. IEEE Conf. Decision and Control*, p. To Appear, 2014.
- [57] E. Yeung, J. Kim, and R. M. Murray, “Resource competition as a source of non-minimum phase behavior in transcription-translation systems,” in *Proc. IEEE Conf. Decision and Control*, pp. 4060 – 4067, 2013.
- [58] N. A. Cookson, W. H. Mather, T. Danino, O. Mondragón-Palomino, R. J. Williams, L. S. Tsimring, and J. Hasty, “Queueing up for enzymatic processing: correlated signaling through coupled degradation,” *Mol. Syst. Biol.*, vol. 7, no. 561, 2011.
- [59] M. Chamberlin, J. Mcgrath, and L. Waskell, “New RNA polymerase from *escherichia coli* infected with bacteriophage T7,” *Nature*, vol. 228, pp. 227–231, 1970.
- [60] K. Temme, R. Hill, T. H. Segall-Shapiro, F. Moser, and C. A. Voigt, “Modular control of multiple pathways using engineered orthogonal T7 polymerases,” *Nucleic Acids Res.*, vol. 40, pp. 8773–8781, 2012.
- [61] J. W. Ellefson, A. J. Meyer, R. A. Hughes, J. R. Cannon, J. S. Brodbelt, and A. D. Ellington, “Directed evolution of genetic parts and circuits by compartmentalized partnered replication,” *Nat Biotechnol.*, vol. 32, pp. 97–101, 2013.
- [62] J. C. Carlson, A. H. Badran, D. A. Guggiana-Nilo, and D. R. Liu, “Negative selection and stringency modulation in phage-assisted continuous evolution,” *Nat Chem Biol.*, vol. 10, pp. 216–222, 2014.
- [63] T. H. Segall-Shapiro, A. J. Meyer, A. D. Ellington, E. D. Sontag, and C. A. Voigt, “A ?resource allocator? for transcription based on a highly fragmented T7 RNA polymerase,” *Mol Sys Biol.*, vol. 10, no. 742, 2014.
- [64] W. An and J. W. Chin, “Synthesis of orthogonal transcription-translation networks,” *Proc. Natl. Acad. of Sci. USA*, vol. 106, no. 21, pp. 8477–8482, 2009.
- [65] O. Rackham and J. W. Chin, “A network of orthogonal ribosome-RNA pairs,” *Nat. Chem. Biol.*, vol. 1, no. 3, pp. 159–166, 2005.

[66] H. S. Black, “Stabilized feedback amplifiers,” *Bell System Tech. J.*, vol. 13, no. 1, 1934.

Figure captions

Figure 1: *Modularity of basic parts.* (A) Some known structural interactions between genetic sequences affect the activity of promoters and the strength of ribosome binding sites. (B) These structural interferences can be mitigated by physically separating the genetic parts from each other through the insertion of “insulators”. Upstream and downstream of the promoter these insulators contain standard sequences that, used for all constructs, guarantee similar promoter activities within different genetic contexts. The 5’UTR sequence upstream of the ribosome binding site (RBS) can be cut by using CRISPR targets sequences or rybozymes. Interference from secondary structure formation across the 5’UTR and initial gene coding sequence can be mitigated by inserting a translation initiation element.

Figure 2: *Modularity of functional modules: the effect of loads.* (A) Activator-repressor clock: the activator protein A activates its own transcription and that of a repressor R, while the latter represses the transcription of protein A. (B) In isolation, the clock displays sustained oscillations (simulation results). (C) The activator protein is used as an activator of an additional gene in a downstream system. In this case, A is temporarily sequestered by the downstream system so that less of it is available in the reaction of the clock. (D) The consequence of this temporal sequestration is that the clock stops functioning (simulation results).

Figure 3: *Retroactivity and insulation.* (A) A system concept that accounts for retroactivity. The retroactivity to the output s accounts for the additional reaction flux to which the output of S_1 is subjected to when it is connected to S_2 . The retroactivity to the input r accounts for the additional reaction flux that S_1 is imposing on its upstream system when it is connected to it. (B) An insulation device is placed between S_1 and S_2 such that it applies minimal loading to S_1 ($r = 0$), it attenuates the effect of s on its output y , and the output y is an approximately linear function of the input u , that is, $y \approx gu$ for some gain g .

Figure 4: *Basic design principle for retroactivity mitigation.* (A) Block diagram showing the basic mechanism for attenuating the contribution of

retroactivity s on the output y of an insulation device. (B) Equivalent block diagram representation shows that to mitigate retroactivity the input u should be amplified and the output y should be subject to a large negative feedback. (C) A phosphorylation cycle can implement a large input amplification and a similarly large negative feedback on the output. In particular, the input amplification G is proportional to the concentration of the inactive protein y_{in} while the negative feedback gain G' is proportional to the concentration of the phosphatase p .

Figure 5: *Modularity of functional modules: the effect of resource sharing.* The host cell provides resources necessary for transcription, translation, enzymes, ATP, etc. Synthetic modules that use these resources exert a retroactivity flux r on the cellular machinery. This flux, affects the dynamics of the cellular machinery with consequences on the host fitness and repercussions on all modules' function.

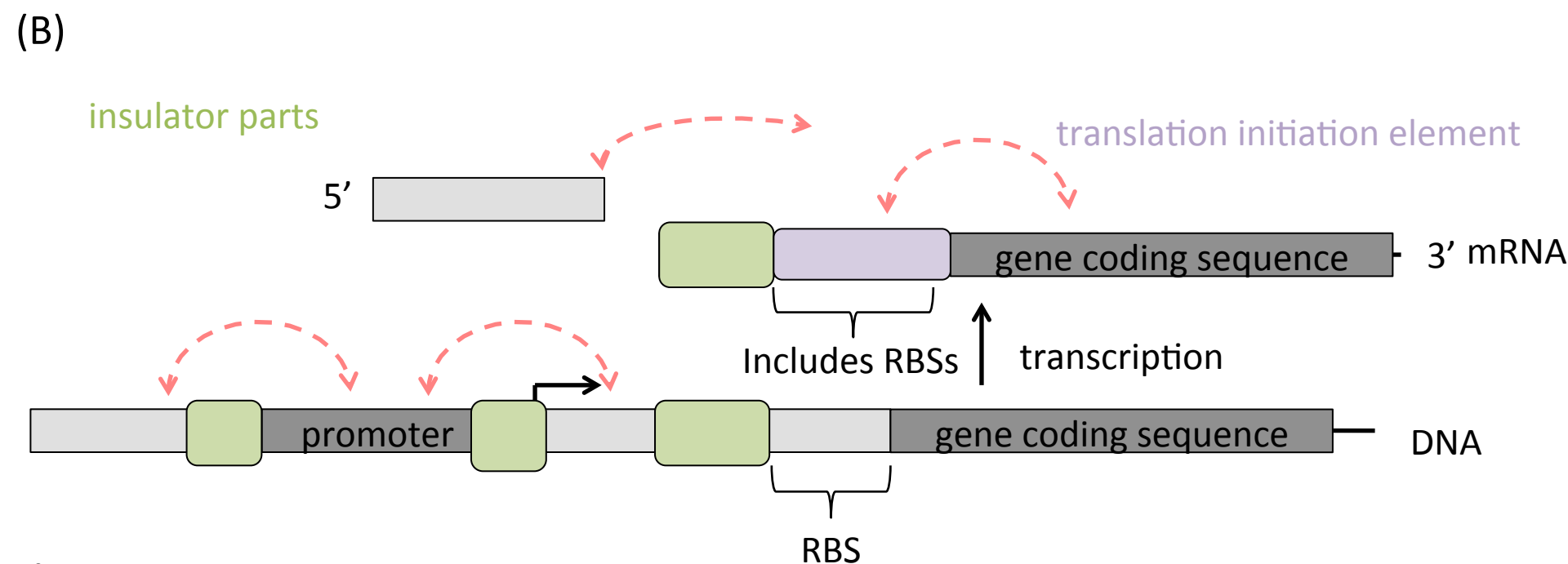
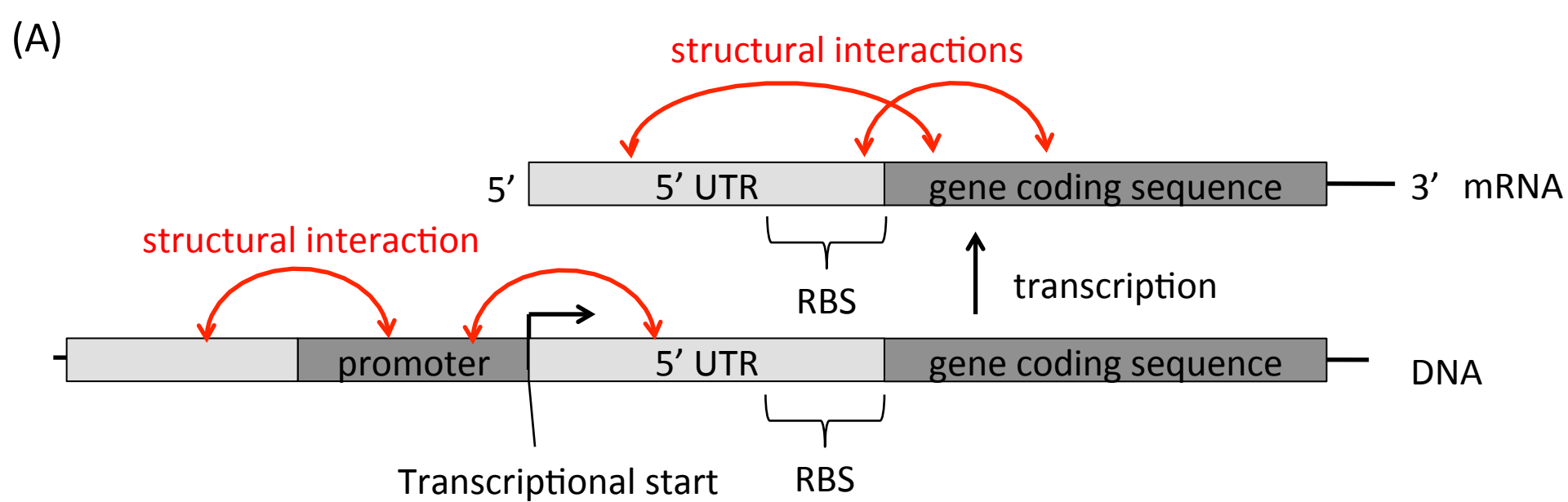
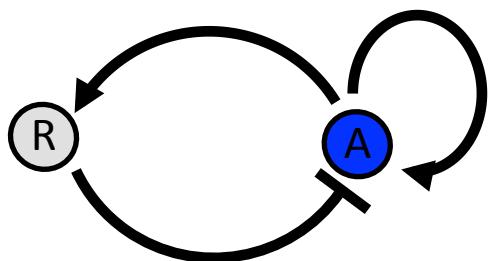
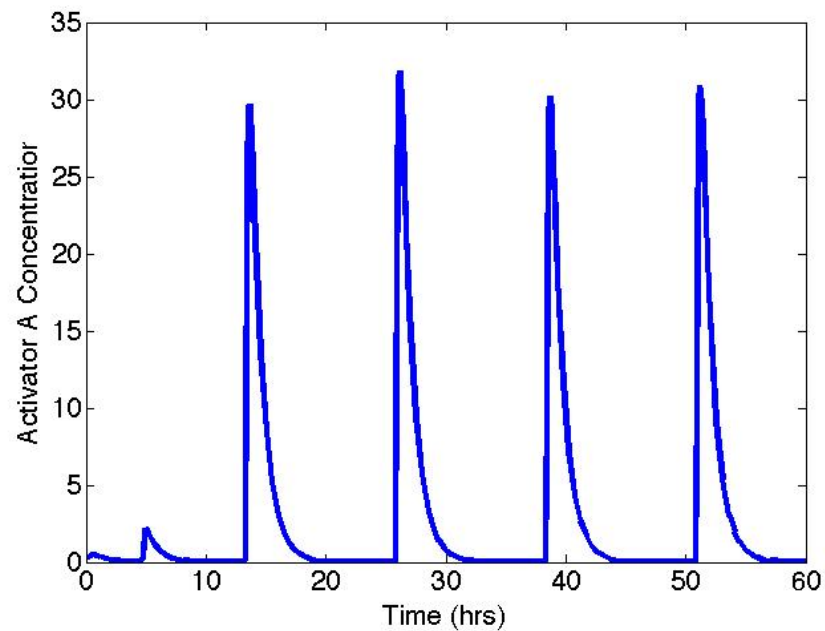

Figure 1

(A)



(B)



(C)

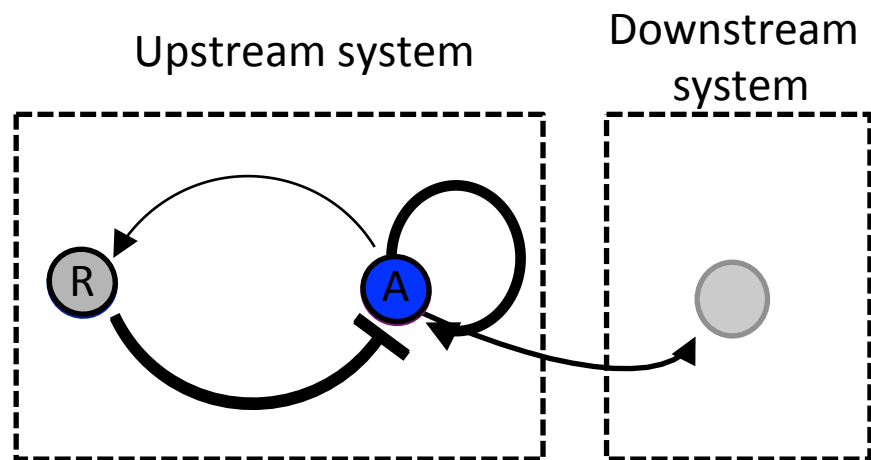

(D)

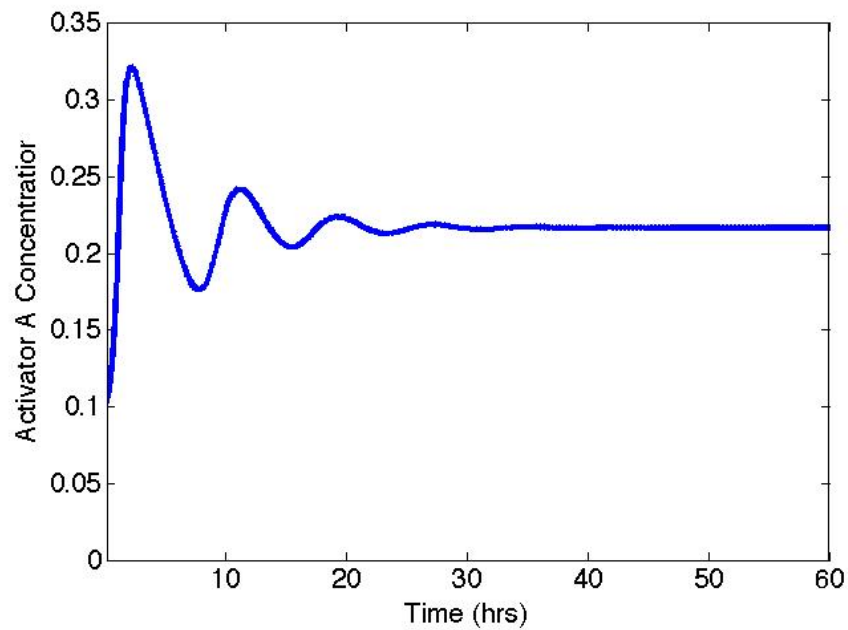
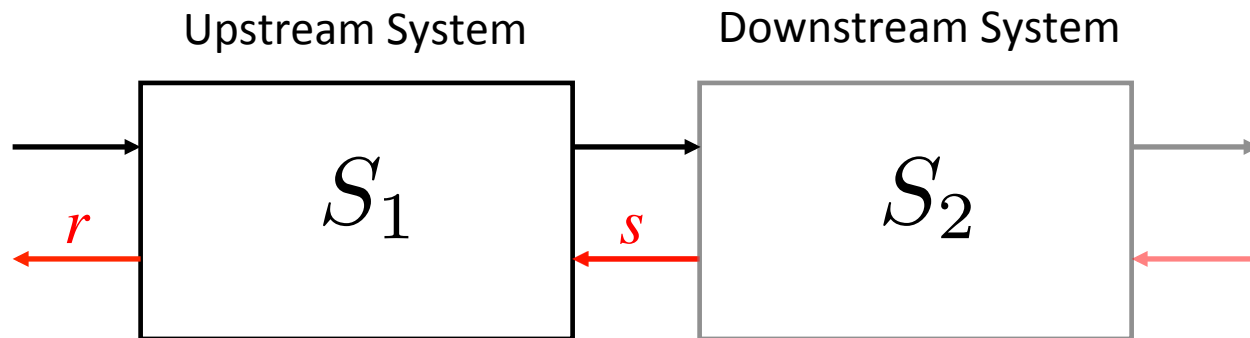

Figure 2

(A)



(B)

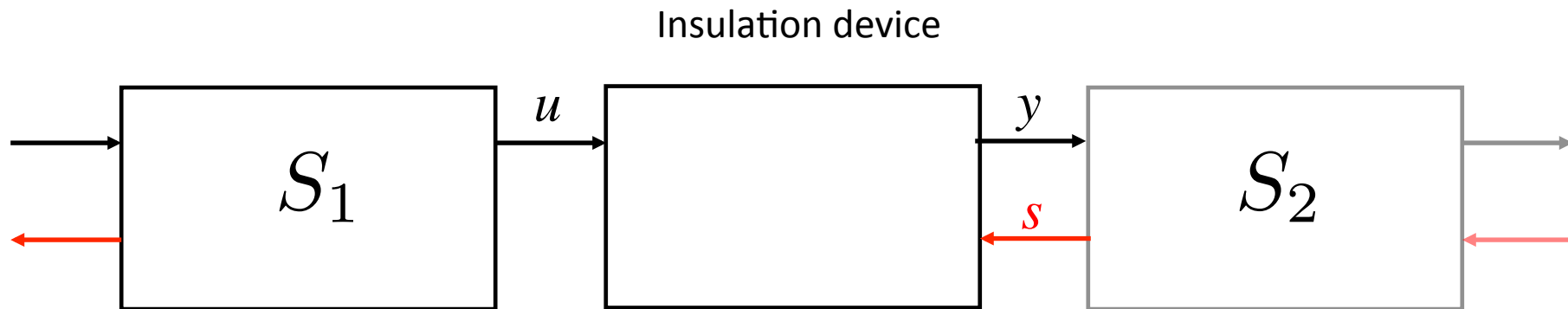

Figure 3

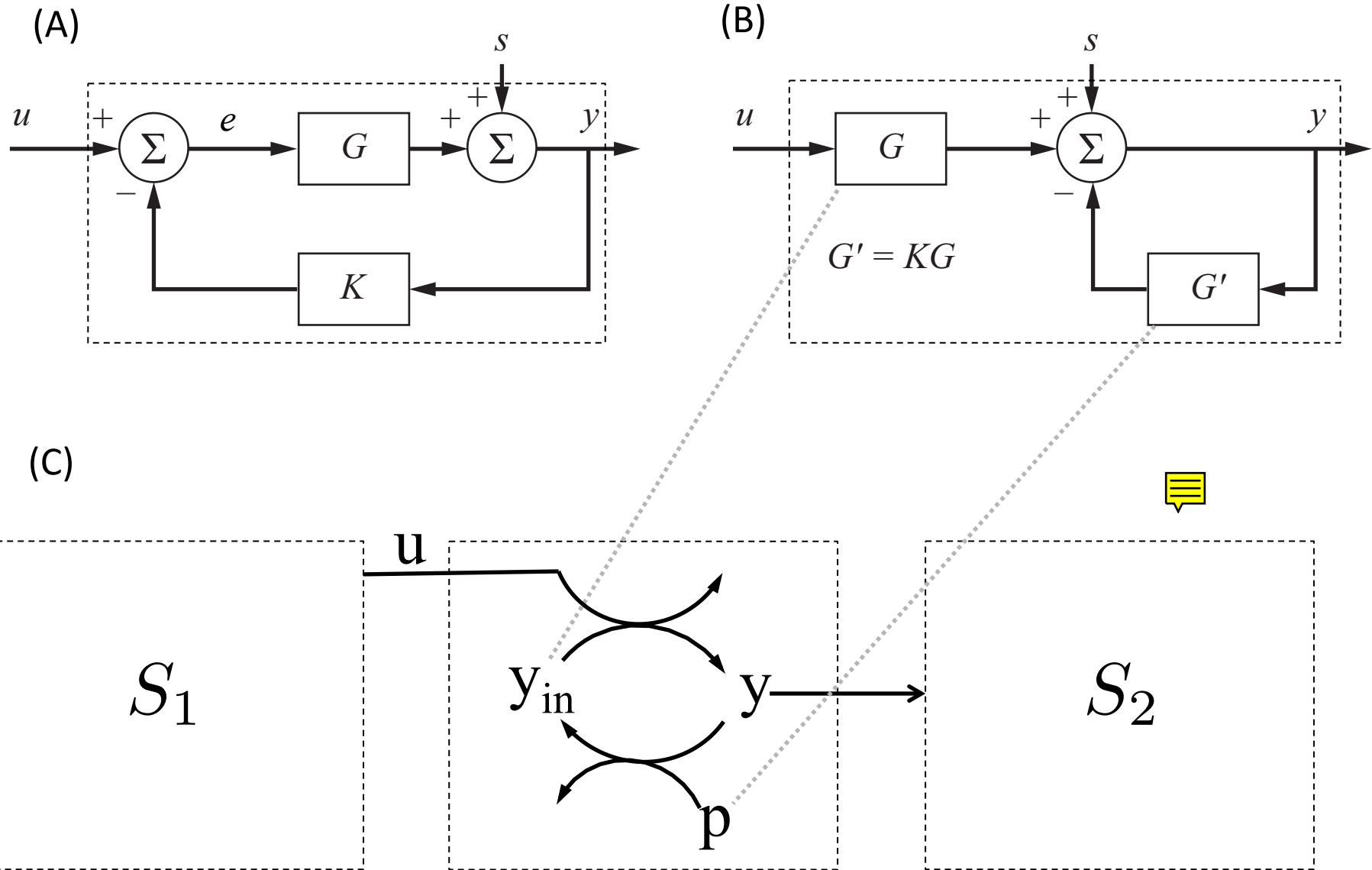

Figure 4

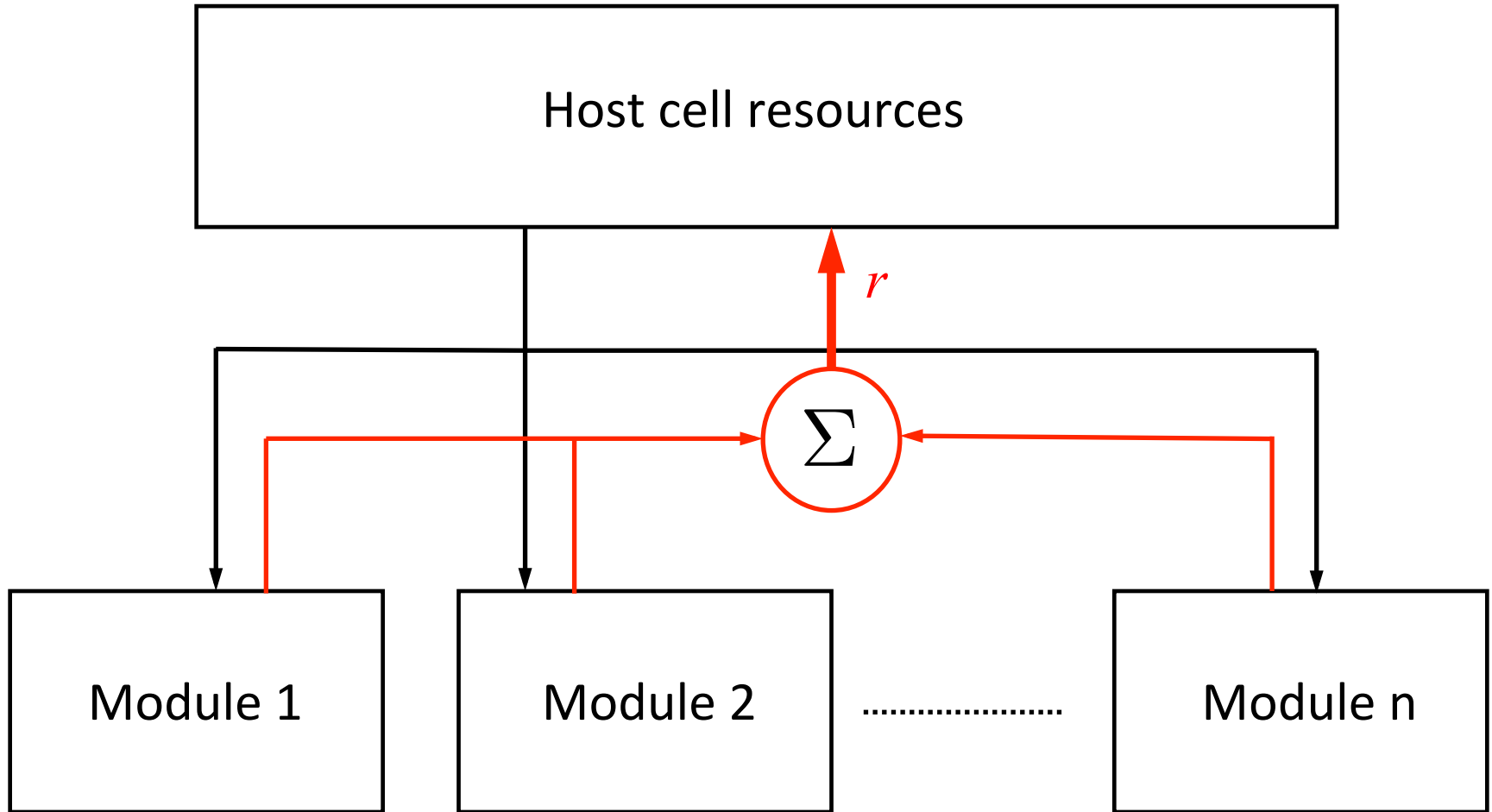

Figure 5