

MIT Open Access Articles

A Bayesian approach for predicting the popularity of tweets

The MIT Faculty has made this article openly available. **Please share** how this access benefits you. Your story matters.

Citation: Zaman, Tauhid, et al. "A Bayesian Approach for Predicting the Popularity of Tweets." The Annals of Applied Statistics 8, 3 (September 2014): 1583–1611 The Annals of Applied Statistics © 2014 Institute of Mathematical Statistics

As Published: <http://dx.doi.org/10.1214/14-AOAS741>

Publisher: Institute of Mathematical Statistics

Persistent URL: <http://hdl.handle.net/1721.1/111083>

Version: Author's final manuscript: final author's manuscript post peer review, without publisher's formatting or copy editing

Terms of use: Creative Commons Attribution-Noncommercial-Share Alike



A BAYESIAN APPROACH FOR PREDICTING THE POPULARITY OF TWEETS

BY TAUHID ZAMAN, EMILY B. FOX AND ERIC T. BRADLOW

*Massachusetts Institute of Technology, University of Washington
and University of Pennsylvania*

We predict the popularity of short messages called *tweets* created in the micro-blogging site known as Twitter. We measure the popularity of a tweet by the time-series path of its *retweets*, which is when people forward the tweet to others. We develop a probabilistic model for the evolution of the retweets using a Bayesian approach, and form predictions using only observations on the retweet times and the local network or “graph” structure of the retweeters. We obtain good step ahead forecasts and predictions of the final total number of retweets even when only a small fraction (i.e., less than one tenth) of the retweet path is observed. This translates to good predictions within a few minutes of a tweet being posted, and has potential implications for understanding the spread of broader ideas, memes or trends in social networks.

1. Introduction. The rapid rise in the popularity of online social networks has resulted in an explosion of user-generated content. There is a wide variety in the type of content—it can be a user comment, a photograph, a movie or a link to a news article. Typically, in these online social networks, users form connections with other users, producing a social graph. For example, in the micro-blogging site Twitter, these connections are known as *followers* and the resulting social graph is known as the *follower graph*. When a user generates a piece of content, it becomes visible to all of his or her followers in the social graph. The content spreads through the social graph if these followers subsequently repost the content so their followers can see it and potentially repost it further.

In this work we focus on the micro-blogging site Twitter which has over 230 million active users as of November 2013 [US Securities and Exchange Commission (2013)]. The user-generated content in Twitter is composed of

Received April 2013; revised January 2014.

Key words and phrases. Social networks, Twitter, Bayesian inference, time series, forecasting.

<p>This is an electronic reprint of the original article published by the Institute of Mathematical Statistics in <i>The Annals of Applied Statistics</i>, 2014, Vol. 8, No. 3, 1583–1611. This reprint differs from the original in pagination and typographic detail.</p>

short messages known as *tweets* containing up to 140 characters, which can also contain images or links to news articles or videos. Tweets are spread through the Twitter follower graph by the act of *retweeting*, which is when a user forwards a tweet to his or her followers.

Our goal in this work is to predict the popularity of a tweet by predicting the time path of retweets it receives. We aim to make these predictions very early on in the lifetime of the tweet, sometimes within minutes of it being posted. We use a Bayesian model to describe the evolution of the retweets of a tweet. With this model we make predictions for the total number of retweets a tweet will receive using information from early retweet times, the retweets of other tweets and summaries of the follower graphs.

The remainder of the paper is organized as follows. In Section 1.1 we describe related work. In Section 2 we provide a description of the data utilized and an exploratory set of analyses of it that guide the proposed probabilistic model of Section 3. We present our posterior computations via Markov chain Monte Carlo (MCMC) in Section 3.5. In Section 4 we present an analysis of our model’s predictive performance on our Twitter data, including a comparison to benchmark models from the extant literature and nested versions of our model. We discuss extensions to this research in Section 5.

1.1. *Previous work.* There has been much recent interest in the retweet prediction problem, albeit in terms of a slightly different type of prediction task. In particular, recent extant research [Zaman et al. (2010), Bakshy et al. (2010)] tried to predict the existence of a retweet between a particular pair of users. While this is an important problem in graph formation or viral spreading across vertices, it is a notably different problem than addressed here due to the precision and pairwise specificity required.

Suh et al. (2010) used a generalized linear model to understand what features influenced the chance of a tweet being retweeted by anyone. Other work [Hong, Dan and Davison (2011), Bandari, Asur and Huberman (2012)] built upon this and used a variety of algorithms to try to predict not the exact number of retweets, but rather a coarse interval for the number of retweets of a tweet. Similar techniques were used by Naveed et al. (2011) and Petrovic, Osborne and Lavrenko (2011) to predict the probability that a tweet receives any retweets, which by definition is nested within the problem we consider.

In contrast to these previous works, we aim to predict the entire time path, and hence the eventual number of retweets of a tweet. This is similar to Szabo and Huberman (2010) who use a linear model to predict the popularity of stories on Digg.com and videos on YouTube after 30 days by observing their popularity after one hour and one week, respectively. Other related work is Agarwal, Chen and Elango (2009) who attempt to make one-step ahead

predictions of the click-through rates of online news stories with a spatial-temporal model that utilizes the time-varying click-through rate of an article along with its spatial position on a webpage. The problem of predicting the structure of time evolving citation networks is studied in Vu et al. (2011). Our prediction goal is similar to these works, but as we demonstrate in Section 4, our approach produces accurate predictions for the final number of retweets using only minutes of observations, rather than hours or days. Given the Bayesian approach utilized here, accurate predictions are possible for a given tweet’s retweet path even when there are no available data other than that of other retweet paths observed so far, especially if one utilizes covariates describing the tweets, retweets and their authors (an area for future research).

2. Data overview. In this section we describe the retweet data we obtained and present exploratory data analysis of some basic features. This analysis is useful in providing an understanding of the scales associated with the data (number of retweets of a typical tweet, time-scale over which a typical tweet is retweeted) and in guiding our more formal modeling choices.

2.1. Data description. We collected retweet data that cover a fairly wide array of topics and also have a wide range of retweet graph sizes. The topics include music, politics and miscellaneous everyday events. Our data set consists of 52 different tweets which were selected through manual exploration of Twitter and are available in the supplemental materials [Zaman, Fox and Bradlow (2014)]. We refer to these original tweets as *root tweets*. For each root tweet, we used the Twitter Search API [Twitter (2012)] to find all retweets. We used root tweets which were at least a week old to make sure that there were likely to be no more retweets occurring. The search API provided us with the retweet times and identity of the users who retweeted. Also, since the Search API could only return a maximum of 1800 results, we did not look at root tweets with more than this many retweets. Based on previous empirical studies [Zhou et al. (2010), Cha et al. (2010)], this maximum number of retweets covers a large fraction of tweets in Twitter and does not represent a significant limitation. However, it is an open research question as to what degree the empirical patterns we observe will hold for tweets with a large number of retweets.

From the text of the retweet, we are able to identify the person that the user retweeted (the username following the text “RT@”). For example, if user Alice posted the tweet “Hello” and user Bob retweeted this root tweet, it would appear as “RT@ Alice: Hello.” We then used the Twitter API to find the number of followers of the root user and each user who retweeted it. The number of followers will act as a covariate in our predictive model. In particular, the number of followers for a given user represents both the

potential retweet base for a given tweet and also a significant moderator of the speed and timing of retweets.

We associate with each root tweet a directed *retweet graph*. We will utilize the following notation for the different data associated with the retweet graph. We denote the root tweet as x which is tweeted by root user v_0^x . The retweet graph associated with x which we observe at time t is denoted $G^x(t) = (V^x(t), E^x(t))$. The vertex set $V^x(t)$ includes the root user (who tweets at $t = 0$) and all users who retweet the root tweet before time t . A directed edge $(u, v) \in E^x(t)$ points from user u to user v if v retweets u before t . We will denote the total number of retweets in $G^x(t)$ by $m^x(t) = |V^x(t)| - 1$. We define the final number of retweets of x as $\lim_{t \rightarrow \infty} m^x(t) = M^x$ and it is the arrival of retweets and attained M^x that we wish to predict.

We will index the users in the retweet graph with the variable j . The root user is indexed by $j = 0$, and all other users have $j > 0$. User j who retweets x is denoted by v_j^x for $j = 1, 2, 3, \dots$. The time of this user's retweet is denoted T_j^x , with $T_0^x = 0$ (the root tweet occurs at time 0). User v_j^x has f_j^x Twitter followers and is d_j^x "hops" from the root user v_0^x in the retweet graph. The parent of v_j^x in the retweet graph is denoted P_j^x . To illustrate these definitions, we show in Figure 1 an example of the retweet graph for a root tweet. Included are pictures of the evolution of the retweet graph, a plot of the number of retweets versus time and a table showing the aforementioned summary data for several users in the retweet graph. As we can see, this particular root tweet has almost all of its retweets at depth one (one hop from the source), which is a common pattern for our data set as discussed below.

2.2. Size, lifetime and depth of retweet graphs. We first look at the size and lifetime of the 52 retweet graphs. The root tweets we collected had between 21 and 1260 retweets. The time for the final retweet to occur ranged from a few hours to a few days as some of the final retweets had very large retweet times. A more stable measure of the lifetime of a root tweet is the time to reach 50% (the median) of its total retweet count. The median retweet times ranged from four minutes to three hours, with most being less than one hour.

We plot the total number of retweets versus the median retweet times for the 52 root tweets in Figure 2. We also plot the rank of each tweet's median retweet time versus the rank of its total number of retweets among our 52 source tweets. The Pearson correlation coefficient for the median retweet times and the eventual number of retweets is -0.12 (p -value = 0.49) and the Kendall tau rank correlation coefficient is 0.03 (p -value = 0.84). Therefore, we do not have evidence to reject the null hypothesis that the eventual number of retweets is uncorrelated with the median retweet time. Instead,

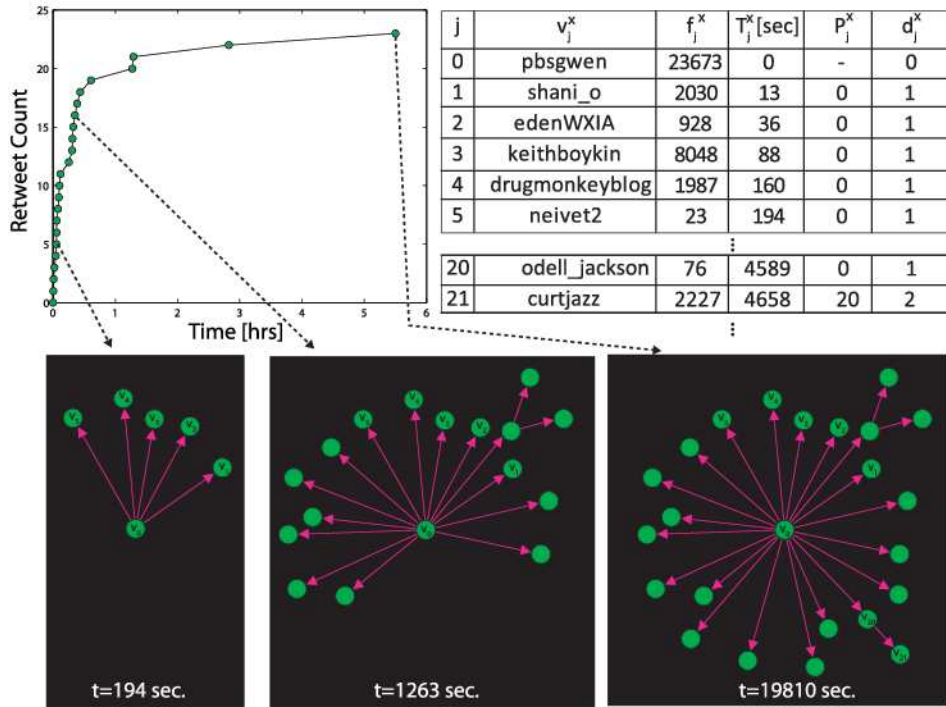

FIG. 1. Data for the root tweet “Cory Booker has never worked a day in his life. Not. #corybookerstories” by root user pbsgwen. The table shows the relevant data for the retweet graph for several users. The plot shows the number of retweets of the root tweet versus time. Images of the retweet graph at different times are also shown.

this suggests the potential value of our model over purely exploratory approaches. In particular, it is important to model the retweet interarrivals for our prediction task. Thus, simply predicting the total number of retweets

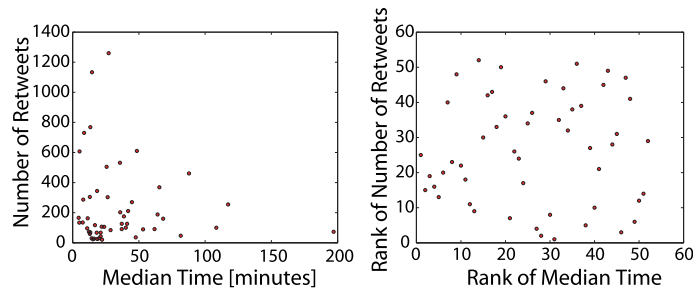

FIG. 2. (Left) total number of retweets versus median retweet time for different root tweets. (Right) rank of total number of retweets versus rank of median retweet time for different root tweets.

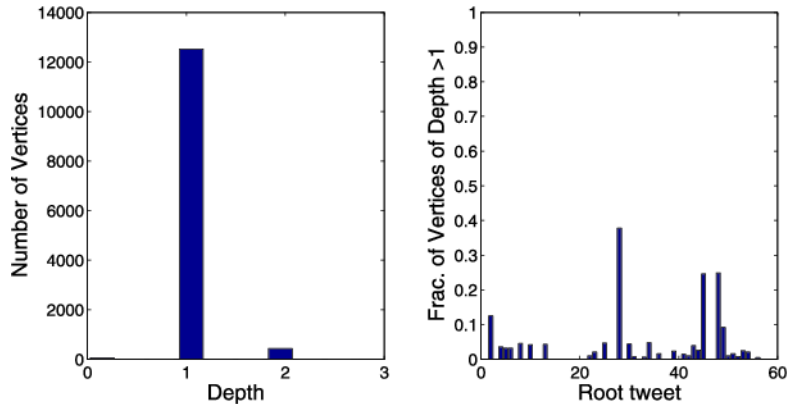

FIG. 3. Histogram of (left) the fraction of users at different depths in all 52 retweet graphs and (right) the fraction of vertices of depth greater than one in the retweet graph for each root tweet.

from the median (or simple central summary) is unlikely to yield accurate predictions.

We next explore the structure of the retweet graphs. In particular, we look at the number of vertices one hop and more than one hop from the root user. For the 52 root tweets, there are 11,882 retweeters who are one hop from the root user and only 314 retweeters more than one hop from the root user. Figure 3 shows the histogram of vertices at different depths in all of the retweet graphs, along with a plot of the fraction of vertices more than one hop from the root user for each retweet graph. As can be seen, retweet graphs typically have most vertices at depth one, but occasionally they have some vertices at depth greater than one, suggesting that root tweets get retweeted much more often than the retweets get retweeted. This fact agrees with previous studies done on retweet graph structures [Kwak et al. (2010), Goel, Watts and Goldstein (2012)] and is key to our ability to predict M^x early, even before potential retweets from those two hops or more are taken into account. We have found that the follower count of the root user has little correlation with the retweet graph depth (Pearson correlation coefficient = 0.13, p -value = 0.28). However, when a retweet graph has depth greater than one, it is typically due to a user with a large number of followers. The median follower count of users in the retweet graph who are not the source but get retweeted is 1,142,923.

2.3. *Reaction times.* Given, as before, that user v_j^x retweets the root tweet at time T_j^x , we define the *reaction time* $S_j^x = T_j^x - T_{P_j^x}^x$ as the elapsed time between when the parent of v_j^x (re)tweets and v_j^x retweets. That is, S_j^x is the time that it takes v_j^x to react and retweet after the root tweet becomes

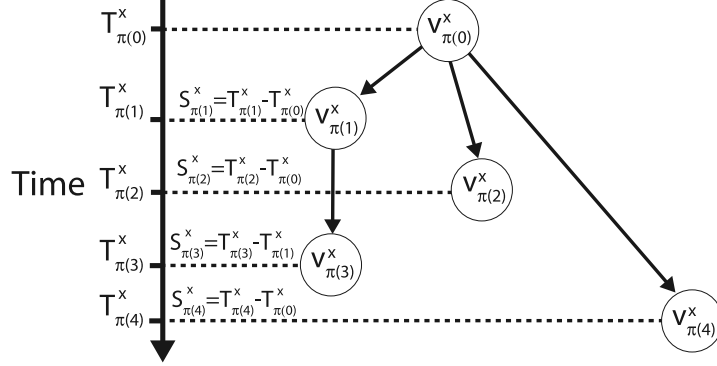

FIG. 4. Description of reaction times for a retweet graph. The vertical position of vertices indicate when they retweeted, with time increasing as one goes down. The reaction time on each edge is expressed in terms of the retweet times of the vertices.

visible to v_j^x via its parent's (re)tweet. We define π as the permutation that orders the M^x retweet times T_j^x from minimum to maximum. That is, $T_{\pi(0)}^x \leq T_{\pi(1)}^x \leq \dots \leq T_{\pi(M^x)}^x$. It is important to note that π corresponds to the sequence in which we observe the retweet times for a root tweet. Figure 4 provides a graphical explanation of the reaction times in terms of retweet times.

To begin a more formal exploration of our data, we first consider a simple and non-Bayesian model in which each S_j^x is assumed to be an i.i.d. log-normal random variable with parameters τ^x and α^x : $\log(S_j^x) \sim \mathcal{N}(\alpha^x, (\tau^x)^2)$. We take the parameters of the log-normal to be different for each root tweet x , but the same for each user within a given retweet graph. This assumption takes into account the fact that there can be heterogeneity of these parameters which depends on the content of the root tweet.

To assess the log-normal assumption, we calculate the maximum likelihood (ML) estimate of α^x and τ^x for each root tweet. Given a set of reaction times S_j^x for $j = 1, 2, \dots, M^x$, the ML estimates are straightforwardly given by

$$\alpha_{\text{ML}}^x = \frac{1}{M^x} \sum_{j=1}^{M^x} \log(S_j^x), \quad \tau_{\text{ML}}^x = \sqrt{\frac{1}{M^x} \sum_{j=1}^{M^x} (\log(S_j^x) - \alpha_{\text{ML}}^x)^2}.$$

In Figure 5 (top left) we show a scatter-plot of α_{ML}^x and τ_{ML}^x for different root tweets x . All parameter values are evaluated with reaction times measured in seconds. The mean and standard deviation of α_{ML}^x is 7.31 and 0.73, respectively. The mean and standard deviation of τ_{ML}^x is 2.31 and 0.31, respectively, and we clearly see some heterogeneity over x . To assess fit, we

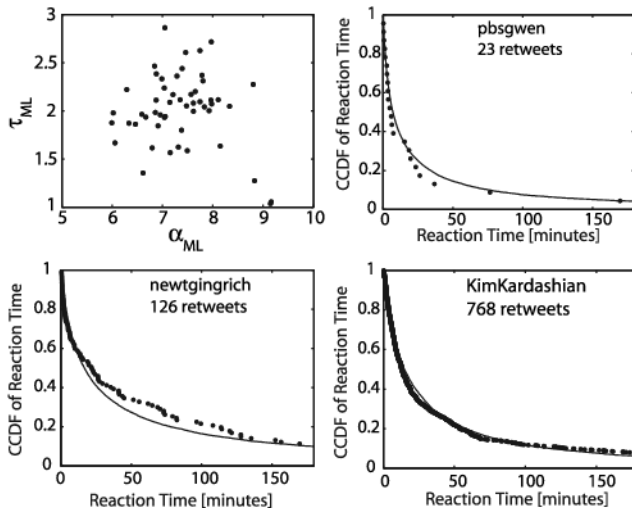

FIG. 5. (Top left) scatter-plot of ML estimates of α^x and τ^x for different root tweets. The remaining figures are plots of the empirical reaction time complimentary cumulative distribution function (CCDF) (black circles) and the CCDF of log-normal distributions using the ML parameter estimates (solid line) for three different root tweets representing the 2.5 (top right), 50 (bottom left) and 95 (bottom right) percentiles of retweet graph size in our data set. For each root tweet, we show the root user for the tweet and the number of retweets in total it received.

show in Figure 5 the empirical complimentary cumulative distribution function (CCDF) of the reaction times along with the CCDF of a log-normal distribution using the ML estimates for the parameters for three root tweets representing the 2.5 (small size, top right), 50 (medium size, lower left) and 95 (large size, lower right) percentiles of retweet graph size in our data set. Qualitatively, the log-normal curves provide a reasonable fit for the reaction times.

The observation of log-normally distributed reaction times has occurred in other application areas. For instance, Stouffer, Malmgren and Amaral (2006) observed that the time for people to respond to emails follows a log-normal distribution. Brown et al. (2005) observed that call durations in call centers follow a log-normal distribution. In the psychology literature there have been different models proposed to explain the origin of log-normal reaction times in different contexts [Ulrich and Miller (1993), van Breukelen (1995)]. However, these models do not apply directly to Twitter and it is interesting to see the same general empirical pattern replicated here.

2.4. *Retweet graph structure.* In this section we provide an initial exploration of the effects of the number of followers, f_j^x , and distance from the root, d_j^x , on the probability of a user's tweet being retweeted. Once a user

v_j^x (re)tweets in the retweet graph for a root tweet x , the (re)tweet appears in the Twitter feed (timeline) of all of v_j^x 's followers. Some number of these followers will subsequently retweet v_j^x . We denote this number by M_j^x , which is equal to the out-degree of v_j^x in the completed retweet graph once the root tweet has stopped spreading. We assume that each of the f_j^x followers of v_j^x will independently retweet v_j^x with probability $0 \leq b_j^x \leq 1$. This gives M_j^x a binomial distribution $\text{Bi}(f_j^x, b_j^x)$. We note that this assumption of conditional independence across followers is reasonable because retweeters are unlikely to be connected to other retweeters and, hence, there is no ‘‘visibility’’ between the f_j^x followers. In our data set, the average of ratio of cycle forming follower edges to all possible follower edges is 0.01. This means that follower edges which connect users in addition to those connected via retweets represent less than 1% of all possible follower edges. For other networks there may be generalizations needed.

We assume the retweet probability b_j^x depends upon two pieces of information: the number of followers f_j^x of v_j^x and the distance d_j^x of v_j^x from v_0^x in the retweet graph. This makes conceptual sense as these two variables represent the potential retweet base and the ‘‘degree of closeness’’ of each vertex, respectively. We model $\text{logit}(b_j^x)$ as

$$(1) \quad \text{logit}(b_j^x) = \beta_0 + \beta_f \log(f_j^x + 1) + \beta_d \log(d_j^x + 1) + \varepsilon_j^x,$$

where $\varepsilon_j^x \sim \mathcal{N}(0, \sigma_b^2)$. For this exploratory analysis (formal model in Section 3), for each user v_j^x we estimate b_j^x as $\widehat{b}_j^x = M_j^x / f_j^x$. We then perform a linear regression of $\text{logit}(\widehat{b}_j^x)$ on $\log(f_j^x + 1)$ and $\log(d_j^x + 1)$ for all users in all root tweets. Here, we only include users for which $M_j^x \geq 1$ so that $\text{logit}(\widehat{b}_j^x)$ will be finite.

The ML estimates of the regression coefficients are $\widehat{\beta}_0 = 1.99$, $\widehat{\beta}_f = -0.79$ and $\widehat{\beta}_d = -4.31$ and the p -values of the corresponding t -statistic are all significantly less than 0.001, indicating a high significance for each coefficient. In Figure 6 we plot $\text{logit}(\widehat{b}_j^x) - \widehat{\beta}_0 - \widehat{\beta}_d \log(d_j^x + 1)$ versus f_j^x and $\text{logit}(\widehat{b}_j^x) - \widehat{\beta}_0 - \widehat{\beta}_f \log(f_j^x + 1)$ versus d_j^x in order to show the isolated effect of each covariate.

The value for $\widehat{\beta}_f$ is negative, which is expected given the way \widehat{b}_j^x is defined, but the value is greater than -1 . This result says that after controlling for d_j^x , the average value of M_j^x scales as $b_j^x f_j^x \sim (f_j^x)^c$ for some $0 < c < 1$. Therefore, the number of retweets should grow with the number of followers a user has, but at a decreasing rate. The value for $\widehat{\beta}_d$ is also negative, indicating that after controlling for f_j^x , a retweet is less likely the farther we get from the root user. Both of these findings are in accordance with previous research on retweet graph structure [Kwak et al. (2010), Goel, Watts and Goldstein (2012)] and provide face validity to our results.

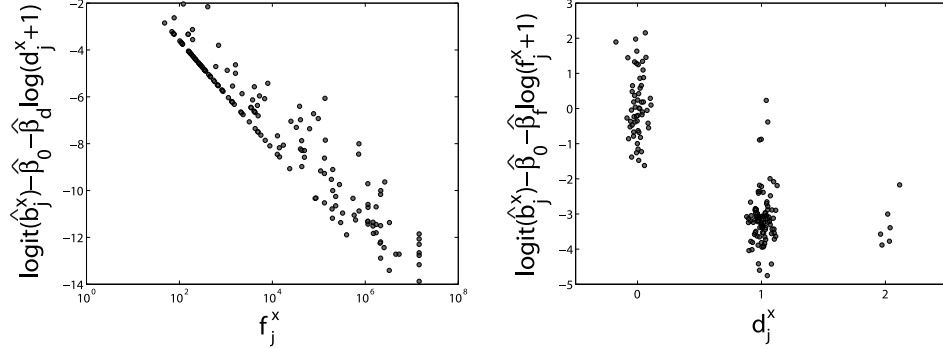

FIG. 6. Plots for all 52 root tweets of (left) $\text{logit}(\hat{b}_j^x) - \hat{\beta}_0 - \hat{\beta}_d \log(d_j^x + 1)$ versus f_j^x and (right) $\text{logit}(\hat{b}_j^x) - \hat{\beta}_0 - \hat{\beta}_f \log(f_j^x + 1)$ versus d_j^x . The values of d_j^x are slightly perturbed in order to improve visibility of the data.

3. Retweet model. Our data analysis in Section 2 provides us with insights on the important properties of the dynamics of retweeting and the structure of retweet graphs. Based on these insights, we propose a Bayesian model for the evolution of the retweet graph of a root tweet.

3.1. Generative model for retweet graph evolution. Our generative model for the evolution of a retweet graph can be described as follows. We start with a single user v_0^x who posts the root tweet x . This user has a reaction time $S_0^x = 0$ and M_0^x children who will eventually retweet x . Each child v_j^x of M_0^x generates a random reaction time S_j^x and an independent random number of children M_j^x . This process repeats recursively with every child generating a reaction time and an independent random number of its own children.

The process terminates when all children which are leaves in the retweet graph have $M_j^x = 0$. As we show in our model specification of Section 3.3, the distribution of M_j^x depends on the depth of the node and in Section 4 we show that we typically learn that M_j^x is likely to be smaller for higher depth nodes. The graphical model of this generative model is shown in Figure 7. In what follows, we specify the components of our generative process by defining the conditional distributions of S_j^x and M_j^x .

3.2. Log-normal model for reaction times. From our exploratory analysis, we saw that a log-normal distribution provided a reasonable fit for the reaction times. There was some variation in the ML estimates of the log-normal parameters, α^x and τ^x , across tweets. Therefore, we choose the following model for the reaction times. For each root tweet x we model $\log(S_j^x)$ as normal with a tweet specific mean α^x and standard deviation

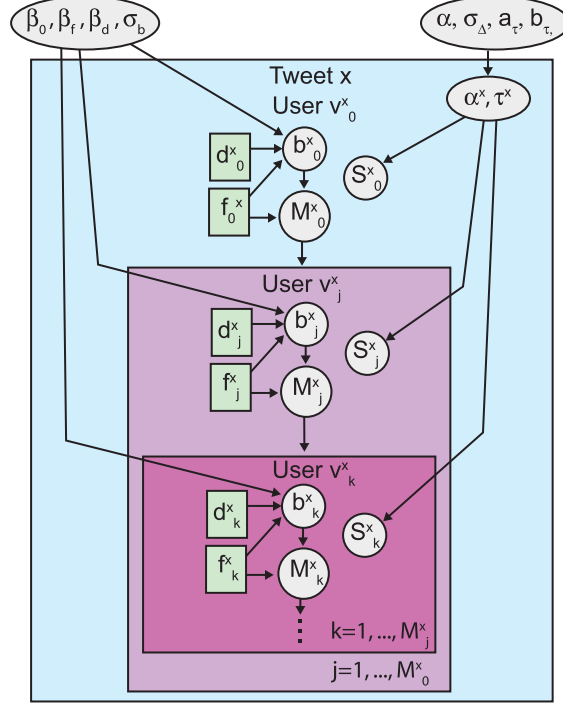

FIG. 7. Graphical model of the Bayesian log-normal-binomial model for the evolution of retweet graphs. The plates denote replication over tweets x and users v_j^x . Nested plates denote retweets occurring at larger depths from the root user. The process terminates when all children which are leaves in the retweet graph have $M_j^x = 0$. Hyperpriors are omitted for simplicity.

τ^x . We place a normal prior on α^x and an inverse-gamma prior on $(\tau^x)^2$, in accordance with standard hierarchical Bayesian models [cf. Gelman and Hill (2007)]. In particular,

$$(2) \quad \log(S_j^x) | \alpha^x, \tau^x, M^x \sim \mathcal{N}(\alpha^x, (\tau^x)^2), \quad j = 1, \dots, M^x,$$

$$(3) \quad \alpha^x | \alpha, \sigma_\Delta \sim \mathcal{N}(\alpha, \sigma_\Delta^2),$$

$$(4) \quad (\tau^x)^2 \sim \text{IG}(a_\tau, b_\tau).$$

To complete our hierarchical Bayesian specification and ameliorate issues with hyperparameter sensitivity, we use the following hyperpriors:

$$(5) \quad \alpha \sim \mathcal{N}(\mu_\alpha, \sigma_\alpha^2),$$

$$(6) \quad \sigma_\Delta^2 \sim \text{IG}(a_\Delta, b_\Delta),$$

$$(7) \quad \log(a_\tau) \sim \mathcal{N}(\mu_a, \sigma_a^2),$$

$$(8) \quad b_\tau \sim \text{Gamma}(k_b, \theta_b),$$

and note that exact hyperparameter values, selected to be uninformative, are provided in Appendix A. The graphical model for the reaction time component of the model is shown in Figure 7 (see node S_j^x and all associated connections) and demonstrates the cross-tweet shrinkage that is allowed by our model.

3.3. *Binomial model for retweet graph structure.* As in our exploratory analysis, we assume independence of retweets between the pool of potential retweeters, specifically assuming that each follower of user v_j^x retweets with probability b_j^x . We saw initial evidence that the retweet probabilities b_j^x showed dependence on the number of followers and depth of the user, f_j^x and d_j^x . Using this insight, we propose the following model for the retweet graph structure:

$$(9) \quad M_j^x | f_j^x, b_j^x \sim \text{Bi}(f_j^x, b_j^x),$$

$$(10) \quad \text{logit}(b_j^x) | \mu_j^x, \sigma_b \sim \mathcal{N}(\mu_j^x, \sigma_b^2),$$

where we define

$$(11) \quad \mu_j^x = \beta_0 + \beta_f \log(f_j^x + 1) + \beta_d \log(d_j^x + 1).$$

This model allows for the possibility of the number of followers, f_j^x , and the depth of the retweet from the root, d_j^x , to influence the number of eventual retweeters. The influence of the covariates, as determined by β_f and β_d , is shared across root tweets x . As with the reaction time model, we put hyperpriors on these global model parameters:

$$(12) \quad \beta_0 \sim \mathcal{N}(\mu_{\beta_0}, \sigma_{\beta_0}^2),$$

$$(13) \quad \beta_f \sim \mathcal{N}(\mu_{\beta_f}, \sigma_{\beta_f}^2),$$

$$(14) \quad \beta_d \sim \mathcal{N}(\mu_{\beta_d}, \sigma_{\beta_d}^2),$$

$$(15) \quad \sigma_b^2 \sim \text{IG}(a_{\sigma_b}, b_{\sigma_b}),$$

where we specify the specific (uninformative) hyperparameter values in Appendix A. The combined model for reaction times and the graph structure is shown in Figure 7.

3.4. *Likelihood function.* We now derive the likelihood function for our retweet model. We partition our data set into two types of tweets, *training* tweets and *prediction* tweets. The training tweets are fully observed retweet graphs. That is, we observe all reaction times (S_j^x) along with the final degree (M_j^x) of each vertex in the retweet graph. For the *prediction* tweets, we observe the retweet graph up to a time t^x and therefore only observe a

fraction of the reaction times and the current degree of each vertex which we denote by $m_j^x(t^x)$. We do not observe the M_j^x 's in a prediction tweet¹ and, therefore, we treat these as missing data.

First, we derive the likelihood of the observations for a training tweet. We define the number of observed retweets for a training tweet x as m^x . The observed data for a training tweet are $\mathbf{S}^x = \bigcup_{j=1}^{m^x} S_j^x$ and $\mathbf{M}^x = \bigcup_{j=0}^{m^x} M_j^x$. Recall that in our model $\log(S_j^x) \sim \mathcal{N}(\alpha^x, (\tau^x)^2)$ for $j = 1, \dots, m^x$. Therefore, if we define $\mathbf{b}^x = \bigcup_{j=0}^{m^x} b_j^x$, the likelihood of the observations is given by

$$\begin{aligned}
 (16) \quad & \mathbf{P}(\mathbf{S}^x, \mathbf{M}^x | \alpha^x, \tau^x, \mathbf{b}^x, m^x) \\
 & = P(M_0^x | b_0^x, F_0^x) \\
 & \quad \times \prod_{j=1}^{m^x} \frac{1}{\sqrt{2\pi}\tau^x} \exp\left(-\frac{(\log(S_j^x) - \alpha^x)^2}{2(\tau^x)^2}\right) P(M_j^x | b_j^x, f_j^x),
 \end{aligned}$$

where $P(M_j^x | b_j^x, f_j^x)$ is given by the binomial of equation (9). We note that S_j^x is not conditionally independent of M_j^x because the total number of S_j^x that exist depend upon M_j^x (which is an element in defining the observed m^x).

For the prediction tweets, we do not observe the M_j^x 's and so will need to marginalize over them. Also, we observe only a subset of the reaction times which comes from retweets that occur before time t^x . Using the previous definitions of π and $m^x(t^x)$, the observed data for a prediction tweet are $\mathbf{S}_{t^x}^x = \bigcup_{j=1}^{m^x(t^x)} S_{\pi(j)}^x$ and $\mathbf{m}_{t^x}^x = \bigcup_{j=0}^{m^x(t^x)} m_{\pi(j)}^x(t^x)$. First, we derive the conditional distribution of the observations $\mathbf{S}_{t^x}^x$ and $\mathbf{m}_{t^x}^x$ conditional on $\mathbf{M}_{t^x}^x = \bigcup_{j=0}^{m^x(t^x)} M_{\pi(j)}^x$, α^x and τ^x . With this conditioning, the contribution to the probability from each vertex $v_{\pi(j)}^x$ observed by time t^x has three components:

- (1) The log-normal likelihood of its observed reaction time [equation (2)].
- (2) The unobserved retweets of its children in the retweet graph. That is, for each vertex $v_{\pi(j)}^x$ that retweets at time $T_{\pi(j)}^x \leq t^x$, we have $m_{\pi(j)}^x(t^x)$ observed retweets by time t and $M_{\pi(j)}^x - m_{\pi(j)}^x(t^x)$ unobserved retweets. Because we are making the observations at time t^x , these $M_{\pi(j)}^x - m_{\pi(j)}^x(t^x)$ reaction times must be greater than $t^x - T_{\pi(j)}^x$. Therefore, if we define the cumulative distribution function of $\mathcal{N}(\alpha^x, (\tau^x)^2)$ as $F(\cdot | \alpha^x, \tau^x)$, the contribution to the conditional distribution is $(1 - F(\log(t^x - T_{\pi(j)}^x) | \alpha^x, \tau^x))^{M_{\pi(j)}^x - m_{\pi(j)}^x(t^x)}$. That is, $M_{\pi(j)}^x - m_{\pi(j)}^x(t^x)$ potential retweeters of $v_{\pi(j)}^x$ have not done so yet (or we would have observed them by time t^x).

¹Except in the degenerate case where $m_j^x = f_j^x$, in which case $M_j^x = m_j^x$.

(3) A combinatorial term $\binom{M_{\pi(j)}^x}{m_{\pi(j)}^x(t^x)}$ which must be included because the unobserved retweets from the children of $v_{\pi(j)}^x$ could be any $M_{\pi(j)}^x - m_{\pi(j)}^x(t^x)$ of its $M_{\pi(j)}^x$ children.

Putting these components together, the likelihood of the prediction tweet observations, conditional on the missing $M_{\pi(j)}^x$, is given by

$$\begin{aligned}
& \mathbf{P}(\mathbf{S}_{t^x}^x, \mathbf{m}_{t^x}^x | \alpha^x, \tau^x, \mathbf{M}_{t^x}^x, m^x(t^x)) \\
&= \binom{M_0^x}{m_0^x(t^x)} (1 - F(\log(t^x - T_0^x) | \alpha^x, \tau^x))^{M_0^x - m_0^x(t^x)} \\
(17) \quad & \times \prod_{j=1}^{m^x(t^x)} \frac{1}{\sqrt{2\pi\tau^x}} \exp\left(-\frac{(\log(S_{\pi(j)}^x) - \alpha^x)^2}{2(\tau^x)^2}\right) \binom{M_{\pi(j)}^x}{m_{\pi(j)}^x(t^x)} \\
& \times (1 - F(\log(t^x - T_{\pi(j)}^x) | \alpha^x, \tau^x))^{M_{\pi(j)}^x - m_{\pi(j)}^x(t^x)}.
\end{aligned}$$

As can be seen from equation (17), for prediction tweets S_j^x and M_j^x are not conditionally independent. Because of this dependency we can use temporal observations (retweet times) to predict the final retweet graph structure (and hence the final retweet count of the tweet).

To obtain the complete data likelihood, we simply multiply equation (17) by $\mathbf{P}(M_{\pi(j)}^x | b_{\pi(j)}^x, F_{\pi(j)}^x)$ and sum over all possible values of $M_{\pi(j)}^x$. If we define $\mathbf{b}_{t^x}^x = \bigcup_{j=0}^{m^x(t^x)} b_{\pi(j)}^x$, then the marginal likelihood is

$$\begin{aligned}
& \mathbf{P}(\mathbf{S}_{t^x}^x, \mathbf{m}_{t^x}^x | \alpha^x, \tau^x, \mathbf{b}_{t^x}^x) \\
&= \sum_{M_0^x} \binom{M_0^x}{m_0^x(t^x)} (1 - F(\log(t^x - T_0^x) | \alpha^x, \tau^x))^{M_0^x - m_0^x(t^x)} \\
& \times \prod_{j=1}^{m^x(t^x)} \frac{1}{\sqrt{2\pi\tau^x}} \exp\left(-\frac{(\log(S_{\pi(j)}^x) - \alpha^x)^2}{2(\tau^x)^2}\right) \\
& \times \sum_{M_{\pi(j)}^x} P(M_{\pi(j)}^x | b_{\pi(j)}^x, F_{\pi(j)}^x) \binom{M_{\pi(j)}^x}{m_{\pi(j)}^x(t^x)} \\
& \times (1 - F(\log(t^x - T_{\pi(j)}^x) | \alpha^x, \tau^x))^{M_{\pi(j)}^x - m_{\pi(j)}^x(t^x)}.
\end{aligned}$$

Since this equation does not yield a closed form, we rely on imputing the missing M_j^x as described next in Section 3.5.

3.5. Posterior computations. To summarize, our goal is to calculate a predictive distribution for reaction times, and hence the number of eventual

retweets of a prediction tweet x , given a set of observed (training) retweet paths and the partial history of x observed up to time t^x . Recall that our model consists of three types of parameters. First, there are the global parameters $\Phi = \{\alpha, \sigma_\Delta, a_\tau, b_\tau, \beta_0, \beta_f, \beta_d, \sigma_b\}$ which are shared between tweets. Second, there are tweet specific parameters $\alpha = \bigcup_x \alpha^x$ and $\tau = \bigcup_x \tau^x$. Third, there is a tweet and user specific parameter: the retweet probability b_j^x . We define the set of all retweet probabilities as $\mathbf{b} = \bigcup_{x,j} b_j^x$.

The final vertex degrees (M_j^x) are missing data for the prediction tweets. We define \mathcal{P} as the set of prediction tweets and \mathcal{T} as the set of training tweets. We define the set of unobserved M_j^x for a tweet x as $\mathbf{M}^x = \bigcup_j M_j^x$. For the prediction tweets we define $\mathbf{M}_{\mathcal{P}} = \bigcup_{x \in \mathcal{P}} \mathbf{M}^x$ and for the training tweets we define $\mathbf{M}_{\mathcal{T}} = \bigcup_{x \in \mathcal{T}} \mathbf{M}^x$. We define the set of observed reaction times for a tweet x as $\mathbf{S}^x = \bigcup_j S_j^x$ and the set of all reaction times for both the training and prediction tweets as $\mathbf{S} = \bigcup_x \mathbf{S}^x$. Using the conditional dependencies in our model as laid out in Figure 7, the posterior distribution of the model parameters and $\mathbf{M}_{\mathcal{P}}$ given \mathbf{S} and $\mathbf{M}_{\mathcal{T}}$ can be written as

$$\begin{aligned}
 \mathbf{P}(\Phi, \alpha, \tau, \mathbf{b}, \mathbf{M}_{\mathcal{P}} | \mathbf{S}, \mathbf{M}_{\mathcal{T}}) &\propto \mathbf{P}(\Phi) \prod_x \mathbf{P}(\alpha^x | \alpha, \sigma_\Delta) \mathbf{P}(\tau^x | a_\tau, b_\tau) \\
 &\times \prod_{x,j} \mathbf{P}(M_j^x | b_j^x, f_j^x) \mathbf{P}(b_j^x | \mu_j^x, \sigma_b) \\
 (18) \quad &\times \prod_{x \in \mathcal{T}} \mathbf{P}(\mathbf{S}^x | \alpha^x, \tau^x, \mathbf{M}^x) \\
 &\times \prod_{x \in \mathcal{P}} \mathbf{P}(\mathbf{S}^x, \mathbf{m}_{t^x}^x | \alpha^x, \tau^x, \mathbf{M}^x).
 \end{aligned}$$

To examine our desired predictive distribution of $\mathbf{M}_{\mathcal{P}}$, we sample from equation (18) using an MCMC sampler which involves sampling the model parameters in addition to $\mathbf{M}_{\mathcal{P}}$. The predictive distribution is approximated by utilizing samples of $\mathbf{M}_{\mathcal{P}}$. Also, despite being potentially very high dimensional, the structure of the posterior distribution lends itself to an efficient parallelized implementation which can result in significant speedup. The details of the stages of our sampler along with the parallelized implementation are provided in the [Appendix](#).

4. Results. We partition our data set into a set of 26 training tweets \mathcal{T} and a set of 26 prediction tweets \mathcal{P} . We randomly divide the tweets such that the training and prediction sets have similar retweet count distributions. The specific partition used can be found in the supplemental materials [Zaman, Fox and Bradlow (2014)]. We aim to calculate the predictive distribution for $\mathbf{M}_{\mathcal{P}}$ using a fixed observation fraction of retweets for each prediction.

For instance, for an observation fraction of 10%, we used as observations all data from the 26 training tweets and the first 10% of the total number of reaction times for each of the 26 prediction tweets. Note that by fixing the observation *fraction*, we are observing each prediction tweet up to a different time. We use observation fractions ranging from 10% to 100%. 100 represents a fully in-sample analysis, and lower fractions are used to understand how early on in a tweet’s life predictions can be made.

For each observation fraction, we generated posterior samples using three independent MCMC chains with dispersed starting points run for 3000 iterations and discarding a burn-in period of 1000 iterations. Convergence of the MCMC sampler was assessed using the Gelman–Rubin statistic [Gelman and Rubin (1992)]. A histogram of the posterior samples of the global parameters for an observation fraction of 100% is shown in Figure 8 and the corresponding posterior means are shown in Table 1.

We find that the posterior mean of α is 7.42, which is comparable to the mean of the ML estimates of α^x from Section 2.3 (7.31). Also, the 90% posterior credible interval of the β parameters do not contain 0, indicating that these parameters are important to the predictive power of our model and agree with our earlier analyses from Section 2.4.

In Section 4.1 we describe our prediction results for the number of eventual retweets, followed by an analysis in Section 4.3 that looks at the impact of the number of followers (f_j^x) and the depth of the retweeters (d_j^x) on our predictions.

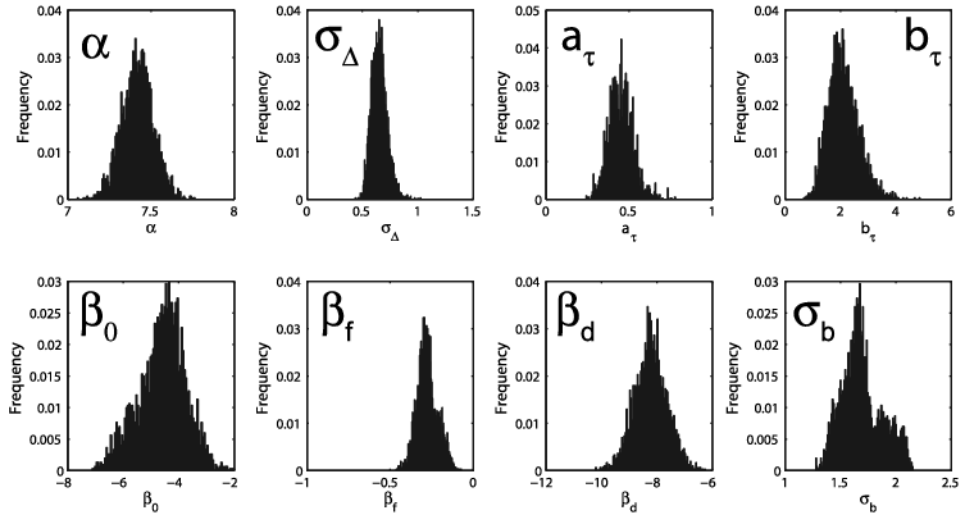

FIG. 8. Histograms of posterior samples of global parameters with an observation fraction of 100%.

TABLE 1
*Posterior means and standard deviations
(s.d.) for the global model parameters with
an observation fraction of 100% (a fully
in-sample analysis)*

Parameter	Posterior mean (s.d.)
α	7.42 (0.10)
σ_{Δ}	0.65 (0.07)
a_{τ}	0.45 (0.07)
b_{τ}	2.11 (0.55)
σ_b	1.69 (0.18)
β_0	-4.61 (0.85)
β_f	-0.28 (0.06)
β_d	-8.22 (0.59)

4.1. *Retweet prediction results.* The predictions of our model for the total number of retweets come from M_j^x , the eventual number of retweets from retweeter v_j^x . For instance, if at time t^x we observe $m^x(t^x)$ retweets, our prediction of the total number of retweets is given by the predictive distribution of $\sum_{j=0}^{m^x(t^x)} M_{\pi(j)}^x$. This serves as a step-ahead forecast of M^x . We discuss possibilities to go beyond this step-ahead prediction in Section 5.1.

Our predictions are for observation fractions ranging from 10% to 100%. The prediction results for four different root tweets are shown in Figure 9. We plot the median and 90% posterior credible intervals for the total number of retweets for different observation fractions. The predictions are plotted along with the number of observed retweets versus time. From these plots, it can be seen qualitatively that the predictions made within a few minutes for the eventual number of retweets are relatively close to the true value. We have found for all the prediction tweets that the median time for the total number of retweets to enter the 90% posterior credible interval of the prediction is 3 minutes.

To better understand the model predictions at the individual tweet level, we show boxplots of the posterior distribution of the absolute percent error (APE) for each prediction tweet (using the posterior median as the prediction value) for different observation fractions in Figure 10. The whiskers on the boxplots are the 90% posterior credible intervals. As can be seen, as we increase the observation fraction, the prediction error tends to decrease. There are a few tweets which have exceptionally large errors at a 40% observation fraction. We discuss these tweets in Section 5.2.

We can aggregate these results across all prediction tweets by looking at the APE of predictions made using the posterior median as our prediction value. We have found no significant relationship between the APE of a pre-

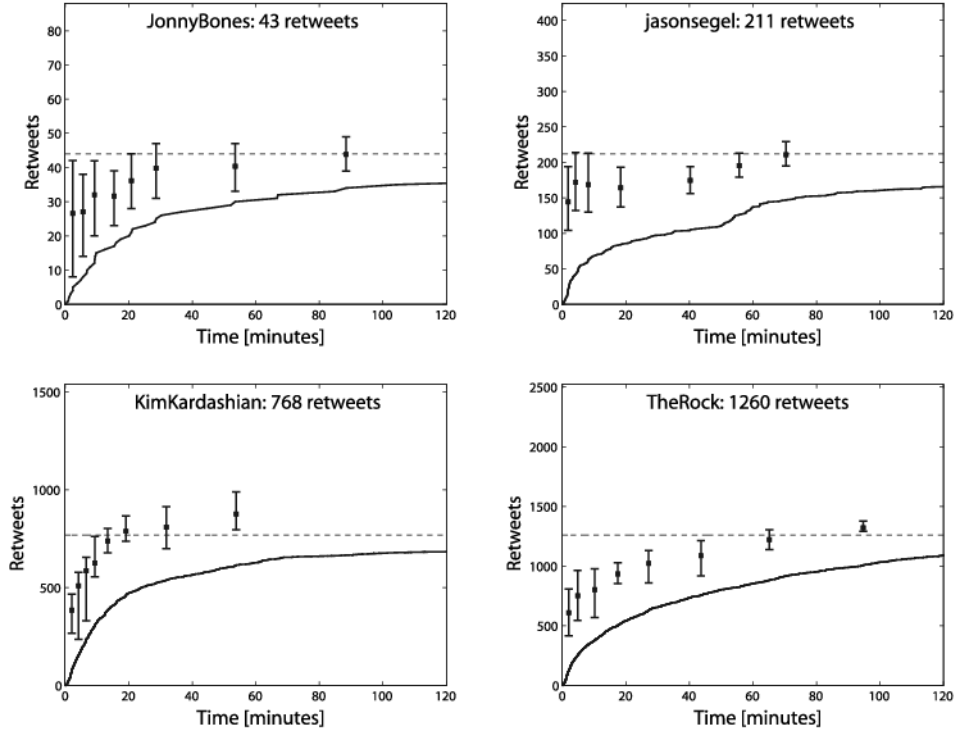

FIG. 9. Prediction of the total number of retweets for four different root tweets. The solid line represents the number of observed retweets versus time. The solid square is the posterior median of the predictive distribution for the total number of retweets based on observations only up to that time point. The error bars correspond to the 90% credible intervals. The horizontal dashed line is the final number of observed retweets M^x . The root user and total number of retweets of each tweet are shown in the plots.

diction and the final number of retweets. For instance, at 25%, 50% and 75% observation fractions the correlation between the APE and final number of retweets is 0.14 (p -value 0.49), 0.14 (p -value 0.49) and 0.14 (p -value 0.49), respectively. In Figure 11 we show a boxplot of the APE for all 26 prediction tweets versus observation fraction.

As can be seen, for our model the median APE (MAPE) is below 40% for observation fractions ranging from 10% to 100%. The average retweet time of the prediction tweets at a 10% observation fraction is 4.4 minutes. Therefore, we see that using only a few minutes of observations, we can predict with reasonable accuracy the total number of retweets given a small fraction of observations. To check robustness, we have repeated the predictions on 10 different random partitions of the tweets. We have found for 10% observation fraction the MAPE of each partition was between 20% and 36%, with an average value of 28%.

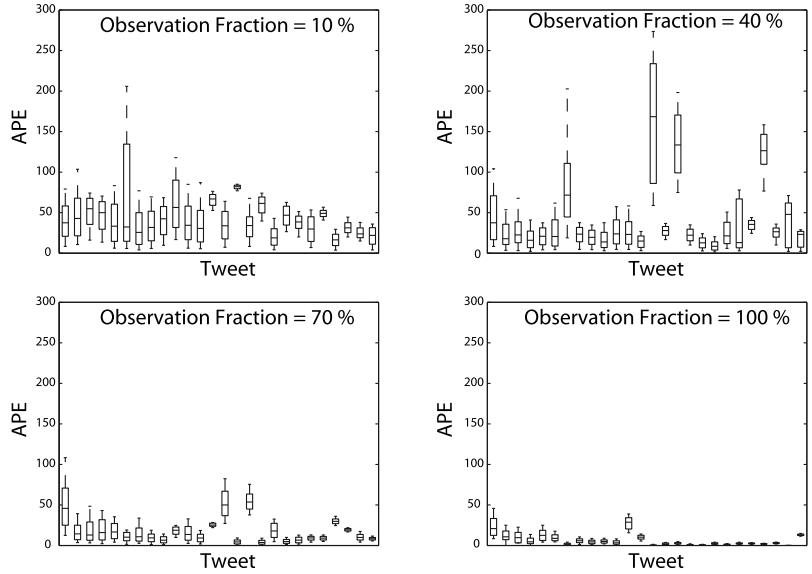

FIG. 10. *Boxplots of prediction absolute percent error (APE) for 26 prediction tweets. Each plot corresponds to a different observation fraction of retweets.*

To get a sense of how good the predictions are, consider the MAPE at 10% and 100%. At 10%, if one thought that there were no more retweets, the error would be 90%. Our model’s median error is less than 40%, which means that the model predicts that the tweet will receive many more retweets. At 90%, if one thought there were no more retweets, the error would be 10%. Our model’s median error is less than 10%, which means that the model predicts that the tweet is almost done spreading. Therefore, we see that our model can predict if a tweet has a significant amount of (retweet) life left or if it is near its end.

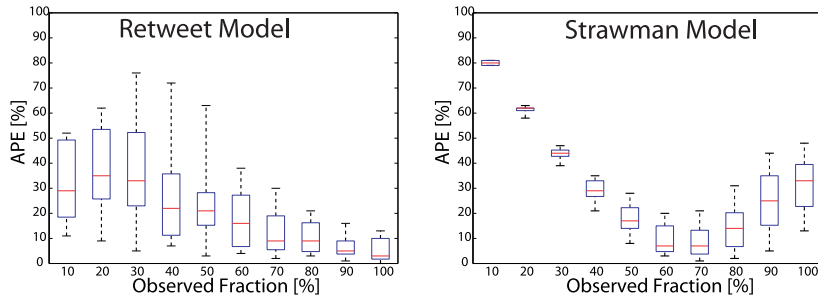

FIG. 11. *Boxplots of the APE of the retweet model and strawman model at different observation fractions.*

4.2. *Comparison with benchmark models.* We next compare our model with three different benchmark models. First, we consider a linear regression model that uses no temporal information and only the follower count of the root user (source tweeter). Second, we consider the regression model of Szabo and Huberman (2010) which uses only the current retweet count. Finally, we consider a dynamic Poisson model with exponentially decaying rate based on the work of Agarwal, Chen and Elango (2009). We will see that our model outperforms each of these approaches.

The linear regression model is as follows:

$$(19) \quad \log(M^x) = \beta_0 + \beta_1 \log(f_0^x) + \varepsilon^x,$$

where ε^x is a zero mean, normally distributed error term. This model only uses the root users' follower count to predict the final retweet count, but no information about the retweet times or followers and depth of retweeters.

The regression model of Szabo and Huberman (2010) for the final retweet count is

$$(20) \quad \log(M^x) = \beta(t) + \log(m^x(t)) + \varepsilon^x,$$

where ε^x is a zero mean, normally distributed error term. Here the final retweet count is modeled as a log-linear function of the current retweet log count at time t , where the intercept $\beta(t)$ is time varying. Since $m^x(t)$ approaches $M^x(t)$ as t goes to infinity, we also expect $\beta(t)$ to approach zero in this model.

For the dynamic Poisson model with exponentially decaying rate, we bin time into 5 minute intervals indexed by $k = 0, 1, 2, \dots$. The number of retweets in the k th bin is a Poisson random variable with rate $\lambda\delta^k$. Here λ is the initial retweet rate, and δ describes the exponential decay of the rate.

We perform ML estimation of these models on the training tweets, and then predict on the prediction tweets. For the linear regression model which only uses the follower count, the MAPE is 65%. This is much higher than our model that is able to use observations of retweet times. For the other two models which utilize retweet times, we plot their MAPE in Figure 12. We plot the MAPE of both the final retweet count and also the remaining retweet count (so that the maximum possible MAPE = 100%). For each type of MAPE, we can see that our retweet model outperforms the other models.

4.3. *Comparison with nested models: Impact of f_j^x and d_j^x .* To show the importance of f_j^x and d_j^x to our retweet model, we compare to a strawman model which ignores these covariates. The strawman model assumes that M_j^x comes from a Poisson distribution (not binomial as before since f_j^x is unknown) with global rate λ . We keep the reaction time component of the retweet model the same. We put an uninformative gamma prior on λ with

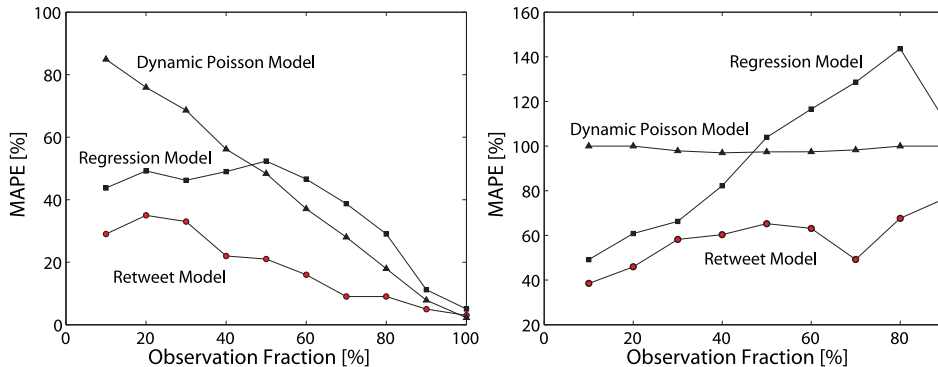

FIG. 12. Plots of the median absolute percentage error (MAPE) for the total retweet count (left) and remaining retweet count (right) versus observation fraction of retweets for 26 root tweets. The three curves are the MAPE for the retweet model, the linear regression model of Szabo and Huberman (2010) and the dynamic Poisson model with exponentially decaying rate.

shape and scale parameters 1 and 500, respectively. We use the median of the predictive distribution as a point estimate of the number of retweets in comparing our model’s performance to that of the strawman. In Figure 11 we show boxplots for the absolute percent error (APE) of the two models’ predictions for all of the prediction tweets versus the observation fraction. For an observation fraction of 10% (where predictions are most useful) the error of the strawman model is very high (MAPE = 80%) compared to our model (MAPE = 29%). Also, while our model’s error tends to decrease as more retweets are observed, the strawman model’s error decreases to a point and then increases again. The strawman model’s prediction for the total number of retweets is essentially a constant multiplied by the number of observed retweets. To make this more evident, in Figure 13 we plot the MAPE versus observation fraction for both models and a naive model which predicts $1.4m^x(t^x)$ for the eventual number of retweets. The factor of 1.4 was chosen to make the minimum MAPE of the naive model occur at the same observation fraction as the strawman model. As can be seen, the error of the strawman is very similar to the naive model.

To assess the overall fit of the two models, we compare their average log-likelihood (LL) and deviance information criterion (DIC) [Spiegelhalter et al. (2002)] for an observation fraction of 100% in Table 2. Models which fit better have larger values for the LL and smaller values for the DIC. As can be seen from Table 2, our model has a significantly better fit than the strawman model. This analysis demonstrates that f_j^x (user information) and d_j^x (retweet graph structure) are important elements for predicting retweets accurately.

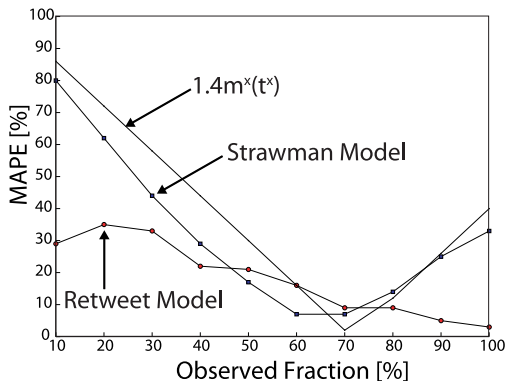

FIG. 13. Plot of the median absolute percentage error (MAPE) versus observation fraction of retweets for 26 root tweets. The three curves are the MAPE for the retweet model, a strawman model which ignores f_j^x and d_j^x , and a naive model which always predicts $1.4m^x(t^x)$.

5. Model extension opportunities. We next discuss various extensions to our retweet model. We first discuss improving our predictions using future potential retweeters. Then we discuss evidence in our data which suggests possible extensions to our reaction time model. Finally, we discuss the incorporation of side information for the tweets.

5.1. *Distribution over future potential retweeters.* Our current predictions are based on eventual retweets from existing users in the observed retweet graphs and do not take into account retweets of future retweeters who have not yet been observed. We can think of this prediction as a step-ahead forecast of the total eventual number of retweeters. In practice, it quickly provides a good estimate since most retweet graphs have low depth and retweets occur quickly. However, one could extend our prediction to account for the eventual retweets from users who have not yet been observed, in particular, by integrating over our uncertainty. This type of prediction would require greater knowledge of the structure of the underlying follower

TABLE 2
Average log-likelihood (LL) and deviance information criterion (DIC) for a 100% observation fraction for the full retweet model and a nested strawman model

	Retweet model	Strawman model
LL	-38,860	-103,907
DIC	83,848	208,026

graph. For instance, if a user has a follower with a large number of followers, this user may receive a large number of retweets due to a retweet from this follower. Therefore, incorporation of unobserved retweeters could potentially improve our predictions, but would require obtaining more data on the follower graph. Note, however, that under the (experimentally validated) assumption that the probability of retweeting decreases with depth, the sensitivity of our predictions to inaccuracies of future retweeter information may be minimal.

5.2. *Reaction time modeling.* As seen in Figure 10 (top right), at an observation fraction of 40% there are four different tweets with very large errors compared to the other tweets. We looked at these tweets more closely to try to understand the source of this error. The number of retweets for these tweets ranged from 73 to 608. What these tweets had in common was the fact that the number of retweets increased very rapidly at first, and then slowed down considerably. This behavior deviated from the log-normal reaction time model. If the reaction times were log-normal, then their logarithms would be normally distributed and the difference between the median and mean of their logarithms would be zero. Any deviation of this difference from zero can be viewed as a deviation from log-normality. We define Δ^x as this difference normalized by the median of the logarithm of the reaction times:

$$\Delta^x = \frac{\text{mean}(\log(S_j^x)) - \text{median}(\log(S_j^x))}{\text{median}(\log(S_j^x))}.$$

To show the similarities of the four high error tweets, in Figure 14 we plot Δ^x versus the median reaction time for each prediction tweet. The four triangles in the plot are the tweets with the large errors. As can be seen, these tweets have a short median reaction time along with a large value for Δ^x . Therefore, it seems that these tweets have reaction times that are not well

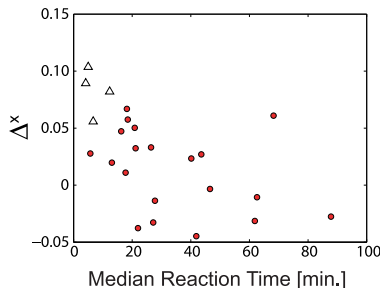

FIG. 14. Plot of median reaction time versus Δ^x for the prediction tweets. The triangle points are the tweets with large prediction errors at 40% observation from Figure 10.

modeled by the log-normal distribution, which leads to the larger prediction errors. It is an interesting area of future research to try and understand what properties of these tweets and the users who posted them cause this type of retweeting behavior and why the reaction times are not well modeled by the log-normal distribution.

5.3. Incorporation of side information. Our model relied primarily on the timing information of retweets, depth in the retweet graph and number of followers for predictions. However, there are other types of side information that we could incorporate which may potentially improve the accuracy of the predictions. One type of side information is the time of day. It may be that the retweet behavior of a tweet depends upon the time it was posted. Another type of side information is the content of the tweet. For instance, retweet behavior may depend upon the topic of the tweet, and whether or not that topic is a currently trending topic in Twitter. These types of side information can be readily incorporated into our modeling framework as covariates for the parameters such as α^x and b_j^x .

6. Conclusion. We have presented a model for retweet dynamics in Twitter. Our Bayesian approach allowed us to provide predictions for the total number of retweets, along with posterior credible intervals for the predictions. The predictions had a MAPE of less than 40% when at least 10% of the total number of retweets were observed. For most tweets, this translated to an average error less than 40% within 5 minutes of the tweet being posted.

We have shown that given the size of the retweeter network and depth from the source tweet, we are able to predict the number of potential viewers of a tweet. The level of accuracy in our predictions allows us to consider using this model for different applications. For example, it can be used to turn tweets into a potential source of impressions for display ads. Because tweets are typically only actively retweeted for a few hours, the early predictions our model provides are key to detecting a popular tweet before it receives a large amount of retweets. Also, the similarity of the manner by which people spread content in social networks suggest that this model can be used for other social networks such as Facebook. Therefore, our model's early predictions could create a whole new source of impressions for online advertising on dynamic social network content with a finite "lifetime."

Finally, because this model is for a single tweet, it can be used as the foundation for a more general model for the spread of broader ideas which involve multiple tweets from multiple users. Our model can easily be parallelized to analyze very large collections of tweets. With a model for the spread of ideas, we could develop a better understanding of how memes and trends spread and potentially predict the speed and magnitude of their popularity.

APPENDIX A: DETAILS OF MCMC SAMPLER

We use a Metropolis-within-Gibbs scheme to sample from the posterior distribution of the model parameters. We define the set of model parameters as $\Theta = \{\Phi, \mathbf{b}, \boldsymbol{\alpha}^x, \boldsymbol{\tau}^x, \mathbf{M}_P\}$ and for any parameter $\gamma \in \Theta$, we define the set of parameters excluding γ as $\Theta_{-\gamma}$. We also define the set of observed reaction times as \mathbf{S} . For our MCMC sampler, we must sample from the conditional distribution $\mathbf{P}(\gamma|\mathbf{S}, \mathbf{M}_T, \Theta_{-\gamma})$ for each model parameter. We will now derive these conditional distributions and show how to sample from them.

A.1. Retweet graph structure parameters.

Hyperparameters $\beta_0, \beta_F, \beta_d, \sigma_b^2$. The prior distributions for β_0, β_F and β_d are normal with mean 0 and standard deviation $\sigma_\beta = 100$. It can be shown that the joint conditional distribution of $(\beta_0, \beta_F, \beta_d)$ is multivariate normal with mean $\boldsymbol{\mu}$ and covariance matrix \mathbf{C} . Because of this, we can directly sample the β 's in a Gibbs step. We simply need to determine $\boldsymbol{\mu}$ and \mathbf{C} . To do this, first we let N be the total number of observed reaction times for all training and prediction tweets. To express the mean and covariance of the conditional distribution, it is helpful to define the following variables:

$$\begin{aligned} N_1 &= N + \sigma_b^2 \sigma_\beta^{-2}, & E &= \sum_{x,j} \log(f_j^x + 1) \log(d_j^x + 1), \\ D &= \sum_{x,j} \log(d_j^x + 1), & D_2 &= \sum_{x,j} \log^2(d_j^x + 1) + \sigma_b^2 \sigma_\beta^{-2}, \\ F &= \sum_{x,j} \log(f_j^x + 1), & F_2 &= \sum_{x,j} \log^2(f_j^x + 1) + \sigma_b^2 \sigma_\beta^{-2}, \\ Y_0 &= \sum_{x,j} \log(b_j^x + 1), & Y_F &= \sum_{x,j} \log(b_j^x + 1) \log(f_j^x + 1), \\ Y_d &= \sum_{x,j} \log^2(b_j^x + 1) \log(d_j^x + 1) + \sigma_b^2 \sigma_\beta^{-2}. \end{aligned}$$

Then the covariance matrix of the conditional distribution is given by

$$\mathbf{C} = \sigma_b^2 \begin{bmatrix} N_1 & F & D \\ F & F_2 & E \\ D & E & D_2 \end{bmatrix}^{-1}$$

and its mean is given by

$$\boldsymbol{\mu} = \begin{bmatrix} N_1 & F & D \\ F & F_2 & E \\ D & E & D_2 \end{bmatrix}^{-1} \begin{bmatrix} Y_0 \\ Y_F \\ Y_d \end{bmatrix}.$$

The prior distribution of σ_b^2 is inverse-gamma with shape and scale parameters $a_{\sigma_b} = 0.5$ and $b_{\sigma_b} = 0.5$, respectively. We can directly sample from the conditional distribution for σ_b^2 because it is inverse-gamma with shape parameter a'_{σ_b} and scale parameter b'_{σ_b} given by

$$a'_{\sigma_b} = a_{\sigma_b} + \frac{N}{2},$$

$$b'_{\sigma_b} = b_{\sigma_b} + \frac{1}{2} \sum_{x,j} (\text{logit}(b_j^x) - \mu_j^x)^2,$$

where $\mu_j^x = \beta_0 + \beta_F \log(f_j^x + 1) + \beta_d \log(d_j^x + 1)$.

Parameters b_j^x . The conditional distribution of b_j^x is given by

$$\mathbf{P}(b_j^x | \mathbf{S}, \mathbf{M}_{\mathcal{T}}, \Theta_{-b_j^x}) \propto \mathbf{P}(M_j^x | b_j^x) \mathbf{P}(b_j^x | \beta_0, \beta_F, \beta_d, \sigma_b)$$

$$\propto (b_j^x)^{M_j^x} (1 - b_j^x)^{f_j^x - M_j^x} \exp\left(-\frac{(\text{logit}(b_j^x) - \mu_j^x)^2}{2\sigma_b^2}\right).$$

To sample from this conditional distribution, we use a Metropolis–Hastings step with the proposal value for $\text{logit}(b_j^x)$ drawn from a normal distribution with mean μ_j^x and standard deviation σ_b .

Missing M_j^x . The conditional distribution for M_j^x is

$$\mathbf{P}(M_j^x | \mathbf{S}, \mathbf{M}_{\mathcal{T}}, \Theta_{-M_j^x}) \propto \binom{M_j^x}{m_j^x} (1 - F(\log(t - S_j^x) | \alpha^x, \tau))^{M_j^x - m_j^x}$$

$$\times \binom{f_j^x}{M_j^x} (b_j^x)^{M_j^x} (1 - b_j^x)^{f_j^x - M_j^x} \mathbf{1}\{M_j^x \geq m_j^x\}.$$

We generate samples from this conditional distribution using a Metropolis–Hastings step with the proposal for M_j^x drawn from a binomial distribution $\text{Bi}(f_j^x, b_j^x)$.

A.2. Retweet time parameters.

Hyperparameters α , σ_{Δ}^2 , a_{τ} , b_{τ} . We utilized an extremely diffuse prior distribution for α that is normal with mean 0 and standard deviation $\sigma_{\alpha} = 100$. The conditional distribution of α is again normal with mean μ'_{α} and variance $\sigma_{\alpha}^{\prime 2}$, so it can be directly sampled. If we define the total number of root tweets (training and prediction) as N_t , then the mean and variance are

$$\mu'_{\alpha} = (N_t + \sigma_{\Delta}^2 \sigma_{\alpha}^{-2})^{-1} \sum_x \alpha^x,$$

$$\sigma_{\alpha}^{\prime 2} = (N_t + \sigma_{\Delta}^2 \sigma_{\alpha}^{-2})^{-1} \sigma_{\Delta}^2.$$

The prior distribution of σ_Δ^2 is inverse-gamma with shape and scale parameters $a_{\sigma_\Delta} = 0.5$ and $b_{\sigma_\Delta} = 0.5$, respectively. We can directly sample from the conditional distribution for σ_Δ^2 because it is again inverse-gamma with shape parameter a'_{σ_Δ} and scale parameter b'_{σ_Δ} given by

$$\begin{aligned} a'_{\sigma_\Delta} &= a_{\sigma_\Delta} + \frac{N_t}{2}, \\ b'_{\sigma_\Delta} &= b_{\sigma_\Delta} + \frac{1}{2} \sum_x (\alpha^x - \alpha)^2. \end{aligned}$$

The prior distribution of $\log(a_\tau)$ is normal with mean $\mu_a = 0$ and standard deviation $\sigma_a = 10$. The conditional distribution of a_τ is given by

$$\begin{aligned} \mathbf{P}(a_\tau | \mathbf{S}, \mathbf{M}_\mathcal{T}, \Theta_{-\alpha^x}) &\propto \mathbf{P}(a_\tau) \prod_{x=1}^{N_t} \mathbf{P}(\tau^x | a_\tau, b_\tau) \\ &= \exp\left(-\frac{\log^2(a_\tau)}{2\sigma_a^2}\right) \prod_{x=1}^{N_t} \frac{b_\tau^{a_\tau}}{\Gamma(a_\tau)} (\tau^x)^{-a_\tau}. \end{aligned}$$

To sample from this conditional distribution, we use a random walk Metropolis–Hastings step. That is, if we define the i th sample of a_τ as $a_{\tau,i}$, the proposal for the $(i+1)$ sample is drawn from a normal distribution with mean $a_{\tau,i}$ and standard deviation 0.2, where 0.2 is chosen to balance the acceptance rate with step size.

The prior distribution of b_τ is gamma with shape parameter $k_b = 1$ and scale parameter $\theta_b = 500$. We can sample directly from the conditional distribution of b_τ because it is gamma with shape parameter k'_b and scale parameter θ'_b given by

$$\begin{aligned} k'_b &= k_b + N_t a_\tau, \\ \theta'_b &= \left(\theta_b^{-1} + \sum_j (\tau^j)^{-1} \right)^{-1}. \end{aligned}$$

Parameters α^x , τ^x . The conditional distribution of α^x depends upon whether the root tweet is in the training or prediction set. For training tweets, the conditional distribution of α^x is normal with mean μ_{α^x} and variance $\sigma_{\alpha^x}^2$ with

$$\begin{aligned} \mu_{\alpha^x} &= (M^x + \tau^2 \sigma_\Delta^{-2})^{-1} \sum_{j=1}^{N_t} \log(S_j^x), \\ \sigma_{\alpha^x}^2 &= (M^x + \tau^2 \sigma_\Delta^{-2})^{-1} \tau^2. \end{aligned}$$

For a prediction tweet with n observed retweets, the conditional distribution of α^x is given by

$$\begin{aligned} & \mathbf{P}(\alpha^x | \mathbf{S}, \mathbf{M}_{\mathcal{T}}, \Theta_{-\alpha^x}) \\ & \propto \exp\left(\frac{(\alpha^x - \alpha)^2}{2\sigma_{\Delta}^2}\right) \\ & \quad \times \prod_{j=0}^{n-1} \exp\left(-\frac{(\log(T_{j+1}^x) - \alpha^x)^2}{2\tau^2}\right) (1 - F(\log(t - S_j^x) | \alpha^x, \tau))^{M_j^x - m_j^x}. \end{aligned}$$

To sample from this conditional distribution, we use a random walk Metropolis–Hastings step. We define the i th sample of α^x as α_i^x , and the proposal for the $(i + 1)$ sample is drawn from a normal distribution with mean α_i^x and standard deviation 0.2, where 0.2 is chosen to balance the acceptance rate with step size.

The prior distribution of $(\tau^x)^2$ is inverse-gamma with shape and scale parameters a_{τ} and b_{τ} , respectively. We denote the inverse-gamma density function by $\text{IG}(\cdot | a_{\tau}, b_{\tau})$. The conditional distribution of $(\tau^x)^2$ can be written as

$$\begin{aligned} & \mathbf{P}((\tau^x)^2 | \mathbf{S}, \mathbf{M}_{\mathcal{T}}, \Theta_{-\tau}) \\ & \propto \text{IG}((\tau^x)^2 | a'_{\tau}, b'_{\tau}) \prod_{x \in \mathcal{P}} (1 - F(\log(t - S_j^x) | \alpha^x, \tau))^{M_j^x - m_j^x}, \end{aligned}$$

where the parameters of the inverse-gamma density function above are

$$\begin{aligned} a'_{\tau} &= a_{\tau} + \frac{m^x(t)}{2}, \\ b'_{\tau} &= b_{\tau} + \frac{1}{2} \sum_{j=1}^{m^x(t)} (\log(S_j^x) - \alpha^x)^2. \end{aligned}$$

For training tweets, $M_j^x = m_j^x$, so the conditional distribution is inverse-gamma and we can sample τ^x directly. For prediction tweets, we must use a Metropolis–Hastings step with the proposal value for $(\tau^x)^2$ drawn from an inverse-gamma distribution with shape and scale parameters a'_{τ} and b'_{τ} , respectively.

APPENDIX B: DISTRIBUTED IMPLEMENTATION OF MCMC SAMPLER

The MCMC sampler lends itself naturally to distributed computation. The variables to be sampled are global (shared) and local (tweet/user specific). The main computational burden comes from the local random vari-

ables, of which there can be thousands or millions, depending on the size of the observations. However, the steps for sampling many of these local variables can be done simultaneously, which can result in a considerable speedup.

There are two random variables associated with each tweet/user pair $(x, j): b_j^x$ and M_j^x . The only local variable the sampling step of b_j^x depends on is M_j^x . For sampling M_j^x , the only local variables needed are b_j^x , α^x and τ^x . Therefore, the sampling steps of b_j^x and M_j^x must be done sequentially. However, this sequence of steps can be done in parallel across all tweet/user pairs (x, j) .

There are two random variables associated solely with each tweet $x: \alpha^x$ and τ^x . The sampling of α^x needs the values of τ^x and all M_j^x associated with tweet x . Similarly, the sampling of τ^x depends on the values of α^x and all M_j^x associated with tweet x . Therefore, the sampling steps of α^x and τ^x must be done sequentially, but this can be done in parallel across all tweets x .

Putting all this together, we obtain the following distributed implementation of the MCMC sampler to generate a sample from the full posterior distribution. First, sequentially sample the global parameters Φ . Second, sequentially sample the parameters α^x and τ^x for a tweet x , but simultaneously for all tweets. Third, sequentially sample the parameters b_j^x and M_j^x for all tweet/user pairs (x, j) , but simultaneously for all tweet/user pairs. This results in a classic data parallel setup that can be efficiently implemented using frameworks such as MapReduce.

SUPPLEMENTARY MATERIAL

Supplement: Retweet time series data (DOI: [10.1214/14-AOAS741SUPP](https://doi.org/10.1214/14-AOAS741SUPP); .zip). These files contain the data of the retweet time series for the root tweets studied in this paper. They also include the files which contain the different partitions of the tweets into training and prediction sets used for the analysis in this paper.

REFERENCES

- AGARWAL, D., CHEN, B. and ELANGO, P. (2009). Spatial-temporal models for estimating click-through rates. Unpublished manuscript.
- BAKSHY, E., HOFMAN, J. M., MASON, W. A. and WATTS, D. J. (2010). Everyone’s an influencer: Quantifying influence on Twitter. In *Proc. WSDM*. ACM, New York.
- BANDARI, R., ASUR, S. and HUBERMAN, B. A. (2012). The pulse of news in social media: Forecasting popularity. In *AAAI Conference on Weblogs and Social Media*. AAAI, Dublin, Ireland.

- BROWN, L., GANS, N., MANDELBAUM, A., SAKOV, A., SHEN, H., ZELTYN, S. and ZHAO, L. (2005). Statistical analysis of a telephone call center: A queueing-science perspective. *J. Amer. Statist. Assoc.* **100** 36–50. [MR2166068](#)
- CHA, M., HADDADI, H., BENEVENUTO, F. and GUMMADI, K. P. (2010). Measuring user influence in Twitter: The million follower fallacy. In *Proc. AAAI Conf. on Weblogs and Social Media*. AAAI, Washington, DC.
- GELMAN, A. and HILL, H. (2007). *Data Analysis Using Regression and Multi-level/Hierarchical Models*. Cambridge Univ. Press, Cambridge.
- GELMAN, A. and RUBIN, D. B. (1992). Inference from iterative simulation using multiple sequences. *Statist. Sci.* **7** 457–472.
- GOEL, S., WATTS, D. J. and GOLDSTEIN, D. G. (2012). The structure of online diffusion networks. In *Proc. EC*. ACM, New York.
- HONG, L., DAN, O. and DAVISON, B. D. (2011). Predicting popular messages in Twitter. In *Proceedings of the 20th International Conference Companion on World Wide Web* 57–58. ACM, New York.
- KWAK, H., LEE, C., PARK, H. and MOON, S. (2010). What is Twitter, a social network or a news media? In *Proc. WWW*. ACM, New York.
- NAVEED, N., GOTTRON, T., KUNEGIS, J. and ALHADI, A. C. (2011). Bad news travels fast: A content-based analysis of interestingness on Twitter. In *ACM Web Science*. ACM, New York.
- PETROVIC, S., OSBORNE, M. and LAVRENKO, V. (2011). RT to win! Prediction message popularity in Twitter. In *AAAI Conference on Weblogs and Social Media*. AAAI, Barcelona. Spain.
- SPIEGELHALTER, D. J., BEST, N. G., CARLIN, B. P. and VAN DER LINDE, A. (2002). Bayesian measures of model complexity and fit. *J. R. Stat. Soc. Ser. B Stat. Methodol.* **64** 583–639. [MR1979380](#)
- STOUFFER, D. B., MALMGREN, R. D. and AMARAL, L. A. N. (2006). Log-normal statistics in e-mail communication patterns. Available at [ArXiv:physics/0605027](#).
- SUH, B., HONG, L., PIROLI, P. and CHI, E. H. (2010). Want to be retweeted? Large scale analysis on factors impacting retweet in Twitter network. In *IEEE International Conference on Social Computing* 177–184. IEEE, Minneapolis, MN.
- SZABO, G. and HUBERMAN, B. A. (2010). Predicting the popularity of online content. *Commun. ACM* **8** 80–88.
- TWITTER (2012). Using the Twitter search API. Available at <https://dev.twitter.com/docs/using-search>.
- ULRICH, R. and MILLER, J. (1993). Information processing models generating lognormally distributed reaction times. *J. Math. Psych.* **37** 513–525.
- US SECURITIES and EXCHANGE COMMISSION (2013). Twitter, Inc. Form S-1. Available at <http://www.sec.gov/Archives/edgar/data/1418091/000119312513424260/d564001ds1a.htm>.
- VAN BREUKELLEN, G. J. P. (1995). Theoretical note: Parallel information processing models compatible with lognormally distributed response times. *J. Math. Psych.* **39** 396–399.
- VU, D. Q., ASUNCION, A. U., HUNTER, D. R. and SMYTH, P. (2011). Dynamic egocentric models for citation networks. In *International Conference on Machine Learning*. ACM, New York.
- ZAMAN, T., FOX, E. B. and BRADLOW, E. T. (2014). Supplement to “A Bayesian approach for predicting the popularity of tweets.” DOI:[10.1214/14-AOAS741SUPP](https://doi.org/10.1214/14-AOAS741SUPP).
- ZAMAN, T., HERBRICH, R., GAEL, J. V. and STERN, D. (2010). Predicting information spreading in Twitter. In *Proc. Workshop on Computational Social Science and the Wisdom of Crowds, NIPS*. NIPS, Vancouver, Canada.

ZHOU, Z., BANDARI, R., KONG, J., QIAN, H. and ROYCHOWDHURY, V. (2010). Information resonance on Twitter: Watching Iran. In *ACM Workshop on Social Media Analytics* 123–131. ACM, New York.

T. ZAMAN
SLOAN SCHOOL OF MANAGEMENT
MASSACHUSETTS INSTITUTE OF TECHNOLOGY
CAMBRIDGE, MASSACHUSETTS 02139
USA
E-MAIL: zlisto@mit.edu

E. B. FOX
DEPARTMENT OF STATISTICS
UNIVERSITY OF WASHINGTON
BOX 354322
SEATTLE, WASHINGTON 98195
USA
E-MAIL: ebfox@stat.washington.edu

E. T. BRADLOW
THE WHARTON SCHOOL
UNIVERSITY OF PENNSYLVANIA
PHILADELPHIA, PENNSYLVANIA 19104
USA
E-MAIL: ebradlow@wharton.upenn.edu