

Implementing Flow Time Reduction Using Process Mapping and Innovation

by

Scott K. Jacobsmeyer

S.B., Materials Science and Engineering,
Massachusetts Institute of Technology (1992)

Submitted to the Department of Mechanical Engineering
and the Sloan School of Management
in Partial Fulfillment of the Requirements for the Degrees of

Master of Science in Mechanical Engineering
and
Master of Science in Management

in conjunction with the
Leaders for Manufacturing Program

at the
Massachusetts Institute of Technology
May 1994

© 1994 Massachusetts Institute of Technology
All rights reserved

Signature of Author _____
Department of Mechanical Engineering
MIT Sloan School of Management
May 6, 1994

Certified by _____
Stuart B. Brown,
Professor of Materials Science and Engineering
Thesis Supervisor

Certified by _____
Stephen C. Graves,
Professor of Management Science
Thesis Supervisor

Accepted by _____
Ain A. Sonin, Professor of Mechanical Engineering
Chairman, Departmental Committee on Graduate Students

Accepted by _____
Jeffrey A. Barks
Associate Dean, ~~Dean~~ Bachelor's and Master's Programs

MASSACHUSETTS INSTITUTE OF
TECHNOLOGY

AUG 01 1994

LIBRARY

OXFORD

Implementing Flow Time Reduction Using Process Mapping and Innovation

by

Scott K. Jacobsmeyer

Submitted to the Departments of Mechanical Engineering
and the Sloan School of Management
in Partial Fulfillment of the Requirements for the Degrees of

**Master of Science in Mechanical Engineering
and
Master of Science in Management**

Abstract

Flow time reduction can be used by the manufacturing firm as a competitive advantage in several ways. Lower flow times result in less capital being held up in inventory, increased responsiveness to changing customer needs, and more rapid detection of processing abnormalities. This thesis is a case study on a flow time reduction program conducted at a large metal fabrication company.

Two distinct techniques, process mapping and process innovation, were applied simultaneously to reduce the overall flow time on a particular product. The first technique, process mapping, was focused on identifying and eliminating inefficiencies in the execution of the existing manufacturing process. Such opportunities were brought to light through a rigorous analysis of each step in the manufacturing flow path by a cross-functional team representing different segments of the process. These process mapping sessions were able to identify numerous incremental gains that when pooled together represented a substantial flow time reduction opportunity.

The second technique, process innovation, was applied to reduce flow time by radically changing some component of the physical manufacturing process (i.e. the transformation of raw materials into finished product). In this case, a proprietary new heat treatment procedure was developed and characterized as a potential replacement of the existing process. If implemented, it has the potential to dramatically reduce the flow times and improve product quality.

This thesis evaluates the implementation of this flow time reduction program in three ways. First, the process mapping and process development procedures are described and documented as applied to this situation. Second, the strengths and weaknesses of each as applied in a real manufacturing plant environment are discussed candidly. Finally, general conclusions and recommendations about the flow time reduction process are made to provide guidance to readers preparing to engage in a similar effort.

Thesis Advisors:

**Stuart B. Brown, Professor of Materials Science and Engineering
Stephen C. Graves, Professor of Management Science**

Acknowledgments

The author gratefully acknowledges the Leaders for Manufacturing Program for its support of this work.

Thanks to all the people at the plant for graciously hosting my internship and treating me like a member of the family. You helped make my experience both successful and thoroughly enjoyable. I wish you all continued success in the future.

Thanks to John, Dan, Roger, Dick, and the other members of the flow time reduction team for taking the time to answer what must have seemed an endless stream of my questions. Thanks to Dan, Matt, and Kirk of the CAD/CAM lab for their assistance with the finite element modeling portion this research. Thanks to Bill, Amiya, and Ken for contributing their time and resources to the technical portion this research. This project was truly a team effort. I hope our efforts are rewarded by increased orders in the future.

Thanks to Bob, John, and Dan for acting as my mentors throughout the internship experience.

Thanks to my thesis advisors Stuart Brown and Stephen Graves for their guidance and support of this project.

Thanks to the fellows of the LFM program for providing such a stimulating and invigorating environment in which to learn over the past two years. I hope that we will stay in contact in the future, and I wish you all success in all your endeavors.

Finally, special thanks go out to my fiancée Tiina for her unwavering love and support throughout the past two years. I am very much looking forward to building our future together.

Table of Contents

Abstract	3
Acknowledgments	5
Table of Contents	7
List of Figures	9
List of Tables	9
List of Equations	9
Chapter 1 -- Introduction	11
1.1 Context of Thesis	11
1.2 Objectives	13
1.3 Results	13
1.4 Organization of Thesis	15
Chapter 2 -- Background Information for Flow Time Reduction Analysis	17
2.1 Chapter Overview	17
2.2 Motivation for Pursuing Flow Time Reduction	17
2.3 Framework for Pursuing Flow Time Reduction	18
2.4 Business Environment at ACME Metal Products	21
2.5 Introduction to the Manufacturing Process for Product X	22
2.6 Chapter 2 Summary	24
Chapter 3 -- Historical Flow Time Analysis	25
3.1 Chapter Overview	25
3.2 Assembling the Flow Time Database	25
3.3 Summary Characteristics of Historical Flow Time Data	26
3.4 Interpretation of Data	29
3.4.1 Benchmark Flow Times	29
3.4.2 Trend Analysis	30
3.5 Flow Time Database Revisited	32
3.6 Chapter 3 Summary	33
Chapter 4 -- Flow Time Reduction Through Process Mapping	35
4.1 Chapter Overview	35
4.2 The Process Mapping Procedure	35
4.3 Results of Process Mapping Procedure on Product X	38
4.4 Discussion of Process Mapping Results	41
4.5 Barriers to Implementation of Flow Time Reduction Projects	42
4.6 Chapter 4 Summary	45
Chapter 5 -- Flow Time Reduction Through Process Innovation	47
5.1 Chapter Overview	47
5.2 Introduction to the Direct Solution and Age (DSA) Process	47
5.3 Finite Element Modeling of the Quenching Process	50
5.3.1 Why Finite Element Modeling	50
5.3.2 Procedure for Modeling Quenching Process	51
5.3.3 Solving for the Heat Transfer Coefficient	53
5.3.4 Application of Heat Transfer Data to Production Configurations	55
5.3.5 Uncertainty Analysis	56
5.3.6 Conclusions from Finite Element Modeling of Quenching Process	58
5.3.7 Opportunities for Additional Finite Element Modeling	59
5.4 Process Definition at the ACME Research Center	60
5.4.1 Grain Size vs. Processing Variables Experimentation	60

Table of Contents (continued)

5.4.2 Critical Cooling Rate Experimentation	65
5.5 Chapter 5 Summary	66
Chapter 6 -- Summary, Conclusions, and Recommendations	69
6.1 Thesis Summary	69
6.2 Conclusions.....	70
6.2.1 Flow Time Reduction Through Process Mapping.....	70
6.2.2 Flow Time Reduction Through Process Innovation.....	70
6.3 Recommendations for Future Flow Time Reduction Efforts	71

List of Figures

Figure 2.5.1 - High Level Manufacturing Flow Path for Product X.....	23
Figure 3.3.1 - Average Flow Time Breakdown by Process Segment and Phase	28
Figure 4.2.1 - Coding System for Process Maps.....	35
Figure 4.2.2 - Initial Process Map for Widget Making Example.....	36
Figure 4.2.3 - Sub-Process Map for Widget Making Example.....	36
Figure 4.3.1 - Intermediate Level Process Map for Ingot Manufacturer A	39
Figure 5.3.2.1 - Representative 2-D Cross Section of a Metal Slab	51
Figure 5.3.3.1 - Modeled vs. Experimental Comparison of Type A Quench	54
Figure 5.3.3.2 - Modeled vs. Experimental Comparison of Type B Quench	55

List of Tables

Table 3.3.1 - Historical Flow Times by Process Segment for Product X	27
Table 3.3.2 - Comparison of Flow Times Versus Year Process Completed	27
Table 4.2.1 - Prioritization Matrix for Flow Time Reduction Projects.....	38
Table 4.3.1 - Summary of Projects Identified Using Process Mapping Procedure	39
Table 5.3.4.1 - Center Cooling Rates for Type A and Type B Quenches.....	56
Table 5.4.1.1 - Experimental Matrix for Grain Size Experiments	61
Table 5.4.1.2 - Results of Grain Size Experiments	62
Table 5.4.1.3 - Calculated Effects of Variables in Grain Size Experiments	63
Table 5.4.2.1 - Material Properties for Post-Solution Cooling Rate Experiments.....	65

List of Equations

Equation 5.3.2.1 - Calculation of the Radiation Heat Transfer Coefficient.....	52
Equation 5.3.2.2 - Calculation of Total Heat Transfer Coefficient.....	52
Equation 5.3.5.1 - Calculation of the Biot Number	57

Chapter 1 -- Introduction

1.1 Context of Thesis

"The Leaders for Manufacturing Program is a partnership between MIT and major U.S. manufacturing firms to discover and translate into teaching and practice principles that produce world-class manufacturing and manufacturing leaders. This partnership is motivated by our shared belief that excellence in manufacturing is critical to meeting the economic and social needs of individuals, firms, and society, and that the health of U.S. based companies operating in global markets is essential to the nation's well being."

This is the vision statement of the Leaders for Manufacturing Program (LFM). Fellows in LFM commit themselves to this vision by engaging in an intensive two year engineering-management-manufacturing curriculum at MIT. One of the cornerstones of the LFM experience is an integrative research project conducted during a seven month internship at one of the partner companies. Projects are selected to address real issues in the manufacturing environment today. This thesis is the product of such an internship.

At its most literal level, this thesis addresses the topic of reducing the manufacturing flow time of a particular product (henceforth known as Product X) at a large metal fabrication company (henceforth known as ACME Metal Products)¹. Flow time reduction was pursued using two distinct techniques: process mapping and process innovation. Process mapping was utilized as a means of identifying and eliminating inefficiencies in the execution of the existing manufacturing process. Process innovation was applied with the goal of radically changing part of the manufacturing process to yield a step function improvement in flow time and product quality. The approach of simultaneously seeking incremental improvements through process mapping and step function improvements through process innovation is broadly applicable. Survival in

¹ The names of the company at which this research was conducted, the product, and the customer of that product have been disguised to protect proprietary and confidential interests. All data on flow times and technical characteristics of the product have also been disguised.

today's competitive environment requires the manufacturing firm to seek change and improvement using both techniques. These procedures, results, analyses, and conclusions as applied to this flow time reduction effort are described in detail herein and will hopefully provide guidance to anyone attempting a similar project.

At another level, this thesis is about what happens when the neatly packaged ideas of the academic world run head on into a real life manufacturing plant with real people and real barriers to change. Even the most logical and best planned strategy for introducing a good, required change into the manufacturing environment will encounter unanticipated hurdles and barriers. One of the members of the flow time reduction team often quipped to me, "I guess the answer to this problem isn't as simple as what's on page 17 of your textbook." This is not to say that the textbook ideas are invalid, but rather the implementation strategy must be flexible and responsive to the needs of the specific situation. The frictions and challenges of operating at the interface of the academic and real worlds are interwoven into the fabric of this thesis.

Finally, this thesis is about people and change. I firmly believe that all people want to do a good job in their work and will do so if given the opportunity. Well meaning people, however, do not always agree or understand one another, especially in the face of uncertainty and change. For any individual, team, or organization to be successful in implementing change, it is of paramount importance that such disagreements or misunderstandings be resolved constructively rather than destructively. This flow time reduction project generated some such disagreement. Fortunately, the team members worked to achieve understanding and consensus rather than force their ideas upon others. Although these day to day interactions and relationships between the team members are not transcribed in the text of this thesis, they formed the foundation for the entire project.

1.2 Objectives

The objective of the flow time reduction program on Product X at ACME Metal Products was to improve ACME's competitive position in the marketplace by achieving a one-third reduction in flow time. The process mapping and innovation techniques utilized were means to achieving that end.

The objectives of this thesis are three-fold. First, it is intended to document the process mapping and process innovation efforts utilized by the flow time reduction team at ACME to reduce the flow time on Product X and their outcomes. Second, it is intended to evaluate the strengths and weaknesses, successes and failures of the process mapping and innovation techniques as applied to this situation. Finally, it is intended to provide conclusions and recommendations about implementing flow time reduction programs in a general context that may be applicable to other situations.

My personal objective throughout the internship was to gain experience from addressing the product, process, and people issues that come with managing change in the manufacturing firm in an integrated fashion. This internship project provided a unique educational environment from which I was able to learn and grow.

1.3 Results

The end results of this flow time reduction project were mixed. A great number of opportunities for flow time reduction were identified through the process mapping procedure, but few were actually implemented. Of those projects that were implemented, there is no hard data yet to establish the actual flow time reduction achieved. The goal was to reduce the flow time of Product X by one-third, but as of December 1993 the actual reduction was far from this goal.

The process mapping portion of the flow time reduction program stalled at the project implementation phase for a variety of reasons that are discussed in Chapter 4 and Chapter 6. If all the projects identified had been implemented, the approximate reduction

in flow time would have been between 25 and 35%. Although most of these projects have not yet been implemented, their identification was a step in the right direction.

The process innovation portion of the flow time reduction program made significant strides toward the development and characterization of the new heat treatment process, but more research is needed before such a process can be implemented. If the new procedure is ultimately implemented, the expected reduction in flow time (relative to the baseline flow time at the beginning of the internship) will be approximately 10%.

Despite these setbacks, everyone on the flow time reduction team would agree that the flow time reduction project was worthwhile. It left the members of the flow time reduction team at ACME with a much better understanding of both the internal and external manufacturing process for Product X. The relationships developed with the external suppliers through the process mapping sessions may prove helpful in future partnering and negotiation.

The flow time reduction team members learned the techniques of process mapping which can be applied in the future to other segments of ACME's business. The development of the new heat treatment practice furthered ACME's understanding of the existing heat treatment process for Product X, and contributed to their knowledge base on the processing-properties-performance relationships of Product X.

The flow time database (described in Chapter 3), initially established to provide reference data on the past flow times of Product X, was expanded to include processing histories and material properties. This provided ACME with a system for accumulating data on Product X that proved valuable on several occasions for evaluating the effects of input material and processing characteristics on the properties of the finished product. This database should continue to facilitate such analyses in the future.

1.4 Organization of Thesis

This thesis is organized to provide a logical progression through background information, the historical flow time analysis, the process mapping effort, the process innovation effort, and final conclusions and recommendations. Commentary on the strengths and weaknesses, successes and failures of the techniques used in each portion of the project and the impediments that may be encountered are interleaved into the chapters.

Chapter 2 addresses the motivation for pursuing flow time reduction at ACME, introduces various flow time reduction methodologies, develops the concepts of process mapping and process innovation as means of achieving flow time reduction, discusses the general business environment in which ACME competes, and provides an introduction to the manufacturing process for Product X.

Chapter 3 describes the historical flow time analysis conducted to gain an understanding of the major components of the overall flow time, identify any trends or patterns in the data that might provide insight into the process, and establish a flow time benchmark to compare future flow times against.

Chapter 4 introduces the technique of process mapping, describes how it was applied to Product X at ACME, summarizes the opportunities identified, examines some of the projects that were implemented, and discusses the impediments that were encountered in the implementation phase of the process.

Chapter 5 describes the development and characterization of a new heat treatment procedure for Product X through finite element modeling and designed experiments. The feasibility of the process is evaluated and recommendations are made on how to proceed.

Chapter 6 summarizes the net results of the flow time reduction program. The project conclusions and recommendations are generalized so that they may provide insight not only to ACME but to any other firm preparing to engage in a flow time reduction program.

Chapter 2 -- Background Information for Flow Time Reduction Analysis

2.1 Chapter Overview

This chapter presents relevant background information about the flow time reduction program. First, it gives an explanation of the motivation behind pursuing flow time reduction at ACME Metal Products. Second, it offers an introduction to methodologies of flow time reduction, including the process mapping and process innovation techniques that were applied to Product X. Third, it provides background on the business environment and organizational culture at ACME Metal Products. Fourth, it introduces at a high level the manufacturing process for Product X. The key points of this background discussion are summarized at the end of the chapter.

2.2 Motivation for Pursuing Flow Time Reduction

The flow time for a manufacturing process is defined as the total elapsed time between when that process was started and when the final product was shipped to the customer, including all wait and queue time. Flow time is quite different from the touch time, the length of time the product is physically being worked on, moved, tested, etc., or value-added time, the cumulative length of the steps where the product is being transformed or evaluated so as to provide value to the customer. In this analysis, the overall manufacturing flow time will refer to the elapsed time between order placement and delivery of a finished product.

Flow time reduction has become a popular battle cry of manufacturing companies in recent years for a number of reasons. First, flow time reduction decreases capital tied up in inventory by shortening the length of the manufacturing process. Second, flow time reduction increases the responsiveness of the manufacturing firm to new and changing customer needs. Third, flow time reduction lowers scrap rates by decreasing the time to detection. Finally, flow time reduction can increase scheduling and shipment

performance by eliminating unnecessary complexity in the manufacturing process. Overall, the firm which systematically and continuously reduces flow times on their products is likely to maintain a sustainable competitive advantage over less responsive competitors.

In this case, the critical stimulus to pursue flow time reduction was a direct mandate from the Customer². In a high level meeting between ACME Metal Products and the Customer, the Customer stipulated that reduced flow time were a requirement to receive increased orders for Product X. As a result of that meeting, ACME assembled a flow time reduction team whose charter was to cut flow times on Product X by one-third.

2.3 Framework for Pursuing Flow Time Reduction

As has been alluded to previously, the two general categories of flow time reduction are: eliminating inefficiencies in the existing process and changing the physical manufacturing process. For example, improving scheduling of a processing center would eliminate inefficiency in the existing process. Replacing the processing center altogether with a new process would represent a physical change. These two categories are interdependent, as implementing the new process should also eliminate all the inefficiencies of the old one (and hopefully not add new ones of its own).

It is quite common for manufacturing flow times to be over 90% non-value-added time, with most of the 90% being queue time. There are likely to be many incremental efficiency improvements that will add up to a substantial gain. Changes in the physical manufacturing process are more likely to yield step function gains. Pursuing both incremental and step-function improvements simultaneously is the best way to capture the maximum possible flow time reduction.

There are numerous methodologies that have been used in industry to pursue flow time reduction. Although they each tend to emphasize different elements of the

² As of December, 1993, ACME had only one customer for Product X. There are several other potential customers for products that are variations of Product X.

manufacturing process (i.e. scheduling of equipment and employees, performance metrics, analytical modeling, business process reengineering, process mapping, and process innovation), they are not incompatible with one another. One, several, or all of them may be applied simultaneously to a given process or product if resources permit. A number of the most common of these methodologies are summarized below.

Theory of Constraints

In the theory of constraints methodology popularized by Goldratt³, scheduling of material flows through the factory are paced by the bottleneck operation. Work in process inventory levels may be reduced dramatically by subordinating all other manufacturing operations to the bottleneck. Eliminating excess inventory in the system allows new orders to be processed more expeditiously by the system, leading to reduced flow times.

Adapting Work Schedules to Process Flow

In some situations, flow time reductions can be achieved by more closely matching employee work schedules to the natural flow of the manufacturing process. For example, if a series of sequential operations take 5 hours each but the normal workday is only 8 hours, adding 2 hours of overtime or switching some people to a 4 10-hour day workweek would allow two of these operations per day instead of one. Flexible scheduling of break times may allow operators to take their breaks while equipment is running, not in the middle of a setup process. Adding a second shift might be practical for long flow time items. The flow time benefits associated with such work schedule changes would need to be weighed relative to any additional costs that might be incurred.

Performance Metrics

People tend to execute their responsibilities in a such a way as to maximize their performance metrics and rewards. Executives are evaluated based on profit and ROI, while shift supervisors are evaluated based on quantity and quality of output. Asking

³ Goldratt, Eliyahu M. Theory of Constraints. New York, North River Press, 1990.

people to devote part of their effort to reducing flow times when they are evaluated based on other metrics will most likely fail, even if those individuals understand the potential benefits to the organization as a whole. From a high level perspective, designing a performance evaluation system that rewards flow time reduction in the plant can be an effective stimulus towards achieving flow time reduction.

Reengineering of Business Processes

Reengineering, popularized by Hammer⁴, is based on the elimination of operating inefficiencies not only in manufacturing processes but also in design, research and development, engineering, sales, marketing, finance, and executive functions. The cumulative effect of such efficiency increases across all business processes reduces both overall costs and flow times associated with manufacturing products, bringing new products to market, responding to customer needs, transferring information within the company, etc.

Analytical Models

Construction of analytical models to simulate production systems can be very useful in predicting the results of different operating strategies or dealing with uncertainty in processing times or process outputs. For example, queuing theory was developed to address issues associated with variations in equipment utilization rates, processing times, and arrival intervals. In applying the results of such models, care must be taken to interpret the results in the context of assumptions, error, and uncertainty that is built into the model.

Process Mapping

Process mapping is a means of identifying the inefficiencies in an existing manufacturing process. The basic idea is to have a team of people associated with a given product document its flow path in great detail and as a group look for opportunities

⁴ Hammer, Michael R. Reengineering the Corporation. New York, Harper Business, 1993.

for improvement. This team-based technique can bring to light numerous opportunities for flow time reduction that would otherwise go unnoticed.

Process Innovation

Process innovation refers to the pursuit of changes in the physical manufacturing process that may lead to step function improvements in flow time. Although the details of a process innovation effort tend to be very process and product specific, the general keys to making it work are to dedicate the necessary people and dollar resources to the project and to create a working environment that does not penalize risk taking.

The flow time reduction team for Product X at ACME focused on applying the techniques of process mapping and process innovation, although elements of the others were sometimes utilized. The procedure for process mapping and details of its application to the manufacturing process for Product X are described in Chapter 4. Process innovation was applied to Product X through the development and characterization of a new heat treatment process as a potential replacement for the existing process. Details of this process innovation effort are discussed in Chapter 5.

2.4 Business Environment at ACME Metal Products

ACME Metal Products competes in the large metal fabrication industry. In this industry's past, the power in the supplier-customer relationship resided with the suppliers. Orders exceeded industry capacity, so customers had little leverage on price or lead times. Today the situation is reversed. Industry capacity exceeds orders, so customers can play one supplier against another to get the best possible deal. As margins have been squeezed over the last several years, many of ACME's competitors have been forced out of business. To this point, ACME has benefited from this industry contraction by capturing a larger share of a shrinking pie.

ACME's plant is best characterized as a low volume job shop where inventory levels are high and inventory turns are low. Material release in the plant is driven by an outdated MRP system that assumes infinite capacity and no rework. Day to day scheduling is controlled by a "critical ratio" defined as: (number of processing days remaining) / (number of days until shipping due date). Unfortunately, the processing time standards presuppose a large amount of queue time, leading to the self-fulfilling prophecy of long lead times and high inventory levels. ACME is currently attempting to resolve these issues by rationalizing and reengineering the manufacturing operations in the plant.

As with much of the heavy industry in the U.S., the internal culture change required to drive such resolution has lagged behind the competitive changes in the marketplace. Changing a company's culture is not as easy as reading a book, hiring a consultant, or implementing the latest management fad. Many fear that change will make them obsolete, and for some it will. It takes a great deal of confidence, courage, and patience on the part of all the individuals who make up the organization to put themselves through such a tumultuous process. Although they aren't there yet, ACME has recognized the need for cultural change and is making strides toward establishing the new culture.

2.5 Introduction to the Manufacturing Process for Product X

This section is intended to provide an introductory description of the manufacturing process. A more detailed description of the manufacturing process constructed for use in the flow time reduction effort is discussed in Chapter 4. Due to the proprietary nature of the manufacturing process for Product X, it can only be discussed in general terms.

There are four phases to the manufacturing process for Product X. Typically the Customer places orders for Product X a year at a time with different delivery dates for

individual units. When the time is right to begin in order to meet a specific ship date, ACME orders a metal ingot from one of the ingot suppliers. Due to the specialized nature of the alloy, the ingot suppliers manufacture the metal to order instead of stocking it. The manufacturing lead time for the metal is a significant component of the overall flow time. The second phase is in-house fabrication work. Several distinct geometry transformations occur during this phase. In the third phase of the manufacturing process, the product is shipped to external suppliers for machining and heat treatment. ACME does not currently have internal facilities suitable for these processes. In the fourth and final phase, the product is shipped to an external ultrasonic inspection facility, and then back to ACME for certification. Upon approval of the certification documentation by the Customer, the product is usually shipped within 48 hours. The components of this high level description of the manufacturing process are illustrated in Figure 2.5.1.

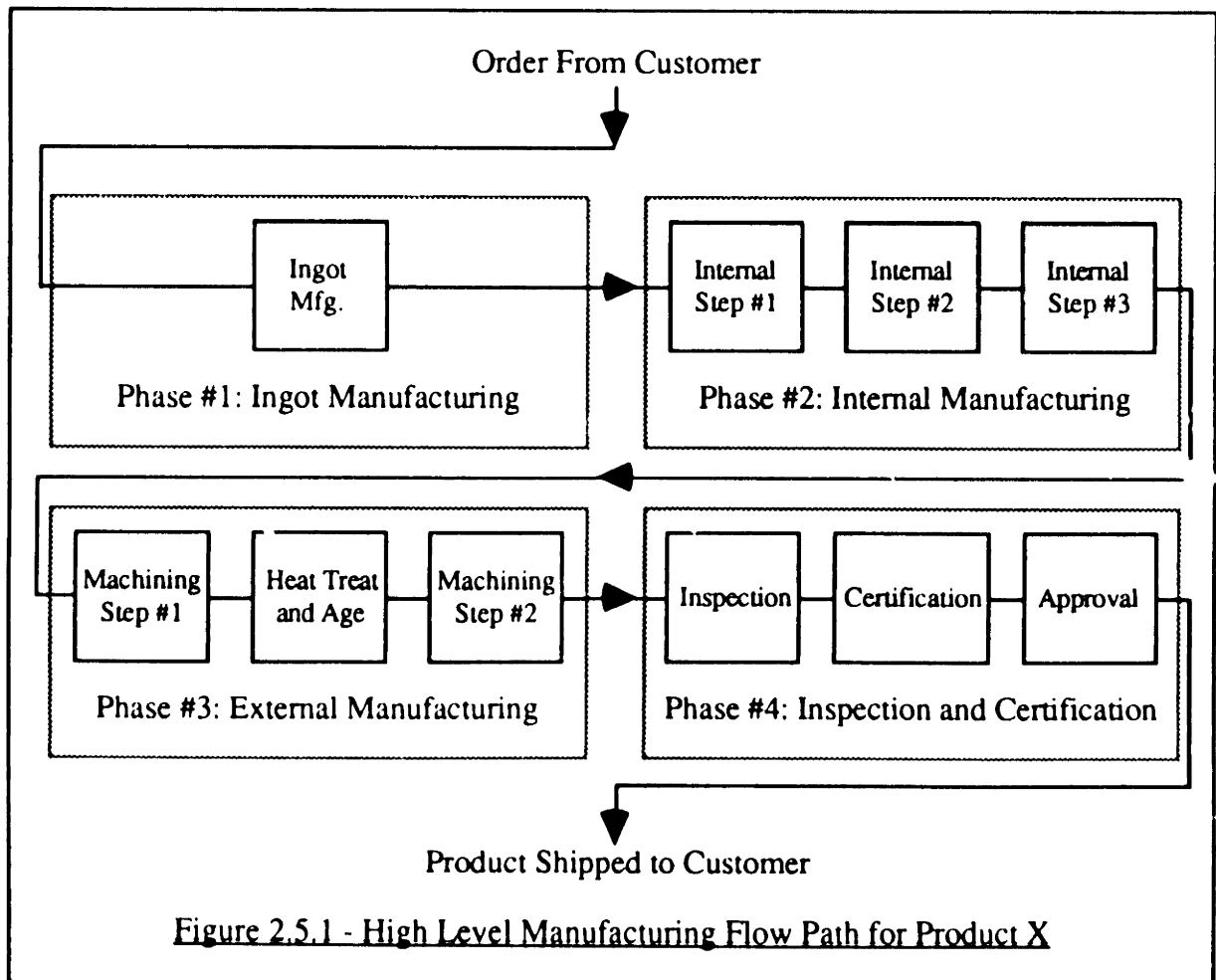

2.6 Chapter 2 Summary

Flow time reduction is aimed at reducing capital tied up in inventory, increasing company responsiveness to customer needs, lowering defect detection times, and increasing production efficiency. The flow time reduction effort on Product X at ACME was initiated by the Customer, who stipulated that reduced flow times were a requirement for increased business.

Flow time reduction may be pursued by eliminating inefficiencies in the existing process or radically changing the physical manufacturing process. A variety of methodologies are commonly used to achieve flow time reduction. In the case of the flow time reduction effort on Product X, process mapping was used to address inefficiencies in the existing process, while process innovation was used to develop a new heat treatment process.

Overcapacity in the large metal fabrication industry has transferred the power in the supplier-customer relationship from companies such as ACME to their customers. The cultural transformation involved in adapting to a customer focus has lagged behind the changes in market conditions, but is now being addressed.

The manufacturing process for Product X consists of four phases: ingot manufacturing, internal manufacturing, external machining and heat treatment, and inspection / certification. A more in depth description may be found in Chapters 3 and 4.

Chapter 3 -- Historical Flow Time Analysis

3.1 Chapter Overview

As a starting point for the flow time reduction project, a spreadsheet database of historical flow times was constructed to answer three questions. First, what were the historical flow times for the major steps in the manufacturing process? Second, were there any trends in Product X flow times over the four years that ACME had manufactured Product X for the Customer? Third, could any conclusions be drawn from the historical flow times that would help the flow time reduction team direct their efforts?

Prior to this historical flow time analysis, it had been assumed that flow times for Product X were around 73 days and had been improving. The analysis, however, indicated that: 1. The historical average flow time was roughly 100 days, 2. There was tremendous variation between flow times for different units, and 3. Flow times were not significantly improving nor worsening. This chapter details the procedure used for assembling the historical flow time database, summarizes the contents of the database, and makes observations and conclusions based on that data.

3.2 Assembling the Flow Time Database

As of June 1993, the cumulative number of units of Product X manufactured by ACME was less than 100, all of which had been manufactured in the past four years. The recent time frame of Product X meant that most production records would still be accessible and the low volume indicated that it would be possible to examine on a unit by unit basis the flow time history of every unit manufactured. Based on this reasoning, a database was constructed to calculate and compare flow times of major operations for every unit of Product X ever manufactured.

Gathering the data proved much more difficult than initially expected. The internal production tracking system records were incomplete, the data they contained

were often inaccurate, and it was not very user friendly. Records of production milestones at outside suppliers were incomplete on production during first two years. Several other data sources paralleled this patchwork picture of flow times for Product X. By cross-referencing the multiple sources, however, enough data was gathered to calculate flow times for more than 90% of the total units between any two operations. This data proved more than enough to paint a descriptive picture of the historical flow times of Product X.

3.3 Summary Characteristics of Historical Flow Time Data

Table 3.3.1 summarizes the key flow time characteristics (average, median, standard deviation, minimum, and maximum) of the manufacturing process for Product X by phase and segment as described in Section 2.5⁵. Flow times for individual segments are calculated from the time of completion of the previous step to the time of completion of the current step. Table 3.3.2 summarizes the median and range of flow times for each process segment sorted by year of completion of that segment. All available data as of December, 1993 were used in these calculations.

Figure 3.3.1 illustrates average manufacturing flow times by process segment and phase. Figure 3.3.2 illustrates the magnitude of the variations about the average flow time for each process segment.

⁵ The data in Tables 1 and 2 have been scaled in order to yield an average overall flow time of 100 days. The proportional relationships between the data have been maintained.

Phase / Segment	Process Description	Ave	Med	Stdv	Min	Max
1 / 1	Ingot Manufacturing ⁶	~29	~29	-	~20	~39
2 / 2	Internal Fabrication Step #1	11	6	14	2	68
2 / 3	Internal Fabrication Step #2	9	8	5	2	17
2 / 4	Internal Fabrication Step #3	7	6	3	2	16
3 / 5	Machining Step #1	6	6	2	3	16
3 / 6	Heat Treatment and Age	8	7	4	2	26
3 / 7	Machining Step #2	6	5	4	2	24
4 / 8	Ultrasonic Inspection	9	7	7	1	32
4 / 9	Certification	11	8	9	1	36
4 / 10	Approval ⁷	4	3	5	0	34
All	Ingot Manufacturing to Approval ⁸	100	100	46	66	137

Table 3.3.1 - Historical Flow Times by Process Segment for Product X

Phase / Segment	Process Description	1991	1992	1993
1 / 1	Ingot Manufacturing	~29 (20-39)	~29 (20-39)	~29 (20-39)
2 / 2	Internal Fabrication Step #1	5 (2-49)	5 (2-21)	11 (2-68)
2 / 3	Internal Fabrication Step #2	5 (2-14)	13 (6-17)	7 (7-7)
2 / 4	Internal Fabrication Step #3	5 (2-16)	6 (3-16)	6 (6-10)
3 / 5	Machining Step #1	5 (3-9)	7 (5-16)	5 (4-7)
3 / 6	Heat Treatment and Age	6 (4-9)	7 (5-26)	8 (2-12)
3 / 7	Machining Step #2	6 (2-22)	5 (3-10)	5 (2-24)
4 / 8	Ultrasonic Inspection	14 (10-24)	8 (2-33)	3 (1-11)
4 / 9	Certification	5 (1-15)	8 (1-31)	7 (5-36)
4 / 10	Approval	0 (0-0)	3 (0-34)	2 (0-9)
All	Ingot Manufacturing to Approval	81 (66-86)	110 (90-137)	85 (80-115)

Table 3.3.2 - Comparison of Flow Times Versus Year Process Completed
- Median (Range)

⁶ Due to the lack of data available on ingot manufacturing flow times, the average, median, minimum, and maximum flow times are based on the best estimates of the flow time reduction team. For the purposes of calculating the overall flow time characteristics, it was assumed that all ingot manufacturing times were equal to the average ingot manufacturing time and the standard deviation of the ingot manufacturing flow times was 0.

⁷ Certification through approval flow times for some pieces produced in 1991 were not meaningful since units were approved prior to certification, and as a result have not been used in calculating these figures.

⁸ These overall flow time characteristics are based on individual units of product. They are not sums of the flow time characteristics from the individual process segments.

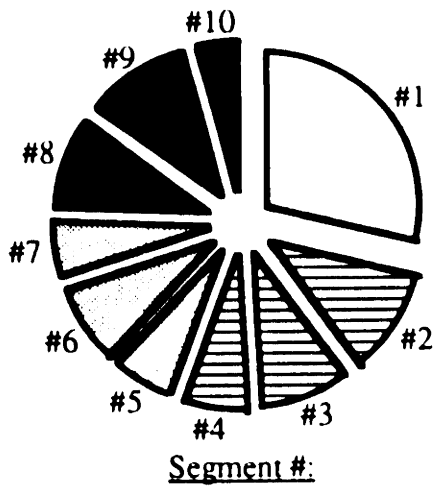

Segment #: Process - Flow Time

#1: Ingot Manufacturing - 29 days

#2: Internal Step #1 - 11 days

#3: Internal Step #2 - 9 days

#4: Internal Step #3 - 7 days

#5: Machining Step #1 - 6 days

#6: Heat Treat / Age - 8 days

#7: Machining Step #2 - 6 days

#8: Ultrasonic Inspection - 9 days

#9: Certification - 11 days

#10: Approval to Ship - 4 days

Total (#1-#10): 100 days

Phase #1: Ingot Manufacturing - 29 days

Phase #2: Internal Fabrication - 27 days

Phase #3: External Fabrication - 20 days

Phase #4: Inspection / Certification - 24 days

Figure 3.3.1 - Average Flow Time Breakdown by Process Segment and Phase

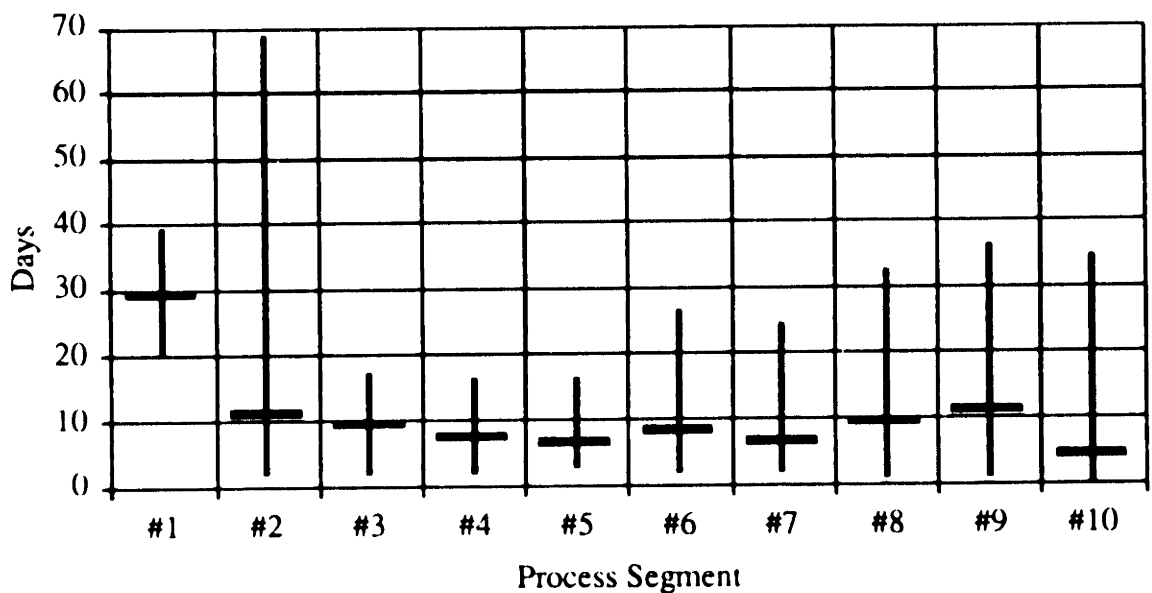

Figure 3.3.2 - Minimum-Average-Maximum Flow Times by Process Segment

3.4 Interpretation of Data

3.4.1 Benchmark Flow Times

The first goal of the flow time database was to establish the actual flow times for the individual phases and segments of the manufacturing process. As can be seen in Table 3.3.1 and Figure 3.3.1, the four phases of the manufacturing flow path (ingot manufacturing - 29 days, internal fabrication - 27 days, external fabrication - 20 days, and inspection / certification - 24 days) each accounted for roughly one quarter of the average overall flow time of 100 days. The flow times for the individual process segments ranged from 4 days for approval to ship to 29 days for ingot manufacturing. The average overall flow time for Product X over the history of the program was 100 days. This was much longer than the 73 days that was assumed prior to construction of the database.

The average and median flow times are only half the story, however. As can be seen in Table 3.3.2 and Figure 3.3.2, the variation in flow times for all segments has been substantial. In some segments, particularly Internal Fabrication Step #1 and Certification, the maximum flow time was 5 to 6 times the average. Unfortunately, examining this data years after the fact does not yield a causal analysis of the observed variations. Some of the likely causes (observed on current production during my internship at ACME) were:

- Changes in the Customer's due date in the middle of the manufacturing process.
- Scheduling conflicts, expediting.
- Queue times
- Equipment breakdowns.
- Production holds due to development of process modifications.
- Production holds waiting for Customer approval of process modifications.
- Production holds waiting for Customer specification changes.

3.4.2 Trend Analysis

The second purpose of the flow time database was to determine if any trends were present in flow times over the past three years. Due to the tremendous variation in flow times for most segments and the few number of data points for others, a rigorous statistical analysis is not practical. For example, if there had been a real 20% reduction (from 5 days to 4 days) in the average flow time for External Machining Step #2 from 1992 to 1993, the observable effect of that reduction would be totally obscured by the sources of variation that have caused it to take as little as 2 and as many as 24 days in 1993. The ranges of flow times for individual segments in some cases lengthened and in some cases shortened, but that alone was not enough to determine if the old causes of variation had been eliminated or if new causes of variation were active.

With these variation considerations in mind, consider the mean time to completion observed in 1991, 1992, and 1993. The mean time to completion for units of Product X shipped in 1991 was 81 days. To interpret this number correctly, however, it must be known that in 1991 the Customer was requesting delivery of units already started ahead of the original schedule. Units of Product X were expedited through some segments of the manufacturing process. The flow times observed in 1991 were not indicative of a standard procedure (as they are meant to reflect) but rather of an atypical, expedited version. If it had not been for the heavy push by the Customer to expedite the units through, the observed flow times would almost certainly have been longer.

In 1992, the median overall flow time was 110 days. Customer requirements for Product X dropped off somewhat in 1992, resulting in delivery dates to the Customer on some units being pushed out after production had begun. These units did end up lingering in the system longer, but probably not because of a substantive change in manufacturing flow time.

In 1993, the median overall flow time dropped to 85 days. This observed reduction was not due to the flow time reduction program, as the first of these changes

were being implemented only at the very end of the year. Orders were not being pulled by the Customer as in 1991, either. It seems most likely that the observed decrease in overall flow times in 1993 was primarily the result of favorable variations, not a real reduction.

Delivery performance from 1991 to 1993 with respect to the Customer's final due date was, qualitatively speaking, very good. If due dates were pulled in, units were expedited through remaining operations to meet the new due date if at all possible. If due dates were pushed out, units were held at their current stage of production until their critical ratio (as defined in Section 2.4) returned to a value of 1. When due dates were missed, it was most likely because the due date had been pulled in by an unrealistic amount or because a unit of Product X had been scrapped midway through the process for quality reasons and started over. Since flow time reduction was not a priority, planned flow times were almost certainly longer than they needed to be to allow for variation, leading to the self-fulfilling prophecy of longer observed flow times. This due date driven variation, coupled with variation from other sources, confounds the flow time database making it difficult to extract conclusions much other than how long flow times were historically.

Overall, the search for significant trends in flow times turned out to be indeterminate because of unpredictable variations. The persistence of these variations, whatever the causes were, brings to light the importance of making the overall production process more robust to those that can be controlled. Until these causes are identified and addressed, it will be difficult to gauge the impact of other changes in the manufacturing process and flow path.

3.4.3 Database Conclusions

As the analysis was based on historical observations without reference to cause, these conclusions are mostly diagnostic indicators. Understanding the why behind them

was reserved for the process mapping and innovation efforts, where the team became immersed in the details of the actual manufacturing process.

The flow time database provided the flow time reduction program with a set of benchmark flow time characteristics to compare the subsequent results of the flow time reduction program to. It had been assumed that overall flow times were around 73 days and improving. The analysis, however, indicated that the historical average was 100 days and that there wasn't a significant reduction trend underway.

The minimum actual flow time achieved to date in actual manufacturing of Product X is 66 days. Adding the minimum flow times for each process segment (assuming an ingot manufacturing time of 20 days) yields an additional flow time benchmark of 35 days. This theoretical 35 day flow time should actually be considered as an upper bound on the minimum theoretical flow time, as even in the best execution of the existing process there is likely to be room for improvement. These benchmarks supported the initial assumption that there was much room for improvement on Product X.

Furthermore, the database pointed out the need to identify and address the sources of variability in flow times. As was illustrated in Table 3.3.1, overall flow times have varied by more than a factor of two. Individual process segments have varied by much more. As the Customer's confidence level in ACME to be able to deliver Product X by a specific date is controlled not only by the average flow time but also the maximum flow time observed, it is important to get this variation under control.

3.5 Flow Time Database Revisited

The flow time database described above provided the first factual evaluation of historical flow times on Product X. Furthermore, it catalyzed the development of a more extensive database for Product X. The final database contained complete information on processing dates, flow times, processing variables, and material properties. On several

occasions the complete database was used as a tool in investigating the relationships between processing variables and material properties in the finished product. In one case the database was used to see if a correlation existed between ultrasonic noise and grain size in the metal. Another time it was used to examine the relationship between metal chemistry and strength / toughness in the finished product. As the database is updated in the future, it should continue to be a helpful tool in evaluating the results of both flow time reduction efforts and product quality improvement initiatives.

3.6 Chapter 3 Summary

A spreadsheet database of historical flow time data for Product X was assembled to determine what were the historical flow times for the major steps in the manufacturing process, if there were any trends evident in that data, and if any of these observations could be used to guide the subsequent process mapping and innovation effort. Analysis of the database yielded the following results:

- Average historical flow times were 100 days (much longer than the existing assumption of 73 days.)
- Huge variations in flow times were present in every segment of the overall manufacturing process.
- No significant trends were observed. If any trends were present in reality, there effect has been dwarfed by variations in the process.

These results provided a comparison benchmark for the process mapping and innovation effort, and identified the need to address variation in the process. Additionally, the flow time database was later expanded to include processing variables and material properties. The expanded database provided ACME with a useful tool for evaluating the relationships between processing variables and material performance, as well as tracking the future results of the flow time reduction initiative.

Chapter 4 -- Flow Time Reduction Through Process Mapping

4.1 Chapter Overview

This chapter begins by describing the process mapping procedure and demonstrating its application using a hypothetical example. Second, the results of the application of the process mapping procedure to Product X are presented and analyzed. Finally, the impediments to actual implementation of the projects identified during the process mapping procedure are discussed.

4.2 The Process Mapping Procedure

Process mapping is a technique of documenting and analyzing the manufacturing process for a given product. The key parameter here is that the real manufacturing process, not an idealized version of it, be considered. The real manufacturing process may be visualized by placing yourself in the shoes of the product and considering everywhere you must go and everything you must do to be transformed from an order to a finished product. Every value-added, non-value-added, and queue component of the process should be included in the process map using the coding system in Figure 4.2.1.

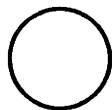

Value-added process. The product is being transformed or evaluated so as to provide value to the customer.

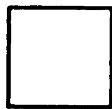

Non-value-added process. Typically the product is being moved, processing equipment is being set-up or cleaned, etc.



Queue time. The product is waiting for the next processing resource to become available.

Figure 4.2.1 - Coding System for Process Maps

To illustrate the procedure for constructing the process map, consider the following hypothetical manufacturing process for making a widget. A first step in constructing the process map for the widget might be the process engineer's office. Through the eyes of the process engineer, the process map for widget manufacturing might look like Figure 4.2.2.

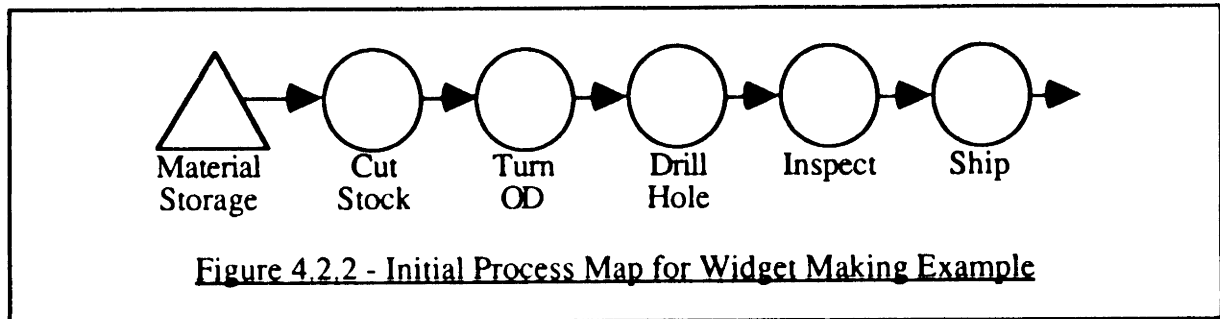

Figure 4.2.2 - Initial Process Map for Widget Making Example

This initial process map is a good starting point, but it is by no means complete. Each of the operations described in Figure 4.2.2 consist of multiple steps and have their own process maps. If, for example, we were to consult with a lathe operator on the floor about the "Turn OD" step, we might find the sub-process map illustrated in Figure 4.2.3.

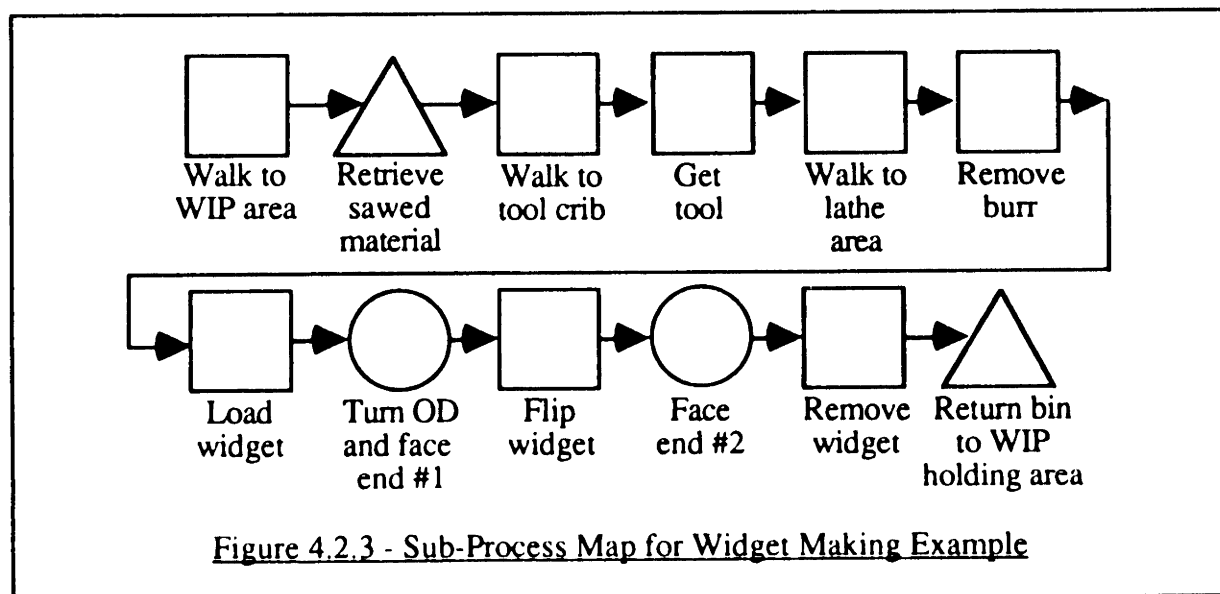

Figure 4.2.3 - Sub-Process Map for Widget Making Example

As can be seen in this sub-process map, the number and cumulative time of non-value added and queue steps is typically large relative to the number of value added steps. It is important to note that process maps do not account for unanticipated disturbances or interruptions to the normal product flow which may add additional queue time to the manufacturing process. It is not at all uncommon to find the total value added time in a manufacturing process to be less than 10% of the overall flow time.

The process map should be assembled to the requisite level of detail by a few members of the flow time reduction team in preparation for review by the entire team. The requisite level of detail is something of a judgment call, for each step in a process map can always be subdivided into a series of steps. The level of detail should be enough to thoroughly reflect the value added, non-value added, and queue time components of the manufacturing flow path.

Once the process map has been completed, the flow time reduction team should be assembled to review it. The team will be most productive when it is cross-functional, including operators from the floor, process engineers, materials managers, operations managers, product management, etc. If the flow time reduction effort is being executed to satisfy the needs of a particular customer or product, it may be useful to have customer representatives participate in the process. In some cases joint sessions between customers and suppliers may not be feasible, as most manufacturing companies regard their processes as proprietary and a source of competitive advantage.

The team then walks step by step through the process. In some cases, this happens literally as team members walk through the plant tracing the path of the product. It is the responsibility of all team members to ask questions of other team members as to why specific process steps may be necessary or to suggest improvements. Ideally the team will represent a critical mass of knowledge and authority with respect to how the product is manufactured and what can be changed within the context of the overall plant operations. It is very important in this phase of the process for team members to give full

consideration to even the most improbable suggestions. In the end, discussion of unlikely, infeasible, or radically new approaches may stimulate other ideas which are within the realm of possibility.

Once the team has completed the flow path review process, the projects identified are assigned a priority code according to potential flow time reduction and resource requirements for implementation. The format for project classification is summarized in Table 4.2.1.

Project Priority	Flow Time Reduction	Resource Requirements
I	High	Low
II	High	High
III	Low	Low
IV	Low	High

Table 4.2.1 - Prioritization Matrix for Flow Time Reduction Projects

Following the prioritization procedure, the projects are delegated to the team member or members who are best suited to act as project champion and oversee its implementation. Since time and dollar resources are limited, the expectation is that projects will be implemented in order of priority. Finally, the flow time reduction team should agree on a preliminary timetable for completion of the assigned projects and schedule a follow-up session.

4.3 Results of Process Mapping Procedure on Product X

The process mapping procedure was initially applied to Product X through a joint session between ACME and the Customer, and subsequently in sessions between ACME and each of the external suppliers. A great number of opportunities for flow time reduction were identified through these sessions. Due to the proprietary nature of the manufacturing process for Product X, specific descriptions of most of these projects cannot be disclosed. An additional benefit of the process was that all team members gained an increased understanding of the overall manufacturing process.

Figure 4.3.1 is typical of the process maps constructed for Product X, in this case being the result of a session between ACME and Ingot Manufacturer A. A total of 14 projects were identified in this session, with the potential for up to an 8-10 day flow time reduction. Table 4.3.1 summarizes the results of each of these process mapping sessions by number and priority of projects identified, and the potential flow time reduction associated with their implementation. Two representative projects are then described as illustrations of the types of projects that were identified.

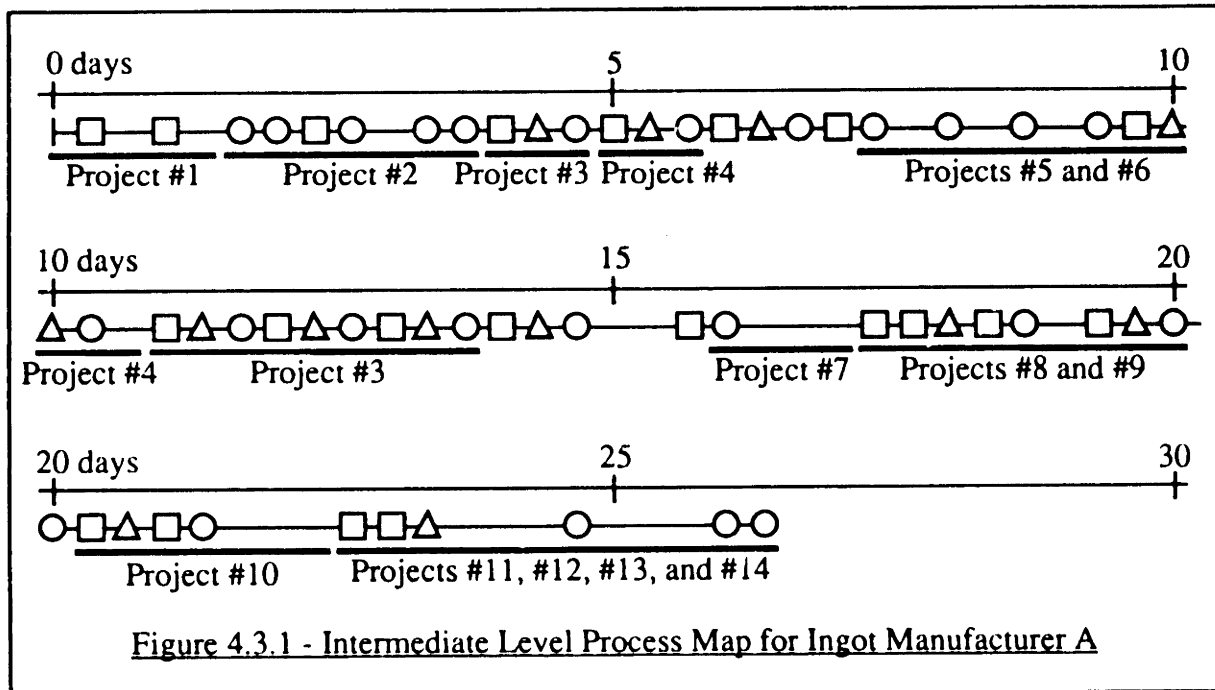

Process Mapping of:	Number of Projects Identified (Priority)				Current Average Flow Time	Potential Flow Time Reduction
	I	II	III	IV		
Ingot Manufacturer A	3	5	6	0	29 days	8-10 days
Ingot Manufacturer B	2	5	6	0	29 days	8-10 days
Internal Fabrication	3	0	1	0	27 days	8-10 days
Machine Shop A	1	2	1	0	12 days	3-4 days
Machine Shop B	1	1	2	0	12 days	3-4 days
Heat Treat / Age Shop A	0	1	6	0	8 days	2-3 days
Heat Treat / Age Shop B	0	2	10	0	8 days	2-3 days
Inspection / Certification	0	3	3	0	24 days	6-8 days
Total	10	19	35	0	100 days	27-35 days

Table 4.3.1 - Summary of Projects Identified Through Process Mapping Procedure

To further illustrate the results of the process mapping procedure, consider the following two examples of the projects identified:

- Grind sharp edges on ingot at ingot suppliers. Historically, the first step in the internal manufacturing process was to grind off the sharp edges on the ingot where it was cut by the ingot manufacturer. For this non-value added operation to take place, the ingot had to wait through grinding area queues as well as be ground, resulting in a significant addition of flow time to the overall process. During the process mapping sessions at the ingot suppliers, team members realized that the ingot suppliers had better facilities to handle the grinding process and could do it significantly faster. Because this opportunity could give a modest flow time reduction for minimal effort, it was assigned a priority code of III.
- Prepare metallurgical test specimens at machine shops. Historically, test material was removed from units of Product X in the second machining step, shipped to ACME to be cut into test specimens, and finally shipped to the testing lab. When the flow time reduction team reviewed this part of the process with the machine shops, they asked if there was any reason why they couldn't prepare the test specimens and ship them straight to the testing lab. The answer was no, and although the project sounds obvious, it was not until the flow time reduction team worked through the process mapping procedure with the machine shops that it came to light. The fact of the matter was that by making this change, ACME could save both flow time and money. This project was categorized as priority I.

Overall, a total of 64 projects were identified through the application of the process mapping procedure to the internal and external manufacturing process of Product X. If all these projects are ultimately implemented, the approximate cumulative flow time reduction will be between 27 and 35 days. Section 4.4 below discusses the most common project themes, while Section 4.5 discusses some of the reasons why most of these projects haven't yet been implemented.

4.4 Discussion of Process Mapping Results

The majority of the projects identified through the process mapping procedure involve one of the following four themes: improved scheduling, improved communication, elimination of non-value added steps, and facilities enhancement. These themes are discussed in the paragraphs below.

Given that the historical flow time analysis indicated the theoretical minimum flow time (assuming no changes to the physical manufacturing process) was actually less than 35 days, it is not surprising that improved scheduling was a common theme among the projects. Improving the scheduling for an entire plant or a specific production center is not a minor project however. Scheduling shouldn't be optimized for one product at the expense of others (also known as expediting). It requires a comprehensive review of capacity, utilization, bottlenecks, material flow, forecast production, and a host of other factors for the whole system. As is discussed in Section 4.5, trying to persuade ACME's external suppliers to engage in such change was not an easy task.

Improved communication between and within the process segments was another common theme, particularly in the later phases of the operation where the unit is frequently being moved between facilities (i.e. ACME to machine shop, machine shop to heat treat, etc.). Some of these projects involved changes as simple as making sure the unit was shipped to the correct loading dock and advising future operations of estimated deliver dates to their facilities (also related to scheduling). As simple as they may seem, these are typical of the opportunities that the process mapping procedure can identify that would otherwise go unnoticed.

Several projects were identified based on eliminating non-value added steps. Most of these involved eliminating inspection and testing procedures that were either redundant or no longer required. Again, many of these opportunities would have gone unnoticed if the flow time reduction team had not walked step by step through the process.

Opportunities for flow time reduction through facilities enhancement and improved material handling capability were also identified. These opportunities were typically based on minor improvements to existing facilities that individuals already knew could help but never had the time or approval to work on them.

Overall, the process mapping procedure proved quite useful in facilitating the identification of flow time reduction opportunities. The technique is both powerful and simple, rendering it a valuable tool in any manufacturing environment.

4.5 Barriers to Implementation of Flow Time Reduction Projects

Even though there is general agreement in industry on the benefits that can be achieved through flow time reduction and the existence of the process mapping procedure as a means to identify such opportunities, there are still many barriers to successful implementation. Talking about process and procedural changes on paper is much easier than going out on the floor and implementing change in an environment that may resist that change. The barriers described below are among those that were encountered during the flow time reduction project on Product X at ACME.

Which Benefits Are Most Important to the Customer?

ACME initiated the flow time reduction program on Product X to improve their competitive position in the eyes of the Customer and capture more business in the future. The Customer's own ordering behavior, however, conflicted with their demand for flow time reduction. The Customer preferred to place orders for a year at a time. Why then was the Customer so concerned about flow times of 100 days when they were placing orders with delivery dates much further out than that? At most, ACME's flow time for Product X would only come into play in determining delivery capability on perhaps the first few pieces.

The key benefit to the Customer turned out to be cost instead of flow time. After the process mapping sessions had been conducted and ACME and its suppliers were

preparing for the implementation phase, the Customer requested a price reduction for Product X. Their justification in asking for the price reduction was that ACME had now identified numerous flow time reduction projects that when implemented would reduce cost. After further negotiation, ACME agreed to part of the Customer's price reduction demands. The Customer, who had initially mandated the flow time reduction program on Product X, subsequently lost interest in flow times.

If the Customer's sole motivation from the outset was to achieve a price reduction, then everyone would have been better served if this had been laid on the table up-front. When the flow time reduction team at ACME came to this realization so far into the flow time reduction project, there was general frustration that so much effort had been invested only to learn that it was mostly a negotiating tool for the Customer. The flow time reduction team was satisfied with their accomplishments to this point, but the loss of the original purpose from the Customer slowed all subsequent implementation of flow time reduction projects.

Level of Internal Commitment

Given the situation described above, it is obvious that the level of internal commitment to seeing the project through to completion is also critical to successful implementation of flow time reduction projects. In this case, the Customer's flow time reduction demands were used as substitute for a true internal commitment to the flow time reduction procedure: "We're doing it because the Customer wants us to." This is not to question the individual commitment of the flow time reduction team members at ACME towards wanting to do the right thing. Rather, when the Customer's level of support for the project dropped precipitously, there was no internal champion of the cause to continue to drive the projects to completion, especially the projects where a significant time and money investment was required to realize the flow time reduction.

How Repeatable is the Process?

Identifying and implementing flow time reduction projects would be easiest if the real manufacturing process were always identical. The process mapping procedure would have accounted for all flow path events, and no unexpected disturbances would ever be encountered. In reality, however, no two units of product ever see the exact same path from order receipt to finished product shipment. This is especially true of low volume, job shop production of a complicated product like Product X.

The Customer was consistently raising the quality specifications for Product X. As a result, the physical manufacturing process for Product X was routinely being adjusted to yield a higher quality product that would meet or exceed the new specifications. Production would be put on hold until such changes were finalized and approved by the Customer. A technical or engineering staff member with special instructions would need to be present during that stage of the manufacturing process to educate the production people about the new process. Such flow time variations due to technical holds were encountered on almost every unit.

Furthermore, other unpredictable delays (scheduling conflicts, equipment breakdowns, etc.) wreaked havoc with attempts to firmly schedule subsequent processes. This often resulted in the self-fulfilling prophecy that production couldn't be firmly scheduled due to variation, but the variation couldn't be eliminated because production wasn't being firmly scheduled. Implementing flow time reduction in such a dynamic, unpredictable environment is obviously very difficult.

How Much Leverage Do You Have on External Suppliers?

As was the case with Product X, achieving significant overall flow time reductions on a product where much of that flow time occurs at external suppliers hinges upon the firm's leverage to influence the actions of those external suppliers. Even with the best intentions and logical explanations of the benefits of flow time reduction, there will be those suppliers who decline to participate any more than they are forced to. If

your product is responsible for only a small fraction of their revenues and they know that you don't have many alternatives, it is highly unlikely that they will restructure their operations solely because of your request. This situation was encountered between ACME, the ingot manufacturers, and the heat treat shops.

4.6 Chapter 4 Summary

The process mapping procedure for analyzing a manufacturing flow path and identifying opportunities for flow time reduction was presented in detail. Application of this procedure to the manufacturing process for Product X yielded a total of 64 flow time reduction projects with the potential to reduce overall flow time by 25 to 35%. Most of these projects were based on improved scheduling, improved communication, elimination of non-value added steps, and facilities enhancement. In general, the project identification portion of the process was executed quite successfully.

Implementing the flow time reduction projects identified through the flow time reduction procedure proved a much more difficult task. The Customer withdrew their support midway into the project, there was no internal champion of flow time reduction prepared to and with the ability to drive the project forward after the Customer withdrew support, the manufacturing process was not entirely stable, and ACME didn't have much leverage with some of the external suppliers to persuade them to participate wholeheartedly. Because of these reasons, only a handful of the projects had actually been implemented by the end of the internship. Future flow time reduction programs should invest the time up front to assess the barriers that may be encountered, and plan strategies for overcoming them.

Chapter 5 -- Flow Time Reduction Through Process Innovation

5.1 Chapter Overview

The second approach taken to reduce flow time on Product X was the consideration of a physical process innovation that would yield a step function decrease in flow times when implemented. Specifically, this chapter describes the development and characterization of a heat treatment process for Product X known as direct solution and age (DSA). In order to protect the proprietary interests of ACME, numerical data on the geometry, material properties, and analysis results have been disguised. The proportional and causal relationships between these elements, however, have been preserved.

The chapter is divided into six sections. The first section describes the principles behind the DSA process, the flow time and quality expected to result from its implementation, and the issues associated with developing the process. The second section covers the application of finite element analysis and experimental quenching to model the cooling rate behavior of Product X in various quenching mediums. The third section describes the procedure and results of a 2^3 full-factorial designed experiment conducted to assess the relative importance of several key process variables. The fourth section describes an experiment conducted to determine the minimum acceptable cooling rate during the quenching phase of the DSA process. The fifth section evaluates the results of the DSA development effort and provides recommendations on future steps. The key points of the chapter are summarized in the final section.

5.2 Introduction to the Direct Solution and Age (DSA) Process

Product X undergoes a common metallurgical transformation during the heat treatment procedure known as precipitation hardening. The goal of this process is to optimize the strength and toughness properties of the finished product.

The precipitation hardening heat treatment procedure consists of three steps. First, the product is heated to an elevated temperature at which the hardening elements enter into a solid solution with the bulk material. Second, the material is rapidly quenched to "freeze" the hardening elements in the solid solution and keep them from precipitating out prematurely. If the quenching rate is too slow, undesirable phases of the hardening elements and bulk material may precipitate out and deteriorate material properties. Finally, the material is heated to an "aging" temperature below the initial solutioning temperature. At the aging temperature, the reaction kinetics are such that the hardening elements can precipitate out into a uniform dispersion of fine precipitates in a controlled manner. Product X currently has a heat treatment process that has been specifically tailored to the material, but following the general steps of precipitation hardening processes described above.

The current heat treatment process for Product X has two undesirable drawbacks. First, the process cannot be performed in-house due to facility limitations. The necessity of going to an external heat treat supplier substantially increases overall flow times. Second, all the while the material is at elevated temperatures the metal grains are increasing in size, leading to reduced material performance. It takes many hours for the part to cool after Internal Fabrication Step #3, and many hours to heat up to temperature for the solutioning operation. Ideally, the solutioning process would immediately follow Internal Fabrication Step #3. This process is known as direct solution and age (DSA).

The DSA process has been used to yield fine grained structures and superior material properties in smaller components for years. ACME has not previously implemented a DSA process on Product X, however, for several reasons. First, the process requirements for applying DSA to Product X were unknown. Issues such as the minimum required cooling rate during the quenching process had not been resolved. Second, it had been assumed that the current quenching medium was the only acceptable way to achieve the minimum required cooling rate. Because ACME did not have this

exact type of quenching apparatus, it was further assumed that a large capital expenditure would be required to make the process work in house.

Unsatisfied with these assumptions, we set out to analyze the feasibility of this process by developing a factual understanding of the process requirements. If the analysis proved that a DSA process for Product X was feasible and such a process was implemented, there would be substantial quality, flow time, and potentially cost benefits. The quality enhancement would result from the minimization of time the unit spends at elevated temperatures after Internal Step #3. The flow time reduction would result from the elimination of the shipping, queue, and heat-up time associated with heat treatment at an external supplier and the ensuing combination of the two machining steps into one. If the DSA process proved infeasible, the metallurgical and processing information gathered during the analysis could still be applied to future refinements in the heat treatment process.

The DSA process analysis was approached in two ways. First, the finite element analysis tools at ACME were used to model the quenching process. Using thermocouple data gathered from past and current quenching experiments, heat transfer relationships between the test piece and the quenching mediums were extracted and applied to models of actual production configurations of Product X. These models provided valuable insight into the cooling rates actually achieved in the product. Second, several sub-scale experiments were conducted at the ACME Research Center. One of these was a 2³ full-factorial designed experiment exploring the impact of three processing variables (immediately prior to the quenching process) on tensile strength, toughness, and grain size in the finished material. The other experiment studied tensile strength and toughness as a function of cooling rate during quenching. Because of the time constraints of the internship, the processing experiments were conducted in parallel with the modeling. The finite element modeling analysis is discussed below in Section 5.3. The experiments conducted at the ACME Research Center are discussed in Section 5.4.

5.3 Finite Element Modeling of the Quenching Process

5.3.1 Why Finite Element Modeling

The most critical variable during the DSA process is the cooling rate achieved during the quenching process. As was discussed earlier, if the material is not cooled rapidly enough, there is a danger of precipitating out undesirable phases. Conducting a series of full scale experiments to determine the lower bound of acceptable cooling rates was infeasible from both a time and cost standpoint. Finite element modeling, however, allowed the data gathered in only a few full scale experiments to be applied to additional scenarios in a fraction of the time or cost of additional experiments.

Some full scale quenching data was already available. A scrapped unit of Product X had been fitted with thermocouples, heated to the solution temperature, and quenched at both external heat treat suppliers. In addition, another scrap piece was fitted with thermocouples and quenched using the best available facilities at ACME during the internship. These three experiments provided temperature histories as a function of time at multiple locations within the test pieces. Applying finite element modeling to this thermal data allowed the extraction of heat transfer relationships between the part and the quenching medium that could subsequently be applied to production configurations of Product X.

Without finite element capability, it would not have been possible to apply these results to other scenarios. The material properties of Product X, such as thermal conductivity, density, specific heat, and emissivity, and the heat transfer relationship between the material and the quenching medium are all functions of temperature. Calculating an exact solution by hand would be impossible. Finite element modeling provided a means to find a highly accurate, approximate solution to the problem by dividing the unit into thousands of smaller sub-units that could be solved linearly. Only with a computer can the millions of calculations required to make this technique work be performed in an accurate and time efficient manner.

5.3.2 Procedure for Modeling Quenching Process

The quenching process was modeled in 2-D space using Ansys revision 4.4A. The model consisted of three sections: geometry definition, material properties specification, and boundary conditions. In order to simplify the adaptation of the model to different quenching scenarios or geometries, the code was written into a UNIX batch file with certain parameters isolated as input variables. As was noted previously, the geometries, material properties, and analysis results discussed in this section have been disguised to protect the proprietary interests of ACME Metal Products but preserve proportional and causal relationships.

Geometry Definition

The external geometry was described using a series of keypoints and line segments. The resulting 2-D cross section of the part was meshed to provide an accurate solution in a minimum amount of time. Through trial and error, a mesh with nodal spacings of approximately 1cm was selected. Further refinements in the mesh did not yield significantly different results. To illustrate the geometry and meshing procedure, Figure 5.3.2.1 below shows the keypoints, line segments, and nodes for the quarter-section of a generic metal cylinder (30 cm tall and 60 cm in diameter).

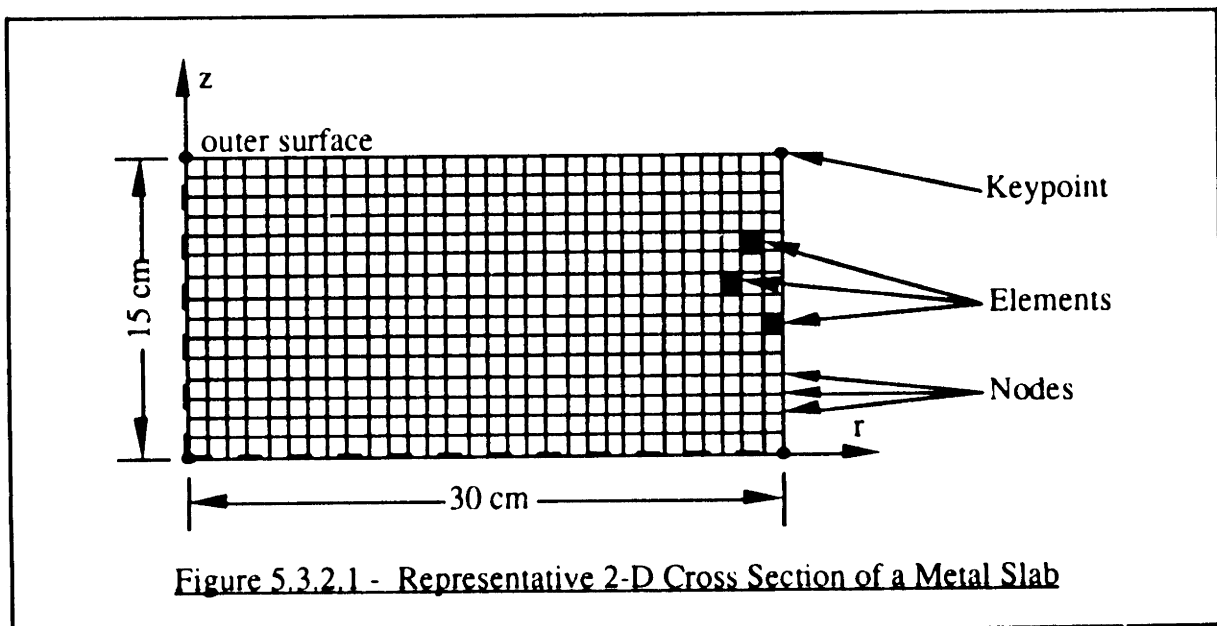

Material Properties

The material properties required for thermal modeling of Product X were thermal conductivity, specific heat, density, emissivity, and the heat transfer coefficient between the material and the quenching medium. Data on thermal conductivity, specific heat, density, and emissivity was available from past research conducted by ACME. Regressions were applied to the data to capture the temperature dependence.

While developing the model, it became apparent that Ansys had difficulty handling radiation heat transfer when given large temperature gradients between the radiating surface and the surroundings. To resolve this problem, the radiation component of heat transfer was converted into a temperature dependent, radiation heat transfer coefficient by solving the heat flux equation in Equation 1. The form factor is assumed to be one.

$$\text{heat flux} = h_r A (T_{\text{part}} - T_{\text{ref}}) = \epsilon \sigma A (T_{\text{part}}^4 - T_{\text{ref}}^4)$$

Equation 5.3.2.1 - Calculation of the Radiation Heat Transfer Coefficient

$$h_t (\text{total}) = h_c (\text{convection component}) + h_r (\text{radiation component})$$

Equation 5.3.2.2 - Calculation of Total Heat Transfer Coefficient

Solving Equation 5.3.2.1 for h_r yielded a fourth order temperature dependent relationship. In this relationship, it is the higher order terms that dominate at temperatures where heat loss due to radiation is significant. As will be explained later, for modeling the cooling rate behavior at the center of the part, the convection heat transfer coefficient may be accurately approximated as a constant (two to three orders of magnitude larger than the constant term in the radiation heat transfer relationship). Thus, in Section 5.3.3 when the constant term of the heat transfer coefficient is tuned to fit the experimental data, the radiation component is essentially unaltered.

Boundary Conditions

The key boundary conditions specified by the model were the convection surfaces, the time scale of the analysis, and the time increment between iterations. The convection surfaces were simply the outside surfaces of the part. The time scale was selected to be long enough for the part to cool below the temperature at which the hardening elements are effectively "locked" in solution in both quenching regimes. The time increment between iterations was calculated by the Ansys software using an algorithm that allows the time between iterations to grow larger as the steep thermal gradients present at the beginning of the analysis fade, preventing the software from solving more iterations than necessary.

Modeling Assumptions

In any modeling effort, assumptions must be made to simplify the calculations or due to a lack of information. The most notable assumptions made in this analysis are: 1. The material properties are isotropic and correct (particularly emissivity), 2. The convection heat transfer coefficient is constant. Although this would not be acceptable for modeling points near the surface, it does provide a good fit for the center of the part, 3. The emissivity is not dependent on the surrounding medium, and 4. The temperature within the piece is uniform immediately prior to quenching. In reality, some air cooling of the part will have occurred in transit from the solutioning furnace to the quenching apparatus.

5.3.3 Solving for the Heat Transfer Coefficient

Using the model described above, a trial and error approach was used to match the model output to the actual data. The cooling rate was monitored in the model at the same locations that the thermocouples were located within the test pieces. The goal at this stage of the modeling effort was to most closely match the cooling rate behavior at the

location that cooled most slowly, even if this meant inaccurate results for locations near the surface.

From this iterative approach, it was empirically determined that a constant convective heat transfer coefficient was quite adequate for predicting cooling rate behavior at the center of the part. In reality, the convective heat transfer coefficient is a highly non-linear function of the temperature of the material and the temperature of the quenching medium. Calculating a higher order relationship was both beyond the scope of this analysis and very difficult given nature of the experimental data.

Figure 5.3.3.1 compares the modeled versus experimental cooling profile at the center of a part quenched using the existing process at the external suppliers (hereafter known as Quench A). Figure 5.3.3.2 compares the modeled versus experimental cooling profile at the center of a part quenched using the best possible internal method (hereafter known as Quench B).

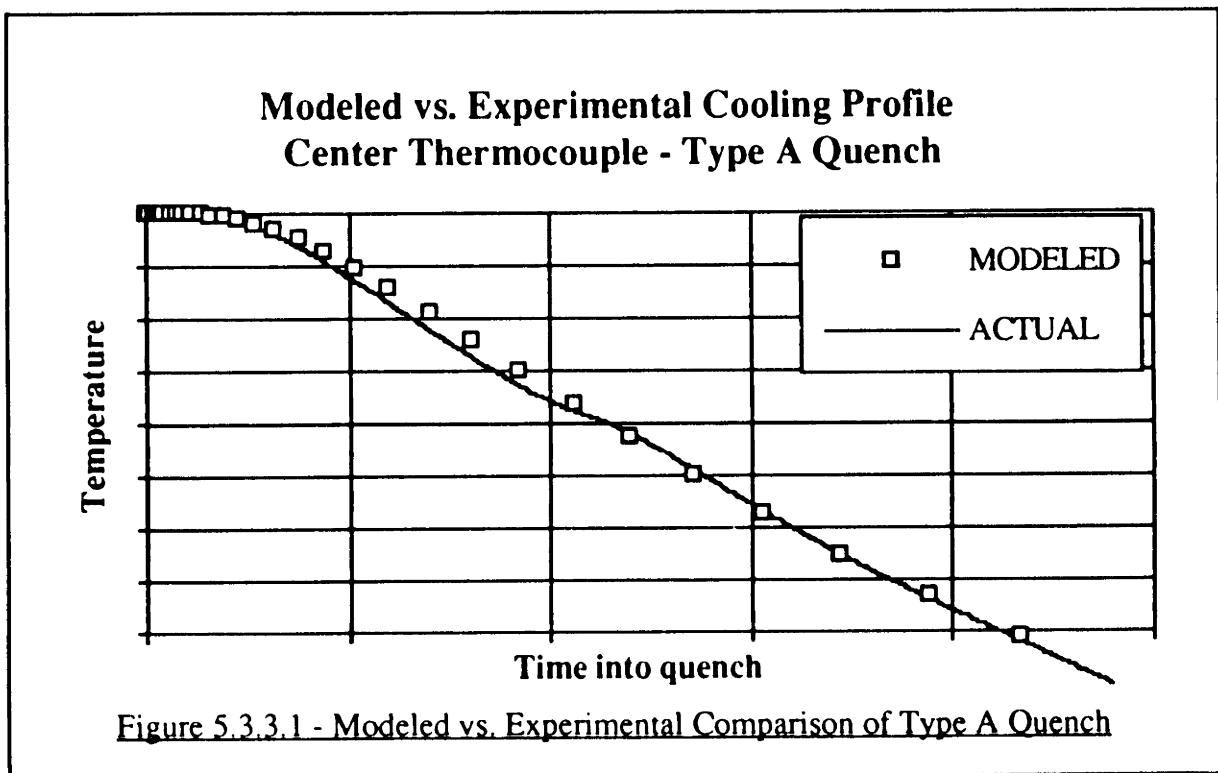

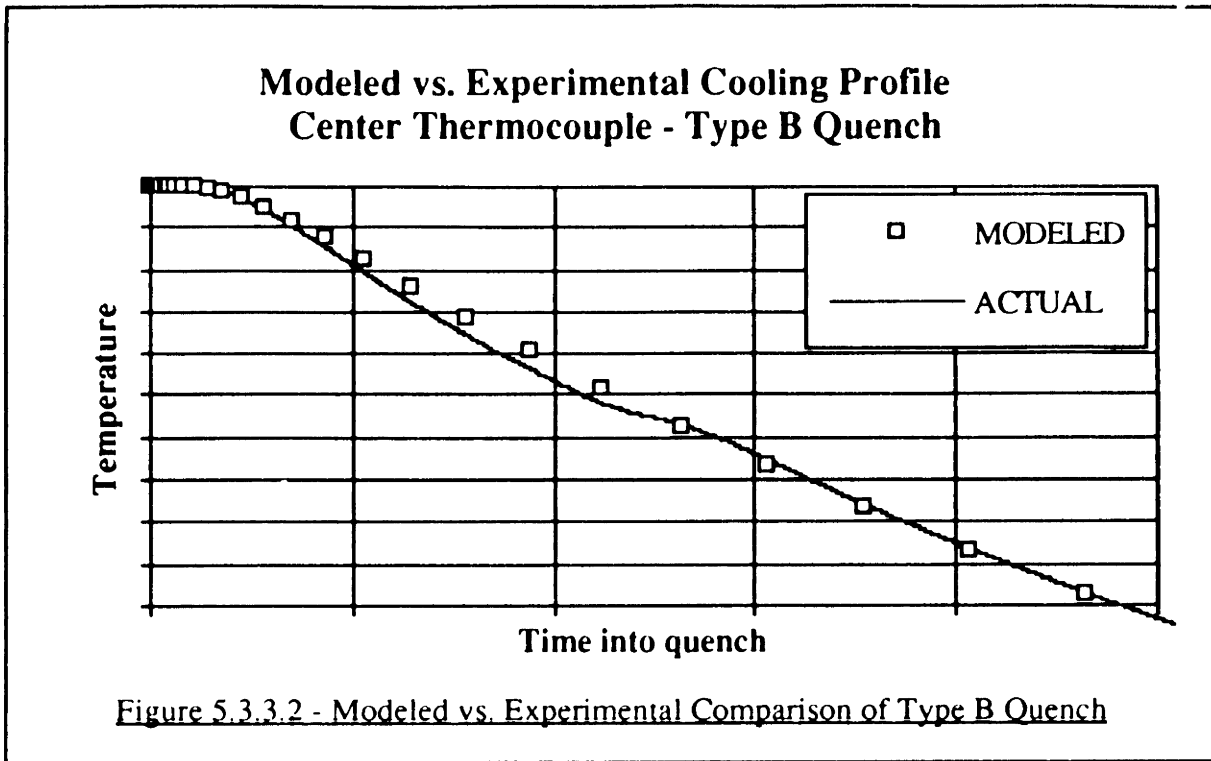

The overall fit of the models to the experimental data was quite good. The slight overestimate of temperature during the early stages of the quench was not a problem, since the goal of the modeling effort was to match the slope of the cooling profile over the given range.

5.3.4 Application of Heat Transfer Data to Production Configurations

The heat transfer relationships extracted from the experimental data were subsequently applied to actual production configurations to predict center cooling rates realized using both quenching methods. In addition to the rate of heat extraction from the surface, the half-thickness of the part sets the thermal resistance in governing how quickly the center can cool. Table 5.3.4.1 below summarizes the half-thickness and center cooling rates for both quenches for the eight actual production configurations of Product X.

Part Type	Half Thickness (cm)		Cooling Rate (°F/min)	
	Machined	Un-Machined	Type A Quench	Type B Quench
Configuration 1	6.73	7.05	45.0	15.7
Configuration 2	7.81	8.08	34.8	13.3
Configuration 3	6.33	6.90	50.0	16.1
Configuration 4	7.40	7.82	37.0	14.2
Configuration 5	8.12	8.89	32.6	11.7
Configuration 6	9.39	10.00	25.1	10.1
Configuration 7	8.12	8.89	32.6	11.7
Configuration 8	8.69	9.18	28.8	11.5

Table 5.3.4.1 - Center Cooling Rates for Type A and Type B Quenches⁹

5.3.5 Uncertainty Analysis

When considering the significance of the output of any model, it is important to consider the both the potential sources of uncertainties in the model inputs and the potential impact of those uncertainties on the results of the analysis. In this thermal analysis of the quenching of Product X, the potential sources of uncertainties in the model inputs are: accuracy of the material properties (thermal conductivity, specific heat, density, emissivity), accuracy of the heat transfer relationship between the part and the quenching medium and the experimental data used calculate it, accuracy of part dimensions, cooling of the part in transition from the solutioning furnace to the quenching apparatus. Of these sources of uncertainty, the two most likely to have the greatest impact on the results of the analysis are the material properties (particularly thermal conductivity) and the heat transfer coefficient between the part and the quenching medium. The part dimensions are controlled to reasonably tight tolerances and the cooling of the part that occurs en-route to the quenching apparatus is essentially insignificant compared to the cooling during the quenching process itself.

Both the thermal conductivity and the heat transfer coefficient have a significant impact on the rate of heat extraction from the part. Depending on their relative

⁹ The half-thickness dimensions have been normalized to a maximum half-thickness of 10 cm. The center cooling rates have been normalized to a maximum rate of 50°F/min.

magnitudes, uncertainties in one or both can have a significant impact on the accuracy of the results of the model. The dimensionless Biot number provides such a means of comparison and is presented in Equation 5.3.5.1.

$$Bi = \frac{hl}{k}$$

Equation 5.3.5.1 - Calculation of the Biot Number

The Biot number is the ratio of the thermal conductance of the interface between the solid and quenching medium (i.e. heat transfer coefficient) and the thermal conductance of the solid (i.e. thermal conductivity divided by characteristic thickness). Large Biot numbers (significantly greater than 1) indicate that the thermal conductance of the solid controls the cooling rate of the part, placing more importance on minimizing the uncertainty of the thermal conductivity. Small Biot numbers (significantly less than 1) indicate that the thermal conductance of the interface between the solid and the quenching medium controls the cooling rate of the part, placing more importance on minimizing uncertainty in the heat transfer coefficient. A Biot number of 1 indicates that both factors are of equal importance to the cooling rate.

In the case of Type A quenching (existing process), the Biot number is several times greater than 1 for all configurations of Product X, indicating the internal cooling rate will be dominantly controlled by the thermal conductivity of the material. Thus, the cooling rates predicted by the finite element model for Type A quenching will be several times more sensitive to uncertainties in thermal conductivity than uncertainties in the heat transfer coefficients at the surface. In the case of Type B quenching (best current internal quenching process), the situation is reversed. The Biot number is only a fraction of 1, indicating the internal cooling rate will be dominantly controlled by the rate of heat extraction from the surface. Thus, the cooling rates in Type B quenching will be several times more sensitive to uncertainties in the heat transfer coefficients than uncertainties in thermal conductivity. It is important to note that in neither the Type A or Type B quench

does one component of the overall thermal conductance so completely control the rate of heat extraction that the other is insignificant. Therefore, uncertainties in both should be considered

This analysis of the major uncertainties in the modeling results is based on theory and intuition from working with the model. Unfortunately, time was not available to perform a rigorous sensitivity analysis on each of the model's input parameters. Such an analysis would be valuable in providing estimates of error in these predicted cooling rates. From a qualitative standpoint, my own best upper-bound estimate on the potential error (based on intuition from constructing and working with the model) is perhaps 1 or at most 2°F/min. In the following discussion on this predicted cooling rate data, such errors would not have a profound impact on the conclusions.

5.3.6 Conclusions from Finite Element Modeling of Quenching Process

The predicted center cooling rates achieved by the current (Type A quench) process range from 25.1°F/min for the thickest configuration of Product X to 50.0°F/min for the thinnest configuration. In the case of the thickest configuration, this cooling rate is more than 57% slower than had been previously assumed. Since the current quenching process is known to yield acceptable material properties for all configurations, 25.1°F/min is an upper bound estimate on the minimum acceptable cooling rate.

The predicted center cooling rates achieved by the best quenching method presently available at ACME (Type B quench) range from 10.0°F/min for the thickest configuration to 16.1°F/min for the thinnest. In the case of the thinnest configuration, this cooling rate was as much as double the best previous estimate.

The bottom line to this analysis is that the difference in the cooling rates achieved by Type A and Type B quenching is not nearly as large as had originally been assumed. Specifically, the difference between the lowest Type A quench cooling rate of 25.1°F/min and the fastest Type B quench cooling rate of 16.1°F/min is only 9°F/min. There are

several process embellishments that might be added to the Type B quenching process that could significantly boost the cooling rate for a relatively small capital expenditure relative to the cost of installing Type A quenching apparatus.

Furthermore, if the critical cooling rate is found to be lower than 25.1°F/min, it is possible that the as-is Type B quenching process may be yielding acceptable cooling rates. Establishing the value the critical cooling rate was the goal of one of the experiments conducted at the ACME Research Center described below in Section 5.4. Because these experiments were being conducted in parallel with the modeling effort, we did not know at that time to focus on cooling rates less than 25.1°F/min. In fact, the lowest cooling rate evaluated was 23.4°F/min. This test specimen proved to have acceptable properties, supporting the prediction of the finite element model that 25.1°F/min is acceptable. More experimentation is needed to pinpoint the value of the critical cooling rate for this process.

5.3.7 Opportunities for Additional Finite Element Modeling

The finite element analysis described in this section represented a significant contribution to the development and characterization of the DSA process for Product X at ACME. There are several opportunities for additional finite element modeling of the process that would yield improved process understanding. First, a coupled thermal-mechanical analysis would be useful in stress state of the unit throughout the quenching process. As the DSA process would have the unit entering the solution and quench processes with the as-fabricated surface instead of a machined surface, knowledge of the stress state should allow estimation of whether surface imperfections will lead to failure via fracture. Second, more advanced modeling may allow the extraction of the real non-linear, temperature dependent heat transfer relationship between the unit and the quenching medium. Finally, a sensitivity analysis of the model would determine the

exact sensitivity of the model output to the various inputs and identify which input variables, if any, should be known with a higher degree of certainty.

5.4 Process Definition at the ACME Research Center

Two sets of experiments were conducted at the ACME Research Center to gain a better understanding of the relationship between DSA process variables and the material properties of the finished product. Any quality enhancements that could be demonstrated would add support to the existing flow time reduction motivation for pursuing the DSA process. The first set of experiments investigated grain size as a function of temperature during Internal Fabrication Step #3, a proprietary processing variable, and solution time. The second set of experiments investigated yield strength and toughness as a function of cooling rate after solution treatment. The procedures, results, analyses, and conclusions are described below.

5.4.1 Grain Size vs. Processing Variables Experimentation

Procedure

A 2^3 full factorial designed experiment was conducted to investigate the impact of Internal Fabrication Step #3 temperature (T), a proprietary processing variable (S), and solution time (X) on the grain size in the finished unit of Product X.. The values of each level of the experimental variables were either chosen as bounding cases (temperature and press speed) or as best estimates of what might actually be implemented in a DSA process (solution time). An additional two samples were prepared using a scaled version of the existing heat treat and age practice for use as baselines. The actual experimental matrix is summarized in Table 5.4.1.1.

ID#	Temperature (T)	Variable #2 (S)	Solution time (X)
Direct solution and age (DSA) specimens			
1	low (-)	setting 1 (-)	short (-)
2	high (+)	setting 1 (-)	short (-)
3	low (-)	setting 2 (+)	short (-)
4	high (+)	setting 2 (+)	short (-)
5	low (-)	setting 1 (-)	long (+)
6	high (+)	setting 1 (-)	long (+)
7	low (-)	setting 2 (+)	long (+)
8	high (+)	setting 2 (+)	long (+)
Baseline specimens			
B1	low (-)	setting 1 (-)	(different process)
B2	high (+)	setting 1 (-)	(different process)

Table 5.4.1.1 - Experimental Matrix for Grain Size Experiments

The starting material for the test specimens were miniature, proportionally scaled ingots cut from a slice of a real ingot. Although the specimens were taken from the same region of the original ingot slice, it is possible that there were some variations in the initial microstructures. Due to time and budget limitations, however, only one specimen of each type was prepared.

The fabrication steps leading up to the heat treatment process were prepared in a scaled manner based on the existing fabrication process. After solutioning and quenching, the DSA specimens were given an aging practice designed to simulate the time and temperature history experienced by the center of the part during the existing aging process. The baseline specimens were solutioned according to a process designed to simulate the time and temperature history experienced by the center of the part during the existing solutioning practice, and aged with the DSA specimens. The specific details of these processes are proprietary, and thus may not be described in greater detail.

Results

Upon completion of the aging treatment, the specimens were sectioned, polished, and chemically etched to reveal the grain structure. Grain size measurements were taken by evaluating five fields at two locations on each sample specimen using the intercept

method. Grain sizes are reported on the ASTM grain size scale (higher numbers indicate smaller grains). It must be noted that this grain size measurement method is only accurate to approximately one-third or one-half an ASTM grain size. The measured grain sizes for each specimen are summarized below in Table 5.4.1.2. The calculated estimates of the effects of temperature, proprietary variable #2, and solution time in the designed experiment are summarized in Table 5.4.1.3.

ID#	Temp (T)	Variable #2 (S)	Solution Time (X)	Grain Size 1	Grain Size 2	Grain Size
Designed experiment specimens						
1	low (-)	setting 1 (-)	short (-)	7.20	7.35	7.28
2	high (+)	setting 1 (-)	short (-)	7.65	7.20	7.43
3	low (-)	setting 2 (+)	short (-)	7.35	7.50	7.43
4	high (+)	setting 2 (+)	short (-)	7.50	7.35	7.43
5	low (-)	setting 1 (-)	long (+)	7.20	7.05	7.13
6	high (+)	setting 1 (-)	long (+)	6.75	6.75	6.75
7	low (-)	setting 2 (+)	long (+)	6.60	6.75	6.68
8	high (+)	setting 2 (+)	long (+)	6.90	6.90	6.90
Baseline specimens						
B1	low (-)	setting 1 (-)	(different process)	6.90	6.75	6.83
B2	high (+)	setting 1 (-)	(different process)	6.00	6.45	6.23

Table 5.4.1.2 - Results of Grain Size Experiments

Effect	Estimate +/- standard error
average	7.13 +/- 0.06
main effects	
temperature T	0.00 +/- 0.13
variable #2 S	- 0.04 +/- 0.13
solution time X	- 0.53 +/- 0.13
two-factor interactions	
T x S	0.11 +/- 0.13
T x X	- 0.08 +/- 0.13
S x X	- 0.11 +/- 0.13
three factor interactions	
T x S x X	0.19 +/- 0.13
baseline B1 (average)	6.83 +/- N/A
baseline B2 (average)	6.23 +/- N/A

Table 5.4.1.3 - Calculated Effects of Variables in Grain Size Experiments¹⁰

Analysis

To be statistically significant at the 95% confidence level, the calculated effect must be more than 2 times the magnitude of the standard error. Considering the designed experiment results from this standpoint, the only input parameter having a significant impact on grain size is solution time. The magnitude of this effect is observed to be -0.53 ASTM grain sizes, indicating a grain growth of 0.53 ASTM grain sizes during the extra solution time experienced by the (+) solution time samples. The observed effect of grain growth being a function of solution time was consistent with our expectations.

It is known that temperature and proprietary variable #2 can have an effect on grain size in other processing regimes. In this experiment, the effects were observed to be insignificant, most likely being overwhelmed by the effect of the solution time.

The baseline specimens were observed to have grain sizes of ASTM 6.83 and 6.23 at the low and high Internal Fabrication Step #3 temperatures, respectively. Given that temperature was not observed to have a statistically significant impact in the designed

¹⁰ No direct estimate of the standard error can be made from this data since there were no replicate runs. Assuming that the second and third order interactions are negligible, however, it follows that these calculated effects measure differences resulting mainly from experimental error. This technique was applied to calculate the standard error for this experiment.

experiment and that the solution times experienced by the baseline specimens were in fact longer than the DSA specimens, it seems most likely that these values differ more based on measurement error than anything else. If we compare the average of the two baseline specimens (ASTM 6.53) to the average of the long solution time DSA specimens (6.87) and the short solution time DSA specimens (ASTM 7.39), the baseline specimens with their longer solution times do indeed have a larger grained structure as would be expected. Such a comparison is only quasi-legitimate statistically, but sometimes decisions and conclusions must be carefully drawn from limited or incomplete data.

Conclusions

The results of this experiment reflect favorably on the ability of a DSA to yield a finer grained microstructure. The existing manufacturing process leading up to and including the heat treatment procedure (forge at elevated temperature - cool - reheat - solution - quench) leads parts to experience longer cumulative exposure to elevated temperatures longer than with the DSA process. Longer cumulative exposure to elevated temperatures in the form of solution times were observed to have a statistically significant effect on grain size in the DSA designed experiment specimens. Therefore, it may be concluded that the DSA process is indeed capable of yielding a higher quality, finer grained microstructure in addition to substantial flow time reductions.

Further process characterization of the impact of the solutioning process on the final grain size is required before full scale trials are justified (excluding consideration of other processing limitations). A combination of finite element modeling of the thermal history of Product X during the solutioning phase of the manufacturing process coupled with additional sub-scale experiments examining the impact of solution time on grain size should be utilized to gain greater understanding of the processing-properties interactions between solution time and grain size.

5.4.2 Critical Cooling Rate Experimentation

Procedure

An experiment was conducted to evaluate the effect of post-solution cooling rate on material yield strength, Charpy V-notch (CVN) toughness, elongation, and reduction in area. Test specimens were prepared from a scrapped, un-heat treated unit of Product X. The specimens were solutioned and aged according to the baseline practice in the grain size experiments, but furnace quenched after solution treatment to achieve a controlled cooling rate.

Three different cooling rates (46.9°F/min, 42.2°F/min, and 23.4°F/min) were utilized, reflecting the technical team's best estimates of the cooling rates being experienced in the center of Product X in the current quenching process. Since these experiments were conducted in parallel with the finite element modeling, we were unable to benefit from the modeling results in this experimental iteration.

Results

The material properties for the three post-solution cooling rate experiments are summarized in Table 5.4.2.1 below.

Cooling Rate	Yield Strength	CVN Toughness	Elongation	R of A
23.4°F/min	127.8 ksi	41.5, 43 ft-lbs	21%	38.1%
42.2°F/min	127.8 ksi	44, 46.5 ft-lbs	23%	44.9%
46.9°F/min	127.3 ksi	40.5, 46.5 ft-lbs	23%	43.6%

Table 5.4.2.1 - Material Properties for Post-Solution Cooling Rate Experiments

Analysis

The trends expected to be seen as the cooling rate decreases below the minimum acceptable cooling rate are increases in yield strength, and decreases in CVN toughness, elongation, and R of A. Above the minimum acceptable cooling rate variations in material properties should not be effected, as they all accomplish the same function of keeping the hardening elements in solid solution. As can be seen from the data, there are

no significant trends in the anticipated directions over this range of cooling rates. This suggests that the minimum required cooling rate is in fact less than 23.4°F/min.

Conclusions

Although this experiment did not identify the exact value of the minimum acceptable cooling rate to achieve material properties, it did demonstrate that 23.4°F/min was fast enough. This observation is in agreement with the finite element modeling of the existing quenching process, which indicated that the largest units of Product X achieve center cooling rates of only 25.1°F/min. Given that the current process is known to yield acceptable finished parts, it is reasonable to conclude that the minimum acceptable cooling rate is in fact less than 23.4°F/min. This is a very favorable conclusion, for it indicates that slower quenching rates may be adequate for the process. Further experimentation is needed to establish the exact cutoff and the robustness of material behavior in the vicinity of that cutoff value.

5.5 Chapter 5 Summary

This portion of the flow time reduction project was aimed at reducing flow time through process innovation. A technique known as direct solution and age (DSA) was investigated as potential replacement for the existing heat treatment process. If, upon further characterization and development, this process is implemented, it has the potential to save approximately 10 days of flow time. Furthermore, a DSA process for Product X is expected to yield a refined grain structure, and thus a higher quality product.

Finite element modeling was used to analyze the quenching process. Using limited data from full scale experiments, heat transfer relationships for the different quenching processes were developed and applied to all production configurations. The results indicated that the center cooling rate being achieved with the existing process at the external heat treat suppliers was much less than assumed and the center cooling rate achievable using the best available internal facilities was higher than assumed.

Experiments now underway at ACME may demonstrate that the cooling rate capability of the internal facilities can be increased to the point that in-house quenching (and thus DSA) becomes feasible.

A designed experiment was conducted at the ACME research center to assess the impact of several DSA processing variables (internal fabrication step #3 temperature, proprietary variable #2, and solution time) on the grain size of the finished product and verify the expected grain size reduction. The experimental results indicated that solution time prior to quenching had a statistically significant impact on the grain size of the finished product. The DSA samples were observed to have a finer grain size than the baseline specimens representing the existing process.

A second experiment was conducted at the ACME Research Center to determine the critical cooling rate needed during the quenching process to maintain acceptable yield strength, toughness, elongation, and reduction in area properties. The results indicated there was no significant difference between specimens quenched at 23.4°F/min and specimens quenched at 46.9°F/min. This result is both in agreement with the process theory, which predicts the same properties in all specimens cooled rapidly enough to keep the hardening elements in solid solution, and the finite element modeling, which predicted the critical cooling rate to be less than 25.1°F/min. More experiments need to be conducted for cooling rates less than 23.4°F/min to isolate the minimum acceptable cooling rate to achieve specified material properties. The lower it is found to be, the more likely a DSA process will be implemented on Product X.

Although this portion of the flow time reduction project did not culminate in the implementation of the DSA process, important material properties and processing knowledge were contributed to ACME's understanding of the processing-properties-performance dependencies of Product X. This knowledge will provide the foundation for further DSA process characterization, hopefully leading to successful implementation in the future.

Chapter 6 -- Summary, Conclusions, and Recommendations

6.1 Thesis Summary

This thesis has examined the execution of a flow time reduction program applied to the manufacturing process for Product X. The flow time reduction techniques of process mapping and process innovation were described and their application to Product X was documented and analyzed. The final results of the program were mixed.

Judged on an absolute scale, the net reduction in flow time actually achieved was very small. Many opportunities were identified through the process mapping procedure but most were not implemented for a variety of reasons discussed in Chapter 4. The development and characterization of the direct solution and age heat treatment practice made definite strides, but more work is required before such a process can be implemented in production.

There were many positive results to the flow time reduction program, however. The team at ACME developed a more thorough understanding of both the internal and external manufacturing processes for Product X. Relationships were built with external suppliers that may pay dividends in the future. The flow time reduction techniques learned on this project may be more successfully applied to future situations based on our experiences. The characterization of the DSA process, though incomplete, has laid the foundation for continued development and contributed to ACME's understanding of the processing-properties-performance relationships in Product X. Finally, the expanded flow time database has provided ACME with a useful tool for both accumulating flow time, processing data, and material properties on Product X and evaluating the information contained therein.

6.2 Conclusions

6.2.1 Flow Time Reduction Through Process Mapping

The technique of process mapping is a viable tool for both understanding a manufacturing process and identifying opportunities within that process for flow time reduction. As was illustrated by the flow time reduction program on Product X, these opportunities can cumulatively lead to a very significant flow time reduction.

While the process mapping procedure does identify where the opportunities are, it does not usually explain the best strategy for their implementation or make the plant environment fundamentally more receptive to such changes. In the overall procedure, process mapping through implementation and realization of flow time savings, process mapping portion is the easy part of the battle. It is a high visibility process that yields nice charts, new teams and projects, and sometimes overly optimistic forecasts of the flow time reduction that will be achieved. Getting from the process mapping stage through actual implementation requires great effort, motivation, and commitment, for this is where the reality of the situation must be changed.

6.2.2 Flow Time Reduction Through Process Innovation

Process innovation is just as important as process mapping in achieving flow time reduction. The how-to of process innovation is not as easily communicated, however, for the details of how to arrive at a useful process innovation are highly dependent on the specific situation. Generally speaking, there are actions the organization can take to stimulate process innovations. It should be willing to try new processes and procedures, take risks, and support longer term development efforts. The organization should be willing to study the best practices of other organizations as a source of ideas, avoiding the "not invented here" syndrome. Any organization that is aggressively pursuing process innovations will encounter failures along the way. Such failures are part of the process and should not be penalized by the organization.

Although the timing and benefit of process innovations can't be predicted with great precision and regularity, the manufacturing firm can cultivate the right environment for such innovations to occur. This is the key to adding process innovation capability to a firm's flow time reduction tool kit.

6.3 Recommendations for Future Flow Time Reduction Efforts

Based on our experiences with the flow time reduction program on Product X at ACME Metal Products, the following recommendations are made to organizations preparing to engage in similar efforts.

- *Invest Time in Up-Front Planning*

Planning ahead to assess project difficulty, resource requirements, potential barriers, and potential gains is time well spent. Considering all the options will allow the leveraging of available resources to the maximum possible benefit.

- *Go For an Easy Win First*

If there are multiple opportunities for flow time reduction, go for an easy win first. Selecting a reasonable size project with a high likelihood of success will generate the internal buy-in and support that is necessary for tackling larger, more difficult projects.

- *Have an Internal Project Champion*

Flow time reduction efforts should be driven by an internal champion who is thoroughly committed to the process and believes in the results that can be achieved. Preferably, this person will be in middle to upper management and in a position to establish flow time reduction as a priority in the firm. Such top level support can continue to drive the project forward when barriers and impediments are encountered.

- *Apply Process Mapping and Process Innovation Techniques*

The techniques of process mapping and process innovation should be applied as methodologies for pursuing flow time reduction. The structure they provide (particularly in the case of process mapping) can be very important in channeling the efforts of well

meaning people towards the same goal. In addition, they provide a sense of structure to the entire process that might otherwise seem rudderless.

- *Empower Teams to Implement Changes*

The teams and individuals working on the flow time reduction effort must be given the time and resources to implement the identified changes. This may mean assigning people full time to flow time reduction projects. If these responsibilities are simply added to people's workload (such as getting product out the door), flow time reduction will not appear to be a priority and the effort will likely fail.

- *Apply Experiences to New Flow Time Reduction Projects*

In the spirit of continuous improvement, the experiences gained during the first flow time reduction project should be applied to subsequent efforts. The flow time reduction techniques described in this thesis will have been internalized by the organization, along with a more thorough understanding of the production environment. These two factors should allow future efforts to be both more focused and more rapidly executed, accelerating the benefits of flow time reduction and spurring new projects. Ideally, the techniques of flow time reduction will become integrated into the overall operating philosophy of the business.