

MIT Open Access Articles

Aggressive quadrotor flight through cluttered environments using mixed integer programming

The MIT Faculty has made this article openly available. **Please share** how this access benefits you. Your story matters.

Citation: Landry, Benoit et al. "Aggressive quadrotor flight through cluttered environments using mixed integer programming." 2016 IEEE International Conference on Robotics and Automation (ICRA), May 2016, Stockholm, Sweden, Institute of Electrical and Electronics Engineers (IEEE), June 2016 © 2016 IEEE

As Published: <http://dx.doi.org/10.1109/icra.2016.7487282>

Publisher: Institute of Electrical and Electronics Engineers (IEEE)

Persistent URL: <https://hdl.handle.net/1721.1/122048>

Version: Author's final manuscript: final author's manuscript post peer review, without publisher's formatting or copy editing

Terms of use: Creative Commons Attribution-Noncommercial-Share Alike



Aggressive Quadrotor Flight through Cluttered Environments Using Mixed Integer Programming

Benoit Landry¹, Robin Deits¹, Peter R. Florence¹ and Russ Tedrake¹

Abstract—Quadrotor flight has typically been limited to sparse environments due to numerical complications that arise when dealing with large numbers of obstacles. We hypothesized that it would be possible to plan and robustly execute trajectories in obstacle-dense environments using the novel Iterative Regional Inflation by Semidefinite programming algorithm (IRIS), mixed-integer semidefinite programs (MISDP), and a model-based controller. Unlike sampling-based approaches, the algorithm guarantees non-penetration of the trajectories even with small obstacles such as strings. We present experimental validation of this hypothesis by aggressively flying a small quadrotor (34g, 92mm rotor to rotor) in a series of indoor environments including a cubic meter volume containing 20 interwoven strings.

I. INTRODUCTION

Advances in research have brought the quadrotor to a level of sophistication that is making it increasingly attractive for a variety of commercial applications like surveying and delivery. In order for these applications to become a reality, we now need algorithms that can deal reliably with environments that are substantially more cluttered than a laboratory setting. The most successful algorithms put forward to enable quadrotors to avoid obstacles often require an exponential increase in planning time with respect to the number of obstacles by, for example, introducing an integer variable for each face of obstacles in the environment. Most of these algorithms therefore start to perform poorly as the number of obstacles is increased beyond a modest handful of them [1] [2].

Recently, it has been suggested that the challenges of increasing obstacle density may be overcome by the novel Iterative Regional Inflation by semidefinite programming algorithm (IRIS) that segments space into obstacle-free regions. Planning paths through this segmentation can be accomplished using mixed-integer convex optimization, with the complexity growing with the much more manageable number of free-space segments instead of the number of obstacle faces. Hence, it can produce trajectories in environments containing many more obstacles than was previously demonstrated. Moreover the non-penetration constraint that the algorithm enforces along the entire path promise better performance with small obstacles than previous approaches that rely on sampling. We hypothesized that it would be possible to aggressively fly a small quadrotor through environments containing greater number of obstacles than ever demonstrated before by leveraging IRIS, MISDPs, and

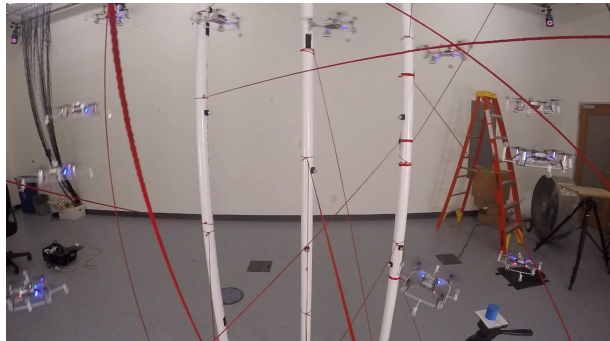

Fig. 1: Composite image of a single quadrotor, the Crazyflie Nano Quadcopter, executing a trajectory found using IRIS and MISDP through an environment of 20 interwoven strings and 6 poles contained in a cubic meter volume.

model-based control approaches. This document presents experimental validation of this hypothesis and of the planning algorithm introduced in [3].

The quadrotor used in our experiment, an off-the-shelf 34g platform running customized firmware, was controlled by the off-board software Drake [4] and followed trajectories computed by IRIS and mixed-integer semidefinite programs. The sensing was accomplished with Vicon optical sensors as well as an IMU on-board the quadrotor. The exact location of the obstacles was given to the planner ahead of time, as a set of convex hulls. We evaluated the performance of our algorithm by looking at its ability to find collision-free trajectories through environments containing many more obstacles than previously demonstrated alongside the tracking performance of our control system.

II. RELATED WORK

A few planning algorithms have been successfully applied to planning for quadrotors in moderately crowded environments. The approach in [5] consisted of running RRT* in the entire space where the quadrotor might fly. The algorithm only expanded the randomly-exploring tree with straight paths in order to make its expansion more efficient. It therefore resulted in a piece-wise linear collision-free trajectory. Finally, the algorithm computed a smooth trajectory using a quadratic program between each node along the path returned by RRT*. Although a very efficient approach, relying on sampling of space in order to check for collisions makes it potentially difficult to deal with very small obstacles like the strings used in our experiment. [1] demonstrated the use of mixed-integer quadratic programs in order to plan

The authors are with (1) Computer Science and Artificial Intelligence Laboratory, MIT, Cambridge, MA 02139, USA {landry, rdeits, peteflo, russt}@mit.edu

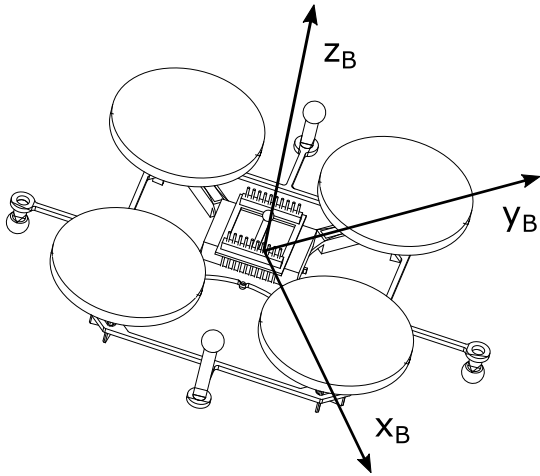

Fig. 2: Model of the quadrotor used, the Crazyflie Nano Quadcopter, and the body frame used in the differentially flat model developed by [10]. \mathbf{z}_B points in the same direction as the propellers at all time.

collision-free trajectories. In this particular work, the integer variable enforced non-penetration by making sure that the sampled location is on the collision-free side of at least one of the faces of each obstacle. The approach worked well in practice, but it suffered from having the number of integer variables grow rapidly with the number of obstacles. The technique once again cannot guarantee to generate collision-free trajectories between sample points, unlike our presented approach.

IRIS, our choice of algorithm for convex segmentation of free-space, has previously been used in the context of collision-free footstep planning [6]. In this application, the algorithm generated obstacle-free regions in the robot’s configuration space. A mixed-integer program was then used to assign steps to each regions while simultaneously optimizing the pose of the robot. [3] then went on to demonstrate that we could formulate the problem of planning minimum-snap collision-free trajectories as a mixed-integer semidefinite program by using the obstacles-free regions returned by IRIS and by planning in differentially flat space. This document in part aims to provide experimental demonstrations for these results.

[7] demonstrated a feedback controller for aggressive flight inspired by the work of Hoffmann et al. [8]. In this approach, an off-board controller computed the position and velocity error of the quadrotor and an on-board attitude controller converted the associated desired center of mass acceleration to a desired attitude. Finally, [9] used time-varying LQR to demonstrate an aircraft with rotating wings executing a knife-edge maneuver in order to fly between two poles without colliding with either of them. Our experiment utilizes the same model-based optimal control technique.

III. MODELLING AND SYSTEM IDENTIFICATION

We use the *differentially flat* quadrotor model introduced in [10] also used by others [5]. Generally, a system is said

to be flat if there exists a set of output, in equal number to the number of inputs, such that all the states of the system can be computed from these outputs (without integration). In our quadrotor model, the flat outputs are x , y , z position, and yaw.

The model consists of a single floating rigid body and four inputs. We define the inputs as the square of the angular velocities ω^2 of the motors on the quadrotor. A spinning propeller produces two forces on the quadrotor, namely lift and drag. Those forces are directly proportional to ω^2 . Each input ω_i^2 can therefore be said to produce a certain linear force F_i on the center of mass as well as to create a moment M_i according to

$$F_i = k_f \omega_i^2, \quad (1)$$

$$M_i = k_m \omega_i^2. \quad (2)$$

We can then write the dynamics of the quadrotor:

$$m\ddot{\mathbf{r}} = mg\mathbf{z}_W + \left(\sum_{i=1}^4 F_i \right) \mathbf{z}_B, \quad (3)$$

$$\dot{\boldsymbol{\omega}} = I^{-1} (-\boldsymbol{\omega} \times I \boldsymbol{\omega} + \mathbf{W}), \quad (4)$$

$$\mathbf{W} = \begin{bmatrix} 0 & k_f L & 0 & -k_f L \\ -k_f L & 0 & k_f L & 0 \\ k_m & -k_m & k_m & -k_m \end{bmatrix} \begin{bmatrix} \omega_1^2 \\ \omega_2^2 \\ \omega_3^2 \\ \omega_4^2 \end{bmatrix}, \quad (5)$$

where m is the mass of the quadrotor, $\ddot{\mathbf{r}}$ is the acceleration of its center of mass, \mathbf{z}_W is a unit vector in the direction of gravity, \mathbf{z}_B is a unit vector pointing in the same direction as the propellers (in the world frame), I is the inertia matrix of the quadrotor, L is the distance between each propeller and the center of mass of the quadrotor, and $\boldsymbol{\omega}$ is the angular velocity of the quadrotor in the body frame [5].

We solve the problem of identifying the parameters of this model with a two step approach. First, we directly or semi-directly measure each parameter of the model with a series of simple experiments. Second, we log flight data for a series of maneuvers using a motion capture system, and use an optimization-based algorithm to adjust those parameters. The k_f parameter was identified by measuring the thrust produced by the quadrotor placed upside-down on a scale and fitting the corresponding parameter. The k_m parameter can be measured by slowly increasing a pair of opposite motors (motors spinning in the same direction) and measuring the resulting angular velocities using the on-board gyroscope. We also produced a detailed model of the quadrotor using *SolidWorks* in order to compute an estimate of its inertia. Then after this initial set of measurements we logged a series of flights using our optical tracking system and fit the model to the resulting data using MATLAB’s Grey-box model estimation. The parameters we identified with this approach are shown in table I.

IV. TRAJECTORY GENERATION

A. Segmentation of Free-Space

The convex regions of free space are generated using the software IRIS [11]. IRIS solves the problem of segmenting

Parameter	Value
I_{xx}	$2.3951 \cdot 10^{-5} \text{kg} \cdot \text{m}^2$
I_{yy}	$2.3951 \cdot 10^{-5} \text{kg} \cdot \text{m}^2$
I_{zz}	$3.2347 \cdot 10^{-5} \text{kg} \cdot \text{m}^2$
K_m	$1.8580 \cdot 10^{-5} N \cdot \text{m} \cdot \text{s}^2$
K_f	$0.005022 N \cdot \text{s}^2$

TABLE I: Parameters of our model of the Crazyflie Nano Quadcopter

3D space into a set of convex regions through a series of convex optimizations. More specifically, IRIS alternates between two optimizations. The first optimization is a quadratic program that finds hyperplanes that separate a convex region of space from the obstacles. The second optimization is a semidefinite program that takes the intersection of those hyperplanes, and finds an ellipsoid of maximum volume inscribed inside those hyperplanes.

In order to account for the dimensions of the quadrotor, we inflate the convex hulls representing the obstacles before passing them to IRIS. We inflate the obstacles by moving each one of their planes in the direction of their normal by an amount equal to the radius of the quadrotor. This allows us to treat the quadrotor as a dimensionless object for the rest of the planning.

B. Mixed Integer Semidefinite Program

Ordinarily, designing a trajectory for a dynamical system such as a quadrotor would require us to consider the full state of our model (in this case, the position, velocity, orientation, and angular velocity of the center of mass) and its inputs. The model of the quadrotor used in this work, however, has the attractive quality of being differentially flat in four outputs, namely the x , y , and z position and yaw of the model's center of mass [10]. From a trajectory in those four flat outputs, we can derive a trajectory of the entire state of the model and its inputs by following the procedure described in [10]. We further simplify the problem by setting the yaw trajectory to zero during the optimization.

We follow the procedure described in [3] to represent trajectories in x , y , z as piecewise polynomial functions of time, and we fix the timespan of each polynomial piece to an arbitrary range of 0 to 1. This arbitrary timespan can be adjusted after the optimization to control the actual time spent executing the trajectory. With the timespan fixed, the trajectory optimization consists of choosing the coefficients of the piecewise polynomials. Additionally, we constrain that the piecewise polynomial be continuous up to the $(d-1)$ th derivative, where d is the degree of each polynomial piece.

In order to ensure that the trajectories generated are fully collision-free, we require that each polynomial piece be fully contained within some convex region of obstacle-free space. This is a conservative approach, since it is entirely possible for a trajectory to be collision-free without having each polynomial lie within a single convex volume, but it is an advantageous constraint because it converts our problem into one we can efficiently solve to its global optimum.

We represent the assignment of polynomial pieces to convex regions of free space with a matrix of binary variables, $H \in \{0, 1\}^{R \times N}$, where R is the number of convex regions and N is the number of polynomial trajectory pieces. For each element of H , we constrain that if $H_{r,j} = 1$, then polynomial j must be contained within region r . This constraint can be represented as a combination of linear and semidefinite constraints for a polynomial of arbitrary degree, although it can be reduced to a second-order cone constraint for polynomials of degree 3 [3].

To ensure that every polynomial is contained in some convex region, we add linear constraints of the form:

$$\sum_{r=1}^R H_{r,j} = 1 \quad \forall j \in 1, \dots, N, \quad (6)$$

[12] showed that sum of squares constraints can be formulated as semidefinite programs. We therefore formulate our non-penetration constraint as a sum of squares constraint. First we define the polynomial j as a linear combination of polynomial basis functions $\phi_1(t), \dots, \phi_{d+1}(t)$.

$$P_j(t) = \sum_{k=1}^{d+1} C_{j,k} \phi_k(t) \quad t \in [0, 1], \quad (7)$$

Therefore if $H_{r,j}$ is set to 1, then the polynomial must be contained inside the safe region r

$$A_r P_j(t) \leq b_r \quad \forall t \in [0, 1], \quad (8)$$

or

$$A_r \sum_{k=1}^{d+1} C_{j,k} \phi_k(t) \leq b_r \quad \forall t \in [0, 1]. \quad (9)$$

The constraint 9 can be written as m constraints of the form

$$a_{r,l}^T \sum_{k=1}^{d+1} C_{j,k} \phi_k(t) \leq b_{r,l} \quad \forall t \in [0, 1], \quad (10)$$

where

$$A_r = \begin{bmatrix} a_{r,1}^T \\ a_{r,2}^T \\ \vdots \\ a_{r,m}^T \end{bmatrix} \quad \text{and} \quad b = \begin{bmatrix} b_{r,1} \\ b_{r,2} \\ \vdots \\ b_{r,m} \end{bmatrix}. \quad (11)$$

By redistributing the terms in 10, we get:

$$\sum_{k=1}^{d+1} (a_{r,l}^T C_{j,k}) \phi_k(t) \leq b_{r,l} \quad \forall t \in [0, 1], \quad (12)$$

with which we can now define $q(t)$

$$q(t) := b_{r,l} - \sum_{k=1}^{d+1} (a_{r,l}^T C_{j,k}) \phi_k(t) \geq 0 \quad \forall t \in [0, 1]. \quad (13)$$

The polynomial $P_j(t)$ is fully contained in region r if and only if $q(t) \geq 0 \forall t \in [0, 1]$. This holds if and only if $q(t)$ can be written as:

$$q(t) = \begin{cases} t\sigma_1(t) + (1-t)\sigma_2(t) & \text{if } d \text{ is odd} \\ \sigma_1(t) + t(1-t)\sigma_2(t) & \text{if } d \text{ is even} \end{cases} \quad (14)$$

$$\sigma_1(t), \sigma_2(t) \text{ are sums of squares} \quad (15)$$

where $\sigma_1(t)$ and $\sigma_2(t)$ are polynomials of degree $d-1$ if d is odd and of degree d and $d-2$ if d is even. Following the work of Mellinger, we add a quadratic cost function on the squared norm of the snap (the fourth derivative with respect to time) of the trajectory. For polynomials of degree $d \leq 3$, this cost function is instead reduced to the squared norm of the d^{th} derivative of the polynomial.

The full optimization consists of searching over the coefficients of the polynomials and their assignments to safe regions $H_{r,j}$ simultaneously, and is thus a mixed-integer convex program. Specifically, it is a mixed-integer semidefinite program (MISDP) for polynomials of degree $d \geq 4$, or a mixed-integer second-order cone program (MISOCP) for polynomials of degree $d = 3$. In our prior work [3], we found that the MISDP formulation often proved numerically unstable in our solver, Mosek [13]. However we found that the degree 3 MISOCP was generally quite tractable, so for this work we chose to solve the MISOCP to determine the assignment of polynomials to regions of free space, then to fix the binary variables H and solve a single MISDP for a degree-5 polynomial to produce a smooth, minimum-snap trajectory.

V. CONTROLLER DESIGN

There are two main control loops stabilizing the quadrotor. The first one is an attitude controller running entirely on-board the platform. The second one is a state-space controller running off-board using Drake.

The inputs to the on-board attitude controller are the desired Euler angles ϕ_{des} , θ_{des} , ψ_{des} , angular velocities and a nominal squared angular velocity for the propellers ω_0^2 . The attitude controller first maps the nominal squared angular velocity of the propellers to duty cycles for the motors $u_{D,0}$ using a third control loop that accounts for varying battery voltage. The on-board attitude controller computes the error between the current and desired Euler angles e_{rpy} and angular velocities e_w and uses a linear PD controller to stabilize them.

$$u_{D,0} = \frac{V_{max}}{V_{actual}} (\sqrt{\omega_0^2 - \beta}) + \alpha. \quad (16)$$

$$u_D = -K \begin{bmatrix} e_{rpy} \\ e_w \end{bmatrix} + u_{D,0}, \quad (17)$$

where u_D is the input (duty cycles) actually sent to the physical hardware (the motors). V_{max} is the nominal voltage of the battery, V_{actual} is the current battery voltage, α can be interpreted as the minimum duty cycle that must be sent to the hardware in order to get any angular velocity ω with the motors. Parameter β then accounts for the fact that the propellers start out at a certain non-zero velocity.

The off-board controller has the responsibility of tracking the trajectories using a time-varying linear quadratic regulator [14]. First we augment the differentially flat model used by the planning algorithm to take into account the on-board attitude controller. This is done by simply adding a model of the on-board attitude controller (a system that computes propeller square angular velocities from the error between the current and desired euler angles and angular

velocities of the quadrotor) and cascading that system with the differentially flat model. This does not create a state space \mathbf{x} that is different from the differentially flat model in any way but it does generate a new input space and therefore a new feed-forward term $u_0(t)$:

$$u := [\phi_{des} \quad \theta_{des} \quad \psi_{des} \quad \omega_{x,des} \quad \omega_{y,des} \quad \omega_{z,des} \quad \omega_{0,des}], \quad (18)$$

where $\omega_{0,des}$ is an offset squared velocity added to each propeller.

We then define the error dynamics $\bar{\mathbf{x}}(t)$ and $\bar{u}(t)$.

$$\bar{\mathbf{x}}(t) = \mathbf{x}(t) - \mathbf{x}_0(t), \quad (19)$$

$$\bar{u}(t) = u(t) - u_0(t). \quad (20)$$

We can then linearize the plant dynamics $\dot{\mathbf{x}}(t) = f(\mathbf{x}, u)$ around the nominal trajectories and get the following error dynamics

$$\dot{\bar{\mathbf{x}}}(t) = A(t)\bar{\mathbf{x}}(t) + B(t)\bar{u}(t). \quad (21)$$

Now if we define the following quadratic cost on the tracking error

$$J(\mathbf{x}', t') = \int_0^\infty \bar{\mathbf{x}}^T(t) Q \bar{\mathbf{x}}(t) + \bar{u}^T(t) R \bar{u}(t) dt, \quad (22)$$

$$Q = Q^T \geq 0, R = R^T > 0, \mathbf{x}(t) = \mathbf{x}'(t).$$

It can then be shown that the optimal cost-to-go J^* has the form

$$J^*(\bar{\mathbf{x}}, t) = \bar{\mathbf{x}}^T S(t) \bar{\mathbf{x}}, S(t) = S^T(t) \geq 0, \quad (23)$$

where $S(t)$ is the solution to the differential algebraic Riccati equation:

$$-\dot{S} = Q - SBR^{-1}B^T S + SA + A^T S. \quad (24)$$

Although the boundary condition on $S(t)$, i.e. the value of $S(t_f)$ where t_f is the time where the plant reaches the goal state, can be chosen along with the costs Q and R to give the best tracking, or it can be made the same as the infinite-horizon cost if the trajectory ends on a fixed point we want to stabilize.

The result is a time-varying controller $K(t)$ that takes the full state of the quadrotor as input and returns a control input to be sent to the on-board attitude controller.

VI. IMPLEMENTATION DETAILS

Our platform of choice, the Crazyflie Nano Quadcopter, is one of the smallest quadrotors available on the market. It measures 92mm from propeller to propeller and weighs 34g with optical markers mounted on it. It has a flight time of around 5 minutes. Its small size and general safety makes it an ideal candidate for applications that require it to fly near people. However, the small size of the Crazyflie also presents many challenges in using it as a research platform. Indeed, its small inertia requires controllers that can react with very little latency.

The software architecture assembled for our experiment consists of our custom quadrotor firmware, Drake running in MATLAB and a multi-threaded base station that takes

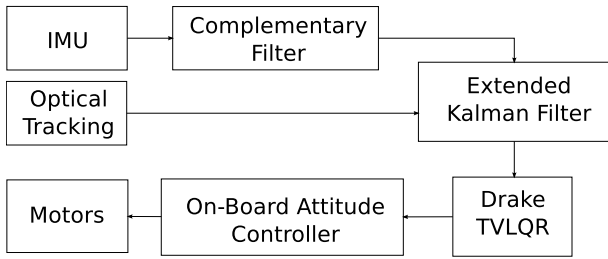

Fig. 3: Functional block diagram of our control system. All of the software runs off-board the quadrotor except for the attitude controller.

care of both the off-board estimation [15] [16] and the communication between the quadrotor and Drake. The various components are linked together using the Lightweight Communications and Marshalling (LCM) library. More details on the software implementation is available in [17]. As required by the license used by Bitcraze (GNU v3) we distribute the entirety of our software online¹.

In order to test our planning and control approaches, we designed a series of obstacle courses of increasing difficulty. Each obstacle field was built with a combination of PVC pipes, plastic fencing and cotton string. We then measured the dimensions of each one of them and entered them in a file using the Unified Robot Description Format (URDF). The URDF, along with Drake, allows us to seamlessly extract convex hull representations of the resulting obstacle fields.

First, we experiment with a simple “forest” simulation, mimicking a series of vertical obstacles. Then we experiment with a few vertical obstacles contained between two “walls” that the quadrotor has to either go over or under. This is particularly challenging for our controller because it makes it easy for the quadrotor to enter a vortex ring state as it travels downward and comes to a zero airspeed in order to accelerate back up. The third course starts to increase the number of obstacles with a total of 11 vertical and angled poles. Finally, an environment made of 6 poles and 20 strings placed in various orientations is used to demonstrate the scalability of our approach. Note that the trajectory in the environment with the strings was built by concatenating shorter trajectories that linked set points on either sides of the obstacle course.

VII. RESULTS

Figures 4 to 8 show the results of running the controllers in the four environments. As it can be seen from the plots, IRIS, MISDPs and model-based control approaches are indeed capable of flying a small quadrotor like the Crazyflie through environments that are densely populated with obstacles, confirming our hypothesis. The number of obstacles we used ranged from 5 to 26, all contained within a cubic meter volume or so. The plots also show how our controller was capable of tracking the trajectories with errors that did not

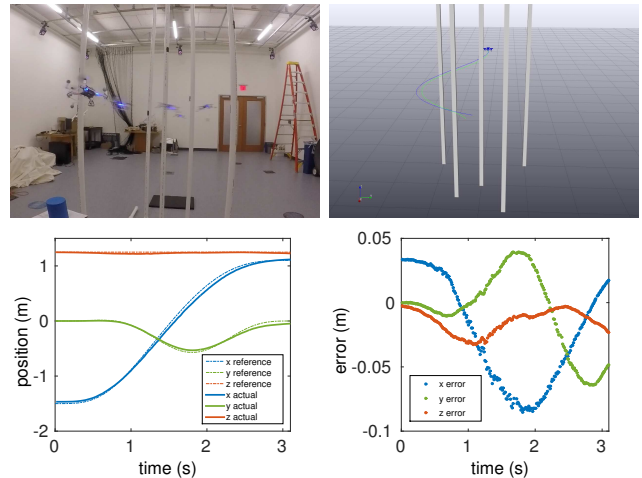

Fig. 4: Top left is a composite picture of the quadrotor executing the planned trajectory through the “forest” environment. Top right overlays the planned and executed trajectory for this environment. Bottom left shows the tracking of position over time and bottom right the corresponding error.

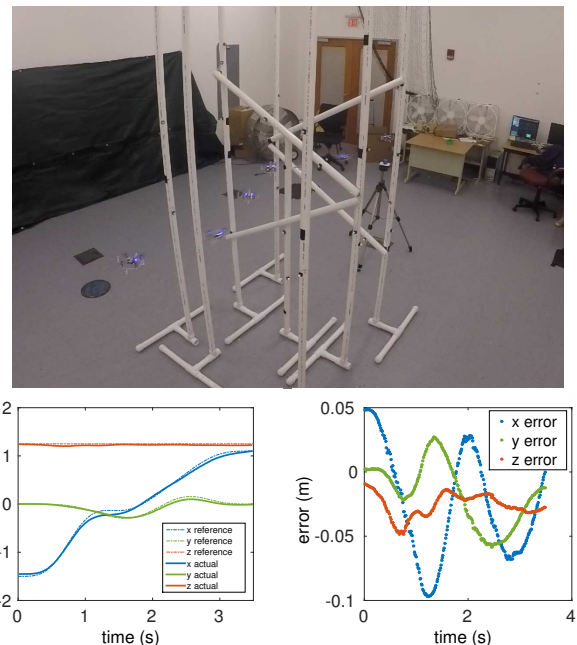

Fig. 5: Top is a composite picture of the quadrotor executing the planned trajectory through the environment containing 11 poles. Bottom left shows the tracking of position over time and bottom right the corresponding error.

¹<https://github.com/blandry/crazyflie-tools>

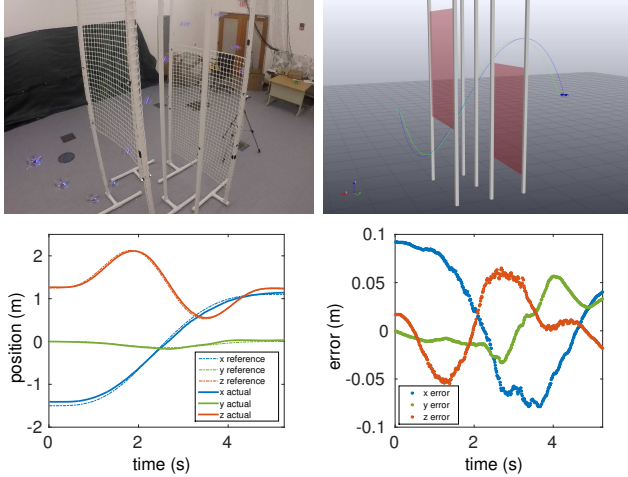

Fig. 6: Top left is a composite picture of the quadrotor executing the planned trajectory through the “walls” environment. Top right overlays the planned and executed trajectory for this environment. Bottom left shows the tracking of position over time and bottom right the corresponding error.

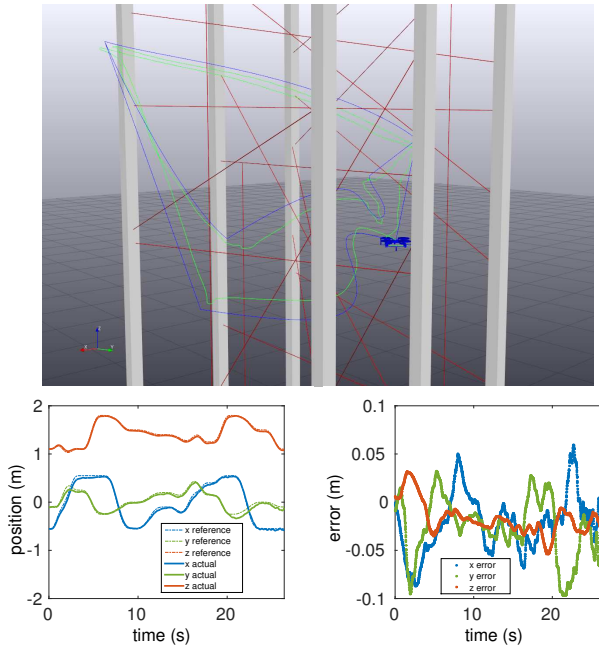

Fig. 7: Top is a computer rendering of the environment containing 20 strings and six poles. The rendering overlays the planned (blue) and executed (green) trajectories. Bottom left shows the tracking of position over time and bottom right the corresponding error.

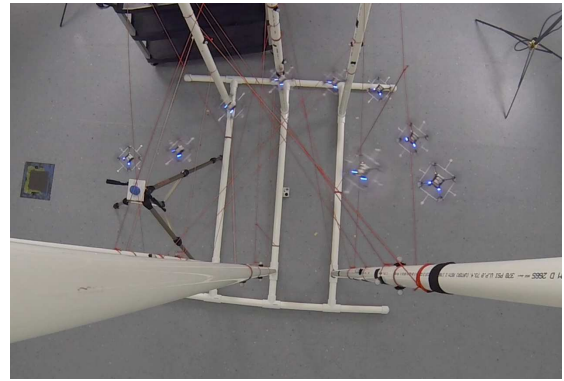

Fig. 8: A picture of the obstacle field containing 20 strings and 6 poles taken from the top. A composite of the quadrotor flying the first part of the trajectory is shown.

deviate from the planned trajectories by more than 10cm or so, and that were lower than that on average.

We found that the limitation of the planning algorithm lies in the number of obstacle-free regions that can be handled efficiently by the mixed-integer program, although this limitation only appeared once we reached a significant number of obstacles like with the environment containing 20 strings and 6 poles. In this case, we also found that using a feasible but not necessarily optimal trajectory returned by the solver was highly sufficient to complete the task. The planning algorithm took on average about 10 minutes to return a solution for the most crowded environments. A few seeds were usually manually added toward the center of the obstacle field in order to increase the density of segments in that area, but we relied on the heuristic based automatic seeding described in [3] for most of them.

We also unsurprisingly found that the quality of the tracking depended on the speed at which we were executing the trajectories. This turned out to be more of a challenge than expected, because there was no analytical way to compute a maximal velocity for a given trajectory and controller.

We also found that TVLQR performed reasonably well for this task. However the results give us good reasons to believe that time might not be the best dimension to parametrize over. We believe that better performance could be produced by transverse LQR [18], where the parameter would be the tangential velocity of the tracked trajectory instead of time. This controller would be closer in spirit to what was demonstrated in [7].

We also attempted to run the trajectories with the attitude controller in Drake (producing a completely off-board controller). Even though we were able to track trajectories with a certain level of success with this approach, we found that moving the attitude controller off-board added a significant amount of instability to the system. Indeed errors in roll and pitch quickly take the quadrotor into unstable states if this particular control loop is not running quickly enough (at least around 100Hz in the case of the Crazyflie).

Video recordings of the trajectories being flown are avail-

able on our group's Youtube channel².

VIII. CONCLUSION AND FUTURE WORK

We demonstrated experimental validation of the algorithm originally proposed by Deits to generate collision-free trajectories in obstacle-dense environments. This confirmed our hypothesis that it would be possible to fly a small quadrotor like the Crazyflie through environments containing significantly more obstacles than demonstrated in the past using IRIS, MISDPs and model-based control. The most cluttered environment we flew the quadrotor through contained 26 obstacles in a cubic meter volume and the quadrotor was able to follow a collision-free trajectory through it within 10cm of precision.

In the future, we would like to develop a method to derive the maximum speed at which a given control system could execute the planned trajectory, perhaps using a parametric funnels approach [19]. We are also interested in improving the quality of our trajectory tracking, with transverse LQR potentially being a great improvement to time-varying LQR.

ACKNOWLEDGMENT

The authors would like to acknowledge Anirudha Majumdar for his constant guidance and support throughout the duration of this project. Also Andy Barry for his extremely valuable advice on our hardware and firmware development. Benoit Landry is also partially supported by the Siebel Scholars Foundation.

REFERENCES

- [1] D. Mellinger, A. Kushleyev, and V. Kumar, "Mixed-integer quadratic program trajectory generation for heterogeneous quadrotor teams," in *Robotics and Automation (ICRA), 2012 IEEE International Conference on*. IEEE, 2012, pp. 477–483.
- [2] T. Schouwenaars, B. De Moor, E. Feron, and J. How, "Mixed integer programming for multi-vehicle path planning," in *European control conference*, vol. 1. Citeseer, 2001, pp. 2603–2608.
- [3] R. Deits and R. Tedrake, "Efficient mixed-integer planning for uavs in cluttered environments," 2014.
- [4] R. Tedrake, "Drake: A planning, control, and analysis toolbox for nonlinear dynamical systems," 2014. [Online]. Available: <http://drake.mit.edu>
- [5] C. Richter, A. Bry, and N. Roy, "Polynomial trajectory planning for quadrotor flight," in *International Conference on Robotics and Automation*, 2013.
- [6] R. L. Deits, "Convex segmentation and mixed-integer footstep planning for a walking robot," Ph.D. dissertation, Massachusetts Institute of Technology, 2014.
- [7] D. Mellinger, N. Michael, and V. Kumar, "Trajectory generation and control for precise aggressive maneuvers with quadrotors," *The International Journal of Robotics Research*, p. 0278364911434236, 2012.
- [8] G. M. Hoffmann, S. L. Waslander, and C. J. Tomlin, "Quadrotor helicopter trajectory tracking control," in *AIAA Guidance, Navigation and Control Conference and Exhibit*, 2008, pp. 1–14.
- [9] A. J. Barry, "Flying between obstacles with an autonomous knife-edge maneuver," Ph.D. dissertation, Massachusetts Institute of Technology, 2012.
- [10] D. Mellinger and V. Kumar, "Minimum snap trajectory generation and control for quadrotors," in *Robotics and Automation (ICRA), 2011 IEEE International Conference on*. IEEE, 2011, pp. 2520–2525.
- [11] R. Deits and R. Tedrake, "Computing large convex regions of obstacle-free space through semidefinite programming," in *Workshop on the Algorithmic Fundamentals of Robotics (WAFR), Istanbul, Turkey*, 2014.
- [12] P. A. Parrilo, "Sums of squares and semidefinite programming," mar 2006. [Online]. Available: http://ocw.mit.edu/courses/electrical-engineeringandcomputerscience/6972algebraictechniquesand-semidefiniteoptimizationspring2006/lecturenotes/lecture_10.pdf
- [13] Mosek ApS, "The MOSEK optimization software," 2014. [Online]. Available: <http://www.mosek.com/>
- [14] R. Tedrake, "Lqr-trees: Feedback motion planning on sparse randomized trees," 2009.
- [15] S. O. Madgwick, "An efficient orientation filter for inertial and inertial/magnetic sensor arrays," *Report x-io and University of Bristol (UK)*, 2010.
- [16] M. Bloesch, M. Hutter, M. A. Hoepflinger, S. Leutenegger, C. Gehring, C. D. Remy, and R. Siegwart, "State estimation for legged robots-consistent fusion of leg kinematics and imu," *Robotics*, p. 17, 2013.
- [17] B. Landry, "Planning and control for quadrotor flight through cluttered environments," Master's thesis, Massachusetts Institute of Technology, 2015.
- [18] I. R. Manchester, "Transverse dynamics and regions of stability for nonlinear hybrid limit cycles," *arXiv preprint arXiv:1010.2241*, 2010.
- [19] A. Majumdar, M. Tobenkin, and R. Tedrake, "Algebraic verification for parameterized motion planning libraries," in *American Control Conference (ACC), 2012*. IEEE, 2012, pp. 250–257.

²<https://www.youtube.com/watch?v=v-s564NoAu0>