



MIT Open Access Articles

Heat transfer in flat-plate boundary layers: a correlation for laminar, transitional, and turbulent flow

The MIT Faculty has made this article openly available. **Please share** how this access benefits you. Your story matters.

Citation	Lienhard, John H., V, "Heat transfer in flat-plate boundary layers: a correlation for laminar, transitional, and turbulent flow." Journal of Heat Transfer 142, 6 (June 2020): no. 061805 doi 10.1115/1.4046795 ©2020 Author(s)
As Published	10.1115/1.4046795
Publisher	ASME
Version	Final published version
Citable link	https://hdl.handle.net/1721.1/124894
Terms of Use	Creative Commons Attribution 4.0 International license
Detailed Terms	https://creativecommons.org/licenses/by/4.0/

Heat transfer in flat-plate boundary layers: a correlation for laminar, transitional, and turbulent flow

John H. Lienhard V

Rohsenow Kendall Heat Transfer Lab
Massachusetts Institute of Technology
Cambridge MA 02139-4307 USA

Journal of Heat Transfer, **142**(6): 061805, June 2020
doi: 10.1115/1.4046795



Oversimplified model of boundary layer transition

Used in many textbooks and in Whitaker's correlation (AIChE J. 18(2) 1972)

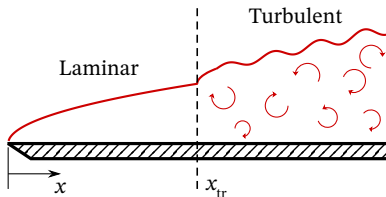

Boundary layer is described as having a "transition Reynolds number." Equations are given for laminar b.l. and for turbulent b.l.

$$\bar{h} = \frac{1}{L\Delta T} \int_0^L q_w dx$$
$$= \frac{1}{L} \left[\int_0^{x_{tr}} h_{lam} dx + \int_{x_{tr}}^L h_{turb} dx \right]$$

Use a turbulent correlation (more on this...) and laminar theory (and more on this...)

$$\overline{Nu}_L \equiv \frac{\bar{h}L}{k} = 0.036 Pr^{0.43} (Re_L^{0.8} - Re_{tr}^{0.8}) + 0.664 Re_{tr}^{1/2} Pr^{1/3}$$

Whitaker's equation (assign $Re_{tr} = 200,000$, and add variable properties factor)

$$\overline{Nu}_L = 0.036 Pr^{0.43} (Re_L^{0.8} - 9,200) \left(\frac{\mu_w}{\mu_0} \right)^{1/4}$$

How transitional boundary layer data actually look

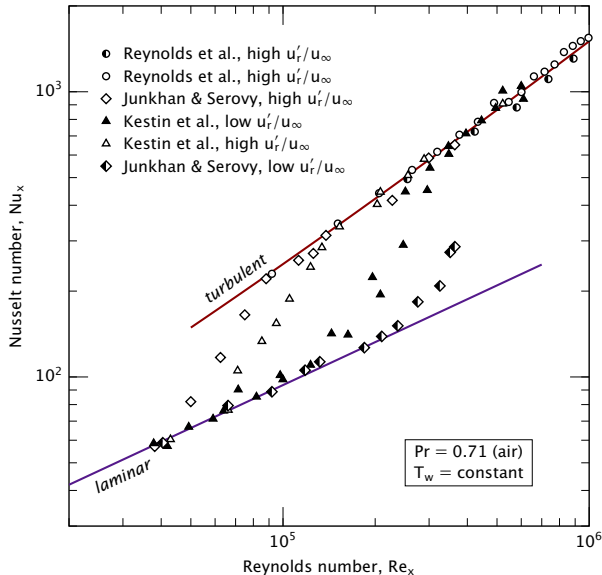

More realistic model of boundary layer transition

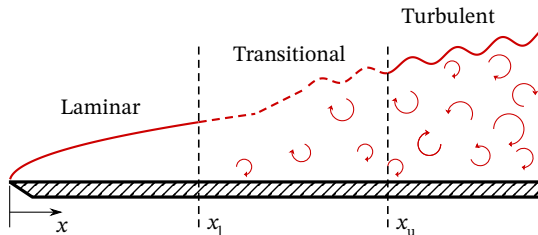

Transition begins at x_l and ends at x_u . Laminar and transition regions have similar length.

Heat transfer coefficient through the transition region

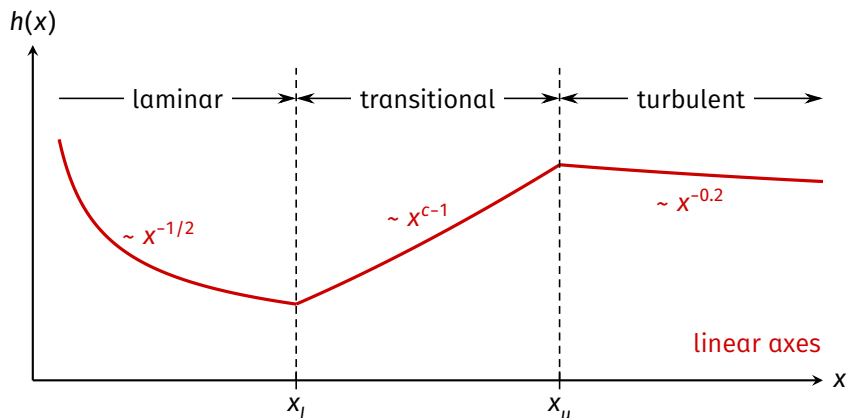

- Transition region has length similar to laminar region
- Transition has been observed to begin for $4 \times 10^4 \leq Re_l \leq 2.8 \times 10^6$
- The exponent in the transition zone, c , ranges from 1.4 to 6

Churchill's concept: *AIChE J.* 22(2) 1976

Building on Churchill and Ozoe (1973) and Churchill and Usagi (1972)

$$\text{Nu}_x = \text{Nu}_0 + \left[\text{Nu}_{\text{lam}}^s + \left(\text{Nu}_{\text{trans}}^p + \text{Nu}_{\text{turb}}^p \right)^{s/p} \right]^{1/s} \quad \text{with} \quad \begin{cases} p = -5 \\ s = 2 \end{cases}$$

Churchill's concept: *AIChE J.* 22(2) 1976

Building on Churchill and Ozoe (1973) and Churchill and Usagi (1972)

$$\text{Nu}_x = \text{Nu}_0 + \left[\text{Nu}_{\text{lam}}^s + \left(\text{Nu}_{\text{trans}}^p + \text{Nu}_{\text{turb}}^p \right)^{s/p} \right]^{1/s} \quad \text{with} \quad \begin{cases} p = -5 \\ s = 2 \end{cases}$$

- Very low Reynolds number limit, $\text{Nu}_0 = 0.45$

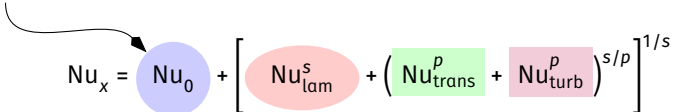

The diagram shows the equation $\text{Nu}_x = \text{Nu}_0 + \left[\text{Nu}_{\text{lam}}^s + \left(\text{Nu}_{\text{trans}}^p + \text{Nu}_{\text{turb}}^p \right)^{s/p} \right]^{1/s}$ with the following highlights: Nu_0 is in a blue circle, Nu_{lam}^s is in a pink oval, $\text{Nu}_{\text{trans}}^p$ is in a green rectangle, and $\text{Nu}_{\text{turb}}^p$ is in a pink rectangle. A black arrow points from the text above to the blue circle.

$$\text{Nu}_x = \text{Nu}_0 + \left[\text{Nu}_{\text{lam}}^s + \left(\text{Nu}_{\text{trans}}^p + \text{Nu}_{\text{turb}}^p \right)^{s/p} \right]^{1/s}$$

Churchill's concept: *AIChE J.* 22(2) 1976

Building on Churchill and Ozoe (1973) and Churchill and Usagi (1972)

$$\text{Nu}_x = \text{Nu}_0 + \left[\text{Nu}_{\text{lam}}^s + \left(\text{Nu}_{\text{trans}}^p + \text{Nu}_{\text{turb}}^p \right)^{s/p} \right]^{1/s} \quad \text{with} \quad \begin{cases} p = -5 \\ s = 2 \end{cases}$$

- Very low Reynolds number limit, $\text{Nu}_0 = 0.45$

The diagram shows the equation $\text{Nu}_x = \text{Nu}_0 + \left[\text{Nu}_{\text{lam}}^s + \left(\text{Nu}_{\text{trans}}^p + \text{Nu}_{\text{turb}}^p \right)^{s/p} \right]^{1/s}$. The term Nu_0 is enclosed in a blue circle. The term Nu_{lam}^s is enclosed in a red oval. The terms $\text{Nu}_{\text{trans}}^p$ and $\text{Nu}_{\text{turb}}^p$ are enclosed in green and pink boxes, respectively. An arrow points from the text 'Very low Reynolds number limit, $\text{Nu}_0 = 0.45$ ' to the blue circle. Another arrow points from the text 'Laminar correlation' to the red oval.

- Laminar correlation

$$\text{Nu}_{\text{lam}} = 0.3387 \phi^{1/2} \quad \text{with} \quad \phi \equiv \text{Re}_x \text{Pr}^{2/3} \left[1 + \left(\frac{0.0468}{\text{Pr}} \right)^{2/3} \right]^{-1/2}$$

for $0 < \text{Pr} < \infty$

Churchill's concept: *AIChE J.* 22(2) 1976

Building on Churchill and Ozoe (1973) and Churchill and Usagi (1972)

$$Nu_x = Nu_0 + \left[Nu_{\text{lam}}^s + (Nu_{\text{trans}}^p + Nu_{\text{turb}}^p)^{s/p} \right]^{1/s} \quad \text{with } \begin{cases} p = -5 \\ s = 2 \end{cases}$$

- Very low Reynolds number limit, $Nu_0 = 0.45$

$$Nu_x = Nu_0 + \left[Nu_{\text{lam}}^s + (Nu_{\text{trans}}^p + Nu_{\text{turb}}^p)^{s/p} \right]^{1/s}$$

The diagram shows the equation with four terms highlighted in colored boxes: Nu_0 in a blue circle, Nu_{lam}^s in a red oval, Nu_{trans}^p in a green box, and Nu_{turb}^p in a pink box. Arrows point from the text descriptions below to these terms.

- Laminar correlation
- Transition correlation

$$Nu_{\text{trans}} = b Re_x^{3/2} \quad \text{i.e., } c = 3/2 \text{ with } b \text{ fit to the end of transition, } Re_u$$

Churchill's concept: *AIChE J.* 22(2) 1976

Building on Churchill and Ozoe (1973) and Churchill and Usagi (1972)

$$Nu_x = Nu_0 + \left[Nu_{\text{lam}}^s + (Nu_{\text{trans}}^p + Nu_{\text{turb}}^p)^{s/p} \right]^{1/s} \quad \text{with } \begin{cases} p = -5 \\ s = 2 \end{cases}$$

- Very low Reynolds number limit, $Nu_0 = 0.45$

$$Nu_x = Nu_0 + \left[Nu_{\text{lam}}^s + (Nu_{\text{trans}}^p + Nu_{\text{turb}}^p)^{s/p} \right]^{1/s}$$

The diagram shows the equation with color-coded terms: Nu_0 is in a blue circle, Nu_{lam}^s is in a red oval, Nu_{trans}^p is in a green box, and Nu_{turb}^p is in a pink box. Arrows point from the text descriptions below to these terms.

- Laminar correlation
- Transition correlation
- Turbulent correlation

$$Nu_{\text{turb}} \approx 0.032 \phi^{4/5} \quad \text{with } \phi \text{ as for laminar flow}$$

Churchill's concept: *AIChE J.* 22(2) 1976

Building on Churchill and Ozoe (1973) and Churchill and Usagi (1972)

$$\text{Nu}_x = \text{Nu}_0 + \left[\text{Nu}_{\text{lam}}^s + \left(\text{Nu}_{\text{trans}}^p + \text{Nu}_{\text{turb}}^p \right)^{s/p} \right]^{1/s} \quad \text{with} \quad \begin{cases} p = -5 \\ s = 2 \end{cases}$$

- Very low Reynolds number limit, $\text{Nu}_0 = 0.45$

The diagram shows the Churchill correlation equation with components highlighted in colored ovals: Nu_0 (blue), Nu_{lam}^s (red), $\text{Nu}_{\text{trans}}^p$ (green), and $\text{Nu}_{\text{turb}}^p$ (pink). Arrows point from the text below to these components.

$$\text{Nu}_x = \text{Nu}_0 + \left[\text{Nu}_{\text{lam}}^s + \left(\text{Nu}_{\text{trans}}^p + \text{Nu}_{\text{turb}}^p \right)^{s/p} \right]^{1/s}$$

- Laminar correlation
- Transition correlation
- Turbulent correlation
- Churchill made an aggregate comparison to some local data, using the ϕ variable, but with only limited agreement.

Churchill's correlation compared to individual data sets

Local Nu_x data for air and water from several independent studies

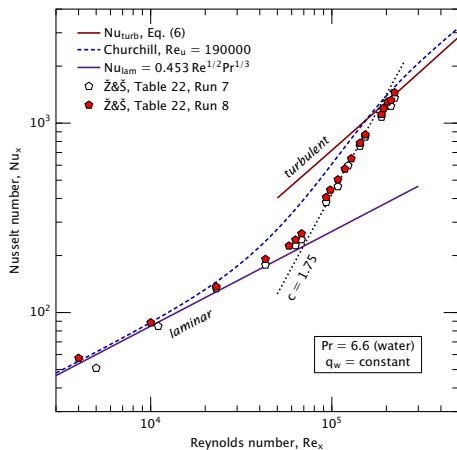
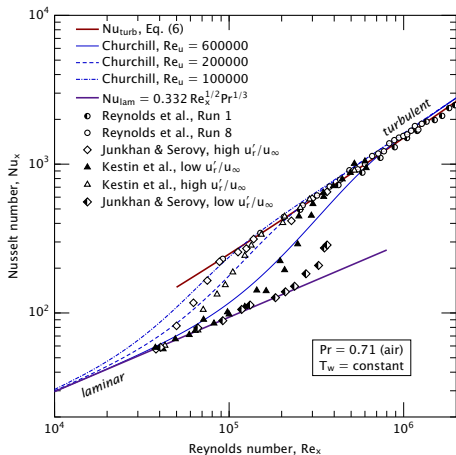

Churchill's correlation compared to individual data sets

Local Nu_x data for air and water from several independent studies

Churchill's approach needs adjustments

- change from laminar to transitional slope and from transitional to turbulent slope should be faster
- constant 0.45 is not important
- transition region's slope (c) should be greater and variable
- turbulent Nu should be lower

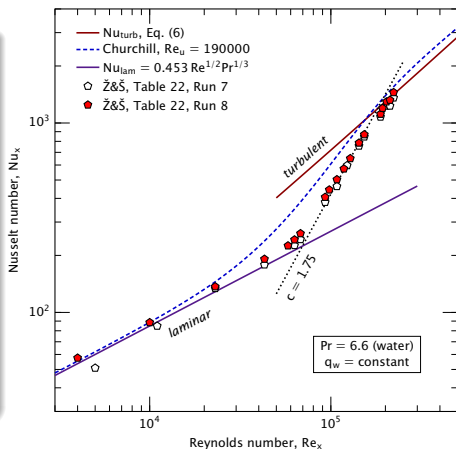

Correlating the laminar regime

Experimental support for Blasius b.l. is excellent.

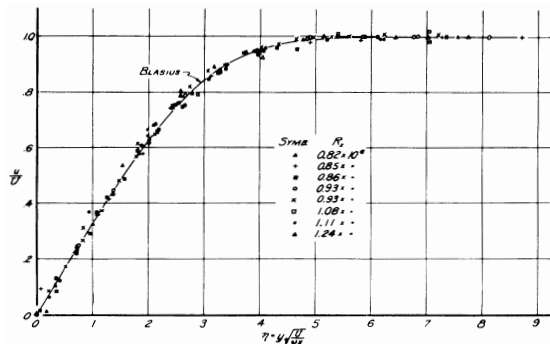

Measurements by
Hans W. Liepmann, 1943
(NACA WR-107)

There's not much need to include liquid metals, so just use theoretical results for gases and dielectric liquids

$$Nu_{\text{lam}} = \begin{cases} 0.332 Re_x^{1/2} Pr^{1/3} & \text{for UWT} \\ 0.453 Re_x^{1/2} Pr^{1/3} & \text{for UHF} \end{cases} \quad \text{for } Pr \geq 0.6$$

This approach eliminates Churchill's ϕ variable.

Laminar boundary layers in lab are not ideal

Seban & Doughty (1956)

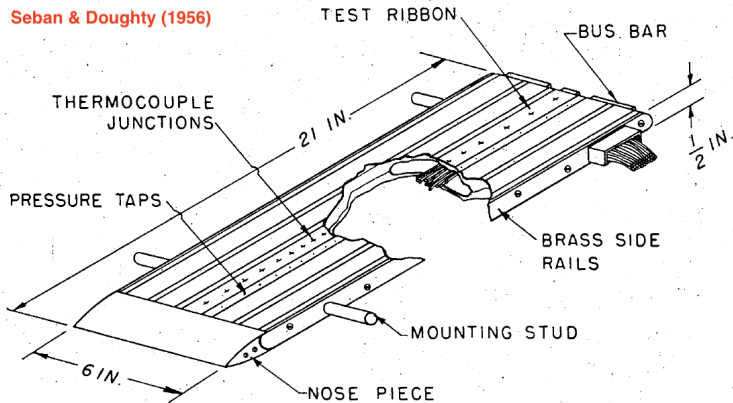

Kestin et al. (1961)

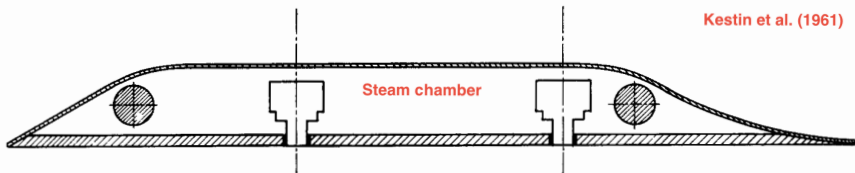

Suction slots sometimes used to remove upstream b.l.

Analytical correction factors have often been applied to the measurements

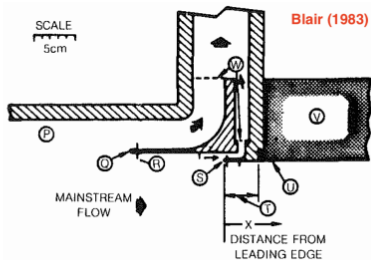
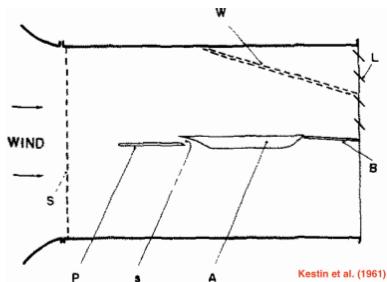

Fig. 2 Test wall leading edge bleed scoop



Suction slots sometimes used to remove upstream b.l.

Analytical correction factors have often been applied to the measurements

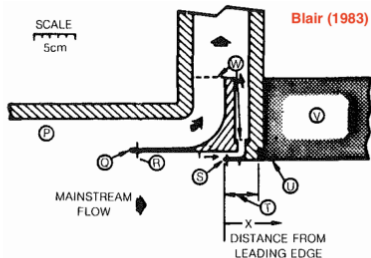
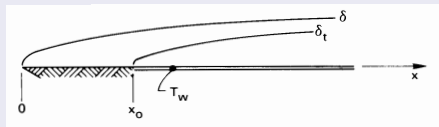

Fig. 2 Test wall leading edge bleed scoop

Edwards & Furber (1956)

Unheated Starting Length



$$Nu_x^{UWT} = 0.332 Re_x^{1/2} Pr_x^{1/3} [1 - (x_0/x)^{3/4}]^{-1/3}$$

Nusselt number, Nu	Configuration factor, F	Corrected Nusselt number, Nu_c	Rn/R
5,220	1.22	4,290	
4,460	1.22	3,660	
3,600	1.23	2,930	
3,230	1.24	2,600	
2,830	1.24	2,280	
2,610	1.24	2,100	
1,925	1.26	1,530	
980	1.30	753	
587	1.35	435	
280	1.75	160	

Uniform wall heat flux with unheated starting length

Tribus & Klein (1952) gave this integral

$$T_w - T_\infty = A(x) \int_0^x \left[1 - \left(\frac{\xi}{x} \right)^{3/4} \right] q_w(\xi) d\xi$$

$A(x) = C/k\text{Re}_x^{1/2}\text{Pr}_x^{1/3}$ and $C = 0.624065$. For

$$q_w(x) = \begin{cases} 0 & \text{for } x < x_0 \\ q_0 & \text{for } x \geq x_0 \end{cases}$$

$$\frac{T_w - T_\infty}{A(x)q_0} = \int_{x_0}^x \left[1 - \left(\frac{\xi}{x} \right)^{3/4} \right] d\xi$$

Setting $u = 1 - (\xi/x)^{3/4}$, $u_0 = 1 - (x_0/x)^{3/4}$, and $s = u/u_0$, some algebra leads to:

$$\frac{3(T_w - T_\infty)}{4xA(x)q_0u_0^{1/3}} = I(u_0) \equiv \int_0^1 s^{-2/3}(1 - u_0s)^{1/3} ds$$

$$\text{Nu}_x^{\text{UHF}} \equiv \frac{q_0x}{(T_w - T_\infty)k} = \frac{3\text{Re}_x^{1/2}\text{Pr}_x^{1/3}}{4Cu_0^{1/3}I(u_0)}$$

We can bound the integral $I(u_0)$:

$$I(u_0) \leq I(0) = \int_0^1 s^{-2/3} ds = 3$$

$$\begin{aligned} I(u_0) &\geq I(1) = \int_0^1 s^{-2/3}(1-s)^{1/3} ds \\ &= \frac{\Gamma(1/3)\Gamma(4/3)}{\Gamma(5/3)} = 2.649958 \dots \end{aligned}$$

These bounds are tight. If we say $I(u_0) \simeq I(1)$

$$\begin{aligned} \text{Nu}_x^{\text{UHF}} &\simeq \frac{3\text{Re}_x^{1/2}\text{Pr}_x^{1/3}}{4Cu_0^{1/3}I(1)} \\ &= 0.4535 \frac{\text{Re}_x^{1/2}\text{Pr}_x^{1/3}}{\left[1 - (x_0/x)^{3/4} \right]^{1/3}} \end{aligned}$$

The approximation is bounded within 12% right up to x_0 . (Note $x_0 = 0$ is a UHF plate.)

Correlating the transition regime

The experimentally observed behavior is:

$$\text{Nu}_{\text{trans}} = b \text{Re}_x^c$$

b may be fixed by Nu_{lam} at the Reynolds number where the transition curve intersects the laminar curve, Re_l :

$$\text{Nu}_{\text{trans}} = \text{Nu}_{\text{lam}}(\text{Re}_l, \text{Pr}) \left(\text{Re}_x / \text{Re}_l \right)^c$$

Churchill put $c = 3/2$, and Žukauskas and Šlančiauskas put $c = 1.4$. However, our comparison to data shows c range from 1.4 to 6, rising as Re_l rises.

We will fit c as a function of Re_l .

Correlating turbulence: Classical Colburn analogy?

Data for boundary layers from Colburn (1933), Chilton and Colburn (1934)

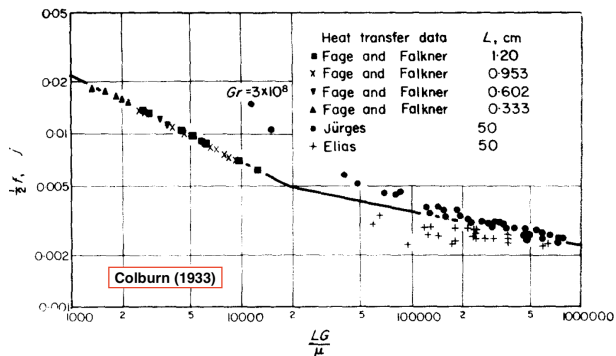

$$St = \frac{C_f}{2} Pr^{-2/3}$$

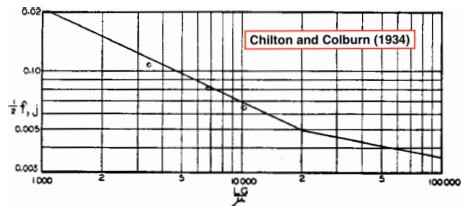

Correlating turbulence: Classical Colburn analogy?

Data for boundary layers from Colburn (1933), Chilton and Colburn (1934)

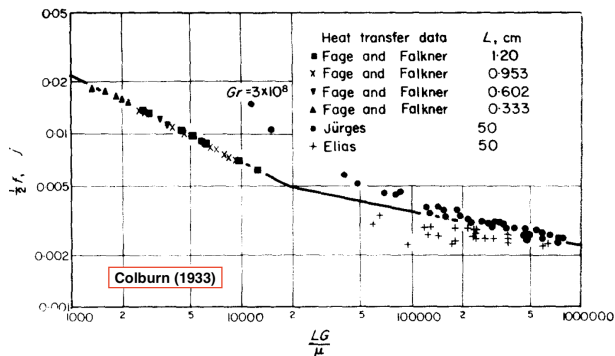

$$St = \frac{C_f}{2} Pr^{-2/3}$$

Concerns

- All data are for air
- Only average h
- Just 2 laminar and 2 turbulent expts.
- Laminar analogy is for **UWT** (Pohlhausen, 1921)
- **Data of Fage & Falkner (1931)...**

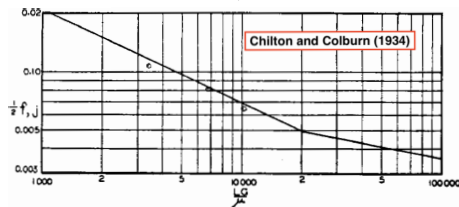

Jakob & Dow, *Trans. ASME*, 1946

The Colburn analogy does not account for a non-uniform wall temperature distribution. Neither Jakob nor Colburn recognized that laminar h is different for UWT and UHF!

range.

Colburn (25) accepted Pohlhausen's equation and made a correlation according to which Fage and Falkner's results would be in agreement with this equation. Because we had found their values to be 27 per cent too high, we asked Dr. Colburn for an explanation of this discrepancy, and he found that due to a slide-rule error, all points representing Fage and Falkner's values in his Fig. 20 should be raised by 21 per cent. This explains the greatest part of the mentioned difference.



Fage & Falkner report (ARC R&M 1408, 1931)

Laminar b.l. on an electrically heated plate. Uniform wall heat flux (not uniform temperature)

ON HEAT TRANSFER AND SURFACE FRICTION.

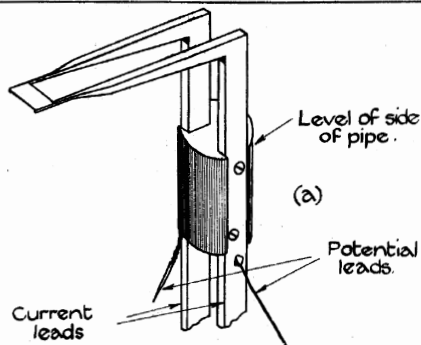

Dimensions in cms.

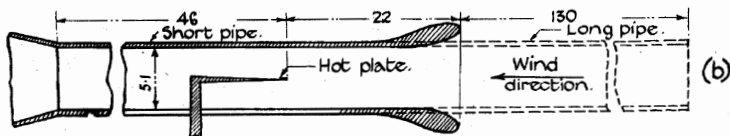
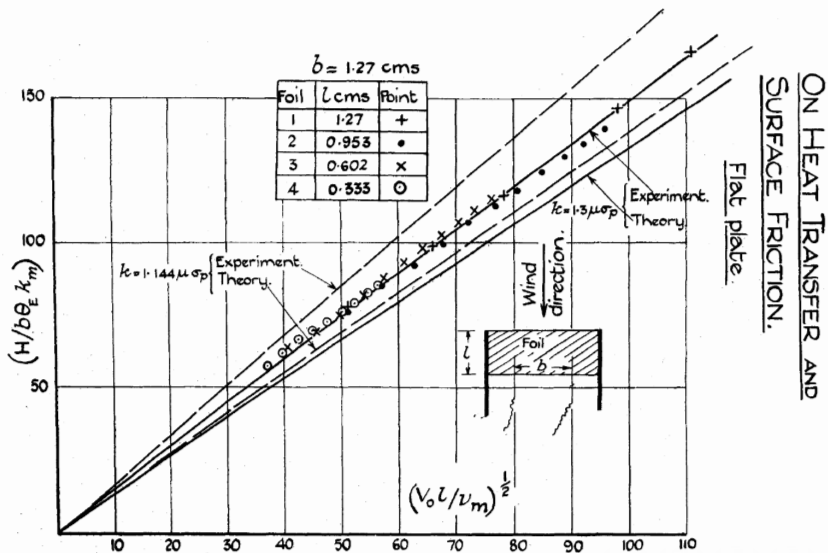

Fig. 12.

Fage & Falkner report (ARC R&M 1408, 1931)

Laminar b.l. on an electrically heated plate. Uniform wall heat flux (not uniform temperature)



R&M. 1408.

FIG. 3.

Similarity solutions for uniform heat flux ($\Delta T \sim x^{1/2}$)

Fage & Falkner (1931) found the similarity solution for $\Delta T \sim x^n$, but the first numerical integrations for $n = 1/2$ (UHF) were due to Sugawara et al. (1951) and Levy (1952). Fitting Levy's results ($Pr = 0.7, 2, 10, 20$):

$$Nu_x = 0.4542 Re_x^{1/2} Pr^{0.3301}$$

Imai (1958) solved o.d.e. asymptotically for high Pr :

$$\frac{Nu_x}{Re_x^{1/2}} = \frac{\Gamma(2/3)A^{1/3}}{2^{1/2} 3^{2/3} \Gamma(4/3)} \text{ with } A = (1/2 + 2n)\sqrt{2}(0.33206)Pr$$

For $n = 1/2$:

$$Nu_x = 0.4587 Re_x^{1/2} Pr^{1/3}$$

Fage & Falkner's experimental values for air fit well to $\overline{Nu}_L = 0.75 Re_L^{1/2}$, with $T_{w,av}/T_\infty = 1.45$, and k_{mean} that is 12% lower than the modern value. Their experiments are within +9% of Imai; if corrected for property variation as $(T_{w,av}/T_\infty)^{-0.4}$, the agreement is -6%.

Local boundary layer heat transfer data

Literature review shows:

- Almost all measurements are in air
- Before 1950, most data are for *average* heat transfer coefficient
- Many well-defined wind-tunnel studies after about 1950
- Only **two water data sets** and the transformer oil data of Ž & Š
- Freestream turbulence is not often described well

To correlate the turbulent section of the b.l. despite the lack of liquid data, we may take advantage of the law-of-the-wall and the wealth of **pipe-flow data** spanning huge range of Pr

Universal velocity distribution (Clauser, 1956)

$$u/u_* = fn(yu_*/\nu) \text{ where } u_* = \sqrt{\tau_w/\rho}$$

Local shear stress (as f or C_f) determines velocity distribution near the wall.

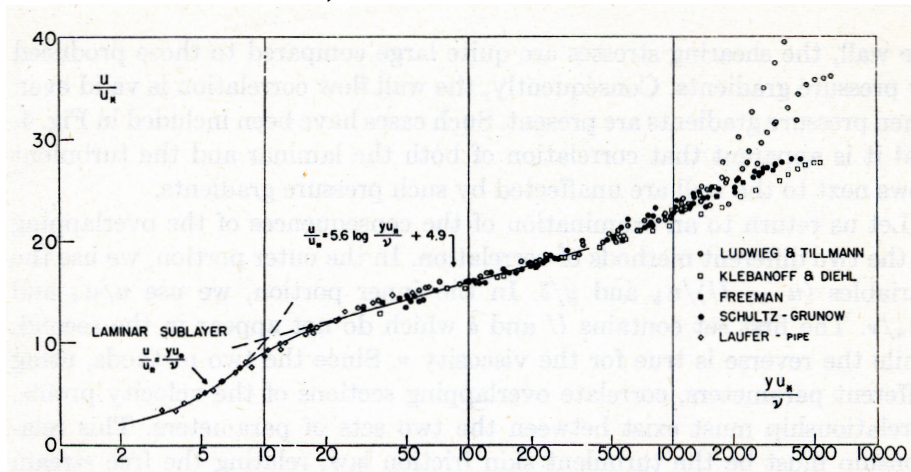

Generalized Reynolds-Colburn analogy

$$St = \frac{Nu_x}{Re_x Pr} = \frac{C_f/2}{a_1 + a_2(Pr^{a_3} - 1)\sqrt{C_f/2}}$$

Authors	Flow	a_1	a_2	a_3
PRANDTL (1928)	pipe flow	1	8.77	1
PETUHKOV & KIRILLOV (1958)	pipe flow	1.07	12.7	2/3
ŽUKAUSKAS & ŠLANČIAUSKAS (1987 summary of older work)	flat plate	0.93	12.5	2/3
WHITE (1974)	flat plate	1	12.8	0.68
GNIELINSKI (1976)	pipe flow	1	12.7	2/3

Gnielinski examined thousands of data points in pipe flow, for $0.6 \leq Pr \leq 10^5$, and his values capture 90% of the liquid data to $\pm 20\%$, and better for gases.

Generalized Reynolds-Colburn analogy

$$St = \frac{Nu_x}{Re_x Pr} = \frac{C_f/2}{1 + 12.7(Pr^{2/3} - 1)\sqrt{C_f/2}}$$

Authors	Flow	a_1	a_2	a_3
PRANDTL (1928)	pipe flow	1	8.77	1
PETUHKOV & KIRILLOV (1958)	pipe flow	1.07	12.7	2/3
ŽUKAUSKAS & ŠLANČIAUSKAS (1987 summary of older work)	flat plate	0.93	12.5	2/3
WHITE (1974)	flat plate	1	12.8	0.68
GNIELINSKI (1976)	pipe flow	1	12.7	2/3

Gnielinski examined thousands of data points in pipe flow, for $0.6 \leq Pr \leq 10^5$, and his values capture 90% of the liquid data to $\pm 20\%$, and better for gases.

We adopt Gnielinski's coefficients.

Correlating fully turbulent flow

$$\text{Nu}_{\text{turb}} = \frac{\text{Re}_x \text{Pr} (C_f/2)}{1 + 12.7(\text{Pr}^{2/3} - 1)\sqrt{C_f/2}} \quad \text{for } \text{Pr} \geq 0.6 \quad (6)$$

Skin friction coefficient, C_f , from White's b.l. formula (accuracy of 1-2%):

$$C_f(x) = \frac{0.455}{[\ln(0.06 \text{Re}_x)]^2}$$

Correlating fully turbulent flow

$$\text{Nu}_{\text{turb}} = \frac{\text{Re}_x \text{Pr} (C_f/2)}{1 + 12.7(\text{Pr}^{2/3} - 1)\sqrt{C_f/2}} \quad \text{for } \text{Pr} \geq 0.6 \quad (6)$$

Skin friction coefficient, C_f , from White's b.l. formula (accuracy of 1-2%):

$$C_f(x) = \frac{0.455}{[\ln(0.06 \text{Re}_x)]^2}$$

For gases, the b.l. power-law of Reynolds et al. is close:

$$\text{Nu}_{\text{turb}} = 0.0296 \text{Re}_x^{0.8} \text{Pr}^{0.6} \quad \text{for gases}$$

Correlating fully turbulent flow

$$\text{Nu}_{\text{turb}} = \frac{\text{Re}_x \text{Pr} (C_f/2)}{1 + 12.7(\text{Pr}^{2/3} - 1)\sqrt{C_f/2}} \quad \text{for } \text{Pr} \geq 0.6 \quad (6)$$

Skin friction coefficient, C_f , from White's b.l. formula (accuracy of 1-2%):

$$C_f(x) = \frac{0.455}{[\ln(0.06 \text{Re}_x)]^2}$$

For gases, the b.l. power-law of Reynolds et al. is close:

$$\text{Nu}_{\text{turb}} = 0.0296 \text{Re}_x^{0.8} \text{Pr}^{0.6} \quad \text{for gases}$$

Žukauskas & Šlančiauskas correlated their own data to roughly $\pm 15\%$:

$$\text{Nu}_{\text{turb}} = 0.032 \text{Re}_x^{0.8} \text{Pr}^{0.43}$$

However, we will see that agreement with other data sets is **not** so good.

Blending the regions

Follow Churchill, but with larger exponents to blend more rapidly

$$\text{Nu}_x = \cancel{\text{Nu}_0} + \left[\text{Nu}_{\text{lam}}^s + \left(\text{Nu}_{\text{trans}}^p + \text{Nu}_{\text{turb}}^p \right)^{s/p} \right]^{1/s}$$

Let $p = -10$ and $s = 5$. These values fit the observed rates of transition better than Churchill's values ($p = -5$ and $s = 2$).

$$\text{Nu}_x(\text{Re}_x, \text{Pr}) = \left[\text{Nu}_{\text{lam}}^5 + \left(\text{Nu}_{\text{trans}}^{-10} + \text{Nu}_{\text{turb}}^{-10} \right)^{-1/2} \right]^{1/5} \quad (9)$$

Summary of the proposed correlation

Combining formula

$$\text{Nu}_x(\text{Re}_x, \text{Pr}) = \left[\text{Nu}_{\text{lam}}^5 + \left(\text{Nu}_{\text{trans}}^{-10} + \text{Nu}_{\text{turb}}^{-10} \right)^{-1/2} \right]^{1/5} \quad (9)$$

Laminar region

$$\text{Nu}_{\text{lam}}(\text{Re}_x, \text{Pr}) = \begin{cases} 0.332 \text{Re}_x^{1/2} \text{Pr}^{1/3} & \text{UWT} \\ 0.453 \text{Re}_x^{1/2} \text{Pr}^{1/3} & \text{UHF} \end{cases}$$

With an unheated starting length of x_0 , use

$$\text{Nu}_{\text{lam}}(\text{Re}_x, \text{Pr}) \times \left[1 - (x_0/x)^{3/4} \right]^{-1/3}$$

Transition region

$$\text{Nu}_{\text{trans}}(\text{Re}_x, \text{Pr}) = \text{Nu}_{\text{lam}}(\text{Re}_l, \text{Pr}) \times (\text{Re}_x/\text{Re}_l)^c \quad \text{with } c = \text{fn}(\text{Re}_l)$$

Turbulent region

$$\text{Nu}_{\text{turb}}(\text{Re}_x, \text{Pr}) = \frac{\text{Re}_x \text{Pr} (C_f/2)}{1 + 12.7(\text{Pr}^{2/3} - 1)\sqrt{C_f/2}} \quad (6)$$
$$C_f(\text{Re}_x) = \frac{0.455}{[\ln(0.06 \text{Re}_x)]^2}$$

We now apply this correlation to many data sets, fitting c and Re_l in each case. Fluids considered:

- Air
- Water
- Oil

Data of several investigators for air

Laminar, transitional, and fully turbulent flow

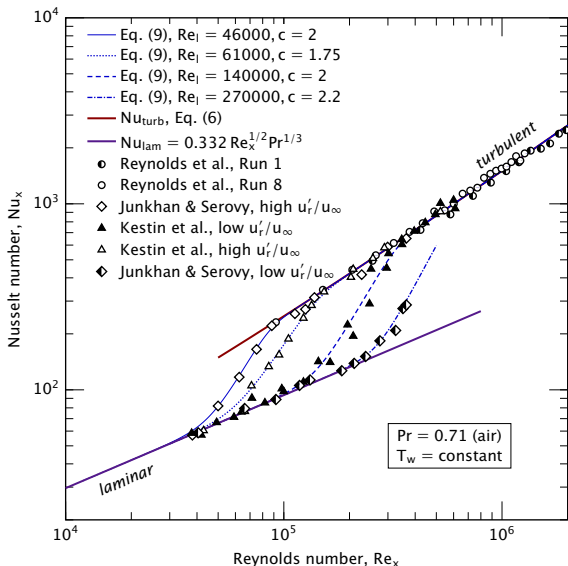

Blair's data for air (1983)

Laminar, transitional, and fully turbulent flow. $Nu_{\text{lam}}^{\text{UHF}} \approx 0.4535 Re_x^{1/2} Pr_x^{1/3} [1 - (x_0/x)^{3/4}]^{-1/3}$

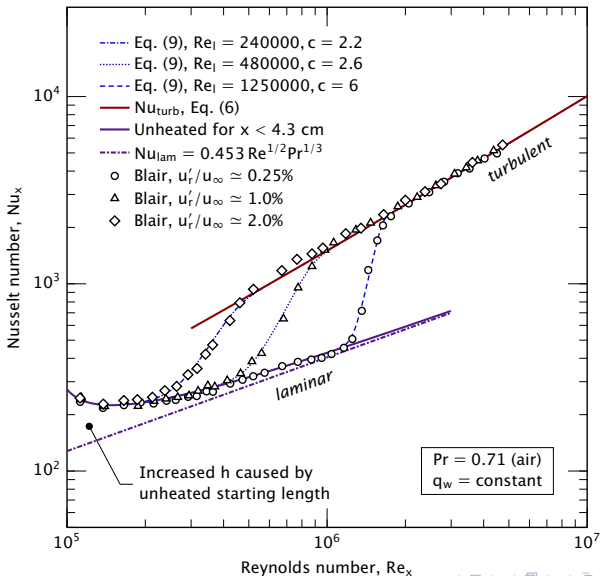

Air data: Seban and Doughty (1956); Reynolds et al. (1958)

Experiments with natural transition (b.l. not tripped)

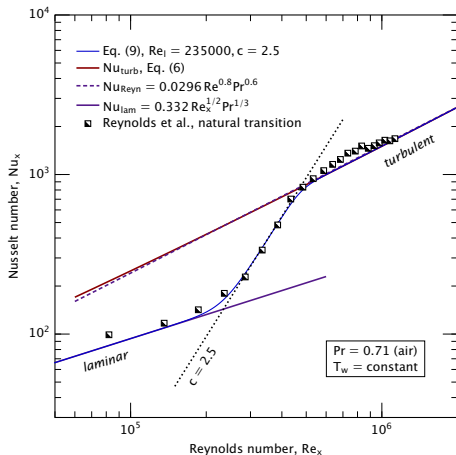
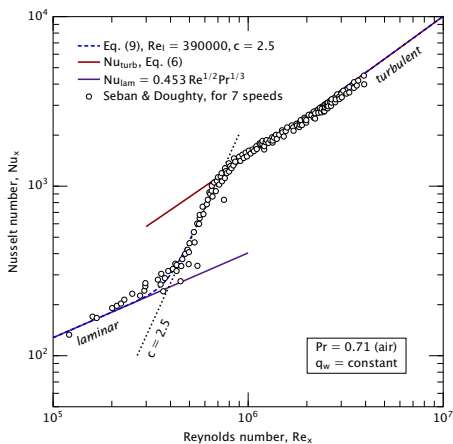

Žukauskas & Šlančiauskas data for air

Laminar, transitional and fully turbulent flow in different experiments

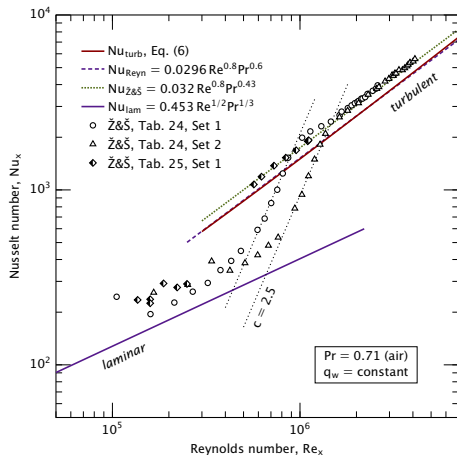
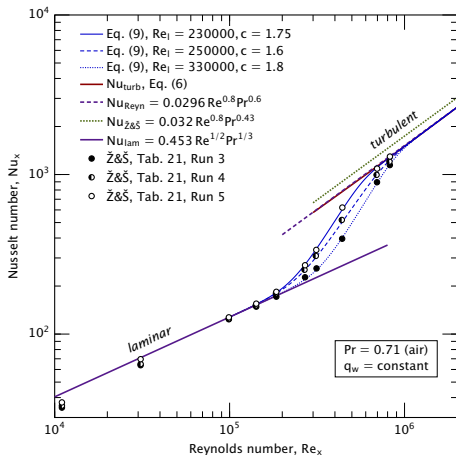

All fully-turbulent air data

Žukauskas & Šlančiauskas data are systematically high by 15–25%

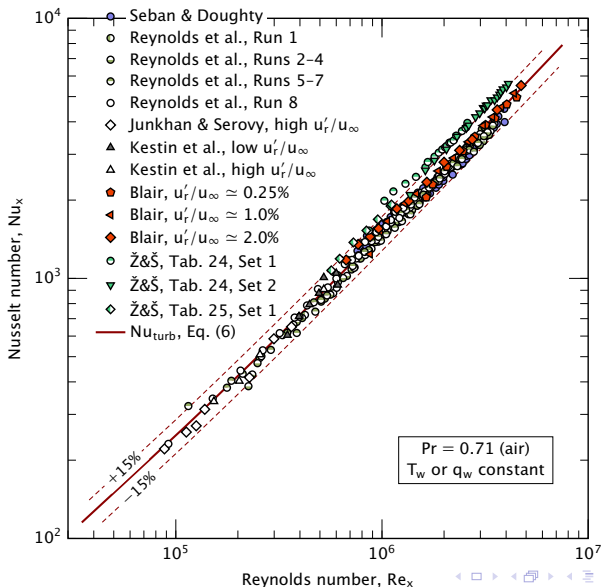

All fully-turbulent air data (w/o ž & š)

328 data points, 99.4% are within $\pm 15\%$ of Eq. (6). Standard deviation is just 5.5%.

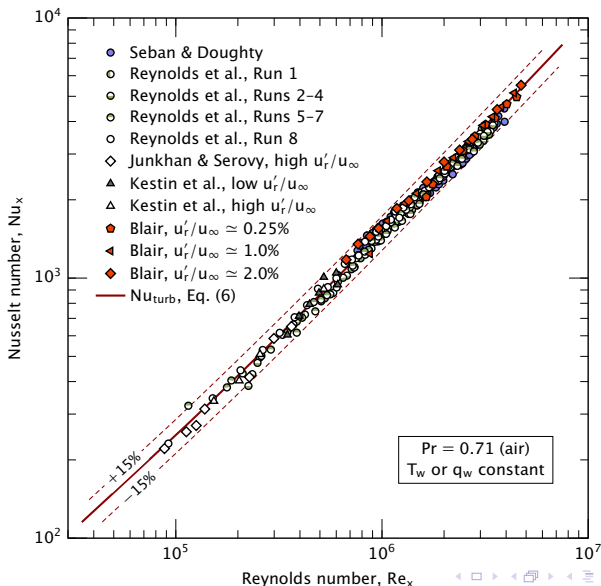

Results for water: Pr = 5.4 and 6.6

Data of Žukauskas & Šlančiauskas with correlations of Ž & Š and Hollingsworth

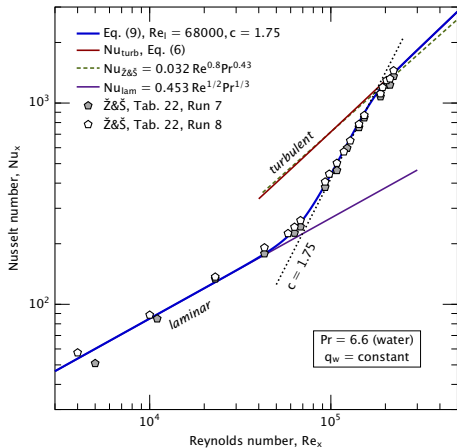
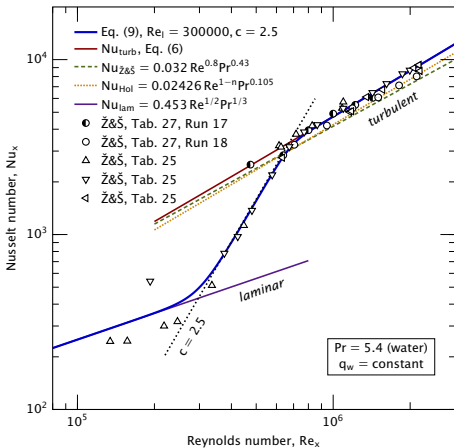

Water data from Ž & Š for Pr = 3

Water at 60°C, measurement uncertainties 2× previous water data. (NB: change of scale)

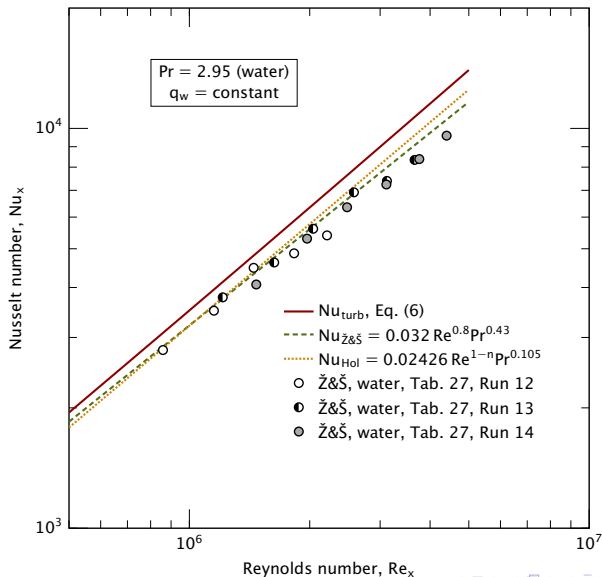

Transformer oil. Variable property ratio: $(Pr_{\infty}/Pr_w)^{0.25}$

Correction: $Pr = 55, 2.7\%$; $84, 12.7\%$; and $85, 17\%$

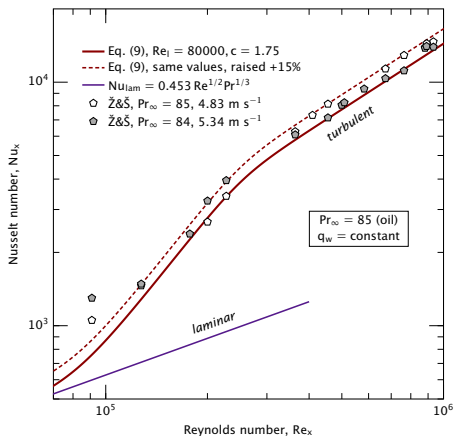
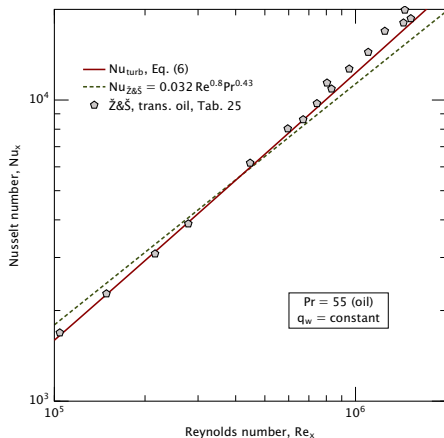

Transformer oil

Prandtl numbers of 108 and 257. Plots adjusted for strongly varying properties using $(Pr_\infty/Pr_w)^{0.25}$.

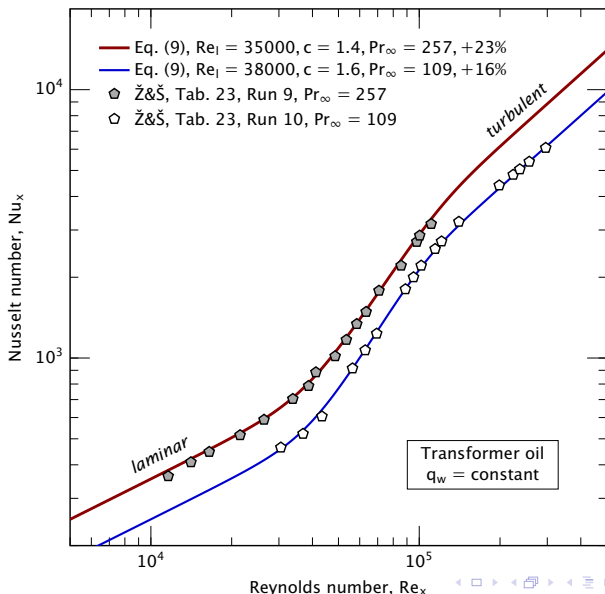

Fitting c as a function of Re_l

$$Nu_{trans} = Nu_{lam}(Re_l, Pr) (Re_x/Re_l)^c$$

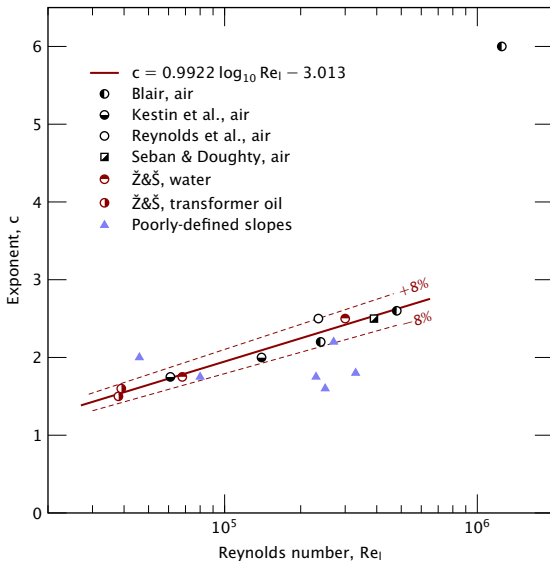

Summary of the proposed correlation

$0.7 \leq Pr \leq 257$ and $4,000 \leq Re_x \leq 4,300,000$, with free-stream turbulence levels up to 5%

Combining formula

$$Nu_x(Re_x, Pr) = \left[Nu_{\text{lam}}^5 + \left(Nu_{\text{trans}}^{-10} + Nu_{\text{turb}}^{-10} \right)^{-1/2} \right]^{1/5} \quad (9)$$

Laminar region

$$Nu_{\text{lam}}(Re_x, Pr) = \begin{cases} 0.332 Re_x^{1/2} Pr^{1/3} & \text{UWT} \\ 0.453 Re_x^{1/2} Pr^{1/3} & \text{UHF} \end{cases}$$

With an unheated starting length of x_0 , use

$$Nu_{\text{lam}}(Re_x, Pr) \times \left[1 - (x_0/x)^{3/4} \right]^{-1/3}$$

Transition region

$$Nu_{\text{trans}}(Re_x, Pr) = Nu_{\text{lam}}(Re_l, Pr) \times (Re_x/Re_l)^c$$

Re_l is the Reynolds number at onset of transition, x_l

$$c = 0.9922 \log_{10} Re_l - 3.013 \quad \text{for } Re_l < 5 \times 10^5$$

Turbulent region

$$Nu_{\text{turb}}(Re_x, Pr) = \frac{Re_x Pr (C_f/2)}{1 + 12.7(Pr^{2/3} - 1) \sqrt{C_f/2}} \quad (6)$$

$$C_f(Re_x) = \frac{0.455}{[\ln(0.06 Re_x)]^2}$$

Average Nusselt Number

$$\bar{h} = \frac{1}{L\Delta T} \int_0^L q_w dx = \frac{1}{L} \left[\int_0^{x_l} h_{\text{laminar}} dx + \int_{x_l}^{x_u} h_{\text{trans}} dx + \int_{x_u}^L h_{\text{turbulent}} dx \right]$$

For gases, can use Reynolds' power law: $Nu_x = 0.0296 Re_x^{0.8} Pr^{0.6}$

$$\begin{aligned} \overline{Nu}_L \equiv \frac{\bar{h}L}{k} &= 0.037 Pr^{0.6} (Re_L^{0.8} - Re_u^{0.8}) + 0.664 Re_l^{1/2} Pr^{1/3} \\ &+ \underbrace{\frac{1}{c} (0.0296 Re_u^{0.8} Pr^{0.6} - 0.332 Re_l^{1/2} Pr^{1/3})}_{\text{contribution of transition region}} \quad \text{for gases} \end{aligned}$$

For $Re_l = 140,000$, $c = 2$, $Re_u = 335,000$ with, say, $Re_L = 600,000$:

$$\overline{Nu}_L = \underbrace{470.7}_{\text{turb.}} + \underbrace{221.6}_{\text{lam.}} + \underbrace{259.2}_{\text{trans.}} = 951.5$$

The transitional region contributes **27.2%**.

Summary

We have correlated Nu_x for a flat plate boundary layer from laminar, to transitional, to fully turbulent flow for $4,000 \leq Re_x \leq 4,300,000$ and $0.7 \leq Pr \leq 257$.

Summary

We have correlated Nu_x for a flat plate boundary layer from laminar, to transitional, to fully turbulent flow for $4,000 \leq Re_x \leq 4,300,000$ and $0.7 \leq Pr \leq 257$.

- 1 The transition region has a length similar to the laminar region.

Summary

We have correlated Nu_x for a flat plate boundary layer from laminar, to transitional, to fully turbulent flow for $4,000 \leq Re_x \leq 4,300,000$ and $0.7 \leq Pr \leq 257$.

- 1 The transition region has a length similar to the laminar region.
- 2 $Nu_{trans} \propto Re_x^c$, and c increases with Re_l , the value at the onset of transition.

Summary

We have correlated Nu_x for a flat plate boundary layer from laminar, to transitional, to fully turbulent flow for $4,000 \leq Re_x \leq 4,300,000$ and $0.7 \leq Pr \leq 257$.

- 1 The transition region has a length similar to the laminar region.
- 2 $Nu_{trans} \propto Re_x^c$, and c increases with Re_l , the value at the onset of transition.
- 3 By modifying Churchill's correlation, $Nu_x(Re_x, Pr)$ can be accurately predicted in the transition and turbulent ranges, giving very good agreement with a large body of independent experiments.

Summary

We have correlated Nu_x for a flat plate boundary layer from laminar, to transitional, to fully turbulent flow for $4,000 \leq Re_x \leq 4,300,000$ and $0.7 \leq Pr \leq 257$.

- 1 The transition region has a length similar to the laminar region.
- 2 $Nu_{trans} \propto Re_x^c$, and c increases with Re_l , the value at the onset of transition.
- 3 By modifying Churchill's correlation, $Nu_x(Re_x, Pr)$ can be accurately predicted in the transition and turbulent ranges, giving very good agreement with a large body of independent experiments.
- 4 Žukauskas & Šlančiauskas's turbulent air data are systematically high.
- 5 Žukauskas & Šlančiauskas's turbulent correlation is *not recommended*.

Summary

We have correlated Nu_x for a flat plate boundary layer from laminar, to transitional, to fully turbulent flow for $4,000 \leq Re_x \leq 4,300,000$ and $0.7 \leq Pr \leq 257$.

- 1 The transition region has a length similar to the laminar region.
- 2 $Nu_{trans} \propto Re_x^c$, and c increases with Re_l , the value at the onset of transition.
- 3 By modifying Churchill's correlation, $Nu_x(Re_x, Pr)$ can be accurately predicted in the transition and turbulent ranges, giving very good agreement with a large body of independent experiments.
- 4 Žukauskas & Šlančiauskas's turbulent air data are systematically high.
- 5 Žukauskas & Šlančiauskas's turbulent correlation is *not recommended*.
- 6 Fage & Falkner's data for UHF laminar air flow agree well with analytical results, contrary to the suggestion of Jakob & Dow.

Summary

We have correlated Nu_x for a flat plate boundary layer from laminar, to transitional, to fully turbulent flow for $4,000 \leq Re_x \leq 4,300,000$ and $0.7 \leq Pr \leq 257$.

- 1 The transition region has a length similar to the laminar region.
- 2 $Nu_{trans} \propto Re_x^c$, and c increases with Re_l , the value at the onset of transition.
- 3 By modifying Churchill's correlation, $Nu_x(Re_x, Pr)$ can be accurately predicted in the transition and turbulent ranges, giving very good agreement with a large body of independent experiments.
- 4 Žukauskas & Šlančiauskas's turbulent air data are systematically high.
- 5 Žukauskas & Šlančiauskas's turbulent correlation is *not recommended*.
- 6 Fage & Falkner's data for UHF laminar air flow agree well with analytical results, contrary to the suggestion of Jakob & Dow.
- 7 Very few measurements of h exist for turbulent liquid boundary layers.

To read more, see this paper

J. H. Lienhard V, “Heat transfer in flat-plate boundary layers: a correlation for laminar, transitional, and turbulent flow,” *J. Heat Transfer*, **142**(6): 061805, June 2020.

OPEN ACCESS: <https://doi.org/10.1115/1.4046795>



Supplementary slides

Schubauer and Skramstad measurements in a very low turbulence wind tunnel (NACA Rpt. 909, 1948)

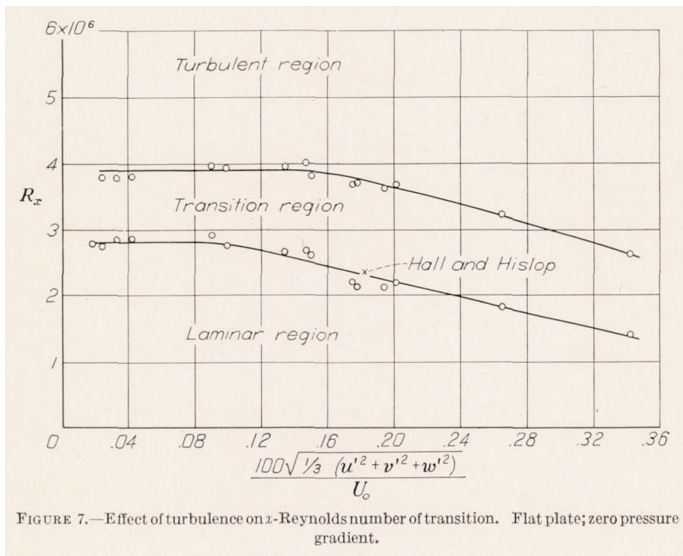
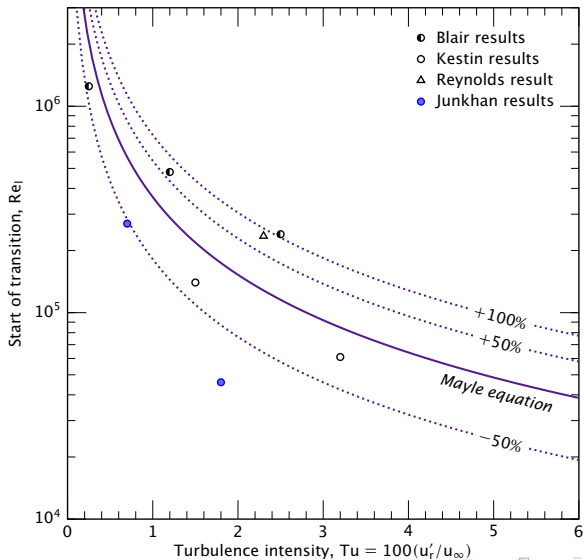
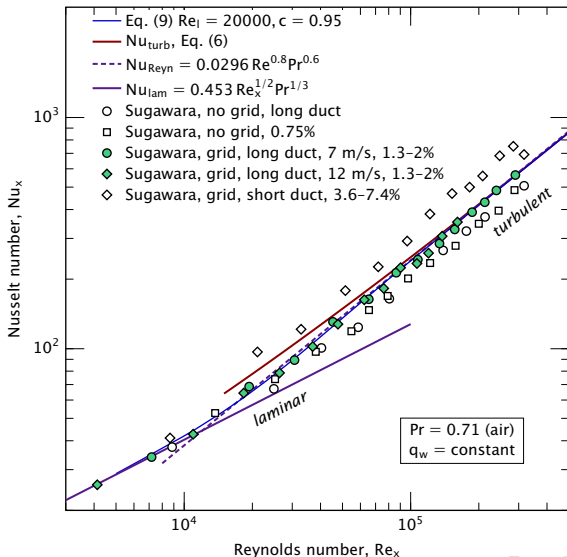

FIGURE 7.—Effect of turbulence on x -Reynolds number of transition. Flat plate; zero pressure gradient.

Mayle (1991) onset formula compared to data sets with well-defined free-stream turbulence: $Re_l \approx 3.6 \times 10^5 Tu^{-1.25}$



Sugawara et al., transient cooling of plate in air, high turbulence (*Trans. JSME*, 1951; NASA, 1958)



“It is quite clear from Fig. 16 that Sugawara and Sato’s experimental results in the laminar range deviate from Pohlhausen’s solution by a large amount. ...Clearly, the general features of their results do not agree with those of the others and of the present investigation. This divergence might be the result of the questionable accuracy of the non-steady method, or of some defects in their arrangement.”

The Japanese language version of Sugawara et al. includes a discussion of wall temperature variation ($\Delta T \sim x^{1/2}$) and a correlation close to the UHF result. Kestin et al. seem to have totally missed these ideas.

Whitaker's comparison to average data (AIChE J, 1972)

Concerns

- Only one data set follows the ad hoc transition fit
- Reynolds et al. data is systematically below the fitted curve
- All studies except Reynolds et al. made large corrections for unheated starting length
- ⇒ Not a convincing validation of transition model

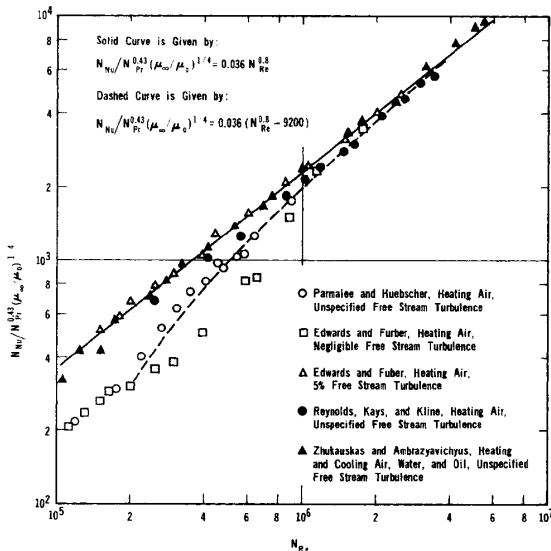

Churchill's correlation in full

Churchill's correlation for uniform T_w is

$$\text{Nu}_x = 0.45 + (0.3387 \phi^{1/2}) \left\{ 1 + \frac{(\phi/2600)^{3/5}}{[1 + (\phi_u/\phi)^{7/2}]^{2/5}} \right\}^{1/2}$$

where

$$\phi \equiv \text{Re}_x \text{Pr}^{2/3} \left[1 + \left(\frac{0.0468}{\text{Pr}} \right)^{2/3} \right]^{-1/2}$$

and $10^5 \leq \phi_u \leq 10^7$ must be fit to each specific data set. If the Reynolds number at the end of the transition region is Re_u , an estimate is $\phi_u \approx \phi(\text{Re}_x = \text{Re}_u)$.

For uniform q_w , change 0.3387, 0.0468, and 2600 to 0.4637, 0.02052, and 7420.

Churchill's correlation in full

Churchill's correlation for uniform T_w is

$$\text{Nu}_x = 0.45 + (0.3387 \phi^{1/2}) \left\{ 1 + \frac{(\phi/2600)^{3/5}}{[1 + (\phi_u/\phi)^{7/2}]^{2/5}} \right\}^{1/2}$$

where

$$\phi \equiv \text{Re}_x \text{Pr}^{2/3} \left[1 + \left(\frac{0.0468}{\text{Pr}} \right)^{2/3} \right]^{-1/2}$$

and $10^5 \leq \phi_u \leq 10^7$ must be fit to each specific data set. If the Reynolds number at the end of the transition region is Re_u , an estimate is $\phi_u \approx \phi(\text{Re}_x = \text{Re}_u)$.

For uniform q_w , change 0.3387, 0.0468, and 2600 to 0.4637, 0.02052, and 7420.

$$\text{Nu}_x \xrightarrow{\text{Re}_x \gg \text{Re}_u} 0.032 \phi^{4/5} \xrightarrow{\text{Pr} \gg 1} 0.032 \text{Re}_x^{0.8} \text{Pr}^{8/15}$$

which is an *ad hoc* exponent on Pr so as to use the variable ϕ .

Churchill's comparison to local data (AIChE J, 1976)

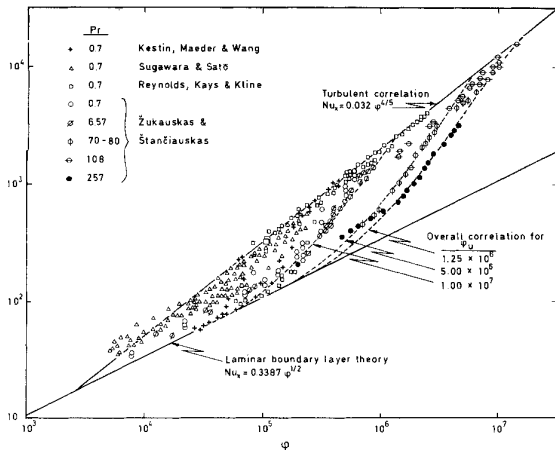

Concerns

- Only a few data sets match transition fit
- Much of this data is not for UWT
- Kestin's high & low turbulence data are not separated
- Sugawara data also not separated by turbulence level

Schook *transient* air data at $Ma = 0.36$ (IJHMT 44, 2001)

Ludwig tube (blow-down) with $T_w \approx \text{constant}$ and varying freestream turbulence.

