

MIT Open Access Articles

Non-Higgsable abelian gauge symmetry and \mathcal{F} -theory on fiber products of rational elliptic surfaces

The MIT Faculty has made this article openly available. *Please share* how this access benefits you. Your story matters.

Citation: Morrison, David R. et al. "Non-Higgsable abelian gauge symmetry and F-theory on fiber products of rational elliptic surfaces." *Advances in Theoretical and Mathematical Physics* 22, 1 (September 2018): 177 – 245

As Published: <http://dx.doi.org/10.4310/atmp.2018.v22.n1.a5>

Publisher: International Press of Boston

Persistent URL: <https://hdl.handle.net/1721.1/126423>

Version: Original manuscript: author's manuscript prior to formal peer review

Terms of use: Creative Commons Attribution-Noncommercial-Share Alike



Non-Higgsable abelian gauge symmetry and F-theory on fiber products of rational elliptic surfaces

David R. Morrison¹ Daniel S. Park^{2,3} and Washington Taylor⁴

¹*Departments of Mathematics and Physics
University of California, Santa Barbara
Santa Barbara, CA 93106, USA*

²*Simons Center for Geometry and Physics
State University of New York
Stony Brook, NY 11794, USA*

³*NHETC and Department of Physics and Astronomy
Rutgers University
Piscataway, NJ 08855, USA*

⁴*Center for Theoretical Physics
Department of Physics
Massachusetts Institute of Technology
77 Massachusetts Avenue
Cambridge, MA 02139, USA*

E-mail: [drm at math.ucsb.edu](mailto:drm@math.ucsb.edu), [dspark at physics.rutgers.edu](mailto:dspark@physics.rutgers.edu), [wati at mit.edu](mailto:wati@mit.edu)

ABSTRACT: We construct a general class of Calabi–Yau threefolds from fiber products of rational elliptic surfaces with section, generalizing a construction of Schoen to include all Kodaira fiber types. The resulting threefolds each have two elliptic fibrations with section over rational elliptic surfaces and blowups thereof. These elliptic fibrations generally have nonzero Mordell–Weil rank. Each of the elliptic fibrations has a physical interpretation in terms of a six-dimensional F-theory model with one or more non-Higgsable abelian gauge fields. Many of the models in this class have mild singularities that do not admit a Calabi–Yau resolution; this does not seem to compromise the physical integrity of the theory and can be associated in some cases with massless hypermultiplets localized at the singular loci. In some of these constructions, however, we find examples of abelian gauge fields that cannot be “unHiggsed” to a nonabelian gauge field without producing unphysical singularities that cannot be resolved. The models studied here can also be used to exhibit T-duality for a class of little string theories.

Contents

1	Introduction	2
2	Canonical singularities of algebraic threefolds	4
3	Fiber products of rational elliptic surfaces	7
3.1	Schoen’s construction	7
3.2	Allowed singularity pairs	9
3.3	Example: I_0^* singularities in B	11
3.4	Blowup geometry	13
3.5	Combining rational elliptic surfaces	14
3.6	Conifold transitions, the Higgs mechanism, and massless hypermultiplets	16
4	Elliptic fibrations over bases with a \mathbb{C}^*-structure	18
4.1	Examples	18
4.2	The other bases	20
5	Aspects of abelian gauge symmetry	21
5.1	Abelian anomaly coefficients	23
5.2	Non-enhanceable $\mathfrak{u}(1)$ components	26
6	A-B duality	32
6.1	Example: Model with coincident singular fiber $I_0^* \times I_n$	34
6.2	Example: Model with coincident singular fiber $I_0^* \times IV$	37
6.3	Little string theories	40
7	Conclusions	40
A	Terminal singularities and small resolutions	42
B	Two explicit MCP blowups	43
C	\mathbb{C}^* bases with generic nonzero Mordell–Weil rank	47

1 Introduction

Recently, the phenomenon of gauge symmetries that cannot be Higgsed in low-energy supersymmetric theories has been studied intensively in the context of F-theory [1–7]. These works have focused on nonabelian gauge symmetries that may arise through singular Kodaira fiber types that are present at generic points in the complex structure moduli space of a Calabi–Yau threefold or fourfold that is elliptically fibered over a given base geometry. Such “non-Higgsable” nonabelian gauge groups seem to arise in very generic classes of F-theory vacua. In this paper we consider a class of models that give rise to analogous non-Higgsable *abelian* gauge factors.

An interesting class of elliptic Calabi–Yau threefolds was constructed by Schoen [8] using fiber products of rational elliptic surfaces with section¹ that admit small resolutions. These manifolds are of interest for a number of reasons, including the fact that manifolds with Mordell–Weil (MW) groups having relatively large rank r are easily constructed in this fashion, $r = 9$ being the largest out of the examples appearing in this work. Schoen’s construction was generalized by Kapustka and Kapustka [11] to include a broader range of singular fibers in the component rational elliptic surfaces. In this paper we generalize this construction further, by considering the full range of Kodaira fiber types in the component rational elliptic surfaces. We give a systematic classification of the pairs of fiber types which, when combined into a fiber product, have at worst canonical singularities in the total space. Following Miranda [12] and Grassi [13], for each of the projections from the fiber product to one of the factors, there is a blowup of the base and a partial resolution of the total space that yields a flat elliptic fibration (*i.e.*, one in which all fibers are one-dimensional) such that the canonical bundle of the total space is trivial. Combining this information with Persson’s list [14, 15] of the combinations of singular fibers that can appear in a rational elliptic surface gives in principle a complete classification of all elliptic Calabi–Yau threefolds that can be constructed in this fashion.

Elliptic Calabi–Yau threefolds of this type are of interest in physics, where they can be used as compactification spaces for F-theory [16–18] to give six-dimensional supergravity theories. The role of abelian gauge fields in F-theory, associated with elliptically fibered Calabi–Yau manifolds having nonzero Mordell–Weil rank, has been of substantial recent interest (see for example [19–41].) Some of the threefolds that we consider here have been constructed in this related physics context. In [42], following methods developed in [1, 43], a complete classification was given of complex surfaces that admit a \mathbb{C}^* -action and can act as bases for an elliptically fibered Calabi–Yau threefold. Of the more than 100,000 such bases, 13 have the property that the associated elliptically fibered Calabi–Yau threefolds have Mordell–Weil groups of nonzero rank everywhere in the moduli space. We show in §4 that all 13 of these models are special cases of the construction presented here.

¹There exist rational elliptic surfaces with no section (see *e.g.* [9, Chap. V, §6] or [10]) but they will not concern us here.

These manifolds shed light on the extent to which fibrations with nonzero Mordell–Weil rank can be analyzed through deformations of local Kodaira singularity structures. In [25, 33], we showed that in a very general class of situations, sections in the free part of the Mordell–Weil group (associated with abelian gauge fields) can be converted to divisors associated with Kodaira singularities that are local in the base (associated with nonabelian gauge fields) without changing $h^{1,1}$ of the threefold. This shows that in many cases, threefolds with nonzero Mordell–Weil rank can be constructed from deformations of threefolds with vanishing Mordell–Weil rank. In some cases the transition from “horizontal” divisors associated with sections to “vertical” divisors associated with Kodaira singularities gives rise to singularities that require further treatment. As discussed in [33], some of these situations involve singularities that require a blowup in the base manifold. In other situations, however, we find that the singularity cannot be resolved (while keeping the canonical bundle trivial), and there is no blowup of the base that leads to an acceptable F-theory background. The threefolds constructed here provide a variety of concrete examples of such situations where the full Mordell–Weil rank cannot be realized in this way without producing singularities that lie at infinite distance from the interior of the moduli space of the manifold, corresponding in physics terms to theories with abelian gauge fields that cannot be “unHiggsed” or “enhanced.”²

Another interesting aspect of the manifolds we study is that they admit two distinct elliptic fibration structures. Depending on which elliptic fibration structure we choose to preserve, we arrive at two different resolutions, and two different six-dimensional physical models in the F-theory limit. Calabi–Yau manifolds with distinct elliptic fibration structures were also recently discussed in a related context in [44]. Upon compactifying the two distinct six-dimensional theories to five dimensions along a circle, it can be shown that the two five-dimensional theories are actually dual to each other. This duality, which we call A - B duality, can be understood in terms of flops relating the two resolutions. It is also closely related to “little string theories:” choosing one singular fiber in each of the two fibrations and restricting to neighborhoods of the chosen fibers, there is a scaling limit that produces a little string theory from the F-theory compactification [45, 46]. Our A - B duality exhibits the expected T-duality of the corresponding little string theories.

Because the results in this paper may be of interest both to mathematicians and to physicists, we have tried to arrange the presentation in a way that makes the relevant points accessible to both types of readers. After a review of canonical singularities in §2, the construction is described in mathematical terms in §3, and the examples encountered in the physical context are described in §4. We discuss the abelian sector of the F-theory vacua in §5, while §6 is devoted to studying A - B duality. Some concluding remarks are given in §7.

²Recently, another scenario has been suggested in which a non-enhanceable abelian gauge symmetry in an F-theory background can arise. In [41], it was pointed out that F-theory models with abelian gauge symmetry that simply do not have the moduli that can be tuned to enhance the abelian gauge algebra might exist.

2 Canonical singularities of algebraic threefolds

One common approach to studying F-theory compactifications is to begin with M-theory compactified on a smooth elliptically fibered Calabi–Yau manifold $X \rightarrow B$ and then take a limit in which the area of the elliptic fiber approaches zero, yielding an F-theory compactification. However, adhering to the requirement that X be nonsingular does not allow for some important features to show up in M-theory, such as nonabelian gauge symmetry. An alternate approach, emphasized in [47–49] among other places, is to begin with the Weierstrass model defined by

$$y^2 = x^3 + fx + g \tag{2.1}$$

and treat the Weierstrass coefficients as directly defining the F-theory compactification via specification of the (variable) axio-dilaton in a type IIB compactification on the base B . The total space \overline{X} of a fibration defined in this way is typically singular.

A natural question in either of these approaches is what kind of singularities to allow. That is, if we are to compactify M-theory on a space \tilde{X} that is birational to a Weierstrass model \overline{X} (or more generally, whose relative Jacobian is birational to a Weierstrass model [50, 51]), which singularities should be permitted in \tilde{X} ?

One possible answer is to demand that \tilde{X} admit a resolution of singularities $X \rightarrow \tilde{X}$ such that X is a smooth Calabi–Yau manifold. However, in a number of recent works including [25, 51, 33], singular spaces \tilde{X} that do not have a Calabi–Yau resolution have arisen naturally in an F-theory or M-theory context. Such spaces also arise in this work, with singularities arising over a point in the base of the elliptic fibration that do not admit a Calabi–Yau resolution but that do not seem to compromise the physical integrity of the theory.

A perhaps better answer, at least for threefolds³, is to demand that (after an appropriate partial resolution) $\tilde{X} = \tilde{X}_0$ have a deformation of complex structure \tilde{X}_t that is a Calabi–Yau manifold for each value of $t > 0$, such that \tilde{X}_0 is at finite distance from \tilde{X}_t in the moduli space metric. By a result due to Hayakawa [56] and Wang [57], such \tilde{X} are characterized by having *Gorenstein canonical singularities* and *trivial dualizing sheaf*. *Gorenstein* means that there is a natural analogue of the bundle of holomorphic n -forms on \tilde{X} , known as the *dualizing sheaf*, which is a locally free sheaf. *Canonical* means that by blowing up \tilde{X} we can never introduce poles into the original n -forms.

We call \tilde{X} a *Calabi–Yau variety* if it has Gorenstein canonical singularities and trivial dualizing sheaf, and we argue that this is the natural class of spaces on which M-theory can be compactified. Among other things, this definition allows for rational double points in complex codimension two, which correspond to nonabelian gauge symmetry in the compactified theory. Allowing such singularities does not seem to compromise the physical integrity of the theory.

³Note that, as pointed out in [52, 53], the situation is more complicated for Calabi–Yau fourfolds. There are (terminal) singularities such as $\mathbb{C}^4/\mathbb{Z}_2$ that seem very well behaved for physical purposes, yet which admit neither complex structure smoothings [54] nor Calabi–Yau resolutions [55].

To spell out the meaning of “canonical singularities” in more detail, we can use Hironaka’s famous theorem [58] to resolve the singularities on \tilde{X} by a sequence of projective blowups,⁴ yielding $\pi : Z \rightarrow X$. A Gorenstein space \tilde{X} is *canonical* if

$$K_Z = \pi^*(K_{\tilde{X}}) + \sum a_i D_i \tag{2.2}$$

with all coefficients a_i non-negative [60]. The blowup is called *crepant* if all $a_i = 0$ [61]. Note that if \tilde{X} has trivial dualizing sheaf and $X \rightarrow \tilde{X}$ is a crepant projective resolution of singularities, then X is a Calabi–Yau manifold.

To formulate the definition of canonical, we need to use non-crepant blowups in general, and one may wonder about the physical significance of a non-crepant blowup. This is best studied by considering a two-dimensional sigma-model whose target is an arbitrary Kähler manifold Z [62, 53]. (This is relevant for string compactification rather than M-theory compactification, but the two are closely related.) The behavior of this theory under renormalization is governed by the canonical divisor K_Z . For an algebraic curve C on Z , if $K_Z \cdot C < 0$ then the sigma model operator that creates C is irrelevant, and under RG flow C contracts to a point. If $K_Z \cdot C > 0$ then the operator is relevant and under RG flow, C grows without bound. Finally, if $K_Z \cdot C = 0$ then the operator that creates C is marginal and under RG flow C remains of finite volume.

This phenomenon is the essential insight in “Mori theory” [63, 64], which is a detailed study of the birational geometry of algebraic threefolds that proceeds by blowing down curves C with $K_Z \cdot C < 0$. Moreover, there is an expectation that Mori theory will be reproduced by “Kähler–Ricci flow” [65], which directly uses Ricci flow (the one-loop approximation to the sigma model RG flow) to produce new models, although the mathematical theory of Kähler–Ricci flow is still under development.

From the physics point of view, one could blow up the original singular space arbitrarily and then run RG flow on the sigma model. If $K_Z \cdot C \leq 0$ for all curves C on Z , then we can expect the RG flow to approach a sigma model on a space in which all the curves with $K_Z \cdot C < 0$ have been shrunk to points. However, the presence of any curve C with $K_Z \cdot C > 0$ would prevent this from happening.

The endpoint of this process is known from Mori theory, and the final space that is reached has “ \mathbb{Q} -factorial terminal singularities.” *Terminal singularities* are a special class of canonical singularities in which all coefficients a_i in (2.2) are strictly greater than zero. Such a singularity is *\mathbb{Q} -factorial* if there are no further crepant projective blowups that can be made. It is also known from Mori theory that for a given variety, there can be more than one birational model with \mathbb{Q} -factorial terminal singularities. For Calabi–Yau varieties, any two such models differ by a sequence of flops [66, 67].

⁴The blowup $\pi : Z \rightarrow X$ is *projective* if $Z \subset (X \times \mathbb{P}^N)$ for some N , with the map π given by projection to the first factor. This condition guarantees that if X is Kähler then so is Z . In algebraic geometry, there can be other kinds of blowup, in which Z is only assumed to be a scheme (or even just an algebraic space in the sense of Artin [59]).

Putting together the Hironaka blowup followed by the Mori blowdown, we conclude that any Calabi–Yau variety has a crepant projective blowup with at worst \mathbb{Q} -factorial terminal singularities. (In fact, using an algorithm of Reid [61], such a crepant projective blowup can be made directly, without “overshooting” and needing to invoke Mori theory or the RG flow.) In addition, by a result of Namikawa and Steenbrink [68], any Calabi–Yau threefold with \mathbb{Q} -factorial terminal singularities can always be deformed to a smooth Calabi–Yau manifold. Thus, we do not expect to find such singularities in generic (maximally Higgsed) 6D F-theory models. Since the corresponding theorem does not hold for fourfolds, however, such codimension two singularities in Calabi–Yau fourfolds can arise even in maximally Higgsed models [69, 6].

We focus here on *maximal crepant projective blowups*, which we call *MCP blowups* for short. In general, any Calabi–Yau variety \tilde{X} of dimension three has an MCP blowup $X = X_0$ which in turn has a complex structure deformation to a smooth Calabi–Yau manifold X_t . By Hayakawa and Wang, X_0 is at finite distance from the interior of complex structure moduli space; we then obtain the original \tilde{X} from X_0 by tuning Kähler moduli appropriately.

A crepant projective blowup of a terminal singularity is often called a *small blowup* (or a *small resolution* in case it resolves the singularities completely). There is an important subtlety to be aware of concerning these: whether or not a given terminal singularity admits a small projective blowup depends on the existence of certain divisors that might exist locally (in the complex topology) but not globally. The divisor must exist globally if the blown up space is to be a Kähler manifold or singular Kähler variety. The endpoint of the Mori program or of Kähler-Ricci flow is a projective or Kähler space, so only global blowups are permitted. We will discuss a different perspective on the question of global blowups, including a physical interpretation, in §3.6.

Returning to F-theory, consider a Weierstrass model in the form (2.1) with associated elliptic fibration $\tilde{X} \rightarrow B$. Allowing the total space \tilde{X} to be a Calabi–Yau variety does not seem to compromise the integrity of the F-theory compactification. Let $X \rightarrow \tilde{X}$ be an MCP blowup. If the induced map $X \rightarrow B$ has any fiber components of complex dimension two, the corresponding F-theory model has tensionless strings in its low-energy spectrum, which indicates that there is a conformal field theory (CFT) as part of the spectrum [70]. F-theory models are easier to understand when they are not coupled to conformal field theories in this way, and fortunately it is known from work of Miranda [12] and Grassi [13] that there is a blowup $\hat{B} \rightarrow B$ of the base and an elliptic fibration $X \rightarrow \hat{B}$ all of whose fibers are one-dimensional. (Such a fibration is called *flat*.) The corresponding F-theory models have a conventional field-theoretic description at low energy, which can be understood as an effective description of the tensor branch of the CFT. We will use such modified bases and the associated flat fibrations frequently in this paper. The necessity for blowing up the base in order to obtain a flat family can be detected directly from the Weierstrass model (2.1): any point in the base at which f has multiplicity at least four and g has multiplicity at least six must be blown up.

3 Fiber products of rational elliptic surfaces

We begin in §3.1 by summarizing the construction of Schoen and the generalization by Kapustka and Kapustka. In §3.2, we present the main result of this paper, which is the set of pairs of singularities that can be consistently combined in a Calabi–Yau threefold built from a fiber product of rational elliptic surfaces with section when blowups on the surfaces as well as small resolutions are allowed. §3.3 gives an example case worked out in detail where blowups of the base surface are needed, and §3.4 describes the geometry on the base of the elliptically fibered threefold in the remaining cases. In §3.5, we describe how the allowed singularity pairs can be combined in different ways using rational elliptic surfaces from Persson’s list to give the complete set of possible elliptically fibered Calabi–Yau threefolds that can be constructed in this way.

3.1 Schoen’s construction

A *rational elliptic surface with section*⁵ is a complex surface A that is constructed by blowing up nine points on \mathbb{P}^2 , where the first eight points are generic and the ninth point is the additional point that lies on all cubics passing through the first eight points. A rational elliptic surface is elliptically fibered over \mathbb{P}^1 with section, and the anti-canonical class $-K_A$ of the surface satisfies $K_A \cdot K_A = 0$. The class $-K_A$ is effective, and can in fact be used to define the fibration, where the zero locus of any section of the line bundle $\mathcal{O}(-K_A)$ is a fiber of the fibration. The fibration consists of a map $\pi_A : A \rightarrow \mathbb{P}^1$ whose fibers are elliptic curves.

A rational elliptic surface with section can alternatively be described by means of a Weierstrass equation

$$y^2 = x^3 + fx + g \tag{3.1}$$

where f and g are sections of the line bundles $\mathcal{O}(4)$ and $\mathcal{O}(6)$, respectively, on \mathbb{P}^1 .⁶ For every point $p \in \mathbb{P}^1$, either f vanishes to order at most 3 at p , or g vanishes to order at most 5 at p . The Weierstrass fibration defines an elliptic surface $\pi_{\bar{A}} : \bar{A} \rightarrow \mathbb{P}^1$ (after adding the points at infinity in the fibers) whose total space \bar{A} is generally singular, with rational double points as singularities. There is a minimal resolution of singularities $A \rightarrow \bar{A}$ (which is unique in the case of surfaces) defining the smooth⁷ elliptic surface $\pi_A : A \rightarrow \mathbb{P}^1$.

The types of singular fibers that can occur on smooth elliptic surfaces with section were classified by Kodaira and are displayed in Table 1. The criteria distinguishing among the different fiber types of a smooth elliptic surface A are expressed in terms of orders of vanishing of the coefficients f and g of the associated Weierstrass equation (3.1) as well as the order of vanishing of the discriminant $\Delta := 4f^3 + 27g^2$, as shown in the second column in the Table. On

⁵Such surfaces are sometimes referred to as “ dP_9 ” in the physics literature by analogy with the nomenclature “ dP_n ” for a del Pezzo surface obtained as the blowup of \mathbb{P}^2 in n points.

⁶This can be contrasted with the case of a Calabi–Yau variety that is elliptically fibered over a general base B (of any dimension), in which the coefficients f, g in the Weierstrass equation are sections of line bundles $\mathcal{O}(-4K_B)$, and $\mathcal{O}(-6K_B)$.

⁷Some of the fibers of π_A may be singular, but the total space is smooth.











Kodaira type	deg (f, g, Δ)	geometry	rank
I_1	$(0, 0, 1)$		0
I_n	$(0, 0, n)$		$n - 1$
II	$(1, 1, 2)$		0
III	$(1, 2, 3)$		1
IV	$(2, 2, 4)$		2
I_0^*	$(2, 3, 6)$		4
I_n^*	$(2, 3, 6 + n)$		$n + 4$
IV^*	$(3, 4, 8)$		6
III^*	$(3, 5, 9)$		7
II^*	$(4, 5, 10)$		8

Table 1. Table of Kodaira types of codimension one singularities in elliptic fibrations (with section). The second column gives degrees of vanishing of coefficients f, g in the associated Weierstrass equation (3.1) and discriminant Δ at a point on the base with the given Kodaira type of singular fiber. The third column describes the geometry of the fiber within an elliptically fibered surface as a weighted combination of intersecting -2 curves.

a smooth elliptic surface A , the singular fiber manifests as a (weighted) union of intersecting rational curves of self-intersection -2 , according to the geometry depicted in column 3 of the Table.

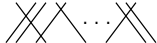
A list of the possible singular fiber configurations on any rational elliptic surface was constructed by Persson [14]; a nice alternative description of this list is given in [15].

Schoen constructed a class of Calabi–Yau threefolds in terms of fiber products of rational elliptic surfaces with section. Given two (smooth) rational elliptic surfaces with section

$$\pi_A : A \rightarrow \mathbb{P}^1, \quad \pi_B : B \rightarrow \mathbb{P}^1, \quad (3.2)$$

a threefold is constructed as the fiber product space

$$\tilde{X} = A \times_{\mathbb{P}^1} B := \{(u, v) \in A \times B \mid \pi_A(u) = \pi_B(v)\}. \quad (3.3)$$

This threefold can be viewed as an elliptic fibration over either A or B . When A and B both have singular fibers over a common point p in \mathbb{P}^1 , the resulting space \tilde{X} is itself singular.

B \ A	I_1	$I_{n>1}$	II	III	IV	I_n^*	IV^*	III^*	II^*
I_1	\mathcal{G}	\mathcal{G}	\mathcal{T}	\mathcal{G}	\mathcal{G}	\mathcal{S}^*	\mathcal{S}^*	\mathcal{S}^*	\mathcal{S}^*
$I_{m>1}$	\mathcal{G}	\mathcal{S}	\mathcal{T}	\mathcal{S}	\mathcal{S}	\mathcal{S}^*	\mathcal{S}^*	\mathcal{S}^*	\mathcal{S}^*
II	\mathcal{T}	\mathcal{T}	\mathcal{G}	\mathcal{T}	\mathcal{T}	\mathcal{G}^*	\mathcal{S}^*	\mathcal{S}^*	
III	\mathcal{G}	\mathcal{S}	\mathcal{T}	\mathcal{G}	\mathcal{T}	\mathcal{S}^*	\mathcal{S}^*		
IV	\mathcal{G}	\mathcal{S}	\mathcal{T}	\mathcal{T}	\mathcal{S}^*	\mathcal{S}^*			
I_m^*	\mathcal{S}	\mathcal{S}	\mathcal{G}	\mathcal{S}^*	\mathcal{S}^*				
IV^*	\mathcal{S}	\mathcal{S}	\mathcal{S}	\mathcal{S}^*					
III^*	\mathcal{S}	\mathcal{S}	\mathcal{S}^*						
II^*	\mathcal{S}	\mathcal{S}							

Table 2. Singularities of the MCP blowup: \mathcal{S} Smooth, \mathcal{T} Terminal \mathbb{Q} -factorial, or \mathcal{G} Global data needed to decide. For entries with an asterisk, a blowup of the base is needed to obtain a flat family.

Schoen showed in [8] that when the fibers on the two sides are of type I_n, I_m the threefold \tilde{X} gives rise to a smooth elliptically fibered Calabi–Yau threefold X after a small projective resolution of the singularities (unless $n = 1$ or $m = 1$, in which case the small projective resolution exists only if there is an appropriate “extra” divisor on \tilde{X}).⁸ Kapustka and Kapustka [11] generalized this result to include the coincident singular fibers $I_n \times III, I_n \times IV, II \times II$, and $III \times III$ of $\tilde{X} \rightarrow \mathbb{P}^1$. In the following subsection we analyze an even broader class of singularity combinations for which a Calabi–Yau threefold X can be constructed as an elliptic fibration over the base B (or a blowup thereof) by resolving singularities of a fiber product.

3.2 Allowed singularity pairs

Given a pair of rational elliptic surfaces A and B , we now study a fiber product $\tilde{X} = A \times_{\mathbb{P}^1} B$ along with one of its elliptic fibrations $\tilde{X} \rightarrow B$. If A and B have any singular fibers whose locations on \mathbb{P}^1 coincide, the total space \tilde{X} has singularities. Given that the singular fibers of the A and B fibration at p are of Kodaira type S_A and S_B , we denote the coincident singular fiber of $\tilde{X} \rightarrow \mathbb{P}^1$ at p by $S_A \times S_B$. There are three general possibilities for those singularities: either they have an MCP blowup which still has a flat fibration over the base B , or they have an MCP blowup which admits a flat fibration over a base \hat{B} which is a blowup of the original base B , or the singularities are worse than canonical and there is no MCP blowup.

In fact, the statements in question depend only on a small neighborhood of the point $p \in \mathbb{P}^1$ over which A and B each have a singular fiber. The following proposition explains what happens in each case.

Proposition 1 *Let $\mathbb{D} \subset \mathbb{P}^1$ be a small disk centered at a point p , and let $\tilde{X} \rightarrow B$ be the fiber product of two elliptic surfaces $\pi_A : A \rightarrow \mathbb{D}$ and $\pi_B : B \rightarrow \mathbb{D}$ considered as an elliptic*

⁸Note that in the absence of an appropriate “extra” divisor (which in this case is the graph of an isomorphism between A and B), Schoen showed that a non-Kähler small resolution always exists, but that there is no Kähler one.

fibration over B . Table 2 indicates the behavior of the singularities of \tilde{X} , as a function of the singularity types of the fibers of A and B at p , as follows:

- For cases denoted \mathcal{S} , there is an MCP blowup $X \rightarrow \tilde{X}$ that is smooth and has an induced flat elliptic fibration $X \rightarrow B$, as shown in [8] and [11] for the cases in the upper left box.
- For cases denoted \mathcal{G} , there is an MCP blowup $X \rightarrow \tilde{X}$ that has an induced flat elliptic fibration $X \rightarrow B$. The space X may or may not be smooth, depending on the existence of “extra” divisor(s) on \tilde{X} (which is a global consideration depending on more information than just the types of the singular fibers of A and B). Note that either all MCP blowups have a smooth total space, or none of them do.
- For cases denoted \mathcal{T} , there is an MCP blowup $X \rightarrow \tilde{X}$ that has a flat elliptic fibration $X \rightarrow B$, but for every MCP blowup, X is singular, as shown in [8], [11], and reviewed in Appendix A.
- For cases denoted \mathcal{S}^* , there is an MCP blowup $X \rightarrow \tilde{X}$ that is smooth and has a flat elliptic fibration $X \rightarrow \hat{B}$ over a base \hat{B} that is a blowup of the original base B .
- For the case denoted \mathcal{G}^* , there is an MCP blowup $X \rightarrow \tilde{X}$ that has an induced flat elliptic fibration $X \rightarrow \hat{B}$ over a base \hat{B} that is a blowup of the original base B . The space X may or may not be smooth, depending on the existence of “extra” divisor(s) on \tilde{X} (which is a global consideration depending on more information than just the types of the singular fibers of A and B). Note that either all MCP blowups have a smooth total space, or none of them do.
- For cases with no entry in Table 2, the singularities of \tilde{X} are worse than canonical and there is no MCP blowup. These singularities are separated from the bulk of the moduli space by an infinite distance, as shown by Hayakawa and Wang.

For notational convenience in our later discussion, when B requires no blowup we define $\hat{B} := B$ so that in every case we can refer to the flat elliptic fibration $X \rightarrow \hat{B}$.

In all cases other than those without entries, we expect a consistent F-theory model.

The cases in the upper left box of Table 2 are treated in [8] and [11]. We review some of the details in Appendix A. Among other things, ref. [8] spells out the “global considerations” when A and B come from rational elliptic surfaces over \mathbb{P}^1 and have singular fibers of types I_1 and I_n : the “extra” divisor in question is the graph of an isomorphism between A and B (which only exists when they are isomorphic).

There is a simple interpretation in the context of M-theory of terminal singularities that admit a small resolution locally, but that do not admit a global Kähler resolution unless there is a global section that can be used to resolve it completely. A terminal singularity of such type lies above a codimension-two locus in the base. There is a subset \mathcal{S} of irreducible curves that come from the local small resolution of the singularity, whose elements do not intersect any

fibrational resolution divisors. Recall that each fibrational resolution divisor represents an element of the Cartan of the non-abelian gauge algebra. Since the curves in \mathcal{S} do not intersect any of the fibrational resolution divisors, the only physical scenario in which the singularity can be completely resolved is when the curves in \mathcal{S} represent matter charged under some abelian gauge factor. Such a factor can only exist when there are additional global sections that intersect the curves in \mathcal{S} .

It is worth observing that the fiber product \tilde{X} is a partial resolution of singularities of the “Weierstrass fiber product”

$$\bar{X} := \bar{A} \times_{\mathbb{P}^1} \bar{B} := \{(\bar{u}, \bar{v}) \in \bar{A} \times \bar{B} \mid \pi_{\bar{A}}(\bar{u}) = \pi_{\bar{B}}(\bar{v})\}. \quad (3.4)$$

For analyzing the elliptic fibration $\tilde{X} \rightarrow B$, it is useful to also introduce the intermediate partial resolution $X' \rightarrow B$ defined by

$$X' := \bar{A} \times_{\mathbb{P}^1} B := \{(\bar{u}, v) \in \bar{A} \times B \mid \pi_{\bar{A}}(\bar{u}) = \pi_B(v)\}. \quad (3.5)$$

The fibration $X' \rightarrow B$ is in Weierstrass form, and the Weierstrass coefficients $f_{X'}$ and $g_{X'}$ are completely determined from those of \bar{A} by

$$\begin{aligned} f_{X'} &= \pi_B^*(f_{\bar{A}}) \\ g_{X'} &= \pi_B^*(g_{\bar{A}}). \end{aligned} \quad (3.6)$$

The original fiber product $\tilde{X} \rightarrow B$ is a partial resolution of singularities of $X' \rightarrow B$, and the total space X' is a partial resolution of singularities of \bar{X} . For most of the paper, we have chosen to refer to the F-theory compactification on \tilde{X} , as opposed to X' , to avoid confusion, although X' encodes enough data to define an F-theory background. On the other hand, we have been careful to refer to X' when discussing various singularities associated to the gauge group and matter content.

We are particularly interested here in the cases \mathcal{S}^* and \mathcal{G}^* , where a blowup of the base is needed to resolve the singularities. Such geometries were not considered in [8] and [11].

3.3 Example: I_0^* singularities in B

As an example, we work out in detail the case where B considered as an elliptic fibration over \mathbb{P}^1 contains a singular fiber of type I_0^* over a point $p \in \mathbb{P}^1$. In this case, as shown in Table 1, B contains a singular elliptic curve C described by a single -2 curve taken with multiplicity two, which intersects four other -2 curves each taken with multiplicity one. If A also contains a singular fiber at the point p , then the fiber product space \tilde{X} defined through (3.3) is singular. Considering \tilde{X} as an elliptic fibration over B , the type of singularity in A over p determines the degrees of vanishing of f, g, Δ along the curve C in the Weierstrass model $\hat{X} \rightarrow B$ of \tilde{X} . For example, if there is a type *III* singularity in A over p , then the component of C that is a -2 curve with multiplicity 2 will have degrees of vanishing of f, g, Δ of $(2, 4, 6)$, while the degree of vanishing over the other -2 curves will be $(1, 2, 3)$. The multiplicity of f, g, Δ at a

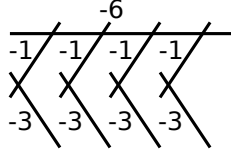

Figure 1. The configuration of intersecting divisors of negative self intersection on \widehat{B} that replaces the I_0^* configuration of -2 curves in the surface B when a fiber product space \widetilde{X} is formed from B and a rational elliptic surface A with a type IV singularity over the same point p as the I_0^* singularity in A , and $X \rightarrow \widetilde{X}$ resolves the singularities, giving an elliptic fibration over the blowup \widehat{B} .

point in B where two curves intersect, over each of which the fibration becomes singular, will generically be the sum of the degrees of vanishing over the two curves. Thus, in the case of the type III singularity in A , the multiplicities of f, g, Δ at the intersection points between the -2 curves that meet will be $(3, 6, 9)$. In such a case, all the singularities of \widetilde{X} can be resolved by a crepant projective blowup.

If the multiplicities of f, g, Δ at any point in the surface B reach or exceed $(4, 6, 12)$, however, then any MCP blowup of the Calabi–Yau total space creates a new divisor and so the map to B is not equidimensional. To avoid this, we blow up the base B before resolving singularities, giving a new surface \widehat{B} . If A contains a singularity of type IV , for example, the degrees of vanishing on the -2 curve in B of multiplicity 2 become $(4, 4, 8)$, while the degrees of vanishing on the other -2 curves become $(2, 2, 4)$, and the multiplicities at the intersection points become $(6, 6, 12)$. In this case, each of the intersection points must be blown up. This gives four new -1 curves in the base (the exceptional divisors of the blowups), and the self-intersections of the original -2 curves become -6 for the curve of multiplicity 2, and -3 for the curves of multiplicity one. The resulting Calabi–Yau X is then an elliptic fibration over a new surface \widehat{B} that contains in place of the original union of -2 curves of type IV the configuration of curves shown in Figure 1. The degrees of vanishing of f, g, Δ over the exceptional curves arising from the blowup are given by subtracting $(4, 6, 12)$ from the multiplicities at the original intersection point, so in this case are given by $(2, 0, 0)$.

Since there are no points on \widehat{B} where f, g, Δ vanish to degrees 4, 6, 12, the Weierstrass model $X' \rightarrow B$ blows up to a Weierstrass elliptic fibration $\widehat{X} \rightarrow \widehat{B}$ with codimension one Kodaira singularities of types IV^* and IV over the -6 and -3 curves in B' respectively; the standard resolution of these singularities gives a smooth Calabi–Yau threefold X that is elliptically fibered over \widehat{B} .

If we increase the singularity on A over p further, the fiber product space no longer has canonical singularities. For example, if there is a type I_0^* singularity on A , this gives vanishing degrees of 4, 6, 12 over the -2 curve with multiplicity 2 in B . Such a singularity cannot be blown up in a way that gives a Calabi–Yau total space, regardless of whether points in the base B are blown up.

3.4 Blowup geometry

The other cases described in Proposition 1 can be analyzed in a parallel fashion. In each case, thinking of \tilde{X} as an elliptically fibered space over the base B , a singularity in the elliptic fibration structure of A corresponds to vanishing degrees of f, g, Δ over the corresponding fiber in B , according to Table 1. In each case, this imposes vanishing degrees on the constituent -2 curves in the singular fiber of B ; if the multiplicities reach 4, 6, 12 at a point than the point in B must be blown up, while if the vanishing degrees on a curve reach 4, 6, 12, then the space does not have canonical singularities, so no blowup will produce a Calabi–Yau variety. Carrying out this algorithm for each of the cases involving a blowup on B , we arrive at the curve geometries illustrated in Figure 2 in the blown up \hat{B} that supports an elliptically fibered Calabi–Yau threefold X with at worst \mathbb{Q} -factorial terminal singularities. We note that the un-labeled curves in the first column of the Figure all have self-intersection -2 .

There are five basic types of cases shown in Figure 2.

1. For each of the first four B-fiber types I, II, III, IV , the cases depicted in the first diagram of A-fibers require no blowup of the base and the analysis is just the one given in [8] and [11] and summarized in Proposition 1.
2. For each the last three B-fiber types I_n^*, IV^*, III^* , the cases with A-fiber of type I_n have gauge groups forming a quiver that reproduces an affine simply laced Dynkin diagram on the base, considered in [71].
3. For all other entries whose A-fiber is not of type II or type I_n^* , the final blown up configuration consists of non-Higgsable clusters [1] joined by -1 curves (discussed further in §3.5), and as a result, the resolution of the codimension-one singular locus resolves the singularities. The Kodaira fiber types are those dictated by the non-Higgsable clusters. Note that in several instances, there are -1 curves of Kodaira type II that do not belong to a non-Higgsable cluster: those are -1 curves joining a -5 curve to a -3 curve, which occur for $III^* \times I_n$ and for $II \times III^*$ (see also [42]). All other -1 curves are Kodaira type I_0 (*i.e.*, nonsingular fibers). There are some clusters consisting of only a single -2 curve without a gauge group, as in the $IV^* \times II$ and $I_0^* \times III$ examples, and these also have Kodaira type I_0 .
4. When the A-fiber is of type II and the B-fiber is of type IV^* , the intersections among curves in the base to be concerned with have types $II-IV$ and $IV-I_0^*$. These all have crepant projective resolutions [12, 72].

On the other hand, when the A-fiber is of type II and the B-fiber is of type I_m^* , the MCP blowup is not smooth. We consider this case in Appendix B.

5. When the A-fiber is of type I_n^* , there are two kinds of resolutions that may be needed. In most cases, we have an I_n^* curve transversally intersecting an I_{2n} curve. (Note that the transversality of the intersection gives monodromy to the I_{2n} curve so that the

corresponding gauge algebra is $\mathfrak{sp}(n)$.) The singularities that appear here were explicitly resolved by Miranda [12].

On the other hand, for a base with a type II fiber, we have an I_n^* curve that is simply tangent to an I_{2n} curve. We consider the MCP blowup of this case in Appendix B.

3.5 Combining rational elliptic surfaces

Persson’s list [14, 15] gives the 279 possible combinations of singular fibers that can arise in a rational elliptic surface. A wide range of Calabi–Yau threefolds can be constructed by choosing each of A and B from this list, and then selecting combinations of coincident singular fibers that satisfy the constraints of Proposition 1.⁹

As an example, one allowed configuration on Persson’s list is a collection of three type IV singularities. If we choose both A and B to be this type of rational elliptic surface, there are four distinct classes of smooth Calabi–Yau threefolds that can be constructed, depending on whether 0, 1, 2, or 3 pairs of type IV singularities on A and B are chosen to lie over coincident points p in the common base \mathbb{P}^1 .

The rank of the Mordell–Weil group of the Calabi–Yau threefold X considered as an elliptic fibration over \widehat{B} can be found by subtracting the rank contribution from each singularity in A as listed in Table 1 (in the absence of global sections of X that do not come from pulling back the global sections of A). Thus, in the preceding example with three coincident $IV \times IV$ pairs, the Mordell–Weil group of the resulting $X \rightarrow \widehat{B}$ is $8 - 3 \times 2 = 2$.

As another example, we can take B to be a rational elliptic surface with two I_0^* singular fibers. We can choose A to have type IV singular fibers at the points corresponding to the two singular fibers of B . This reduces the rank of the Mordell–Weil group to 4, for a generic elliptic fibration over the blown up base \widehat{B} , which has within it two configurations of curves as shown in Figure 1. In addition to the two IV singularities, we can arrange additional singular fibers in A , but the total degree of vanishing of Δ of the additional fibers can be at most 4. We describe this configuration more explicitly in the following section, as an example of a case where the base has \mathbb{C}^* -structure and the generic elliptic fibration has a Mordell–Weil group with nonzero rank.

In [1], two of the present authors used a physically motivated approach to identify all possible connected configurations of curves of negative self intersection -2 or below that can lie in a surface B that supports an elliptically fibered Calabi–Yau threefold with section. Such configurations consist of single curves of negative self intersection $-3, \dots, -8, -12$, linear chains of curves of self intersection $(-3, -2), (-3, -2, -2), (-2, -3, -2)$, and general configuration of -2 curves. Furthermore, there are strong restrictions on which combinations of these “non-Higgsable clusters” can be connected by -1 curves, as detailed in [1]. As mentioned in the

⁹ There is one additional condition that must be considered in general: whether the locations of the points in the discriminant locus on each fibration can be tuned to that the desired points coincide between the two fibrations. However, in all of our explicit examples, we consider three singular fibers or fewer, and this is not an issue in those cases.

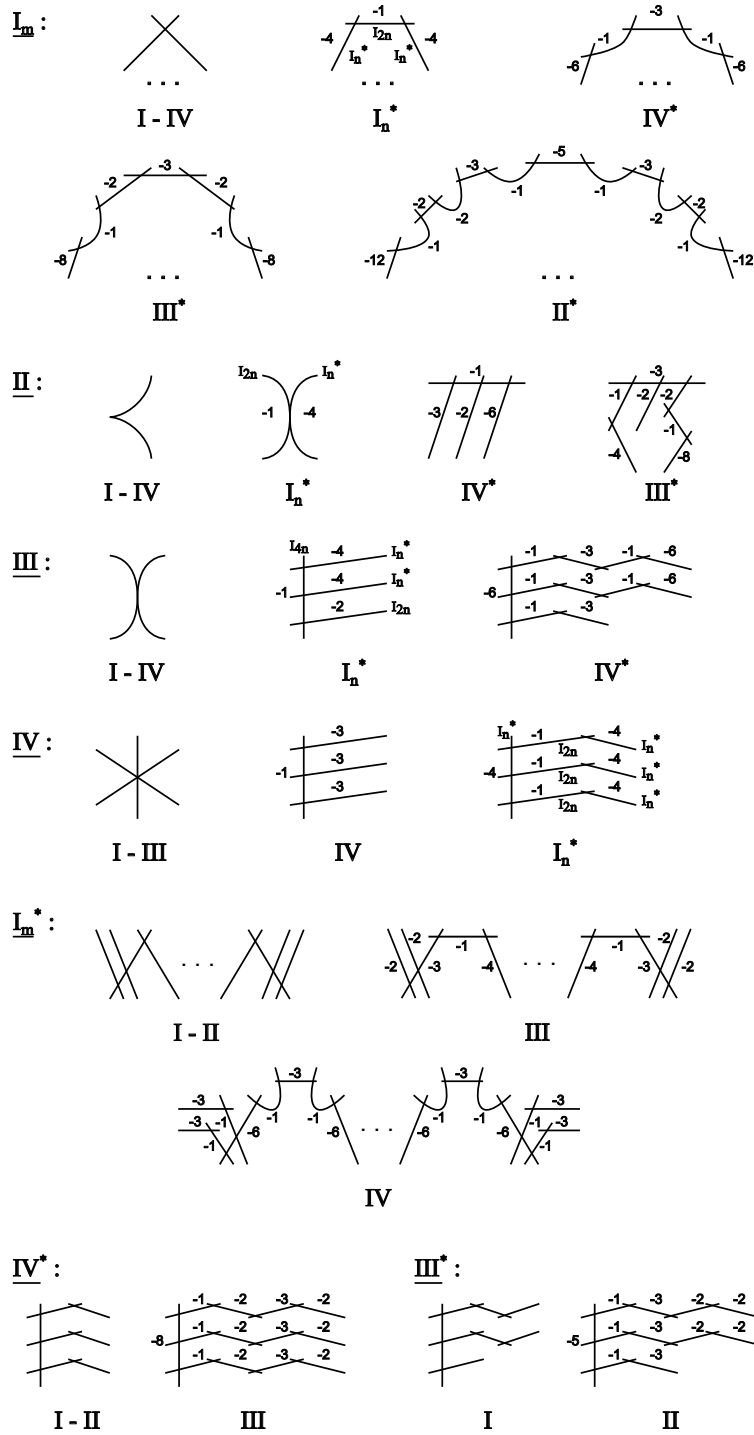

Figure 2. Geometries of the blown up rational curve configurations in \widehat{B} for different B-fiber types. (The B-fiber type is indicated by underlining).

previous section, all of the configurations of curves in blown up bases \widehat{B} as described above consist of various combinations of these clusters, connected in allowed ways by -1 curves. We note that while these configurations of curves are associated to non-Higgsable gauge groups in the low-energy theory [1], the manifolds obtained by resolving the coincident singular fibers may have enhanced gauge symmetry that can be Higgsed further down. For example, any of the base singularities coincident with an I_n or I_n^* singularity with large enough n along the A -direction has enhanced gauge symmetry. The theories whose gauge/matter sector consist of only non-Higgsable clusters can be obtained from these manifolds by further setting the complex structure to a generic point, and thereby completely Higgsing the gauge groups that could be gotten rid of this way. Only after this Higgsing do we arrive at a generic elliptic fibration over the same base \widehat{B} obtained by the resolution procedure.

3.6 Conifold transitions, the Higgs mechanism, and massless hypermultiplets

One of the most subtle aspects of Mori theory is the issue of small resolutions (or small partial resolutions) of terminal singularities. As explained in §2, when there is no crepant projective blowup possible, the singularity is called \mathbb{Q} -factorial, and this is a property we expect thanks to Mori theory. Whether there exists a crepant projective blowup is a question that cannot be decided by simply analyzing a small neighborhood of the terminal singular point in question: from the point of view of algebraic geometry, the crucial question is whether or not a certain global divisor exists on the singular space.

This issue is familiar from its appearance in the first example of a conifold transition studied in the physics literature [73–75]. In that example, a limiting quintic threefold contains 16 conifold points, all located in a single \mathbb{P}^2 contained within the limiting quintic. When the \mathbb{P}^2 is blown up, all 16 conifold points are resolved to \mathbb{P}^1 s, but they only contribute a single Kähler class to the blown up threefold. In other words, these small blowups are not independent: all 16 must be done at once, or none at all can be done. In particular, all of the \mathbb{P}^1 s lie in a common homology class.

Furthermore, as emphasized in [76], each conifold point has an S^3 “vanishing cycle” in any nearby nonsingular quintic threefold. But these S^3 ’s are also not independent in homology: there is a linear relation among them which implies the existence of a 4-chain whose boundary is that linear relation. In the conifold limit, the 4-chain becomes a 4-cycle, namely, the divisor which is to be blown up. Thus, an alternate description of the global issue is the question of whether the vanishing cycles of the individual conifold points are linearly independent in homology or not.

This transition is interpreted in [75, 76] as an instance of the Higgs mechanism for a $\mathfrak{u}(1)$ gauge symmetry.¹⁰ The blown up space has a $\mathfrak{u}(1)$ gauge symmetry and 16 massive hypermultiplets of charge 1, represented by M2-branes wrapping \mathbb{P}^1 s. When we blow down, the 16 hypermultiplets become massless. As discussed in [75, 76], the space of flat directions which enable the transition can be identified with the space of homology relations among the

¹⁰The discussion in [75, 76] is in terms of type II string theory, but we give an M-theory version here [77].

\mathbb{P}^1 s. If there were only a single \mathbb{P}^1 charged under the $\mathfrak{u}(1)$ (and hence no homology relation), there would be no flat direction and no transition.¹¹ Note that on the Higgs branch, the massless hypermultiplets which arose from flat directions no longer have an interpretation in terms of wrapped branes.

More generally,¹² we can consider a transition in which the complex structure of a Calabi–Yau manifold is deformed until it acquires δ conifold points whose vanishing cycles admit ρ homology relations. At the transition point, the ρ 4-chains will all become 4-cycles realized by divisors, which both enhance the gauge symmetry by $\mathfrak{u}(1)^{\oplus\rho}$ and provide the geometric ingredients needed for performing the small blowups. The intersections of the \mathbb{P}^1 s with the new divisors after blowing up determine the charges and the homology classes, and we see that there must be $\delta - \rho$ homology relations among the \mathbb{P}^1 s.

If we approach the transition from the Coulomb branch, *i.e.*, approach the singular space by blowing down a collection of δ \mathbb{P}^1 s, we get one massless hypermultiplet for each of the \mathbb{P}^1 s, each charged under the $\mathfrak{u}(1)$. There are $\delta - \rho$ flat directions, corresponding to the $\delta - \rho$ homology relations among the \mathbb{P}^1 s, leaving only $\delta - \rho$ “new” massless hypermultiplets on the Higgs branch. On the other hand, if we approach the transition from the Higgs branch by “unHiggsing,” *i.e.*, approach the singular space by complex structure deformation, we again associate one massless hypermultiplet to each of the δ conifold points. Out on the Higgs branch they are uncharged; however, the charges at the transition point are associated to the coefficients in the corresponding homology relation among the vanishing cycles (since those coefficients go over to intersection numbers once the 4-chain becomes a 4-cycle [76]).

Note that the extreme cases $\rho = 0$ and $\rho = \delta$ are both allowed. If $\rho = 0$ then no blowup is possible and we have only a Higgs branch. On the other hand, if $\rho = \delta$ then the neutral massless hypermultiplets are identical on Higgs and Coulomb branches. In other words, the Coulomb branch contains everything and there is no Higgs branch *per se*.

For more general terminal singularities, we expect a similar pattern: in the limit of a complex structure deformation, (1) each vanishing cycle should be associated to a massless hypermultiplet [82], (2) each independent homology relation among vanishing cycles should determine a $\mathfrak{u}(1)$ in the limiting theory, and (3) the charges of each massless hypermultiplet should be determined by the coefficient of its vanishing cycle in the appropriate homology relations.

To illustrate this, let us consider the simplest case where a \mathbb{Q} -factorial terminal singularity arises in the classes of manifolds of interest. Let us take a family X_t of manifolds where the A and B fibrations are generic with twelve I_1 singularities. Let us assume that at $t = 0$, there

¹¹This follows from a mathematical result of Friedman [78], which states that given a collection of disjoint contractible rational curves C_1, \dots, C_k on a Calabi–Yau threefold X , the singular space \bar{X} obtained by contracting these curves can be smoothed by a complex structure deformation if and only if there is a relation $\sum_{j=1}^k a_j [C_j] = 0$ among the homology classes $[C_j]$ such that all coefficients a_j are nonzero. This does not contradict the result of Namikawa and Steenbrink [68] because \bar{X} is not \mathbb{Q} -factorial.

¹²The mathematics of the general situation was analyzed in [79, 80, 78] and the physics was discussed in [81].

is a coincident $I_1 \times I_1$ fiber over a single point on the base \mathbb{P}^1 . Upon moving to this point by taking $t \rightarrow 0$, a single 3-cycle vanishes and shrinks into a conifold singularity. The discriminant locus of $X_0 \rightarrow B$ has a single nodal singularity above which the conifold singularity is located. There is, however, no global divisor that can be utilized to resolve this singularity, and thus there is no enhanced gauge symmetry at this point. Following the discussion presented above, we find that a single neutral massless hypermultiplet is localized at this conifold singularity.

These types of singularities can also arise at points containing matter charged under nonabelian groups, particularly in cases where the Kodaira singularity type associated with the nonabelian algebra is non-minimal. In Appendix B, we describe another class of examples where extra states arise at the intersection of type $IV-IV$ tunings of the gauge algebra $\mathfrak{su}_2 \oplus \mathfrak{su}_2$. Another example of this was encountered in [2], where an additional uncharged scalar at a $III-IV$ intersection fills out the desired matter content of the standard model gauge algebra $\mathfrak{su}_2 \oplus \mathfrak{su}_3$.

4 Elliptic fibrations over bases with a \mathbb{C}^* -structure

An interesting set of examples of the threefolds described in this paper were recently encountered from a somewhat different direction. Using the analysis of [1] describing allowed configurations of curves of negative self intersection in any given base, a complete list of toric bases for elliptically fibered Calabi–Yau threefolds was given in [43]. This work was extended in [42] to include all bases that admit a (single) \mathbb{C}^* action.¹³ Of the more than 100,000 \mathbb{C}^* bases in this class, a small number (thirteen) have the property that the generic elliptic fibration over these bases has a nonzero Mordell–Weil rank. These bases are tabulated in Appendix C. We will refer to these bases as $\widehat{B}_1, \dots, \widehat{B}_{13}$ where the data describing \widehat{B}_k is given in equation (C.k).

Each of these bases can be described as a blowup of a Hirzebruch surface \mathbb{F}_m with two disjoint sections Σ_0, Σ_∞ and some number N of fibers along which points either on one of the sections or at an intersection of exceptional divisors are blown up, which maintains the \mathbb{C}^* structure. Thus, each such base can be characterized by the self intersections n_0, n_∞ of the two sections, and N chains of divisors of given negative self intersections that connect the two sections. Each of these bases and the corresponding elliptically fibered Calabi–Yau threefolds correspond to one of the fiber product constructions described in the previous section.

4.1 Examples

As an example, consider the base \widehat{B}_{13} . This base contains two I_0^* configurations of -2 curves, connected by four -1 curves. This is therefore a rational elliptic surface with two I_0^* singular fibers. The Hodge numbers of the Calabi–Yau threefold that is a generic elliptic fibration over a rational elliptic surface are $h^{1,1} = h^{2,1} = 19$. The Mordell–Weil rank of this threefold is $r = 8$. An explicit determination of the moduli in the Weierstrass model for elliptically fibered

¹³Such surfaces have been studied for decades (see *e.g.* [83, 84]) and have recently been recognized as a special case of “T-varieties” [85].

Calabi–Yau threefolds over this base using the methods developed in [42] confirms that the Weierstrass coefficients can be described as

$$\begin{aligned} f &= f_0 z^4 + f_1 z^3 w + \cdots + f_4 w^4 \\ g &= g_0 z^6 + g_1 z^5 w + \cdots + g_6 w^6, \end{aligned} \tag{4.1}$$

where z, w are homogeneous coordinates on the base \mathbb{P}^1 over which \widehat{B}_{13} is itself an elliptic fibration. These can be tuned, for example, to produce a type II^* singularity at a point in \mathbb{P}^1 by arranging the coefficients so that $f = a(z - \alpha w)^4, g = b(z - \alpha w)^5(z - \beta w)$. Such a tuning corresponds to having an additional type II^* singular fiber in A at a point on \mathbb{P}^1 away from the singular fibers of \widehat{B}_{13} . Since the rank reduction from the II^* singularity is 8, the resulting Calabi–Yau manifolds have Mordell–Weil rank 0; in physics terminology, the 8 abelian gauge fields associated with a reduction of F-theory on \widehat{B}_{13} can all be simultaneously “unHiggsed” to form an E_8 gauge group.

Now, consider the base \widehat{B}_{12} . This base is identical to \widehat{B}_{13} except that one of the I_0^* configurations of -2 curves has been replaced by the configuration of divisors shown in Figure 1, corresponding to the tuning of a type IV $(2, 2, 4)$ vanishing on one of the singular fibers of the rational elliptic surface \widehat{B}_{13} . This corresponds to a fiber product construction where the base B has two I_0^* singular fibers and the base A has a single type IV fiber at the same point as one of the singular fibers on B . The Calabi–Yau threefold \widehat{X} given by resolving a generic elliptic fibration over the base \widehat{B}_{12} generically has Mordell–Weil rank 6, where two of the sections have been lost from the type IV tuning. The Weierstrass moduli for elliptic fibrations over \widehat{B}_{12} are those in (4.1), with the first (or last) two coefficients in both f and g dropped. In this situation again the abelian gauge fields can be all simultaneously unHiggsed. This can be done by tuning an additional IV^* at a further point on the \mathbb{P}^1 , corresponding to the combination IV, IV^* that is available on the Persson list; in the physical theory, this combines the remaining 6 abelian gauge fields into an E_6 gauge group.

Finally, consider the base \widehat{B}_8 . In this base, both I_0^* fibers have been given type IV singularities, so each cluster of -2 curves has been replaced by the configuration of divisors in Figure 1. The resulting Calabi–Yau threefold has Mordell–Weil rank 4, and the Weierstrass coefficients are parameterized as

$$f = f_2 z^2 w^2 \tag{4.2}$$

$$g = g_2 z^4 w^2 + g_3 z^3 w^3 + g_4 z^2 w^4. \tag{4.3}$$

We can now ask how much of the remaining Mordell–Weil rank can be removed by tuning an additional singularity over a point in \mathbb{P}^1 . The discriminant is essentially a quartic, so the most we could hope for would be to tune a type I_4 singularity of rank 3. Even this cannot be done, however, since to give Δ four equal roots would require setting $f = 0, g = az^2 w^2(z - \alpha w)^2$, which would be a $(2, 2, 4)$ singularity having rank only 2. Thus, in this case, in the physics language there are two abelian gauge factors that cannot be removed by unHiggsing. The fact

that the type I_4 singularity cannot be tuned over this base matches with the fact that the singularity combination IV, IV, I_4 does not appear in Persson’s list.

We have therefore seen that the three bases \widehat{B}_{13} , \widehat{B}_{12} , and \widehat{B}_8 are a sequence of bases corresponding to progressive tunings of higher singularities in a rational elliptic surface A that we fiber product with the original base B given by \widehat{B}_{13} .

4.2 The other bases

A similar analysis shows that the other 10 bases listed in Appendix C have similar descriptions through sequences of blowups of a rational elliptic surface B associated with fiber products with different rational elliptic surfaces A . The difference in the other cases is that the rational elliptic surface B itself does not have a description as a \mathbb{C}^* base. We consider each family in turn.

$$\widehat{B}_{11} \rightarrow \widehat{B}_{10}, \widehat{B}_9 \rightarrow \widehat{B}_5$$

The base \widehat{B}_{11} is constructed from a type IV fiber with a IV tuning on the left and a type IV^* fiber on the right, with generic Mordell–Weil rank 6. \widehat{B}_{10} comes from a type III tuning on the right (reducing the Mordell–Weil rank by 1), and \widehat{B}_9 comes from an increased tuning to I_0^* on the left (reducing the Mordell–Weil rank by another 2). The base \widehat{B}_5 comes from combining these tunings, with a final Mordell–Weil rank of 3. The resulting f, g each have only two terms, so the highest nonabelian rank that can be reached by further tuning at an additional point in \mathbb{P}^1 is rank 1 from a $(1, 2, 3)$ tuning. Thus, again, in this case the original base associated with \widehat{B}_5 has two abelian gauge fields that cannot be removed by unHiggsing. Again, this matches with the Persson list, which does not allow any combination of singularities with total rank more than 1 beyond the combination III, I_0^* .

$$\widehat{B}_6 \rightarrow \widehat{B}_7, \widehat{B}_3 \rightarrow \widehat{B}_4$$

The base \widehat{B}_6 is built from a type III fiber on the left, and a III^* fiber on the right, with an I_0^* tuning on the left, giving Mordell–Weil rank 4. \widehat{B}_7 comes from a II tuning on the right, \widehat{B}_3 comes from a IV^* tuning on the left, and \widehat{B}_4 follows from both tunings, with a Mordell–Weil rank of 2. The resulting f, g have respectively one and two terms. In this case, an I_2 singularity can be tuned by choosing f precisely to flip the sign of the middle term in the discriminant $4f^3 + 27g^2$. This corresponds to the allowed combination II, IV^*, I_2 in Persson’s list, giving in this case a single abelian field corresponding to the base \widehat{B}_4 that cannot be unHiggsed.

$$\widehat{B}_2 \rightarrow \widehat{B}_1$$

Finally, the base \widehat{B}_2 is built from a type II fiber with a IV^* tuning on the left and a type III^* fiber on the right. The Mordell–Weil rank of 2 is reduced to 1 on base \widehat{B}_1 , where the tuning on the left is enhanced to III^* . The resulting f, g have 2 terms each, so it is possible to tune an additional III or I_2 singularity at another point on the base \mathbb{P}^1 , reducing the Mordell–Weil rank to 0. Again, this matches with the fact that the III^*, III and III^*, I_2

singularity combinations are both allowed on Persson’s list.

Thus, all of the bases identified in [42] that have \mathbb{C}^* structure and nonzero Mordell–Weil rank everywhere in the Calabi–Yau moduli space fit into the classification of models described in this paper. Matching with the results of [33], in the case where the Mordell–Weil rank over a given base is generically 1, there is a tuning of the Weierstrass degrees of freedom that transforms the extra section into a vertical divisor associated with an additional Kodaira type singularity. In cases where the Mordell–Weil rank is generically greater than one, however, we have found several situations where the entire Mordell–Weil rank cannot be removed by tuning moduli to convert the sections to vertical divisors. In all the cases we have studied, there is a perfect matching between the possible tunings that remove Mordell–Weil rank and Persson’s list of allowed singularity types for the rational elliptic surface A with which we can take the fiber product.

5 Aspects of abelian gauge symmetry

The generalization of Schoen manifolds that we study generically have non-trivial Mordell–Weil groups. This implies that many of the F-theory compactifications on these manifolds have abelian gauge symmetry. In this section, we study aspects of the abelian gauge symmetry of these vacua.¹⁴

For the purposes of studying the abelian gauge symmetry of an F-theory compactification on the MCP blowup X of $\tilde{X} = A \times_{\mathbb{P}^1} B$, it is useful to start with the family of varieties $X_t = \tilde{X}_t = \bar{X}_t = A_t \times_{\mathbb{P}^1} B$, where A_t is a generic elliptic fibration over \mathbb{P}^1 for $t > 0$, none of whose singular fibers (which are all I_1) are coincident with those of B . We can arrive at $\tilde{X} = \tilde{X}_0$ by tuning the complex structure coefficients of X_t , which either corresponds to unHiggsing matter charged under a gauge group, turning off a Higgs branch operator in a strongly coupled SCFT [70, 86, 87], or both. We view the F-theory compactification on the MCP blowup $X \rightarrow \tilde{X}$ as a theory obtained from X_t by first moving to a special point $t = 0$ in the Higgs branch moduli space which has enhanced gauge symmetry and/or a strongly coupled sector, and then moving on the tensor branch of that strongly coupled sector, if applicable, corresponding to blowing up one or more points on B .

For a generic fibration A_t the Mordell–Weil group $MW(X_t)$ is free and has rank 8. All the generators of this group can be obtained by pulling back the generators of $MW(A_t)$. \bar{X}_t is a smooth Calabi–Yau manifold with no codimension-two singular fibers, and thus nothing is charged under these $\mathfrak{u}(1)$ s—the 8 $\mathfrak{u}(1)$ s are non-Higgsable. Upon going to the locus \tilde{X} , two things can happen that can affect the abelian gauge group of the theory:

1. A develops singular fibers beyond I_1 and II (which can either coincide with singular fibers of B or not), contributing negatively to the MW rank.

¹⁴Throughout this section, we refer to the gauge algebra, rather than the gauge group of the theory, to avoid subtleties involving the global structure of the gauge group. We also only concern ourselves with the “free part” of the Mordell–Weil group of an elliptic fibration X , which is obtained by quotienting the group by its torsion subgroup. We denote this group $\bar{MW}(X)$, as opposed to the Mordell–Weil group $MW(X)$.

2. A global divisor, which can be used to blow up a collection of codimension-two singular fibers, develops, contributing positively to the MW rank.

In event 1, a subset of the $\mathfrak{u}(1)$ components of the gauge algebra enhances into a non-abelian gauge component $\tilde{\mathfrak{g}}$, whose gauge algebra can be read off of the singular fibers of A . The subset of the $\mathfrak{u}(1)$ components that are enhanced can be identified with the Cartan subalgebra of $\tilde{\mathfrak{g}}$. Recall that the divisors of a rational surface form the lattice with the inner product $\tilde{U} \oplus (-E_8)$ with

$$\tilde{U} = \begin{pmatrix} 0 & 1 \\ 1 & -1 \end{pmatrix}, \quad (5.1)$$

which is given by the intersection pairing of the surface. The sublattice \tilde{U} is spanned by the fiber and the zero-section of the rational surface, while the E_8 lattice is spanned by the rest of the divisors. Denoting the set of irreducible components of all the singular fibers to be T_A , the Cartan matrix of $\tilde{\mathfrak{g}}$ can be identified by the intersection matrix of T_A . Meanwhile, the orthogonal complement $T_{A,\perp}$ of T_A with respect to the $(-E_8)$ lattice is called the essential sublattice of the Néron-Severi group of A , and can be identified with the “free part” $\widehat{MW}(A)$ of the Mordell–Weil group of A [88]. These elements pulled back to the MCP blowup of $X \rightarrow \tilde{X}$ span the subgroup $\widehat{MW}_A(X)$, whose rank we denote r_A , of $\widehat{MW}(X)$. These are to be identified with the $\mathfrak{u}(1)$ s in X_t that did not enhance to anything upon moving to the locus \tilde{X} .

Event 2 introduces additional $\mathfrak{u}(1)$ factors into the fray. A simple example is when the complex structure of A is tuned to be isomorphic to that of B . \tilde{X} then has 12 $I_1 \times I_1$ singularities, with codimension-two singularities localized at the 12 nodal points of the I_1 fibers in the base. In this case, as originally explained in [8], the singularities can be resolved by blowing up along the graph of the isomorphism, which is just the image Γ of the points $(x, x) \in A \times B$ under the map $A \times B \rightarrow A \times_{\mathbb{P}^1} B$. Thus X has MW rank 9, and the gauge algebra of the theory is given by $\mathfrak{u}(1)^{\oplus 9}$. Note that Γ passes through all the 12 singularities, thus implying that there are 12 hypermultiplets carrying unit charge under the new $\mathfrak{u}(1)$.

While \tilde{X} is a singular space, we note that the complex structure of the A and B fibrations and the Kähler modulus of the base manifold B suffice to define a sensible physical theory, as long as all the coincident singular fibers of \tilde{X} are one of the allowed types in Table 2. One may have concerns about the existence of codimension-two singularities on B that require blowing up the base, but these singularities merely indicate that the effective theory can be understood as a gauge theory with hypermultiplets and SCFTs coupled to gravity, with subgroups of the global symmetry groups of the SCFTs possibly gauged.¹⁵

With this picture in mind, let us now focus our attention to certain aspects of the abelian gauge group of the variety X . In §5.1, we study the abelian anomaly coefficients of F-theory compactified on X . This corresponds to the height-pairing matrix of the rational sections of the threefolds [89]. In §5.2, we study the problem of enhanceability of the abelian gauge group,

¹⁵Some basic checks on the consistency of these effective theories have been carried out in [87].

i.e., whether generators of the Mordell–Weil group can be localized to Kodaira singularities by tuning the complex structure. In particular, we show that there are many manifolds for which there exist factors of the abelian gauge group that cannot be “unHiggsed,” or equivalently, “enhanced” into a non-abelian gauge group without introducing problematic singularities.

5.1 Abelian anomaly coefficients

In this section, we mainly study the anomaly coefficients of the $\mathfrak{u}(1)$ components of the gauge algebra that correspond to the generators of the subgroup $\widehat{MW}_A(X)$ of the free part $\widehat{MW}(X)$ of $MW(X)$. As noted previously, these $\mathfrak{u}(1)$ s are the $\mathfrak{u}(1)$ s in the compactification on X_t that did not enhance to a non-abelian gauge symmetry at the \tilde{X} locus. At the end of the section, we present a computation of the anomaly coefficients of the MW rank 9 example introduced above.

Before going on further, let us recall some basic facts about abelian anomaly coefficients in F-theory compactifications on Calabi–Yau threefolds. The anomaly coefficients are bilinear forms on the abelian gauge algebra that are valued in the second homology of the base manifold. More concretely, labeling the components of the abelian gauge algebra by $M, N, P, Q \dots$, the anomaly coefficients take the form b_{MN} , where each b_{MN} is a divisor class in the base of the elliptic fibration [90]. Given the Kähler class j of the base, the kinetic terms for the $\mathfrak{u}(1)$ gauge fields are given by

$$j \cdot b_{MN} F^M \wedge *F^N, \quad (5.2)$$

where F^M is the field-strength two-form for the M th $\mathfrak{u}(1)$. Furthermore, the abelian anomaly equations are given by

$$-6K \cdot b_{MN} = \sum_I q_M^I q_N^I, \quad b_{MN} \cdot b_{PQ} + b_{MP} \cdot b_{NQ} + b_{MQ} \cdot b_{NP} = \sum_I q_M^I q_N^I q_P^I q_Q^I, \quad (5.3)$$

where \cdot here denotes the intersection pairing in the base. The variable I summed over on the right-hand side of the equations indexes all the individual hypermultiplet components in the theory, and q_M^I is the charge of the I th hypermultiplet under the M th $\mathfrak{u}(1)$. Writing the rational section corresponding to the M th abelian gauge component as S_M , the anomaly coefficient can be computed geometrically by the formula [89]

$$b_{MN} = -\pi_B(\sigma(S_M) \cdot \sigma(S_N)) \quad (5.4)$$

where σ denotes the Shioda map [88, 89, 25] and the dot on the right-hand side of this equation is the intersection pairing within the Calabi–Yau manifold. π_B is the projection map to the base.

Let us now label the (free) basis of $\widehat{MW}(A) \cong \widehat{MW}_A(X) \subset \widehat{MW}(X)$ by the indices m, n, p, q, \dots and proceed to compute b_{mn} , which is the projection of the bilinear form b_{MN} on $\widehat{MW}(X)$ (viewed as a vector space) to the subspace $\widehat{MW}_A(X)$. Recall from the discussion at the beginning of the section that for sections s_m of A , the Shioda pairing is given by

$$\sigma(s_m) \cdot \sigma(s_n) = (T_{A,\perp})_{mn}, \quad (5.5)$$

where $T_{A,\perp}$ is the orthogonal complement of the lattice spanned by singular fibers of A with respect to $(-E_8)$. Now let us denote the pull-back of s_m to X by S_m . Then the main claim of this section is that

$$b_{mn} = -\pi_B(\sigma(S_m) \cdot \sigma(S_n)) = -(T_{A,\perp})_{mn} F_{\widehat{B}}, \quad (5.6)$$

where $F_{\widehat{B}}$ is the fiber class of the base \widehat{B} . It is convenient to express this equation in the notation

$$b_A = -T_{A,\perp} \otimes F_{\widehat{B}}. \quad (5.7)$$

The self-intersection of $F_{\widehat{B}}$ being zero, the anomaly equations (5.3) imply that none of the r_A $\mathfrak{u}(1)$ s have charged matter, and are thus non-Higgsable.

The derivation of equation (5.6) is quite simple from the point of view described at the beginning of the section. As explained, the theory compactified on X_t has gauge algebra $\mathfrak{u}(1)^{\oplus 8}$. The cohomology class of the sections of A_t are merely products of the sections of A_t with the class of the fiber in the base. Thus the gauge anomaly coefficient for this theory is given by

$$b_{t>0} = E_8 \otimes F_B, \quad (5.8)$$

where F_B is the class of the base B . There are no codimension-two singularities in X_t , thus no charged matter under the $\mathfrak{u}(1)$ s—all 8 $\mathfrak{u}(1)$ s are thus non-Higgsable. This is consistent with the anomaly equations, since $F_B^2 = -K \cdot F_B = 0$. The simplest way to confirm equation (5.8) is to tune the complex structure of A_t such that there is an E_8 singularity that does not coincide with any of the B singularities. The theory becomes an E_8 theory with a single adjoint hypermultiplet. The $\mathfrak{u}(1)$ s of X_t can be identified with the Cartan subalgebra of the \mathfrak{e}_8 algebra, and the \mathfrak{e}_8 brane is located along the fiber class F_B . By Higgsing the adjoint hypermultiplet of the \mathfrak{e}_8 theory, we arrive at the abelian theory with anomaly coefficients (5.8).

Now starting from X_t , we tune the complex structure of the A -fibration $t \rightarrow 0$ to arrive at \widetilde{X} . Then a subset of the abelian components of A_0 become enhanced to a non-abelian gauge group. These components can be identified with the subspace T_A of $(-E_8)$. Denoting the sections of A_t that span the subset T_A as \widetilde{s}_i , the sections \widetilde{S}_i obtained by pulling back these sections to X_t become vertical when we arrive at \widetilde{X} . Meanwhile, the $\mathfrak{u}(1)$ components of A_t orthogonal to the $\mathfrak{u}(1)$ components that enhance at the \widetilde{X} locus remain decoupled from the unHiggsing process, and are unaffected. Thus these abelian components correspond to the sections obtained by pulling back the sections $T_{A,\perp}$ to \widetilde{X} , *i.e.*, elements of $\widehat{MW}_A(\widetilde{X})$, and their anomaly coefficients are given by

$$\widetilde{b}_A = -T_{A,\perp} \otimes F_B. \quad (5.9)$$

When the MCP blowup $X \rightarrow \widetilde{X}$ does not require blowups of the base, equation (5.9) implies equation (5.7). When the blowup $\widehat{B} \rightarrow B$ is required, the effective theory of the F-theory compactification on \widetilde{X} has a strongly coupled SCFT, and the blowup of the base corresponds

to moving on the tensor branch of the SCFT. Now moving on this tensor branch does not affect the abelian gauge fields corresponding to elements of $\widehat{MW}_A(\tilde{X})$ at all, since none of the operators of the SCFT are charged under them. Thus $\widehat{MW}_A(\tilde{X}) \cong \widehat{MW}_A(X)$, and the anomaly coefficients of these gauge fields are given by equation (5.7) as claimed:

$$b_A = -T_{A,\perp} \otimes F_{\hat{B}},$$

$F_{\hat{B}}$ being the pull-back of the class F_B to \hat{B} , which is orthogonal to the resolution divisors introduced in the blow up. Recall that the volumes of the resolution divisors correspond to the vacuum expectation values of the tensor branch operators.

A crucial point in this picture is the fact that a $\mathfrak{u}(1)$ of X_t , at any point in the complex structure moduli space, cannot have anything charged under itself unless it enhances to a non-abelian gauge symmetry. Thus none of the charged matter appearing at the \tilde{X} locus is charged under the $\mathfrak{u}(1)$ s corresponding to the sections $\widehat{MW}_A(X)$, since none of them have enhanced to a non-abelian gauge symmetry. This also indicates that, although additional rational sections can appear at the \tilde{X} locus, they cannot obstruct the result (5.7).

Let us conclude this section by discussing X obtained from resolving \tilde{X} with isomorphic A and B fibrations that are generic. Let us denote the eight sections obtained by pulling back sections s_m of A to X by S_m , and the additional section, the graph of the isomorphism, by S_0 . As derived previously, the anomaly coefficients only involving the sections S_m are given by

$$b_{mn} = (E_8)_{mn} F_B, \quad (5.10)$$

where we take m to label the roots of E_8 . We can utilize the result [25]

$$b_{MN} = -\pi(S_M \cdot S_N) - K + S_M \cdot Z + S_N \cdot Z \quad (5.11)$$

where the formula becomes simpler in the absence of any non-abelian gauge symmetry. $S_M \cdot Z$ denotes the class of the divisor along which the section S_M intersects the zero section Z .

For the rational surface $K = -F_B$. Now $-\pi(S_0 \cdot S_0) = K = -F_B$, since S_0 itself is a rational surface, and S_0 being the graph of the isomorphism yields $S_0 \cdot Z = Z_B$, where Z_B is the class of the base of the rational surface. We then arrive at

$$b_{00} = 2F_B + 2Z_B. \quad (5.12)$$

Meanwhile,

$$S_m \cdot Z = (s_m \cdot z)F_B = 0 \quad (5.13)$$

for the base z of the rational surface A , since the sections s_m of A do not intersect z . Also, the fact that S_0 is the graph of the isomorphism implies that

$$\pi(S_m \cdot S_0) = [s_m]. \quad (5.14)$$

We then arrive at

$$b_{0m} = F_B + Z_B - [s_m] = -[\sigma_B(s_m)] \quad (5.15)$$

where σ_B here is the Shioda map on the rational surface B [88]. Recall that

$$[\sigma_B(s_m)] \cdot F_B = [\sigma_B(s_m)] \cdot Z_B = 0, \quad [\sigma_B(s_m)] \cdot [\sigma_B(s_n)] = -(E_8)_{mn}. \quad (5.16)$$

To summarize, we find that

$$b_{00} = 2F_B + 2Z_B, \quad b_{0m} = -[\sigma_B(s_m)], \quad b_{mn} = (E_8)_{mn} F_B. \quad (5.17)$$

Let us check the anomaly equations using the anomaly coefficients (5.17). Recall that there are 12 charged hypermultiplets in the spectrum with charge 1 under $\mathfrak{u}(1)_0$ corresponding to the section S_0 . This is because the graph S_0 passes through all 12 codimension-two singularities sitting on top of the nodal points of the I_1 singularities in the base. The anomaly equations only involving indices $m > 0$ are trivially satisfied, so let us only check those involving the index 0. Since all of the 12 hypermultiplets are solely charged under $\mathfrak{u}(1)_0$, we get

$$\begin{aligned} -K \cdot b_{00} = F_B \cdot b_{00} = 2, & & -K \cdot b_{m0} = F_B \cdot b_{m0} = 0, \\ b_{00}^2 = 4, & & 3b_{00} \cdot b_{0n} = 0, \\ b_{00} \cdot b_{mn} + 2b_{0n} \cdot b_{0m} = 0, & & b_{0m} \cdot b_{np} + b_{0n} \cdot b_{mp} + b_{0p} \cdot b_{mn} = 0. \end{aligned} \quad (5.18)$$

These equations can be confirmed by utilizing the relations (5.16) and the intersection numbers

$$F_B \cdot F_B = 0, \quad Z_B \cdot Z_B = -1, \quad F_B \cdot Z_B = 1. \quad (5.19)$$

5.2 Non-enhanceable $\mathfrak{u}(1)$ components

We begin this section by studying an example of an F-theory compactification with an abelian gauge symmetry, that cannot be unHiggsed, or enhanced, to a “sensible” theory with non-abelian gauge symmetry. After examining a particular example in detail and explaining the obstructions to enhancement, we conclude by commenting on the proliferation of manifolds with such sections among the elliptically fibered Calabi–Yau manifolds constructed as an MCP blowup of fiber product spaces of elliptic rational surfaces.

Before moving on further, let us define what we mean by a “non-enhanceable” abelian gauge component. We say that a $\mathfrak{u}(1)$ component of the gauge algebra of an F-theory background $\widehat{X} \rightarrow \widehat{B}$ is *non-enhanceable* when it cannot be enhanced to a non-abelian gauge symmetry by tuning moduli of the theory, parameterized by neutral hypermultiplets, to a point within finite distance from the interior of moduli space. In geometric terms, a $\mathfrak{u}(1)$ is non-enhanceable when the corresponding rational section of the $\mathfrak{u}(1)$ cannot be converted to a vertical divisor by tuning moduli without moving an infinite distance within the complex structure moduli space of the MCP blowup $X \rightarrow \widehat{X}$. While it may be possible that for certain X , the $\mathfrak{u}(1)$ does not enhance at any point in the closure of the moduli space [41], in all the examples we consider, the non-enhanceability comes from the fact that the point of enhancement lies at infinite distance.

Now given an F-theory background with gauge algebra $\mathfrak{g} \oplus \mathfrak{u}(1)$, it might be the case that the $\mathfrak{u}(1)$ component is non-enhanceable by our definition, but becomes enhanceable upon

breaking \mathfrak{g} into a subgroup by giving supersymmetric expectation values to charged hypermultiplets:

$$\mathfrak{g} \oplus \mathfrak{u}(1) \quad \rightarrow \quad \mathfrak{g}' \oplus \mathfrak{h}' \oplus \mathfrak{u}(1) \quad \rightarrow \quad \mathfrak{g}' \oplus \mathfrak{h}, \quad (5.20)$$

where the first arrow denotes the breaking of \mathfrak{g} to $\mathfrak{g}' \oplus \mathfrak{h}'$ and the second arrow denotes the enhancement of $\mathfrak{h}' \oplus \mathfrak{u}(1)$ to \mathfrak{h} . Here, $\mathfrak{g}' \oplus \mathfrak{h}' \subsetneq \mathfrak{g}$, $\mathfrak{h}' \oplus \mathfrak{u}(1) \subsetneq \mathfrak{h}$, where \mathfrak{h} is a non-abelian algebra. This process, however, cannot happen when the initial theory is non-Higgsable. Geometrically, this is when the initial background is a generic fibration over a given base. Note that in this case the $\mathfrak{u}(1)$ component in question is always non-Higgsable.

The model whose abelian gauge symmetry we examine in detail is the generic elliptic fibration (C.8) over \widehat{B}_8 , which is a non-Higgsable model. Let us understand how certain abelian gauge symmetries of the model could be enhanced, but others can not. Recall from section (4.1), the Weierstrass model of the A -fibration of this theory can be expressed as

$$y^2 = x^3 + fx + g \quad (5.21)$$

with

$$\begin{aligned} f &= f_2 w^2 z^2 \\ g &= g_2 w^4 z^2 + g_3 w^3 z^3 + g_4 w^2 z^4 \end{aligned} \quad (5.22)$$

for projective coordinates z and w on the \mathbb{P}^1 base. As before, we denote the fiber product of A and B as \widetilde{X} . The Mordell–Weil group of the elliptic fibration is generated by four rational sections, and hence the gauge algebra of the F-theory model compactified on this manifold has four abelian components in it. We show how this abelian component can be enhanced to a non-abelian gauge component in various ways, and show that in fact two $\mathfrak{u}(1)$ components are non-enhanceable, *i.e.*, cannot be un-Higgsed to a non-abelian gauge component.

The basis of the group of sections can be chosen from the six sections

$$\begin{aligned} s_i &: x = \alpha_i w z, \quad y = \sqrt{g_2} w^2 z + \sqrt{g_4} w z^2 \\ t_i &: x = \beta_i w z, \quad y = \sqrt{g_2} w^2 z - \sqrt{g_4} w z^2, \end{aligned} \quad (5.23)$$

where α_i and β_i denote the three roots of the cubic polynomials

$$\alpha^3 + f_2 \alpha + (g_3 - 2\sqrt{g_2 g_4}) = 0 \quad (5.24)$$

and

$$\beta^3 + f_2 \beta + (g_3 + 2\sqrt{g_2 g_4}) = 0, \quad (5.25)$$

which are distinct for generic values of the coefficients. We note that the six sections obey the relations

$$s_1 + s_2 + s_3 = 0, \quad t_1 + t_2 + t_3 = 0. \quad (5.26)$$

We therefore may choose, for example, s_1, s_2, t_1 and t_2 as the generators of the Mordell–Weil group.

The discriminant locus of this manifold is given by

$$4f^3 + 27g^2 = 27w^4z^4 \left[g_2w^2 + \left(g_3 + \frac{2i}{3\sqrt{3}}f_2^{3/2} \right) wz + g_4z^2 \right] \left[g_2w^2 + \left(g_3 - \frac{2i}{3\sqrt{3}}f_2^{3/2} \right) wz + g_4z^2 \right]. \quad (5.27)$$

Note that there are two *IV* fibers of the *A*-fibration located at the points $z = 0$ and $w = 0$. These coincide with the loci of the I_0^* singularities of the *B*-fibration. Upon inspection of equation (5.27), we see some manifest ways of enhancing the abelian gauge symmetry to a non-abelian gauge symmetry, which we organize in the following way:

- $\mathfrak{su}(2) : 4f_2^3 + 27(g_3 - 2\sqrt{g_2g_4})^2 = 0.$
- $\mathfrak{su}(2) : 4f_2^3 + 27(g_3 + 2\sqrt{g_2g_4})^2 = 0.$
- $\mathfrak{su}(2)^{\oplus 2} : g_3 = 0, f_2^3 = -27g_2g_4.$
- $\mathfrak{su}(3)$ (type *IV*) : $f_2 = 0, g_3^2 = 4g_2g_4.$

Note that the maximal rank enhancement in this list is of rank 2. Further enhancement is not possible—they lead to singularities that lie at infinite distance from the interior of moduli space, as we show shortly.

It is instructive to work out how each of the abelian gauge symmetries enhances to $\mathfrak{su}(2)$. Let us take two roots α_1 and α_2 of (5.24) and examine the limit where the $\mathfrak{u}(1)$ associated to the section $(s_1 - s_2)$ is un-Higgsed. The complex numbers f_2 and g_i parametrizing the Weierstrass coefficients can then be traded for $\alpha_1, \alpha_2, \sqrt{g_2}$ and $\sqrt{g_4}$ in the following way:

$$\begin{aligned} f &= -(\alpha_1^2 + \alpha_1\alpha_2 + \alpha_2^2)w^2z^2 \\ g &= g_2w^4z^2 + (2\sqrt{g_2g_4} - \alpha_1\alpha_2(\alpha_1 + \alpha_2))w^3z^3 + g_4w^2z^4. \end{aligned} \quad (5.28)$$

The rational section $(s_1 - s_2)$, according to standard rules of adding sections [91], is given by

$$[X, Y, Z] = \left[c_3^2 - \frac{2}{3}b^2c_2, -c_3^3 + b^2c_2c_3, b \right] \quad (5.29)$$

in projective coordinates of the *A*-fiber. Here, the coefficients c_i and b are given by

$$c_2 = \frac{3}{2}(\alpha_1 + \alpha_2)wz, \quad c_3 = 2\sqrt{g_2}w + 2\sqrt{g_4}z, \quad b = (\alpha_1 - \alpha_2). \quad (5.30)$$

The Weierstrass model can then be written in the form

$$y^2 = x^3 + (c_1c_3 - b^2c_0 - \frac{c_2^2}{3})x + \left(c_0c_3^2 - \frac{1}{3}c_1c_2c_3 + \frac{2}{27}c_2^3 - \frac{2}{3}b^2c_0c_2 + \frac{1}{4}b^2c_1^2 \right) \quad (5.31)$$

for

$$c_0 = \frac{1}{4}w^2z^2, \quad c_1 = 0. \quad (5.32)$$

This fits nicely into the form of the elliptic fibration with Mordell–Weil rank-one in [25].¹⁶ This form, in particular, is convenient for enhancing the $\mathfrak{u}(1)$ gauge algebra into an $\mathfrak{su}(2)$ —we can simply take $b = (\alpha_1 - \alpha_2)$ to be zero. By tuning b to zero, the Mordell–Weil section becomes trivial, and an I_2 singularity appears at the locus

$$c_3 = 2\sqrt{g_2}w + 2\sqrt{g_4}z = 0. \quad (5.33)$$

This enhancement corresponds to tuning the parameters f_2 and g_i so that

$$4f_2^3 + 27(g_3 - 2\sqrt{g_2g_4})^2 = 0. \quad (5.34)$$

We can further enhance the gauge algebra to $\mathfrak{su}(3)$ by taking $\alpha_2 - \alpha_3$ to zero. In order for this to happen, f_2 must additionally be set to zero. The gauge divisor is, as before, given by the elliptic fiber of the base lying above the locus (5.33).

Similarly, the $\mathfrak{u}(1)$ associated to the section $(t_1 - t_2)$ is enhanced by taking $(\beta_1 - \beta_2)$ to zero. The enhancements corresponds to the tuning

$$4f_2^3 + 27(g_3 + 2\sqrt{g_2g_4})^2 = 0. \quad (5.35)$$

This leads to an I_2 singularity to appear at

$$\sqrt{g_2}w - \sqrt{g_4}z = 0 \quad (5.36)$$

By tuning f_2 to zero, the Mordell–Weil rank reduces further by one, and the singularity of the A -fibration enhances to a IV singularity at this point. On the other hand, we can choose to enhance the $\mathfrak{u}(1)$ associated to section $(s_1 - s_2)$ rather than $(t_2 - t_3)$. In this case, the A -fibration has two I_2 singularities, each at the loci (5.33) and (5.36).

We may attempt to un-Higgs abelian gauge symmetries further. For example, we can make the Mordell–Weil group trivial by setting either

$$f_2 = g_2 = g_3 = 0, \quad (5.37)$$

or

$$f_2 = g_3 = g_4 = 0. \quad (5.38)$$

Note that in the former/latter case, the A -fibration develops a IV^* singularity at the locus $w = 0/z = 0$, respectively. This means that there exists a coincident singular fiber of \tilde{X} given by the product $IV^* \times I_0^*$ at the corresponding point, which does not have an MCP blowup. Another option is to set

$$g_2 = g_4 = 0. \quad (5.39)$$

In this case, the A -fibration develops two I_0^* singularities, each at $w = 0$ and $z = 0$. The coincident singular fibers at these points, which are both given by the product $I_0^* \times I_0^*$, also lie at infinite distance from the interior of the moduli space.

¹⁶It has recently been shown [41] that elliptic fibrations with Mordell–Weil rank-one do not necessarily have to be a Jacobian of a \mathbb{P}^{112} model.

In fact, certain $u(1)$ s cannot be un-Higgsed without giving rise to singularities that lie at infinite distance to begin with. The sections $(s_i - t_j)$, and $(s_i + t_j)$ are of this sort. For definiteness, let us try to un-Higgs the section $(s_1 - t_1)$. To do so, we can write the Weierstrass equation of the A -fibration in the form (5.31) with

$$\begin{aligned} c_0 &= \frac{1}{4}w^2z^2, & c_1 &= \left(\frac{\alpha_1^2 + \alpha_1\beta_1 + \beta_1^2 + f_2}{2\sqrt{g_2}} \right) wz^2, \\ c_2 &= \frac{3}{2}(\alpha_1 + \beta_1)wz, & c_3 &= 2\sqrt{g_2}w, & b &= (\beta_1 - \alpha_1). \end{aligned} \tag{5.40}$$

To enhance this $u(1)$, we must tune b to zero. It is simple to see that for this tuning, there is a coincident singular fiber $I_0^* \times I_0^*$ at $w = 0$, which is not allowed. Similarly, attempting to un-Higgs the section $(s_1 + t_1)$ gives rise to a coincident singular fiber $I_0^* \times I_0^*$ at $z = 0$. We therefore see that two of the four $u(1)$ components of this theory are non-enhanceable.

As can be seen from the example we have studied, a simple way of discerning whether a model has a non-enhanceable abelian component is to attempt to fully enhance the abelian gauge symmetry and look for obstructions. This is in fact the essence of the brief argument presented in §4.1. Given a manifold constructed by performing an MCP blowup on a fiber product space of surfaces A and B , the abelian gauge symmetry can be enhanced by decreasing the Mordell–Weil rank of the A fibration by making the singularities of A worse. There are only a limited number of ways of doing so. In particular, let us assume that there are k coincident singular fibers

$$S_1 \times \Sigma_1, \dots, S_k \times \Sigma_k, \tag{5.41}$$

such that the resolution of each results in at least one rigid curve, *i.e.*, negative intersection curve, in the base over which there is a non-abelian gauge symmetry. This is true, for example, when the MCP blowup of the coincident singular fiber requires blowing up the base. In this case, the singularities S_i are stuck, and cannot be moved by tuning complex structure parameters. Furthermore, they are allowed to only get worse upon enhancement. If enhancing a certain abelian component worsens the singularity S_i to S'_i , and if $S'_i \times \Sigma_i$ is a singularity that does not admit an MCP blowup, that component can be identified as a non-enhanceable $u(1)$. The “vacuum” obtained by enhancing the abelian component does not have an effective description as a six-dimensional supergravity theory coupled to gauge fields, hypermultiplets or SCFTs.

Since there are only 16 A -fibrations in Persson’s list with Mordell–Weil rank zero, it is particularly easy to detect whether there exists at least one abelian component that is non-enhanceable. This can be done by first identifying which of the 16 fibrations the current A -fibration can enhance into, and see if the coincident singular fibers of the enhanced model admit an MCP blowup. For example, for the generic elliptic fibration over \widehat{B}_8 , or model (C.8), there are two coincident singular fibers given by the product $IV \times I_0^*$. Of the 16 fibrations of Mordell–Weil rank zero, the only two A -fibrations the model (C.8) can possibly enhance into are the ones with either the singularities IV^* and IV or two I_0^* singularities, which we have

already observed in the detailed analysis. In both cases, there exists a coincident singular fiber that cannot be resolved without moving an infinite distance within moduli space.

We thus see that there can exist a plethora of models with non-enhanceable components of the abelian gauge algebra. For example, let us consider the class of Calabi–Yau varieties X obtained through an MCP blowup of a fiber product space where the A -fibration has the singular fiber list:

$$A : [I_1^*, IV, I_1]. \quad (5.42)$$

We also assume that the B fibration has a IV fiber coincident with the I_1^* fiber of A , and either an I_n^* or a IV fiber coincident with the IV fiber of A . Thus there are two coincident singular fibers:

$$(I_1^* \times IV, IV \times IV) \quad \text{or} \quad (I_1^* \times IV, IV \times I_n^*). \quad (5.43)$$

We assume that there are not any additional coincident singular fibers. There are 8 entries in Persson’s list that can be used as the base B that satisfies this criterion.

X has MW rank 1, whose corresponding section comes from pulling back the unique free generator of the MW group of the A fibration. The corresponding $\mathfrak{u}(1)$ gauge symmetry is always non-enhanceable. The way to see this is to first acknowledge that the resolution $X \rightarrow \tilde{X}$ requires the blowup of the base for the two coincident singular fibers, thus making the I_1^* and IV singularities of the A -fibration stuck. Now of the 16 fibrations of the rational surface that has MW rank zero, the only one that the given A -fibration can enhance into has the singular fiber list

$$[IV^*, IV]. \quad (5.44)$$

Thus the $I_1^* \times IV$ singularity of X becomes a $IV^* \times IV$ singularity, which does not yield a resolution with a sensible six-dimensional effective description.

We note that while model (C.8) is a non-Higgsable model, the previous example is not. Let us end the section with another non-Higgsable model with a non-enhanceable $\mathfrak{u}(1)$. Let us consider when the A fibration has the singular fibers

$$[I_0^*, IV, I_1, I_1] \quad (5.45)$$

as well as for the B fibration. Let the coincident singular fibers be given by

$$(I_0^* \times IV, IV \times I_0^*). \quad (5.46)$$

The Mordell–Weil rank of the resolution of this fiber product space is given by 2. Resolution of the coincident singular fibers requires blowing up the base, and thus the singularities I_0^* and IV are stuck and can only get worse. The only Mordell–Weil rank-zero fibrations that the A fibration can enhance to have the singular fiber list

$$[I_0^*, I_0^*] \quad \text{or} \quad [IV^*, IV]. \quad (5.47)$$

Thus there is either a $I_0^* \times I_0^*$ fiber or $IV^* \times IV$ fiber, either of which lies at infinite distance from the interior of moduli space. Thus this model must have a non-enhanceable $\mathfrak{u}(1)$.

6 A - B duality

In this section, we examine the duality of manifolds under the exchange of A and B fibers of the Calabi–Yau threefolds obtained by the A - B construction studied so far. Given a manifold that admits multiple elliptic fibrations, the physics of an F-theory model associated to this manifold depends on the choice of the fiber. For a fiber product space

$$\tilde{X} = A \times_{\mathbb{P}^1} B, \tag{6.1}$$

we choose the elliptic fiber of the A direction to be the F-theory fiber. We could have performed an MCP blowup of the coincident singular fibers of \tilde{X} in multiple ways. We have, however, chosen to perform the blowup these singularities in a way consistent with the elliptic fibration structure, so that the MCP blowup is still a flat elliptic fibration with the fiber aligned along the A direction. Let us denote the manifold obtained by such a resolution by X . The base \widehat{B} of X is given by blowing up the base B as explained in detail in §3. Meanwhile, we can consider a dual variety \tilde{X}^D such that its elliptic fibration structure is given by

$$\tilde{X}^D = A^D \times_{\mathbb{P}^1} B^D \equiv B \times_{\mathbb{P}^1} A, \tag{6.2}$$

whose MCP blowup is given by X^D such that the fiber is aligned in the $A^D = B$ direction. The base \widehat{B}^D of this manifold is given by a blow up of $B^D = A$.

While \tilde{X} and \tilde{X}^D are the same singular variety, their MCP blowups X and X^D are in general different since each one is compatible with a different elliptic fibration. Upon compactifying F-theory on $X \rightarrow \widehat{B}$ and $X^D \rightarrow \widehat{B}^D$, we arrive at different six-dimensional theories. The tensor, gauge and matter content in general will be different. Upon compactifying the theory further on a circle, however, the five-dimensional effective theories become dual to each other. This is because the two distinct varieties come from performing two distinct MCP blowups on a single singular variety. Put differently, X and X^D sit at different regions of the movable cone [66, 92] (*i.e.*, the extended Kähler moduli space) of a single variety. As we will see shortly, they are in fact related by flops.¹⁷

Let us understand how various elements of the second cohomology of X and X^D map into each other under these flops, which we denote “ A - B duality.”¹⁸ A useful way of classifying the second cohomology, or equivalently, the four-cycles of the manifold, is to divide them into five groups: resolution divisors of A singularities, B singularities, and coincident singular fibers and divisors of type MW_A and MW_B . The names of the first two types of divisors are self-explanatory. The resolution divisors of the coincident singular fibers can be localized at the locus of the singular fiber, or be a global section that (partially) resolves multiple codimension-two singularities. The $MW_A(MW_B)$ -type divisors are four-cycles that come from pulling back a section (including the zero section) of the $A(B)$ -fibration with respect to the projections to

¹⁷This also follows from general results in Mori theory [66, 67].

¹⁸For technical reasons, we restrict our discussion from this point on to \tilde{X} that have honest resolutions to a smooth CY manifold. We expect these results to generalize to MCP blowups.

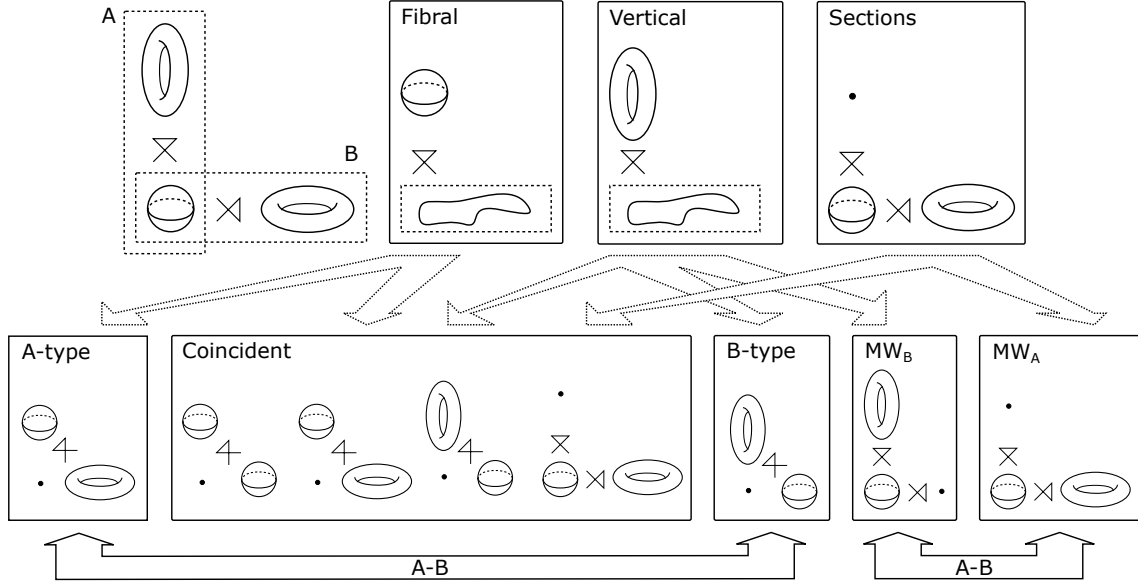

Figure 3. A classification of divisors in the resolution of an elliptic fibration over a rational surface, and their exchange properties under A - B duality. The divisors are fibrations, whose bases and generic fibers we have depicted. The fibral divisors are either resolution divisors of A -type or coincident singular fibers, while the vertical divisors can be of MW_B -type or resolution divisors of either coincident singular fibers or B -type singularities. The sections either are MW_A -type divisors, or a global divisor, the blow up along which resolves multiple codimension-two singularities at the coincident loci. The solid arrows with the label “ A - B ” denote the exchange under A - B duality.

each rational surface. It is straightforward to understand how the different classes of divisors are mapped into each other under A - B duality. The resolution divisors of A -singularities are exchanged with the resolution divisors of B -singularities, while the resolution divisors of the coincident singular fibers are exchanged among themselves. Meanwhile, the divisors of types MW_A and MW_B are also exchanged.

Another useful way of classifying the divisors is to divide them into three groups, according to the Shioda-Tate-Wazir theorem [93, 94]: fibral divisors, vertical divisors, and sections. The fibral divisors are divisors that have the structure of a rational curve fibered along a divisor in the base. Vertical divisors are those obtained by fibering the elliptic fiber over divisors in the base. The sections are four-cycles that are parallel to the base manifold, and consist of the zero section and the generators of the Mordell–Weil group. A schematic depiction of each type of divisor is given in Figure 3. Then, from the point of view of X we find the following:

1. The fibral divisors consist of resolution divisors of coincident singular fibers and A -singularities.
2. The vertical divisors consist of resolution divisors of coincident singular fibers and B -singularities, and divisors of type MW_B .

3. The sections of the either divisors of type MW_A , or come from global resolution divisors that resolve multiple codimension-two singularities localized at coincident singular fibers.

The exchange of the various divisors under A - B duality is depicted in Figure 3.

As mentioned earlier, we can engineer little string theories [45] by taking a certain scaling limit of the F-theory compactification on these manifolds. The A - B duality then becomes a T -duality of the little string theory.

In what follows, we examine some examples to see how A - B duality can be understood in terms of flops. The first example is the case when A and B have a single coincident singular fiber given by the product $I_0^* \times I_n$, that is, we assume all other singularities are either of type $I_1 \times \cdot$ or $\cdot \times I_1$. Next, we examine the case that A and B have a single coincident singular fiber $I_0^* \times IV$. We end the section by relating the A - B dualities with T -dualities of little string theories.

6.1 Example: Model with coincident singular fiber $I_0^* \times I_n$

Let us consider a Calabi–Yau manifold \tilde{X} with one coincident singular fiber $I_0^* \times I_n$ over the point p of the base \mathbb{P}^1 . Let us denote the elliptically fibered manifold obtained by resolving \tilde{X} so that its fiber is aligned in the A -direction as X . The B -fibration, which is to be considered as the base of X , has a reducible fiber that decomposes into n (-2) -curves at locus p . On each of the n components, there lies a I_0^* singularity. This implies that the intersection of the (-2) curves must be further resolved. The singularities can be fully resolved by n blowups by (-1) -curves at each intersection. The base is then given by \hat{B} , which is a rational surface blown up at n points. There are no singular fibers sitting above a generic point of these (-1) -curves. On the other hand, the n now- (-4) curves carry $\mathfrak{so}(8)$ gauge-symmetries. Upon resolving each of these I_0^* singularities, we obtain $4n$ fibral divisors. Meanwhile, there are $(10 + n)$ fibral divisors, $(10 - n)$ of which are of type MW_A . $2n$ of the divisors come from resolving the coincident singular fiber. Finally, there are $(9 - 4) = 5$ sections of the theory. Hence the number of divisors are given by

$$\begin{aligned} \text{Fibral} &: 4n, & \text{Vertical} &: 10 + n, & \text{Sections} &: 5. \\ \text{Coincident} &: 4n + 2n = 6n, & MW_B &: 10 - n, & MW_A &: 5. \end{aligned} \tag{6.3}$$

The gauge algebra of the F-theory compactification on X is given by

$$\mathfrak{g}_X = \mathfrak{so}(8)^{\oplus n} \oplus \mathfrak{u}(1)^{\oplus 4}. \tag{6.4}$$

There are $T_X = (9 + n)$ tensor multiplets in the theory, as the rational surface B has been blown up n times to reach \hat{B} . This number is always given by one less than the vertical divisor count.

Now let us consider the dual resolution X^D of this manifold, where $B^D = A$ is taken to be the base. The I_0^* singularity of the $A^D = B$ -fibration implies that there is a reducible fiber, which, upon resolution can be shown to consist of five (-2) -curves. On four of the

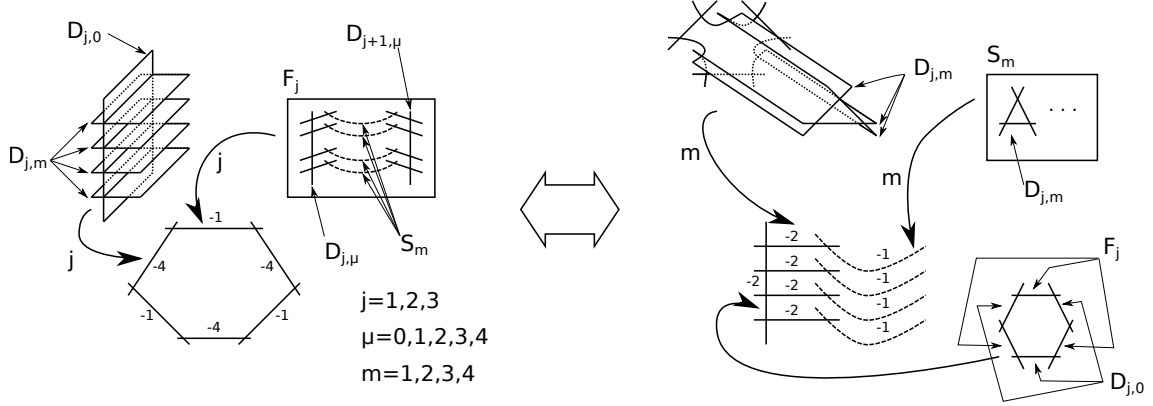

Figure 4. The behavior of divisors of X (left) and X^D (right) under flops for distinct resolutions of a coincident singular fiber given by $I_0^* \times I_3$.

curves, there is an I_n singularity, while on one, there is an I_{2n} singularity. The resolution of these singularities yields $4(n-1) + (2n-1)$ fibral divisors that come from resolving the coincident singular fiber. Meanwhile, there are 10 vertical divisors. Five of these vertical divisors, which lie above the aforementioned (-2) -curves, arise in the process of resolving the coincident singular fiber. The remaining five are of type MW_B^D . Meanwhile, there are $(10-n)$ MW_A^D -divisors. To summarize, the divisor count is given as the following:

$$\begin{aligned} \text{Fibral} &: 6n - 5, & \text{Vertical} &: 10, & \text{Sections} &: (10 - n). \\ \text{Coincident} &: 4(n - 1) + (2n - 1) + 5 = 6n, & MW_B^D &: 5, & MW_A^D &: (10 - n). \end{aligned} \quad (6.5)$$

Note that the divisor count is exchanged as described previously. The gauge algebra of the X^D compactification is given by

$$\mathfrak{g}_{X^D} = \mathfrak{su}(2n) \oplus \mathfrak{su}(n)^{\oplus 4} \oplus \mathfrak{u}(1)^{\oplus (10-n)}, \quad (6.6)$$

while the number of tensor multiplets T_{X^D} is 9.

Let us now examine how the various divisors in the two manifolds are related to each other by flops. We denote the divisors that are involved in the flops by $D_{j,\mu}$, F_j and S_m where j runs from 1 to n and μ runs from 0 to 4. We label the non-zero indices of μ by m . The geometry of the divisors are depicted in Figure 4 in the case that $n = 3$.

In X , the divisors $D_{i,\mu}$ are obtained by fibering rational curves that compose the I_0^* fiber, labeled by μ , over the (-4) curves, labeled by j , in the base. The central component of the I_0^* fiber is given the index $\mu = 0$ while the other rational curves are labeled by m . F_j are rational surfaces obtained by fibering the elliptic fiber over the (-1) curves in the base. This rational surface has two I_0^* fibers at the loci where the (-4) curve meets the (-1) curves. The components of these I_0^* fibers within F_j can be understood as the intersection curves between F_j and the divisors $D_{j,\mu}$ and $D_{j+1,\mu}$. S_m are rational sections of X that intersect F_j along its sections, which are represented as a dotted lines in Figure 4. This section intersects the curves $D_{j,m} \cap F_j$ and $D_{j+1,m} \cap F_j$ within F_j .

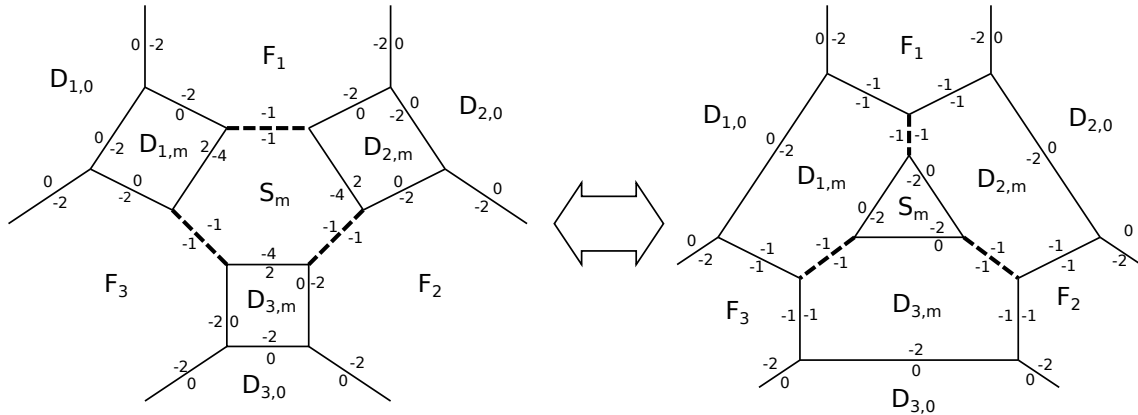

Figure 5. Flops relating X (left) and X^D (right).

The manifold X^D can be obtained from X by flopping along $4n$ curves. The flops are illustrated in Figure 5 for $n = 3$. Before describing the flops in detail, let us explain the information this Figure contains. The faces of the diagrams correspond to the divisors, while the edges along which two faces meet denote the curves along which the two corresponding divisors intersect. The numbers on each side of an edge denote the self-intersection of the curve within the corresponding divisor. For example, the curve at the intersection of $D_{j,m}$ and S_m in X have self-intersection number 2 within $D_{j,m}$, and is a (-4) -curve from the point of view of S_m . The two numbers labeling a curve adds up to (-2) via the adjunction formula, since the divisors and curves live inside a Calabi–Yau total space. Two edges meet when the corresponding curves have intersection number-one in the divisor both of the curves lie within. The self-intersection number of curves change after a flop, as curves within the divisors are blown up or down during a flop transition. The intersection numbers are modified accordingly with the blowups and blow-downs—if a point on the curve is being blown up, the self intersection number decreases by one, while when an adjacent curve gets blown down, it increases by one.

X^D is obtained from X by flopping the curves that are represented by dotted lines in Figure 5. Such flops are carried out for each $m = 1, \dots, 4$, resulting in $4n$ curves being flopped. This corresponds to blowing down four curves in each F_j , n curves in each S_m and blowing up two curves in each of the $D_{j,m}$. X^D is then an elliptic fibration over $\widehat{B^D} = A$, which is a rational surface with a resolved I_0^* fiber.

In X^D , the divisors $D_{j,m}$ are obtained by fibering the components of the I_n fiber over the non-central components of the I_0^* fiber in the base A . The divisors $D_{j,0}$, together with F_j consist the $2n$ divisors obtained by fibering the rational curves of the I_{2n} fiber over the central component of the I_0^* fiber in the base. The S_m now are vertical divisors. They are rational curves with a resolved I_n fiber. The the components of the I_n fiber within S_m lie at the intersection between S_m and $D_{j,m}$. This structure is summarized in the right-hand side of Figure 4.

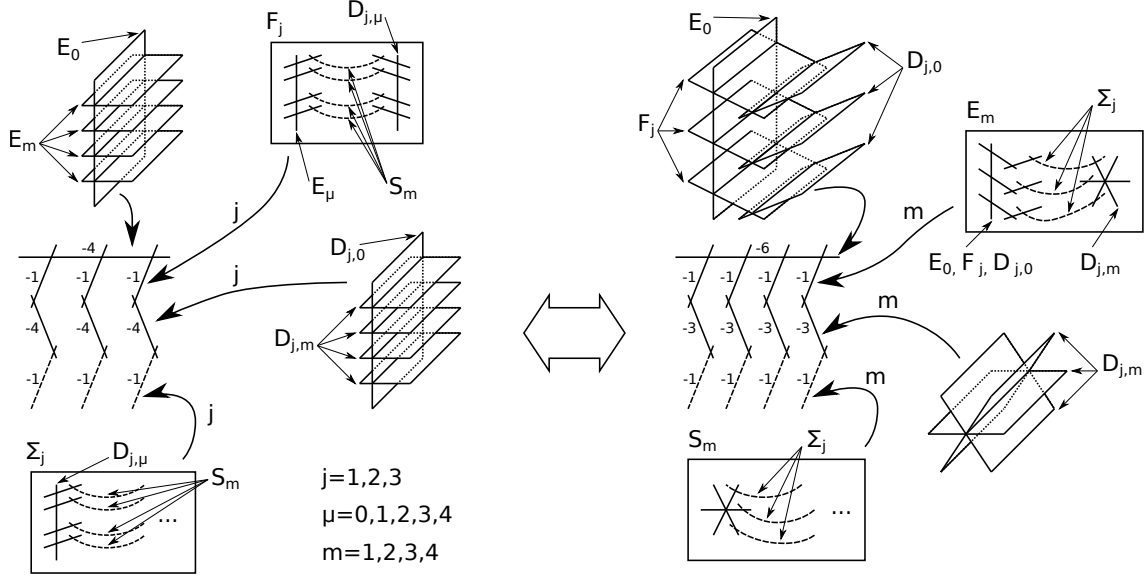

Figure 6. The behavior of divisors of X (left) and X^D (right) under flops for distinct resolutions of a coincident singular fiber $I_0^* \times IV$.

Let us examine the topology change of the divisors. S_m in X was a copy of the base \widehat{B} of X , which is a rational surface blown up at n points. During the flop, S_m undergoes n blow-downs and becomes a rational surface with an I_n fiber. Meanwhile, the $D_{j,m}$, which were minimal ruled surfaces in X , are blown up at two points. These two blowups, which sits above the intersection locus of the m -th non-central component of the I_0^* fiber with the central component, is responsible for the bifundamental matter between the I_{2n} and I_n gauge groups. The $3n$ curves responsible for generating the bifundamental matter can be observed at the boundary of the outer-ring of $2n$ divisors consisting of $D_{j,0}$, F_j ($j = 1, \dots, n$) and the inner-ring of n divisors $D_{j,m}$ in Figure 5.

6.2 Example: Model with coincident singular fiber $I_0^* \times IV$

Let us now consider a Calabi–Yau manifold \widetilde{X} with a single coincident singular fiber $I_0^* \times IV$ over a point p in the base \mathbb{P}^1 . As before, we denote the manifold obtained by resolving \widetilde{X} so that the elliptic fiber is aligned in the A -direction to be X . The base \widehat{B} is obtained by blowing B up at four points, where B is a rational surface with a resolved IV fiber. This leads to a configuration of a central (-4) curve and three branches that consist of a (-1) and (-4) curve, labeled by j . For each (-4) curve, there is a I_0^* fiber fibered over it. The configuration of these curves in the base are depicted on the left-hand side of Figure 6.

We denote the divisors involved in the flops by E_μ , $D_{j,\mu}$, S_m and Σ_j . These divisors are also depicted on the left-hand side of Figure 6. The index j runs from 1 to 3, while μ runs from 0 to 4. As before, the non-zero indices of μ are denoted by m . E_μ are minimal ruled surfaces obtained by fibering the components of the I_0^* fibers along the central (-4) curve

in the base, while $D_{j,\mu}$ come from fibering the components of the I_0^* fibers along the other (-4) curves. The surfaces obtained by fibering the central component of the I_0^* fiber carry the index $\mu = 0$. Meanwhile, F_j are rational surfaces sitting above the (-1) curves connecting the central (-4) curves to the (-4) curves in the branch. They contain two I_0^* fibers whose components lie at the intersection of F_j and E_μ or $D_{j,\mu}$. For each j , there also exists a vertical divisor Σ_j that lies above a (-1) divisor in the base that intersects the (-4) curves at a point. Σ_j are also rational surfaces with a I_0^* fiber whose components are intersections of Σ_j with $D_{j,\mu}$. The sections S_m of X intersect F_j and Σ_j along its sections, represented as a dotted lines in Figure 6. This section intersects the curves $E_m \cap F_j$ and $D_{j,m} \cap F_j$ within F_j and $D_{j,m} \cap \Sigma_j$ within Σ_j . The divisor count of this manifold is given by the following:

$$\begin{aligned} \text{Fibral} &: 16, & \text{Vertical} &: 14, & \text{Sections} &: 5. \\ \text{Coincident} &: 16 + 7 = 23, & MW_B &: 7, & MW_A &: 5. \end{aligned} \tag{6.7}$$

The gauge algebra of F-theory compactified on X is given by

$$\mathfrak{g}_X = \mathfrak{so}(8)^{\oplus 4} \oplus \mathfrak{u}(1)^{\oplus 4}, \tag{6.8}$$

while $T_X = 13$.

In the dual resolution X^D of this manifold, the base $B^D = A$ has a single singular I_0^* fiber, which can be resolved into a Kodaira fiber consisting of five (-2) -curves. There is an IV^* singularity along the central component of the Kodaira fiber, while there are IV singularities along the rest of the four components, labeled by m . The base manifold must be blown up at the four points the four (-2) components intersect the central component to resolve the codimension-two singularities. The configurations of these curves within the base can be seen on the right-hand side of Figure 6.

Let us now describe the 40 flop transitions that take X to X^D . These are depicted in Figure 7. In (a), the 12 curves at the intersection of F_j and S_m are flopped. These curves are the dotted curves on F_j on the left-hand side of Figure 6. Note that the intersection numbers of the curve $E_m \cap S_m$ jumps by three, as this curve intersects three of the blown down curves, namely $F_j \cap S_m$ for $j = 1, 2, 3$. Then the 12 curves at the intersection of F_j and $D_{j,m}$ are flopped in (b). The self-intersection number of the curve $F_j \cap D_{j,0}$ jumps by four, as it intersects four of these curves— $F_j \cap D_{j,m}$ for $m = 1, \dots, 4$. In (c), the 12 curves that lie at the intersection of $D_{j,0}$ and $D_{j,m}$ are flopped. The self-intersection number of $\Sigma_j \cap D_{j,0}$ now jump by four, as it intersects four of the curves being flopped. Finally, in (d), the 4 curves at the intersection of S_m and E_m are flopped. An interesting point to see is that by blowing down $S_m \cap E_m$ the three divisors $D_{j,m}$ for given m meet at a point, forming a singular type- IV Kodaira fiber, as depicted in the right-hand side of Figure 6.

After the flops, F_j , E_0 and $D_{j,0}$ become minimal ruled surfaces that constitute a type- IV^* Kodaira fiber fibered over the (-6) curve in the base manifold of X^D . The minimal curves $D_{1,m}$, $D_{2,m}$ and $D_{3,m}$ are obtained by fibering the components of the type- IV Kodaira fibers over the four (-4) curves labeled by m . The sections S_m of X , each of which undergoes three

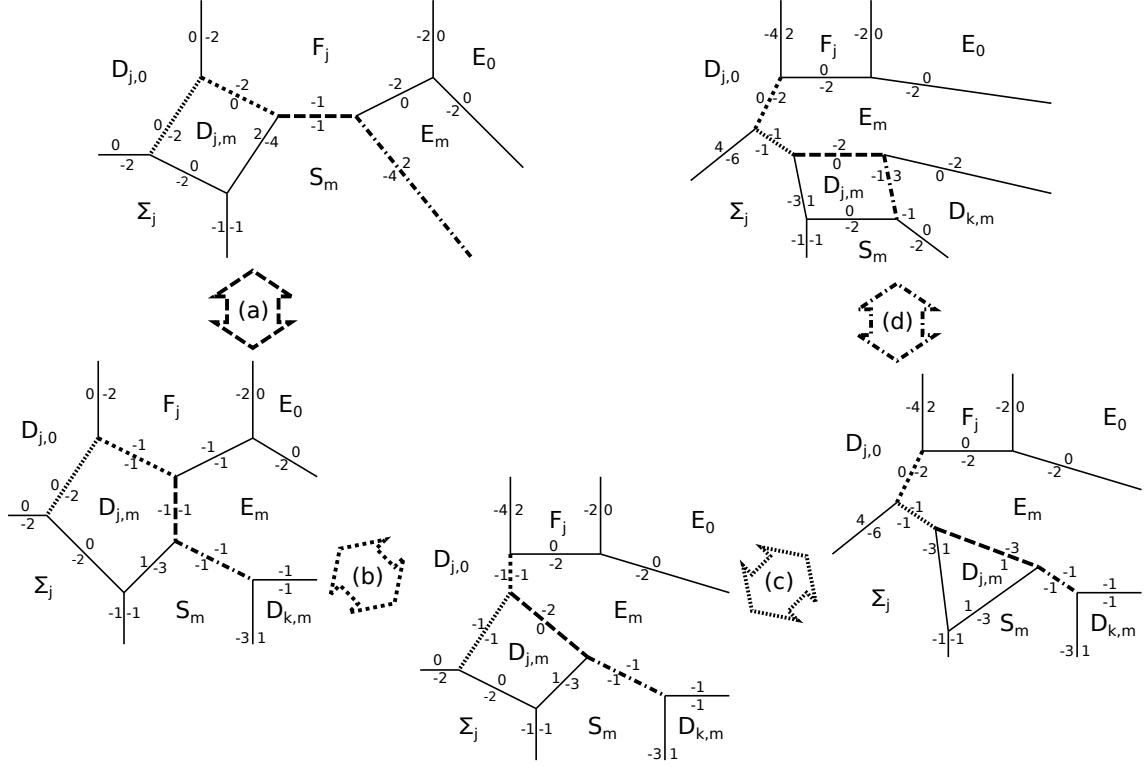

Figure 7. Flops relating X (upper-left) and X^D (upper-right). The dash-style of the arrows indicate which curve is being flopped.

blow-downs during the flops, become vertical divisors of X^D , which are rational surfaces. These surfaces have a single type- IV fiber whose components lie at the intersection of S_m and $D_{j,m}$. Σ_j , which were vertical divisors of X , now become sections of X^D , which are given by copies of the base $\widehat{B^D}$, which is a rational surface blown up at four points. Note that each Σ_j is blown up four times during the flop transitions. E_m , which were rational surfaces in X , are blown up eight times and become rational surfaces in X^D . These rational surfaces are elliptic fibrations over the (-1) curves in the base that connect the central (-6) curve to the (-3) curves. Each E_m has two singular fibers, each of type IV^* and IV . The components of the IV^* fiber are given by the intersection curves of E_m with E_0 , E_j and $D_{j,0}$, while the components of the IV fiber can be identified with the curves at the intersection loci of E_m with the divisors $D_{j,m}$. The number of each type of divisor is given by the following:

$$\begin{aligned}
 \text{Fibral} &: 14, & \text{Vertical} &: 14, & \text{Sections} &: 7. \\
 \text{Coincident} &: 14 + 9 = 23, & MW_B^D &: 5, & MW_A^D &: 7.
 \end{aligned}
 \tag{6.9}$$

The divisor count is exchanged with respect to that of X as expected. Compactifying F-theory on X^D , we get a theory with $T_{X^D} = 13$ and gauge algebra

$$\mathfrak{g}_{X^D} = \mathfrak{e}_6 \oplus \mathfrak{su}(3)^{\oplus 4} \oplus \mathfrak{u}(1)^{\oplus 6}.
 \tag{6.10}$$

6.3 Little string theories

We review from [45] the construction of little string theories from F-theory. The starting point is an F-theory model with base \widehat{B} that has a map $\varphi : \widehat{B} \rightarrow \mathbb{D}$ to a small disk. The metric on \widehat{B} is scaled so that the induced area of \mathbb{D} goes to infinity, while the area of a fiber $\varphi^{-1}(t)$ remains finite. That finite area is proportional to the scale of the little string theory. D3-branes wrapping the components of the central fiber $\varphi^{-1}(0)$ provide the tensionless strings in the theory. Little string theories are expected to have T-duality upon compactification on a circle [95–97].

The general fiber of φ can either have genus zero or genus one. The key construction produces F-theory models over such a base \widehat{B} with a map φ for which the general fiber has genus one. If the fibration φ has a section¹⁹ (as is the case in this paper), then the dualizing sheaf $\mathcal{O}_{\widehat{B}}(K_{\widehat{B}})$ of \widehat{B} is the pullback of a line bundle on the disk \mathbb{D} . This implies that the Weierstrass coefficients $f_{\widehat{B}}$ and $g_{\widehat{B}}$ are determined by corresponding Weierstrass coefficients $f_{\mathbb{D}}$ and $g_{\mathbb{D}}$ on the disk. Those Weierstrass coefficients determine an elliptic fibration $A \rightarrow \mathbb{D}$, and the F-theory model for the little string theory is a fiber product.

Our A - B duality now immediately yields the expected T-duality of these models, which applies to the circle-compactified theories. The T-dual of the little string theory built as above, is the little string theory constructed from the elliptic fibration over A (possibly after blowing up A , as we have discussed).

7 Conclusions

In this paper we have constructed a general class of elliptic Calabi–Yau threefolds using fiber products of rational elliptic surfaces. These threefolds have the feature that the elliptic fibration has multiple independent sections at all points in the complex structure moduli space, corresponding in F-theory to non-Higgsable abelian gauge components in the associated low-energy 6D supergravity theory. From the mathematical point of view these manifolds are interesting as a generalization of the constructions of Schoen [8] and Kapustka and Kapustka [11]. From the physics point of view, these are interesting as they give low-energy theories with non-Higgsable abelian components.

One significant feature of the models we have studied here is that they contain a range of singularity types, some of which include terminal singularities with no crepant projective resolution. These singularities, which occur at codimension two in the base, are not known to cause problems with the associated physics theory, so that elliptic Calabi–Yau threefolds with these types of singularities fit naturally in the class of physically sensible geometries that can be used in F-theory. Other codimension two singularities without a Calabi–Yau resolution have been encountered in 6D F-theory models, such as in the context of discrete gauge symmetries [101, 33, 102–106]. A related observation has been made for 4D F-theory models, which is that many elliptic Calabi–Yau fourfolds have singularities that either can

¹⁹Note that there are some cases, explored in [45], in which φ has a multi-section rather than a section.

be tuned or are present everywhere in complex structure moduli space, which do not admit crepant projective resolutions, but which seem innocuous from a physics point of view; this can happen either in codimension two on the base [69, 6] or in codimension three [54, 55]. A further understanding of how singularities without a Calabi–Yau resolution fit into the landscape of F-theory compactifications and associated geometry should shed light on both the physics and mathematics of these configurations.²⁰

In terms of physics applications, one potentially interesting direction in which to extend this work is to 4D theories, where combining a non-Higgsable $\mathfrak{u}(1)$ factor with a non-Higgsable $\mathfrak{su}(3) \oplus \mathfrak{su}(2)$ [2, 6] would give a family of vacua where the standard model gauge group would arise at a generic point in the moduli space, without requiring tuning.

The constructions developed here provide a large class of examples of theories in which there are one or more $\mathfrak{u}(1)$ components that exist generically in the moduli space over a given base, and where tuning moduli to enhance to a nonabelian gauge symmetry following [25, 33] gives rise to additional singularities without a Calabi–Yau resolution. In some cases these singularities can be removed by blowing up points on the base but in other cases they cannot, and lie at infinite distance in moduli space. One way in which it has been suggested such an unHiggsing structure may be relevant is in classifying models with abelian components by first classifying nonabelian models and then Higgsing (*e.g.* [38]), although it has also been suggested that there can exist certain models with abelian gauge symmetry that are unattainable this way [41]. The examples given here show explicitly that for the approach of obtaining abelian models by Higgsing to be complete, it would be necessary to include in the classification of nonabelian models certain kinds of singularities without Calabi–Yau resolutions, corresponding to unphysical 6D models at infinite distance from the interior of moduli space. While in principle this may be possible it would significantly complicate this approach to the classification of F-theory models with abelian symmetries.

Another particularly interesting feature of these constructions is the presence of two distinct elliptic fibrations for each of the resulting Calabi–Yau threefolds. This leads to an interesting T-duality type structure for the associated little string theories, which would be interesting to explore further.

Acknowledgements: We would like to thank Lara Anderson, Antonella Grassi, Gabriella Martini, Tony Pantev and Yinan Wang for helpful discussions. This research was supported by the DOE (USA) under contracts #DE-SC00012567, #DOE-SC0010008 and #DE-FG02-92ER-40697, by the National Science Foundation (USA) under Grant Nos. PHY-1066293 and PHY-1307513, and by the Centre National de la Recherche Scientifique (France). All of us would like to thank the Aspen Center for Physics for hospitality during part of this work, and DRM would like to thank the Simons Center for Geometry and Physics and the Institut Henri Poincaré for hospitality during other parts of the work.

²⁰As this work was being completed we learned of recent work making progress in this direction [82].

A Terminal singularities and small resolutions

As we saw in §3.6, the global questions about the existence of crepant projective blowups can either be phrased in terms of algebraic geometry (does a certain divisor exist?) or in terms of topology (is there a homology relation among vanishing cycles?). One advantage of the algebraic geometry approach is that for certain terminal singularities the question can be resolved locally without needing global data.

In fact, some terminal singularities are known to have no crepant blowup (projective or not) based solely on their local equation. A class of these was analyzed by Reid [61]: singularities of the form

$$x^2 + y^2 + u^2 + v^k = 0 \tag{A.1}$$

admit no crepant blowup when k is odd, and may or may not admit a crepant projective blowup (depending on global conditions about divisors) when k is even. Other terminal singularities that admit no projective crepant blowup include

$$x^2 + y^2 + u^3 + v^4 = 0, \quad x^2 + y^3 + u^3 + v^3 = 0, \quad \text{and} \quad x^2 + y^3 + u^3 + v^4 = 0, \tag{A.2}$$

while some that may or may not admit a crepant projective blowup depending on global conditions are

$$x^2 + y^2 + u^3 + v^3 = 0, \quad \text{and} \quad x^2 + y^2 + u^4 + v^4 = 0. \tag{A.3}$$

The global conditions enter as follows: higher order terms in the local equations can obstruct a factorization which is visible at lower order. For example, a node on a plane curve whose leading order terms are $x^2 + y^2$ may have a complete equation of the form $x^2 + y^2 + x^3 + y^3$, which is irreducible. The latter describes a node whose two local branches are connected globally, as one would see in a Kodaira fiber of type I_1 . In fact, this phenomenon is the cause of the appearance of global conditions in the I_1 case but not in the I_n cases for $n > 1$: in the latter cases, the nodes appearing in the singular fiber each represent the intersection of two distinct curves (so factorization is possible) while in the former case, the node is part of an irreducible curve and factorization is impossible.

The reason for an unknown “global condition” even in these cases, is that there may be some other divisor passing through the singular point, the blowup of which would resolve the singularity. All we can say for certain is that the obvious divisors related to factorization of the given local equation do not exist globally.

The singularity $x^3 + y^3 + u^3 + v^3$ is somewhat different: it is associated to a blowup of the base because there is a crepant projective blowup of the singularity that introduces a divisor.

We now review the singularities occurring in the fiber product constructions described in the upper left box of Table 2; these singularities were originally described in [8] and [11] (using slightly different notation). Each of the two elliptic surfaces is nonsingular, and we must consider the possible singular points on each fiber in question. The surface in question will have a description of the form $\varphi(x, y) = t$, and the second surface will have a description

B \ A	I_1	$I_{n>1}$	II	III	IV
I_1	$x^2+y^2-u^2-v^2$	$x^2+y^2-u^2-v^2$	$x^2+y^2-u^2-v^3$	$x^2+y^2-u^2-v^4$	$x^2+y^2-u^3-v^3$
$I_{m>1}$	$x^2+y^2-u^2-v^2$	$x^2+y^2-u^2-v^2$	$x^2+y^2-u^2-v^3$	$x^2+y^2-u^2-v^4$	$x^2+y^2-u^3-v^3$
II	$x^2+y^3-u^2-v^2$	$x^2+y^3-u^2-v^2$	$x^2+y^3-u^2-v^3$	$x^2+y^3-u^2-v^4$	$x^2+y^3-u^3-v^3$
III	$x^2+y^4-u^2-v^2$	$x^2+y^4-u^2-v^2$	$x^2+y^4-u^2-v^3$	$x^2+y^4-u^2-v^4$	$x^2+y^4-u^3-v^3$
IV	$x^3+y^3-u^2-v^2$	$x^3+y^3-u^2-v^2$	$x^3+y^3-u^2-v^3$	$x^3+y^3-u^2-v^4$	$x^3+y^3-u^3-v^3$

Table 3. Local equations of singularities in fiber products of nonsingular surfaces.

of the form $\psi(u, v) = t$, with the two parameters t being identified. The singularity on the fiber product then takes the form

$$\varphi(x, y) - \psi(u, v) = 0. \quad (\text{A.4})$$

The corresponding local equation $\varphi(x, y)$ takes the form $x^2 + y^2$ for a node (normal crossing points in I_m); it takes the form $x^2 + y^3$ for a cusp (as in type II); it takes for form $x^2 + y^4$ for a tacnode (as in type III); and it takes the form $x^3 + y^3$ for an ordinary triple point (as in type IV).

We reproduce the upper left of Table 2 in Table 3, this time displaying the local equation. The singularities that occur are all of the types analyzed in this appendix, yielding most of the results displayed in Table 2. (Note that since all variables are complex, the signs are not relevant.) There are some cases in Table 2 where an appropriate global divisor is known to exist, showing that a crepant projective resolution exists. The divisors in question are provided by divisors that are fiber components for one of the elliptic fibrations. Such divisors exist globally, and can be used to perform the crepant resolutions (unless the fiber is irreducible *i.e.*, cases I_1 and II).

B Two explicit MCP blowups

A fiber product in which one fiber has type II and the other fiber has type I_n^* presents computational challenges for finding an MCP blowup no matter which of the two elliptic fibrations is being studied. In this appendix, we give some of the details in each of these cases.

We begin with a base containing a type I_m^* fiber (*i.e.*, a configuration of rational curves whose dual graph is an affine \widehat{D}_{m+4} diagram) whose elliptic fibration has a fiber of type II along the multiplicity one components of the \widehat{D}_{m+4} graph. Let ψ be a function on the base which vanishes along the \widehat{D}_{m+4} graph with the appropriate multiplicities:

$$\psi = \prod \psi_j^{m_j} \quad (\text{B.1})$$

where $\{\psi_j = 0\}$ is the curve corresponding to the j^{th} node in the graph and m_j is its Dynkin index. In the Weierstrass equation, ψ divides f and ψ divides g . Thus, when $m_j = 1$ we

have a Kodaira fiber of type II , but when $m_j = 2$ we have a Kodaira fiber of type IV . Our challenge is to find a maximal crepant projective blowup of this Weierstrass model.

As pointed out in [72], the “collision” of two fibers of type II , or of two fibers of type IV , has a leftover terminal singularity after the codimension two (in the total space) singularities have been resolved. We will carry this out explicitly in our example.

The Weierstrass equation takes the form

$$y^2 = x^3 + c_1\psi x + c_2\psi \tag{B.2}$$

for some constants c_1, c_2 with $c_2 \neq 0$. Near a point of intersection of two of the curves over which the fibration has type IV , we may write $\psi = s^2 t^2 \widehat{\psi}(s, t)$, where $\{s = 0\}$ and $\{t = 0\}$ are the two curves. (That is, $s = \psi_j, t = \psi_{j+1}$ for some j .) Note that the function $\widehat{\psi}(s, t)$ cannot be a square, since ψ is not a square.

We blowup the locus $x = y = s = 0$ and consider the chart with coordinates $\tilde{x} = x/s, \tilde{y} = y/s, s$, and t . The proper transform of the equation is

$$\tilde{y}^2 = s\tilde{x}^3 + c_1 s t^2 \widehat{\psi} \tilde{x} + c_2 t^2 \widehat{\psi}. \tag{B.3}$$

We then blowup the locus $\tilde{x} = \tilde{y} = t = 0$ and consider the chart with coordinates $\bar{y} = \tilde{y}/\tilde{x}, \bar{t} = t/\tilde{x}, \tilde{x}$, and s . This time, the proper transform of the equation is

$$\bar{y}^2 = s\tilde{x}(1 + c_1 t^2 \widehat{\psi}) + c_2 t^2 \widehat{\psi}, \tag{B.4}$$

which has a conifold singularity at the origin. Notice that the exceptional divisor for each of the blowups is irreducible since $\widehat{\psi}$ is not a square; this implies that the corresponding gauge algebra on each type IV locus is $\mathfrak{su}(2)$. Also, since $\widehat{\psi}$ is not a square, the terms

$$\bar{y}^2 - c_2 t^2 \widehat{\psi} \tag{B.5}$$

cannot be factored. Indeed, without an additional (global) divisor which is not visible in the construction, this conifold point cannot be resolved. Thus, we have produced a crepant projective blowup which is not smooth, and which may or may not be maximal depending on the existence of a global divisor.

We now turn to a base containing a type II fiber (*i.e.*, a cuspidal curve) whose elliptic fibration has a fiber of type I_n^* along the cuspidal curve. At generic points of the curve, f and g have multiplicities 2 and 3 but at the singular point of the cuspidal curve, the multiplicities are 4 and 6. Thus, the singular point must be blown up.

The blown up base will have two rational curves which are tangent to each other. Over the proper transform of the original cuspidal curve the elliptic fibration has a fiber of type I_n^* ; but over the other curve the fiber has type I_{2n} . Since the curves are tangent, we cannot simply quote known results to understand the crepant (projective) blowups.

The singularity that appears at the intersection point is among those considered by Katz and Vafa [98], who found a local equation describing the singularity in the form

$$x^2 + y^2 z - z^{n+3} (z + t^2)^{2k}, \tag{B.6}$$

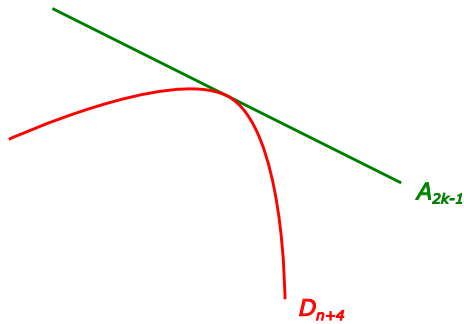

Figure 8. The original singular locus.

with a D_{n+4} singularity (Kodaira type I_n^*) along $x = y = z = 0$, and an A_{2k-1} singularity (Kodaira type I_{2k}) along $x = y = z + t^2 = 0$. We assume that $n \geq 1$ (since the case $n = 0$ is trivial), and $k \geq 1$. We will analyze this singularity by induction on k ; the application to our specific problem is the case $k = n$. The singularity is illustrated in Figure 8.

Note that the case of transverse intersection (the one already treated by Miranda [12]) is obtained from this by substituting $s = t^2$. We will comment on the differences as we go along.²¹

Our strategy is to resolve the A_{2k-1} singular locus, step by step. To this end, we blow up $x = y = z + t^2 = 0$, and consider two coordinate charts. The key coordinate chart for understanding the inductive structure has coordinates $\tilde{x} = x/(z + t^2)$, $\tilde{y} = y/(z + t^2)$, z , and t with equation

$$\tilde{x}^2 + \tilde{y}^2 z - z^{n+3}(z + t^2)^{2k-2}, \quad (\text{B.7})$$

which is a singularity of the same form but with a lower value of k . Note that if $k = 1$, then (B.7) takes the simpler form

$$\tilde{x}^2 + \tilde{y}^2 z - z^{n+3}, \quad (\text{B.8})$$

which has a curve of D_{n+4} singularities at $\tilde{x} = \tilde{y} = z = 0$ (and arbitrary t).

The exceptional divisor in this chart is described by $z + t^2 = 0$. Substituting that into the equation, if $k > 1$ we find two components

$$z + t^2 = \tilde{x} \pm t\tilde{y} = 0. \quad (\text{B.9})$$

(Note that in the transverse intersection case, with $s = t^2$, there is only a single irreducible component.) The two components meet at $z = \tilde{x} = t = 0$. This is illustrated in Figure 9.

On the other hand, if $k = 1$, the exceptional divisor takes the form

$$z + t^2 = \tilde{x}^2 - \tilde{y}^2 t^2 + (-1)^n t^{2n+6} = 0, \quad (\text{B.10})$$

²¹Note that Miranda's 1983 analysis produces a fiber in codimension two that is not of the expected Kodaira type, anticipating the phenomenon rediscovered in [99] and [100].

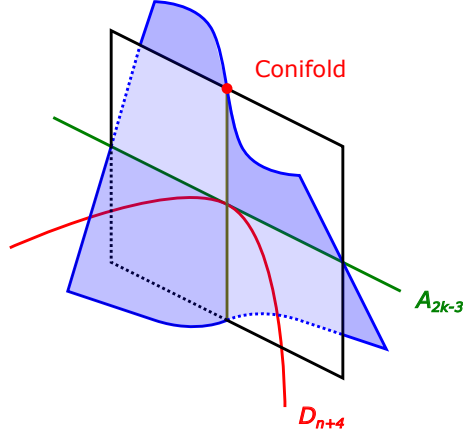

Figure 9. The first blowup.

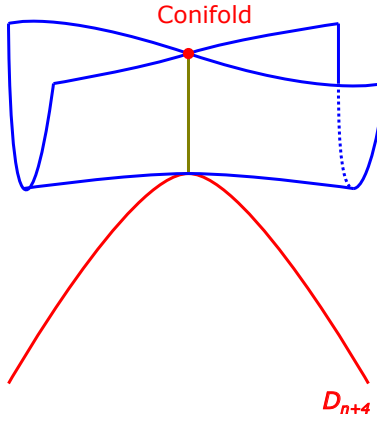

Figure 10. The final A_ℓ blowup.

which is an irreducible surface, singular along $z = \tilde{x} = t = 0$. (When we use s rather than t^2 , the surface has an isolated singularity at $\tilde{x} = \tilde{y} = z = s = 0$.) This is illustrated in Figure 10.

The other important coordinate chart²² has coordinates $\bar{x} = x/y$, $\bar{z} = (z + t^2)/y$, y , and t with equation

$$\bar{x}^2 + y\bar{z} - t^2 - (y\bar{z} - t^2)^{n+3}y^{2k-2}\bar{z}^{2k}. \quad (\text{B.11})$$

This time, the exceptional divisor is described by $y = 0$ and we again see two components when $k > 1$

$$y = \bar{x} \pm t = 0, \quad (\text{B.12})$$

meeting at $\bar{x} = y = t = 0$. (There is only a single component when we use s rather than t^2 .)

²²There is a third coordinate chart, but no new singularities appear there.

However, when $k = 1$ the exceptional divisor

$$y = \bar{x}^2 - t^2 + (-1)^n t^{2n+6} \bar{z}^2 \quad (\text{B.13})$$

is irreducible, and is singular along $\bar{x} = y = t = 0$. (It is nonsingular when we use s rather than t^2 .)

For any value of k , the threefold in this chart has a conifold singularity at the origin. If for $k \neq 1$ we rewrite (B.11) in factored form

$$(\bar{x} + t)(\bar{x} - t) + y \left(\bar{z} - (y\bar{z} - t^2)^{n+3} y^{2k-3} \bar{z}^{2k} \right), \quad (\text{B.14})$$

we see that a small resolution can be obtained by blowing up $x + t = y = 0$, which is one of the components of the exceptional divisor, *i.e.*, it exists globally as a divisor.

When $k = 1$, however, there is no obvious divisor to use for the global small resolution of the conifold point.

Note that if we use s rather than t^2 , (B.11) is nonsingular and a small resolution is not needed.

Thus, by induction on k we can resolve the I_{2k} locus almost completely, leaving only a single conifold point as well as the I_n^* locus. The singular I_n^* locus is just a product of a D_{n+4} singularity with the parameter curve, so its resolution proceeds just like the resolution of D_{n+4} . This leaves only the final conifold point unresolved, and depending on (unknown) global data it may not be possible to resolve it.

C \mathbb{C}^* bases with generic nonzero Mordell–Weil rank

This appendix contains the list of 13 \mathbb{C}^* bases identified in [42] over which a generic elliptic fibration has Mordell–Weil group of nonzero rank r . In each example, N chains of curves of negative self intersection connect curves Σ_0 and Σ_∞ with self-intersection n_0, n_∞ respectively. In each case, the Hodge numbers $h^{1,1}, h^{2,1}$ of the generic elliptically fibered Calabi–Yau threefold over that base are given.

$$\begin{aligned} r = 1 : \quad & N = 3, n_0 = -2, n_\infty = -3; \quad h^{1,1} = 34, h^{2,1} = 10 & (\text{C.1}) \\ \text{chain 1} : \quad & (-2, -1, -2) \\ \text{chain 2} : \quad & (-2, -2, -1, -4, -1) \\ \text{chain 3} : \quad & (-2, -2, -2, -2, -2 - 1, -8, -1, -2) \end{aligned}$$

$$\begin{aligned} r = 2 : \quad & N = 3, n_0 = -1, n_\infty = -2; \quad h^{1,1} = 24, h^{2,1} = 12 & (\text{C.2}) \\ \text{chain 1} : \quad & (-2, -1, -2) \\ \text{chain 2} : \quad & (-3, -1, -2, -2) \\ \text{chain 3} : \quad & (-6, -1, -2, -2, -2, -2, -2) \end{aligned}$$

$$\begin{aligned}
r = 2 : N = 3, n_0 = -2, n_\infty = -6; h^{1,1} = 46, h^{2,1} = 10 & \quad (C.3) \\
\text{chain 1} : (-2, -1, -3, -1) \\
\text{chain 2} : (-2, -2, -2, -1, -6, -1, -3, -1) \\
\text{chain 3} : (-2, -2, -2, -1, -6, -1, -3, -1)
\end{aligned}$$

$$\begin{aligned}
r = 2 : N = 3, n_0 = -5, n_\infty = -6; h^{1,1} = 61, h^{2,1} = 1 & \quad (C.4) \\
\text{chain 1} : (-1, -3, -1, -3, -1) \\
\text{chain 2} : (-1, -3, -2, -2, -1, -6, -1, -3, -1) \\
\text{chain 3} : (-1, -3, -2, -2, -1, -6, -1, -3, -1)
\end{aligned}$$

$$\begin{aligned}
r = 3 : N = 3, n_0 = -4, n_\infty = -8; h^{1,1} = 62, h^{2,1} = 2 & \quad (C.5) \\
\text{chain 1} : (-1, -4, -1, -2, -3, -2, -1) \\
\text{chain 2} : (-1, -4, -1, -2, -3, -2, -1) \\
\text{chain 3} : (-1, -4, -1, -2, -3, -2, -1)
\end{aligned}$$

$$\begin{aligned}
r = 4 : N = 3, n_0 = -1, n_\infty = -2; h^{1,1} = 25, h^{2,1} = 13 & \quad (C.6) \\
\text{chain 1} : (-2, -1, -2) \\
\text{chain 2} : (-4, -1, -2, -2, -2) \\
\text{chain 3} : (-4, -1, -2, -2, -2)
\end{aligned}$$

$$\begin{aligned}
r = 4 : N = 3, n_0 = -1, n_\infty = -5; h^{1,1} = 40, h^{2,1} = 4 & \quad (C.7) \\
\text{chain 1} : (-2, -1, -3, -1) \\
\text{chain 2} : (-4, -1, -2, -2, -3, -1) \\
\text{chain 3} : (-4, -1, -2, -2, -3, -1)
\end{aligned}$$

$$\begin{aligned}
r = 4 : N = 4, n_0 = -6, n_\infty = -6; h^{1,1} = 51, h^{2,1} = 3 & \quad (C.8) \\
\text{chain 1} : (-1, -3, -1, -3, -1) \\
\text{chain 2} : (-1, -3, -1, -3, -1) \\
\text{chain 3} : (-1, -3, -1, -3, -1) \\
\text{chain 4} : (-1, -3, -1, -3, -1)
\end{aligned}$$

$$\begin{aligned}
r = 4 : N = 3, n_0 = -2, n_\infty = -4; h^{1,1} = 35, h^{2,1} = 11 & \quad (\text{C.9}) \\
\text{chain 1} : (-2, -2, -1, -4, -1) \\
\text{chain 2} : (-2, -2, -1, -4, -1) \\
\text{chain 3} : (-2, -2, -1, -4, -1)
\end{aligned}$$

$$\begin{aligned}
r = 5 : N = 3, n_0 = -1, n_\infty = -8; h^{1,1} = 51, h^{2,1} = 3 & \quad (\text{C.10}) \\
\text{chain 1} : (-3, -1, -2, -3, -2, -1) \\
\text{chain 2} : (-3, -1, -2, -3, -2, -1) \\
\text{chain 3} : (-3, -1, -2, -3, -2, -1)
\end{aligned}$$

$$\begin{aligned}
r = 6 : N = 3, n_0 = -1, n_\infty = -2; h^{1,1} = 24, h^{2,1} = 12 & \quad (\text{C.11}) \\
\text{chain 1} : (-3, -1, -2, -2) \\
\text{chain 2} : (-3, -1, -2, -2) \\
\text{chain 3} : (-3, -1, -2, -2)
\end{aligned}$$

$$\begin{aligned}
r = 6 : N = 4, n_0 = -2, n_\infty = -6; h^{1,1} = 35, h^{2,1} = 11 & \quad (\text{C.12}) \\
\text{chain 1} : (-2, -1, -3, -1) \\
\text{chain 2} : (-2, -1, -3, -1) \\
\text{chain 3} : (-2, -1, -3, -1) \\
\text{chain 4} : (-2, -1, -3, -1)
\end{aligned}$$

$$\begin{aligned}
r = 8 : N = 4, n_0 = -2, n_\infty = -2; h^{1,1} = 19, h^{2,1} = 19 & \quad (\text{C.13}) \\
\text{chain 1} : (-2, -1, -2) \\
\text{chain 2} : (-2, -1, -2) \\
\text{chain 3} : (-2, -1, -2) \\
\text{chain 4} : (-2, -1, -2)
\end{aligned}$$

References

- [1] D. R. Morrison and W. Taylor, *Classifying bases for 6D F-theory models*, Central Eur. J. Phys. **10**, 1072 (2012), [arXiv:1201.1943](https://arxiv.org/abs/1201.1943) [hep-th].

- [2] A. Grassi, J. Halverson, J. Shaneson, and W. Taylor, *Non-Higgsable QCD and the Standard Model Spectrum in F-theory*, JHEP **01** (2015) 086, [arXiv:1409.8295 \[hep-th\]](#).
- [3] L. B. Anderson and W. Taylor, *Geometric constraints in dual F-theory and heterotic string compactifications*, JHEP **1408**, 025 (2014), [arXiv:1405.2074 \[hep-th\]](#).
- [4] D. R. Morrison and W. Taylor, *Non-Higgsable clusters for 4D F-theory models*, J. High Energy Phys. **05** (2015) 080, [arXiv:1412.6112 \[hep-th\]](#).
- [5] J. Halverson and W. Taylor, *\mathbb{P}^1 -bundle bases and the prevalence of non-Higgsable structure in 4D F-theory models*, JHEP **09** (2015) 086, [arXiv:1506.03204 \[hep-th\]](#).
- [6] W. Taylor and Y. N. Wang, *A Monte Carlo exploration of threefold base geometries for 4d F-theory vacua*, JHEP **1601**, 137 (2016), [arXiv:1510.04978 \[hep-th\]](#).
- [7] J. Halverson, *Strong Coupling in F-theory and Geometrically Non-Higgsable Seven-branes*, [arXiv:1603.01639 \[hep-th\]](#).
- [8] C. Schoen, *On fiber products of rational elliptic surfaces with section*, Math. Z., **197**, 177-199 (1988).
- [9] F. R. Cossec and I. V. Dolgachev, *Enriques surfaces. I*, Progress in Mathematics, vol. 76, Birkhäuser Boston Inc., Boston, MA, 1989.
- [10] Y. Fujimoto, *On rational elliptic surfaces with multiple fibers*, Publ. Res. Inst. Math. Sci. **26** (1990) 1–13.
- [11] G. Kapustka and M. Kapustka, *Fiber products of elliptic surfaces with section and associated Kummer fibrations*, Internat. J. Math. **20**, 401-426 (2009), [arXiv:0802.3760 \[math.AG\]](#).
- [12] R. Miranda, *Smooth models for elliptic threefolds*, The birational geometry of degenerations (Cambridge, Mass., 1981), Progr. Math., vol. 29, Birkhäuser Boston, Mass., 1983, pp. 85–133.
- [13] A. Grassi, *On minimal models of elliptic threefolds*, Math. Ann. **290** (1991) 287–301.
- [14] U. Persson, *Configurations of Kodaira fibers on rational elliptic surfaces*, Math. Z., **205**, 1-47 (1990).
- [15] R. Miranda, *Persson’s list of singular fibers for a rational elliptic surface*, Math. Z., **205**, 191-211 (1990).
- [16] C. Vafa, *Evidence for F-Theory*, Nucl. Phys. B **469**, 403 (1996), [arXiv:hep-th/9602022](#).
- [17] D. R. Morrison and C. Vafa, *Compactifications of F-Theory on Calabi–Yau Threefolds – I*, Nucl. Phys. B **473**, 74 (1996), [arXiv:hep-th/9602114](#).
- [18] D. R. Morrison and C. Vafa, *Compactifications of F-Theory on Calabi–Yau Threefolds – II*, Nucl. Phys. B **476**, 437 (1996), [arXiv:hep-th/9603161](#).
- [19] T. W. Grimm, T. Weigand, *On Abelian Gauge Symmetries and Proton Decay in Global F-theory GUTs*, Phys. Rev. **D82**, 086009 (2010), [arXiv:1006.0226 \[hep-th\]](#).
- [20] E. Dudas, E. Palti, *On hypercharge flux and exotics in F-theory GUTs*, JHEP **1009**, 013 (2010), [arXiv:1007.1297 \[hep-ph\]](#).
- [21] J. Marsano, *Hypercharge Flux, Exotics, and Anomaly Cancellation in F-theory GUTs*, Phys. Rev. Lett. **106**, 081601 (2011), [arXiv:1011.2212 \[hep-th\]](#).

- [22] M. J. Dolan, J. Marsano, N. Saulina, S. Schafer-Nameki, *F-theory GUTs with $U(1)$ Symmetries: Generalities and Survey*, Phys. Rev. **D84**, 066008 (2011), [arXiv:1102.0290 \[hep-th\]](#).
- [23] J. Marsano, N. Saulina, and S. Schäfer-Nameki, *G-flux, M5 instantons, and $U(1)$ symmetries in F-theory*, Phys. Rev. **D87** (2013) 066007, [arXiv:1107.1718 \[hep-th\]](#).
- [24] T. W. Grimm, M. Kerstan, E. Palti, and T. Weigand, *Massive Abelian Gauge Symmetries and Fluxes in F-theory*, JHEP **12** (2011) 004, [arXiv:1107.3842 \[hep-th\]](#).
- [25] D. R. Morrison and D. S. Park, *F-Theory and the Mordell–Weil Group of Elliptically-Fibered Calabi–Yau Threefolds*, JHEP **1210**, 128 (2012), [arXiv:1208.2695 \[hep-th\]](#).
- [26] C. Mayrhofer, E. Palti, and T. Weigand, *$U(1)$ symmetries in F-theory GUTs with multiple sections*, JHEP **03** (2013) 098, [arXiv:1211.6742 \[hep-th\]](#).
- [27] V. Braun, T. W. Grimm, and J. Keitel, *New Global F-theory GUTs with $U(1)$ symmetries*, JHEP **09** (2013) 154, [arXiv:1302.1854 \[hep-th\]](#).
- [28] M. Cvetič, D. Klevers, and H. Piragua, *F-Theory Compactifications with Multiple $U(1)$ -Factors: Constructing Elliptic Fibrations with Rational Sections*, JHEP **06** (2013) 067, [arXiv:1303.6970 \[hep-th\]](#).
- [29] V. Braun, T. W. Grimm, and J. Keitel, *Geometric Engineering in Toric F-Theory and GUTs with $U(1)$ Gauge Factors*, JHEP **12** (2013) 069, [arXiv:1306.0577 \[hep-th\]](#).
- [30] M. Cvetič, A. Grassi, D. Klevers and H. Piragua, *Chiral Four-Dimensional F-Theory Compactifications With $SU(5)$ and Multiple $U(1)$ -Factors*, JHEP **1404**, 010 (2014), [arXiv:1306.3987 \[hep-th\]](#).
- [31] J. Borchmann, C. Mayrhofer, E. Palti, and T. Weigand, *$SU(5)$ Tops with Multiple $U(1)$ s in F-theory*, Nucl. Phys. **B882** (2014) 1–69, [arXiv:1307.2902 \[hep-th\]](#).
- [32] M. Cvetič, D. Klevers, H. Piragua and P. Song, *Elliptic fibrations with rank three Mordell–Weil group: F-theory with $U(1) \times U(1) \times U(1)$ gauge symmetry*, JHEP **1403**, 021 (2014), [arXiv:1310.0463 \[hep-th\]](#).
- [33] D. R. Morrison and W. Taylor, *Sections, multisections, and $U(1)$ fields in F-theory*, J. Singularities **15** (2016) 126–149, [arXiv:1404.1527 \[hep-th\]](#).
- [34] I. Antoniadis and G. K. Leontaris, *F-GUTs with Mordell–Weil $U(1)$ ’s*, Phys. Lett. **B735** (2014) 226–230, [arXiv:1404.6720 \[hep-th\]](#).
- [35] M. Kuntzler and S. Schafer-Nameki, *Tate Trees for Elliptic Fibrations with Rank one Mordell–Weil group*, [arXiv:1406.5174 \[hep-th\]](#).
- [36] M. Esole, M. J. Kang, and S.-T. Yau, *A New Model for Elliptic Fibrations with a Rank One Mordell–Weil Group: I. Singular Fibers and Semi-Stable Degenerations*, [arXiv:1410.0003 \[hep-th\]](#).
- [37] C. Lawrie, S. Schafer-Nameki, and J.-M. Wong, *F-theory and All Things Rational: Surveying $U(1)$ Symmetries with Rational Sections*, JHEP **09** (2015) 144, [arXiv:1504.05593 \[hep-th\]](#).
- [38] M. Cvetič, D. Klevers, H. Piragua, and W. Taylor, *General $U(1) \times U(1)$ F-theory compactifications and beyond: geometry of unHiggsings and novel matter structure*, JHEP **11** (2015) 204, [arXiv:1507.05954 \[hep-th\]](#).

- [39] S. Krippendorff, S. Schafer-Nameki, and J.-M. Wong, *Froggatt-Nielsen meets Mordell–Weil: A Phenomenological Survey of Global F-theory GUTs with U(1)s*, *JHEP* **11** (2015) 008, [arXiv:1507.05961 \[hep-th\]](#).
- [40] M. Cvetič, A. Grassi, D. Klevers, M. Poretschkin and P. Song, *Origin of Abelian Gauge Symmetries in Heterotic/F-theory Duality*, *JHEP* **1604**, 041 (2016), [arXiv:1511.08208 \[hep-th\]](#).
- [41] D. R. Morrison and D. S. Park, *Tall sections from non-minimal transformations*, [arXiv:1606.07444 \[hep-th\]](#).
- [42] G. Martini and W. Taylor, *6D F-theory models and elliptically fibered Calabi–Yau threefolds over semi-toric base surfaces*, *JHEP* **06** (2015) 061, [arXiv:1404.6300 \[hep-th\]](#).
- [43] D. R. Morrison and W. Taylor, *Toric bases for 6D F-theory models*, *Fortschr. Phys.* **60** (2012) 1187–1216, [arXiv:1204.0283 \[hep-th\]](#).
- [44] L. B. Anderson, X. Gao, J. Gray and S. J. Lee, *Multiple Fibrations in Calabi–Yau Geometry and String Dualities*, [arXiv:1608.07555 \[hep-th\]](#).
- [45] L. Bhardwaj, M. D. Zotto, J. J. Heckman, D. R. Morrison, T. Rudelius, and C. Vafa, *F-theory and the classification of little strings*, *Phys. Rev. D* **93** (2016) 086002, [arXiv:1511.05565 \[hep-th\]](#).
- [46] S. Hohenegger, A. Iqbal and S. J. Rey, “Self-Duality and Self-Similarity of Little String Orbifolds,” *Phys. Rev. D* **94**, no. 4, 046006 (2016) doi:10.1103/PhysRevD.94.046006 [[arXiv:1605.02591 \[hep-th\]](#)].
- [47] A. Grassi, J. Halverson and J. L. Shaneson, *Matter From Geometry Without Resolution*, *JHEP* **1310**, 205 (2013), [arXiv:1306.1832 \[hep-th\]](#).
- [48] M. R. Douglas, D. S. Park and C. Schnell, *The Cremmer-Scherk Mechanism in F-theory Compactifications on K3 Manifolds*, *JHEP* **1405**, 135 (2014), [arXiv:1403.1595 \[hep-th\]](#).
- [49] D. R. Morrison, *What is F-theory?*, to appear.
- [50] J. de Boer, R. Dijkgraaf, K. Hori, A. Keurentjes, J. Morgan, D. R. Morrison, and S. Sethi, *Triples, fluxes, and strings*, *Adv. Theor. Math. Phys.* **4** (2001) 995–1186, [arXiv:hep-th/0103170](#).
- [51] V. Braun and D. R. Morrison, *F-theory on genus-one fibrations*, *JHEP* **1408** (2014) 132, [arXiv:1401.7844 \[hep-th\]](#).
- [52] D. R. Morrison and M. R. Plesser, *Non-spherical horizons, I*, *Adv. Theor. Math. Phys.* **3** (1999) 1–81, [arXiv:hep-th/9810201](#).
- [53] D. R. Morrison, K. Narayan, and M. R. Plesser, *Localized tachyons in $\mathbb{C}^3/\mathbb{Z}_N$* , *JHEP* **0408** (2004) 047, [arXiv:hep-th/0406039](#).
- [54] M. Schlessinger, *Rigidity of quotient singularities*, *Invent. Math.* **14** (1971) 17–26.
- [55] J. Fine, *On varieties isomorphic in codimension one to torus embeddings*, *Duke Math. J.* **58** (1989) 79–88.
- [56] Y. Hayakawa, *Degeneration of Calabi–Yau manifold with W-P metric*, [arXiv:alg-geom/9507016](#).

- [57] C.-L. Wang, *On the incompleteness of the Weil-Petersson metric along degenerations of Calabi-Yau manifolds*, Math. Res. Lett. **4** (1997) 157–171.
- [58] H. Hironaka, *Resolution of singularities of an algebraic variety over a field of characteristic zero. I, II*, Ann. of Math. (2) **79** (1964), 109–203; *ibid.* (2) **79** (1964) 205–326.
- [59] M. Artin, *Algebraic spaces*, Yale University Press, New Haven, Conn., 1971, A James K. Whittemore Lecture in Mathematics given at Yale University, 1969, Yale Mathematical Monographs, 3.
- [60] M. Reid, *Canonical 3-folds*, Journées de Géométrie Algébrique d’Angers, Juillet 1979/Algebraic Geometry, Angers, 1979 (Alphen aan den Rijn), Sijthoff & Noordhoff, Alphen aan den Rijn, 1980, pp. 273–310.
- [61] M. Reid, *Minimal models of canonical 3-folds*, Algebraic Varieties and Analytic Varieties (S. Iitaka, ed.), Adv. Stud. Pure Math., vol. 1, Kinokuniya, 1983, pp. 131–180.
- [62] P. S. Aspinwall and D. R. Morrison, *Stable singularities in string theory*, Comm. Math. Phys. **178** (1996) 115–134, (with an appendix by Mark Gross), [arXiv:hep-th/9503208](#).
- [63] S. Mori, *Threefolds whose canonical bundles are not numerically effective*, Ann. of Math. (2) **116** (1982) 133–176.
- [64] S. Mori, *Flip theorem and the existence of minimal models for 3-folds*, J. Amer. Math. Soc. **1** (1988) 117–253.
- [65] J. Song and B. Weinkove, *An introduction to the Kähler-Ricci flow*, An introduction to the Kähler-Ricci flow, Lecture Notes in Math., vol. 2086, Springer, Cham, 2013, pp. 89–188, [arXiv:1212.3653 \[math.DG\]](#).
- [66] Y. Kawamata, *Crepant blowing-up of 3-dimensional canonical singularities and its application to degenerations of surfaces*, Ann. of Math. (2) **127** (1988) 93–163.
- [67] J. Kollár, *Flops*, Nagoya Math. J. **113** (1989) 15–36.
- [68] Y. Namikawa and J. H. M. Steenbrink, *Global smoothing of Calabi-Yau threefolds*, Invent. Math. **122** (1995) 403–419.
- [69] A. Klemm, B. Lian, S. S. Roan and S. T. Yau, *Calabi-Yau fourfolds for M theory and F theory compactifications*, Nucl. Phys. B **518**, 515 (1998), [arXiv:hep-th/9701023](#).
- [70] N. Seiberg, *Nontrivial fixed points of the renormalization group in six-dimensions*, Phys. Lett. B **390**, 169 (1997), [arXiv:hep-th/9609161](#).
- [71] S. Katz, P. Mayr, and C. Vafa, *Mirror symmetry and exact solution of 4D N = 2 gauge theories. I*, Adv. Theor. Math. Phys. **1** (1998) 53–114, [arXiv:hep-th/9706110](#).
- [72] A. Grassi, *Log contractions and equidimensional models of elliptic threefolds*, J. Algebraic Geom. **4** (1995) 255–276, [arXiv:alg-geom/9305003](#).
- [73] P. Candelas, P. S. Green and T. Hubsch, *Finite Distance Between Distinct Calabi-Yau Manifolds*, Phys. Rev. Lett. **62**, 1956 (1989).
- [74] P. Candelas, P. S. Green and T. Hubsch, *Rolling Among Calabi-Yau Vacua*, Nucl. Phys. B **330**, 49 (1990).

- [75] B. R. Greene, D. R. Morrison and A. Strominger, *Black hole condensation and the unification of string vacua*, Nucl. Phys. B **451**, 109 (1995) [arXiv:hep-th/9504145](#).
- [76] B. R. Greene, D. R. Morrison and C. Vafa, *A geometric realization of confinement*, Nucl. Phys. B **481**, 513–538 (1996) [arXiv:hep-th/9608039](#).
- [77] P. S. Aspinwall, S. H. Katz and D. R. Morrison, *Lie groups, Calabi-Yau threefolds, and F theory*, Adv. Theor. Math. Phys. **4**, 95 (2000) [arXiv:hep-th/0002012](#).
- [78] R. Friedman, *Simultaneous resolution of threefold double points*, Math. Ann. **274** (1986) 671–689.
- [79] C. H. Clemens, *Double solids*, Adv. Math. **47** (1983) 107–230.
- [80] C. H. Clemens, *Homological equivalence modulo algebraic equivalence is not finitely generated*, Publ. Math. IHES **58** (1983) 19–38.
- [81] D. R. Morrison, *Through the looking glass*, Mirror Symmetry III (D. H. Phong, L. Vinet, and S.-T. Yau, eds.), AMS/IP Stud. Adv. Math., vol. 10, International Press, Cambridge, 1999, pp. 263–277, [arXiv:alg-geom/9705028](#).
- [82] P. Arras, A. Grassi and T. Weigand, *Terminal singularities, Milnor numbers, and matter in F-theory*, to appear.
- [83] P. Orlik and P. Wagreich, *Isolated singularities of algebraic surfaces with C^* action*, Ann. of Math. (2) **93** (1971) 205–228.
- [84] P. Orlik and P. Wagreich, *Singularities of algebraic surfaces with C^* action*, Math. Ann. **193** (1971) 121–135.
- [85] K. Altmann, N. O. Ilten, L. Petersen, H. Süß, and R. Vollmert, *The geometry of T-varieties*, EMS Ser. Congr. Rep., Eur. Math. Soc., Zürich, 2012, pp. 17–69, [arXiv:1102.5760](#) [[math.AG](#)].
- [86] J. J. Heckman, D. R. Morrison and C. Vafa, *On the Classification of 6D SCFTs and Generalized ADE Orbifolds*, JHEP **1405**, 028 (2014), [arXiv:1312.5746](#) [[hep-th](#)].
- [87] M. Del Zotto, J. J. Heckman, D. R. Morrison and D. S. Park, *6D SCFTs and Gravity*, JHEP **1506**, 158 (2015), [arXiv:1412.6526](#) [[hep-th](#)].
- [88] T. Shioda, *Theory of Mordell-Weil lattices*, in *Proceedings of the International Congress of Mathematicians, Vol. I, II (Kyoto, 1990)*, pp. 473–489, Math. Soc. Japan, Tokyo, 1991.
- [89] D. S. Park, *Anomaly Equations and Intersection Theory*, JHEP **1201**, 093 (2012), [arXiv:1111.2351](#) [[hep-th](#)].
- [90] D. S. Park and W. Taylor, *Constraints on 6D Supergravity Theories with Abelian Gauge Symmetry*, JHEP **1201**, 141 (2012), [arXiv:1110.5916](#) [[hep-th](#)].
- [91] J. H. Silverman, *The arithmetic of elliptic curves*, vol. 106 of *Graduate Texts in Mathematics*. Springer, Dordrecht, second ed., 2009.
- [92] D. R. Morrison, *Beyond the Kähler cone*, Proc. of the Hirzebruch 65 Conference on Algebraic Geometry (M. Teicher, ed.), Israel Math. Conf. Proc., vol. 9, Bar-Ilan University, 1996, pp. 361–376, [arXiv:alg-geom/9407007](#).
- [93] T. Shioda, *On elliptic modular surfaces*, J. Math. Soc. Japan **24** (1972) 20–59.
- [94] R. Wazir, *Arithmetic on elliptic threefolds*, Compos. Math., **140**, pp. 567–580, (2004).

- [95] N. Seiberg, *New theories in six dimensions and matrix description of M-theory on T^5 and T^5/Z_2* , Phys. Lett. B **408** (1997) 98–104, [arXiv:hep-th/9705221](#).
- [96] K. A. Intriligator, *New string theories in six-dimensions via branes at orbifold singularities*, Adv. Theor. Math. Phys. **1** (1998) 271–282, [arXiv:hep-th/9708117](#).
- [97] K. A. Intriligator, *Compactified little string theories and compact moduli spaces of vacua*, Phys. Rev. D **61** (2000) 106005, [arXiv:hep-th/9909219](#) [[hep-th](#)].
- [98] S. H. Katz and C. Vafa, *Matter from geometry*, Nucl. Phys. B **497**, 146 (1997) [arXiv:hep-th/9606086](#).
- [99] D. R. Morrison and W. Taylor, *Matter and singularities*, JHEP **01** (2012) 022, [arXiv:1106.3563](#) [[hep-th](#)].
- [100] M. Esole and S.-T. Yau, *Small resolutions of $SU(5)$ -models in F-theory*, Adv. Theor. Math. Phys. **17** (2013) 1195–1253, [arXiv:1107.0733](#) [[hep-th](#)].
- [101] V. Braun and D. R. Morrison, *F-theory on Genus-One Fibrations*, JHEP **1408**, 132 (2014), [arXiv:1401.7844](#) [[hep-th](#)].
- [102] L. B. Anderson, I. Garcia-Etxebarria, T. W. Grimm and J. Keitel, *Physics of F-theory compactifications without section*, JHEP **1412**, 156 (2014), [arXiv:1406.5180](#) [[hep-th](#)].
- [103] C. Mayrhofer, E. Palti, O. Till and T. Weigand, *Discrete Gauge Symmetries by Higgsing in four-dimensional F-Theory Compactifications*, JHEP **1412**, 068 (2014), [arXiv:1408.6831](#) [[hep-th](#)].
- [104] D. Klevers, D. K. Mayorga Pena, P. K. Oehlmann, H. Piragua and J. Reuter, *F-Theory on all Toric Hypersurface Fibrations and its Higgs Branches*, JHEP **1501**, 142 (2015), [arXiv:1408.4808](#) [[hep-th](#)].
- [105] M. Cvetič, R. Donagi, D. Klevers, H. Piragua and M. Poretschkin, *F-theory vacua with \mathbb{Z}_3 gauge symmetry*, Nucl. Phys. B **898**, 736 (2015) [arXiv:1502.06953](#) [[hep-th](#)].
- [106] A. Font, I. Garcia-Etxebarria, D. Lust, S. Massai and C. Mayrhofer, *Heterotic T-folds, 6D SCFTs, and F-Theory*, [arXiv:1603.09361](#) [[hep-th](#)].