

Optimizing the Efficiency and Filter Area of the SurgiBox Environmental System by Redistributing Effective Media Area across Filter Length

by

Sandra L. Walter

Submitted to the Department of Mechanical Engineering in
Partial Fulfillment of the Requirements for the Degree of

Bachelor of Science

at the

Massachusetts Institute of Technology

May 2020

© 2020 Sandra Walter
All rights reserved

The author hereby grants to MIT permission to reproduce and to distribute publicly paper and electronic copies of this thesis document in whole or in part in any medium now known or hereafter created.

Signature of Author

Department of Mechanical Engineering
May 8, 2020

Certified by.....

Daniel Frey
Professor of Mechanical Engineering
Thesis Supervisor

Accepted by.....

Maria Yang
Professor of Mechanical Engineering
Undergraduate Officer

Optimizing the Efficiency and Filter Area of the SurgiBox Environmental System by Redistributing Effective Media Area across Filter Length

by

Sandra L. Walter

Submitted to the Department of Mechanical Engineering on
May 8, 2020 in Partial Fulfillment of the Requirements for the
Degree of Bachelor of Science in Mechanical Engineering

Across the globe, billions of people lack access to safe surgery. SurgiBox is working to lower that number by creating a portable surgical environment for patients in need. To do this, they are working to improve their air filtration system by better utilizing filter media to create a more efficient system. To help SurgiBox achieve this goal, Solidworks Flow Simulation Models were created and analysed to determine what parameters would be necessary to achieve a goal of a uniform velocity profile while meeting volumetric flow rate specifications. These models show that it is possible to achieve a uniform velocity distribution by using filters with varied resistances to air flow. It was found that, neglecting edge effects, the pressure drops (at a defined velocity) of the filter follow a linear trend across the length of the filter. However, these models also show that edge effects lead to significant air flow inconsistencies revealing that if these edge effects are not addressed, the system may quickly fall out of specification. Numerically generated “ideal” system centerline velocity and pressure curves were created to be used as comparative tools while conducting experiments on the SurgiBox system. These, in combination with the SolidWorks models will inform design changes to the SurgiBox system and help the SurgiBox team quantitatively assess the quality of their designs.

Thesis Supervisor: Daniel Frey

Title: Professor of Mechanical Engineering

Acknowledgements

I would like to thank Professor Dan Frey for sticking with me and encouraging me to push through challenges to keep learning. I would also like to thank Debbie and Stephen from the SurgiBox team. Stephen, thank you for sharing your technical expertise to help me truly understand the SurgiBox system. Debbie, getting to know you and your story over the past year and a half has been an inspiring opportunity. You have been an outstanding mentor; your caring and compassion has helped me so much and I am honored to contribute in any way I can to the amazing vision you have with SurgiBox. Finally, I would like to thank my friends for being supportive even when I talked about this all the time.

Table of Contents

1: Introduction	5
2: Background	6
2.1: SurgiBox	6
2.1.1: SurgiBox's Product and Vision	6
2.1.2: Environmental Box Design	7
2.2: Pleated Filter Media	8
2.3: Assumptions when Looking at Air Flow Through Pleated Filter Media	12
2.3.1: Pleat Shape	12
2.3.2: Normal Flow	12
2.3.3: Turbulence Inside the Air Filtration Box	13
2.3.4: Other Assumptions	14
2.4: Pressure Drop across Pleated Filter Media	14
2.5: Specifications of HEPA Filter Paper	17
3: Methods	20
4: SolidWorks Visual Optimization	21
4.1: Model Setup	21
4.2: Uniform Filter Density	22
4.3: Combining One and Two Inch Thick Filters	23
4.4: Optimizing with More Partitions	27
4.6: What Resistances Produce Uniform Flow?	32
5: Understanding the Effects of an Optimized System	35
5.1: Pressure Distribution Inside the SurgiBox System	35
5.2: What would a Perfect System Look Like?	38
5.3: Model Comparisons to Ideal Pressure Curve	40
5.4: Understanding Pressure Drops from Atmospheric to Centerline	41
6: Conclusion	44
7: References	46
8: Appendices	47
8.1: Appendix A	47
8.2: Appendix B	49

8.3: Appendix C	50
8.4: Appendix D	52

1: Introduction

SurgiBox, a company that seeks to bring safe surgery to those who would not otherwise have access to a hospital operating room, is in the process of redesigning the air filtration system. Surgibox is a novel medical technology that sprung from team members questioning the assumption that operating rooms had to be large buildings or tents. By realising that surgeons' bodies could be outside the sterilized surgical setting, similarly to how a glove box is used to handle chemicals, the team was able to create a collapsible surgical bubble that fits in a backpack.

SurgiBox has made incredible progress towards their goal, but is still striving to make their system more compact. To do this, the team needed to transform their current environmental box into a compressible version of itself. This requires designing a compressible filter. To make the system as small as possible, the amount of filter paper used must be minimized. However, because the filter is perpendicular to the fan, the pull of the fan changes based on its distance from the fan. To combat this, effective filter areas can be adjusted to produce a more uniform flow. Analysis is needed to determine the optimal pleat density as a function of distance away from the fan.

To determine this pleat density function, analysis was conducted in SolidWorks Flow Modeling software and an ideal model was created in MATLAB. Insights from these applications informed recommendations to the SurgiBox team.

2: Background

2.1: SurgiBox

2.1.1: SurgiBox's Product and Vision

Manmade and natural disasters continuously put millions of people in life-threatening situations. Rural communities in developing countries lack facilities where major medical procedures can be performed. Currently, 5 billion people lack access to safe surgery. Each year, 18 million deaths could be prevented with timely access to safe surgical care [8]. SurgiBox seeks to provide a safe surgical setting to help prevent these deaths and help patients live longer, healthier lives.

SurgiBox is an organization founded by Dr. Debbie Lin Teodorescu, MD, MEng, AM that seeks to bring safe surgical settings to patients in need. Questioning the assumption that safe surgical environments need to fill a room, the SurgiBox Team created a portable surgical setting that attaches to the patient. This shift in thinking is depicted in Figure 2.1.1.1.

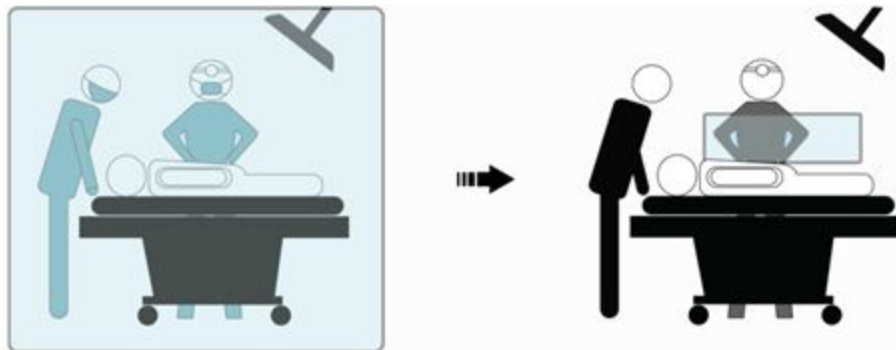

Figure 2.1.1.1: SurgiBox transformed the idea of a safe surgical setting from a clean room (left) to the SurgiBox device (right).

Creating a smaller, more portable surgical setting allows for a fast set up time and superior mobility. These features allow for more patients to be treated faster; it is a device that is desperately needed across the world.

The SurgiBox system consists of two main components: the bubble and the environmental box. These components are shown in Figure 2.1.1.2.



Figure 2.1.1.2: Surgibox bubble (left) and air filtration box (right)

The bubble is where the surgery actually takes place. Made out of soft, clear plastic, it unfolds when filled with clean air and has ports for surgeons to insert their hands and transport equipment in and out of SurgiBox. The environmental box cleans the air that goes into SurgiBox. It uses a HEPA filter to ensure that the air inside the bubble meets the cleanliness standards of a hospital operating room.

Along with the battery, these two components comprise the SurgiBox system. To reach communities with critical need, the SurgiBox system needs to condense to fit comfortably within a backpack. Because the bubble is made of thin, flexible material, it easily folds down to a small cylindrical package that slides neatly into any bag. Because powering the fan is the primary source of power consumption in the system, a small lightweight battery meets SurgiBox's power consumption needs. The current version of the air filtration box is the bulkiest component; it is block-shaped and made of rigid parts making it hard to fit into a bag. In addition, it is mostly hollow. This means that there is room for improvement on the compatibility aspect of this design so it was identified as an opportunity for improvement and work was done to redesign the component.

2.1.2: Environmental Box Design

In an effort to make SurgiBox easier to transport, design work has been conducted to create a collapsible environmental box. This new design features a collapsible filter that will allow the environmental box to condense to about a quarter of its size during transport. This design is shown in both the open and closed positions in Figure 2.1.2.1.

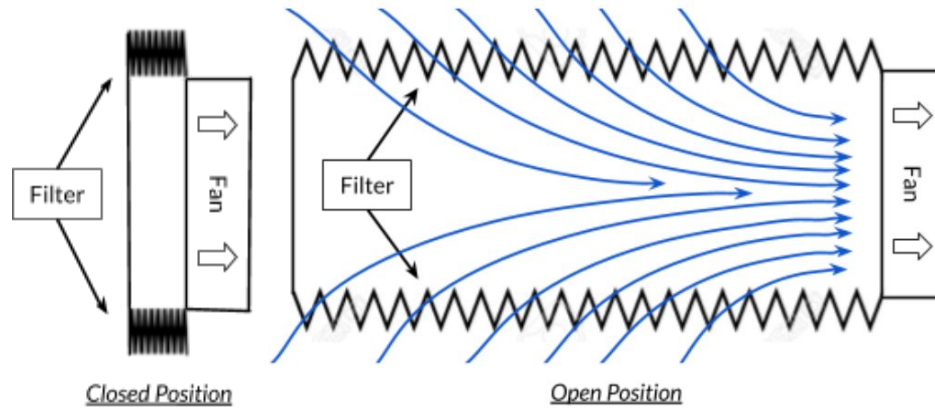

Figure 2.1.2.1: Simplified drawings of the environmental box design in the closed (left) and opened (right) positions. The filter paper, fan, and back wall of the device are shown. The blue lines represent air flowing through the system.

In the closed position, the filter paper is compressed and the box becomes smaller for transportation. To be as compact as possible, it is important to minimize the amount of filter paper used without overwhelming the filter. This thesis will discuss a model created to determine the filter pleat density function necessary to minimize this value.

It is SurgiBox's goal to create a system that can inflate the 300 liter bubble in 30 seconds. This means that the environmental box must filter 0.01 cubic meters of air each second. As will be discussed in section 2.5: *Specifications of HEPA Filter Paper*, there are limitations on the maximum velocity air can travel through a HEPA filter while remaining within filtration specifications. This data, combined with the target volumetric flow rate of 0.01 cubic meters per second, will inform the minimum area of filter paper required for the environmental box.

2.2: Pleated Filter Media

Pleating is common in air filtration applications. It is used to increase the effective filtration area as well as reduce velocity. This means that with pleats, filters can have a substantially higher capacity, higher efficiency, and lower energy consumption than flat media [1]. However, after a certain point, it is not always better to add more pleats. Exceptionally high pleat densities can lead to a reduction in airflow and a corresponding increase in pressure drop or decrease in permeability. This can be caused by factors such as pleat crowding, filter media compression, and pleat distortion [1]. Therefore, it is important to stay within a 'happy medium' range of pleat densities. Figure 2.2.1, adapted

from Brown 1993 shows how the pressure drop changes as pleats per unit length is increased.

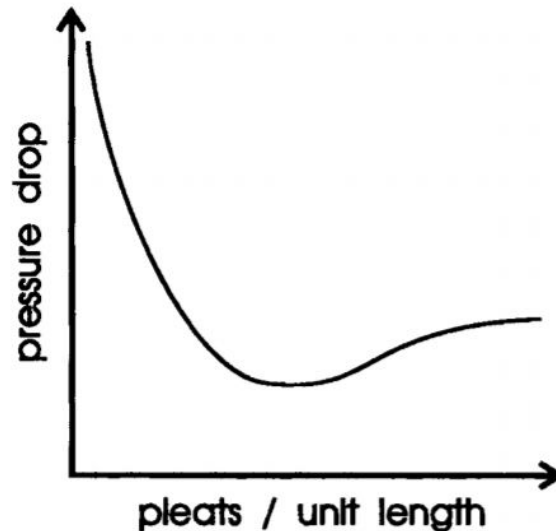

Figure 2.2.1: Pressure drop versus pleat density for a given media type and pleat height, adapted from Brown [1990, p. 65] [7]

The “happy medium” range is the dipped part of the curve. This point is summarized well in *The Effect of Pleating Density and Dust Type on Performance of Absolute Fibrous Filters*. This paper states that, “Introducing surface area is not the point; the point is introducing effective surface area that participates in the filtration action by allowing the air to access it. If this does not happen, the extra surface area will have a counter effect by reducing permeability and consequently raise the pressure drop ... This research has strongly emphasized that the long believed rule which suggests the higher the pleating density, the lower the pressure drop is not always true. This experimental work has shown that the higher the pleating density, the higher the number of pleats, so the more geometrical deformation that can be expected to take place” [1].

According to this research, conducted at Loughborough University on HEPA filter media at low velocities, losses in surface area and media distortion in high pleat density filters causes a large decrease in permeability. These reductions in permeability occurred in pleat densities of 32 and 34 pleats /100 mm [1]. This decrease in permeability means that a higher pressure drop across the filter media is needed for the same volume of air to pass through every second. To achieve this higher pressure drop in SurgiBox’s system, the fan

must increase in speed and therefore have increased power consumption. To keep costs low while maintaining long battery life, pressure drop across filter media should be minimized. Therefore, this research indicates that for SurgiBox's applications, keeping pleat densities at or below 32 pleats /100 mm will lead to higher efficiency.

Air filters are often described as being like strainers for air particles: they let the small air molecules through while stopping larger pollution particles. However, this comparison does not tell the whole story. Most filters, including HEPA filters, use diffusion, inertial impact, and interception to capture particles [3]. The differences between these capture methods as well as a comparison to the 'straining' method can be seen in Figure 2.2.2.

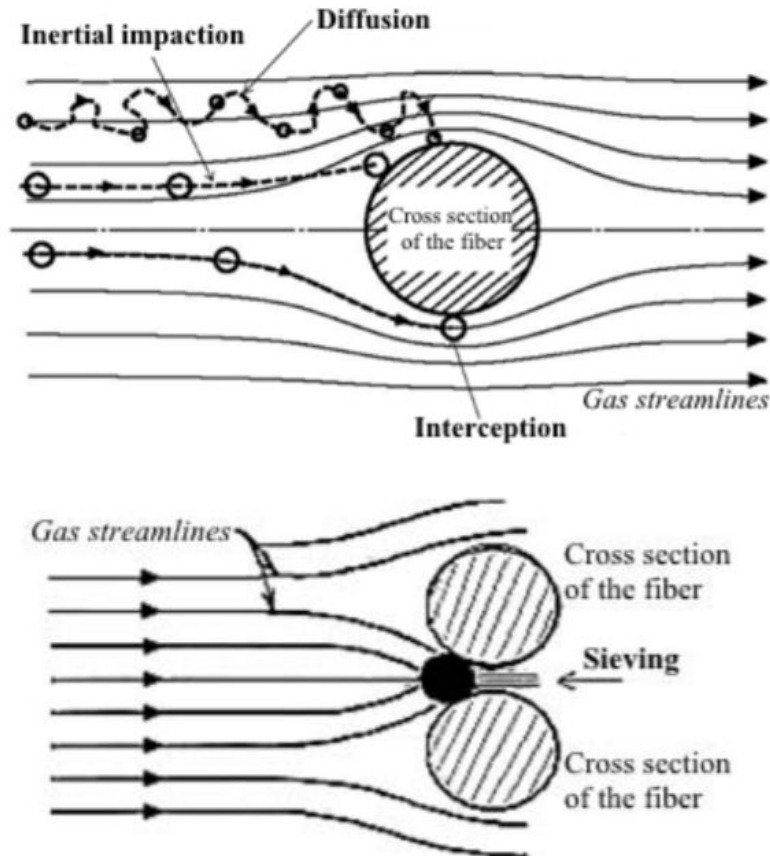

Figure 2.2.2: Top: diffusion, inertial impact, and interception mechanisms of particle deposition onto a fiber. Bottom: sieving or straining filtration method [4].

The diffusion capture method is used to trap tiny particles that are experiencing Brownian motion. Inertial impact captures particles with higher inertia that are unable to follow the streamlines of air around the fiber. Interception captures particles that move with the air stream, but are intercepted by the edges of the fibers as they move past. In contrast, the sieving or straining method traps particles that are unable to fit between fibers [4]. Diffusion, inertial impact, and interception allow HEPA filters to be effective while having fiber spacing that is larger than the smallest particle they are trying to trap. This can allow for greater efficiency and less clogging in the filter.

Because it utilizes different forms of capture, flow velocity - like pleat density - has its own “happy medium” range to maximise efficiency. Figure 2.2.3 shows how the total efficiency changes as velocity increases.

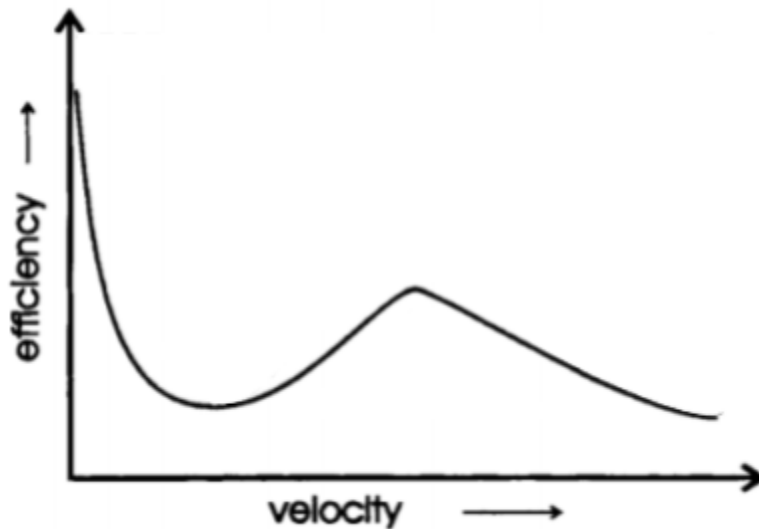

Figure 2.2.3: Filtration Efficiency vs. flow velocity, adapted from Stenhouse [1975]. [7]

Running a filtration system at the peak velocity will give the best efficiency. However, this is not the only aspect that comes into play when determining optimal flow velocity. As will be discussed in greater depth in Section 2.5: *Specifications of HEPA Filter Paper*, percent penetration must also be considered [3]. As velocity increases, there is a greater chance that dangerous particles could slip through the filter. Therefore, the velocity must be kept low enough to keep the system within specification.

2.3: Assumptions when Looking at Air Flow Through Pleated Filter Media

In order to find the optimal pleat density of the filter media, it is important to understand how air flows through pleated filter media and outline major assumptions about this flow.

2.3.1: Pleat Shape

The first assumption pertains to the shape of the filter media. It is common to visualize pleats as having sharp creases. However, the fabric-like properties of filter paper make this almost impossible in real life. Figure 2.3.1.1 shows how the actual pleat shape is a combination of a triangle wave and a square wave.

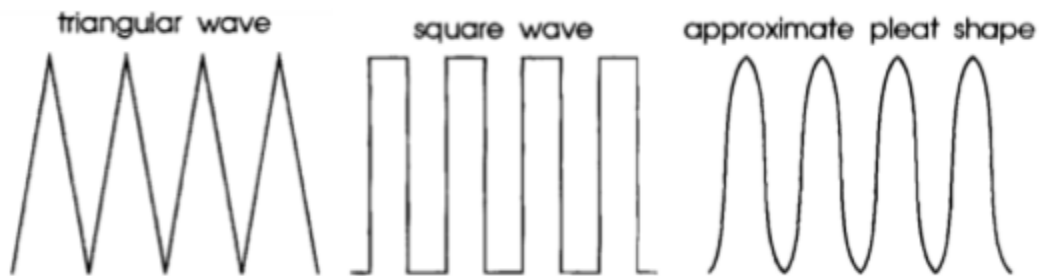

Figure 2.3.1.1: Pleat shape approximation [7]

Since there will always be manufacturing variations in the production of pleated media, this diagram must use an “approximate pleat shape” to describe the pleats. For this reason, there is no practical mathematical function to describe exact pleat shape. When performing calculations, a model is always used. Both triangle and square models are common, but for the purposes of this paper, a triangular model will be used. It is important to note that because the filter media clumps/compresses at the tops and bottoms of the pleats, the effective area will be less than the assumptions made by the triangular model. Therefore, this model will give filter areas that are smaller than what would be needed in practice.

2.3.2: Normal Flow

Another important assumption is that air flows normal to the filter media surface. Figure 2.3.2.1 shows the distinction between air flowing normal to the filter media and air flowing straight through the filter media.

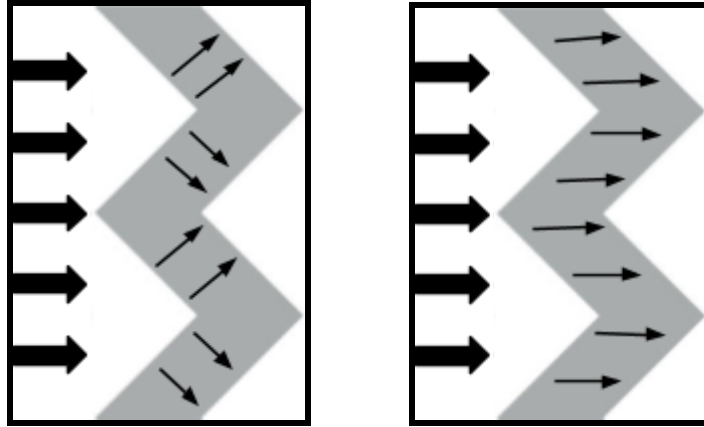

Figure 2.3.2.1: Air flow through pleated filter media (grey). On the left, the air is shown flowing normal to the surface of the filter media and on the right, the air is shown traveling straight through the media.

Although this is not a perfect model, treating the air flow as normal to the filter media is a good approximation of the flow within pleated filter media [7]. In Figure 2.3.2.1, the thin arrows represent the surface velocity of the air: the velocity at which air passes through the filter media. Because of the increased area created by the pleats when air flows normal to the filter, the surface velocity is significantly smaller than the entrance velocity (depicted by the thicker arrows). Being able to handle a high entrance velocity while maintaining a low surface velocity is the reason filter manufacturers choose pleated filter media over flat filter paper.

2.3.3: Turbulence Inside the Air Filtration Box

One assumption that must be carefully considered when setting up this model is the assumption that there is negligible turbulence inside the system. When the air leaves the filter media, it is turbulent and can be classified as jet flow [7]. Figure 2.3.3.1, taken from Charles B. Tebbuit's *CFD Model of Flow through Air Filter Pleats* depicts how the flow settles as it moves farther and farther away from the filter media.

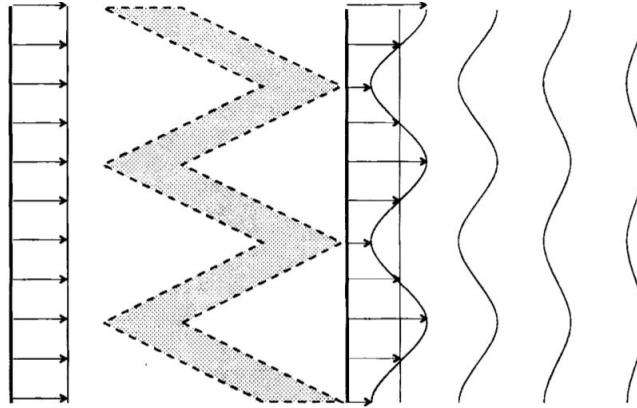

Figure 2.3.3.1: air flow profile as the air moves away from the filter media

As the air moves further away from the media, it transitions from turbulent to laminar flow [7]. Because of the way SurgiBox's environmental box is designed, the air will only be able to partially undergo this transformation before being sucked through the fan. This will lead to some turbulence inside of the box which will cause inefficiencies. The significance of these inefficiencies is not currently known, but could be deduced through experimental procedure once this component is in the prototyping phase.

2.3.4: Other Assumptions

Other crucial assumptions are that the flow is steady state, two dimensional, and that the entrance velocity enters perpendicular to the filter. Steady state can be assumed because of the device's long use time. Two dimensional flow can be assumed because of pleat symmetry. It can be assumed that the entrance velocity enters perpendicular to the filter if we neglect edge effects. Because the device is operating at low surface velocities and is pulling air from an outdoor environment, the edge effects should be minimal.

2.4: Pressure Drop across Pleated Filter Media

To create a model for airflow through the SurgiBox system, it is necessary to understand the pressure drop across the filter media. To do this, many factors must be considered including the flow velocity, the material properties of the filter media, and the dust load of the filter. Generally, the pressure drop across the filter media will rise as the flow velocity increases and drop as the dust load increases. Many authors such as Gunn and McDonough

1980, Raber 1982, and Rivers 1990 agree that a good approximation of the pressure drop across a filter can be summarized by Equation 1.

$$\Delta P_f = K_{ee} U_f^2 + K_m U_m \quad (1)$$

Where ΔP_f is the overall filter resistance, U_f is the filter face velocity, U_m is the average media velocity, K_{ee} is the coefficient dependent on the gross geometry of the entrance and exit passages within the filter, and K_m is the coefficient dependent on the media geometry including the presence of captured dust [5]. Because K_{ee} and K_m are incredibly general, depend on environmental factors, and need to be calculated experimentally, this model serves as more of a way to help people visualise how much different factors affect pressure drop than a basis for computation.

In *Media Velocity Considerations in Pleated Air Filtration*, Fredric Carl Schousbow explained flow modeling equations as built upon modification to Darcy's Law. This law is given by equation 2.

$$\nabla p = -\frac{\mu}{k} \vec{v} \quad (2)$$

In this equation, ∇p is the pressure loss across the filter media, μ is the fluid viscosity, k is a constant of proportionality intrinsic to the porous medium, and \vec{v} is the fluid velocity. This equation is designed for situations where the flow is homogeneous, there are minimal interactions at the interface between the fluid and filter media, there is a low flow rate, and there is no slip flow [6]. For the most part, these conditions are a decent approximation of the SurgiBox system. However, a better approximation could be made using one of the modifications to the system.

To account for the behaviour and apparent viscosity of the fluid within the filter media, the Brinkman's Modification to Darcy's Law was created. This modification adds a damping term to account for the losses. With this modification, the pressure loss becomes equation 3 where μ_e describes the viscosity of the fluid within the media [6].

$$\nabla p = -\frac{\mu}{k} \vec{v} + \mu_e \nabla^2 \vec{v} \quad (3)$$

If all of the variables are known, this equation can precisely describe the pressure drop across the filter media in the SurgiBox system. However, both k and μ_e are specific to the filter and must be determined experimentally.

Therefore, there is no other choice but to look at experimental results to determine pressure drop across the filter. When looked at experimentally, media resistance (Δp) consistently follows Equation 4 where a and b are experimental constants [5].

$$\Delta p = aU_m + bU_m^2 \quad (4)$$

Data sets exist for a number of different filters in different conditions. In *Criteria for Calculating the Efficiency of HEPA Filters During and After Design Basis Accidents*, the authors analyse experimental data from Gregory et al. (39). This data, shown in figure 2.4.1, is representative of a clean, standard HEPA filter.

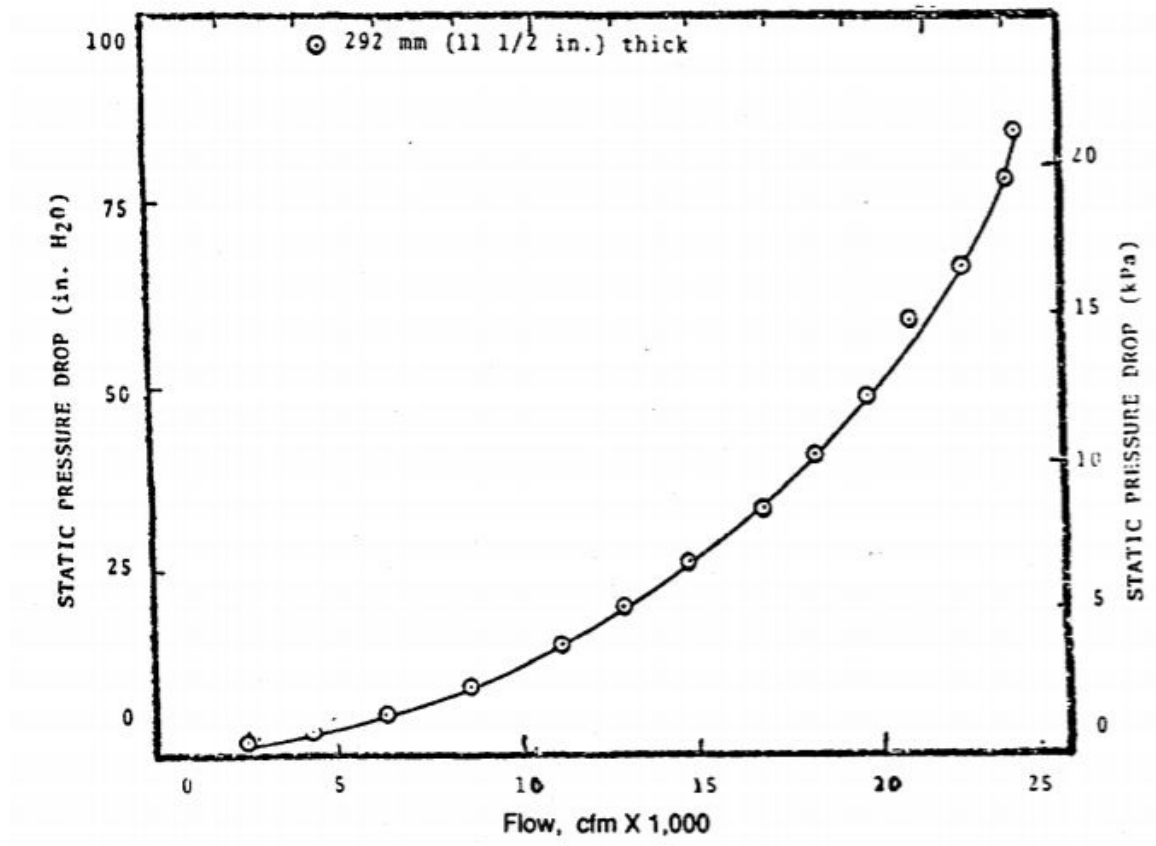

Figure 2.4.1: static pressure versus flow rate through a standard, clean HEPA filter

This graph gives the corresponding pressure drop for a wide range of flow rates [2]. In addition to this data, it is also important to understand the effects of subjecting the filter to a certain pressure. Figure 2.4.2 outlines the threshold values of differential pressure required to structurally damage a standard HEPA filter.

<u>Parameter</u>	<u>ΔP Threshold*, inches w.g.</u>
Baseline (new filter, normal conditions)	37
Age (greater than 14 years)	13
Radiation (6×10^7 Rad)	18
Chemical (HNO ₃ , HF)	0-37
Temperature	
less than 200°C, (392°F)	37
200-300°C, (192-572°F)	26
300-400°C, (572-752°F)	15
400-500°C, (752-932°F)	8
Moisture	
wet filter, (greater than 95% relative humidity)	10
dry filter, previously wet	22

Figure 2.4.2: Maximum pressure drop across HEPA filter media for filters that have been damaged through different means [2]

Because the SurgiBox system has the potential to be exposed to a wide range of harsh environmental conditions, it is important to maintain a maximum pressure below the values on the table to avoid damaging the filter.

2.5: Specifications of HEPA Filter Paper

To meet air filtration specifications, the Surgibox uses a HEPA air filter. HEPA filters are defined as air filters that filter out at least 99.97% of particles in aerosols with essentially monodispersed 0.3 micrometer diameter particles [3]. However, many filters only meet this specification when operating at a specific velocity range. ASME AG-1 specifications require the maximum HEPA filter media velocity to be five feet per minute [3]. This velocity is incredibly slow and in most cases, required flow volumes can only be achieved through large duct sizes with high pleat density. Gerard Garcia of Bechtel National Incorporated argues that this value is absurdly conservative and not necessary to achieve the filtration ratings required by ASME AG-1. Garcia located the data that the 5 feet per minute requirement is based off of. This data is shown in Figure 2.5.1.

Particle Size Penetration Curves

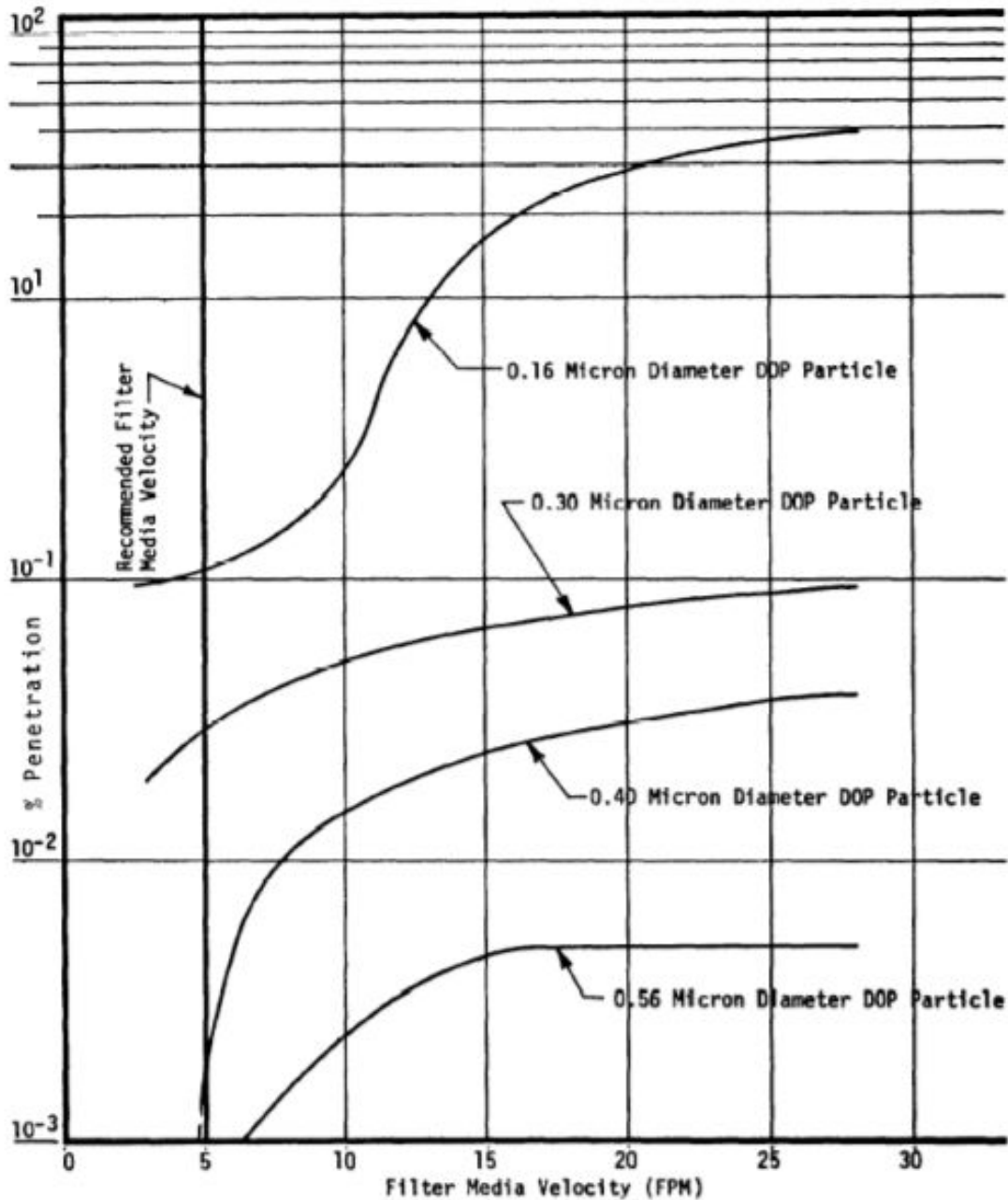

Figure 2.5.1: Percent Penetration versus Filter Media Velocity for different sized particles. A vertical line at 5 feet per minute depicts the specification cut off. From: HEPA Filter Performance Comparative Study, C.A Gunn and D.M. Eaton 14th ERDA Air Cleaning Conference, Figure 12, Page 659

Figure 2.5.1 clearly shows that the 0.3 micron line crosses the 5 feet per minute threshold at a filtration rate of 99.97% [3]. This appears to indicate that the specification is correct.

However, this data is very old and was conducted on filters that are obsolete in today's world. Figure 2.5.2 shows newer data that tells a very different story.

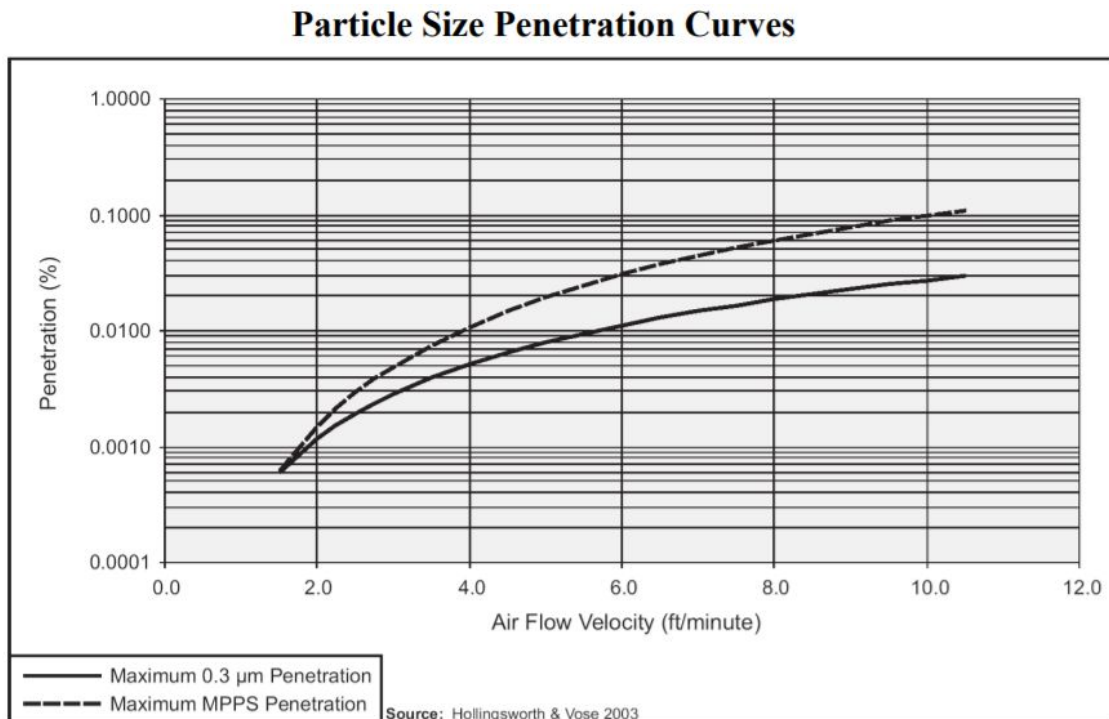

Figure 2.5.2: Hollingsworth and Vose 2003 percent penetration vs air flow velocity for 0.3 micron particles and MPPS particles [3]

This data, gathered from the new Nuclear Air Cleaning Handbook. It shows that HEPA specifications can be achieved with velocities of up to 10.5 feet per minute (~ 0.053 m/s). These velocities are made possible by the “approximately 30 years of filter media research and development” in between the two data sets [3]. These findings indicate that it is possible to use velocities higher than those recommended by ASME AG-1 while staying within HEPA specifications. This will allow SurgiBox to maintain their air quality standards while using less filter paper to create a more compact device.

3: Methods

To understand the velocity and pressure distribution across the environmental box set-up, models were created in Solidworks Flow Simulation. These models are rectangular prisms with a circular entrance hole in the front and filter media on the left and right faces. The remaining sides are categorized as “real walls” in the SolidWorks System. The outside faces of the filter media are set to atmospheric pressure (101325 Pa) and the exit volumetric flow rate is set to 0.01 cubic meters per second.

The filter media is divided into seven one inch sections. These sections are varied between filter specifications to create different simulations. In most versions of the model, the first section is blocked off. The reasons for this are discussed in *Section 4: SolidWorks Visual Optimization*. The filter selections used for this simulation are the 1” nominal MERV 13 Media and the 2” nominal MERV 13 Media. These media fall within SugiBox’s filtration guidelines and behave like HEPA media. To create filters in between these two specifications, their thicknesses and pressure-velocity curves were combined into a spectrum of filters. This allowed for more even velocity profiles to be created and a variety of realistic pressure drop profiles to be analysed.

The velocity and pressure profiles of the models were analysed. The velocity profiles were taken at the outer surface of the filter media unless otherwise noted. Their scales and discretisations are shown in keys alongside the figures. Trends and notable aspects of the models are discussed both quantitatively and qualitatively. These models are also compared to “ideal” model pressure and velocity curves. This “ideal” model, created in matlab, describes the centerline curves of a maximally efficient system. Recommendations on how to compare experimental results to those ideal curves are presented.

4: SolidWorks Visual Optimization

4.1: Model Setup

To better understand the current airflow distribution through the environmental box and how it can be improved, a SolidWorks model was created. The initial model, shown in Figure 4.1.1, is based off of the current environmental box.

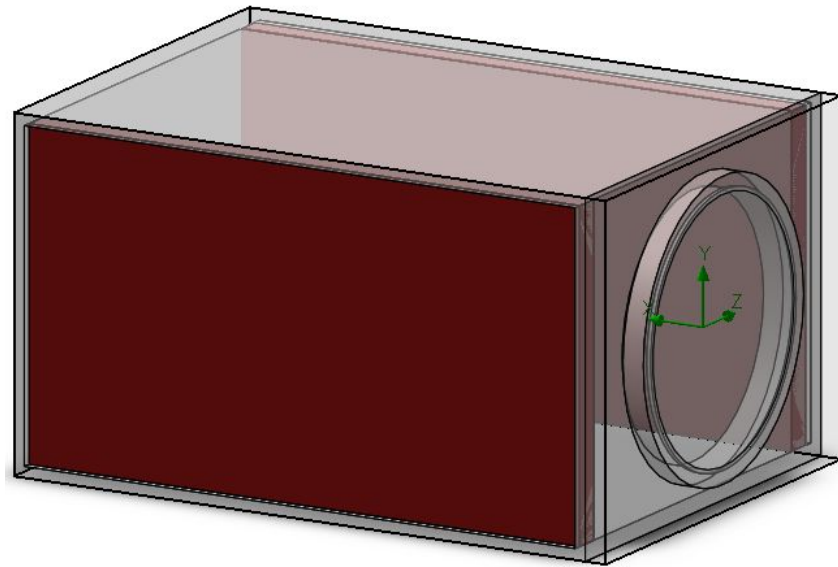

Figure 4.1.1: Model of the current SurgiBox environmental system. The filter, shown in red, is 7 inches long and extends down the length of 2 sides. Air exits the system through the circular hole in the front. The remaining 3 sides are plastic walls.

In this model, 0.01 cubic meters of air flows out of the front tube each second and the pressure outside the box is set to atmospheric. In a medical setting, the only aspect of the system medical workers can control is the fan speed. At the low internal pressures that SurgiBox operates at, fan speed is directly proportional to volumetric flow rate. Because SurgiBox's goal is set in the terms of a volumetric flow rate, this metric was used as the basis of the model.

Because the coefficients for the pressure curve would have to be experimentally calculated for each situation, pre-established curves for similar filters from the SolidWorks database were used. Instead of using a change in pleat density to increase surface area, the filters used in this model change pleat height. This has the same effect on pressure curves

because both changing plate density and pleat height increase the surface area per unit distance of the filter.

The data from this model will shed light on how varying filter area per unit length can optimize airflow distribution. In future sections, these insights will be used to find a pleat density function that will help SurgiBox reduce their required filter media.

4.2: Uniform Filter Density

Before attempting to optimize filter area per unit length, the uniform case must be understood. Figure 4.2.1 shows the velocity distributions of the model with a uniform one inch thick filter, the shortest filter in this model.

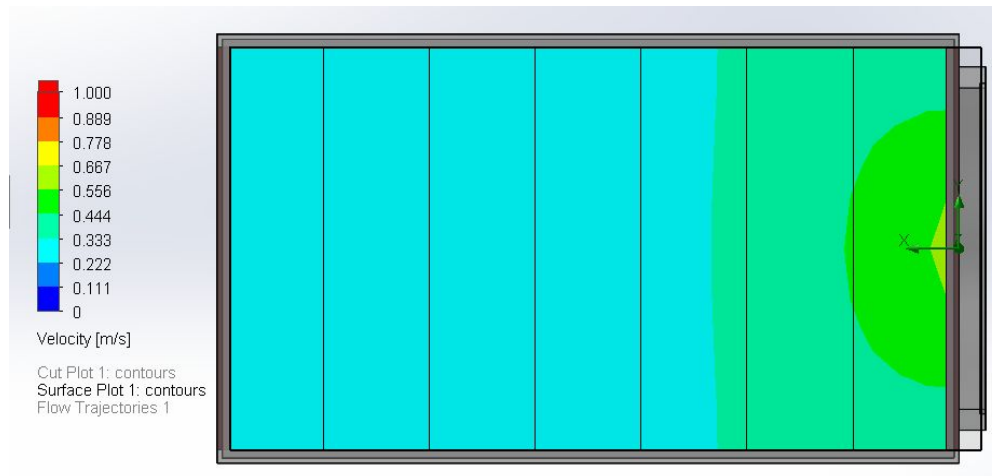

Figure 4.2.1: Velocity profile of uniform 1 inch thick filter. The color profile is from 0 - 1 m/s with 10 divisions comprising 9 bins of color as shown on the left hand side of the figure.

This profile may seem relatively uniform. However, the range seen on the profile, 0.445 m/s (to 0.667 m/s - 0.222 m/s), dwarfs the maximum velocity of 0.053 m/s. This means that even if these values could be shifted down to reasonable velocities, their range could not allow for a system that filters air to specification.

But how could these values be shifted down? It is easy to imagine that if a defined amount moves through a certain filter area at a certain velocity, doubling that area would reduce its velocity by a factor of two. However, because of the geometry of the model, this could not be further from the truth. Figure 4.2.2 shows the velocity profile of a two inch thick filter with all other properties held constant.

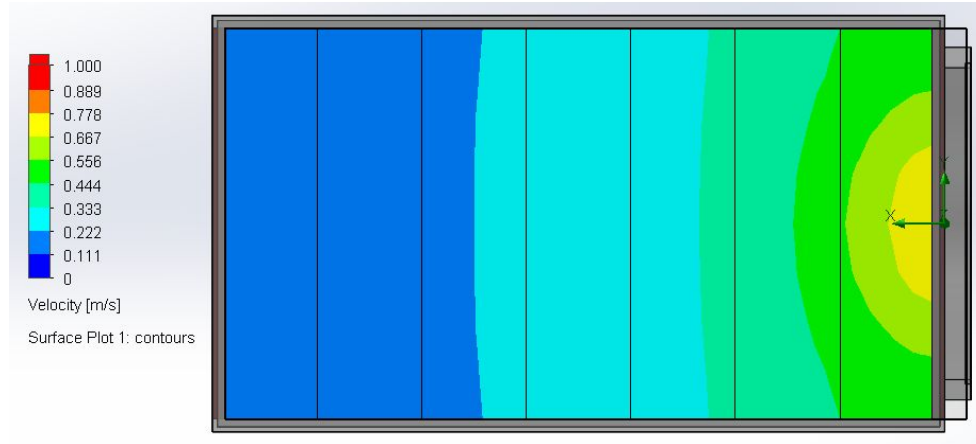

Figure 4.2.2: Velocity profile of uniform 2 inch thick filter. The color profile is from 0 - 1 m/s with 10 divisions comprising 9 bins of color as shown on the left hand side of the figure.

The velocity profile for the two inch thick filter shows considerably more variation than the one inch thick filter. This is because the increase in area means there is less resistance to air flow. Because the pull from the fan is stronger closer to the fan, more air comes through at that point. This means that the filter paper closest to the fan is being overwhelmed while the filter further away from the fan is being underutilized.

Comparing the one inch and two inch filters reveals that the difference in resistance between the two filters is significant and combining them may lead to more uniform velocity profiles.

4.3: Combining One and Two Inch Thick Filters

As described in Section 4.2: *Uniform Filter Density*, the one inch thick filter has a higher resistance to air flow than the two inch thick filter. Therefore, to achieve a more uniform velocity distribution, the four panels closest to the fan were set to one inch thick and the three panels farther from the fan were set to two inches thick. Figure 4.3.1 shows the resulting velocity profile.

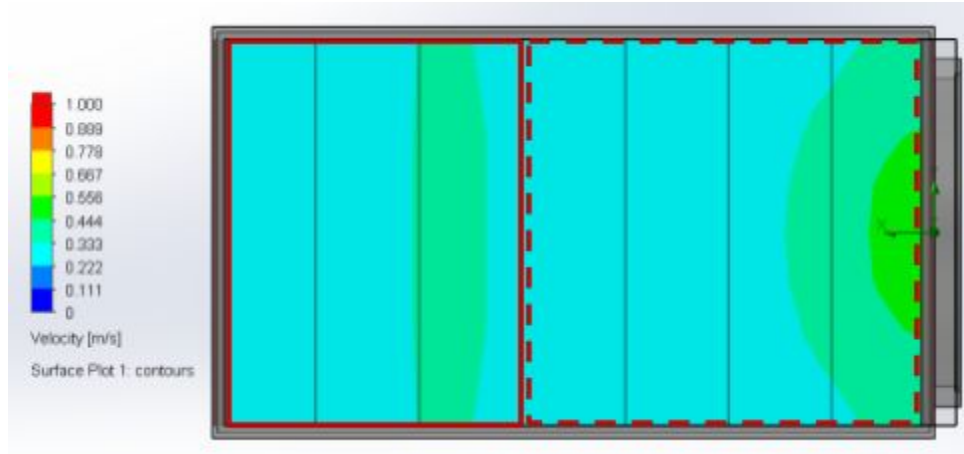

Figure 4.3.1: Velocity profile of split one inch thick (enclosed in dashed red box) and two inch thick (enclosed in solid red box) filter. The color profile is from 0 - 1 m/s with 10 divisions comprising 9 bins of color as shown on the left hand side of the figure.

This profile is more uniform than either of the single-type profiles. This shows that progress has been made towards creating a system that uniformly utilizes all filter media. To gain a more comprehensive understanding of this distribution, the scale was adjusted to better fit the range of data. This is shown in Figure 4.3.2.

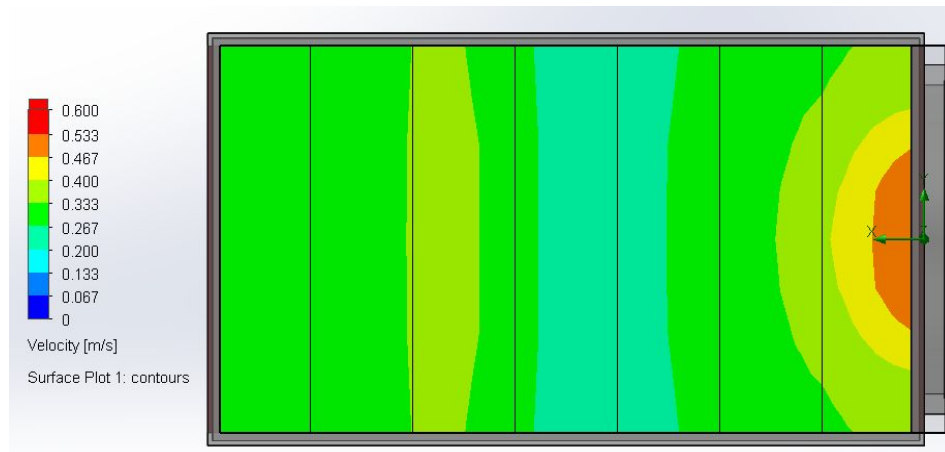

Figure 4.3.2: Velocity profile of split one and two inch thick filter. The color profile is from 0 - 0.6 m/s with 10 divisions comprising 9 bins of color as shown on the left hand side of the figure.

Figure 4.3.2 reveals that much of the distribution is caused by edge effects close to the fan. To combat these edge effects, an adjusted model was created with the first section of filter paper blocked off. Figure 4.3.3 shows the updated model.

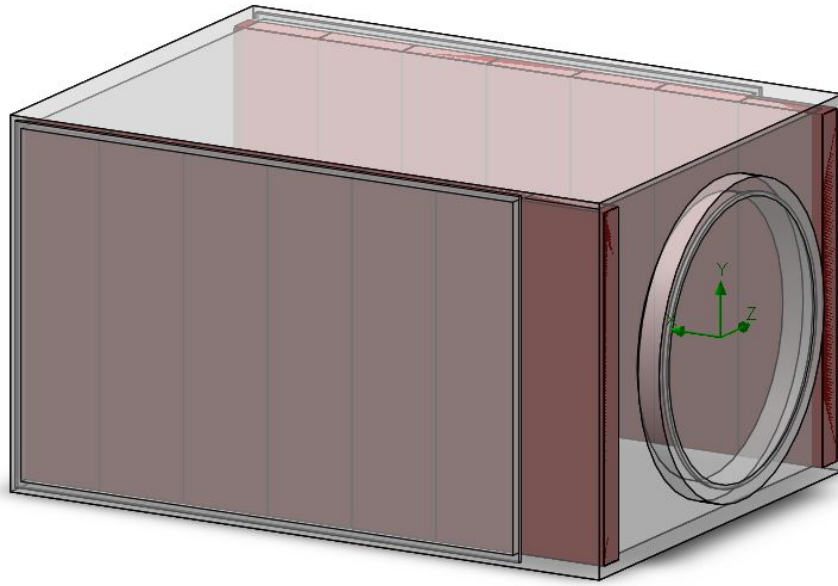

Figure 4.3.3: Revised model the air filtration system. All parameters kept the same except the first section of filter is blocked off.

All previous simulations were run on this revised model. The results of the uniform filter area distributions can be found in Appendix A. Figure 4.3.4 shows the velocity profile of the simulation where the first three panels are one inch thick and the second three panels are two inches thick. Figure 4.3.5 shows the same simulation with a narrower scale.

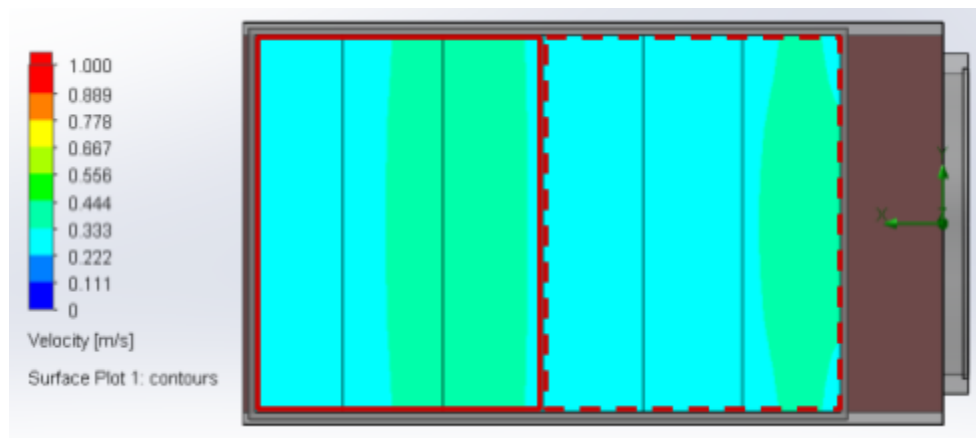

Figure 4.3.4: Revised model velocity profile of split one inch thick (enclosed in dashed red box) and two inch thick (enclosed in solid red box) filter. The color profile is from 0 - 1 m/s with 10 divisions comprising 9 bins of color as shown on the left hand side of the figure.

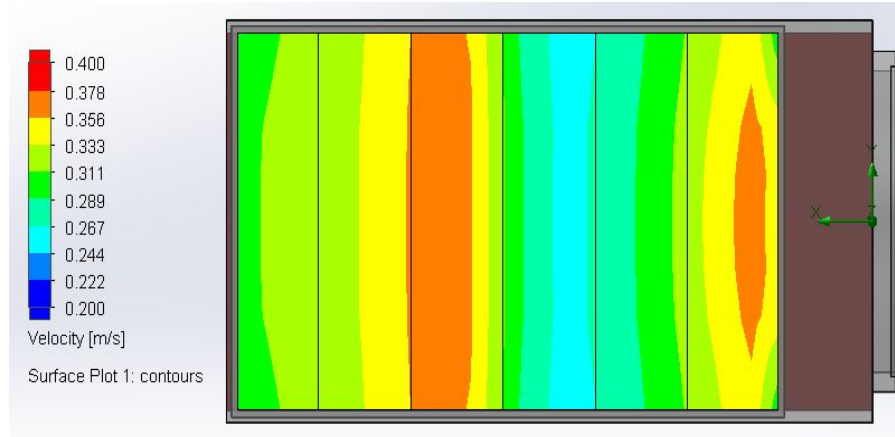

Figure 4.3.5: Revised model velocity profile of split one and two inch thick filter. Top: The color profile is from 0 - 1 m/s with 10 divisions comprising 9 bins of color as shown on the left hand side of the figure.

Although some edge effects can still be seen, they are greatly reduced by blocking off the first section. The significance of this change indicates that the final design of the environmental box should distance the fan from the beginning of the filter paper or otherwise reduce edge effects. This figure also shows that the velocity range has greatly decreased. This indicates that continuing to redistribute filter area will result in a uniform velocity profile.

Figure 4.3.6 shows a comparison of the velocity profiles presented thus far.

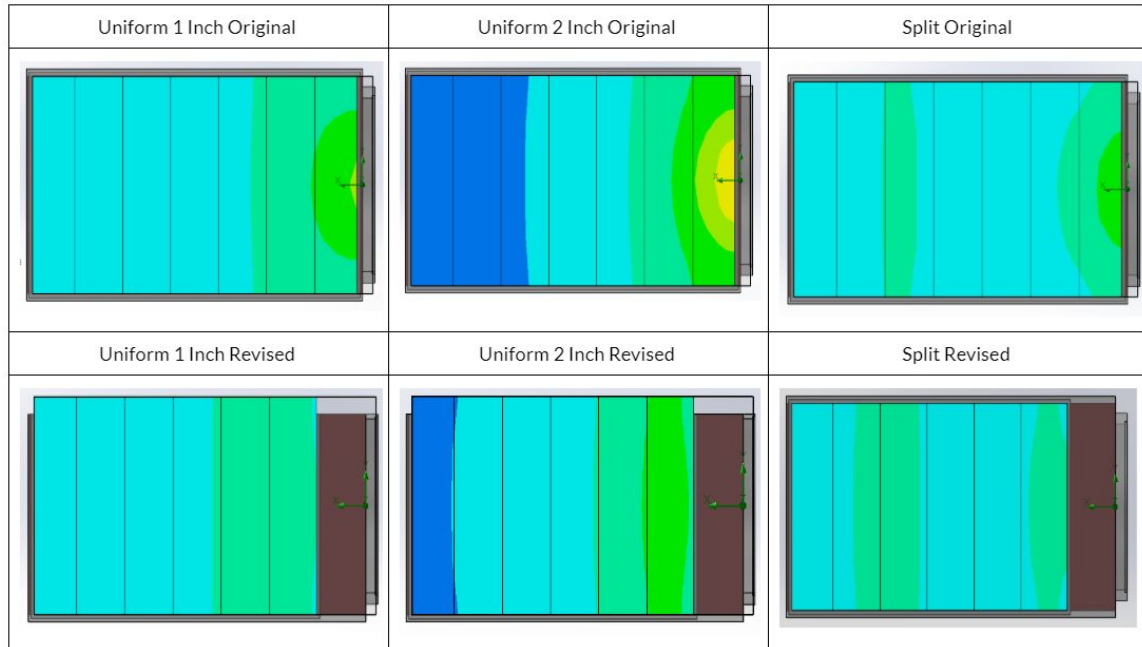

Figure 4.3.6: Summarizing table of velocity distributions of uniform one inch and two inch original and revised models as well as the original and revised split models.

The scales in each of these simula are the same and equivalent to that in Figure 4.2.1. This comparison shows that even though there is a decrease in total filter area (requiring an higher average velocity), the maximum velocity decreased from the original to the revised model in each of the three cases. Because of these results, the revised model will be used in all future simulations.

4.4: Optimizing with More Partitions

Thus far, only filters from the SolidWorks database were used in simulations. However, to create a uniform velocity distribution, more filters are needed. In the SolidWorks Flow Simulation System, filters are characterized by their pressure vs velocity tables and their thickness. By taking the average of these values, a “middle” thickness filter was created. Figure 4.4.1 shows the pressure curves of the one inch thick, two inch thick, and “middle” filters.

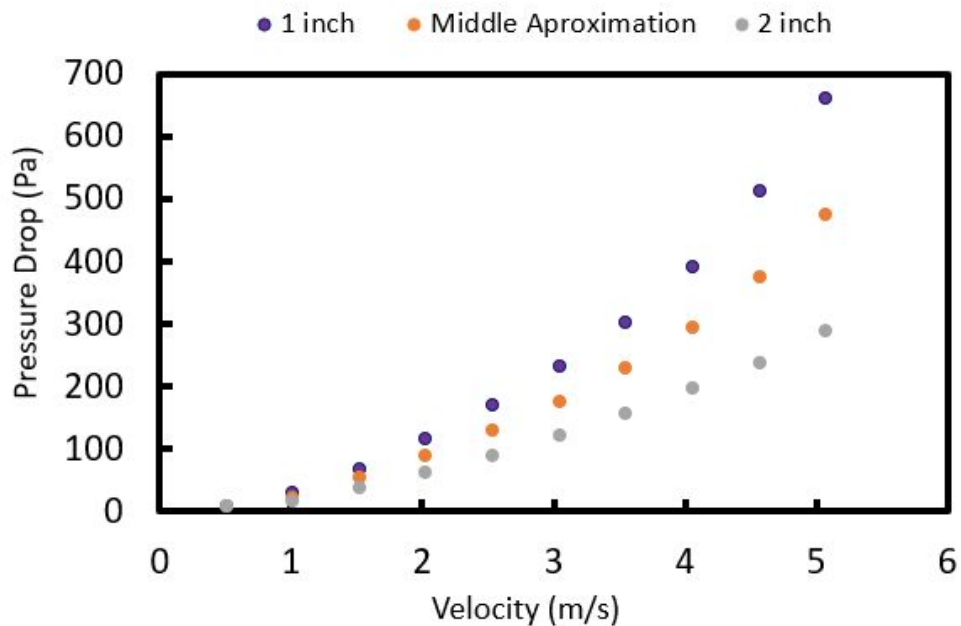

Figure 4.4.1: Pressure vs Velocity graph for one inch, two inch, and middle curves

This graph gives visual insight into the filter resistances seen in the velocity profiles. The one inch filter has a greater pressure drop than the two inch filter and therefore creates more resistance to air flow. The middle approximation falls directly between the two. It is important to note that it is not possible to conclude that this middle filter represents a 1.5 inch filter, but this data does represent a filter with resistance that is halfway between the one inch and two inch filters.

The middle data and thickness were entered into the SolidWorks database as a new filter and a simulation was created where the two panels closest to the fan were set to the one inch thick filter, the next two were set to the middle filter, and the final two were set to the two inch thick filter. The velocity profile for this simulation at three different resolutions and scales is shown in Figure 4.4.2.

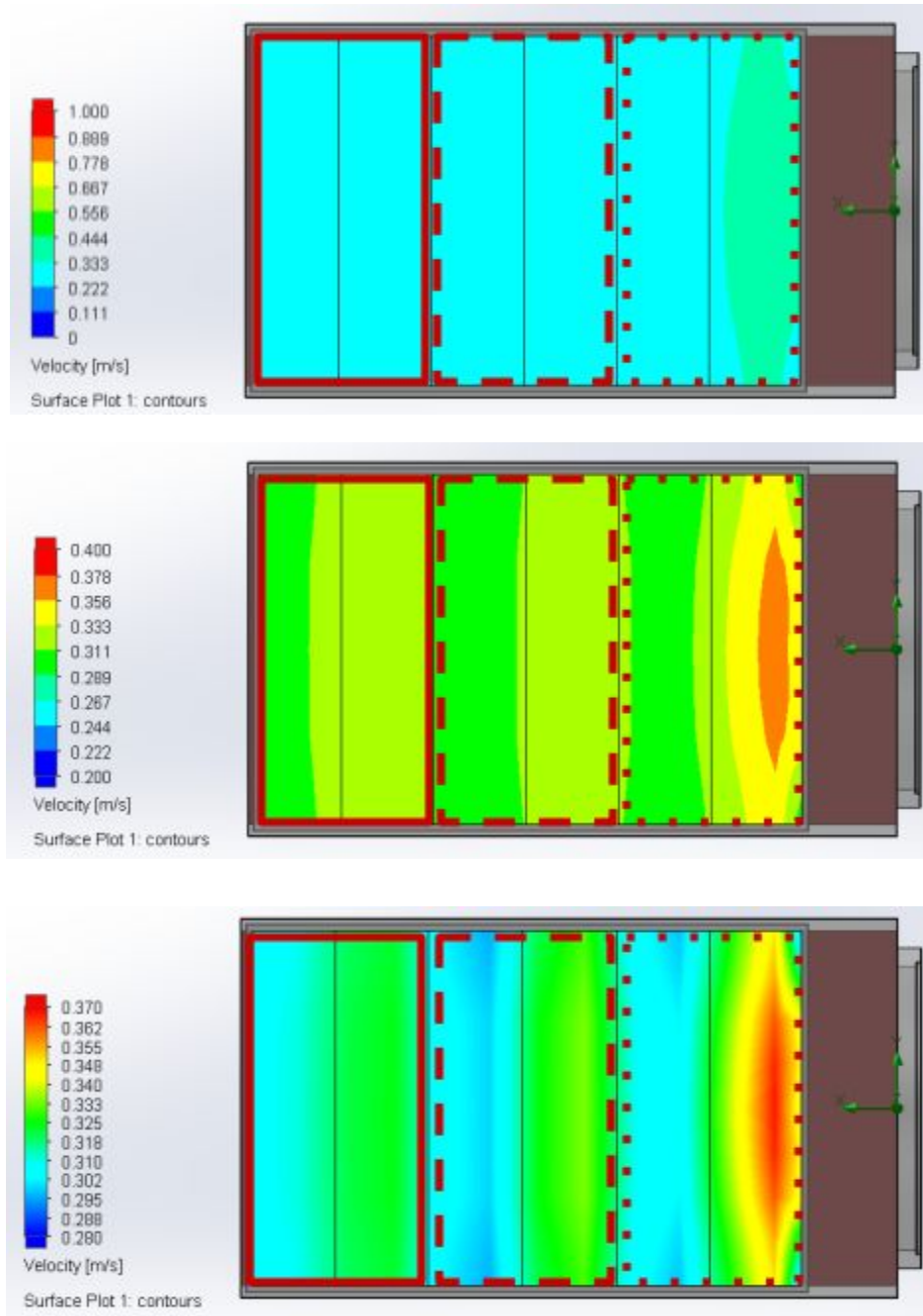

Figure 4.4.2: Revised model velocity profile of the three sections: one inch thick filter on the right (solid red box), middle filter in the middle (dashed red box), and two inch thick filter on the left (dotted red box). Top: The color profile is from 0 - 1 m/s with 10 divisions comprising 9 bins of color as shown on the left hand side of the figure. Middle: The color profile is from 0.2 - 0.4 m/s with 10 divisions comprising 9 bins of color as shown on the left hand side of the figure. Bottom: The color profile is from 0.280 - 0.370 m/s with a continuous scale as shown on the left hand side of the figure.

This figure shows a very even distribution with slight edge effects. As the range is narrowed closer to the profile values and the resolution is increased, it becomes clear that there are distinct strips of high and low velocity at the change of filter media thickness.

To further smooth the velocity profile, more filter variations were added. Between the one inch and two inch filters, nine more pressure curves and thickness were created. These filter values, shown in Appendix B, were manually fitted to a six section model to make the velocity profile with the smallest possible range. This profile is shown with two different resolutions in Figure 4.4.3.

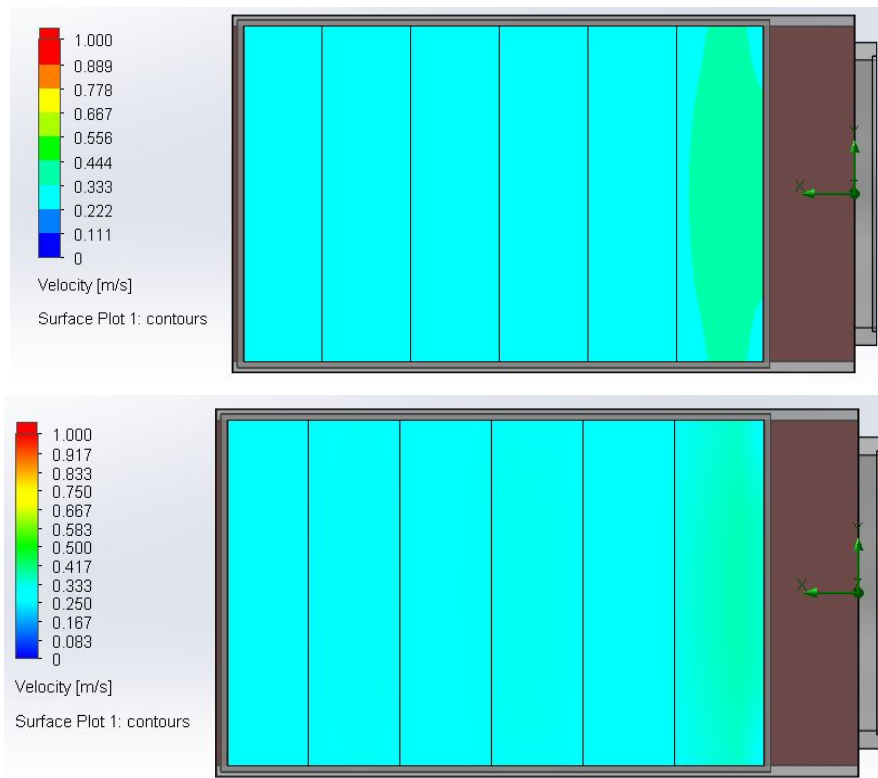

Figure 4.4.3: Velocity profile of model with six different filter selections. The color profile is from 0 - 0.1 m/s with 10 divisions comprising 9 bins of color as shown on the left hand side of the figure.

The filter distribution from right to left is as follows: 1 inch, 9:1, 6:4, 4:6, 1:9, 2. At this scale, the velocity seems uniform. To understand what small-scale variations are occurring, the velocity range was narrowed to be the minimum to maximum velocities. Figure 4.4.4 shows the profile with this adjusted scale.

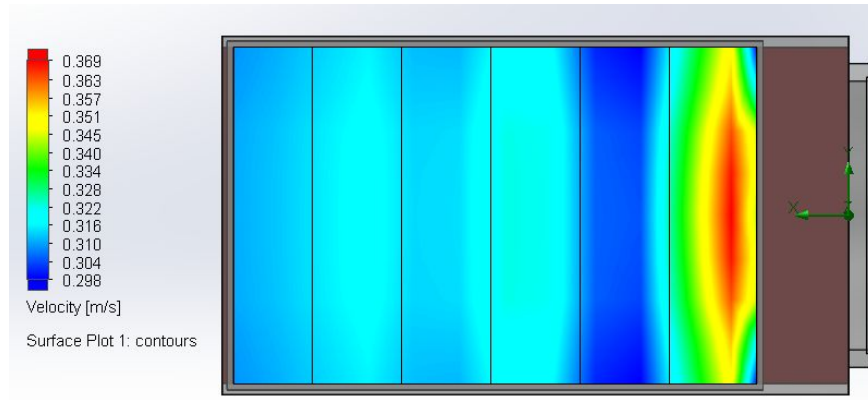

Figure 4.4.4: Velocity profile of model with six different filter selections. The color profile is from 0.298 - 0.369 m/s with a continuous scale as shown on the left hand side of the figure.

It is clear that edge effects are now the dominant cause of variance in this model. Other than these effects, the flow is nearly uniform; the total velocity range of this simulation is 0.071 m/s. This is a full order of magnitude below the 0.445m/s range seen in the uniform case.

Figure 4.4.5 provides a comparative view of the split filter simulations at different scales.

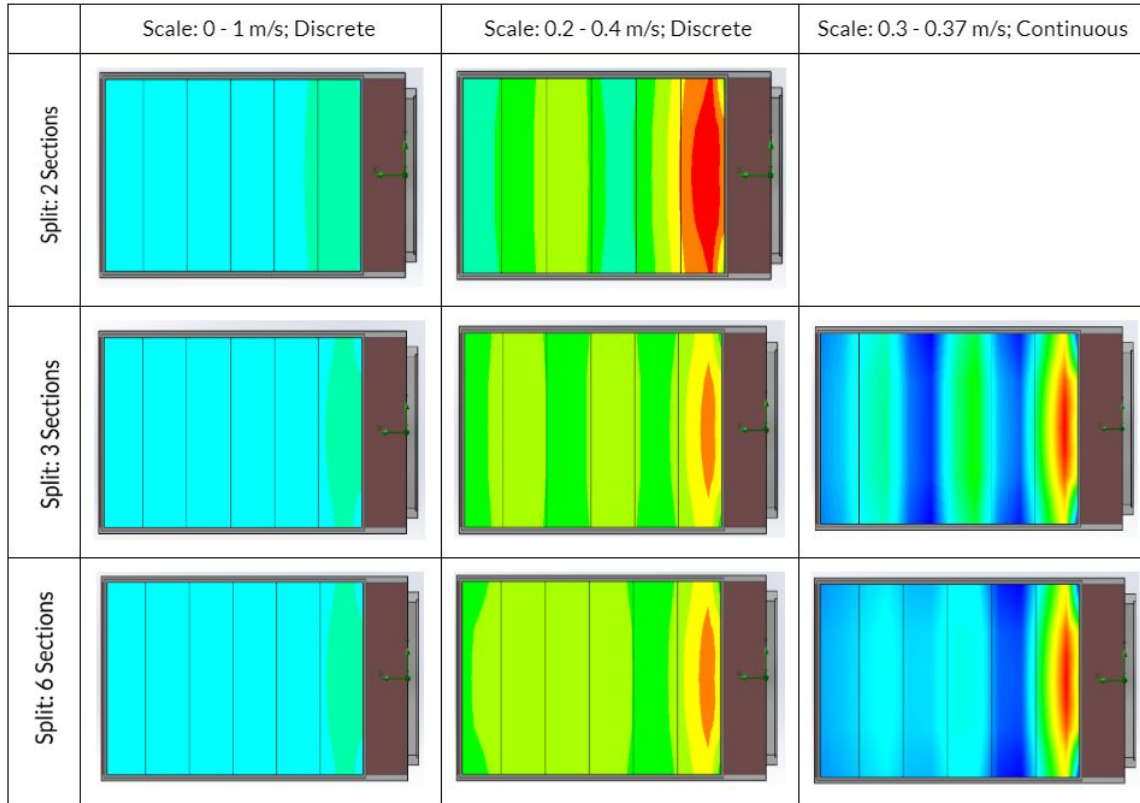

Figure 4.4.5: Summarizing table of velocity distributions of the varied filter sections with different scales.

There is a clear improvement between the two section and three section profiles. From the three section to the six section profiles, the edge effects are functionally the same, but the rest of the system is far more uniform. This indicates that to achieve a smaller velocity range after this point, the edge effects must be addressed before pleating is optimized. This could be achieved in many ways including inserting a filter with a resistance greater than that of the one inch thick filter, padding the area with a material that causes greater resistance, changing the geometry of the system, or increasing the distance between the fan and the beginning of the filter media.

If edge effects are reduced and the filter discretizations increase into a continuous function, a uniform flow is possible for the SurgiBox system.

4.6: What Resistances Produce Uniform Flow?

Uniform flow is created when filter resistances are utilized to counter the geometric effects of the air filtration system. So far, this has been shown using discrete sections. Figure 4.6.1 plots the resistances on a scale according to their “representative filter

thickness.” This metric converts the filter ratio into an axis. For example, on this axis, a 1:9 filter would become a 1.9 inch representative thickness filter and a 6:4 filter would become a 1.4 inch representative thickness filter. It is important to note that this does not mean a 1.5 inch thick filter would have the same pressure curve as a 1.5 inch representative filter. To understand the relationship between representative filters and real life filters, more than two real life data points must be analysed.

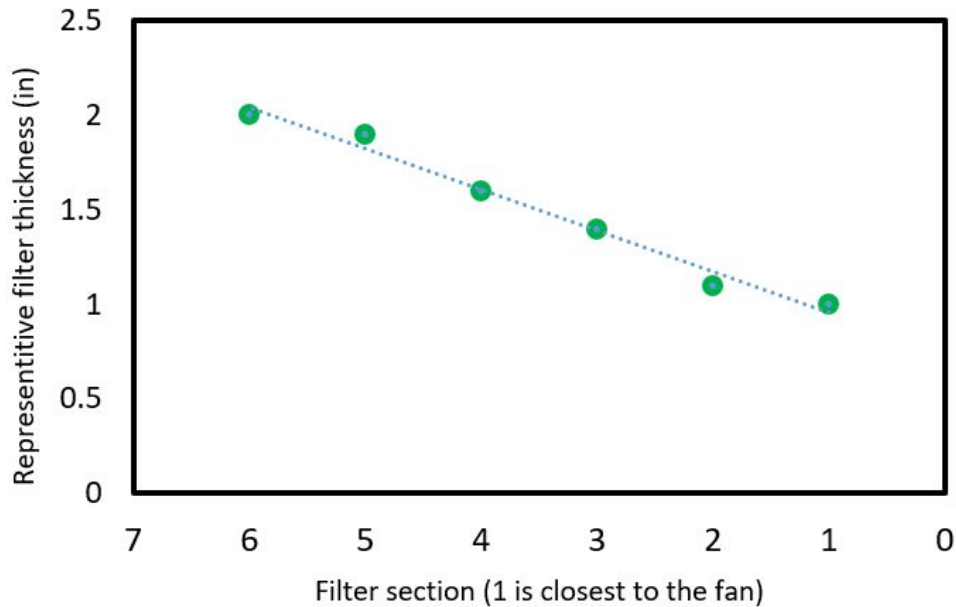

Figure 4.6.1: representative filter thickness vs filter section for the six section split with trendline

This graph shows a linear trend from the one inch thick filter to the two inch thick filter. This indicates that to achieve uniform flow (neglecting edge effects) the filter resistance should decrease linearly as the distance from the fan increases, excluding edge effects.

When analysed within the SurgiBox context, this data may also raise some concerns. To create uniform flow in this case, resistances ranging from those created by a one inch thick filter to those created by a two inch thick filter. This means that section 6 contains about twice as much filter paper as section 1 in the same length. If this were converted to pleat density, section 6 would have a pleat density about twice that of section 1. If, as discussed in section 2.2: *Pleated Filter Media*, it is necessary to stay below 32 pleats per 100 mm, this may lead to incredibly sparse pleating causing long expanded lengths. It is recommended

that the SurgiBox team weighs the pros and cons of this as they move forward with this design.

It is important to note that there are other ways besides area distribution to achieve this pressure drop trend. For instance, another layer of resistant material may be added as a filter cover. The data from Figure 4.6.1 could be used to identify and refine this covering. It is recommended that SurgiBox weigh both options as they move forward in their design.

5: Understanding the Effects of an Optimized System

5.1: Pressure Distribution Inside the SurgiBox System

Creating a uniform flow across the filter impacts the pressure distribution inside of the filter. To better understand how the pressure profile changes, pressure profiles from the cross sectional areas of the revised one inch thick simulation and the six sections model at various distances away from the fan are displayed in Figure 5.1.1. Figure 5.1.2 shows the location on the model these cross sectional areas are taken from.

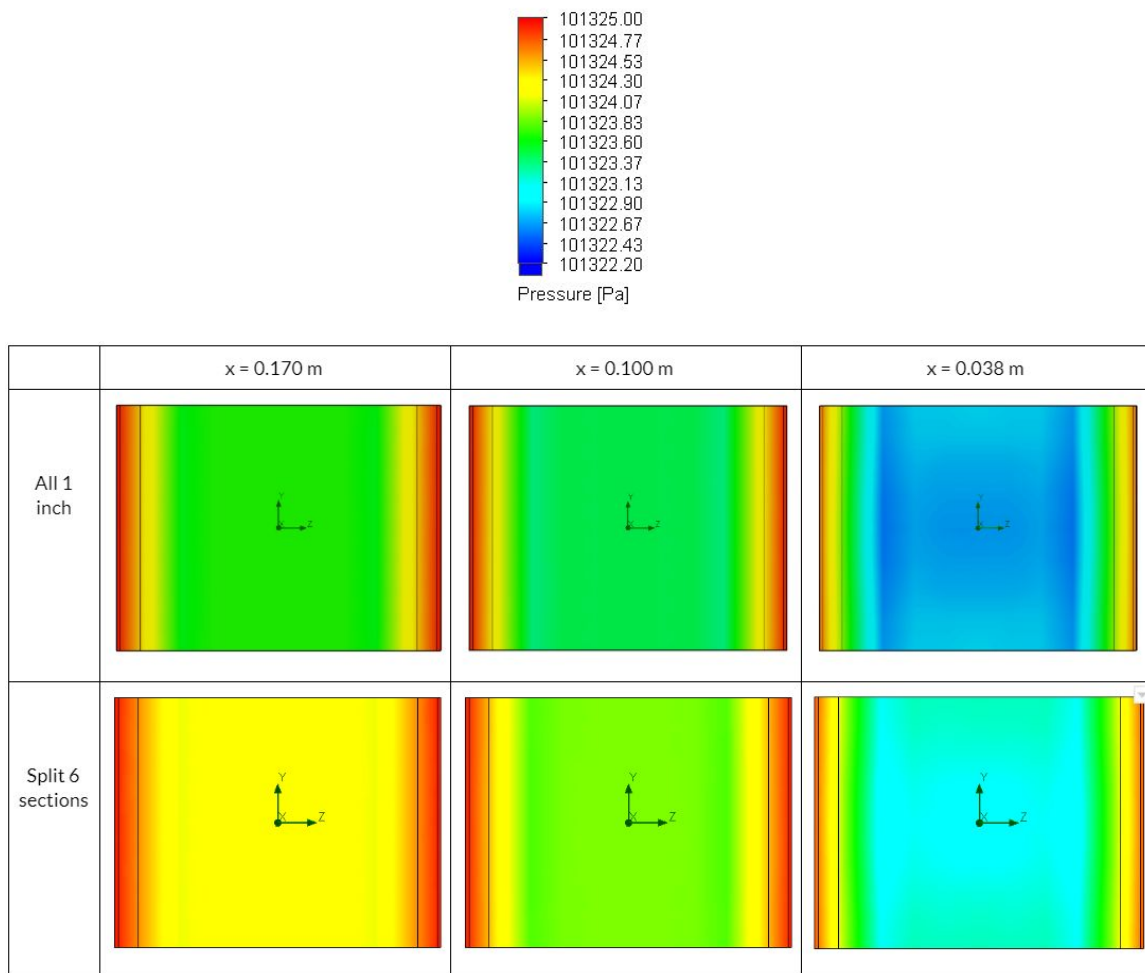

Figure 5.1.1: Pressure distribution of cross sectional areas of the one inch revised model and the six sections model different distances away from the fan. The scales are the same for each and are continuous between 101322.2 Pa and 101325.00 Pa (atmospheric) as shown in the scale above the table

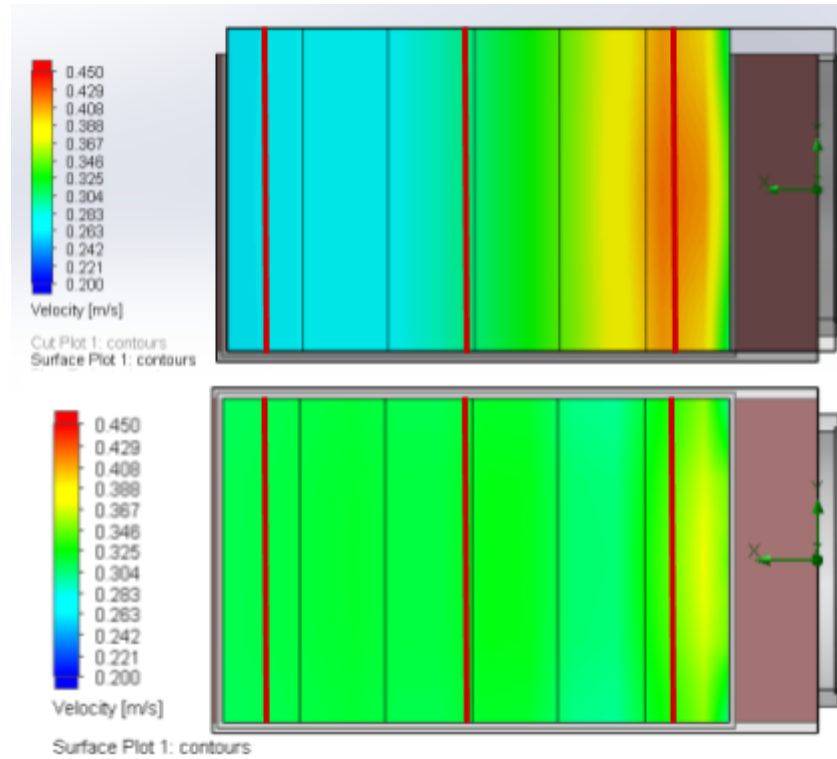

Figure 5.1.2: Velocity profile of the uniform 1 inch thick filter (top) and the six filter sections (bottom). The scales are the same and range continuously from 0.2 m/s to 0.45 m/s. Red lines indicate where the pressure measurements in Figure 5.1.1 were taken.

Before analysing this data, it is important to draw attention to the scale: the total range for this scale spans less than 3 Pascals. This very small pressure difference demonstrates the sensitivity of the system.

It can be seen from the table that the six sections simulation has slightly less of a pressure drop across the cross sectional area. In all three of the one inch thick filter cases, there is a pressure drop across the filter followed by another pressure drop that transitions into the pressure at the center line of the air filtration box. This is not seen in the $x = 0.17$ profile of the six sections filter simulation. This indicates that this system is running, on average, closer to atmospheric pressure than the uniformly one inch thick system. Because steep pressure gradients lead to inefficiencies, this shows that having a more uniform velocity profile across the filter means that the system will be more efficient.

These pressure profiles also show that a constant pressure drop across the filter from atmospheric pressure (caused by uniform velocity distribution) and a pressure gradient within the system are not mutually exclusive. Because pressure gradient causes air flow, it

is necessary to have a pressure gradient along the center axis of the system. Figure 5.1.3 shows the centerline pressure gradient of the six sections simulation.

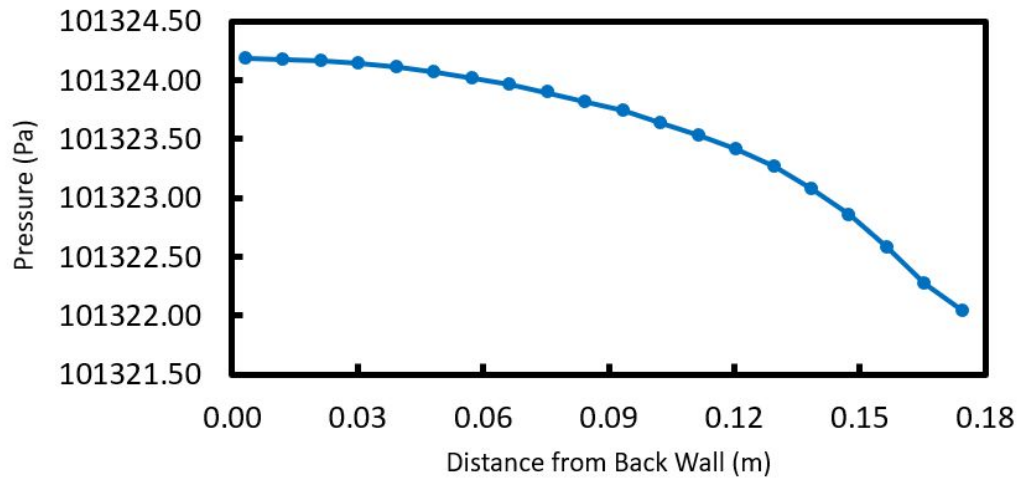

Figure 5.1.3: Pressure vs distance from the fan (right) to the back of the filter (left) down the centerline of the six section simulation

Figure 5.1.3 shows that there is initially a steep pressure gradient, but it becomes more gradual towards the back of the system. This is expected from a system with a constant inlet volumetric flow rate per unit length. Although it is difficult to see, the pressure curve is not quite optimal because of edge effects. This can be seen more clearly in the velocity curve shown in Figure 5.1.4.

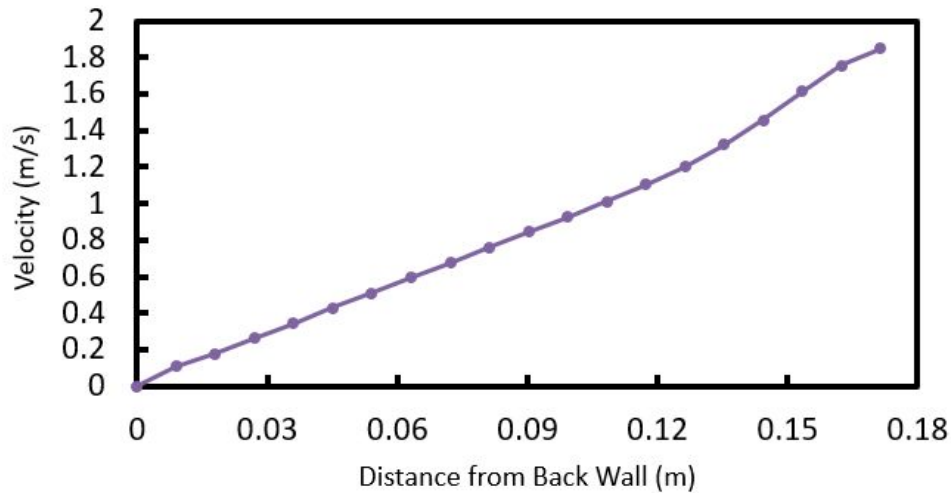

Figure 5.1.4: Velocity vs distance from the fan (right) to the back of the filter (left) down the centerline of the six section simulation

In an ideal case, the velocity curve would be completely linear. However, because of the high flow rates near the fan caused by edge effects, this linearity is broken. Because the change in pressure is directly proportional to the square of the velocity, the effect carries over into the pressure curve. These graphs show that creating a uniform velocity profile across the filter not only leads to designers being able to create a more compact system by eliminating underutilized filter material, but also helps reduce inefficiencies in the air filtration system.

5.2: What would a Perfect System Look Like?

To achieve the most efficient system possible, equal amounts of air must be entering from each discretized section. This would create a linear velocity profile that is zero at the back of the system and the minimum velocity required to meet SurgiBox's flow rate specification of 0.01 cubic meters per second at the fan. The velocity at the fan is calculated by Equation 5.

$$v_{fan} = \frac{4V}{\pi d_{exit}^2} \quad (5)$$

Where v_{fan} is the velocity at the exit of the system, V is the volumetric flow rate out of the system, and d_{exit} is the diameter of the exit hole.

If a system is defined as the space inside the environmental box, Bernoulli's Equation can be used to calculate an ideal pressure curve. This is because there is steady flow, air is incompressible, there is inviscid flow, and there is no work or heat transfer. Equation 6 can be used to describe each discretized section.

$$P_{i+1} = P_i + \frac{\rho v_{fan}^2}{2l^2} (x_i^2 - x_{i+1}^2) \quad (6)$$

Where P_{i+1} is the pressure in the current section, P_i is the pressure in the previous section, ρ is the density of air, l is the length of the filter, x_{i+1} is the current x - position on the filter, and x_i is the previous x - position.

The first section, the section closest to the back of the system, can be found by subtracting the pressure drop across the filter at that point from the atmospheric pressure. Figure 5.2.1 provides a visual of the velocity and pressure curves. The code used to create these graphs is shown in Appendix D.

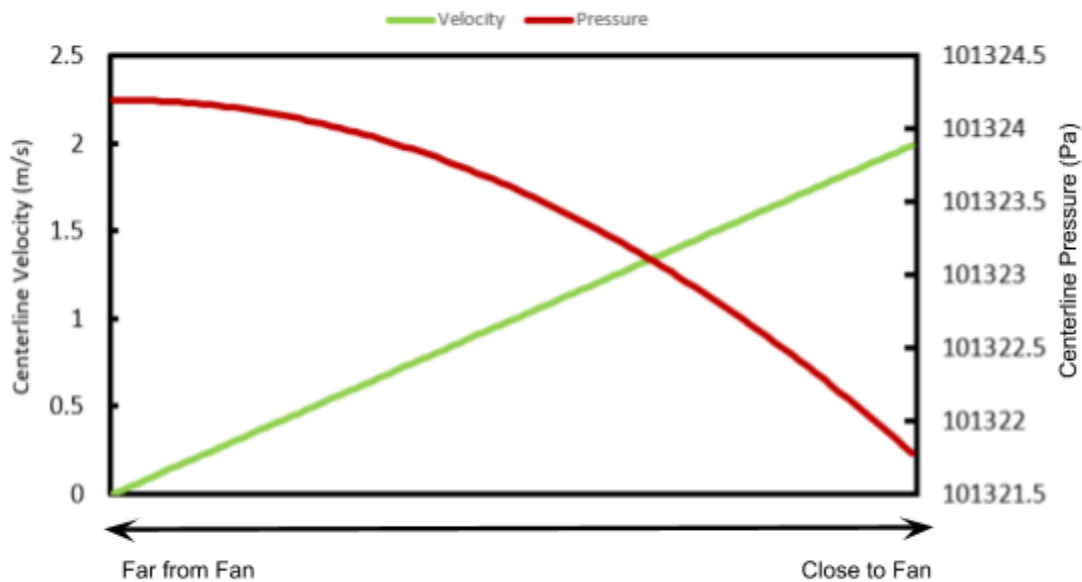

Figure 5.2.1: The ideal velocity (green) and pressure (red) curves for the SurgiBox system. The left axis gives velocity in m/s and the right axis gives pressure in pascals. Note: the scale on this axis covers a small range and should be regarded accordingly. 101325 Pa is atmospheric pressure.

This data can be used as a comparison set: data collected from the SurgiBox system can be compared to these values to understand how the current system compares to an optimal one.

If SurgiBox can achieve this distribution, they would be fully utilizing all of the filter media in the system. This would mean that, at the maximum safe media velocity of 0.053 m/s described in the background section, a total filter area of 0.189 square meters of filter paper would be necessary for the system. At a realistic pleat height of one inch and a filter height of four inches, there would need to be 37 pleats to satisfy these requirements. In their system, it is likely that SurgiBox will require more filter media area to account for safety factors and variations in flow. However, this value provides an aspiration that designers can work towards as the product is refined.

5.3: Model Comparisons to Ideal Pressure Curve

To understand how close the uniform one inch filter and the best manual fit filter models are to the ideal pressure curve, Figure 5.3.1 was created. The datatables for this as well as Figure 5.4.1 are shown in Appendix C.

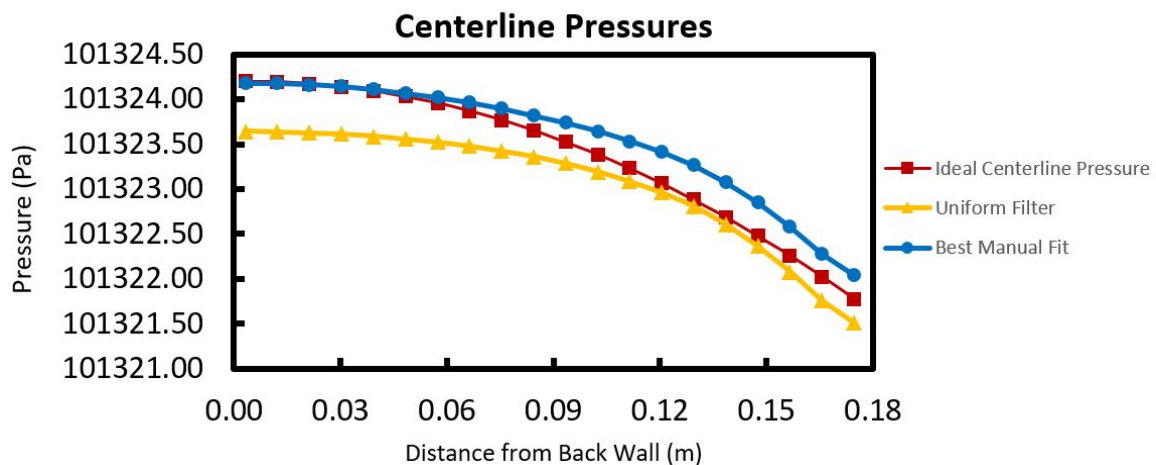

Figure 5.3.1: Centerline pressures for the ideal centerline pressure (red square), the uniform one inch thick filter (yellow triangle), and the best manual fit (blue circle). 20 Data points were collected for each curve.

Far from the fan, the six section split, or best manual fit simulation, lines up with the ideal centerline pressure. Closer to the fan, the uniform one inch thick filter is closer to the ideal centerline pressure. However, they never convincingly match up. The deviation of the ideal

centerline pressure and the best manual fit pressure may be due to edge effects or variations in the model.

It is interesting that the uniform filter and the best manual fit models follow the same shaped curve while the ideal curve follows a different shape. The steeper drop off seen in the ideal centerline pressure curve may be harder to achieve because of the edge effects. Further research would have to be conducted to better understand this anomaly.

5.4: Understanding Pressure Drops from Atmospheric to Centerline

To get from atmospheric pressure to centerline pressure, there is first a pressure drop across the filter media and then another pressure drop to get to centerline pressure. This can be clearly seen in Figure 5.1.1 in *Section 5.1: Pressure Distribution Inside the SurgiBox System*. Figure 5.4.1 isolates the pressure drop across the filter for the uniform one inch thick filter and the best manual fit models.

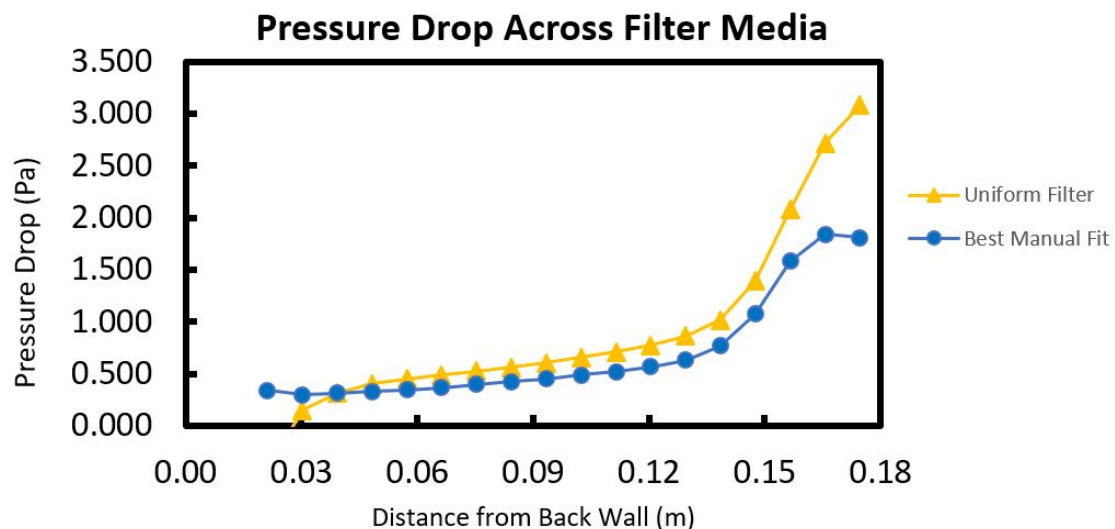

Figure 5.4.1: Pressure drop across filter media for the uniform one inch thick filter (yellow triangle) and the best manual fit (blue circle). 18 Data points were collected for each curve.

Both of these curves have an approximately flat section far away from the fan, then shoot up to higher pressure drops close to the fan because of edge effects. In the uniform filter case, there is a discernible positive slope in the curve moving towards the fan and there is a pressure drop of almost twice that of the best manual fit model close to the fan. The best manual fit model has a more even pressure drop across the filter far away from the fan and

a small jump due to edge effects. Ideally, the pressure drop across the filter would be uniform and as low as possible, maximising the efficiency of the system.

After this first pressure drop, there must be a second pressure drop from inside the filter to the centerline. Figure 5.4.2 shows this drop for both the uniform one inch thick filter model and the best manual fit model.

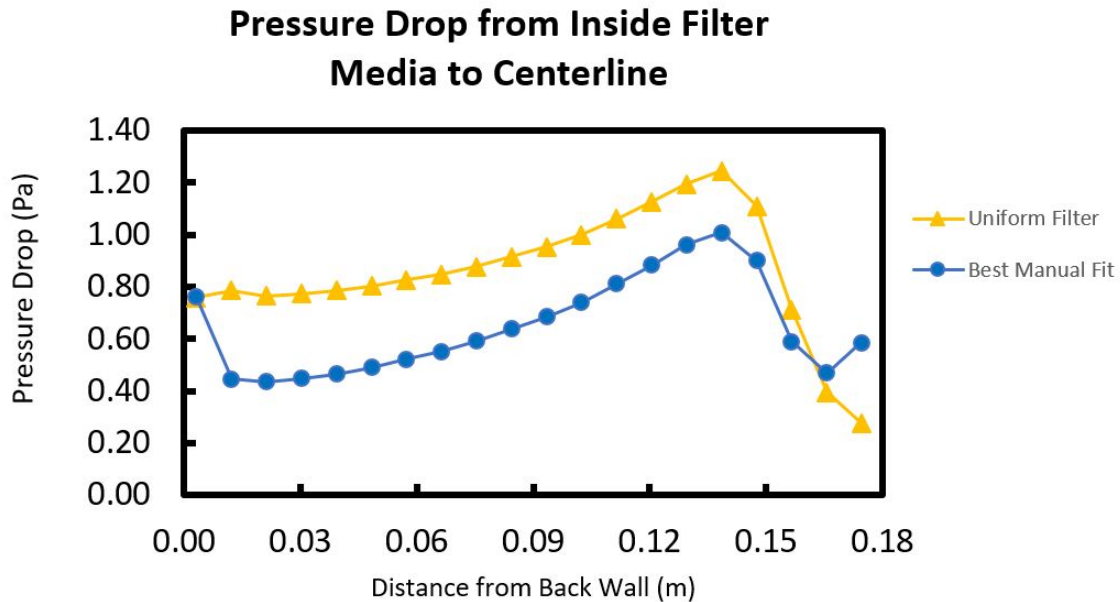

Figure 5.4.2: Pressure drop from just inside the filter media to the centerline for the uniform one inch thick filter (yellow triangle) and the best manual fit (blue circle). 20 Data points were collected for each curve.

Both the uniform filter and the best manual fit models have the same type of shape. Overall, the uniform filter sees a higher pressure drop from the inside of the filter to the centerline, but does not have as much of a spike closer to the fan. Overall, the pressure drops across the filter media are similar to the pressure drop from the inside of the filter media to the centerline. Excluding edge effects, it can be approximated that each accounts for about half of the total pressure drop. Unlike the pressure drop across the filter, the pressure drop from inside the filter to the centerline cannot be uniform; it must follow a similar curve to the total pressure drop. The varied resistance of the filter media allows this to occur.

This data gives a good understanding of what the SurgiBox team can expect to see as they begin testing the environmental box. Comparing experimental results to this data and analysing deviations that arise can help the team create the most efficient filter possible.

6: Conclusion

SurgiBox, a company that seeks to bring safe surgeries to people who do not have access to a hospital, is looking to improve their environmental box by making it more compact and portable. To do this, they must understand the airflow patterns through their system and how they can be improved by creating a uniform flow velocity that meets their specifications.

To stay within HEPA regulations, filter media must be able to trap particles through diffusion, inertial impact, and interception. To do this effectively, the particles must be moving below a certain velocity. While originally believed to be much lower, it has been shown that filter media can still meet HEPA specification as speeds as fast as 10.5 feet per minute. Creating a system where all of the air passed through the filter media at that speed would create the most efficient system possible. Uneven velocity distribution through pleated filter media can lead to problems such as underutilized filter media, inefficiencies, and even overwhelmed filter media capable of letting through dangerous particles. Therefore, an even velocity distribution that is within HEPA filter media specifications can greatly improve the performance of SurgiBox's environmental system.

To understand how this system can be achieved, SolidWorks models with different filter media distributions were created and analysed. A six-section, best manual fit model revealed that an even velocity distribution is possible. However, significant edge effects minimize the benefits of this system. These edge effects would need to be addressed as part of design revisions in order to implement even velocity distribution into the SurgiBox system. This could be achieved by increasing the distance between the fan and start of the filter, adding a high-resistance material that makes it harder for air to pass through the early portions of the filter, designing an incredibly high-resistance filter, or changing the geometry of the system.

The model also gives insight into how effective filter areas should be distributed if these edge effects are significantly reduced. It is easy to conclude that there should be more effective surface area where there are higher nature velocities. In the context of this model, it would make sense to put more pleats closer to the fan because that is where the pull is strongest. However, this reduces system efficiency by promoting uneven velocity

distribution. Counterintuitively, there must be less effective surface area close to the fan and more effective surface area far from the fan. This is due to filter resistance. A filter with less effective surface area per unit length has a higher resistance to flow and a larger pressure drop at a defined velocity than a filter with more effective surface area.

It was found that, neglecting edge effects, the pressure drops (at a defined velocity) of the filter follows a roughly linear trend across the length of the filter. In the model, the final section of filter had about twice the effective surface area as the section closest to the fan. Because it is necessary to stay below 32 pleats per 100 mm, there is potential to have a wide range of pleat densities that result in a low-density, long expanded length. If this is not compatible with SurgiBox's design, the pleat resistance data could be used to find another way to create this pressure drop trend such as creating a cover of flow resistant material to put over top of the filter. It is recommended that the SurgiBox team weighs the pros and cons of these methods as they move forward with this design.

But just how close is this model to a mathematically ideal system? An "ideal" model was created that prioritized even velocity distribution. This model shows what the centerline velocities and pressures would look like in a maximally efficient system. These curves, as well as expected pressure drops across the filter media and within the system, can be used as a tool to help designers understand how real life systems compare to ideal ones. It can also be used as a tool for identifying specific locations where there is room for improvement and describing the comparative efficiency of different designs.

The models described in this paper give insights into how effective filter media areas should be distributed in the SurgiBox environmental system. They also provide insights into the magnitude of the effects of edge effects in this system. The analysis is designed to help the SurgiBox team both qualitatively and quantitatively understand the data from their system as it compares to an ideal system. It also anticipates and provides solutions for potential issues that SurgiBox is likely to see as they implement design changes. The insights gained from this paper will help the SurgiBox team make informed design changes to improve the portability and success of their product.

7: References

- [1] I. S. Al-Attar, “The effect of pleating density and dust type on performance of absolute fibrous filters,” *Environmental Science* , 2011.
- [2] W. Bergman, M. W. First, and W. L. Anderson, “Criteria for calculating the efficiency of deep-pleated HEPA filters with aluminum separators during and after design basis accidents,” *Nuclear Air Cleaning and Treatment Conference*, Jan. 1994.
- [3] G. Garcia, “ASME AG-1 HEPA Filter Media Velocity ,” *Bechtel National Incorporated* .
- [4] N. A. Hakobyan, “Introduction to Basics of Submicron Aerosol Particles Filtration Theory via Ultrafine Fiber Media ,” *Armenian Journal of Physics*, vol. 8, no. 3, pp. 140–151, Apr. 2015.
- [5] R. D. Rivers and D. J. Murphy, “Air Filter Performance Under Variable Air Volume Conditions ,” *American Society of Heating, Refrigerating and Air-Conditioning Engineers*, vol. 106, no. 2, 2000.
- [6] F. C. Schousboe, J. Porteiro, N. Crane, and R. Guldiken, 2017.
- [7] C. B. Tebbutt, Oklahoma State University, 1995.
- [8] D. L. Teodorescu, “SurgiBox: Context,” *SurgiBox*. [Online]. Available: <https://www.surgibox.org/sbcontext>. [Accessed: Sep-2019].

8: Appendices

8.1: Appendix A

Revised model 1 inch thick filter media: discrete and continuous color scale

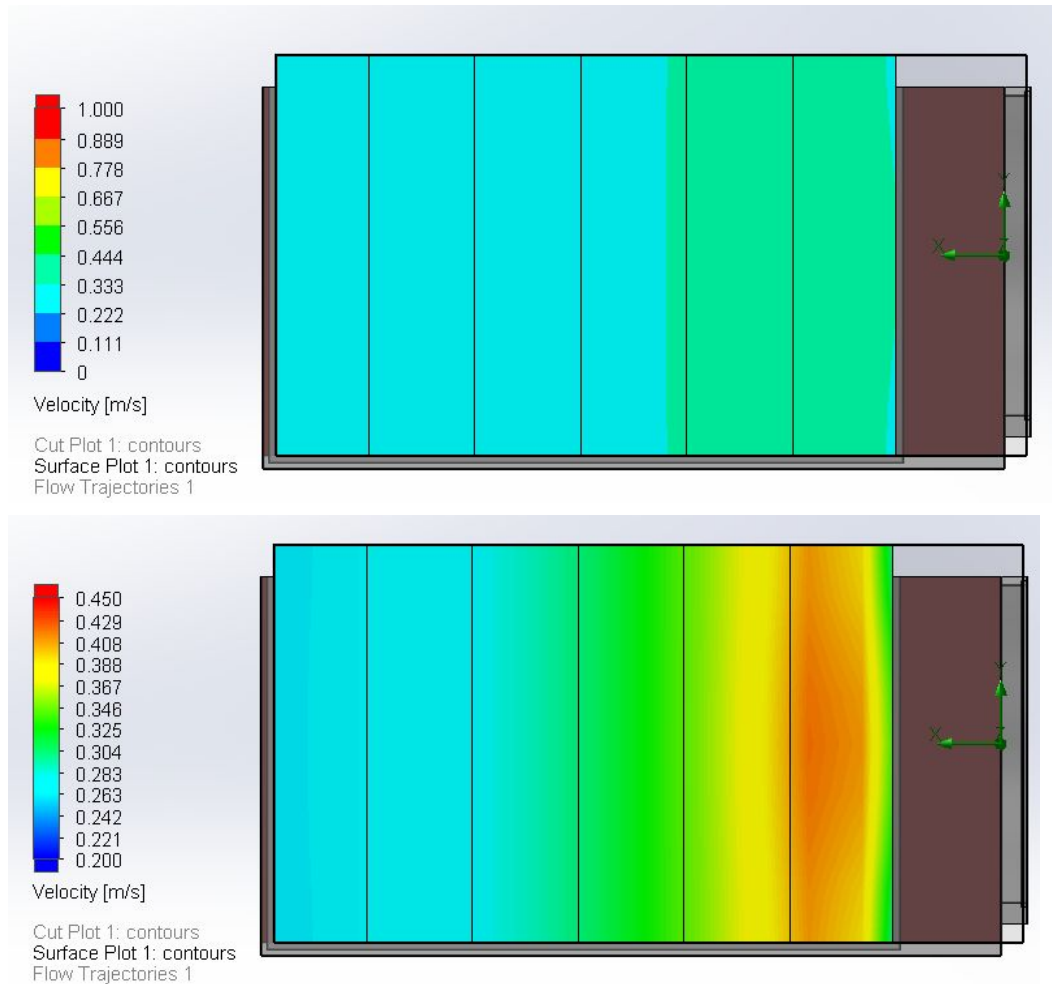

Revised model 2 inch thick filter media: discrete and continuous color scale

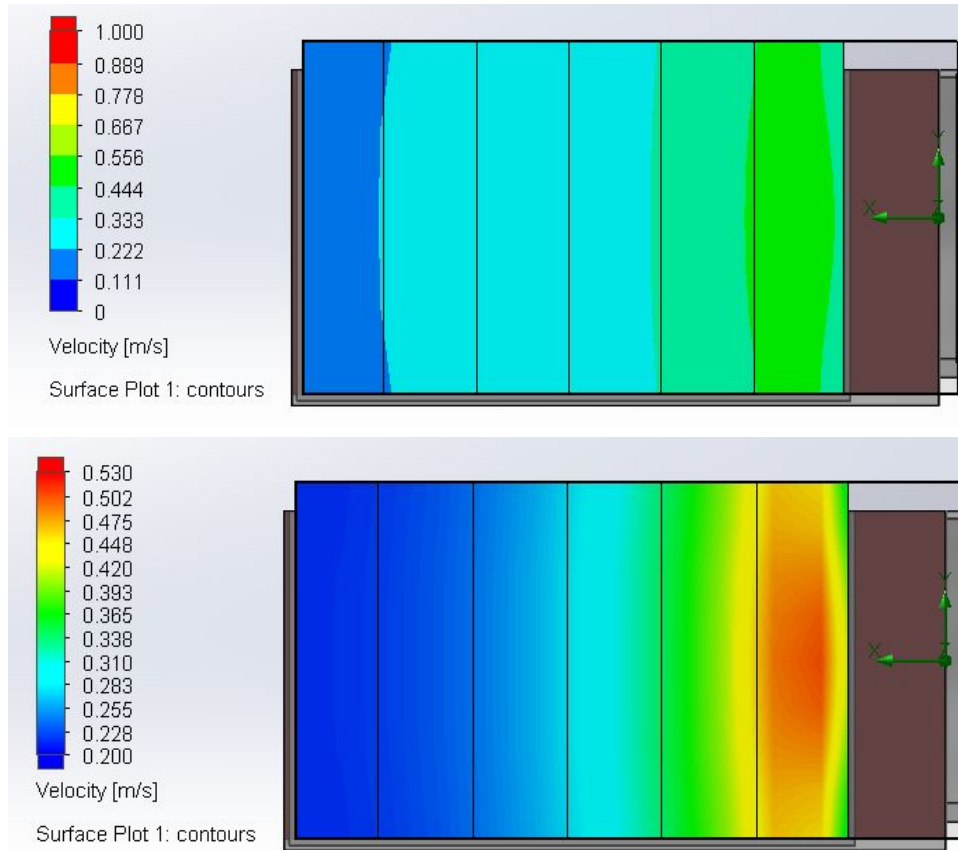

The edge effects seen in the previous version of the model have been greatly reduced.

8.2: Appendix B

Table of pressure and thickness values for 11 equally spaced pressure values. These were calculated as ratios between the one inch and two inch thick filters. For example, the 8:2 values are equal to 0.8 times the pressure for the one inch thick filter plus 0.2 times the pressure for the two inch thick filter.

	Press				
Velocity ▾	1 inch ▾	9:1 aprox ▾	8:2 aprox ▾	7:3 aprox ▾	6:4 aprox ▾
0.508	8.718115	8.718115	8.718115	8.718115	8.718115
1.016	28.645235	27.39979	26.154345	24.9089	23.663455
1.524	68.499475	65.510407	62.521339	59.532271	56.543203
2.032	114.58094	109.350071	104.119202	98.888333	93.657464
2.54	169.38052	161.409672	153.438824	145.467976	137.497128
3.048	230.407325	219.447409	208.487493	197.527577	186.567661
3.556	302.643135	287.946884	273.250633	258.554382	243.858131
4.064	391.06973	371.5162435	351.962757	332.4092705	312.855784
4.572	510.63245	483.23266	455.83287	428.43308	401.03329
5.08	660.08585	622.971589	585.857328	548.743067	511.628806
Thickness	0.0254	0.02794	0.03048	0.03302	0.03556

Pressure Drop Across Filter					
5:5 aprox ▾	4:6 aprox ▾	3:7 aprox ▾	2:8 aprox ▾	1:9 aprox ▾	2 inch ▾
8.718115	8.718115	8.718115	8.718115	8.718115	8.718115
22.41801	21.172565	19.92712	18.681675	17.43623	16.190785
53.554135	50.565067	47.575999	44.586931	41.597863	38.608795
88.426595	83.195726	77.964857	72.733988	67.503119	62.27225
129.52628	121.555432	113.584584	105.613736	97.642888	89.67204
175.607745	164.647829	153.687913	142.727997	131.768081	120.808165
229.16188	214.465629	199.769378	185.073127	170.376876	155.680625
293.3022975	273.748811	254.1953245	234.641838	215.0883515	195.534865
373.6335	346.23371	318.83392	291.43413	264.03434	236.63455
474.514545	437.400284	400.286023	363.171762	326.057501	288.94324
0.0381	0.04064	0.04318	0.04572	0.04826	0.0508

8.3: Appendix C

Table of Ideal centerline calculations and SolidWorks data from the one inch thick revised model and the best manual fit, or six section model. Distance units are in meters and pressure units are in Pascals. Data has been rounded.

x- position	Ideal Pressure Centerline	Uniform One Inch Thick Filter			Best Manual Fit				
		Centerline	Inside Filter	Outside Filter	Pressure Drop Across Filter	Centerline	Inside Filter	Outside Filter	Pressure Drop Across Filter
0.00	101324.20	101323.64	101324.40	-	-	101324.18	101324.94	-	-
0.01	101324.19	101323.64	101324.43	-	-	101324.18	101324.62	-	-
0.02	101324.17	101323.63	101324.39	101323.99	-0.405	101324.16	101324.60	101324.94	0.342
0.03	101324.14	101323.61	101324.39	101324.54	0.151	101324.14	101324.59	101324.89	0.300
0.04	101324.09	101323.59	101324.38	101324.69	0.315	101324.11	101324.58	101324.89	0.313
0.05	101324.03	101323.56	101324.36	101324.76	0.401	101324.07	101324.56	101324.89	0.329
0.06	101323.96	101323.52	101324.35	101324.80	0.449	101324.02	101324.54	101324.89	0.345
0.07	101323.87	101323.48	101324.33	101324.81	0.486	101323.96	101324.52	101324.88	0.368
0.08	101323.77	101323.42	101324.30	101324.83	0.525	101323.90	101324.49	101324.88	0.396
0.08	101323.66	101323.36	101324.28	101324.84	0.562	101323.82	101324.46	101324.88	0.422
0.09	101323.53	101323.29	101324.24	101324.84	0.603	101323.74	101324.42	101324.87	0.452
0.10	101323.39	101323.20	101324.20	101324.85	0.656	101323.64	101324.38	101324.87	0.487
0.11	101323.23	101323.09	101324.15	101324.86	0.709	101323.53	101324.35	101324.87	0.521
0.12	101323.07	101322.96	101324.09	101324.86	0.772	101323.41	101324.30	101324.86	0.565
0.13	101322.88	101322.81	101324.00	101324.87	0.864	101323.27	101324.23	101324.86	0.632
0.14	101322.69	101322.61	101323.85	101324.87	1.017	101323.08	101324.09	101324.85	0.767
0.15	101322.48	101322.37	101323.48	101324.87	1.394	101322.85	101323.75	101324.83	1.073
0.16	101322.26	101322.08	101322.79	101324.87	2.081	101322.58	101323.17	101324.76	1.584
0.17	101322.02	101321.76	101322.15	101324.87	2.718	101322.28	101322.75	101324.59	1.841
0.17	101321.78	101321.51	101321.79	101324.87	3.085	101322.04	101322.62	101324.43	1.809

8.4: Appendix D

Matlab code to create the ideal centerline and ideal pressure curves.

```

exithole_d = 0.08; % METERS the diameter of the exit hole
v_flow_rt = 0.01; %m^3/s the volumetric flow rate of air that needs to go into surgibox
v_max = v_flow_rt/(pi*(exithole_d/2)^2); % m/s the velocity going out of the system
len = 0.2; % meters length of the environmental box
parts = 100; % the number of points we are analysing at
rho = 1.225; % kg/m3 density of air in standard units
vf = 0.053; % m/s the speed at which air moves through the filter paper
A = 0.01; % inner area of the box in METERS

P_atm = 101325; % atmospheric pressure in PASCALS
dP_lo = 0.8; %pascals back end pressure across media representing the lower resistance
area

x = linspace(0, len, parts); % meters a vector of equally spaced x values
v = (v_max/len).*x; % m/s vector of the velocities at the x points
P1 = P_atm - dP_lo;
P = [P1, zeros(1, parts-1)]; %mostly empty pressure vector

for i = 1:(parts-1)
    P(i+1) = P(i)+(0.5*v_max^2* rho/(len^2)*((x(i))^2 - (x(i+1))^2));
end

```