

MIT Open Access Articles

Facilitator effects in middles and more

The MIT Faculty has made this article openly available. ***Please share*** how this access benefits you. Your story matters.

Citation: Newman, Elise. "Facilitator effects in middles and more." *Glossa* 5, 1 (June 2020): 62.

As Published: <http://dx.doi.org/10.5334/gjgl.990>

Publisher: Ubiquity Press, Ltd.

Persistent URL: <https://hdl.handle.net/1721.1/128372>

Terms of use: Creative Commons Attribution 4.0 International license



RESEARCH

Facilitator effects in middles and more

Elise Newman

MIT Department of Linguistics and Philosophy, Cambridge MA, US
esnewman@mit.edu

In this paper, I will argue that obligatory adjuncts in many languages' middle constructions are a byproduct of an independent constraint on movement, called Anti-locality (Abels 2003; Grohmann 2003; Bošković 2007; Schneider-Zioga 2007; Erlewine 2016; Brillman & Hirsch to appear). Anti-locality rules out movement that is too local; in other words, movement cannot produce a structure that is too similar to the pre-movement configuration. Though Anti-locality has typically been proposed for \bar{A} -movement, one of its signatures is the presence of obligatory adjuncts (Erlewine 2016; Brillman & Hirsch to appear), which are also found in many languages' middle constructions. I argue that the profile of obligatory adjuncts in middles is best understood if we extend Anti-locality to A-movement (Deal 2019), thus providing support for the unity of A- and \bar{A} -movement. The proposal will include a tightly restricted set of assumptions about the structure and derivation of a middle, which combined with a formalized Anti-locality constraint, predicts the obligatory adjunct effects we find in different languages' middle constructions. In particular, middles will be argued to lack a VoiceP and have a two step derivation, in which the object moves through Spec vP en route to subject position. Each movement step will be subject to Anti-locality, which can be ameliorated by adjuncts, reflexives, or lexical structure in the predicates that can form middles.

Keywords: Syntax; A-movement; Anti-locality; Middles; Obligatory adjuncts

1 Introduction

It has been proposed that constraints on too-local movement, often called Anti-locality constraints (Abels 2003; Grohmann 2003; Bošković 2007; Schneider-Zioga 2007; Erlewine 2016; Brillman & Hirsch to appear), are responsible for observed asymmetries in subject vs. object \bar{A} -extraction. Erlewine (2016) and Brillman & Hirsch (to appear) have shown that one of the signatures of Anti-locality is a requirement for otherwise optional adverbial phrases.

Brillman & Hirsch (to appear) demonstrate this with the following data on English *that*-trace effects. In (1), we see that object extraction out of embedded clauses allows the embedded complementizer *that* to be pronounced. Conversely subject extraction out of embedded clauses does not allow pronunciation of *that*, unless an adverbial phrase is inserted between embedded Spec TP and embedded C (Bresnan 1972; Culicover 1993).

- (1) a. What does Gromit think (that) Wallace ate?
b. Who does Gromit think (*that) ate the pineapple?
c. Who does Gromit think (that) for all intents and purposes ate the pineapple?

Brillman and Hirsch, following Erlewine (2016), propose that this effect is the result of subjects having to undergo too-local movement from the embedded Spec TP to embedded Spec CP before moving to the matrix clause, which violates Erlewine's *Spec-to-Spec Anti-locality*. When an intervening projection makes this movement step larger, the effect goes away. Objects do not show this effect because they move from the embedded Spec vP to Spec CP, which is sufficiently anti-local.

Spec-to-Spec Anti-locality (Erlewine 2016): \bar{A} -movement of a phrase in the Specifier of YP must cross a maximal projection other than YP

(2) $[_{CP}$ Who does Gromit think $[_{CP}$ that $*([_{AdvP} \dots)]$ $[_{TP} <who>$ ate the pineapple?

They therefore argue that subjects move directly from the embedded Spec TP to the matrix clause, without stopping in Spec CP. This step requires the complementizer to be unpronounced (on a linearization theory of phases (Fox & Pesetsky 2005)).

Though Anti-locality has been invoked primarily to explain constraints on \bar{A} -movement, we also see such sensitivity to adverbial phrases in A-movement phenomena, particularly in many languages' middle construction. Middles differ from passives and unaccusatives in this regard; passives and unaccusatives do not require adverbial phrases.

- (3) *Obligatory adjuncts in middles*
- a. Bureaucrats bribe *(easily).
 - b. This book reads *(quickly).
 - c. Beautiful landscapes photograph *(well).

In this paper, I will argue that this effect in middles arises for the same reasons it arises for *that*-trace effects, namely because these movement steps would otherwise be too local without an adverbial projection to facilitate movement. If my analysis is correct, it provides support for the unity of A and \bar{A} -movement as subject to the same types of constraints.

I know of one earlier argument that Anti-locality constrains A-movement, namely from Deal (2019). She proposes that we see Anti-locality effects in Nez Perce applicative unaccusatives. There, the theme argument raises over the applicative argument to receive ergative case. She argues that the theme must move across the applicative argument here because the applicative argument is trapped in Spec ApplP; movement from Spec ApplP to Spec v P is too short (Figure 1).

Trying to extend this constraint to A-movement must confront an obvious difficulty, namely that subjects raise to Spec TP from Spec v P, which appears to violate this constraint (Figure 2).

Many researchers have independently argued for a VoiceP, which, following Collins (2005) and Merchant (2007), might be projected above the external argument. This configuration would license movement to Spec TP with no violation. This paper will henceforth assume that Voice is indeed between the external argument and T, and argue that one of the differences between middle clauses and active/passive clauses is that middles lack this VoiceP layer. This proposal follows from the observation that it is uncommon for middles to have any special voice morphology, as will be discussed in section 2.

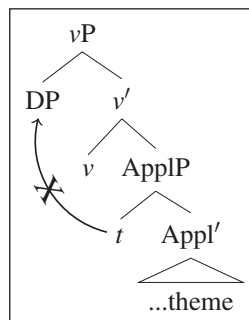

Figure 1: The applicative argument cannot escape the v P so the theme raises instead.

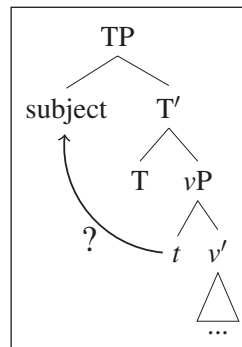

Figure 2: A-movement of the subject to Spec TP from Spec vP should violate Spec-to-Spec Anti-locality if it were applicable to A-movement.

The focus of this paper is A-movement of objects in a variety of constructions, and whether these constructions require additional projections, a phenomenon which I will call a *facilitation effect*. As we will see, adverbs are not the only sorts of projections that can affect movement possibilities in these constructions. I will therefore refer to any optional projection crucial to the well-formedness of constructions such as the middle as a *facilitator*. I will claim that we see facilitation effects in some A-movement constructions but not others due to structural differences between them.

There is a large literature about middles, much of which claims that facilitators in this construction correlate with other properties (e.g. genericity, ability interpretations). In this literature, the study of facilitation in middles is often limited to a set of sentences that are generic and ascribe a property to the surface subject. It is therefore unsurprising that most attempts to understand facilitators in middles link them to semantic quantities inherent to the set of sentences under discussion. In this paper, however, I will be considering a larger set of related sentences that exhibit facilitation requirements. The sentences that I consider have also been called middles by some, primarily because they are surface identical to those that have the “middle interpretation”, but they are not all generic nor do they necessarily have an ability interpretation.

One such use of the term “middle” to refer to non-generic sentences can be found in Sigurðsson (1989); Hrafnbjargarson (2005); Thráinsson (2007), describing Icelandic passive-like constructions. Svenonius (2006) summarizes this use of the word “middle” in Icelandic as referring to anything with agentless voice and the *-st* suffix, e.g. to describe certain reflexive, passive, and sometimes inchoative clauses. There is crucially no reference to a particular interpretation in this definition. For example, middles are not assumed to be necessarily generic.

- (4) *Icelandic* (Svenonius 2006: 16): “middle” can be episodic
 Bjórinna kláraði-st.
 the.beer finished-MID
 ‘The beer got finished up.’

This definition contrasts with other uses of the word “middle”, which might refer in whole or part to a semantic interpretation, rather than a single syntactic configuration. For example, Lekakou (2005) describes middles as a particular pairing of form and interpretation, namely as “generic sentences about the understood object. They feature an otherwise internal argument [...] in syntactic subject position”. Marelj (2004) similarly refers to middles as a cross-linguistic semantic category, where languages can differ syntactically in how to realize a middle.

To keep these notions separate, I will use the term *syntactic middle* (or *s-middle*) to describe any sentence with the syntactic structure of interest in this paper, irrespective of whether it is generic or has other semantic features associated with middles. For example, (5) shows two Italian reflexive sentences with a fronted internal argument that have been argued by many authors to be syntactically identical (Authier & Reed 1996; Ackema & Schoorlemmer 2002; Lekakou 2005). Those with semantic notions of middle in mind have called (5a) a passive and (5b), a middle, due to the fact that one is episodic and the other, generic. However, given their syntactic identity, I will refer to both as s-middles.

(5) *Italian s-middles*

- a. “Reflexive-marked Passive”: can be episodic (Cinque 1988: 554)
Qui, gli spaghetti si mangiano spesso.
here the spaghetti REFL eat often
‘Here, spaghetti is often eaten.’
- b. “Middle”: must be generic (Cinque 1988: 559)
Questo tabolino si trasporta facilmente.
this table REFL transports easily
‘This table transports easily.’

The study of facilitation effects in s-middles pertains to whether removal of a facilitator in either (5a,b) results in ungrammaticality. Some Romance languages have examples like (5a,b) that have been argued not to require facilitation. English middles, however, always require a facilitator, even when they have episodic interpretations.

(6) Episodic middles require facilitators in English

- a. The bread cut quickly when I used the sharper knife.
- b. *The bread cut.

Episodic examples like those in (6) were claimed to be marginally acceptable in Keyser & Roeper (1984) (see (7)), though I have consulted several English speakers who find them perfectly acceptable, and have included an attested example from the internet.

(7) Judgments from Keyser & Roeper (1984: 384)

- a. ?Yesterday, the mayor bribed easily, according to the newspaper.
- b. ?At yesterday’s house party, the kitchen wall painted easily.

(8) (referring to rescued baby raccoons) “...they tamed so well so easily...”
(https://www.youtube.com/watch?v=1t_ZoMxmYRE)

The aim of this paper is to show how a lack of structure can be used as a predictor for facilitation effects in different constructions. Throughout the analysis, I will propose and make use of a revised notion of Anti-locality that builds on previous versions in the literature. The motivation for this revision will be discussed in sections 2 and 4.

(9) **Anti-locality, revised:** A moving constituent α must cross a constituent distinct from the closest X^0 that c-commands it.

- (10) **Crossing:** Movement from a position α to a position β crosses a constituent γ iff γ asymmetrically c-commands α but not β .

I propose a two step derivation in s-middle formation in which the object moves to Spec vP en route to Spec TP. The claim is that both of these steps involve too-local movement unless extra projections are present which can obviate the Anti-locality effect. S-middles inherently lack the two projections that would normally license movement in passives, i.e. VoiceP and the external argument, so s-middles require adverbial phrases or projections such as negation to be inserted (Figure 3).

This approach correctly predicts positional restrictions on the possible facilitators that license s-middles and their interaction with various sorts of predicates. Additionally, on this theory, the apparent differences in facilitation requirements for s-middles cross-linguistically follow as differences in the morphological realization of s-middles in different languages. In particular, languages that have a reflexive in their s-middle constructions will require less facilitation than English s-middles do, because the reflexive argument is extra structure in the clause.

Since unaccusatives are also agentless clauses, this account will also make predictions for the movement patterns of objects in unaccusative clauses. However I will argue that unaccusatives are derivationally different from s-middles and passives by allowing movement of the internal argument to Spec TP in one fell swoop. This difference is due to the fact that unaccusatives are syntactically and semantically agent-less and lack the relevant v head that triggers movement to its edge. This will be discussed in section 5. Finally, additional discussion about previous work on facilitators and the base position of subjects in s-middles can be found in section 6.

2 Anti-locality and object movement

Various Anti-locality constraints have been proposed in the literature (Abels 2003; Grohmann 2003; Bošković 2007; Erlewine 2016); I will concentrate here on the two illustrated in (11) and (12)¹:

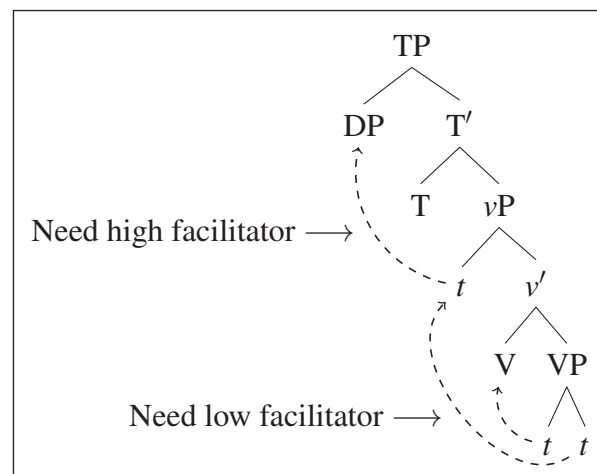
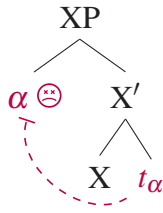

Figure 3: Schematic of proposal. Discussion of how Anti-locality affects movement to the edge of vP will be discussed more concretely in section 4.

¹ Erlewine's Spec-to-Spec Anti-locality has been revised here; the original proposal specifically referenced \bar{A} -movement.

- (11) **Comp-to-Spec Anti-locality** (Abels 2003): movement of the complement of a head X must cross a head other than X



- (12) **Spec-to-Spec Anti-locality** (Erlewine 2016): movement of a phrase in the Specifier of YP must cross a maximal projection other than YP

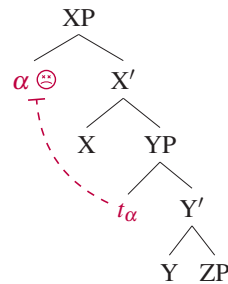

Here I propose that we unify and generalize these two constraints in the following way:

- (9) **Anti-locality, revised:** A moving constituent α must cross a constituent distinct from the closest X^0 that c-commands it.
- (10) **Crossing:** Movement from a position α to a position β crosses a constituent γ iff γ asymmetrically c-commands α but not β .

In line with this formulation, the types of objects that I will argue affect movement possibilities include both functional heads on the clausal spine as well as specifiers such as the external argument. Adjuncts are also claimed to affect movement possibilities, and will therefore be assumed to have one of these representations. The trees in this paper all have adjuncts as specifiers, but note that nothing hinges on this choice, provided that adjuncts are a part of the same numeration as non-optional elements.

I will additionally argue that head movement reduces movement possibilities by expanding the domain of the moving head. The precise proposal will be outlined in section 4. In the meantime, assume that if an X^0 moves to another head Y^0 , a moving constituent α must cross another constituent in addition to both the base and landing positions of X^0 (Figure 4).

Throughout my discussion of object movement, I will assume that the object moves through Spec νP en route to Spec TP. I will further assume that external arguments are

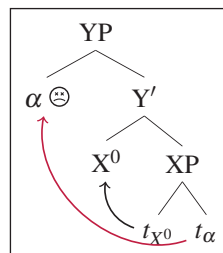

Figure 4: Head movement feeds Anti-locality violations.

introduced in Spec ν P, and Voice is the locus of passive/active morphology (Collins 2005; Merchant 2007).

On these assumptions, the contrast in (13) is related to the one in (14). In other words, the need for an adverb in (13a) but not in (13b) correlates with an inability of a s-middle clause to host an agent in (14a) compared to a passive clause in (14b). Passives, on this account, have an additional layer of structure (actually two counting the passive morphology), responsible for the introduction of the *by*-phrase, which plays the same role as the adverb in (13a), licensing movement across it.

- (13) a. The ocean photographs *(well).
 b. The ocean was photographed (well).
- (14) a. *The ocean photographs well by amateurs.
 b. The ocean was photographed well by an amateur.

We can see in Figure 5 that passives should never need facilitation in any domain because movement is already licensed by the structure. Whether or not V moves to ν , the presence of the external argument is enough to facilitate movement of the object to Spec ν P. The VoiceP facilitates the second step to Spec TP.²

Conversely s-middles are argued to lack at least two of these structural components, namely the agent and a VoiceP. We first discuss the lack of an agent in s-middles. Other work on middles provide several sorts of tests for syntactic activity of an agent, e.g. purpose clauses, agentive adverbs, and *by*-phrases. Middles have been described as having an “implicit agent” (Levin 1993) because we still interpret middle clauses as logically transitive. However we can see that this implicit agent is not represented structurally in s-middles due to the inability to host a *by*-phrase and the contrasts with passives in (15), (16), and (17).³

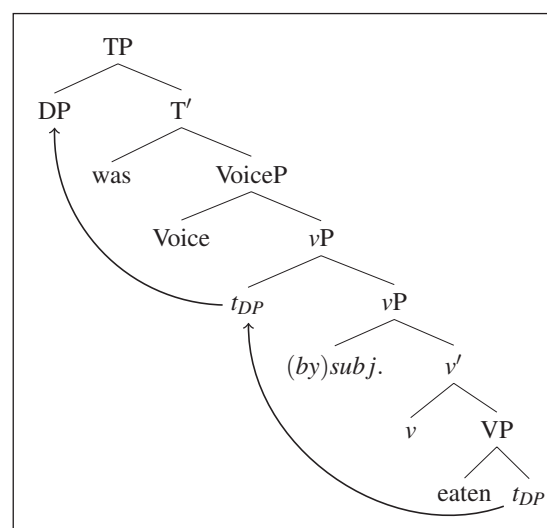

Figure 5: A derivation for passives. No facilitation is needed because both movement steps are Anti-local.

² Here, the *by*-phrase is represented as a ν P specifier (that is presumably linearized on the right), but the proposal can equally well be recast under a smuggling (Collins 2005) approach to passives, where the subject is in Spec ν P and *by* is in Voice, or any other approach that links a *by*-phrase to the presence of some external argument projection in ν P.

³ There is some debate regarding the reliability of the purpose clause test. I chose an episodic s-middle to illustrate the purpose clause diagnostic in order to guard against worries that stativity might independently affect purpose clause licensing. I refer the reader to Ackema & Schoorlemmer (2002) and Lekakou (2005) for additional discussion about control as evidence for the syntactic activity of arguments.

- (15) *English*
- a. The bread was cut quickly to placate the impatient customers.
 - b. *The bread cut quickly to placate the impatient customers.
- (16) *Norwegian* (Johannes Norheim, p.c.)
- a. All maten ble spist for å hindre sløsing.
all food.the was eaten for to prevent waste
'The food was eaten to prevent waste.'
 - b. *All maten spises for å hindre sløsing.
all food.the eat-MID for to prevent waste
intended: 'The food got eaten to prevent waste.'
- (17) No agent-oriented adverbs
- a. This landscape photographs easily.
 - b. *This landscape photographs angrily. (cf. This landscape is photographed angrily (by tourists).)
 - c. This shirt irons quickly.
 - d. *This shirt irons proudly. (cf. This shirt is ironed proudly (by my tailor).)

To summarize, while an unpronounced agent in a passive clause can control a PRO in a purpose clause and be referenced by an agent-oriented adverb, the implicit agent of a s-middle cannot. On the basis of these tests, I conclude that agents are not syntactically active in s-middles but they are in passives, a conclusion taken up in Fagan (1992), Ackema & Schoorlemmer (1995; 2002), Marelj (2004) and others.⁴

I additionally propose that s-middles lack a VoiceP. The proposed lack of Voice follows directly from my assumption that Voice is the locus of passive morphology (Collins 2005; Merchant 2007), which is absent in s-middles (and present, but null in active clauses). In fact, there is no visible middle morphology in many languages, which makes it plausible that there is no dedicated projection in the clause where s-middle-hood is specified (Figure 6). Some languages do have morphological projections inherent to their s-middle constructions, but these projections are typically homophonous with a language's reflexive construction.

- (18) *Icelandic* (Thráinsson 2007: 284-287)
- a. Stóllinn eyðilagði-st.
chair.the destroyd-MID
'The chair got destroyed.'

⁴ As a reviewer points out, some researchers (e.g. Stroik (1992)) have argued that middles do have syntactically active agents, showing that while they don't license *by*-phrases, they do license *for*-phrases. As Lekakou points out, however, *for*-phrases are not a clear test for syntactic activity of the agent because they can generally appear in clauses to introduce arguments that bear no thematic relation to that clause. Additionally, while middles can in principle refer to inanimate and experiencer subjects (like passives), *for*-phrases seem to only introduce agents (unlike *by*-phrases).

- i. *For*-phrases in middles
 - a. This book reads easily for Mary.
 - b. Potatoes don't peel for me.
- ii. *For*-phrases allowed even in intransitive clauses
 - a. This book is too heavy for me.
 - b. These potatoes are too greasy for me.
- iii. *For*-phrases require agentive arguments
 - a. Mary pleases easily (??for John). (c.f. Mary was pleased by John)
 - b. Cities don't destroy easily (??for hurricanes). (c.f. The city was destroyed by the hurricane)

- b. klæða, klæða-st
dress, dress-REFL
'dress, dress oneself'

(19) *French*

- a. Le pain **se** cuit facilement.
the bread REFL bake easy
'Bread bakes easily.'
- b. Jean **s'est** évanoui.
John REFL-is fainted
'John fainted.'

On this approach to s-middles, there is no logical connection between s-middles and passives, and we might expect to find languages that lack passives but exhibit s-middles. Buli is a candidate for such a language. Buli is claimed not to have a passive, preferring to insert an impersonal subject when an English speaker might use the passive. However, there appear to be transitivity alternations with a restricted set of verbs that yield passive-like interpretations.⁵

(20) *Buli* (Abdul-Razak Sulemana, p.c.)

- a. John ðìgì lĀmmú.
John cook the.meat
'John cooked the meat.'
- b. lĀmmú ðìgì (*John).
the.meat cook (*John)
'The meat cooked (*by John).'
- c. John tè bísáŋá lĀmmú.
John give children the.meat
'John gave children the meat.'
- d. ?Bísáŋá tè lĀmmú.
children give the.meat
'Children got the meat.' (need context to avoid garden path)

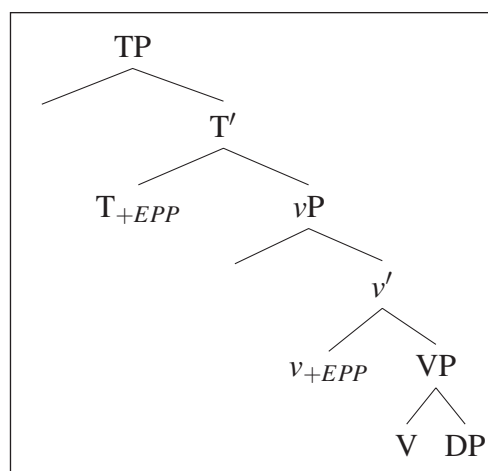

Figure 6: A tree for s-middles without movement.

⁵ Many thanks to Abdul-Razak Sulemana for sharing judgments and discussion.

- e. L̄ammú tè bísájá.
the.meat give children
'The meat was given to children.'

Not all verbs require facilitators to participate in this alternation, which is a feature of some language's s-middle constructions that will be discussed shortly. However, adding facilitators such as modals and negation expands the range of verbs that can alternate, thus showing that this alternation is sensitive to facilitation.

- (21) a. Bísájá miŋ(i) AJohn.
Children recognize.(IPFV) John
'The children recognize John.'
- b. AJohn *(an bag a) miŋ(i).
John *(NEG can IPFV) recognize
'John can't be recognized.' (need negation/modal/aspect)

Given the apparent *by*-phrase constraint and sensitivity to facilitators that these Buli transitivity alternations show, we might conclude that Buli has a productive s-middle construction, despite its lack of a passive. If s-middles contained all of the same functional projections as a passive, we might have expected languages to contain both s-middles and passives or neither. Buli clearly shows that the two constructions are separable and should therefore have different structural descriptions. I have proposed that the s-middle clause is contained within the passive.

This leaves us with a representation of s-middles in which TP selects for a *v*P that does not introduce an external argument. If this analysis is right, it suggests a relationship between the external argument and Voice in which the feature for introducing an external argument is inherited by *v* from Voice.⁶ In the absence of Voice, we also lose the agent. However, we retain the possibility for object movement to target the edge of *v* due to either an EPP feature or its status as a phase.

An additional point of variation between passives and s-middles regards the placement of adverbs, which suggests that V moves to *v* obligatorily in s-middles (Koizumi 1995). Adverbs always appear post verbally in s-middle formation in English.

- (22) a. This book reads easily.
b. *This book easily reads.
- (23) a. This book was read easily.
b. This book was easily read.

The post verbal appearance of the adverb should not be attributed to a right-adjunction requirement on the adverb because in the presence of a complement PP, the adverb need not appear sentence finally. This complement PP can be prosodically reduced, ensuring that it isn't right dislocated due to heaviness in these examples, but is truly in a complement position (Figure 7).

- (24) a. This story tells easily to small children/them.
b. This story tells to small children/them easily.
c. Small packages send more quickly to Massachusetts than New York.
d. Small packages send to Massachusetts more quickly than New York.

⁶ Recall that if external arguments were introduced in Voice, they would violate Anti-locality when moving to Spec TP.

Putting the pieces together, what are the expected facilitation effects and movement possibilities for s-middles? In the absence of Voice, we expect to need a facilitator between *vP* and TP, such as negation (or any projection that triggers *do*-support). Otherwise movement to Spec TP would only cross the T head, which is ruled out by Anti-locality (Figure 8). Facilitators that target this position will be henceforth referred to as *high* facilitators.

Moving the object to the edge of *vP* is also expected to require a facilitator because V moves to *v*. Facilitators that project in this lower domain (e.g. manner adverbs) will henceforth be referred to *low* facilitators (Figure 9).

This structure and derivation predicts that an object needs two types of facilitators, both high and low, if it tries to move to Spec TP. However, thus far we have only considered

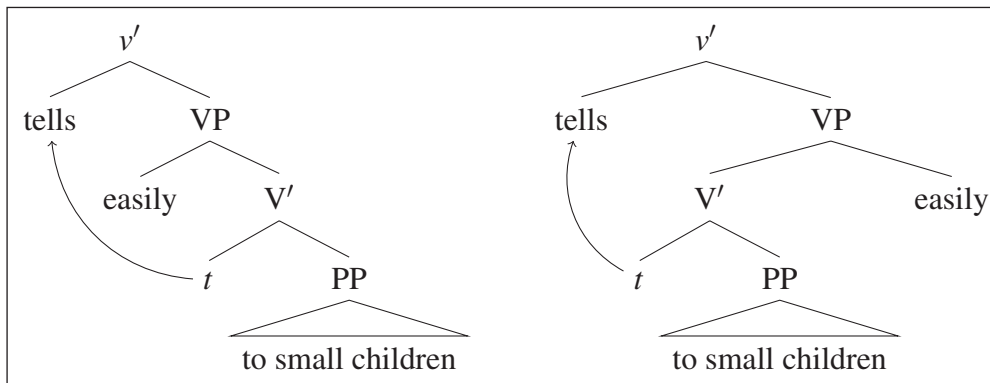

Figure 7: Rightward vs. leftward projection of the adverb yields both possible orders in English. Leftward *easily* is crucial to deriving (24a).

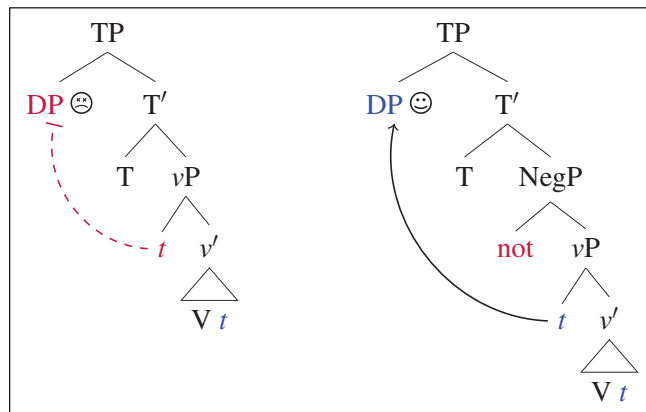

Figure 8: Negation can license movement from Spec *vP* to Spec TP in the absence of Voice.

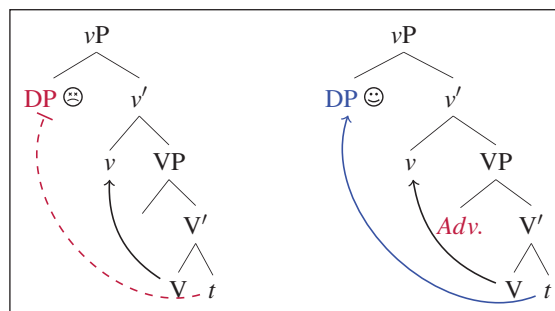

Figure 9: Movement from complement of V to Spec *vP* violates Anti-locality in the absence of an adverb.

very simple VP structures, in which there is nothing between the verb and the direct object. Indeed there are other possible and proposed configurations with more articulated VP structures, containing either null or overt structure between the verb and its internal argument (e.g. instrumental structure, verb-particle constructions, resultative phrases, inherent case layers, etc. (Hoekstra 1988; Bittner & Hale 1996; Hale & Keyser 2002; Pylkkänen 2008; Ramchand 2008 and many others)).

Let us now consider what facilitation patterns we would expect if the object were further embedded in an abstract projection. There are two possible embedding patterns: 1) the object is the complement of some head X that is the complement of V, or 2) the object is the specifier of some XP complement of V. Let us further assume that this material is pied-pipe-able. Considering the first option, if the object is the complement of some XP, the object can move across the XP to Spec vP without a low facilitator, thus needing only a high facilitator. Alternatively, it can pied pipe the XP and strand it later, needing a low facilitator but not a high one (Figures 10, 11, 12).

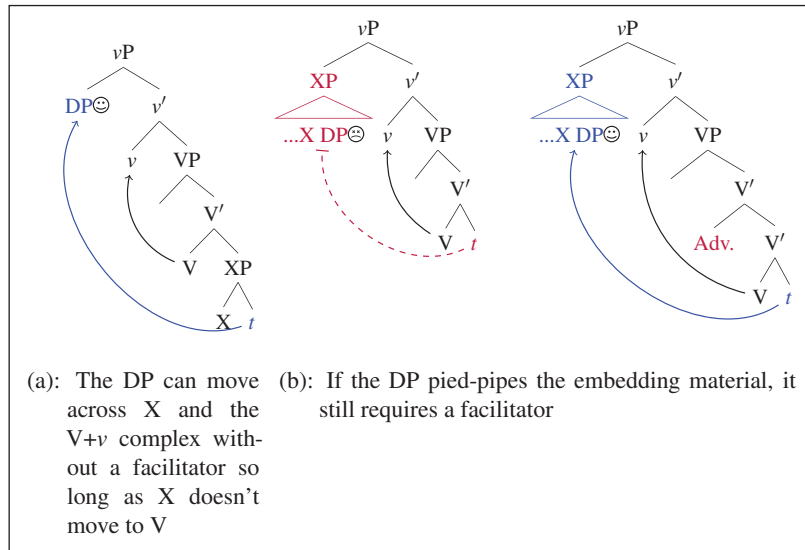

Figure 10: Anti-locality can be ameliorated by either a facilitator or structure that further embeds the DP.

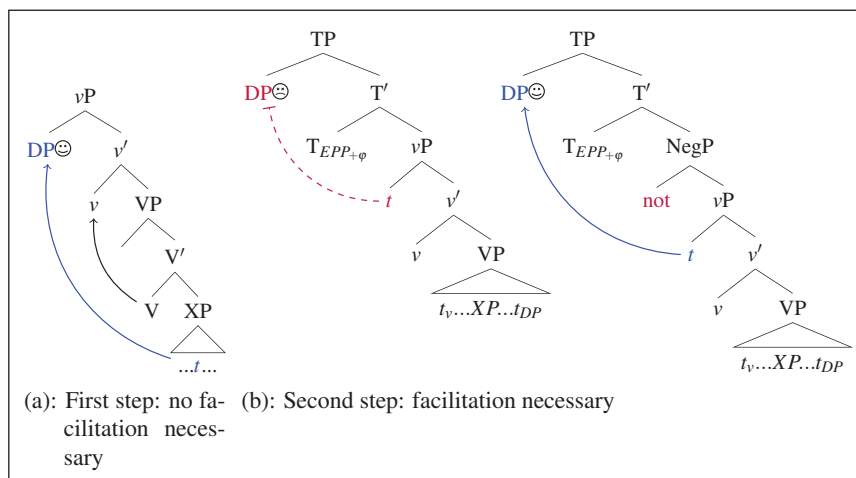

Figure 11: Spelling out a derivation that only requires a high facilitator: a further embedded DP moves across X and the verb to Spec vP, thus not requiring a low facilitator, but needs a high facilitator to move to Spec TP.

Now considering option two, if the object were a specifier instead of a complement of XP, a low facilitator would always be obligatory whether or not the XP is pied-piped. However, the derivation can avoid needing a high facilitator if the DP *does* pied-pipe the XP in such a structure, because it can strand it in the second step to ameliorate Anti-locality en route to Spec TP. This is because when the whole XP is in Spec *v*P, the *v*' asymmetrically c-commands the DP specifier to X, and is crossed (along with T) by the DP when it moves to Spec TP (Figure 13).

We therefore predict three types of facilitation effects in English s-middles depending on whether and how the object is embedded. If the object is not further embedded, we should need both a low and a high facilitator. If the object is further embedded, depending on whether it is the complement or the specifier of the embedding structure will determine

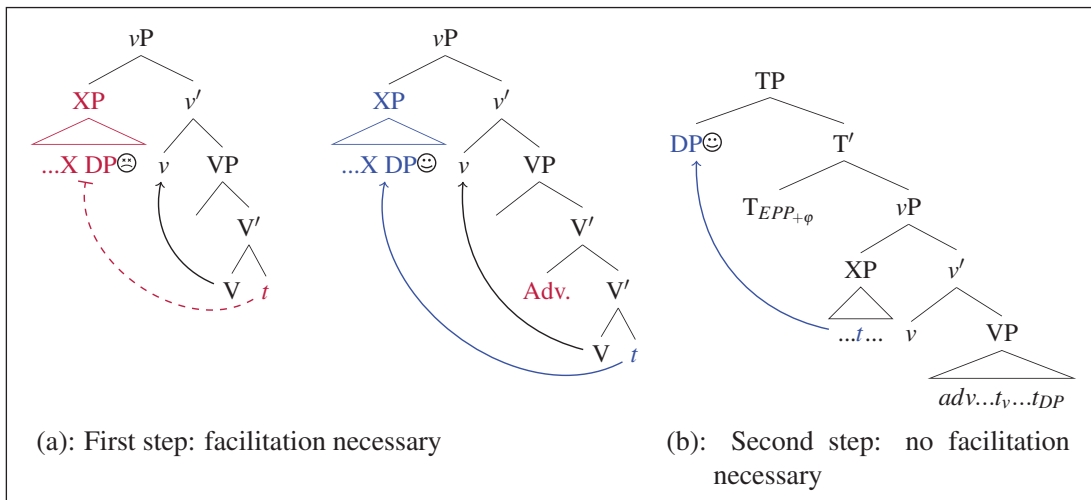

Figure 12: Spelling out a derivation that only requires a low facilitator: the embedding structure was pied-piped in the first movement step, which violates Anti-locality in the absence of an adverb. That structure can be stranded in the second step, thus not requiring a high facilitator.

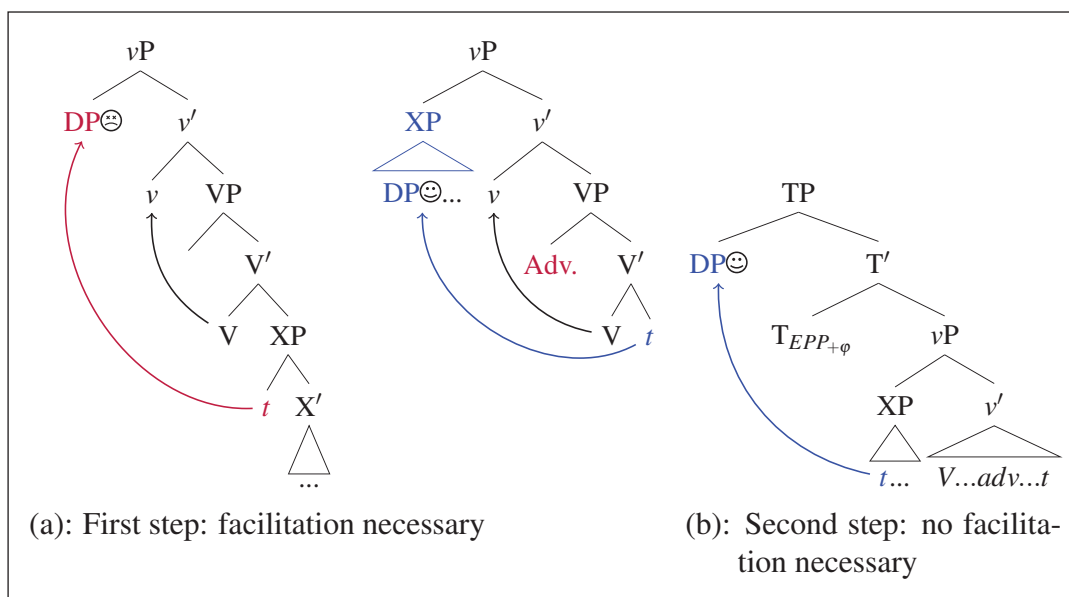

Figure 13: A low facilitator is always necessary because the XP doesn't count as material crossed by its specifier DP.

whether it obligatorily takes a low but not necessarily a high facilitator, or if either a low or a high facilitator will do.

Looking now at the options for facilitating s-middles, exactly these facilitation patterns appear to be found. Different verbs indeed behave differently with respect to the facilitation requirements. On this analysis, the results suggest that different verbs have different kinds of structure associated with their direct objects. The most commonly cited s-middles pattern with the further embedded objects.

- (25) Either high or low facilitator works
- | | | |
|----|--|----------------------|
| a. | The bread cut easily/quickly/like molasses. | ✓ <i>Low adverb</i> |
| b. | The bread should/might/will cut. (...I thawed it yesterday) | ✓ <i>Modal</i> |
| c. | The bread didn't cut. | ✓ <i>Negation</i> |
| d. | A: I told you it would be hard to cut bread with a fork.
B: But the bread <i>did</i> cut! | ✓ <i>Verum focus</i> |
- (26) Only low facilitator works
- | | | |
|----|--|----------------------|
| a. | The book reads easily/quickly/like a play. | ✓ <i>Low adverb</i> |
| b. | *The book should/might/will read. | * <i>Modal</i> |
| c. | *The book doesn't read. | * <i>Negation</i> |
| d. | A: I told you, books are for using as pillows, not reading!
B: *But the book <i>did</i> read! | * <i>Verum focus</i> |

Both categories contain many verbs; a sample of English verbs and their corresponding requirements is summarized below.⁷

Either: cut, peel, stuff, wash, erase, scorch, mix, spread, stain, wear-out, polish, squeeze, knead, shell...

Only low: read, bribe, test, photograph, shelve, wear, store, prepare, salt, iron, befriend, fill, cure, saddle...

Less common are verbs that require both a high and a low facilitator. In other words, these verbs pattern with those structures that do not further embed objects.

- (27) Need both high and low
- *Those diamonds steal easily.
 - *Those diamonds don't steal.
 - ?Those diamonds don't steal easily.
 - *Roger Federer defeats easily.
 - *Roger Federer doesn't defeat.
 - ?Roger Federer doesn't defeat easily.

It has been observed that there is a fourth class of verbs, namely statives, that can never form a s-middle in English (Condoravdi 1989; Fagan 1992; Ackema & Schoorlemmer 2006). The behavior of statives may be understood under my analysis, (on the assumption that statives do not further embed their objects), because statives disallow modification

⁷ Individual speakers sometimes vary in how they categorize these verbs. There is also a strong judgment fatigue effect, which makes it difficult to ask any particular speaker about many verbs back to back. The verbs in this list are not meant to be comprehensive.

by manner adverbs (Thomason & Stalnaker 1973; Katz 2003). It is therefore unclear if any facilitator can target the relevant position for the object to raise.⁸

- (28) a. *Gromit doesn't know algebra quickly.
 b. *Wallace doesn't own a house easily.
- (29) a. *Algebra doesn't know quickly.
 b. *Houses don't own easily.

English isn't unique in this regard. We have seen that Buli requires different amounts of facilitation for different verbs, and we will now see that French also does. The difference between English and French is that French also has a preverbal reflexive clitic in its s-middle construction, which serves as an ever-present high facilitator, collapsing the paradigm to just three types of verbs: those that require a low facilitator, those that do not, and those that can't form a s-middle.⁹

- (30) *French* (Keny Chatain, p.c.)
- a. Le papier se lave.
 The paper REFL wash
 'This paper is (generally) washed.'
- b. La Tour Eiffel se voit ??(depuis ma fenetre).
 the tower Eiffel REFL see from my window
 'The Eiffel Tower is visible from my window.' (one sees the Eiffel Tower from my window)
- c. #/*Les chocolats se veulent en fin de repas.
 The chocolates REFL want.3PL in end of meal
 intended: 'One usually wants chocolate at the end of the meal.'

A summary of facilitation requirements in s-middles and their corresponding structures can be found in Figure 14. Further discussion of the structure of these predicates continues in section 3.¹⁰

If in another language subjects either remain in situ (pro-drop or VSO languages) or move from Spec *vP* to a position higher than Spec *TP* (e.g. possibly V2 languages), we expect high facilitators to never be necessary.¹¹ Such languages are therefore predicted to have fewer restrictions on s-middle formation than English.

⁸ One might wonder if non-manner adverbs can project in this domain to license stative s-middles (e.g. *thoroughly*). Here I defer to other semantic work on the middle construction that shows a connection between the possible adverbs and the implicit agent in middles. It would appear that not all adverbs are possible in s-middles, even when the claimed syntactic and semantic properties should be satisfied (e.g. **The bread cut thoroughly*). Additional investigation of the types of adverbs that allow s-middle formation can be found in Appendix A.

⁹ My thanks to Keny Chatain for French judgements and discussion.

¹⁰ As a reviewer points out, there are also so-called non-standard s-middles in English that do not require facilitation at all (e.g. *This dress buttons*, *Glass recycles*). However, looking more closely at their meaning suggest that they have a focus structure unlike the other s-middles discussed so far (Marelj 2004). *This dress buttons* is most naturally understood to mean that the dress's fastening mechanism is one with buttons rather than say, a zipper. By contrast, s-middles like *this bread cuts easily* don't refer to alternative bread activities. Assuming that focus contains an operator with a context variable (Rooth 1985), I would argue that *Dress buttons/Glass recycles* do contain facilitation, just not overtly.

¹¹ Whether high facilitators license s-middles in V2 languages could bear on the question of whether subjects move to Spec *CP* from Spec *TP* or from Spec *vP*. Based on my investigation of German, there seem to be dialectal differences on this point. German s-middles also contain a postverbal reflexive pronoun (unusual compared to preverbal reflexive clitics and reflexive suffixes elsewhere), but always requires low facilitators. It is unclear why the reflexive pronoun doesn't reduce German's modification requirement by acting as a low facilitator. I leave this for future research.

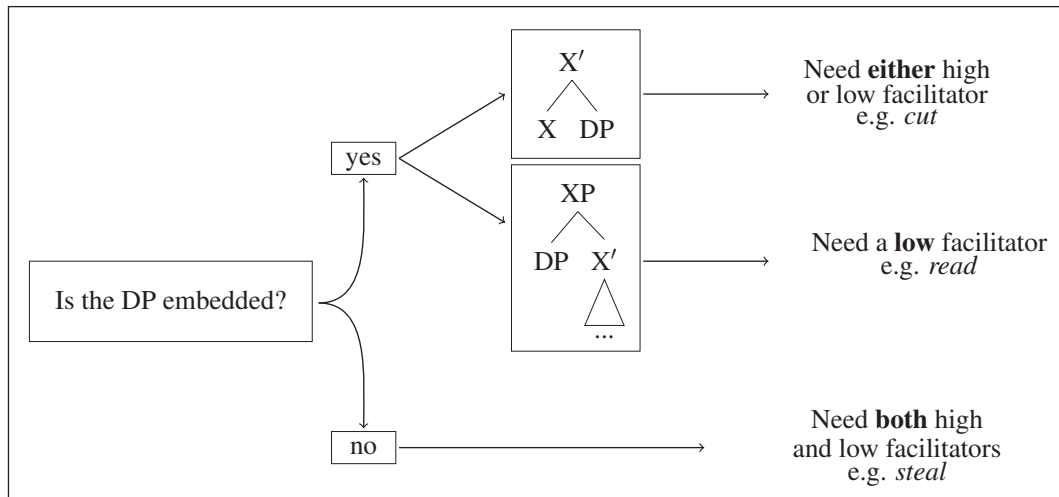

Figure 14: Whether a DP is embedded in an XP, and where the DP is merged in that XP derives the full typology of facilitation requirements we have seen. Stative verbs are in the *no XP* category but cannot host the required low facilitators, resulting in the impossibility of s-middle formation for stative verbs.

If languages such as these additionally have another projection inherent to their s-middle, hosting a reflexive clitic, for example, that element could act as an ever-present facilitator, thus eliminating the need for any other facilitation. Spanish appears to be such a case. The Spanish s-middle is morphologically very similar to the French s-middle, containing a reflexive clitic. However, unlike French, Spanish s-middles have not been reported to have the same aspectual and modification requirements for passive-like interpretations.

It therefore appears that pro-drop may indeed correlate with differences in modification requirements, on the stipulation that the reflexive clitic is a low facilitator in Spanish, but a high facilitator in French.¹² Since Spanish doesn't require movement to Spec TP, the clitic is enough to license the derivation without an extra facilitator. This analysis therefore correctly predicts that Spanish can give a passive-like interpretation to reflexive constructions with even unmodified, stative verbs.

- (31) *Spanish* (Imano Suárez-Palma, p.c.)
 Este libro se quiere.
 this book REFL wants
 'This book is wanted.'

This section has provided a framework through which to investigate facilitation requirements in languages with varying structural and derivational properties. We now turn our attention to the structural differences between verbs that correspond to varying facilitation requirements within a given language.

3 Different predicate structures

In the previous section I showed how different amounts and types of embedding around an object predict the observed facilitation patterns in English (and French) s-middles. So what is the difference between these predicates that they should support these different

¹² I must assume that *se*-clitics may project in different places in different languages for this difference to be explained. More evidence is certainly needed to verify this hypothesis, but it derives preliminary support from work by Burzio (1986): 144–148. He proposes that the different distribution of reflexive clitics in pro-drop Romance languages vs. French can be explained if French generates its clitics higher than the pro-drop languages do. I leave this as a topic for future research.

structures? Researchers who have studied the types of verbs that form s-middles have had various ideas about them, for example that middle verbs take affected objects or have particular aspectual requirements. The success of these generalizations has been debated, but there is a clear consensus concerning middle verbs that they carry a semantic richness that not every verb has. In this section, I argue that the extra meanings associated with middles (e.g. affectedness) are syntactically represented as structure that embeds DP objects in the forms outlined in section 2 (i.e. specifiers of some XP or complements of some X).

3.1 Specifiers of XP

We can see in (32) and (33) that two verbs of the same semantic class do not necessarily behave the same way with respect to s-middle formation, despite having similar meanings. For example, in the *kill* class of verbs, speakers note different facilitation requirements between those verbs which are independent of killing mechanism and those which imply a specific mode of killing. Similarly among food preparation verbs, *make* is degraded compared to a verb like *broil* with just a low facilitator.

- (32) a. ??/*Roaches kill easily.
b. Roaches poison easily.

- (33) a. ??/*This dish makes easily.
b. Salmon broils easily.

Hale & Keyser (2002) propose to represent the difference between *kill* and *poison* syntactically by arguing that one structurally contains the other. They call verbs like *poison* *synthetic* verbs, and analyze them as *kill with poison*. On their analysis, *poison* is really the verb *kill*, which can take a PP complement $\langle DP \rangle$ *with poison*. This DP is the specifier of the PP, as illustrated in Figure 15, which is the configuration I proposed for verbs like *read* that need a low facilitator. At some point in the derivation, *poison* moves to V.

The analysis outlined in section 2 predicts that if *poison* indeed has this structure, it should require a low facilitator for its s-middle. In other words, it should not be possible to license this s-middle with only a high facilitator. This prediction is borne out.

- (34) a. *These roaches don't poison.
b. *This salmon doesn't broil.

The analysis outlined in section 2 combined with a theory of semantic richness that is represented syntactically therefore provides an explanation for the behavior of this class of middle-able verbs.

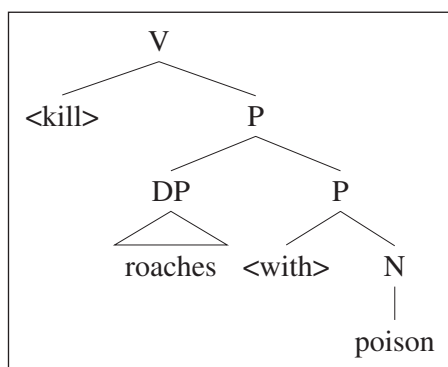

Figure 15: Structure for synthetic verbs in Hale & Keyser (2002). This is the XP structure that I argued for verbs like *read*.

3.2 Complements of X

Section 2 also predicted that there should be a second type of embedding with different properties from verbs like *read/poison*. The second type of embedding was proposed to take the moving object as a complement rather than a specifier. There are some possibilities for null structure of this sort in English, such as resultative phrases or null PP's. More concretely, a possible *overt* manifestation of this structure might be quirky or oblique cases in languages that have them. Looking at Icelandic confirms that quirky case behaves much as we would expect an XP with DP complement to behave in s-middle formation. This finding supports a view in which quirky case is assigned by a null preposition (Rezac 2008; Pesetsky 2013 among others). On this view, quirky case is unlike unmarked/dependent cases, which I assume to be licensed either via dependent case assignment or agreement with other functional heads in the clausal spine.

A-movement of objects in Icelandic can either preserve quirky case on the raised object, or eliminate it depending on what type of clause it is in. Passives, so-called “quirky unaccusatives”, and ditransitive s-middles allow (or require) objects to keep their quirky case, while most unaccusatives and other s-middles cause the object to lose its quirky case. Here I will focus on the difference between passives and s-middles, though what I propose may generalize to the other clause types as well.

- (35) Passives (Svenonius 2006: 14)
 Dyrinum var lokað (af dyraverðinum) klukkan sjö.
 the.doors.DAT was closed by the.porter the.clock seven
 ‘The doors were closed (by the porter) at seven o’clock.’

- (36) S-middles (Svenonius 2006: 17, from Hrafnbjargarson 2005)
- a. Við læsum dyrinum.
 we lock the.doors.DAT
 ‘We are locking the doors.’
 - b. Dyrnar læsa-st.
 the.doors.NOM lock-MID
 ‘The doors are locking.’

An interpretation of these facts that is consistent with my analysis of s-middles holds that quirky case is assigned by a null KP shell that must be stranded in s-middle formation, but is pied-piped in passives.¹³ Passives contain enough structure to allow the entire KP containing the DP to move to subject position without Anti-locality violations. S-middles lack this structure and therefore typically force objects to strand quirky case to ameliorate Anti-locality, which I assume forces the case morphology to be unpronounced without a nominal to host it.

The one exception appears to be ditransitive s-middles, where the object keeps its KP layer. This fact can be explained with the following two assumptions: 1) indirect objects can move across direct objects in Icelandic, and 2) middle morphology can act as a high facilitator (as seen in Figure 16).

- (37) Ditransitive s-middles (Sigurðsson 1989: 260)
- a. Pétur bauð mér vinnu.
 Petur offered me.DAT job.ACC
 ‘Peter offered me a job.’

¹³ This raises the question of why objects cannot strand their KP's in passives. One possibility is that deletion of morphology is dispreferred unless necessary. We will see this again in ditransitive s-middles, where a KP is again pronounced obligatorily when it is possible to pied-pipe it all the way to subject position.

- b. Mér bauð-st vinna.
 me.DAT offered-MID job.NOM
 ‘I got the opportunity to get a job.’

Recall that Deal’s (2019) analysis of Nez Perce prohibits movement of an applicative argument to Spec *vP* due to Anti-locality (the applicative argument is above any viable adverbs that might license this movement step). Indeed her proposal appears to be right

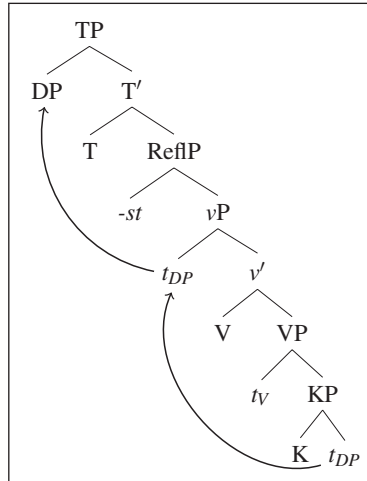

Figure 16: The KP layer must be stranded at some point to ameliorate Anti-locality. The reflexive projection licenses the other step.

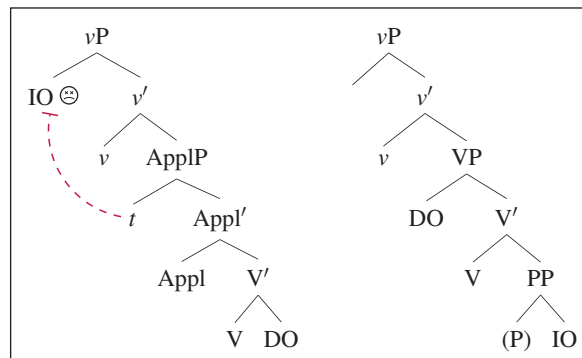

Figure 17: Ditransitive structure vs. Double Object Structure. The IO is too high in ditransitive structure, above any possible facilitators, and cannot move to Spec *vP*.

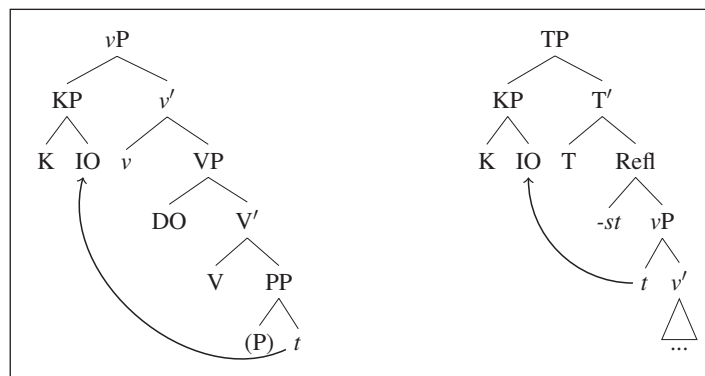

Figure 18: A derivation for Icelandic ditransitive s-middles in which the middle morphology is a high facilitator.

for English: **Libraries don't give books easily*. These Icelandic ditransitives, however, have been shown to be structurally ambiguous (Rezac 2001 and others), with the indirect object optionally lower than the direct object (Figure 17). This ambiguity may explain why Icelandic can move its indirect objects in s-middles but English can't.

The double object configuration, on the assumption that the indirect object can move across the direct object (potentially due to the fact that a) it is contained within a KP, and b) the direct object is in Spec VP, which is too high for any relevant facilitators), allows the indirect object to move with its KP to Spec vP without violating Anti-locality. The middle morphology then licenses the second step of the derivation (Figure 18).

Treating the middle morphology as a high facilitator correctly predicts that adding other high facilitators does not affect the case possibilities of the raised object in s-middles. This follows from an analysis in which the KP is used as a low facilitator. Whether or not there is negation in the second movement step does not change the fact that the KP must be stranded to get to Spec vP, thus yielding obligatorily nominative case on the raised object.

- (38) Halldór Sigurðsson (p.c.)
- a. Dyrnar læsa-st ekki.
the.doors.NOM lock-MID not
'The doors are not locking.'
 - b. Dyrnar ættu að læsa-st.
the.doors.NOM ought to lock-MID
'The doors should be locking.'

A complicating factor for this analysis is that adding a low adverb does not permit the preservation of dative case on the raised object. This is a surprise in light of the ditransitive example, where extra structure allowed the raised object to retain dative case. However, according to Halldór Sigurðsson (p.c.), adding the adverb also degrades the structure; the corresponding tough construction is preferable to the s-middle construction (e.g. *the doors are easy to lock*).

- (39) ?Dyrnar læsa-st auðveldlega.
the.doors.NOM lock-MID easy
'The doors are locking easily.'

To the extent that manner adverbs are acceptable in these constructions, they pose a problem for the idea that quirky case is only stranded in structurally impoverished contexts. However, the fact that this example is already degraded suggests that there may be independent factors at play. The preference for nominative in this example is certainly puzzling, but the status of the adverb in this example may also deserve some scrutiny. A broader study of Icelandic adverbs in these constructions may bear on these results, which I leave to future research.

To summarize, while in passives the object can move across the *by*-phrase to avoid an Anti-locality violation, s-middles do not project this structure, thus limiting the object's options for movement. Thus they are forced to use their quirky case layer as intervening structure, which they strand on their way to subject position. In the presence of a ditransitive clause, the object pied pipes its quirky case shell because the ditransitive provides an extra overt XP layer around the DP to strand. If the object has no choice but to strand quirky case, the case morphology becomes null without a phonological word to host it. Related discussion of overt PP's in s-middles can be found in appendix A.

4 The effects of head movement

Recall my formulation of Anti-locality (repeated here in (9) and (10)). I proposed that head movement reduces other movement possibilities by reducing the number of unique heads in a clause.

- (9) **Anti-locality, revised:** A moving constituent α must cross a constituent distinct from the closest X^0 that c-commands it.
- (10) **Crossing:** Movement from a position α to a position β crosses a constituent γ iff γ asymmetrically c-commands α but not β .

This proposal is reminiscent of Baker's Government Transparency Corollary (Baker 1988: 64), according to which "a lexical category which has an item incorporated into it governs everything which the incorporated item governed in its original structural position". In the context of Baker (1988), this meant that if a head assigned a theta role to an argument, and then moved to a higher head, that higher head could also share the theta index of the argument.

One possible motivation for Anti-locality constraints is the idea that movement must create a new relationship between a head and a moving constituent. Following Baker, if head movement extends the government domain of a particular head, head movement should feed Anti-locality violations by making it more difficult for an object to escape the domain of its governor.

This proposal also dovetails with work that describes head movement as a copying and lowering process (Arregi & Pietraszko 2018; Harizanov & Gribanova 2018). On this view of head movement, the resulting complex head is reflected on both nodes, which collapses the logical structure of the tree to that of one phrase with the label $X + Y$.

To summarize, what is important to the analysis presented in this paper is that if X moves to Y , and X was the closest element that c-commanded an object ZP , then Y no longer counts as something distinct from X that c-commands ZP . In other words, head-movement creates elements that are not distinct in the relevant sense from the moving head. However, other phrases merged in XP or YP that do not participate in the head movement chain (i.e. specifiers or adjuncts) may still ameliorate Anti-locality.

Aside from this feature, this formulation of Anti-locality is much like Abels' and Erlewine's (without reference to specific base positions of the moving constituent). Note, however, that this definition of crossing differs from Erlewine's slightly because he references dominance rather than c-command. On his definition of crossing, adverbs must project on the clausal spine (Cinque 1999) to ameliorate Anti-locality. The present definition is agnostic about the correct representation of adverbs.

If we take this idea seriously that head movement expands the domain relevant to Anti-locality, we make a prediction that auxiliaries and modals on their own shouldn't be appropriate facilitators for s-middles, since they move to T in English. We explore this prediction in 4.1 and 4.2.

4.1 Auxiliary verbs

Thus far we have primarily focused on negation as a high facilitator. Modals were also claimed to be high facilitators, but no mention was made of auxiliary verbs. Investigation of auxiliary verbs reveals that perfect *have* does not license s-middles on its own, but progressive *be* gives different results for different speakers, ranging from ungrammatical to marginally acceptable.

- (40) a. *The bread has cut, now the feast may begin!
- b. %?Please wait, your bread is cutting.

This contrast between the perfect and the progressive does not stem from an independent ban on the perfect in s-middles; examples with an additional facilitator or auxiliary verb improve the perfect s-middles.

- (41) a. The bread has cut smoothly in the past, so it should now.
- b. The bread hasn't cut well today, so we should get a better knife.
- c. ?It's been a good week, the bread has been cutting!
- d. ?The bread must have cut.

Blocking movement of *have* with an infinitive (on the assumption that *to* is an instance of T) is also enough to license the s-middle. Context: our feast is delayed because the bread is frozen and can't be cut. Some time later, we see that the feast has finally begun so someone says...

- (42) The bread seems to have cut.

In summary, the presence of *have* does not affect the well-formed-ness of a s-middle at all. It is perfectly acceptable in a s-middle, provided that there is additional facilitation or something blocking movement of *have* to T. This behavior is exactly what we expect for a high facilitator that undergoes head movement to T (Figure 19).

The same explanation extends to the progressive for speakers who find the progressive an equally bad high facilitator as the perfect. By moving to T, *be* feeds an Anti-locality violation when the object tries to move to Spec TP and thus fails to license a s-middle. However, the fact that some speakers accept the progressive as a high facilitator on its own should be explained. For these speakers, progressive *be* is also certainly acting as a high facilitator, and not a low one, because it fails to license a s-middle for a verb like *photograph*.

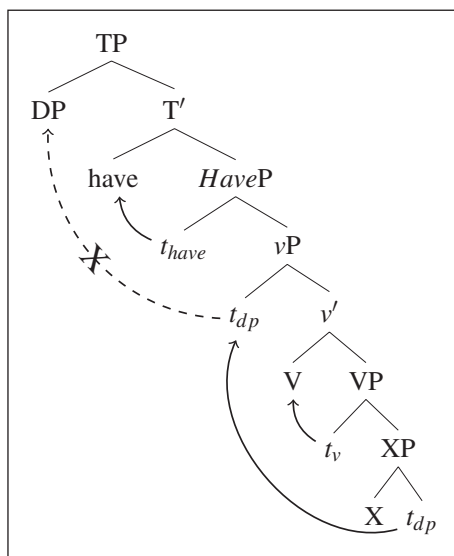

Figure 19: When *have* is the only facilitator present, the DP must strand its XP in the first movement step to avoid an Anti-locality violation. This now-bare DP cannot avoid an Anti-locality violation in the second step because *have* moves to T.

- (43) *Be* is a high facilitator like negation
- a. This landscape photographs nicely.
 - b. *This landscape doesn't photograph.
 - c. *Look, the landscape is photographing.

It would therefore seem that speakers who accept the progressive as a lone high facilitator have a version of the progressive that is structurally richer than the perfect. Biclausal analyses of the progressive have indeed been proposed for languages with aspectually conditioned split ergativity (Laka 2006; Coon 2013a; b; Coon & Preminger 2017). These analyses have a locative component in the progressive that takes a nominalized VP complement (Figure 20).

If this is a viable structure for the progressive, it would straightforwardly account for the contrast between the perfect and progressive for speakers that have it. However, if we want to pursue this line of reasoning, we would want to understand why some speakers posit a biclausal structure for the progressive while others do not, and look for other dialectal differences that should pattern with a particular choice of progressive. I leave this as a topic for future research.

To conclude, the behavior of auxiliary verbs in s-middles can be understood on the present analysis given our assumptions about the interaction between head movement and Anti-locality. Modals, however, are puzzling because they seem able to facilitate s-middle formation, despite moving to T from a position higher than *have*.

4.2 Modals

Close inspection of the modals that do and do not license s-middles supports a claim from Fagan (1992) that an underlying ability reading is a crucial component of these derivations. Fagan's observation is that many s-middles can be paraphrased with an ability modal.

- (44) Blue sheets wash easily. (e.g. *Blue sheets can be easily washed.*)

Fagan ultimately generalizes this observation to claim that all true middles require such modality. In fact, however, an ability reading is not a necessary component of every s-middle that shows facilitation effects. For example, (45) has no obligatory ability interpretation and still requires the comparative to facilitate it. Context: two sheets were washed together, but one was rolled inside the other resulting in different levels of cleanliness.

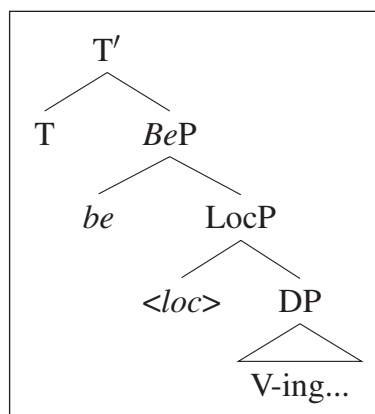

Figure 20: A biclausal structure for the progressive.

(45) Sheet # 1 washed better than sheet # 2.

Note that while it may be possible to imagine a context in which (45) has an ability reading, the present context allows us to interpret (45) without one: here the resulting levels of cleanliness differ due to the circumstances under which the sheets were washed and not necessarily due to any particular properties of the sheets themselves. We will see, however, that an ability reading becomes necessary when trying to facilitate a s-middle with a lone modal. I will therefore argue that modals on their own do not serve as high facilitators. However, modals *with an added ability reading* do seem to license s-middles, suggesting that this ability reading arises from the presence of a syntactic unit which serves as the relevant facilitator.

Let us look first at epistemic *should* and *must*. My previous examples with modality involve epistemic *should*. In a context where we are unsure about whether some loaf of bread will be cuttable, I can say,

(46) This bread should cut, I thawed it yesterday,

meaning something like *It should be the case that you will be able to cut this bread because it is no longer frozen*. Similarly, we can create a context for epistemic *must* as well. Imagine that you have never seen a pineapple in your life, but you have heard glowing reports about its taste. Many of your friends love to eat pineapple on a daily basis and make it sound very enjoyable and easy to do so. One day you see a pineapple for the first time and think to yourself,

(47) Huh, pineapples must peel I guess.

The paraphrase is something like, *it must be the case that one peels/can peel pineapples because I can't imagine anyone enjoying eating that spiny exterior*. We see for both epistemic *should* and *must* that the readings include an ability interpretation. By contrast if we change the context to avoid an ability reading, the sentences become much stranger.

New context: you see freshly peeled pineapples every Wednesday morning at the grocery store, but you never see them fresh on any other day. You also know that nobody works before opening time on Wednesdays so the only time the pineapples could have been peeled is Tuesday evening. You conclude,

(48) #Pineapples must peel on Tuesday evenings.

If this sentence is to mean anything, it can only have an unaccusative-like reading in which pineapples are self-peeling, unlike the standard middle interpretations that contain an implied external argument. The infelicity of this sentence in a context that avoids an ability reading shows that the ability reading is a necessary component of s-middle facilitation by epistemic modals. However if we insert a standard low facilitator, this sentence can be rescued.

(49) Pineapples must peel most conveniently on Tuesday evenings, otherwise we might expect to see freshly peeled pineapples on other days.

In summary, when we see an epistemic modal appearing to act as a lone facilitator, it must also be the case that there is a corresponding ability reading. This ability reading is what facilitates object movement rather than the modal, because the modal moves to T

and fails to ameliorate Anti-locality on its own. If there are other facilitators present (e.g. low adverbs), the ability reading is no longer necessary.

Looking at teleological *should* and *must* shows a similar contrast on the basis of available ability readings.¹⁴ Imagine that we are producers of a TV show discussing props, and product placement is essential to get sponsorship from advertisers. In particular we have a sponsor that makes fine bread knives so it is essential that we have cuttable bread in the show so the bread knife can be featured (as opposed to plastic bread loaf props). We might say,

- (50) In this show, bread should/must cut because we need the protagonist to feature our sponsors' bread knife.

By contrast in a context that emphasizes a non-ability reading, we get infelicity. Imagine now that we are bakery owners trying to reduce the amount of time we spend cleaning up bread crumbs. We therefore relegate all bread-cutting to one corner of a room to minimize the spread of crumbs. We then declare,

- (51) #Bread should/must cut in this corner so crumbs don't get everywhere.

However if we add other facilitators (with the appropriate context), the s-middle becomes felicitous. Important to note is that *quickly* here can refer to the speed at which the bread gets cut, and need not reflect on the capacity of the bread to be cut quickly.

- (52) Bread must cut quickly at all times in this restaurant so customers don't get impatient.

In summary, the teleological modals show the same pattern as the epistemic modals, namely that they are only felicitous in a context with an ability reading in the absence of other facilitators.¹⁵ This suggests that the ability reading has a syntactic representation that counts for Anti-locality.

A remaining puzzle is the fact that the ability reading cannot rescue just any s-middle, e.g. **this bread cuts/*this bread has cut*. This can be explained if the ability reading is a covert ability modal (Figure 21). I propose that while standard English does not overtly pronounce double modals (though several varieties do), modals can optionally select for covert ability modals. A covert ability modal on its own wouldn't be a high facilitator if it moves to T, but one that is introduced by another modal would.

We can see that the covert modal is always the lower of the two (i.e. it should not be the highest verb of the modal/auxiliary complex), because the higher modal moves to T and realizes tense and agreement. Since auxiliaries/root verbs are never higher than modals, a null modal must not be appearing with any inflected *have/be/root*, which explains why an ability reading can't rescue sentences like *the bread cuts* (Figure 22).

We might wonder why the second modal always has an ability interpretation in these contexts. A relevant observation is that dialects of English with double modal constructions differ in which modals may be the second one. Additionally, there seems to be a

¹⁴ Deontic contexts, or contexts in which there is obligation placed on an agent, are ungrammatical in s-middle formation because there are no agents. For example, if I want my brother not to peel the pineapple before I get home from work, I couldn't say **That pineapple must not peel until I get home* to mean that he must not peel it.

¹⁵ The future modal *will* seems to pattern like *should/must* in these respects, and the straight ability modal *can* also appears to be acceptable, though the contexts need to be richer. In this section I focus on the easier contexts with the intention of giving readers an idea of possible future lines of inquiry.

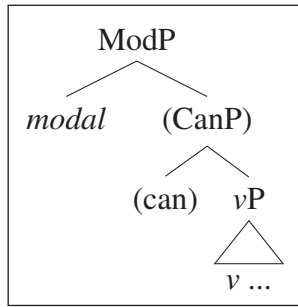

Figure 21: Proposed structure for a modal with an ability reading as a double modal construction where the second modal is covert.

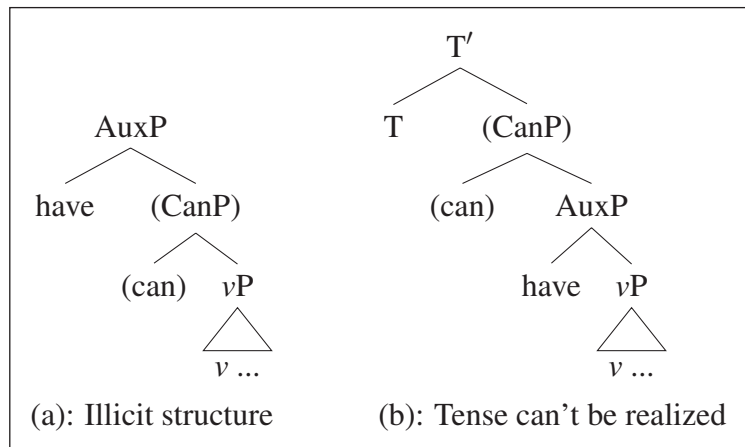

Figure 22: Covert ability modals may only co-occur with overt modals.

directionality amongst modals in this position. According to a 2016 study by Novich i Moré, every dialect of English with double modals allows an ability modal (*can, could*) as the second modal, but not every dialect allows other modals there (e.g. *should, will, etc*) (Table 1).

Similarly, the two modals in a double modal construction appear to be sensitive to each other. While some modals can appear before any type of modal, others can only appear before ability modals, even in a dialect that allows many types of modals in second position (Table 2).

In summary, this paper’s proposal that ability interpretations are covert ability modals is consistent with empirical findings on double modal constructions, which show the second modal to most likely be *can/could* rather than *should/will/etc*.¹⁶ Having explored the predictions of the theory in the domain of s-middle formation, we now address implications for unaccusatives.

¹⁶ A prediction of this theory is that the second modal in principle shouldn’t have to be *can* to license a s-middle (in a dialect that would allow the second modal to be something other than *can*). For example, speakers of a double modal dialect that allow *might should*, should be able to utter (i) without an ability interpretation.

- (i) The potatoes might should peel tomorrow.
→ The potatoes should get peeled tomorrow.

An avenue for future research is to derive this tendency for languages to prefer ability modals as the second modal of a double modal construction. Investigation about other sources of modality in s-middles can be found in Appendix B.

Table 1: Comparison of two UK dialects with double modal (DM) constructions (Novich i More 2016, based on Kortmann et al. 2004).

	SCOTLAND	NORTH OF ENGLAND
DECLARATIVE	might could	might could
	might can	will can
	might would	would could
	might should	
	will can	
	would could	
NEGATIVE	would never could	would no could
	might no could	mustn't could
INTERROGATIVE	Will... can?	

Table 2: Comparison of different DM combinations in Southern US English (Novich i More 2016).

might can	must can	may can
might could	must could	may could
might should		may will
might will		may should
might would		

5 Unaccusatives

We have compared the behavior of two A-movement constructions (namely passives and s-middles), and seen how their structural differences can predict their sensitivity to facilitators. I now address how unaccusatives fit into this account. Unaccusatives have not been shown to require facilitators, despite the fact that they are also structurally impoverished compared to the passive.

- (53) a. Gromit arrived.
 b. The ship sank.
 c. The flower grew.

Recall that passives and s-middles were argued to have analogous derivations; the object raises to Spec ν P and then to Spec TP. Their facilitation requirements were then predicted to be different purely due to their structural differences; passives have a *by*-phrase and a VoiceP but s-middles do not. Unaccusatives should be structurally closer to s-middles than passives given their lack of an external argument and inability to host passive morphology. Their lack of facilitation requirements therefore suggests that they are derivationally different from s-middles. I argue that while unaccusatives may look structurally similar to s-middles, unaccusative ν lacks the property that triggers movement of internal arguments to its edge (contra Legate 2003). Therefore, objects of unaccusatives move to Spec TP in one fell swoop (Figure 23).

I have presupposed the existence of an unaccusative ν (though the analysis would work just as well without one) largely due to data like that in (54), which repeat the adverb tests from section 2. The flexibility in verb-adverb ordering is argued to indicate optional verb movement to a higher head (note that this behavior stands in contrast with s-middles, where verb movement to a higher head was obligatory).

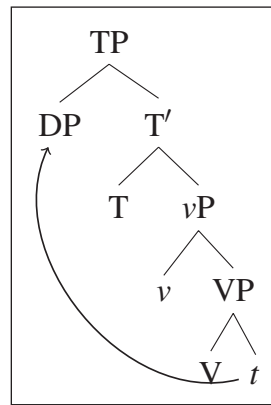

Figure 23: A proposed derivation for unaccusatives.

- (54)
- a. The soap slid quickly across the floor.
 - b. The soap quickly slid across the floor.
 - c. The lamp unassumingly sat on the shelf.
 - d. The lamp sat unassumingly on the shelf.

Throughout the paper, I have been regarding v as the locus of transitive structure, i.e. the head that introduces the external argument. A version of my claims about the structure and derivation of s-middles is that s-middles have a v layer that is logically transitive, but selects for a specifier that is internally, rather than externally merged. In other words, transitive v can either select for an external argument or have an EPP property, where these two options yield active/passive clauses and s-middles respectively. In that vein, I propose that the head above unaccusative verbs that we observed in (54) is unlike transitive v , in that it neither selects for an external argument, nor has such an EPP property, *because* having either of these requirements for a nominal specifier is reserved for v heads that have transitive semantics.

This derivation of unaccusatives predicts their lack of facilitation effects straightforwardly in English. However, given my proposal that head movement feeds Anti-locality, we might worry about a language like French that has uniform V to T movement (presumably through v). This would require facilitation to license movement of the complement of V to Spec TP (Figure 24).

While some French unaccusatives do have a reflexive clitic (Zribi-Hertz 1987, etc.) that could ameliorate Anti-locality, others do not, thus showing that French unaccusatives don't necessarily require facilitation. Following the logic of this paper, the fact that French verb movement does not trigger a need for facilitation in unaccusatives but English auxiliary movement does so in s-middles would suggest either structural differences between them or that head movement has different properties in the two languages. The latter approach has independent support from literature on head movement.

Early approaches to V to T movement argue that rich subject agreement on the finite verb conditions V to T movement in a language, an approach called the Rich Agreement Hypothesis (RAH) (Kosmeijer 1986; Platzack & Holmberg 1989; Pollock 1989; Holmberg & Platzack 1991; 1995; Roberts 1993; Rohrbacher 1994; Bobaljik 1995; Vikner 1995; 1997; Bobaljik & Thráinsson 1998; Koenenman 2000; Koenenman & Zeijlstra 2014, and others). Such proposals attribute obligatory V to T in French but a lack of V to T in English to parametric variation in the richness of each language's *Infl* node. Though specific analyses differ in how exactly the morphology relates to displacement of the verb in French, the conclusion is that French subjects move across more structure than English subjects do,

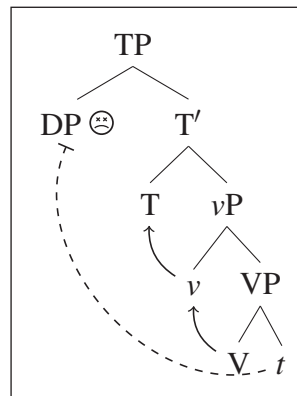

Figure 24: V to T movement blocks object movement.

and this structure is responsible for obligatory V to T movement in French. For example, in Koenenman & Zeijlstra (2014), the French verb moves to a head (called Arg⁰) lower than T, meaning the subject moves across both this head and T when raising to subject position. English does not uniformly require verbs to move to T and so is argued not to have this structure.

While the success of the RAH has been debated, recent work by Harizanov & Gribanova (2018) captures the difference between English and French in a similar way by distinguishing genuine syntactic head movement from post-syntactic word-building operations. On their analysis of French and English head movement, auxiliary movement to T in English occurs in the syntax, but V to T in French is purely a word building process derived by post-syntactic raising. This proposal directly characterizes the observation that not all head displacement operations correspond to morphological changes on a head. Their resulting typology places pronunciation of inflectional features on *v* in English but on T in French, which has V to T in French derived entirely by post-syntactic processes, but auxiliary movement in English as a two step process, 1) syntactic head movement followed by, 2) post-syntactic word formation.

What these accounts have in common is that head movement in French is more tightly connected to the morphology than auxiliary movement in English is. Whether this result is derived by additional structure in the syntax or a difference in the pronunciation rules of each language, V to T movement in French is not expected to feed Anti-locality as auxiliary movement in English does.

Adopting either of these approaches would require clarification on the status of V to *v* movement in English, which was shown to be obligatory in s-middle formation but optional otherwise. Movement from V to *v* was previously assumed to occur in the syntax, which is why low facilitation is needed for s-middle formation with some verbs. According to Harizanov and Gribanova's approach, V to *v* movement generally might be a word-building operation between a category-less root and a verbalizing head, which would suggest that it is purely morphological and shouldn't affect Anti-locality. However, given the optionality of V to *v* in non-middle clauses, we may conclude that the morphology cares little about the linear placement of the verb within *v*P. Therefore, when we see obligatory movement (i.e. in s-middles), it must be for some syntactic reason. This approach would explain why obligatory verb movement affects facilitation in s-middles, but leaves open the possibility that it would not create a need for facilitation in clauses where V to *v* movement is optional.

While the field has yet to settle definitively on why English and French V to T movement have different properties, these two mainstream approaches are consistent with the formulation of Anti-locality and head movement adopted in this paper. This paper's

analysis is therefore able to predict the observed differences in passives, unaccusatives, and s-middles in English and French, provided that the assumptions we make about head movement are analogous to either of those just outlined.

6 Revisiting previous work on middles

The analysis presented here is a departure from previous literature about facilitation effects in middles, which has focused on claimed correlations between facilitation effects and semantic properties of these constructions. For example, Condoravdi (1989) argues that middles are inherently generic and therefore involve quantification over events by a generic operator. The generic operator, she says, requires an adverb, modal, or negation in the nuclear scope to provide a predicate for the event variable in the restrictor. Only verbs with the right kind of eventive structure can combine with a generic operator that quantifies over events, thus explaining both the predicate restrictions and facilitation effects that we see in middles.

Fagan (1988) agrees that properties of middles are related to genericity but suggests that there is generic quantification over implicit agents, and that the facilitators are required for language-specific subcategorization rules. Both of these analyses take as a premise the idea that middle formation is dependent on a generic operator, whose requirements explain the properties of middles we observe.

On a definition of “middle” that requires genericity, these analyses are attractive because they can explain a language’s need for facilitators in light of the semantics of that language’s middle construction. However, the facts that I have described in this paper show a much more general pattern of facilitation effects that appears to extend beyond the meanings commonly attributed to “middles”. Firstly, many of my examples (even in English) were not generic and didn’t contain the kind of modality expected to appear in middles. Secondly, I showed that the *position* of these facilitators is important in a way that previous semantic accounts are ill-equipped to explain.

The fact that the facilitation requirement is three-fold, (some verbs strictly require low facilitators, some accept both high/low, and some require both), is not explained under an analysis that just depends on the existence of a single, semantically defined facilitator.

However, one of the reasons that genericity is assumed to be tightly correlated with middle formation is that some languages with a perfective/imperfective morphological distinction are claimed to restrict s-middles to imperfective aspect (Condoravdi 1989). If this generalization held, it would lend itself better to theories that tie facilitators to semantic requirements.

(55) *French* (Keny Chatain, p.c.)

- a. Le papier se lavait.
the paper REFL wash.PST.IPFV
‘It used to be that one washed this paper.’
- b. #Le papier s’est lavé.
the paper REFL-BE.PFV wash.PST.PFV
‘The paper washed itself.’ (animate paper taking a bath)

I argue that an account of imperfective requirements in s-middles that depends on genericity is untenable for two reasons. Firstly, languages with imperfective s-middles can also have episodic ones (Ackema & Schoorlemmer 2006 with examples from Zribi-Hertz 1982). These data show that generic interpretations are not required for French s-middles as long as the aspectual requirement is satisfied.

- (56) Zribi-Hertz (1982: 349)
- a. La question se traite actuellement à l'Assemblée.
the issue REFL discusses now in Parliament
'The issue is being discussed now in the National Assembly.'
 - b. Les vivres se distribueront tout à l'heure au premier étage.
the victuals REFL distributes all at the-hour on-the first floor
'The food will be distributed in a while on the first floor.'

Secondly, Spanish, though closely related and similarly rich in imperfective morphology, has neither a genericity requirement nor a need for imperfective aspect in its s-middles, making its s-middle almost indistinguishable from passives in terms of aspectual or facilitation requirements. This shows that it is not a universal requirement for s-middles to have imperfective morphology, even in languages that have it overtly.

- (57) *Spanish* (Naomi Feldman, p.c.)
Este edificio se construyo en el año 1800.
this building REFL build.PFV in the year 1800
'This building was built in 1800.'

Given these results, it seems plausible that genericity is not an intrinsic property of s-middle formation in any language, but rather a by-product of the types of facilitators and aspectual environments available to these structures. The analysis presented in this paper offers an account of the distribution of facilitators, but leaves unexplained the relationship between s-middles and imperfective aspect in languages that have one. Nonetheless, this paper has motivated a need to re-carve the set of facts that we should unite under a single analysis of facilitation in middles. What I argue to be common across languages' s-middles is a lack of structure compared to their corresponding passives, rather than a universal semantic interpretation. This view captures the idiosyncratic behavior of facilitation requirements within and across languages as derived from structural configurations in different predicates and languages. If this is right, the same should be true for aspectual requirements, namely that they are derived from other language-specific properties.

6.1 *Unergative analyses of middles*

The analysis of facilitation effects as a response to constraints on movement additionally bears on a debated aspect of s-middles, namely the origin of the surface subject. Throughout this paper, I have motivated an analysis of s-middles in which the surface subject moves from the complement of V. As seen in sections 2 and 3, this analysis captures positional requirements on facilitators and sensitivity to different types of verb-complement structures in s-middle formation.

However, some researchers have argued that at least for some languages, the surface subject of a s-middle is actually base-generated in external argument position (henceforth *unergative* analyses of s-middles). Unergative analyses of s-middles have faced criticism for being UTAH-violating. If the subject of a s-middle were base generated as an external argument, middle verbs would be unusual in assigning to external arguments the theta roles that they would normally assign to an internal argument. Similarly, the present view of s-middles as the quasi-unaccusative variant in a transitivity alternation makes their sensitivity to different verb-complement structures seem natural. However, if we were to regard the subjects of s-middles as external arguments of an intransitive verb, many of the

facilitation facts and sensitivity to different verbal predicates seen in this paper would be wholly unexpected.

That being said, there are some puzzling facts in s-middle formation that could arguably support an unergative theory of s-middles that should be explained. Lekakou (2005) shows that languages differ in whether s-middles fail the relevant unaccusativity diagnostics. Romance languages and Greek are argued to have subjects that start as internal arguments, but German, Dutch, and English s-middles are supposed to be unergative. I will argue that tests for unergativity in German, Dutch, and English do not reliably track the origin of the surface subjects in these languages' s-middles.

German and Dutch s-middles have been shown to pattern with unergatives for two prominent unaccusativity diagnostics (and other, more controversial tests): auxiliary selection and the availability of past participles as attributive modifiers. Like unergatives and unlike unaccusatives, s-middles in both languages select the *have* auxiliary verb. Likewise, past participles cannot act as prenominal modifiers for unergative or s-middle subjects, while they can for unaccusative subjects and the objects of transitives.

First regarding auxiliary selection, the fact that s-middles choose the *have* auxiliary in these languages is indeed puzzling, and I do not have much to say that can illuminate the matter. Instead I refer the reader to debate regarding the many irregularities in auxiliary selection in both languages (discussion can be found in Lieber & Baayen 1997; Hoekstra 1999; Sorace 2000 and many others). Ackema & Schoorlemmer (1995) acknowledge that auxiliary selection may not be a decisive test for the origin of the surface subject due to debate about whether auxiliary selection reflects semantic or syntactic properties of the construction. However, I will more explicitly argue against the use of past participles to motivate unergative s-middles in these languages. The presence of adverbs and reflexive pronouns in the test will be shown to be confounding factors.

Whether a past participle of a verb can be used as a prenominal modifier has been argued to track whether the nominal is an internal or external argument of the verb. As seen in (58), the past participle of unaccusative verbs, but not unergative verbs, can form prenominal modifiers. The examples in (58) are German but the same is true for Dutch.

- (58) *German*
- a. das zerbrochene Stock
the break.PART stick
'the broken stick'
 - b. *das gesungene Kind
the sing.PART child
intended: 'the sung child'

The past participle of a transitive verb like *read* can likewise modify its internal argument, unless it is used as a middle verb (distinguished by the presence of a reflexive pronoun). In this sense, s-middles have been argued to pattern like unergatives, or else we would have expected the past participle of a middle verb to be able to modify its subject.

- (59) *German*
- a. Transitive
ein gelesenes Buch
a read.PART book
'a read book'

- b. Middle
 *ein sich leicht gelesenes Buch
 a REFL easy read.PART book
 intended: ‘an easily read book’

A problem for this test is the fact that French *s*-middles also fail this unaccusativity diagnostic, despite the fact that French *s*-middles have been otherwise argued to generate subjects as internal arguments (on the basis of auxiliary selection and other movement diagnostics, see Lekakou 2005). In fact, it appears to be a general property of reflexive verbs in French that their past participles cannot modify nominals. For an optionally reflexive verb *break*, while *break* can generally form a past participle modifier, *SE-break* cannot, irrespective of the presence of an adverb (Keny Chatain, p.c.).

- (60) *French*
 a. la branche cassée
 the branch broken
 ‘the broken branch’
 b. *la branche se cassée (facilement)
 the branch REFL broken (easily)
 intended: ‘the (easily) broken branch’

It therefore appears that the presence of the reflexive in German *s*-middles may likewise compromise the reliability of this unaccusativity test. The ungrammaticality of (59b) could just as likely be attributed the presence of *sich* as the origin of *Buch*.

Dutch *s*-middles do not have a reflexive pronoun or any other distinctive morphology, so it avoids the confound introduced by the reflexive argument in German. However, this makes it very difficult (if even possible) to distinguish the past participle of a middle verb from the past participle of a regular transitive verb. Indeed the analysis proposed in this paper assumes middle verbs and transitive verbs to be identical in all relevant respects to this unaccusativity diagnostic.

On a narrower definition of *middle*, namely one in which middles have a fixed interpretation, previous attempts to test the unaccusativity of middles using past participles typically include an adverb that licenses middles. Determining whether past participles can modify middle subjects amounts to investigating whether examples like (61) can have the “middle”-interpretation.

The argument is as follows: a full middle clause may have an ability interpretation, i.e. *the bread cuts easily* might mean something like *the bread can be cut easily*. The “middle” construction may be defined by this interpretation, which is somehow intrinsic to the morphosyntactic form of the verb and accompanying adverb. Whether or not the middle interpretation arises when the verb is a past participle modifier may reveal the underlying valency of such a verb when it participates in the middle alternation.

The Dutch example in (61) is reported to lack an ability interpretation when the verb is in its past participle form (represented as a * here). One conclusion we might draw from this is that the ability reading is unavailable because subjects of middles (and perhaps by extension, *s*-middles) are like subjects of unergatives.

- (61) *Dutch* (Ackema & Schoorlemmer 1995: 191)
 het makkelijk snijdende/*gesneden vlees
 the easily cutting/*cut meat

However, this is not the only possible conclusion one might draw from this example. There are other differences between a full tensed clause and the modified DP in (61) (for instance, a tensed clause contains functional projections that a bare participle presumably lacks), which makes this experiment somewhat uncontrolled. The fact that (61) lacks a particular interpretation may or may not tell us anything about the valency of verbs that form s-middles, but might instead raise the interesting but distinct question, *why can't (61) mean all of the things that a s-middle can?*

Recall that the theory advanced throughout this paper argues against the notion that s-middle formation is dependent on an ability interpretation. On this view, the result in (61) couldn't resolve the question of where the subjects of s-middles are introduced because s-middles are defined as a clausal phenomenon and cannot be independently observed at the level of a modified DP. The presence or absence of an ability reading in a s-middle is assumed to depend on the semantic contribution of the present functional heads (e.g. tense/aspect/modals/etc.) and any present adjuncts. Since (61) lacks many of the functional projections of a s-middle by definition, it is unsurprising that they will have different interpretations.

Reframing the result in (61) as a question about interpreting manner modification of participle modifiers may be fruitful for independent reasons. In German, manner adverbs generally can't modify past participles to begin with. The examples in (62) show that the adverb *easily* is already significantly degraded in unambiguously transitive uses of a past participle modifier. The gerundive form is preferred as seen in the contrast between (62c,d) (Kai von Fintel, p.c.). It therefore seems that the Dutch example in (61) might be independently affected by the interactions between adverbs and participles, and not an accurate reflection of the origin of the subject.

- (62) *German*: Transitive with 'easily'
- a. Past participle
 ??/* ein leicht gelesenes Buch
 a easy read.PART book
 intended: 'an easily read book'
 - b. Gerundive
 ein leicht zu lesendes Buch
 a easy to read.DES book
 'an easy to read book'

English doesn't have many clear unaccusativity diagnostics so arguments for an unergative analysis of s-middles rest primarily on independent tests for movement. Relevant tests probe whether s-middle formation can raise subjects that are thematically unrelated to the verb, such as ECM subjects and idiom chunks. It is argued that s-middles behave differently from passives on both points (examples taken from Ackema & Schoorlemmer 1995).

- (63) a. John was believed to be a fool.
 b. *John believes to be a fool easily.

- (64) a. Advantage has been taken of John by unscrupulous operators.
 b. *Advantage takes easily of naive customers.

Observe, however, that the ECM verb under consideration (and in other cited examples I could find) is stative, and is therefore independently ruled out in s-middle formation (*I

am believing John to be a fool). Non-stative ECM verbs are difficult to find, but some speakers appear to get a contrast between doubly facilitated *prove* and *believe* (controlling for potential competition from a subject control reading). A clearer phenomenon that may demonstrate movement in s-middles is the existence of preposition stranding pseudo-middles, which are discussed in Appendix A.1.

(65) ?% President Gromit won't prove/*believe to be guilty easily.

The idiom test is likewise confounded by the choice of a ditransitive idiom in (64). Ditransitive s-middles were shown to be independently degraded in section 3.2. There are, in fact, transitive idioms that can participate in s-middle formation. I conclude that the proposed tests for English may actually support a movement analysis over an unergative analysis of s-middles, when carefully constructed to consider other factors related to s-middle formation.

(66) a. The ice breaks easily when the participants are seasoned conversationalists.
b. ?(One's) appearances keep up easily when the stakes are high.

7 Conclusion

I have offered a perspective on facilitation requirements in which all languages in principle have the same needs regarding A-movement of objects in s-middles, passives, etc. The strategy by which a language chooses to form a s-middle, combined with other parameters in the language (such as the behavior of subjects in that language) determine the extent to which additional facilitators should be inserted. This stands in contrast with previous analyses and empirical claims that treat facilitation requirements as idiosyncratic with the particular semantics of a language's s-middle construction.

This work has typological appeal by refining questions regarding verb structure within and across languages, and the distribution of s-middle and passive constructions across languages. The analysis hinges in part on the notion that different verbs have different underlying relationships with their internal arguments. While this hypothesis is not new, the analysis in this paper provides a clear diagnostic for verbal structure in any given language based on the facilitation requirements observed for that predicate in a language's s-middle construction.

Additionally, I have presented s-middles as an impoverished form of the passive. In this sense we might predict directionality in whether a language has a s-middle construction. If a language has a passive,¹⁷ it by definition contains the machinery for a s-middle. Languages with s-middles, on the other hand, might not necessarily be expected to also have a passive. Buli was argued to be a language with a s-middle but no passive, lending some credence to this hypothesis. However, more systematic work on languages with and without passives is required to understand better what other factors are linked to the presence of passives and s-middles in a given language.

¹⁷ Possibly important is that all of the languages that I have looked at have had periphrastic passives, rather than morphological passives. A grey area regarding this prediction is Greek, which has a morphological passive, and whose "middle" purportedly has two realizations. Some have argued that Greek middles are structurally and morphologically identical to imperfective passives (Tsimpli 1989; Lekakou 2005, though there is debate about the acceptability of *by*-phrases), but others have noted some middles also have active morphology (Condoravdi 1989; Kakouriotis 1994). The presence of the latter type of middle verifies the prediction that Greek should have structurally distinct passives and s-middles, though both forms certainly deserve further scrutiny.

Lastly, the theory presented in this paper (along with Erlewine's) predicts that facilitation should always be an available strategy to ameliorate Anti-locality, provided the language/construction under consideration has appropriate facilitation strategies. There are, however, many more phenomena that have been argued to show Anti-locality effects (Abels 2003 explores many) than have been demonstrated to show sensitivity to facilitation. For some of these phenomena, facilitation effects may simply not have been discovered yet, or might be ruled out by independent features of the construction (e.g. movement occurs in a region where optional projections wouldn't normally appear). Other phenomena, however, might truly not be sensitive to facilitation; movement might simply be ruled out no matter what. In the latter case, this research program brings us to a general question, namely what is the space of constraints on internal merge?

If movement were only constrained by Anti-locality, the possibility that movement could be ruled out in a local region without sensitivity to the presence of facilitators would pose a problem to this theory. However, there is reason to suspect that Anti-locality is not the only constraint on movement. For example, one of Abels' arguments for Comp-to-Spec Anti-locality is the cross-linguistic generalization that a TP cannot move to Spec CP, stranding C. Likewise, Erlewine's Spec-to-Spec Anti-locality rules out a similar movement step, namely from Spec TP to Spec CP. However, only the latter phenomenon has been argued to show facilitation effects (Erlewine 2016; Brillman & Hirsch to appear). The former is simply always ruled out (thank you to an anonymous reviewer for pointing this out).

- (67) *TP-to-Spec CP insensitive to adverbs (based on Abels 2003: 10)
- a. Nobody thought that anything would happen.
 - b. *Anything would happen nobody thought that.
 - c. *Anything would happen nobody thought that at least within the next couple of weeks.

The fact that only one of these phenomena is affected by facilitation, but both involve movement in the same domain, suggests that Anti-locality is not the only constraint active in (67c). For example, there may be surface or prosodic constraints limiting what sorts of elements may appear at the edge of a phrase. We might therefore expect movement to be unable to strand certain elements, irrespective of whether the movement step was Anti-local.

Abbreviations

ACC = Accusative; DAT = Dative; DO = Direct Object; IO = Indirect Object; IPFV = Imperfective; MID = Middle morpheme; NEG = Negation; NOM = Nominative; PFV = Perfective; PART = Participle; PST = Past; PL = Plural; REFL = Reflexive

Additional File

The additional file for this article can be found as follows:

- **Appendices.** Additional investigation of facilitators and modality in middles. DOI: <https://doi.org/10.5334/gjgl.990.s1>

Acknowledgements

I would like to thank Neil Banerjee, Keny Chatain, Kai von Fintel, Edward Flemming, Sabine Iatridou, David Pesetsky, Norvin Richards, Abdul-Razak Sulemana, and three anonymous reviewers for their helpful comments and thorough discussion. I am addi-

tionally grateful to everyone who shared enthusiasm and intuitions about the data; there are too many of you to thank individually but please know that I deeply appreciate your patience and encouragement. All mistakes are my own.

Competing Interests

The author has no competing interests to declare.

References

- Abels, Klaus. 2003. *Successive cyclicity, anti-locality, and adposition stranding*. Storrs, CT: University of Connecticut dissertation.
- Ackema, Peter & Maaike Schoorlemmer. 1995. Middles and nonmovement. *Linguistic Inquiry* 26. 173–197.
- Ackema, Peter & Maaike Schoorlemmer. 2002. Middles. Ms. University of Nijmegen and University of Utrecht.
- Ackema, Peter & Maaike Schoorlemmer. 2006. Chapter 42: Middles. In Martin Everaert & Henk van Riemsdijk (eds.), *The Blackwell companion to syntax* 2. 131–203. Blackwell Publishing Ltd. DOI: <https://doi.org/10.1002/9780470996591.ch42>
- Arregi, Karlos & Asia Pietraszko. 2018. Generalized head movement. *Proceedings of the Linguistics Society of America Annual Meeting* 3(4). 1–15. DOI: <https://doi.org/10.3765/plsa.v3i1.4285>
- Authier, Jean-Marc & Lisa Reed. 1996. On the Canadian French middle. *Linguistic Inquiry* 27(3). 513–523.
- Baker, Mark. 1988. *Incorporation: A theory of grammatical function changing*. Chicago, IL: University of Chicago Press.
- Bittner, Maria & Kenneth Hale. 1996. The structural determination of case and agreement. *Linguistic Inquiry* 27(1). 1–68.
- Bobaljik, Jonathan. 1995. *Morphosyntax: The syntax of verbal inflection*. Cambridge, MA: MIT dissertation.
- Bobaljik, Jonathan & Höskuldur Thráinsson. 1998. Two heads aren't always better than one. *Syntax* 1. 37–71. DOI: <https://doi.org/10.1111/1467-9612.00003>
- Bošković, Željko. 2007. On the locality and motivation of move and agree: an even more minimal theory. *Linguistic Inquiry* 38(4). 589–644. DOI: <https://doi.org/10.1162/ling.2007.38.4.589>
- Bresnan, Joan. 1972. *Theory of complementation in english syntax*. Cambridge, MA: MIT dissertation.
- Brillman, Ruth & Aron Hirsch. to appear. An anti-locality account of English subject/non-subject asymmetries. *Proceedings of CLS 50*.
- Burzio, Luigi. 1986. *Italian syntax: A government-binding approach*. D. Reidel Publishing Company. DOI: <https://doi.org/10.1007/978-94-009-4522-7>
- Cinque, Guglielmo. 1988. On SI constructions and the theory of ARB. *Linguistic Inquiry* 19(4). 521–581.
- Cinque, Guglielmo. 1999. *Adverbs and functional heads*. Oxford University Press.
- Collins, Chris. 2005. A smuggling approach to the passive in English. *Syntax* 8(2). 81–120. DOI: <https://doi.org/10.1111/j.1467-9612.2005.00076.x>
- Condoravdi, Cleo. 1989. The middle, where semantics and morphology meet. *MIT Working Papers in Linguistics* 11. 16–30.
- Coon, Jessica. 2013a. *Aspects of split ergativity*. Oxford: Oxford University Press. DOI: <https://doi.org/10.1093/acprof:oso/9780199858743.001.0001>
- Coon, Jessica. 2013b. TAM split ergativity. *Language and Linguistics Compass* 7. 171–200. DOI: <https://doi.org/10.1111/lnc3.12025>

- Coon, Jessica & Omer Preminger. 2017. Split ergativity is not about ergativity. In Jessica Coon, Diane Massam & Lisa Travis (eds.), *The handbook of ergativity*, 226–252. Oxford: Oxford University Press. DOI: <https://doi.org/10.1093/oxfordhb/9780198739371.013.10>
- Culicover, Peter W. 1993. The adverb effect: Evidence against ECP accounts of the that-t effect. In Amy J. Schafer (ed.), *Proceedings of the north east linguistic society*, 97–111. University of Ottawa: Graduate Linguistic Student Association.
- Deal, Amy-Rose. 2019. Raising to ergative: Remarks on applicatives of unaccusatives. *Linguistic Inquiry* 50(2). 388–415. DOI: https://doi.org/10.1162/ling_a_00310
- Erlewine, Michael Yoshitaka. 2016. Anti-locality and optimality in Kaqchikel agent focus. *Natural Language & Linguistic Theory* 34(2). 429–479. DOI: <https://doi.org/10.1007/s11049-015-9310-z>
- Fagan, Sarah. 1988. The English middle. *Linguistic Inquiry* 19. 181–203.
- Fagan, Sarah. 1992. *The syntax and semantics of middle constructions*. Cambridge University Press.
- Fox, Danny & David Pesetsky. 2005. Cyclic linearization of syntactic structure. *Theoretical Linguistics, special issue on Object Shift in Scandinavian* 31. 1–46. DOI: <https://doi.org/10.1515/thli.2005.31.1-2.127>
- Grohmann, Kleanthes. 2003. *Prolific domains: On the anti-locality of movement dependencies*. John Benjamins. DOI: <https://doi.org/10.1075/la.66>
- Hale, Ken & Samuel Jay Keyser. 2002. *Prolegomenon to a theory of argument structure*. The MIT Press. DOI: <https://doi.org/10.7551/mitpress/5634.001.0001>
- Harizanov, Boris & Vera Gribova. 2018. Whither head movement? *Natural Language & Linguistic Theory* 37. 461–522. DOI: <https://doi.org/10.1007/s11049-018-9420-5>
- Hoekstra, Teun. 1988. Small clause results. *Lingua* 74. 101–139. DOI: [https://doi.org/10.1016/0024-3841\(88\)90056-3](https://doi.org/10.1016/0024-3841(88)90056-3)
- Hoekstra, Teun. 1999. Auxiliary selection in Dutch. *Natural Language & Linguistic Theory* 17(1). 67–84. DOI: <https://doi.org/10.1023/A:1006186109813>
- Holmberg, Anders & Christer Platzack. 1991. On the role of inflection in Scandinavian syntax. In Werner Abraham, Wim Kosmeijer & Eric Reuland (eds.), *Issues in Germanic syntax*, 118–179. Berlin/New York: Mouton de Gruyter.
- Holmberg, Anders & Christer Platzack. 1995. *The role of inflection in Scandinavian syntax*. Oxford: Oxford University Press.
- Hrafnbjargarson, Gunnar Hrafn. 2005. The voice of -ST. Ms. University of Tromsø.
- Kakouriotis, Thanos. 1994. Theta roles and middle constructions. *Proceedings of the 8th International Symposium of English and Greek* 279–304.
- Katz, Graham. 2003. Event arguments, adverb selection, and the stative adverb gap. In Ewald Lang, Claudia Maienborn & Cathrine Fabricius-Hansen (eds.), *Modifying adjuncts*, 455–474. Berlin/Boston: Mouton de Gruyter.
- Keyser, Samuel Jay & Thomas Roeper. 1984. On the middle and ergative constructions in English. *Linguistic Inquiry* 15(3). 381–416.
- Koenenman, Olaf. 2000. *The flexible nature of verb movement*. Utrecht: Utrecht University dissertation.
- Koenenman, Olaf & Hedde Zeijlstra. 2014. One law for the rich and another for the poor: The Rich Agreement Hypothesis rehabilitated. *Linguistic Inquiry* 45. 571–615. DOI: https://doi.org/10.1162/LING_a_00167
- Koizumi, Masatoshi. 1995. *Phrase structure in Minimalist syntax*. Cambridge, MA: MIT dissertation.
- Kosmeijer, Wim. 1986. The status of the finite inflection in Icelandic and Swedish. *Working Papers in Scandinavian Syntax* 26. 1–41.

- Laka, Itziar. 2006. Deriving split ergativity in the progressive. In Alana Johns, Diane Massam & Juvenal Ndayiragije (eds.), *Ergativity. studies in natural language and linguistic theory*, 173–195. Springer, Dordrecht. DOI: https://doi.org/10.1007/1-4020-4188-8_7
- Legate, Julie. 2003. Some interface properties of the phase. *Linguistic Inquiry* 34(3). 506–516. DOI: <https://doi.org/10.1162/ling.2003.34.3.506>
- Lekakou, Marika. 2005. *In the middle, somewhat elevated*. London: University College London dissertation.
- Levin, Beth. 1993. *English verb classes and alternations*. The University of Chicago Press.
- Lieber, Rochelle & Harald Baayen. 1997. A semantic principle of auxiliary selection in Dutch. *Natural Language & Linguistic Theory* 15. 789–845. DOI: <https://doi.org/10.1023/A:1005897301225>
- Marelj, Marijana. 2004. *Middles and argument structure across languages*. Utrecht: Utrecht University dissertation.
- Merchant, Jason. 2007. Voice and ellipsis. Ms. University of Chicago. <http://ling.auf.net/lingbuzz/000403>.
- Novich i Moré, Anna. 2016. *Double modals in the British Isles: Scotland and Northern England*. Barcelona: Universitat Autònoma de Barcelona BA thesis.
- Pesetsky, David. 2013. *Russian case morphology and the syntactic categories*. The MIT Press. DOI: <https://doi.org/10.7551/mitpress/9780262019729.001.0001>
- Platzack, Christer & Anders Holmberg. 1989. The role of AGR and finiteness. *Working Papers in Scandinavian Syntax* 44. 101–117.
- Pollock, Jean-Yves. 1989. Verb movement, Universal Grammar and the structure of IP. *Linguistic Inquiry* 20. 365–424.
- Pylkkänen, Liina. 2008. *Introducing arguments*. The MIT Press. DOI: <https://doi.org/10.7551/mitpress/9780262162548.001.0001>
- Ramchand, Gillian. 2008. *Verb meaning and the lexicon: A first phase syntax*. Cambridge University Press. DOI: <https://doi.org/10.1017/CBO9780511486319>
- Rezac, Milan. 2001. Case licensing and agreement in Icelandic ditransitive constructions. Ms.
- Rezac, Milan. 2008. What will you have, DP or NP? In Daniel Harbour, David Adger & Susana Béjar (eds.), *Phi theory: Phi-features across modules and interfaces*, 83–129. Oxford: Oxford University Press.
- Roberts, Ian. 1993. *Verbs and diachronic syntax*. Kluwer: Dordrecht.
- Rohrbacher, Bernhard. 1994. *The Germanic languages and the full paradigm*. Amherst, MA: University of Massachusetts dissertation.
- Rooth, Mats. 1985. *Association with focus*. Amherst, MA: University of Massachusetts dissertation.
- Schneider-Zioga, Patricia. 2007. Anti-agreement, anti-locality, and minimality. *Natural Language & Linguistic Theory* 25. 403–446. DOI: <https://doi.org/10.1007/s11049-006-9014-5>
- Sigurðsson, Halldór Ármann. 1989. *Verbal syntax and case in Icelandic: A comparative GB approach*. Lund: Lund University dissertation.
- Sorace, Antonella. 2000. Gradients in auxiliary selection with intransitive verbs. *Language* 76(4). 859–890. DOI: <https://doi.org/10.2307/417202>
- Stroik, Thomas. 1992. Middles and movement. *Linguistic Inquiry* 23. 127–137.
- Svenonius, Peter. 2006. Case alternations and the Icelandic passive and middle. In Satu Manninen, Diane Nelson, Katrin Hiietam, Elsi Kaiser & Virve Vihman (eds.), *Passives and impersonals in european languages*, John Benjamins.

- Thomason, Richard & Robert Stalnaker. 1973. A semantic theory of adverbs. *Linguistic Inquiry* 4. 195–220.
- Thráinsson, Höskuldur. 2007. *The syntax of Icelandic*. Cambridge: Cambridge University Press. DOI: <https://doi.org/10.1017/CBO9780511619441>
- Tsimpli, Ianthi. 1989. On the properties of the passive affix in Modern Greek. *UCL Working Papers in Linguistics* 1. 235–260.
- Vikner, Sten. 1995. *Verb movement and expletive subjects in the Germanic languages*. Oxford: Oxford University Press.
- Vikner, Sten. 1997. V to I movement and inflection for person in all tenses. In Liliane Haegeman (ed.), *The new comparative syntax*, London: Longman.
- Zribi-Hertz, Anne. 1982. The ‘middle-se’ construction in French and its status in the triad middle voice-passive-reflexive. *Linguisticae Investigationes* 6. 345–401. DOI: <https://doi.org/10.1075/li.6.2.05zri>
- Zribi-Hertz, Anne. 1987. La réflexivité ergative en français moderne. *Le Français Moderne* 55. 23–54.

How to cite this article: Newman, Elise. 2020. Facilitator effects in middles and more. *Glossa: a journal of general linguistics* 5(1): 62.1–40. DOI: <https://doi.org/10.5334/gjgl.990>

Submitted: 30 April 2019 **Accepted:** 11 March 2020 **Published:** 29 June 2020

Copyright: © 2020 The Author(s). This is an open-access article distributed under the terms of the Creative Commons Attribution 4.0 International License (CC-BY 4.0), which permits unrestricted use, distribution, and reproduction in any medium, provided the original author and source are credited. See <http://creativecommons.org/licenses/by/4.0/>.



Glossa: a journal of general linguistics is a peer-reviewed open access journal published by Ubiquity Press.

OPEN ACCESS 