

MASSACHUSETTS INSTITUTE OF TECHNOLOGY
HAYSTACK OBSERVATORY
WESTFORD, MASSACHUSETTS 01886
 July 27, 2011

Telephone: 781-981-5407
Fax: 781-981-0590

To: EDGES Group
 From: Alan E.E. Rogers and Delani Cele
 Subject: Tests of EDGES calibration at West Forks Maine

1] Introduction and set-up

On 8 July 2011 We took the EDGES to West Forks, ME. As in previous visits we parked in the field on Ballfield road off route 201. We deployed the antenna constructed of aluminum bars (instead of panels) for ease of transport and set-up. We used a wire grid ground plane made of 30 wires 20 feet long spaced 9" apart and oriented in the same direction as the antenna elements to which the balun was attached. The antenna was the same as used on a 14'x14' aluminum foil ground plane in earlier measurements of the impedance at Haystack. Unfortunately it was not practical to use a foil ground plane on the grass covered field.

Impedance (S11) measurements

We made several S11 measurements of the antenna on the wire grid using a VNA which we calibrated at the end of a long cable which was then attached to the output of the balun. Figure 1 shows the location of the antenna and Figure 2 shows the S11 magnitude and phase compared with previous measurements on the foil ground plane. The wire grid ground plane is shown in Figure 3.

2] Sky spectrum measurements

We made 2 sets of measurements. In the first we placed a 6.0 dB attenuator between the balun output and the EDGES antenna input and in the second we removed the attenuator and connected directly to EDGES. The second set turned out to be of limited use owing to the very strong RFI from the dominant FM station at 105.1 MHz.

3] Data analysis

Prior to visiting West Forks we calibrated the internal noise source using the hot noise source described in memo #73. The calibration corrections were placed in the software analysis program. The first stage of the reduction was to obtain the sky spectrum from the 3-position switching using

$$T_u(f) = \left[\frac{P_{sky}(f) - P_{load}(f)}{P_{cal}(f) - P_{load}(f)} \right] T_{cal}(f) + T_{load}$$

$P_{sky}(f)$ = power spectrum on the sky

$P_{load}(f)$ = Power spectrum on the load

$P_{cal}(f)$ = power spectrum on the load + cal

$T_{cal}(f)$ = internal calibration spectrum in K

T_{load} = ambient temperature of the load

$T_u(f)$ = temperature uncorrected for antenna, balun and attenuator

In addition, $T_u(f)$ is filtered using a sliding window to exclude frequency channels with RFI.

The second stage of processing is to apply corrections for the antennas mismatch, balun and attenuator loss. An approximate correction can be made using the following “wave model” relation.

$$T_u = T_{sky} \left(1 - |\Gamma|^2\right) L + T_{amb} (1 - L) + T_{amb} (1 - L) |\Gamma|^2 L$$

Where $L = 10^{-(L_g + L_b + L_a)/10}$

$$|\Gamma|^2 = 10^{-(L_r - L_b)/10}$$

L_g = ground loss ~0.2 dB

L_b = balun loss ~0.3 dB

L_a = attenuator = 6.0 dB

L_r = antenna return loss measured through balun in dB positive for loss
 $= -10 \log_{10} \left(|S_{11}|^2 \right)$

This expression ignores the following:

- 1] Noise from LNA
- 2] Balun mismatch
- 3] Antenna ohmic loss
- 4] LNA mismatch

A more accurate correction can be made using the circuit model of Figure 4. The noise voltages are proportional to the square root of the real part of the associated impedance and are added incoherently. z_f is the equivalent parallel impedance of the ferrite cores in the balun, R1 and R2 are the equivalent values of resistance for the “Tee” equivalent circuit of the 50 ohm attenuator. The reflected LNA noise and impedance of the LNA are estimated using the circuit model described in memo #62 and used the circuit model parameters determined from measurements of a low loss cable open at the end.

- 4] Comments on the wave vs circuit model

The wave model is a convenient wave of clearly showing the physics of the wave flow and results in a rigorous analysis for the “signal” flow using the scattering “S” matrix for various components like the balun and attenuator. The calculation of cascaded circuits is accomplished using the “T” matrix which can be obtained from the 2-port S matrix by relatively simple transformations.

The problem of the wave model arises when noise waves of different temperatures are considered since multiple reflections at the interfaces and noise generated with a lossy network require a series of iterations to achieve high accuracy. For example the thermal noise generated in an attenuator bounces back and forth between the mismatch at the antenna and the mismatch at the LNA. The circuit models are relatively simple at low frequencies and iterations are not needed and a different temperature can be associated with each source.

5] Results

The results of the analysis are given in table 1.

Figures 5, 6 and 7 show the corrected spectra and best fit for the approximate wave model, the circuit model and circuit model for observations without the 6 dB attenuator respectively.

Time range UT	Attenuation	Spectral index	T-50 MHz	Method
2011:189:16:11-17:15	6 dB	-2.53 ± 0.05	5000	wave
2011:189:16:11-17:15	6 dB	-2.53 ± 0.05	5554	circuit
2011:189:17:18-17:27	0 dB	-2.51 ± 0.05	5605	circuit

In the low frequency range the sky noise is much higher than the LNA noise so the differences in the values of spectral index determined by the approximate wave model are not much different from those determined by the circuit model. However, in order to detect or set limited on the EoR we need to strive for the highest accuracy. Currently the circuit model appears to be the best choice.



Figure 1. Location of EDGES antenna on Ballfield, Forks, ME. The active dipole was oriented along an azimuth of 30° . (Horizon is limited by trees which have a maximum elevation of 25° seen from the antenna.)

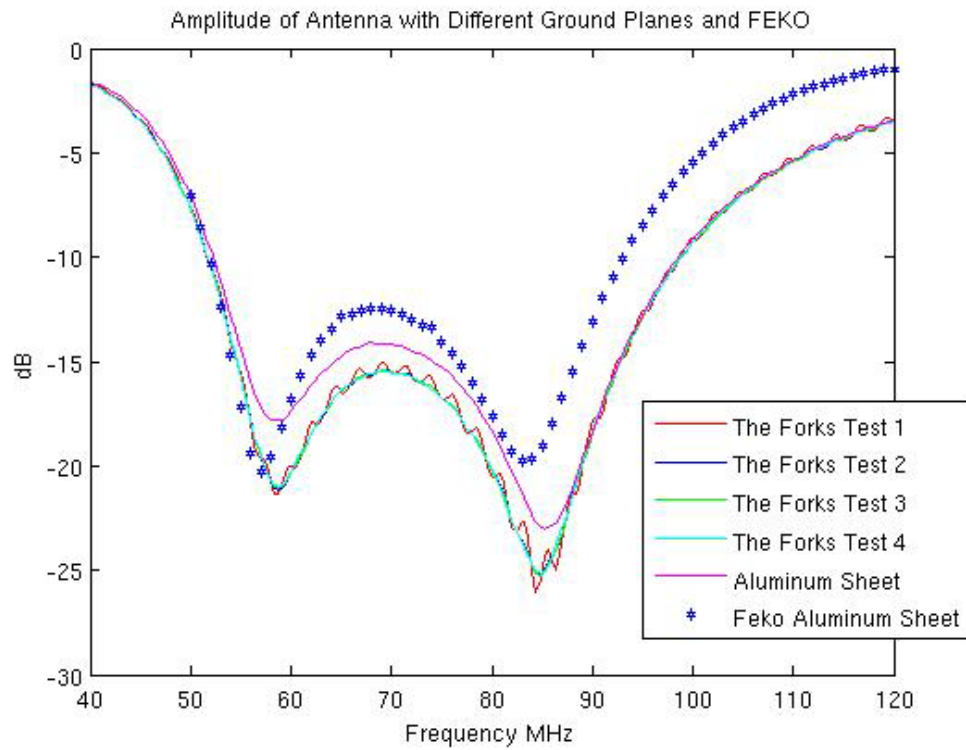

Figure 2A

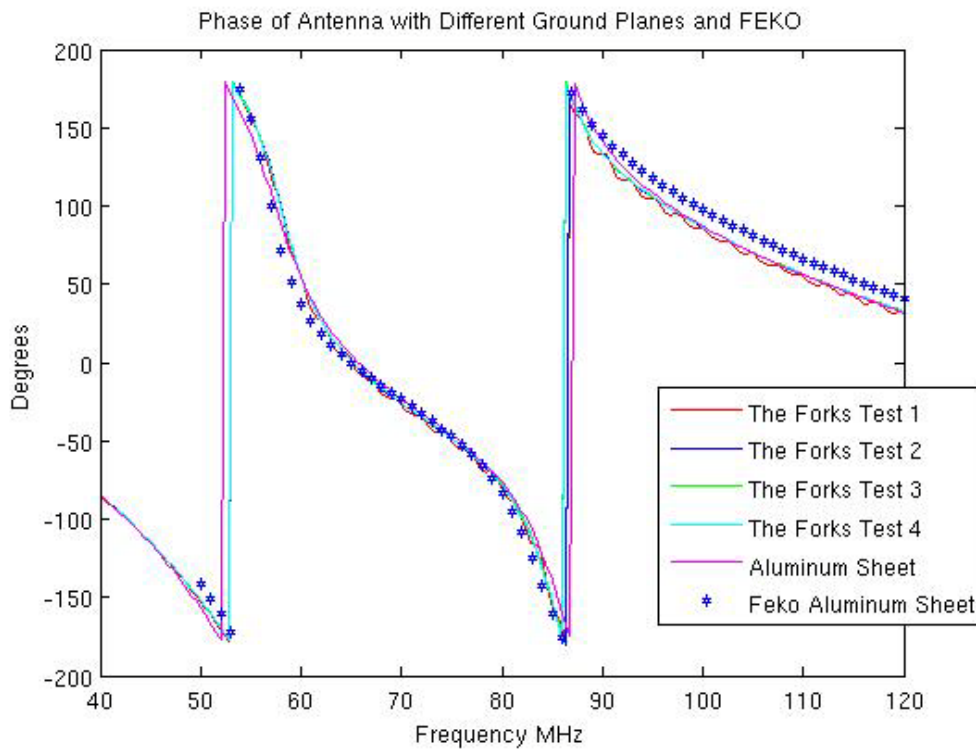

Figure 2B

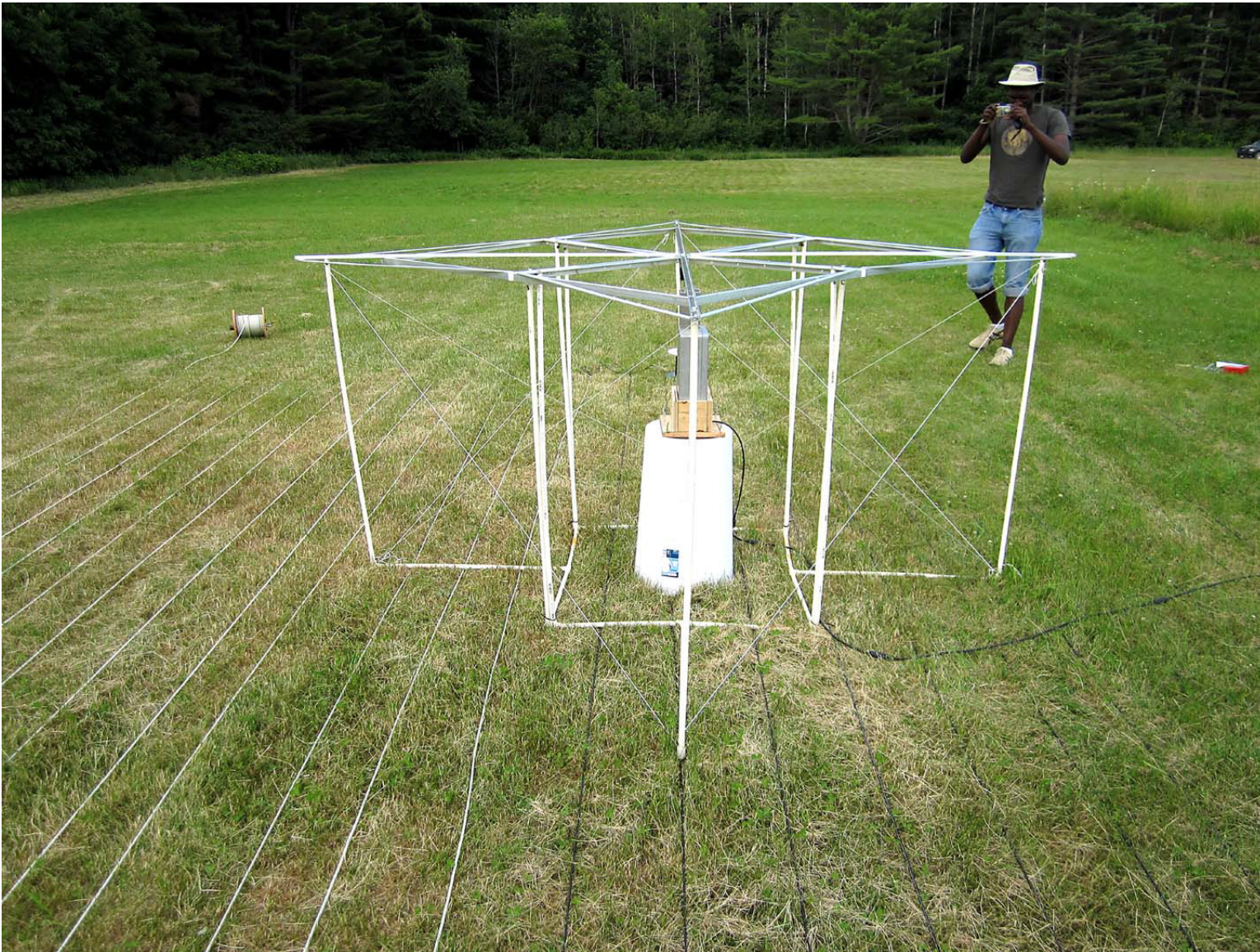
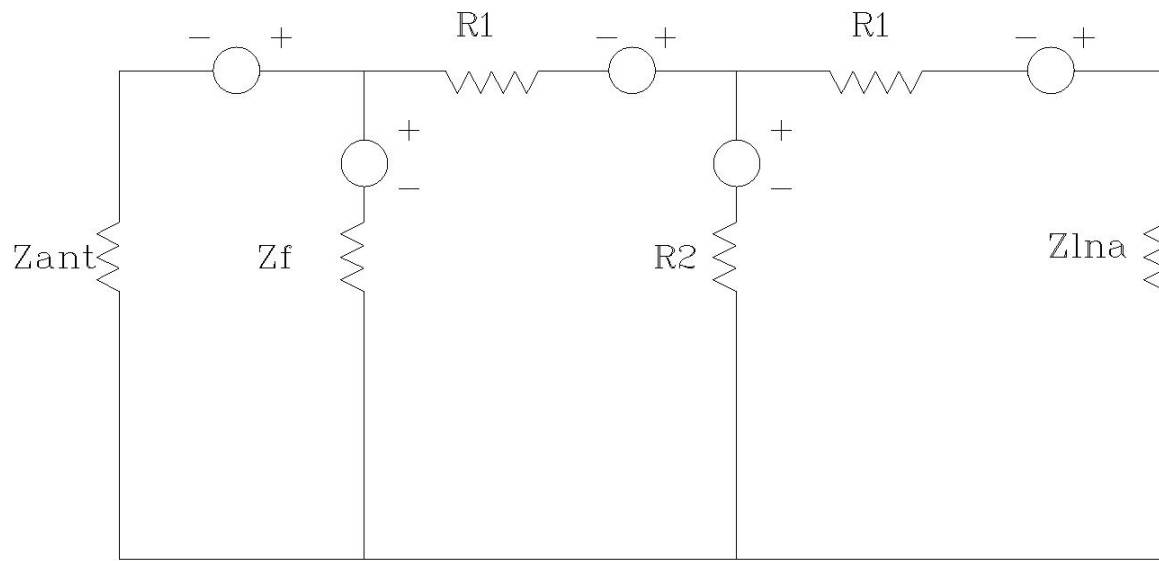

Figure 3. EDGES Antenna on wire grid ground plane.



Equivalent circuit of Antenna balun and attenuator noise

Figure 4.

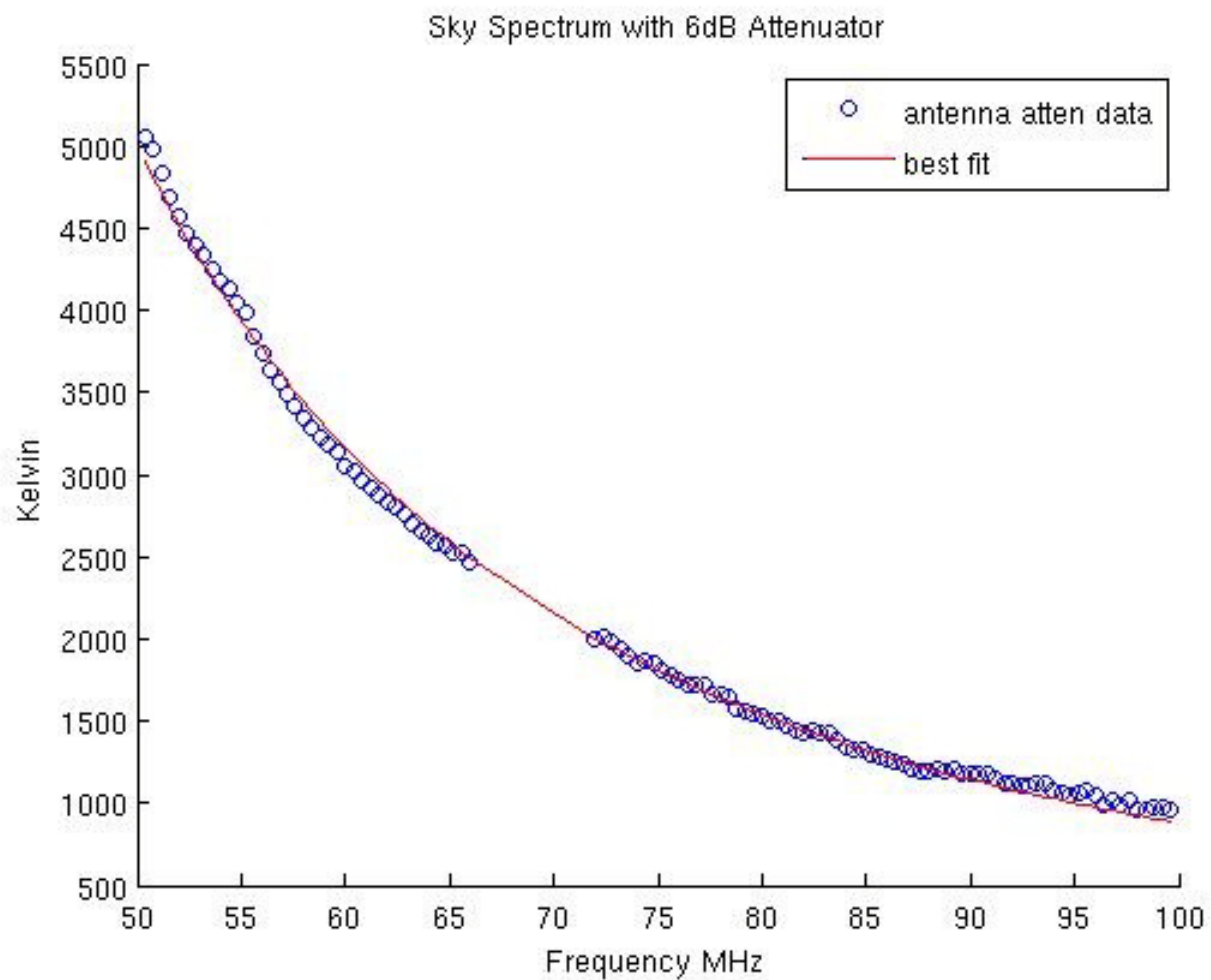

Figure 5. Data corrected using approximate wave model. Data points with RFI contamination are not shown.

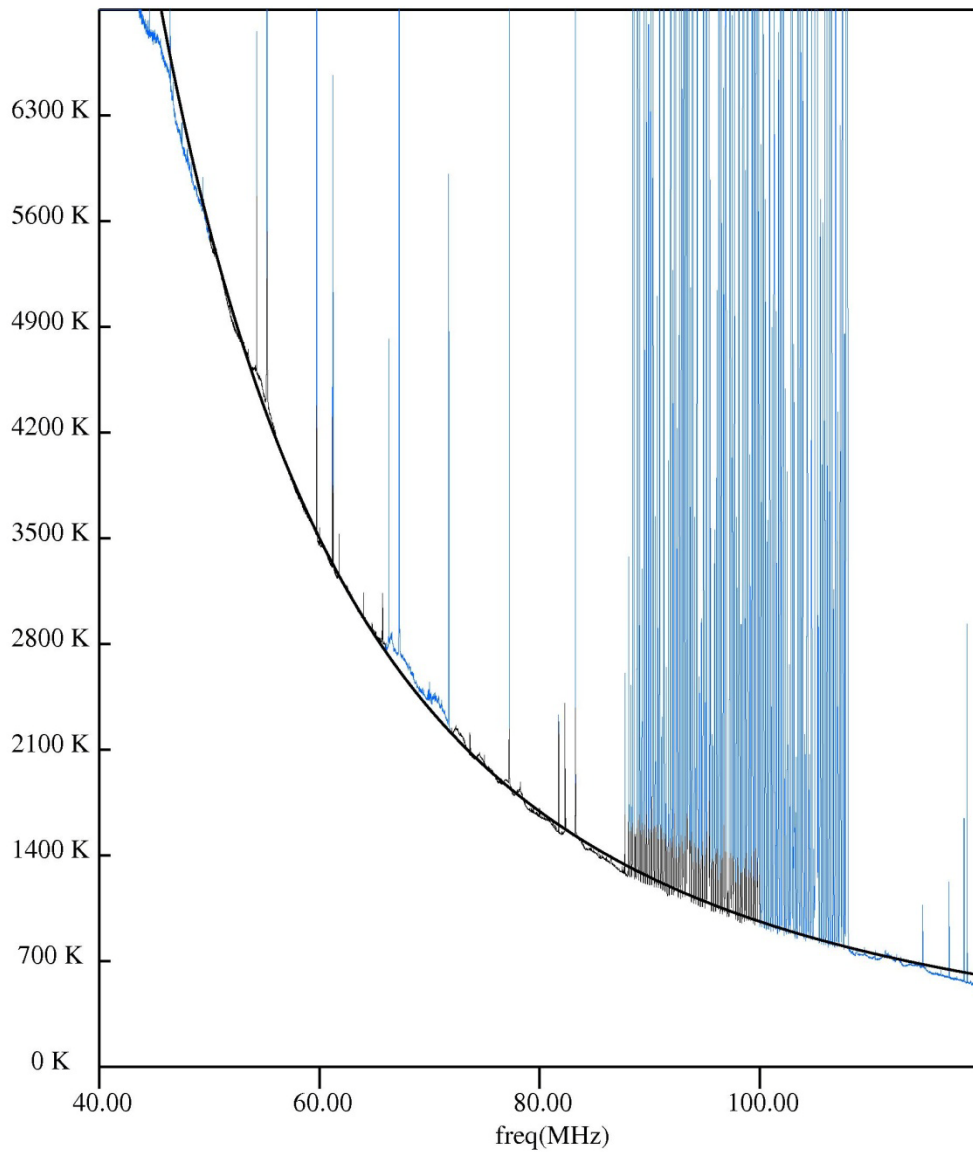

Figure 6. Data taken with 6 dB attenuation corrected using circuit model. Data contaminated with RFI or outside range of 50 to 100 MHz is plotted in blue. Data from 66 to 72 MHz is contaminated with ch 4 DTV

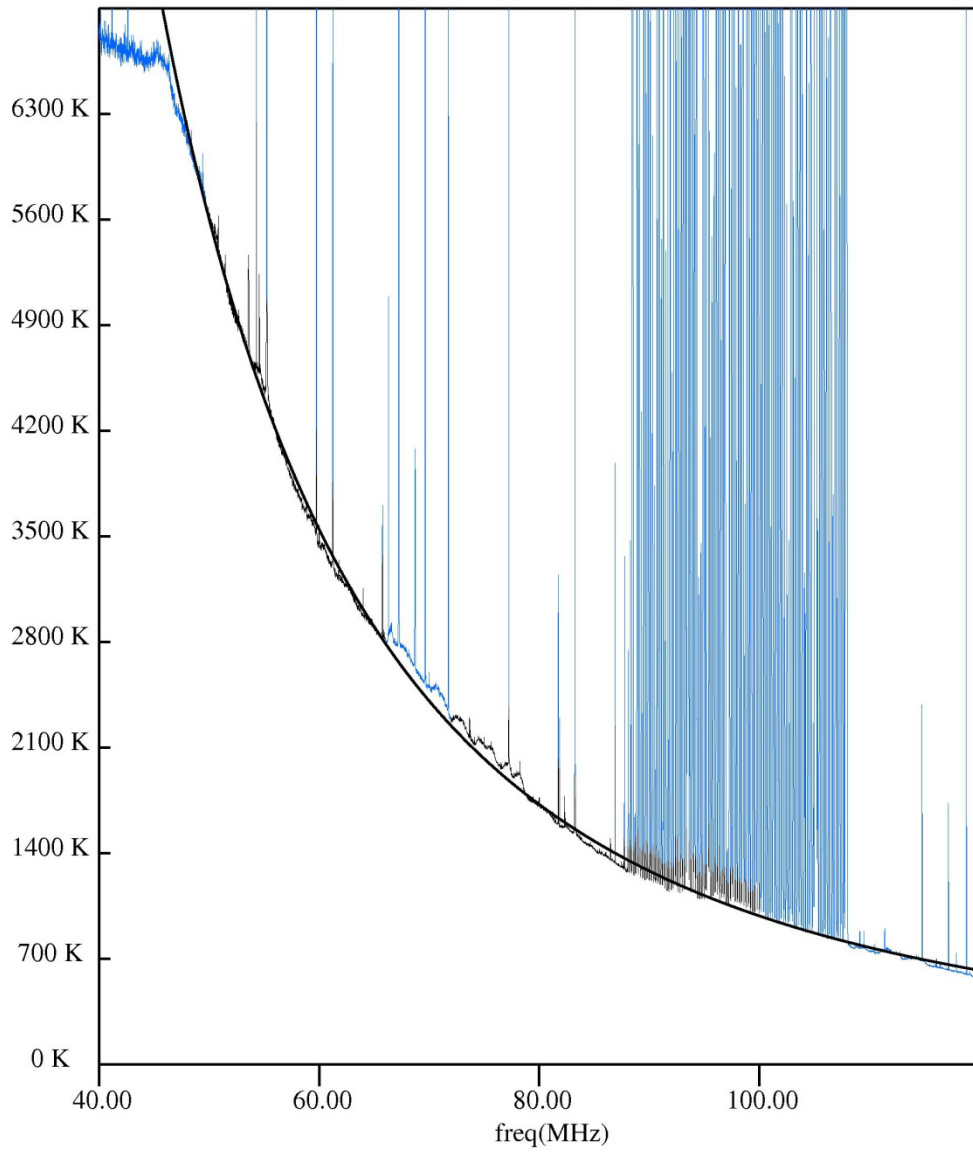

Figure 7. Data taken without 6 dB attenuator corrected using circuit model.