

Wm
Distel
1956

WEAR STUDIES OF ABRASIVE PARTICLES

by

JOSEPH WILLIAM DISTEL

B.M.E., Villanova University
(1955)

SUBMITTED IN PARTIAL FULFILLMENT
OF THE REQUIREMENTS FOR THE
DEGREE OF MASTER OF SCIENCE

at the

MASSACHUSETTS INSTITUTE OF TECHNOLOGY

May, 1956

Signature of Author Signature redacted
Department of
Mechanical Engineering

Certified by Signature redacted
Thesis Supervisor

Accepted by Signature redacted
Chairman, Departmental Committee
on Graduate Students

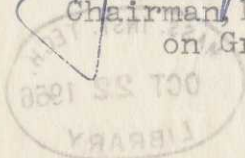

Mc
Thesis
1956

WEAR STUDIES OF ABRASIVE PARTICLES

by

JOSEPH WILLIAM DISTEL

B.M.E., Villanova University
(1952)

SUBMITTED IN PARTIAL FULFILLMENT
OF THE REQUIREMENTS FOR THE
DEGREE OF MASTER OF SCIENCE

at the

MASSACHUSETTS INSTITUTE OF TECHNOLOGY

May, 1956

Signature of Author
Department of
Mechanical Engineering
Joseph W. Distel

Certified by
Thesis supervisor
Arthur G. Cook

Accepted by
Departmental Committee
on Graduate Students
Joseph H. Keenan

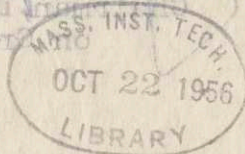

ABSTRACT

WEAR STUDIES OF ABRASIVE PARTICLES

by

Joseph William Distel

Submitted to the Department of Mechanical Engineering on May 21, 1956, in partial fulfillment of the requirements for the degree of Master of Science

A method is devised which enables single abrasive particles to be tested in a multiple fly cutting operation. A method of determining the grinding ratio for individual grit particles is formulated and experimental data are obtained to enable grinding ratio values to be calculated for several different work materials.

Two different types of abrasive material are tested and evaluated in grinding a variety of work materials. Build up of metal on the cutting elements, chip structure and formation, and extent of sparking which occurred are observed. Appreciable rewelding of chips is observed in grinding some metals (notably titanium and zirconium) and its effect is discussed.

Tests are conducted over a range of cutting speeds with one abrasive type and one work material. The effect of cutting velocity on abrasive wear is observed and discussed.

Thesis Supervisor:
Title:

Nathan H. Cook
Assistant Professor of
Mechanical Engineering

Eng. (M.S.) Oct. 22, 1956

ACKNOWLEDGMENTS

The author wishes to express his gratitude to Professor N. H. Cook and Professor M. C. Shaw for their advice and guidance which proved so helpful during the course of the work presented herein.

He also expresses his appreciation to the Carborundum Company, Niagara Falls, New York, for their support and cooperation in this project.

Finally, the author is deeply grateful to all the staff of the Machine Tool and Metal Cutting Laboratories for their technical advice and assistance in the preparation of materials and experimental apparatus used in the studies of this thesis.

TABLE OF CONTENTS

	Page
Abstract	2
Acknowledgments	3
Table of Contents	4
List of Figures and Tables	5
Introduction	6
Statement of Work	8
Previous Work on Single Abrasive Testing	9
Present Work	11
The Grinding Ratio	23
Test I The Grinding Ratio	27
Test II Wear Studies on Various Work Materials	29
Test III Single Abrasive Grinding at Various Speeds	30
Results:	
Test I	31
Test II	33
Test III	36
Determination of Standard Error	38
Visual Observations	41
Future Work	48
Bibliography	50
Appendix	51

LIST OF FIGURES AND TABLES

	Page
Figure 1. Single Grit Fly Cutter	10
Figure 2. Grit Holder Assembly	12
Figure 3. Abrasive Grits and Holders Prior to Mounting	13
Figure 4. Fly Cutter and Workpiece	15
Figure 5. Milling Machine and Fly Cutter	16
Figure 6. Alignment of Work with Indicator	17
Figure 7. Abrasive Grits Adjusted to Work Surface .	18
Figure 8. Parallel Tracks Being Cut on 1020 Steel .	20
Figure 9A. Typical Workpiece Showing Grinding Tracks	21
9B. Enlarged View of Taper Section of Workpiece	
Figure 10. Titanium and Steel Workpieces After Grinding	22
Figure 11A. 24-ST Aluminum Chips	44
11B. 1095 Steel Chips	
Figure 12A. Titanium Chips	45
12B. Zirconium Chips	
Figure 13A. Titanium Chips Showing Rewelding	46
13B. Titanium Chips Showing Rewelding	
Figure 14. Titanium Chips	47
Table 1. Operating Conditions for Test III	30
Table 2. Grinding Ratio Results (Test I)	31
Table 3. Results Test II	34
Table 4. Results Test III	34
Table 5. Determination of Standard Error	40

INTRODUCTION

Of all the commonly employed industrial methods of metal removal, the one which has received the least study and investigation is the grinding operation. The reasons for this lack of work both theoretical and practical in grinding as contrasted with other methods of metal removal become evident perhaps when we consider the fundamental differences between grinding operations and other metal cutting procedures.

Most metal cutting techniques such as turning, shaping, milling, broaching, drilling, reaming, and tapping, employ tools which consist of one, or a relatively small number of cutting edges, each with a fixed geometry and orientation with respect to the work material being cut. Grinding, in contrast, is an operation which employs a relatively large number of cutting elements having a random geometry and orientation. A further difference between the grinding operation and the other metal cutting techniques is that in the latter tool wear is not great in magnitude in comparison to the size of the whole cutting tool, and the geometry of cutting elements remains essentially fixed, while geometries of individual abrasive particles may vary greatly and appreciable wear of abrasive grits may be observed.

Fundamental research on grinding in the past has, with few exceptions, largely been directed to the study of the

grinding wheel itself.

The study presented here is concerned with an investigation of grinding characteristics from a consideration of single abrasive particles. Single abrasive particles are tested in a fly cutting operation and significant quantities, such as abrasive wear, metal removal and grinding ratio (volume of metal removed/volume of abrasive worn away) are observed and recorded.

STATEMENT OF WORK

A method is to be devised to enable measurements to be made on individual abrasive particles to determine wear of abrasive, volume of metal removed in cutting, and grinding ratio.

The values of the grinding ratio G , defined as the volume of metal removed divided by the volume of abrasive worn away are to be determined for an aluminum oxide abrasive type using a variety of different work materials.

Single abrasive particle wear studies using aluminum oxide will be made with titanium as the work material. Tests will be made at different cutting velocities in an attempt to determine the optimum cutting speed.

Abrasive wear will be studied for various abrasive materials and various work materials.

Information of the nature obtained by these tests is felt to be of importance in the evaluation of abrasive materials. Data obtained by the methods outlined in this paper is for abrasive materials only, and unlike grinding wheel data is not influenced by the nature of the bonding material or the wheel structure.

PREVIOUS WORK ON SINGLE ABRASIVE TESTING

Preliminary work on the study of individual abrasive grits was begun here at M.I.T. by Robert Reid (1)* during 1954. Reid's work consisted mainly of devising a method of holding individual grain particles for testing, and also some photographic studies of grit profiles showing the nature of wear which occurs during grinding.

The study of individual abrasive particles was continued during 1955 by John Cole (2). Cole improved Reid's method of mounting the abrasive grains and performed a series of tests to evaluate the wear properties of several different types of aluminum oxide abrasives. For these tests a single abrasive grain mounted in a 1/8" diameter rod was used as a fly cutter tool. (Figure 1). Wear of the abrasive was measured as the change in length of the grit as it passed across a 1-1/2" workpiece of 1020 steel. By this fly cutter method Cole was able to statistically separate abrasive materials of different wear characteristics.

In addition to the above work, a study of the behavior of particles in a grinding wheel has been made utilizing a motion picture camera and a stroboscopic light. (Reference 3). The light is synchronized to illuminate a small area of a grinding wheel once during each revolution. By photographing this area, a record of the wear and breakdown of the grains in the area is obtained.

*Numbers in parenthesis indicate entries in Bibliography.

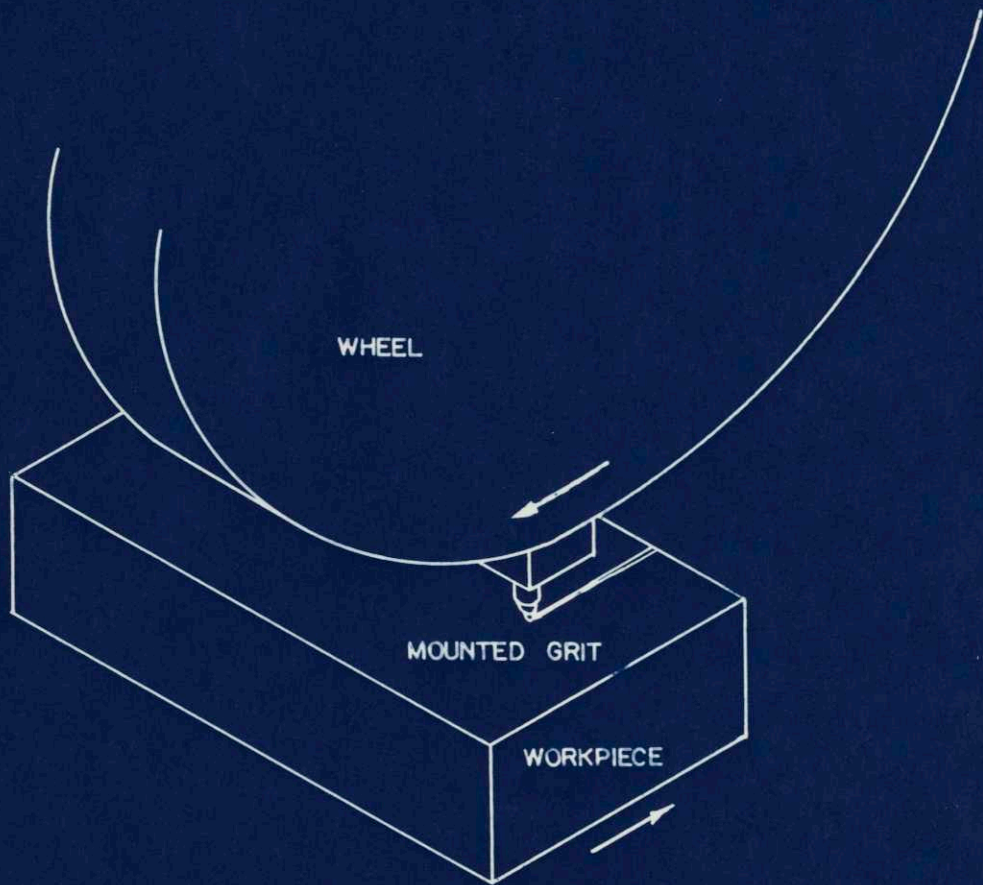

SINGLE GRIT FLY CUTTER

FIGURE 1

PRESENT WORK

For the present study it was desirable to devise a method of testing individual grits which would enable data to be obtained in greater quantity than previously possible with the single tool fly cutter; and if possible, yield more information about the behavior of the cutting grits.

For this purpose a multiple tool fly cutter was devised. (Figure 2). The multiple tool fly cutter is essentially a fixture which holds ten mounted abrasive grits in alignment for cutting. As in previous work, each grit is mounted in a 1/8" diameter rod. The grit holder is made by drilling a small (3/64") hole in the end of a 1/2" length of rod. The end of the rod is then turned to a point with a forming tool. Figure 3 is a photograph of the grit holders and abrasive particles prior to mounting.

Individual abrasive grits are mounted in the grit holder with a porcelain cement known commercially as "Insulate" and manufactured by Sauereisen Cements Company of Pittsburgh, Pennsylvania. This cement has given a satisfactory bond between tool socket and abrasive and outlasts the life of the abrasive. The cement resists all acids (except hydrofluoric), oil, electricity, most solvents and temperatures to 2000 degrees Fahrenheit. The cement may be treated with a dilute acid such as acetic acid to yield a water resistant surface. This last is an important consideration when water base

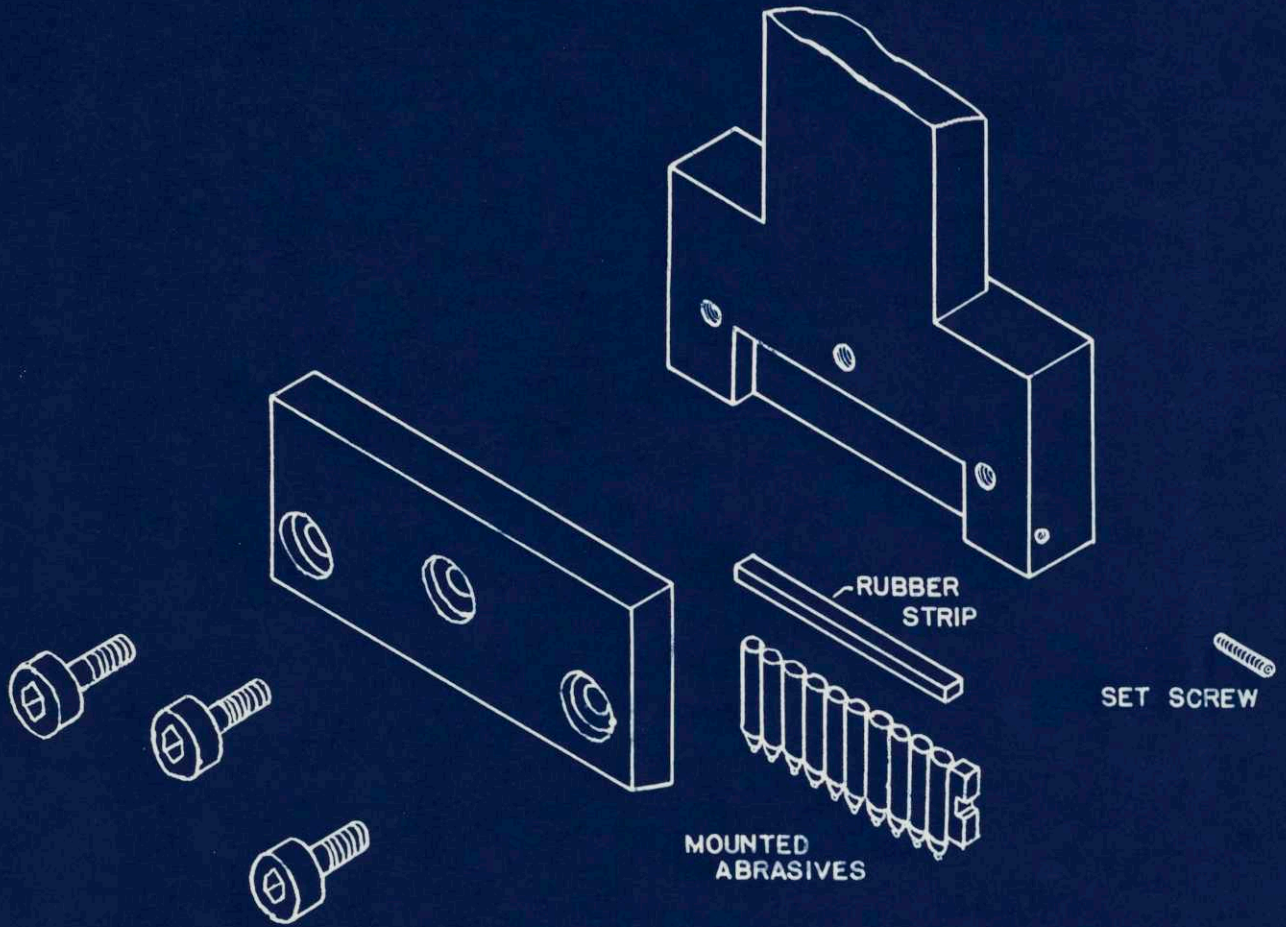

GRIT HOLDER ASSEMBLY

FIGURE 2

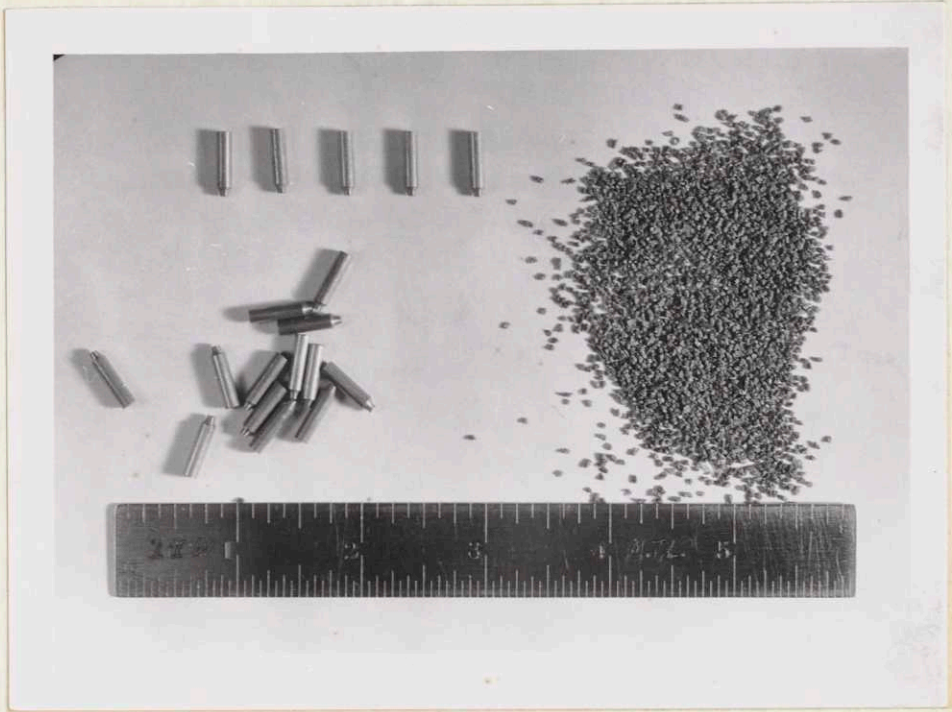

ABRASIVE GRITS AND HOLDERS PRIOR TO MOUNTING

FIGURE 3

cutting fluids are used with the cemented grits.

The multiple grit holder of Figure 2 enables ten mounted abrasive particles to be held in alignment and rigidly secured to the holder by means of four adjusting screws.

The grit holder was mounted on a five-inch diameter wheel to form a fly cutter, and the holder and wheel, as shown in Figure 4, were mounted on a Milwaukee Horizontal Milling Machine. The fly cutter and milling machine are shown in the photograph Figure 5.

The workpieces used in this study were prepared as shown in Figure 4. Each workpiece was ground to give a true surface. A taper section of angle $2^{\circ}52'$ was then ground at each edge of the workpiece thus giving a slope at each edge of the work of 1:20.

Typical test procedure was as follows: The workpiece was accurately aligned in the vise of the milling machine parallel with the direction of travel. This alignment was done by tracing the surface of the workpiece with a dial indicator. The slope of the initial and final taper sections was checked with the dial indicator also. After the work had been aligned, the tool holder with ten mounted abrasive grits was brought over the center of the workpiece and the ten rods were lowered by releasing the end set screw until they contacted the finished surface of the workpiece. The photograph Figure 7 shows the grits being lowered to the work surface. A rubber gasket fitted into the tool holder behind the mounting rods helped to insure good contact between abrasive grit and

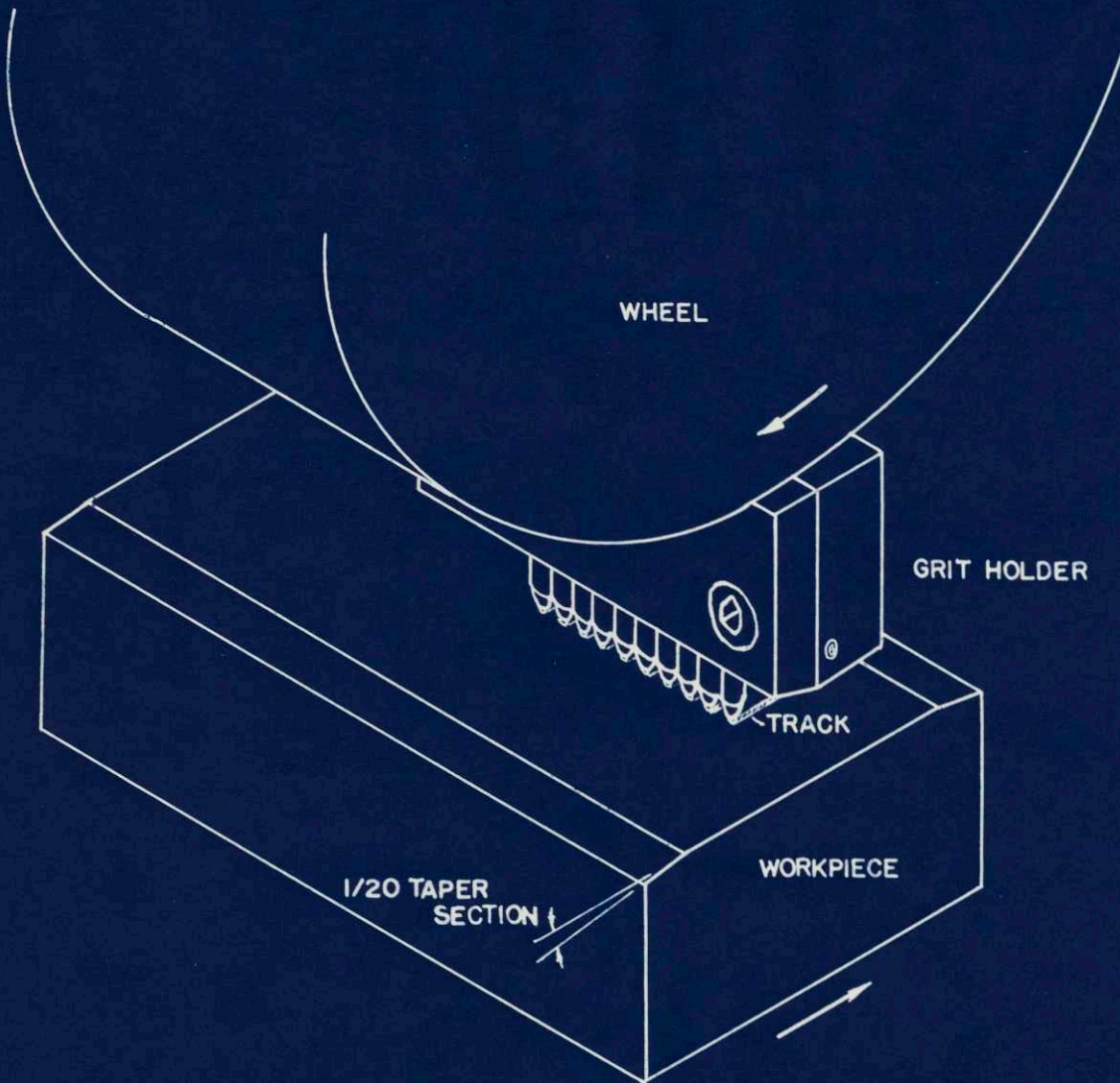

FLY CUTTER & WORKPIECE

FIGURE 4

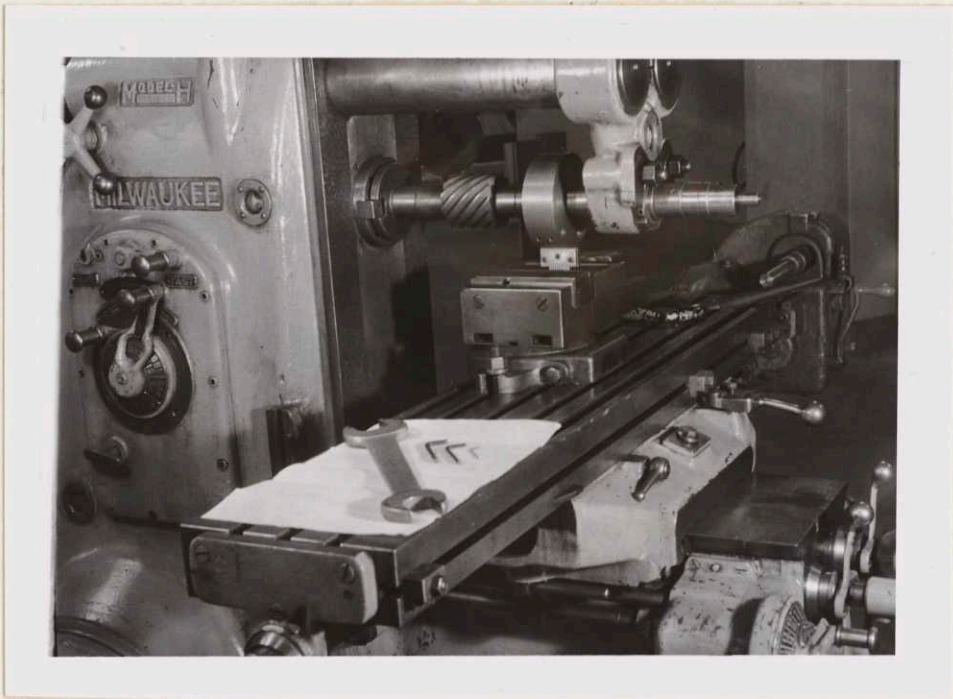

MILLING MACHINE AND FLY CUTTER

FIGURE 5

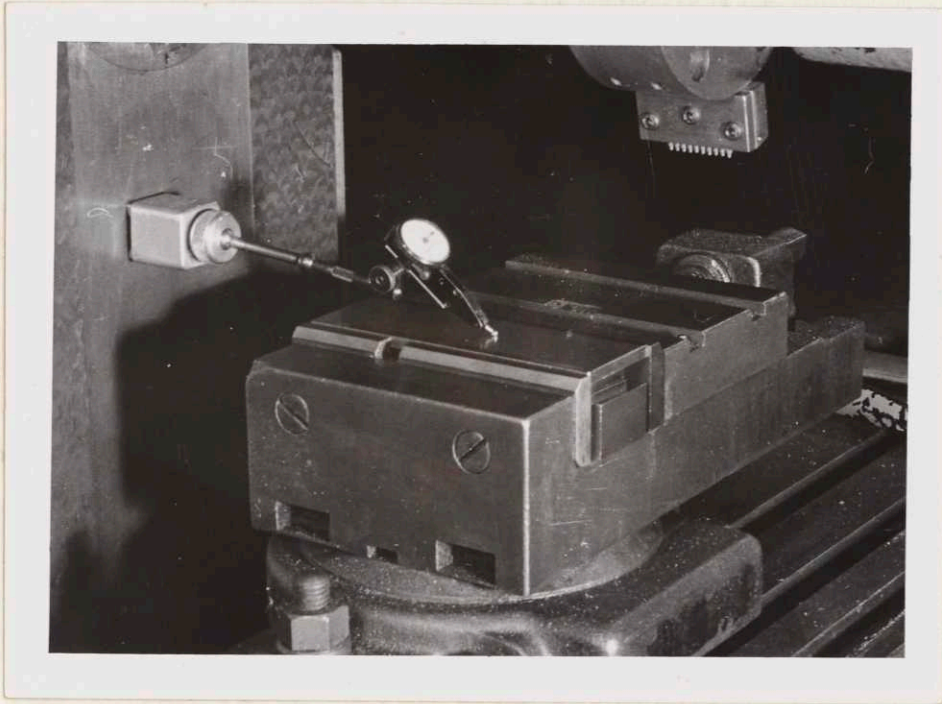

ALIGNMENT OF WORK WITH INDICATOR

FIGURE 6

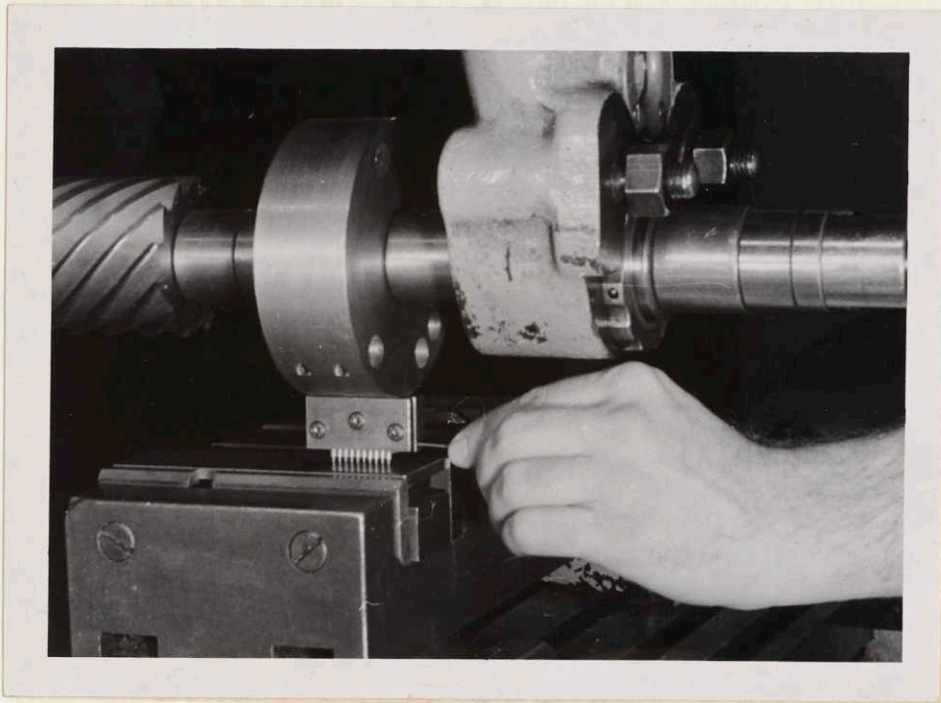

ABRASIVE GRITS ADJUSTED TO WORK SURFACE

FIGURE 7

the surface of the work material. With the ten abrasive grits thus in contact with the surface, the mounting rods were rigidly clamped in position.

The table was fed down a few thousandths of an inch to clear the grits, and the spindle was engaged. The work was brought up to the rotating fly cutter until the mounted abrasives first made contact with the work material. Contact was evident from the appearance of small scratches on the workpiece. This position was designated as zero and set on an indicator attached to measure the vertical motion of the milling table. The work was then fed off to the side of the fly cutter and the table was raised to give a depth of cut of thirty ten-thousandths of an inch (.0030"). The table feed was engaged and the work material traversed the rotating fly cutter, the abrasive particles cutting parallel grooves (Figure 8) across the work. The parallel grooves began and ended in the taper sections at the side of the workpiece. The directions of motion of the fly cutter and workpiece were such as to simulate conventional or up-milling. The entire above procedure was then repeated, the same abrasive particles being tested a second time. With a workpiece length of six inches, approximately one hundred wear tracts can be obtained. Figure 9 shows a typical workpiece and the grinding tracts obtained.

The purpose of the beginning and ending taper sections now becomes evident. The length of the track in the initial and final taper sections indicates the depth of cut of the

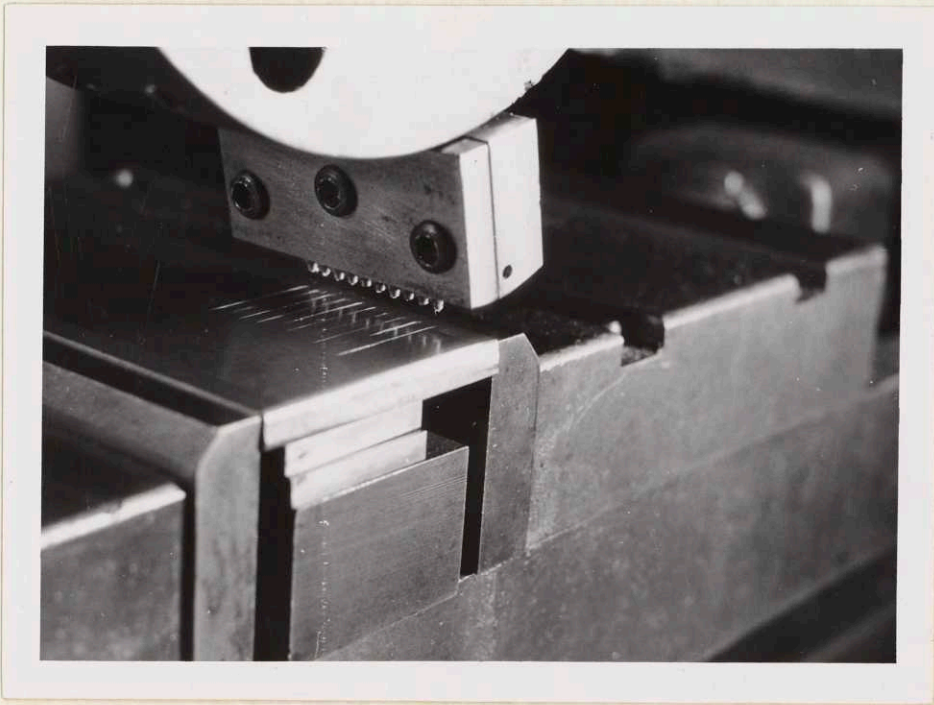

PARALLEL TRACTS BEING CUT ON 1020 STEEL

FIGURE 8

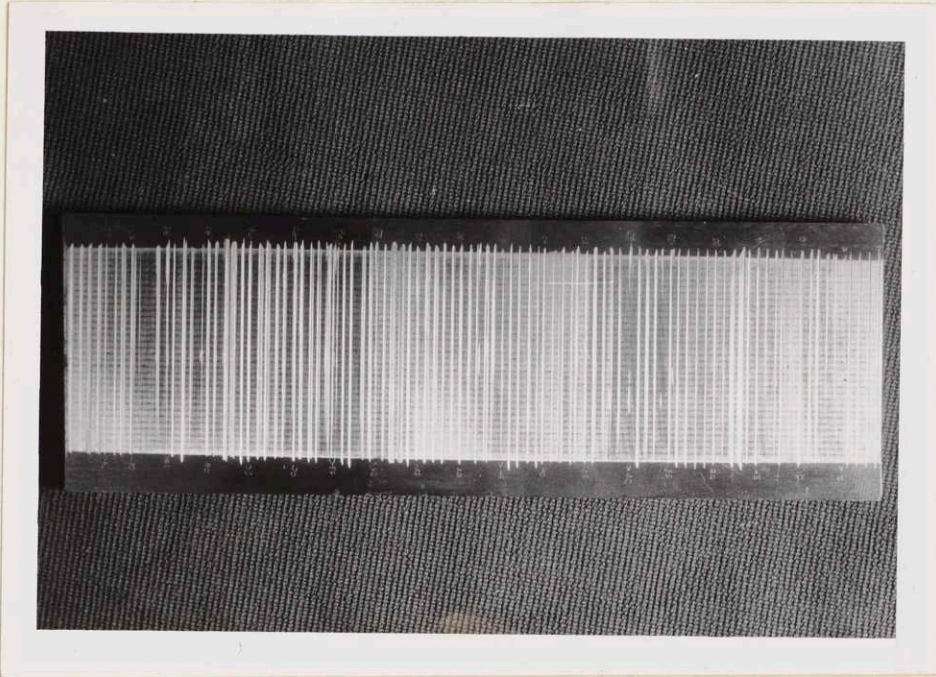

TYPICAL WORKPIECE SHOWING GRINDING TRACKS
(Initial taper at top of photograph)

FIGURE 9A

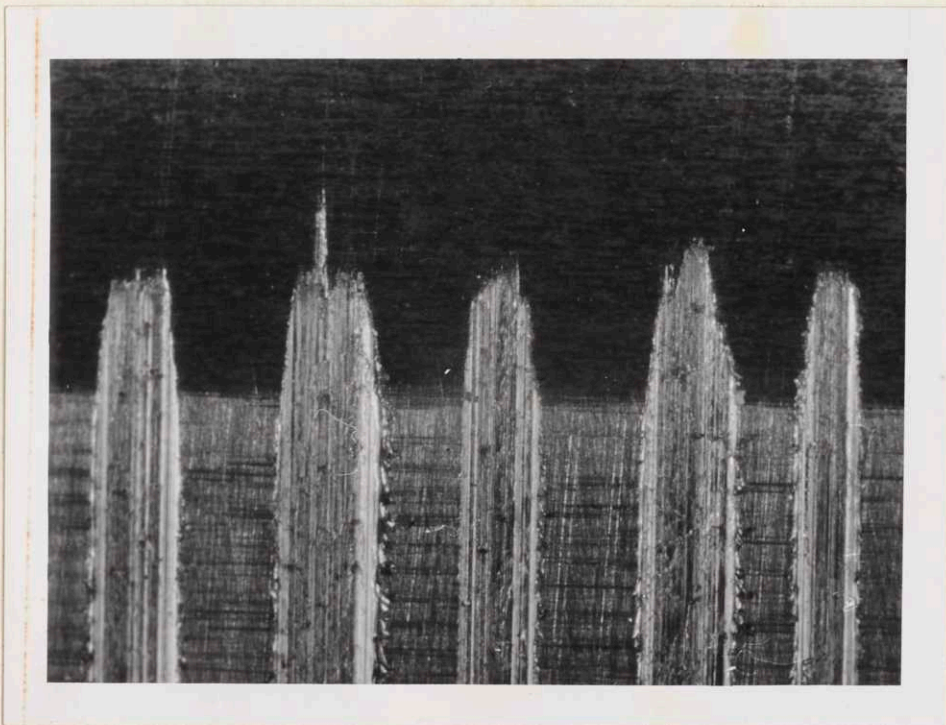

ENLARGED VIEW OF TAPER SECTION OF WORKPIECE

FIGURE 9B

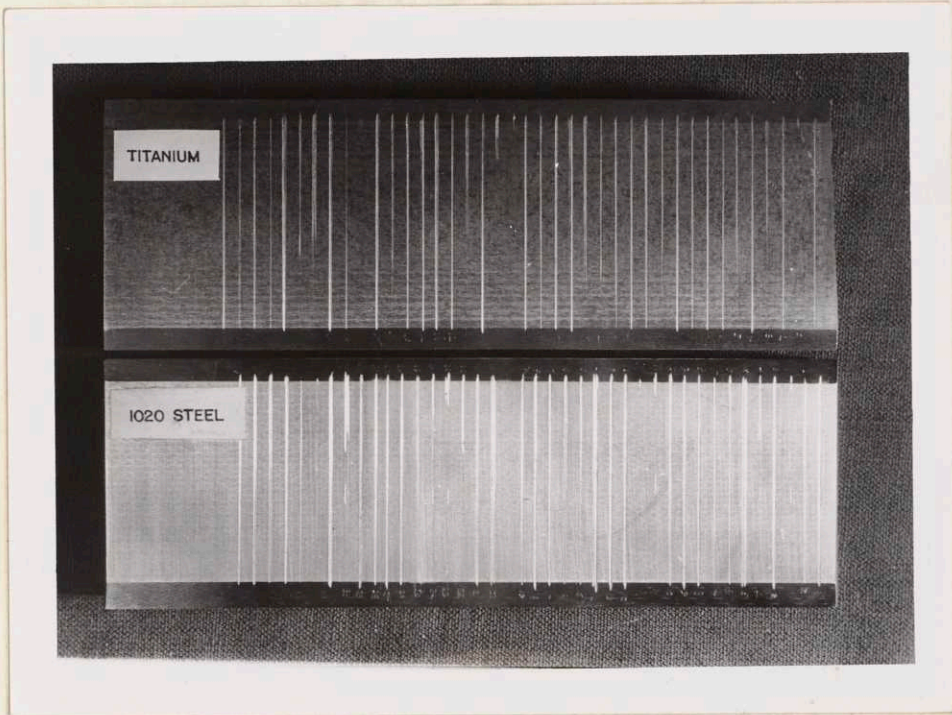

TITANIUM AND STEEL WORKPIECES AFTER GRINDING
(Initial taper at top of specimens).

FIGURE 10

abrasive particle at the beginning and end of the traverse. These dimensions are seen magnified by twenty by virtue of the incorporated slope and are readily measured by means of a Brinell microscope or similar instrument. The difference between the initial and final lengths is an indication of the wear which occurred as the grit traversed the width of the work.

In addition to the change of dimension of the abrasive grit, the taper section yields further information. The face profile of each grit is recorded as it enters and leaves the work and can be observed and measured from the workpiece. This information is necessary in the determination of the value of the Grinding Ratio which is discussed later in this paper. The tracks made by the grits yield a permanent history of the abrasive as it traversed the work. Wear, change of shape of the grit, abrasive fracture, abrasive embedment in the work material, together with various degrees of surface roughness of the metal cut are evident from examination of the ground workpiece. Sparking and formation of grinding chips for various materials may also be observed.

The Grinding Ratio

In the study of grinding operations using a conventional grinding wheel, a frequently recorded quantity is the grinding factor or grinding ratio, G . As previously defined, the grinding ratio is the quotient volume of work material removed in grinding over volume of grinding wheel worn away. The grinding ratio provides a method of comparing performance of different

wheels when grinding similar work materials or quantitatively differentiating the relative difficulty of grinding various work materials. Values of the grinding ratio have also been used to evaluate the action of cutting fluids used in grinding. (Reference 4). The measurement of the volume of the grinding wheel removed indicates in addition to the actual abrasive material, both the bonding material and included voids. Representative values for the grinding wheel G-ratio for steels may range from 50 to 100. Materials which are more difficult to grind, notably titanium, give values of G as low as unity.

In the present work the grinding ratio is studied for individual abrasive particles. From examination of the front profiles of the abrasive grits, as shown on the taper sections of ground workpieces, the change of shape of the grit in one traverse can be measured, and a mean area of wear can be obtained. To determine the volume of abrasive worn away, it is necessary to multiply the wear area by a mean length at right angles to the area. From examination of photographs of single abrasive grits after grinding and the examination of the actual grits, it is felt that a good approximation to this mean length is one half the initial width of the cutting portion of the abrasive grit as measured from the workpiece track. Symmetry of grit in front and side profiles would seem to indicate that this length is a good approximation to the actual value.

The volume of metal removed is calculated as the mean

cross-sectional area of the grinding track multiplied by the width of the workpiece. The areas of the cut material can be obtained from the depth and width of the grinding track as evidenced from the grit profile shown in the taper section. It is to be noted that the only quantities necessary for the determination of the grinding ratio, G, are the width of the workpiece and the initial and final depth and width of the individual tracks, all of which are readily measured from the workpiece.

In equation form the grinding ratio is:

$$G = \frac{\text{vol. metal removed}}{\text{vol. abrasive expended}}$$

$$G = \frac{L \bar{A}}{b (A_1 - A_2)} = \frac{L/2 (A_1 + A_2)}{b (A_1 - A_2)}$$

A = kwd, where k is a constant "shape factor"
1/2 in the case of a triangular cross-section.

$$b = w_1/2$$

$$G = \frac{L/2 (w_1 d_1 + w_2 d_2)}{b (w_1 d_1 - w_2 d_2)} = \frac{L(w_1 d_1 + w_2 d_2)}{w_1 (w_1 d_1 - w_2 d_2)}$$

where:

w_1 = initial width of track

d_1 = initial depth of track

w_2 = final width of track

d_2 = final depth of track

b = mean length of cutting portion of abrasive grit

L = width of workpiece

It is seen from the above analysis that the shape of the grit profile does not enter into the final expression for G , the "shape factor", k , appearing in both numerator and denominator of the expression.

In the case of some materials which are difficult to grind the abrasive particle may wear out before one traverse of the work. In these cases the grinding ratio simplifies as follows:

$$G = \frac{\text{vol. of metal removed}}{\text{vol. of abrasive expended}}$$

$$G = \frac{L'/2 (A_1)}{b (A_1)}$$

$$b = w_1/2$$

$$G = L'/w_1$$

where:

A_1 = the initial cross-sectional area of the track

L' = the actual length of the track

w_1 = the initial width of the track

Test I. The Grinding Ratio

Using the fly cutter technique, the values of the grinding ratio were determined for several different work materials. For this series of tests the following operating conditions were maintained:

Wheel speed	1088 rpm
Wheel diameter	7.25 in.
Cutting velocity	2060 fpm
Workpiece width	1.5" approx.
Table feed	1.0 ipm
Number of cuts per pass	1630 approx.
Initial depth of cut	.0030 inch
Grain depth of cut	37.5 micro inches
Work material	As noted
Abrasive material	K-8
Cutting fluid	None

The grain depth of cut in grinding is defined (5) as the average depth of cut taken by each individual abrasive grain of the grinding wheel. This quantity is found to be an important variable in the determination of grinding wheel characteristics, and is of much greater significance than the nominal or wheel depth of cut, this latter being determined only by the wheel down feed in respect to the workpiece. The grain depth of cut may be determined for the fly cutter used

in these tests from the equation developed for micromilling,
where

$$t = \frac{2v}{NK} \sqrt{\frac{d}{D}}$$

- t = grain depth of cut, inches
- v = table speed in ipm
- N = cutter speed, rpm
- K = number of teeth in wheel (one)
- d = wheel depth of cut, inches
- D = wheel diameter, inches

The work materials used in this series in the determination of the grinding ratio were:

	Brinell Hardness
1. 24-ST Aluminum	137
2. 1020 Steel	167
3. Titanium (Ti 150A)	198
4. 18-8 Stainless Steel	217

The data obtained from these tests together with a discussion of the values are included under the Results section of this paper.

Test II. Wear Studies of Abrasives on Various Work Materials

In this series of tests two abrasive types were tested on a variety of work materials. The abrasives tested were aluminum oxide Lot 212 and silicon carbide. The work materials included: 24-ST aluminum, 1020 steel, 1095 steel, zirconium, titanium (Ti 150A), and 18-8 stainless steel. The test procedure was similar in all respects to that outlined previously in regard to the grinding ratio, with the exception that in these tests on various work materials more data were obtained for each abrasive type. The operating conditions for this series of tests were:

Wheel speed	1088 rpm
Wheel diameter	7.25 in.
Cutting velocity	2060 fpm
Workpiece width	1.5" approx.
Table feed	1.0 ipm
Number of cuts per pass	1630 approx.
Initial depth of cut	.0030 inch
Grain depth of cut	37.5 micro inches
Work material	As noted
Abrasive material	As noted
Cutting fluid	None

Data obtained from these tests are recorded under Results section of this paper. A discussion of the results obtained is also presented.

Test III. Single Abrasive Grinding at Various Speeds

In this series of tests single abrasive grinding was conducted at different speed and feed conditions. The work material used was titanium (Ti 150A). The abrasive was aluminum oxide Lot 212.

In tests of this nature using the fly cutter technique on the milling machine, it is possible to vary, in increments, either the speed of the rotating fly cutter or the table feed separately, or to vary both of these quantities in combination. It was decided that the latter would be done, i.e. both the rotating speed of fly cutter and the table feed would be adjusted. The variable, which was held as close as possible to a constant value, was the grain depth of cut, t . Table 1 shows the fly cutter speeds, the cutting velocities and the grain depth of cut used. A discussion of these tests and the results obtained is presented in the Results section of this paper.

SPEED (N)	FEED (v)	VELOCITY (v)	GRAIN DEPTH
RPM	IPM	FPM	OF CUT (t) in.
1400	1 3/8	2660	40.0×10^{-6}
1088	1	2060	37.5×10^{-6}
851	3/4	1620	35.9×10^{-6}
666	5/8	1260	38.3×10^{-6}
529	1/2	1000	38.5×10^{-6}

TABLE 1

RESULTS

Table 2 shows the values of the grinding ratio (G) which were obtained using K-8 Aluminum Oxide as the abrasive with the work materials shown. The measured quantities from which these G values were computed are listed in the Appendix under Test I.

WORK MATERIAL	BHN	GRINDING RATIO
24-ST ALUMINUM	137	185
1020 STEEL	167	115
TITANIUM TI 150A	198	98
18-8 STAINLESS ST.	217	95

TABLE 2

From the above it is seen that the grinding ratios obtained for steel, titanium, and stainless steel by the single abrasive fly cutter method do not differ greatly from each other, and particularly in the case of titanium and stainless steel are considerably greater than the grinding ratio values of the grinding wheel. G-ratios for titanium and, also stainless steel, when ground in air are often unity or less.

Several factors may contribute to the higher values of the grinding ratio for single abrasive cutting as opposed to conventional grinding wheel cutting. In the case of the single abrasive particle the denominator of the grinding factor equation represents all abrasive material which was expended in removing a given amount of metal, the corresponding denominator in the grinding wheel equation represents, in addition to the actual amount of abrasive used, the volume occupied by the bond of the grinding wheel and the included voids. Two additional factors which may influence the grinding ratio are the extent to which rewelding of the chip to the work surface occurs, and the amount and stability of metal which may build up on the surface of the grinding wheel. Rewelding of chip to chip has been observed when grinding titanium and zirconium with single abrasive particles. In the case of single cutting elements, such as those used in these experiments, rewelding of the chip to the work surface is not observed to any extent. This perhaps is because there is sufficient space for metal to flow away from the cutting element, and the cutting element is not closely followed by other cutting particles. In the grinding wheel case, however, sufficient area may not exist for metal to flow away from the cutting elements and rewelding of chip to work material may become a more determining factor in wheel wear. Thus due to rewelding the same metal may have to be ground from the surface several times. The formation of built up metal on the surface of a grinding wheel has been observed in other work

in the grinding of aluminum, and has been photographically recorded using the stroboscopic technique (Reference 3). An additional consideration is the effect of cutting velocity on abrasive wear. The single abrasive cutting in this series of tests was at a velocity of 2060 fpm. Tests conducted using a conventional grinding wheel and titanium work material (ground in air) indicate the speed for minimum wheel wear to be about 2200 fpm, (Reference 4), and show a considerable increase in wear as the cutting speed is increased. Conventional grinding is done at speeds much greater than those used in the experiments of this paper.

The value of the grinding ratio obtained when grinding 24-ST aluminum with the K-8 aluminum oxide abrasive was considerably greater than the values obtained from the other three work materials. Positive wear of the abrasive was observed, however, unlike the results obtained when aluminum was ground with Lot 212 aluminum oxide and silicon carbide. Built up metal was not observed on the abrasive particles and the negative values of wear indicating the existence of an appreciable built-up-edge were not present. This difference between the K-8 abrasive and the Lot 212 abrasive is discussed further under the suggestions for future work of this paper.

Test II

The results of this series of tests are given in Table 3. Mean values of wear for each abrasive type are listed opposite the work materials tested. Experimental data from

TEST II

WORK MATERIAL	BHN	MEAN VALUE OF WEAR $\times 10^4$ IN.	
		LOT 212 ALUM. OX.	SILICON CARBIDE
24-ST ALUMINUM	137	- 2.8	8.3
1095 STEEL	256	14.0 \pm 1.9	15.3 \pm 1.7
ZIRCONIUM	137	15.7 \pm 2.6	15.7 \pm 2.3
TITANIUM Ti 150 A	198	17.4 \pm 1.6	21.3 \pm 1.8
1020 STEEL	167	20.8 \pm 1.4	20.5 \pm 1.5
18-8 STAINLESS STEEL	217	21.6 \pm 1.8	21.7 \pm 1.6

WEAR VALUES MEASURED TO 0.0001 INCH IN ALL TESTS

TABLE 3

TEST III

ABRASIVE MATERIAL: LOT 212 ALUM. OXIDE

WORK MATERIAL: TITANIUM Ti 150 A

SPEED RPM	FEED IPM	VELOCITY FPM	MEAN WEAR $\times 10^4$ IN.
1400	1 3/8	2660	22.8
1088	1	2060	17.4
851	3/4	1620	16.5
666	5/8	1260	16.9
529	1/2	1000	19.8

TABLE 4

which these values were computed are recorded in the Appendix and indicate the number of passes which were made across each workpiece.

Table 3 lists the work materials in their order of difficulty in grinding. It is seen that in most cases both the aluminum oxide and the silicon carbide abrasive types exhibit similar wear values. This is particularly true with zirconium, 1020 steel and stainless steel. Vertical correlation of the wear values appears favorable in that both abrasive types exhibit increased wear in the same order as they progress down the table. Differences between the aluminum oxide Lot 212 abrasive and the silicon carbide are seen to exist with aluminum, 1095 steel, and titanium work materials. In these latter three cases the aluminum oxide appeared to be superior, exhibiting less wear than the silicon carbide. The data on 1020 steel are based on two tests for each abrasive type. This was done as a check on the reproducibility of the information and to verify the position of the 1020 steel relative to the other work materials. The second test on the steel with both abrasives gave results similar to those obtained from the first test.

The most significant difference to appear in this series of tests is that which occurred when 24-ST aluminum was ground. With Lot 212 aluminum oxide as the abrasive particle considerable metal build up was observed on the abrasive. The built-up-edge which formed was characteristic of almost all the abrasive grits and caused an effective increase in length

of the cutting particles. This metal which adhered to the grits prevented the normal abrasive wear from occurring and caused the negative values of wear shown in the Appendix and the mean negative wear value shown in Table 3. The aluminum was observed to build up on the silicon carbide grit to a much smaller extent than on the Lot 212 aluminum oxide. Most wear of the silicon carbide was positive, the grits not being protected by the adherence of metal on the cutting surfaces. A mean value of positive wear was obtained with the silicon carbide which is considerably greater than the aluminum oxide wear.

Test III

A series of wear tests with aluminum oxide Lot 212 as the abrasive and titanium work material conducted at various values of cutting velocity produced the results shown in Table 4. As previously mentioned, both the wheel speed and the table feed were adjusted, the grain depth of cut being the variable which was maintained at nearly a constant value.

The minimum value of abrasive wear is seen to occur at a cutting velocity of about 1600 feet per min., and to be fairly constant over a velocity range from 2000 fpm to 1200 fpm. In this range, particularly at the lower speed value the built up edge was observed to exist and the reduced abrasive wear may be due to this factor. Wear of the abrasive grit was seen to increase at speeds both above and below the velocity range stated above. Built up metal was not

observed at the high and low speeds.

As mentioned in the discussion of the results of Test I, conventional grinding wheel tests on titanium (in air) show the optimum grinding speed to occur at about 2200 fpm. Wear values from these grinding wheel tests increase appreciably as the cutting velocity is increased. Information regarding wear is not available at speeds lower than about 2000 fpm as this was the lower speed value of the grinding wheel tests.

DETERMINATION OF STANDARD ERROR

In the statistical analysis of the data from Test II, the same evaluation method as used by Cole (Reference 2) was employed to calculate the standard error. Table 5 illustrates the method as applied to Lot 212 Aluminum Oxide abrasive with 18-8 Stainless Steel as the work material.

Column 1 of Table 5 is a list of the values of wear per pass of the mounted abrasive grit as it traversed the work material. These figures are wear in ten-thousandths of an inch and range from the minimum to the maximum value measured. The number of times each wear value occurred was placed opposite the appropriate wear value of Column 1, thus forming Column 2. The sum of the numbers of Column 2 is the total number of passes on the work material. A preliminary mean was established in Column 1. Counting from this mean in both directions and multiplying the numbers of Column 2 by their position from the mean value produced Column 3. The numbers in Column 3 above and below the mean were added separately and interpolation of their sums as indicated in Table 5 gave the exact mean value of wear. Column 4 was produced from Column 3 by again counting from the mean position and multiplying the numbers in Column 3 by their respective positions from the mean. This process of producing Column 4 is equivalent to multiplying the numbers of Column 2 by the square of their position from the mean value. Column 4 was

added in its entirety, and the sum was divided by the total number of passes which occurred. This gave the mean square value. The square root of the mean square was taken, and recorded as the root mean square value. The standard error for a 68% confidence limit was obtained by dividing the root mean square value by the square root of the degrees of freedom, the degrees of freedom being the total number of passes (sum of Column 2) minus one. The standard error for a 95% confidence limit was obtained by doubling the standard error for a 68% confidence limit.

The mean values of wear for Test II together with their calculated standard error are recorded in Table 3 of the Results section of this paper. The standard error was not calculated for the cases where 24-ST aluminum was the work material, as the values obtained were in most cases not true abrasive wear, but rather a result of built up metal on the abrasive grit. A reference to these values in the Appendix will illustrate the results which were obtained with two abrasive materials (aluminum oxide Lot 212, and silicon carbide) grinding aluminum.

VISUAL OBSERVATIONS

During these investigations very interesting visual observations were made concerning the amount of sparking which occurred and the size and characteristics of the chips which were produced from different work materials. Figures 11, 12, 13, and 14 are photographs of the chips obtained from four work materials.

With aluminum oxide Lot 212 as the abrasive material, the following was observed:

1. 24-ST Aluminum. No sparking occurred, but a very considerable built-up-edge was observed to form on all abrasive particles. The formation of the built-up-edge prevented wear from occurring. The chips appeared as shown in Figure 11A. They were short, uniform in size and appearance, had clean surfaces and did not evidence rewelding to any great extent.
2. 1020 Steel. Little sparking occurred here. The chips appeared to be of a uniform size, some temper colors being evident. Rewelding of chip was not observed to occur to any appreciable extent.
3. 1095 Steel. This work material produced considerable sparking when ground, the sparks being similar in appearance to those obtained when grinding with a conventional grinding wheel. The chips produced were as shown in Figure 11B. They exhibited temper colors and were observed to melt and form spheres due to the heat generated.

4. Titanium (150A). Brilliant white sparking was observed as the titanium was ground. The titanium chips were very long and of a featherlike nature. Considerable rewelding of chips occurred in some instances producing continuous chips of as much as 1/2 inch in length. Figure 13 A and B, and Figure 14 show the structure of these long chips.

5. Zirconium. Zirconium appeared very similar to titanium. Considerable brilliant sparking was observed and long chips were produced. Figure 12 B illustrates the zirconium chips. In general the zirconium chips were not as long as the titanium ones, but the structures were very similar.

6. 18-8 Stainless Steel. The stainless steel chips were short, and roughly uniform in size and geometry. They exhibited clean, surfaces and produced no sparking.

The following observations were made with Silicon Carbide as the abrasive material:

1. 24-ST Aluminum. No sparking occurred when the aluminum was ground. Built-up-edge was observed to form but to a much smaller extent than that on the aluminum oxide abrasive. Positive wear of the abrasive was measured in this case. Chips were similar to those produced by the aluminum oxide abrasive, and as shown in Figure 11 A.

2. 1020 Steel. No sparking was observed here. The chips were again similar to those produced by the aluminum oxide particles, being uniform in size and exhibiting

temper colors on the surfaces.

3. 1095 Steel. Considerable sparking was observed when this material was ground. Small chips similar to those of Figure 11 B were produced; temper colors and melting of chips were again observed with this material.
4. Titanium (150A). Titanium again produced a long feather-like chip, showing considerable rewelding of metal. No sparking occurred here, unlike the tests with aluminum oxide.
5. Zirconium. The zirconium chips again appeared similar to the ones obtained from titanium, the long, rewelded structure similar to that shown in Figure 12 B being present. White sparking was observed.
6. 18-8 Stainless Steel. Small, uniform chips were produced which in all respects resembled those produced by the aluminum oxide abrasive. No sparking occurred.



FIGURE 11 A. 24 - ST ALUMINUM CHIPS



FIGURE 11 B. 1095 STEEL CHIPS

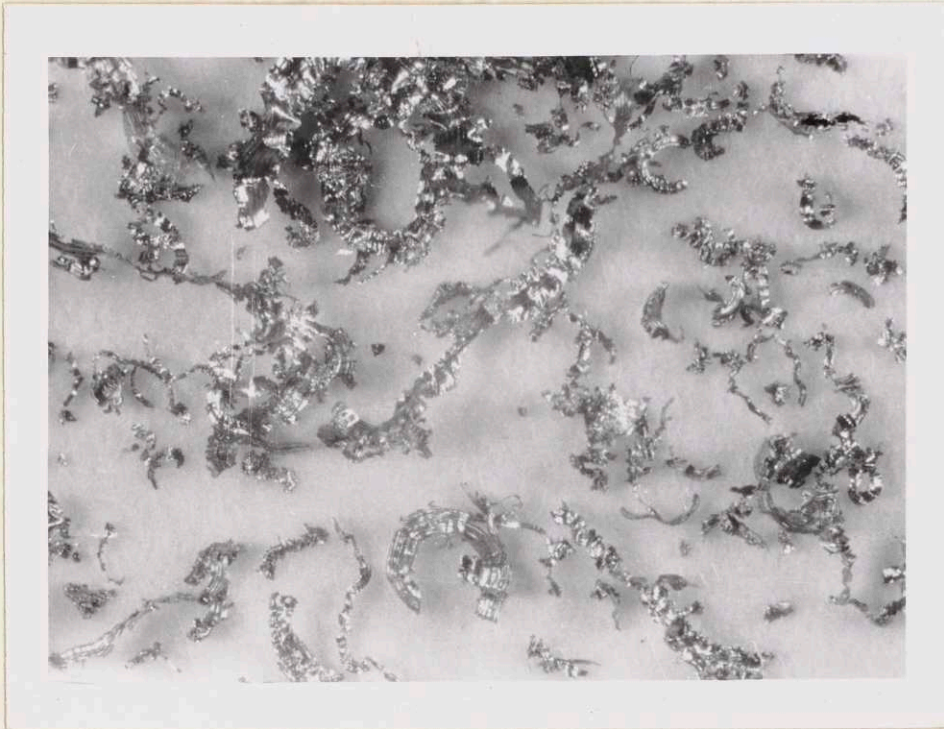

FIGURE 12 A. TITANIUM CHIPS

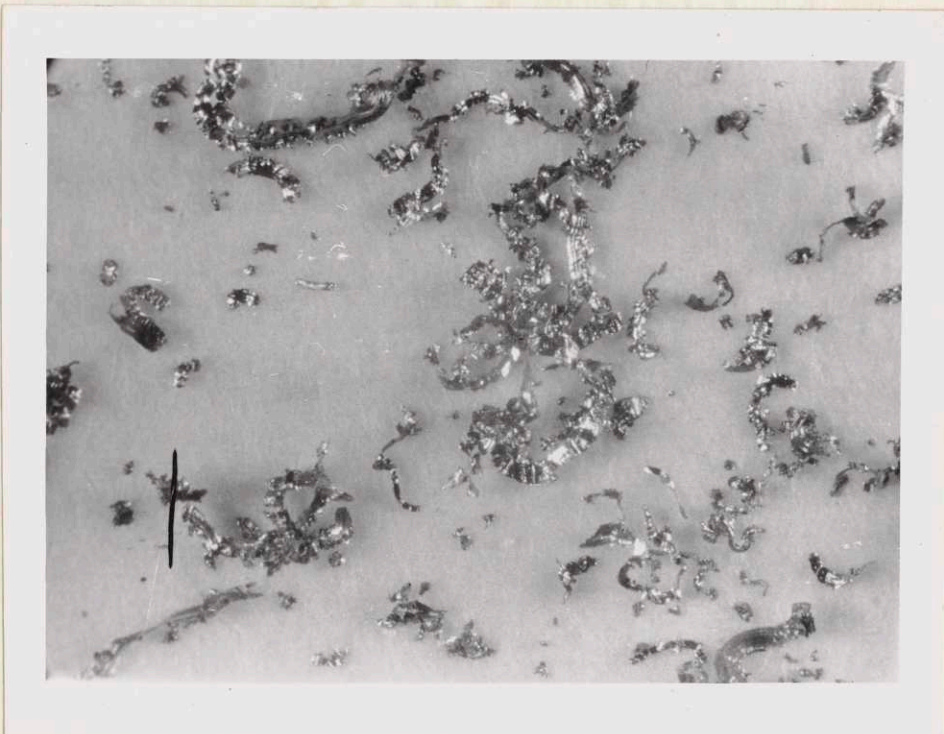
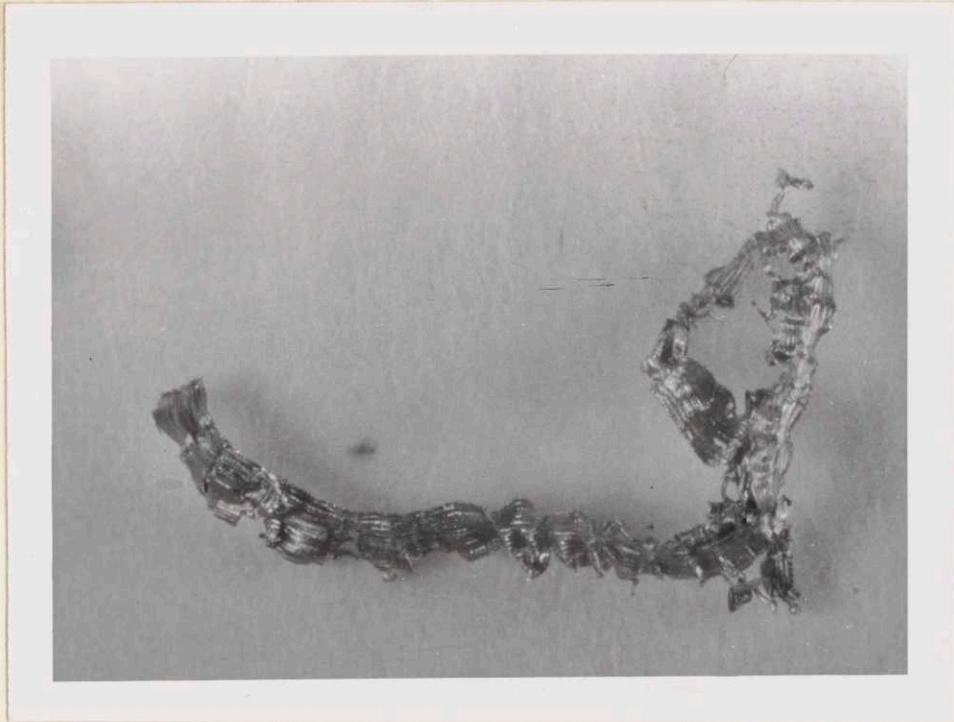
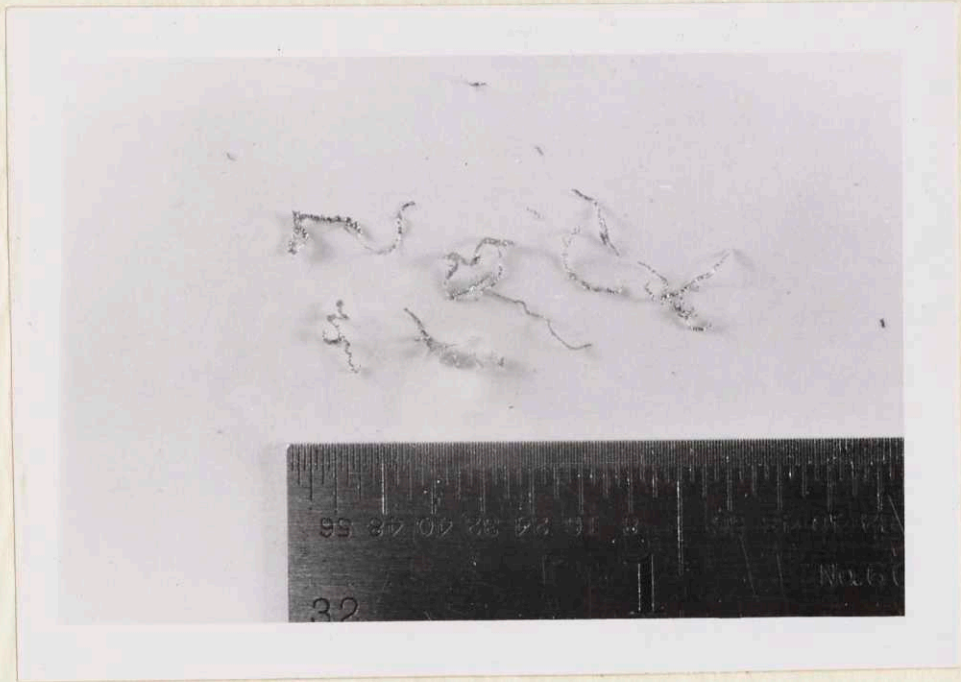

FIGURE 12 B. ZIRCONIUM CHIPS



TITANIUM CHIPS SHOWING REWELDING
(Upper chip is 1/4" in largest dimension)

FIGURES 13 A AND 13 B



TITANIUM CHIPS

FIGURE 14

FUTURE WORK

Single abrasive particle studies could be continued using a variety of abrasive types in grinding of work materials, such as titanium. Abrasive materials which could be studied include: Titanium Oxide, Titanium Carbide, Zirconium Oxide, Zirconium Carbide, Boron Carbide, and others.

A study of the effect of cutting fluids used in conjunction with the single abrasive grinding could be made with titanium again used as the work material. Fluids, such as barium hydroxide and others (Reference 4) which have proven to be useful in grinding titanium, could be tested. Comparisons could be made between the results obtained from grinding wheel tests and those obtained by the fly cutter technique.

The stroboscopic technique discussed under Previous Work, could perhaps be adapted to photograph the fly cutter and mounted abrasives. Using this technique, a photographic record showing wear of a single grit could be obtained. Front and side profile views could be observed and more information showing the nature of the wear process and grit failure would be thus made available. In addition to observations made on the abrasive particles, the stroboscopic study would possibly reveal the mechanism of metal removal and chip formation. A photographic record of the formation of the long chip characteristic of titanium would be of

particular value in establishing the extent to which rewelding of the metal occurs in grinding. The existance of the built-up-edge which has been observed when aluminum is used as the work material could be further verified and its effect in influencing abrasive wear could be studied. The presence of the built-up-edge with Lot 212 aluminum oxide grinding aluminum, and the absence of built up metal with K-8 aluminum oxide could be examined.

BIBLIOGRAPHY

1. Single Grain Studies. M.I.T. Machine Tool Laboratory,
July 28, 1954.
2. Wear Studies of Single Aluminum Oxide Grains During
Grinding. John M. Cole, S.M. Thesis, Mechanical
Engineering Department, M.I.T., August,
1955.
3. Grinding Wheel Wear and Metal Removal (Stroboscopic
Photography). Abel I. Plockier, B.S. Thesis,
Mechanical Engineering Department, M.I.T.,
January, 1956.
4. Grinding of Titanium Alloys with Chemical Fluids.
C. C. Yung, B.S. Thesis, Mechanical Engineer-
ing Department, M.I.T., June, 1955.
5. Metal Cutting Principles. 3rd Edition, M. C. Shaw,
Massachusetts Institute of Technology.

APPENDIX

Symbols and abbreviations used in recording data in Appendix.

No.	pass number
d_1	initial depth of cut, inches
d_2	final depth of cut, inches
w_1	initial width of cut, inches
w_2	final width of cut, inches
L	length of track on specimen, inches
Tot.	total value of column
Av.	average value of column
G	grinding ratio
d	wear of abrasive in ten-thousandths of an inch.

Negative values of d, or cases in which d_2 exceeds d_1 indicate presence of built-up-edge.

SUPPLEMENTARY INFORMATION ON ABRASIVES

Lot K8

This is a pure White Alumina produced from calcined Al_2O_3 in an arc furnace at approximately $2050^{\circ}C$. It is a standard wheel grain and the chemical specifications are as follows:

Al_2O_3	99.1% Min.
Na_2O	0.6% Max.
FeO	0.15% Max.
SiO_2	0.15% Max.

Lot 212

A high titania Aloxite R produced from bauxite in an arc furnace at approximately $2050^{\circ}C$. This grain is used in coated abrasives. The chemical specifications are as follows:

Al_2O_3	93.0% Min.
TiO_2	2.9 - 3.5%
SiO_2	1.4 - 2.0%
FeO	0.3% Max.
MgO	0.4 - 0.6%
ZrO_2	0.3 - 0.5%

Lot 103

A low titania Aloxite R also furnaced from bauxite in the same manner as Lot 212. This is a standard wheel grain. The chemical specifications are as follows:

Al_2O_3	96.0% Min.
TiO_2	1.9 - 2.4%
SiO_2	0.3 - 0.9%
T.C.	0.2% Max.

Black SiC

A blocky wheel grain produced from pure SiO_2 and coke in a resistance furnace with the most active formation occurring at $2200^{\circ}C$. The chemical specifications are listed below.

SiC	96% - 97%
-----	-----------

TEST I

Grit Type: K-8 Alum. Oxide
Work Material: Aluminum 24 - ST

No.	w ₁	w ₂	L	d ₁	d ₂
1	.016	.010	1.65	.0035	.0022
2	.018	0	1.60	.0046	0
3	.014	0	0.10	.0045	0
4	.014	0	0.17	.0040	0
5	.024	.020	1.65	.0043	.0029
6	.015	.015	1.65	.0040	.0021
7	.018	.016	1.65	.0038	.0025
8	.019	.017	1.65	.0041	.0030
9	.011	.008	1.65	.0034	.0025
10	.015	.012	1.65	.0035	.0020
11	.025	.017	1.65	.0043	.0017
12	.028	.026	1.65	.0039	.0032
13	.014	.013	1.65	.0040	.0027
14	.019	.017	1.65	.0043	.0037
15	.017	.006	1.65	.0035	.0007
16	.032	.018	1.65	.0042	.0021
17	.013	.009	1.65	.0015	.0008
18	.017	.017	1.65	.0037	.0032
19	.017	.009	1.65	.0036	.0032
20	.013	.009	1.65	.0035	.0028
21	.017	.017	1.65	.0031	.0023
22	.016	.015	1.65	.0029	.0026
23	.025	.024	1.65	.0028	.0026
24	.014	.010	1.65	.0027	.0027
25	.016	.013	1.65	.0027	.0027
26	.022	0	0.23	.0048	0
27	.021	.004	1.65	.0033	.0007
28	.018	.017	1.65	.0040	.0033
29	.012	.010	1.65	.0036	.0029
30	.020	.017	1.65	.0035	.0026
Tot.	.540	.366	45.00	.1096	.0637
Av.	.018	.012	1.50	.0037	.0021

TEST I

Grit Type: K-8 Alum. Oxide

Work Material: 1020 Steel

No.	w ₁	w ₂	L	d ₁	d ₂
1	.024	.015	1.60	.0032	.0016
2	.018	.015	1.60	.0027	.0004
3	.020	.020	1.60	.0032	.0029
4	.013	0	1.60	.0034	0
5	.038	.038	1.60	.0028	.0021
6	.020	.008	1.60	.0033	.0007
7	.014	.005	1.60	.0023	.0002
8	.015	.011	1.60	.0033	.0017
9	.021	.020	1.60	.0032	.0030
10	.028	.009	1.60	.0040	.0014
11	.020	0	0.12	.0043	0
12	.021	.020	1.60	.0033	.0030
13	.020	.025	1.60	.0035	.0036
14	.043	.040	1.60	.0035	.0042
15	.020	.010	1.60	.0029	.0010
16	.021	.020	1.60	.0028	.0009
17	.019	.015	1.60	.0032	.0019
18	.026	.016	1.60	.0035	.0036
19	.022	.010	1.60	.0031	.0014
20	.035	.030	1.60	.0025	.0014
21	.023	.019	1.60	.0030	.0018
22	.020	0	0.60	.0031	0
23	.039	0	0.20	.0042	0
24	.025	0	1.60	.0030	0
25	.024	.005	1.60	.0025	.0002
26	.020	.015	1.60	.0039	.0017
27	.014	.018	1.60	.0029	.0033
28	.023	.015	1.60	.0032	.0012
29	.022	.014	1.60	.0028	.0027
30	.032	0	1.60	.0040	0
Tot.	.690	.413	44.12	.0966	.0459
Av.	.023	.014	1.47	.0032	.0015

TEST I

Grit Type: K-8 Alum. Oxide

Work Material: Titanium

No.	w ₁	w ₂	L	d ₁	d ₂
1	.009	0	1.65	.0021	0
2	.010	.002	1.65	.0026	.0003
3	.015	0	1.10	.0008	0
4	.014	.012	1.65	.0034	.0017
5	.019	0	1.25	.0023	0
6	.010	.002	1.65	.0020	.0007
7	.012	.004	1.65	.0025	.0007
8	.013	.003	1.65	.0026	.0003
9	.016	.009	1.65	.0026	.0014
10	.009	0	1.30	.0016	0
11	.020	.002	1.65	.0021	.0003
12	.014	.006	1.65	.0024	.0005
13	.017	0	1.65	.0023	0
14	.009	0	1.30	.0025	0
15	.031	0	1.45	.0026	0
16	.038	.007	1.65	.0028	.0015
17	.020	.013	1.65	.0024	.0008
18	.013	.002	1.65	.0026	.0002
19	.015	.007	1.65	.0026	.0011
20	.017	.014	1.65	.0031	.0022
21	.020	0	1.10	.0028	0
22	.011	.005	1.65	.0030	.0009
23	.031	.014	1.65	.0028	.0011
24	.034	.006	1.65	.0033	.0015
25	.020	.009	1.65	.0032	.0006
26	.019	0	1.65	.0033	0
27	.020	.011	1.65	.0026	.0008
28	.005	.004	1.65	.0019	.0007
29	.020	.015	1.65	.0029	.0017
30	.032	0	1.00	.0030	0
Tot.	.533	.147	46.45	.0767	.0190
Av.	.018	.005	1.55	.0026	.0006

TEST I

Grit Type: K-8 Alum. Oxide

Work Material: 18-8 Stainless Steel

No.	w ₁	w ₂	L	d ₁	d ₂
1	.015	.015	1.65	.0024	.0027
2	.020	.015	1.65	.0024	.0014
3	.021	.007	1.65	.0023	.0005
4	.020	0	0.20	.0025	0
5	.020	0	0.55	.0024	0
6	.010	.009	1.65	.0021	.0012
7	.016	.015	1.65	.0023	.0024
8	.019	0	0.15	.0023	0
9	.021	.015	1.65	.0023	.0018
10	.028	0	1.65	.0018	0
11	.016	0	1.60	.0026	0
12	.017	.016	1.65	.0021	.0006
13	.012	0	1.65	.0024	0
14	.021	.016	1.65	.0018	.0016
15	.025	0	1.65	.0026	0
16	.006	0	1.65	.0021	0
17	.018	.014	1.65	.0026	.0016
18	.017	0	1.65	.0025	0
19	.029	.015	1.65	.0027	.0013
20	.008	0	1.30	.0016	0
21	.018	.015	1.65	.0028	.0018
22	.024	.019	1.65	.0030	.0020
23	.015	.004	1.65	.0020	.0007
24	.029	.004	1.65	.0016	.0006
25	.023	.017	1.65	.0018	.0013
26	.028	0	0.10	.0026	0
27	.016	0	1.37	.0020	0
28	.013	0	1.60	.0017	0
29	.024	.002	1.65	.0014	.0002
30	.005	0	1.45	.0006	0
Totl.	.554	.198	42.97	.0653	.0217
Av.	.019	.007	1.43	.0022	.0007

TEST II

Grit Type: Lot 212 Alum. Oxide

Work Material: 24-ST Aluminum

Wear values per pass in ten-thousandths of an inch, (d)

29	-5	-8	-3
-5	-5	-8	-7
32	-7	-6	-2
-4	-7	-8	-6
15	-5	-3	-8
-3	-7	-8	8
-3	4	-7	-6
-4	8	-9	-6
-6	2	-5	-7
-1	-2	-8	-6
-5	-7	8	-4
0	-7	-2	-6
-4	-5	-9	
-5	-5	-8	
0	1	-8	
-5	0	-8	

Grit Type: Silicon Carbide

Work Material: 24-ST Aluminum

2	-2	3	19
4	18	7	5
6	4	-1	32
17	1	-2	27
2	0	-2	11
9	14	-1	21
5	25	0	26
6	14	5	5
31	37	0	5
2	14	0	4
3	1	4	3
0	21	6	1
0	1	10	
14	7	22	
5	0	21	
0	-3	6	

TEST II

Grit Type: Lot 212 Alum. Oxide

Work Material: 1095 Steel

Wear values per pass in ten-thousandths of an inch, (d)

22	15	4	25	2	14
9	21	9	23	6	10
21	24	23	22	16	8
10	27	25	12	3	2
6	9	23	2	15	1
5	14	29	3	11	8
33	12	9	10	18	9
11	25	14	5	10	3
36	4	14	25	10	-*
24	19	5	20	0	35
27	8	19	8	12	16
33	7	19	12	4	25
29	12	8	2	12	4
21	26	8	7	3	1
20	26	3	17	0	0
26	30	14	22	2	

Grit Type: Silicon Carbide

Work Material: 1095 Steel

7	23	18	13	12	-
26	22	20	1	19	10
12	36	17	16	3	
20	20	20	1	15	
6	18	19	10	20	
5	27	26	18	17	
1	11	15	14	20	
21	10	24	30	15	
10	17	18	13	23	
7	7	27	14	19	
8	27	12	18	36	
11	12	20	3	15	
19	12	15	15	10	
7	14	19	10	10	
5	8	8	19	15	
15	5	25	23	11	

*Indicates small negative value not included in calculation.

TEST II

Grit Type: Lot 212 Alum. Oxide

Work Material: Zirconium

Wear values per pass in ten-thousandths of an inch, (d)

10	10	18	0
30	26	25	10
20	13	1	4
7	24	6	23
32	14	23	19
24	20	19	20
34	9	19	13
23	8	20	22
3	12	18	7
4	0	11	21
18	21	2	4
12	26	0	22
36	4	-	2
36	2	21	9
26	2	13	
28	36	-	

Grit Type: Silicon Carbide

Work Material: Zirconium

17	21	16	1
6	21	0	2
22	22	17	15
30	8	13	24
17	23	13	9
25	17	7	34
13	20	12	7
9	13	5	29
30	30	16	22
20	28	7	30
25	12	-	17
21	26	0	15
22	21	0	20
25	2	12	15
31	17	20	7
19	4	0	1
			2

TEST II

Grit Type: Lot 212 Alum. Oxide

Work Material: 150A Titanium

Wear values per pass in ten-thousandths of an inch, (d)

24	29	6	25	14	26
17	26	28	23	19	17
27	9	15	32	17	33
7	5	16	16	10	24
23	0	26	4	15	21
26	17	18	19	26	23
20	20	5	6	25	27
17	25	7	11	32	25
22	21	18	6	14	25
27	25	20	20	23	8
20	9	16	6	15	21
28	16	26	15	8	18
20	23	19	20	9	11
5	19	18	20	6	
9	19	11	12	11	
11	16	8	6	12	

Grit Type: Silicon Carbide

Work Material: 150A Titanium

25	24	25	31	21	22
16	41	27	22	24	25
20	24	26	33	7	16
17	20	24	10	24	27
25	21	11	5	29	17
26	5	14	2	8	29
31	24	15	19	18	20
19	22	21	8	30	9
33	29	17	27	20	16
35	20	11	16	27	24
31	25	22	5	5	28
35	22	20	17	22	
33	20	19	3	20	
36	28	20	25	6	
25	30	19	30	17	
33	9	20	31	28	

TEST II

Grit Type: Lot 212 Alum. Oxide

Work Material: 1020 Steel

Wear Values per pass in ten-thousandths of an inch, (d)

26	25	26	32	16	12
26	22	23	34	14	36
21	10	21	14	18	32
28	27	12	18	42	19
30	16	15	9	19	9
31	15	14	28	6	13
35	17	16	15	28	10
3	30	24	24	19	11
36	35	21	18	20	14
30	34	20	23	0	25
19	8	22	15	13	24
25	42	16	17	32	36
16	30	31	21	22	8
15	28	19	22	26	29
24	21	26	4	30	18
26	19	25	22	23	28
13	21	18	6	17	6
9	19	27	19	21	15
11	30	35	14	30	9
26	19	25	16	21	12
32	18	42	8	6	3
30	20	8	20	6	0
42	26	24	24	3	
27	7	19	25	26	
22	19	22	18	30	
25	23	17	20	41	
35	18	6	23	25	
34	8	32	24	34	
16	7	20	25	12	
25	23	17	22	15	

TEST II

Grit Type: Silicon Carbide

Work Material: 1020 Steel

Wear values per pass in ten-thousandths of an inch, (d)

10	16	14	31	14	47
5	15	12	18	12	3
35	23	11	26	11	34
23	13	25	13	23	23
25	15	33	29	15	42
20	15	29	19	17	32
35	18	1	31	8	20
31	15	17	5	16	26
33	11	5	15	19	19
27	21	10	12	21	26
34	20	12	19	16	15
21	18	31	23	12	26
38	15	11	13	11	12
25	15	17	36	12	24
34	23	7	21	27	9
26	18	22	41	16	
32	23	9	30	5	
19	16	9	28	25	
27	18	0	24	17	
26	20	25	28	28	
6	24	22	27	23	
9	22	23	19	45	
20	25	36	35	35	
22	17	3	34	28	
12	16	15	12	9	
15	28	8	16	35	
25	37	40	38	31	
30	10	10	18	13	
23	14	35	13	38	
18	14	2	22	4	

TEST II

Grit Type: Lot 212 Alum. Oxide
Work Material: 18-8 Stainless Steel

Wear values per pass in ten-thousandths of an inch, (d)

29	29	9	24
34	33	23	11
32	14	20	15
12	31	21	14
24	27	28	20
15	15	27	14
16	32	25	13
26	18	22	<u>23</u>
7	32	23	
26	14	22	
19	25	21	
31	11	22	
25	16	20	
23	25	22	
22	27	15	
25	21	26	

Grit Type: Silicon Carbide
Work Material: 18-8 Stainless Steel

25	20	27	18
20	19	7	17
29	20	20	16
20	33	4	34
29	19	15	13
21	24	4	26
35	16	26	45
19	24	20	15
27	17	25	22
15	27	25	17
28	24	26	24
13	20	27	25
31	22	24	9
14	20	27	27
24	22	22	20
20	23	17	

TEST III

Grit Type: Lot 212 Alum. Oxide Speed: 1400 RPM
Work Material: 150A Titanium Feed: 1 3/8 ipm

11	30	28	29	34	20
19	4	33	31	13	28
17	31	28	32	37	22
9	7	11	16	13	24
17	27	33	36	30	23
25	47	27	24	6	28
28	6	23	29	13	21
27	24	24	8	14	10
21	22	29	15	18	20
18	35	32	12	21	
20	20	24	20	25	
20	33	31	21	22	
16	26	32	21	13	
19	34	25	15	27	
22	29	32	25	25	
20	26	32	16	22	

Grit Type: Lot 212 Alum. Oxide Speed: 1088 RPM
Work Material: 150A Titanium Feed: 1 ipm

24	29	6	25	14	26
17	26	28	23	19	17
27	9	15	32	17	33
7	5	16	16	10	24
23	0	26	4	15	21
26	17	18	19	26	23
20	20	5	6	25	27
17	25	7	11	32	25
22	21	18	6	14	25
27	25	20	20	23	8
20	9	16	6	15	21
28	16	26	15	8	18
20	23	19	20	9	11
5	19	18	20	6	
9	19	11	12	11	
11	16	8	6	12	

TEST III

Grit Type: Lot 212 Alum. Oxide Speed: 851 RPM
Work Material: 150A Titanium Feed: 3/4 ipm

8	14	7	29	22	27
-	19	20	11	8	33
8	11	19	19	16	
15	27	18	20	26	
12	15	29	17	13	
27	6	17	17	26	
15	13	11	22	10	
26	10	9	19	18	
13	19	7	22	8	
24	17	8	20	37	
7	9	8	14	23	
4	14	9	14	7	
13	17	10	22	27	
20	8	29	15	34	
8	10	16	6	14	
5	11	28	24	26	

Grit Type: Lot 212 Alum. Oxide Speed: 666 RPM
Work Material: 150A Titanium Feed: 5/8 ipm

1	1	14	27	16	33
-4	18	11	26	6	8
7	0	12	29	11	35
4	-1	16	5	32	36
10	34	9	11	24	
-1	19	17	13	12	
9	34	22	24	18	
5	16	5	31	26	
-3	25	19	18	19	
19	27	26	15	7	
-3	22	16	24	26	
2	21	10	34	22	
17	27	24	27	7	
-2	23	22	24	14	
11	25	22	32	27	
14	6	19	25	26	

TEST III

Grit Type: Lot 212 Alum. Oxide Speed: 529 RPM
Work Material: 150A Titanium Feed: 1/2 ipm

13	25	18	18	18	22
5	14	20	26	22	31
28	25	0	25	28	17
17	16	23	22	8	30
10	28	16	9	23	17
15	17	20	17	6	20
34	9	24	23	19	21
16	0	12	22	26	26
12	26	26	28	20	
17	8	25	25	24	
16	26	18	23	19	
12	7	26	29	17	
29	16	22	13	45	
13	22	20	31	20	
30	10	23	28	0	
19	22	21	22	33	