

ON THE ORGANIZATION OF THE LEXICON

by

ROCHELLE LIEBER

A.B., Vassar College  
(1976)

SUBMITTED IN PARTIAL FULFILLMENT  
OF THE REQUIREMENTS OF THE  
DEGREE OF

DOCTOR OF PHILOSOPHY

at the

MASSACHUSETTS INSTITUTE OF TECHNOLOGY

May 1980

© Rochelle Lieber 1980

The author hereby grants to MIT permission to reproduce and to  
distribute copies of this thesis document in whole or in part.

Signature of Author . . . . .  
Department of Linguistics and Philosophy  
May 2, 1980

Certified by . . . . .  
Thesis Supervisor

Accepted by . . . . .  
Chairman, Departmental Committee

**ARCHIVES**  
MASSACHUSETTS INSTITUTE  
OF TECHNOLOGY

MAY 12 1980

## ON THE ORGANIZATION OF THE LEXICON

by

Rochelle Lieber

Submitted to the Department of Linguistics and Philosophy  
on 2 May 1980 in partial fulfillment of the requirements for  
the Degree of Doctor of Philosophy

## ABSTRACT

This study attempts to broaden the theory of morphology in two respects. First, it is argued that both inflectional and derivational morphology should be performed within the lexicon, and, in fact, that they require the same sorts of formal processes. Second, an attempt is made to constrain the interaction of morphological rules, and thereby to limit the notion of "possible word".

A theory of the organization of the lexicon is proposed. The lexicon consists of a list of all unanalyzable terminal elements and their lexical entries. Inflectional stem variants are listed, with relationships among them expressed by means of devices called morpholexical rules. In the lexical structure subcomponent, terminal elements are inserted into binary branching unlabeled trees subject to subcategorization restrictions on affixes. Lexical trees are labeled by means of general feature percolation mechanisms. The mechanics of lexical structure are illustrated with an analysis of the Latin verb paradigms; exactly the same mechanisms needed for producing derived words in Latin are also needed for producing inflected words. The subject of morphological conversion is considered in Chapter 3: it is argued that most phenomena usually treated with a zero-affixation analysis cannot be so analyzed. An alternative, non-directional analysis of conversion is proposed.

The third subcomponent of the lexicon consists of a block of string dependent morphological rules, some of which must have transformational power. The properties of these rules, as illustrated by reduplication rules in Tagalog and umlaut processes in German, are shown to follow from constraints placed on other subcomponents of the morphology.

Thesis Supervisor: Morris Halle

Title: Ferrari P. Ward Professor of Modern Languages and Linguistics

**ACKNOWLEDGEMENTS**

Once, I imagined a thesis to be the result of a great flash of inspiration: one waited until the Muse tickled, grabbed a pencil, tapped into that electric impulse, and wrote furiously. Four years at MIT have taught me otherwise. Theses are not written in solitude, and therefore I'd like to acknowledge some of the people who have shared the role of Muse for me in the writing of this thesis.

First and foremost, I would like to thank Morris Halle, my advisor, teacher and chief inspiration (and mayor of the metaphorical Minsk); he has influenced my work at every point, from the first problem set in baby phonology to the final dotting of i's in this thesis, and is responsible for raising the questions that led to many of the ideas expressed here. Thanks also are due to the other members of my committee, Joan Bresnan, whose own work in syntax originally suggested that a study of inflection in morphology would be of interest, and Jim Harris, whose inexhaustible supply of facts on Spanish and insistence on correctness of detail always kept my ideas percolating. To both Jim and Florence Harris, for moral support and friendship above and beyond, not to mention skating at the Res, I am especially grateful. My other teachers, Jay Keyser, Noam Chomsky, Wayne O'Neil, Ken Hale, and Paul Kiparsky have also influenced my thinking more or less directly at various points. In addition, Edwin Williams' class in morphology at MIT (spring 1979) added new directions to my incipient work. Margaret Allen and Mark Aronoff each discussed parts of this study with me. To them also, I am grateful.

Thanks also to all of the fellow students, MIT folks, and

international hangers-around who have made MIT Linguistics a community in the real sense. I have discussed my ideas with many of them, especially Ann Farmer, Mark Baltin, Tim Stowell, Osvaldo Jaeggli, Bruce Hayes, Tarald Taraldsen, David Nash, Jane Simpson, Wilson Grey, and Mohanan. Thankyou thankyou to Alec Marantz for reading and commenting on the chapter on reduplication, etc. I am especially grateful to my friend and typist Bonnie Wilker Stephens for her beautiful preparation of my manuscript.

Final thanks go to the women of McCormick Hall, and especially to Sally Wolford and Meeta Vyas, for keeping me laughing through the worst. In many ways, they made the writing of this thesis possible.

This thesis is dedicated, with love, to my family (the ganze mishpochah), and to the memory of my grandmother.



## TABLE OF CONTENTS

	<u>Page</u>
ABSTRACT	2
ACKNOWLEDGEMENTS	3
INTRODUCTION	8
FOOTNOTES	18
CHAPTER 1: INFLECTIONAL STEM ALLOMORPHY AND THE LEXICON	19
1. Compounding in German	20
1.1. German Noun Classes	20
1.2. Lexical Classes and Morpholexical Rules	24
1.3. Compounding and Stem Allomorphy	29
2. Old English Strong Verbs	34
2.1. Vowel Gradation in Old English Strong Verbs	34
2.2. OE Nominalizations in -i	41
3. Farther Afield	44
3.1. Latin	44
3.2. Tagalog	51
4. Conclusion	53
FOOTNOTES	55
CHAPTER 2: THE ORGANIZATION OF THE LEXICON	59
1. A Morphological Framework	61
1.1. The Permanent Lexicon	61
1.1.1. Lexical Entries	62
1.1.2. Category Classes, Lexical Classes and the Nature of Morpholexical Rules	67
1.2. Lexical Structure	78
1.3. Lexical Transformations and String Dependent Rules	104
1.4. Lexical Semantics	109
2. Latin Verb Paradigms	118

2.1.	Latin Phonology	119
2.2.	Morphology of the Latin Verbs	133
2.2.1.	Morpholexical Classes	140
2.2.2.	Inflectional Affixes	146
2.3.	More Latin Paradigms	163
2.4.	Latin Prefix Verbs	167
3.	Morphological Productivity	175
	FOOTNOTES	181
CHAPTER 3:	MORPHOLOGICAL CONVERSION	187
1.	Against Zero Affixation	188
2.	Against Any Directional Rule of Conversion	195
3.	Conversion as a Redundancy Rule in the Permanent Lexicon	198
4.	The Semantics of Conversion	203
5.	The Scope of Conversion	206
6.	Diversion on Root and Suffix Allomorphy and Truncation Rules	217
7.	Zero-Affixation: Possible Real Cases	225
	FOOTNOTES	232
CHAPTER 4:	STRING DEPENDENT WORD FORMATION AND LEXICAL TRANSFORMATIONS	234
1.	On Restricting the Power of Word Formation Rules	236
2.	Reduplication as a Transformation	246
2.1.	Properties of Reduplication	247
2.2.	The Locality of Reduplication	253
2.3.	Reduplication Summary	270
3.	Umlaut	272
3.1.	Umlaut as a Morphological Process	273
3.2.	Two Possible Reanalyses of Umlaut	281
3.3.	Umlaut and Inflection	293
3.3.1.	Nouns	294
3.3.2.	Verb Paradigms	297
3.3.3.	Adjectives	303

3.4. Umlaut and Conversion	305
3.5. Umlaut Summary	308
4. Theoretical Speculations	311
FOOTNOTES	318
BIBLIOGRAPHY	321
BIOGRAPHICAL NOTE	327

It is the goal of this study to propose a unified theory of word formation in generative grammar, unified in that inflectional and derivational word formation, affixational and non-affixational word formation are accomplished within a single lexical component of the grammar in a principled and highly constrained way. It is an attempt to characterize the formal mechanisms available for word formation, and in doing so, the notion of 'possible word', where 'word' is taken in a broad and intuitive sense to mean a meaningful item which is isolable in a syntactic string -- i.e., a phonological word, in the sense of Chomsky and Halle (1968). That the development of such a theory would be a useful contribution to linguistic theory at this point in time is suggested by a number of developments, both in morphology and syntax.

Morphology has only recently established itself within generative grammar as a subfield in its own right, possessing its own theoretical framework separate from syntax and phonology, and its own continuing dialogue on theoretical issues and problems. Groundbreaking works such as Chomsky's (1970) "Remarks on Nominalization", Halle's (1973) "Prolegomena to a Theory of Word Formation", Siegel's (1974) Topics in English Morphology, Jackendoff's (1974) "Morphological and Semantic Regularities in the Lexicon", and Aronoff's (1976) Word Formation in Generative Grammar set the original boundaries for the study of word formation, carving off from the domains of syntax and phonology a class of phenomena that included derivational affixation, compound formation, and associated allomorphy phenomena. Chomsky (1970) argued that nominalizations such as destruction and refusal should not be derived from the corresponding verbs destroy and refuse by means of syntactic

transformations: the relationships between nominalization and verb were too varied and idiosyncratic to justify transformational derivation. The relating of the nominalizations to their corresponding verbs was relegated to a part of the grammar called the lexicon, the internal geography of which was left largely uncharted.

The work of Siegel, Jackendoff and Aronoff constituted the first attempts to provide structure to the lexicon. These studies concentrated on the problems of determining what items were to have entries in the lexicon, and how lexical items were to be related to one another -- for example, whether all words, complex and underived alike were to be listed, with relationships between derived and underived forms expressed as redundancy rules (cf. Jackendoff 1974), whether complex words were to be derived via generative rules, and only non-derived morphemes listed (an option which at least in part constituted Halle's (1973) proposal), or whether some combination of the two extremes was to be preferred (Aronoff's position). Aronoff (1976), probably the most widely accepted of the early theories of morphology, proposed a sort of formal device called a word formation rule (WFR) which both created new words and analyzed already existing complex words. He also raised questions about the proper way of constraining word formation processes (within his theory, words can only be derived from other words), examined other lexical processes called readjustment rules which alter the shape of morphemes in the presence of other morphemes, and explored how morphological productivity was to be expressed within a theory of word formation. Siegel (1974) concentrated primarily on the properties of derivational

affixation in English, in particular, on the distinction between what she called +-affixes, affixes which affect the stress placement and phonological form of the derived word, and #-affixes, affixes which have no stress or phonological effect. Much of the subsequent literature in generative morphology (e.g., Allen 1978, Strauss 1979) has been concerned with refining the frameworks of Siegel and Aronoff, for example, with exploring the intricacies of the +/#-affix distinction in English.

For the most part, these foundational works in generative morphology agreed, however, in excluding inflectional morphology, that part of word formation concerned with grammatical distinctions such as case, person, number, tense, and aspect, from the domain of the lexicon.<sup>1</sup> Early generative syntactic theory assumed that inflectional affixes were to be added to a syntactic structure as syntactic features in the course of a transformational derivation. Syntactic features were converted to actual segmental morphological material at surface structure, or at least before the application of phonological rules, by the operation of formal devices known as morphological readjustment rules. In general, the question of the place of inflectional morphology in generative grammar was neglected, a neglect that at least partially stemmed from the fact that English, the language on which most of the pioneering work in generative theory was done, is very poor in inflection. On the one hand, a great deal of progress can be made in the study of English even if inflection is completely ignored. On the other hand, the study of the insignificant amount of inflection that there is in English yields little insight into the sort of theoretical

mechanisms necessary for treating inflectional word formation in general.

A number of recent developments, both in morphology and in syntax, however, have begun to weaken the boundaries set on the lexicon by early syntactic and morphological work, and to raise questions about the sorts of phenomena which are of interest within a theory of the lexicon. For example, theories of lexicalist syntax such as Bresnan (1978, 1980), which claim the active-passive relation to be a lexical one, raise the possibility that inflected forms have some place in the lexicon: such theories have argued that a verb and its passive participle both have some sort of lexical representation, one being related to the other by a lexical redundancy rule which states in this case that the subject of the passive participle corresponds to the object of the active verb. Such theories presuppose some form of word formation process which generates these participles, or at least relates them morphologically to their corresponding verb. From a slightly different perspective, Lapointe (1978) argues that a theory of grammar in which all morphology is confined within a single component, namely the lexicon, is more constrained, and therefore more desirable than a theory in which derivational morphology is lexical and inflectional morphology syntactic: he proposes what he calls the Strong Lexicalist Hypothesis (SLH) "which posits that syntactic transformations never have to be allowed to perform morphological operations" (1978:3). Again, a theory encompassing the SLH presupposes some sort of lexical mechanism to produce inflected words.

From the direction of morphology as well, there have come indications that the widely accepted division between derivational and

inflectional morphology is not in fact clear: works such as Carrier's (1979) on Tagalog word formation and McCarthy's (1979) on Semitic suggest that the same sorts of formal processes may be needed for both inflection and derivation. These works have added interest in that the processes in question -- reduplication in Tagalog and reduplication and gemination-like processes in Semitic -- have no obvious place in the standard theoretical framework provided by Aronoff, Siegel, et al. Such non-affixational processes, where treated at all (cf. Aronoff 1976) are considered to be formally identical to affixation processes, although they seem to have rather different properties from affixation.

This thesis fits into the background I have briefly sketched in the following way: in it, I will attempt to explore the limits of the lexicon and to redraw the boundaries of the study of word formation. Redefining the subject of generative morphology to include inflection as well as derivation will necessitate, in turn, rethinking the theoretical foundations of morphology. The major goal of this study, then, is to develop in some detail the sort of theory of word formation consistent with this enlarged domain.<sup>2</sup> The theory which results will have empirical consequences with respect to non-affixational morphology which clearly set it apart from previous theories. This study is not intended to be an exhaustive study of the morphology of any one language: throughout, I will draw examples, often in some depth, from languages like German, Latin, and Tagalog, which have more complex patterns of inflection than English. Often these will give insight into phenomena in English as well.

In Chapter 1<sup>3</sup>, I will present one sort of evidence that suggests



that inflectional word formation should have a place in the lexicon: the sorts of stem allomorphs according to which nouns, verbs, and adjectives in various inflecting languages form their plurals, pasts, participles, etc. often form bases for rules of derivation and compounding. Since derivation and compounding have been counted as lexical processes within all theories of word formation to date, I will argue that inflectional stem allomorphs must be available in the lexicon to feed these processes. I will propose that inflectional stem allomorphs according to which lexical items fall into conjugation and declension classes should be listed in lexical entries, listed stems being related to roots by means of a relation I will call a morpholexical rule. This sort of proposal will be compared to a more traditional non-lexical analysis of inflection making use of morphological readjustment rules operating post-syntactically. The lexical proposal, even in its roughest form, will prove to be superior.

Chapter 2 sets down the basic assumptions needed for a theory of word formation, and provides the theoretical context into which the morpholexical rule device proposed in Chapter 1 will fit. I argue here that the lexicon consists of three subcomponents, each with its own properties and its own characteristic formal devices. The foundation of the word formation component is a subcomponent called the permanent lexicon consisting of lexical entries for all unanalyzable morphemes. Lexical entries contain idiosyncratic information about morphemes -- their category, subcategorization, diacritic specifications, semantic representations, syntactic argument structures, and so on. They allow us, moreover, to determine which morphemes are stems and which affixes;

these terms need not be counted as primitives, given the form of lexical entries I propose here. Lexical entries in the permanent lexicon will be further organized according to major category and conjugation or declension class (referred to collectively as lexical class); each lexical class is defined by morpholexical rules, and the stem allomorphs related by these morpholexical rules. The properties of morpholexical rules will be discussed. The second subcomponent of the morphology is called the lexical structure component: this consists of a rule generating binary branching unlabeled trees into which morphemes from the permanent lexicon are inserted subject to their subcategorization restrictions. Lexical trees will be labeled according to a small number of highly constrained Feature Percolation Conventions. This system of lexical structure will be compared to those previously proposed by Selkirk (1978) and Williams (1979). The permanent lexicon together with the lexical structure component will provide the theoretical basis for all concatenative word formation processes including affixation and compounding. The third subcomponent of the morphology will contain rules of word formation which must refer to properties of the segmental string on which they operate; rules such as reduplication, infixing, vowel ablaut and umlaut processes are among the sorts of operations characteristic of this subcomponent (this subject will be discussed more extensively in Chapter 4). The place of semantic interpretation in morphology will also be touched upon in Chapter 2. It will be argued that the syntax or structural aspect of word formation is not necessarily isomorphic with the semantics of word formation and that the two should in principle be considered independent

of one another. The second half of Chapter 2 is an attempt to illustrate the mechanics of the theory proposed through a detailed analysis of the Latin verb paradigms. It will emerge that exactly the same formal devices independently needed for derivational processes are also needed for analyzing the complex inflectional paradigms of the Latin verbs. This provides some additional confirmation for the idea that inflection and derivation are not in principle different sorts of word formation; it is at least logically possible that a different state of affairs should obtain, since inflection could conceivably require the use of formal mechanisms entirely different from those needed for derivation.

Chapter 3 is concerned with the problem of morphological conversion: it has been argued that pairs of words such as paint<sub>N</sub> and paint<sub>V</sub> and in German Ruf<sub>N</sub> 'call' and rufen<sub>V</sub> 'call' are related by deriving one member of each pair from the other via affixation of a zero morpheme. Here, I will present evidence that the zero-affix we would need to postulate for pairs such as these does not exhibit the behavior of overt derivational affixes: zero morphemes do not place their outputs in unique lexical classes as overt derivational affixes do, nor do they impose unique syntactic argument structures on their outputs, another property of derivational affixes. To analyze these phenomena as zero-affixation would therefore weaken the theory outlined in Chapter 2. I will argue instead that both members of a pair like paint<sub>N</sub>, paint<sub>V</sub> are to be listed in the permanent lexicon, one form being related to the other by redundancy rule. Morphological conversion is therefore structurally non-directional. I will argue further that the semantic rules

interpreting members of conversion pairs may very well be directional, the semantic representation of one member being at least in part derivative of the semantic representation of the other. The final part of this chapter will be concerned with a number of questions raised by the non-directional analysis of conversion, for example, the status of forms in -ate in English, and the necessity for rules of truncation and allomorphy as defined by Aronoff (1976). Phenomena which required truncation and allomorphy rules within Aronoff's framework will be analyzed here without these special rule types: only mechanisms already motivated in Chapter 2 will be needed for the relevant data.

The final chapter in this study will concentrate on string dependent word formation, on the properties of these rules and the constraints which must be placed on them within a reasonable theory of word formation. I will first consider a proposal by McCarthy (1979) that morphological rules be formally constrained by prohibiting the use of transformational notation: data from Tagalog (Carrier 1979) suggest that some reduplication processes at least require transformational power, and therefore that McCarthy's constraint is too strong. In order to approach the subject of constraints on morphological rules from another perspective, I will discuss Carrier's analysis of Tagalog reduplication in some detail: besides requiring transformational statement, Tagalog reduplication exhibits a number of other unusual properties. The three processes of reduplication needed for Tagalog occur over and over again in all sorts of word formation. They have no isolable semantic representation. They are triggered by the presence of a feature. They never by themselves (i.e., without accompanying

affixation) change the category of a word, and they never seem to add to or change the internal structure of the words on which they operate. I will next argue that umlaut in German is a morphological process which must be analyzed by means of a string dependent morphological rule (umlaut cannot be expressed as a morpholexical relation); curiously, the rule of umlaut that I will propose exhibits exactly the same properties as Tagalog reduplication does. The final part of this chapter will attempt to show that the cluster of properties exhibited by both rules is not, in fact, accidental: precisely this set of properties is predicted for string dependent rules by the organization of the lexicon already proposed in Chapter 2, by virtue of the fact that string dependent morphological rules are not morphemes. The sort of string dependent rules possible within this theory is thus automatically highly constrained.

## FOOTNOTES: INTRODUCTION

1. Halle (1973) was the exception here.
2. This is not the first attempt in the literature to integrate inflection and derivation under a unified theory of word formation: Selkirk (1978) and Williams (1979) both assume inflection and derivation to be in principle the same sort of word formation, and base a number of proposals on this assumption. As the theory to be developed below has been strongly influenced by these proposals, they will be discussed in some detail in Chapter 2.
3. An earlier version of this chapter was circulated under the title "Inflection and the Lexicon".

## CHAPTER 1: INFLECTIONAL STEM ALLOMORPHY AND THE LEXICON

The purpose of this thesis as a whole, as outlined in the Introduction, is to present a unified theory of word formation, one which is rich enough to allow the generation of both derived and inflected words and to handle non-affixational types of word formation, but constrained enough to rule out types of word formation that do not seem to occur. The first step towards developing such a unified theory is to show that there is at least prima facie plausibility to the claim that inflectional word formation should be treated in the word formation component of our grammar. Although theories of lexicalist syntax (e.g., Bresnan 1978, Wasow 1977), at least, have assumed that such inflectional forms as passive participles must be represented in the lexicon, there appear in the literature no solid arguments, to my knowledge, which show conclusively from the point of view of morphology that this must be the case. In this chapter, I will therefore present evidence that stem allomorphy usually associated with inflectional paradigms must be considered a word formation process to be handled in the word formation component of our grammar: to analyze these allomorphy facts as non-lexical (i.e., syntactic) leads to a great deal of unnecessary complexity. The argument is quite simple: stem allomorphs usually associated with inflectional paradigms frequently act as bases for further word formation. Processes of derivation and compounding, which are generally agreed to be lexical processes, can apply to what are usually considered to be inflected stems. I will use as examples here the interaction of German nominal stems and compounding, a case of nominalization from non-present stems of strong verbs in Old English,

and a number of cases of derivation from verb stems in Latin and Tagalog. Other examples of the same phenomenon will appear throughout this thesis. Below, I will begin by making the bare minimum of theoretical assumptions about word formation: I will assume some sort of autonomous word formation component containing lexical entries and some sort of formal mechanisms for putting together complex words, including derived words and compounds. At this point, my arguments about inflectional stem allomorphy will go through assuming even a very rudimentary conception of the word formation component. The formal nature of lexical entries and word formation processes will be discussed in greater detail in Chapter 2.

## 1. Compounding in German

### 1.1. German Noun Classes

I will start first with some facts about the German noun paradigms. In one of the few works in generative literature largely devoted to inflection, W. Wurzel (1970) makes the observation that German nouns do not seem to exhibit the same set of inflectional endings if the inflected word is conceived of as merely a combination of root plus inflectional ending. Consider, for example, the nominal paradigms in (1a-d):



(1)	a.	'brook'		b.	'father'	
		sg.	pl.		sg.	pl.
	N	Bach	B $\ddot{u}$ che		Vater	V $\ddot{a}$ ter
	A	Bach	B $\ddot{u}$ che		Vater	V $\ddot{a}$ ter
	G	Bachs	B $\ddot{u}$ che		Vaters	V $\ddot{a}$ ter
	D	Bach	B $\ddot{u}$ chen		Vater	V $\ddot{a}$ tern
	c.	'spirit'		d.	'name'	
	N	Geist	Geister		Name	Namen
	A	Geist	Geister		Namen	Namen
	G	Geistes	Geister		Namens	Namen
	D	Geist	Geistern		Namen	Namen

That is, if we assume that the form of a word must be root+inflection, we are forced to set up four different case paradigms for these four different words: (1a) has a  $\emptyset$  affix in the nominative, accusative, and dative singular, -s in the genitive singular, as does (1b). These two, however, differ in their plural forms, (1a) having -e plus umlaut in the N,A,G plural, umlaut plus -en in the D plural, (1b) having only umlaut in the N,A,G plural, umlaut plus -n in the D plural. (1c) differs from both (1a) and (1b) in the plural, with -r in the N,A,G plural, -rn in the dative plural. Finally, (1d) exhibits -n as the case ending in all forms except N singular, which has  $\emptyset$ , and G singular which has -ns. Obviously, generalizations are being missed here, for example, that the last consonant in the genitive singular is -s, and the last consonant in the dative plural -n. These four nouns, moreover, do not exhaust the number of different inflectional paradigms we would need to postulate if we

were to maintain the assumption that a word consists of a root plus inflection; other nouns seem to exhibit still different case paradigms.

Wurzel argues that a simpler and more general view of German results if we consider the inflected form to consist of a stem plus inflection, rather than a root plus inflection, and postulate a uniform set of inflectional endings as follows (I am using the terms root and stem at this point in an intuitive and pretheoretic way; I will provide a strict definition of these terms in Chapter 2, where it will turn out that a root is always a stem, but not vice versa):

(2)	sg.	pl.
N	-∅	-e
A	-∅	-e
G	-s(M,N), ∅ (F)	-e
D	-∅	-n

German nominal roots differ from one another in the way they form stems; all idiosyncrasy in the nominal paradigms is to be attributed to differences in stem allomorphy. According to Wurzel, the following different patterns are represented, membership in one class rather than another being more or less arbitrary.<sup>1</sup> Thus, the roots in (3a) have the stem allomorph forms in (3b):

(3)	a.	Bach	'brook'	b.	Bäch (pl.)
		Hund	'dog'		Hund
		Auto	'auto'		Autos (pl.)
		Mann	'man'		Männer (pl.)
		Geist	'soul'		Geister (pl.)
		Bär	'bear'		Bären (non-nominative)
		Aug	'eye'		Auge (nominative) Augen (non-nominative)
		Garten	'garden'		Gärten (pl.)

The inflectional endings listed in (2) attach to the roots and stems listed in (3), singular inflectional endings attaching to singular stems, if such a distinction is made, plural inflectional endings to plural stems, and so on. According to Wurzel, the stem plus inflection combination is then subject to the following independently motivated phonological rules: (i) e-Epenthesis, which inserts an -e between two consonants separated by a morpheme boundary, (ii) a general rule of degemination, and (iii) a rule of e-Deletion, which deletes an -e if it follows an unstressed e plus sonorant. Thus, the forms Bach and Vater in (1a) and (1b) actually belong to the same class. They both have an umlaut plural stem to which, for example, the nominative plural inflection -e will be added. Their derivations differ in the applicability of e-deletion in Vater, but not in Bach, however:

(4)	root	Bach	Vater
	plural stem	Bäch	Väter
	Nom. pl.	Bächte	Väterte
	e-deletion	---	Väter

Derivations for some of the dative plurals of nouns in (1) are as follows:

(5)	root	Vater	Geist	Nam
	plural stem	Väter	Geister	Namen
	dative pl.	Vätern	Geistern	Namen
	e-epenthesis <sup>2</sup>	Väterten	Geisterten	Namenten
	e-deletion	Vätern	Geistern	Namen
	degemination	---	---	Namen

Wurzel's fundamental insight is thus that the inflected noun in German consists of a stem (which may or may not be equivalent to the root) plus an inflection. In (3), I have merely listed roots and stems without determining how stems are formed from roots, or where the entities called roots and stems are represented in the grammar. In the following section, I will make a tentative proposal that both roots and stems are listed in the lexicon as members of clearly defined inflectional classes. This framework will then be compared with a traditional syntactic sort of treatment of inflection such as Wurzel's, and it will be shown how a theory in which inflectional stems are represented somewhere in the lexicon makes predictions about possible word formation processes in German which a syntactic account of inflectional stems does not make.

## 1.2. Lexical Classes and Morpholexical Rules

Let us assume initially the following organization of the lexicon. Each major category type (noun, verb, adjective) in the lexicon is divided into lexical classes which consist of roots of that category type and related stems. The term related will be used here in a special

sense. Items A and B listed in the lexicon will be said to be related if there exists a rule of the form (6):

$$(6) \quad X \sim X'$$

where X and X' represent segmental strings differing from one another in some fashion, and A shares the properties of X and B shares the properties of X'. For the time being, let us say that B represents a class of stems, and A a class of roots (this will be modified somewhat in Chapter 2).

A lexical class (corresponding to the declensional and conjugational class of traditional grammar) consists of a rule or rules of the type (6), hereafter called morpholexical rules, plus both the roots and the stems that are related by these rules. That is, both roots and related stems are listed independently in the lexicon. Lexical classes are distinguished from one another by differences in the morpholexical rules which define them. Finally, membership of a given root in a particular lexical class is not predictable from any properties of the root, e.g., it is not possible to predict from any independent property of a root Mann that it belongs to a lexical class with a related stem Männer.

Now we have the theoretical machinery necessary to account for the sorts of data illustrated in (3). A number of lexical classes are needed to cover the range of German nominal paradigms. These lexical classes are defined by the choice of morpholexical rules from the following inventory:

$$(7) \quad X \sim X_n$$

- (8)  $X \sim Xe$
- (9)  $C_o VC_o \sim C_o \overset{\text{II}}{V} C_o r^3$
- (10)  $X \sim Xs$
- (11)  $C_o V C_o \sim C_o \overset{\text{II}}{V} C_o$

Given the morpholexical rules in (7)-(11) above, the lexical classes for German nouns consist of the following:

- CLASS 1: morpholexical rule (11)  $C_o VC_o \sim C_o \overset{\text{II}}{V} C_o$
- roots: Bach, Vater, Kloster, Mutter
- stems: Bäch, Väter, Klöster, Mütter
- CLASS 2: morpholexical rule (10)  $X \sim Xs$
- roots: Streik, Auto
- stems: Streiks, Autos
- CLASS 3: morpholexical rule (9)  $C_o VC_o \sim C_o \overset{\text{II}}{V} C_o r$
- roots: Geist, Mann, Buch
- stems: Geister, Männer, Bücher
- CLASS 4: morpholexical rule (7)  $X \sim Xn$
- roots: Staat
- stems: Staaten<sup>4</sup>
- CLASS 5: morpholexical rule (7)  $X \sim Xn$
- roots: Bär
- stems: Bären



(12)         $v \longrightarrow \ddot{v} / \text{---} ] + \text{pl. umlaut}$

The alternative framework proposed above eliminates the largely redundant feature matrices from lexical entries (e.g., all [-strong] nouns are also [-r-stem], [-s-plural], and all [+feminine] nouns are [-r-stem], and so on), and substitutes the morpholexical rule as a determinant of class membership. The crucial difference between the two frameworks, however, is the following: the stem allomorphs which are related to roots by morpholexical rules are listed in the lexicon as part of the lexical entry for the root forms, whereas the output of the morphological readjustment rules in the traditional framework is not. From this difference in the contents of the lexicon, crucial differences in the empirical predictions made by the two theories can be derived: since stems are listed in the lexicon under the morpholexical theory of inflection, we would expect them to be available to processes of word formation such as derivation and compounding, which are generally assumed to operate on items listed in the lexicon. Thus, although we might not expect, at this point, to find a derived word or compound containing the dative plural form of a noun Vättern (nothing has been said yet about the location in the grammar of actual case endings, but cf. Chapter 2), we should expect to find derivatives or compounds based on the stem allomorph Väter. A theory such as Wurzel's predicts that derivation and compounding should have access only to nominal roots (e.g., Vater), since all inflectional processes take place outside the lexicon. This is a very strong empirical prediction; the following section will therefore be devoted to testing it against some facts about German word formation.



## 1.3. Compounding and Stem Allomorphy

Wurzel, who devotes a section of his book on German word structure to compounding, notes that there exist nominal compounds in German of the following form:

(13)	a.	Arbeitszeit	'worktime'
		Geburtstag	'birthday'
	b.	Sternenschein	'starshine'
		Straussenfeder	'ostrich feather'
	c.	Rechnungsart	'method of calculation'
		Einheitspreis	'fixed price'
		Geschwindigkeitsgrenze	'speed limit'
		Wissenschaftslehre	'theory of knowledge'

What is notable about all the forms in (13) is that the compound, in each case, consists of a base noun (e.g., Zeit in Arbeitszeit) plus another noun (i.e., Arbeit) to which a consonantal stem extension has been added (-s in Arbeitszeit, -n in Sternenschein), and in each case, this stem extension does not correspond to any of the inflected or stem forms of the noun. Nouns like Arbeit and Geburt, which are feminine, form their plural with a stem allomorph with the stem extension -en, and not -s. Feminine nouns are uninflected in the genitive singular, the only other source of -s in the nominal paradigm. Similarly, derived nouns in -heit, -keit, -ung, and -schaft, which are all feminine, have -s nowhere in their paradigms. Finally, a very small number of masculines like Stern and Strauss exhibit the -n extension as in (13b); these nouns form their plurals in -e, are not weak nouns,

and therefore have no stem form with the -n extension as part of their lexical entries.

Consider, however, the compounds in (14):

- (14) a. Vätersitte 'manners of our forefathers'  
 Vaterland 'fatherland'  
 Mütterverschickung 'evacuation of expectant mothers'  
 Mutterfreuden 'maternal joy'

(cf. Vater, stem allomorph = Väter

Mutter, stem allomorph = Mütter)

- b. Geistbildend 'formative, educational'  
 Geisterseher 'visionary seer'  
 Buchbinder 'book binder'  
 Bücherfolge 'series of books'  
 Mannloch 'manhole'  
 Männerkleidung 'man's dress'

(cf. Geist, stem allomorph = Geister

Buch, stem allomorph = Bücher

Mann, stem allomorph = Männer)

- c. Bärenfell 'bearskin'

(cf. Bär, stem allomorph = Bären)

- d. Affenweibchen 'she-ape'  
 Augapfel 'eyeball'  
 Augenarzt 'eyedoctor'

(cf. Aff, stem allomorph = Affe, Affen

Aug, stem allomorph = Auge, Augen)

e. Staatenbund	'confederation'
Schwesterkind	'sister's child'
Schwesternliebe	'sisterly love'

(cf. Staat, stem allomorph = Staaten

Schwester, stem allomorph = Schwestern)

The compounds in (14) differ from those in (13) in an obvious way: the forms of the noun which attaches to the base noun correspond exactly to the root and stem forms of the class to which that noun belongs. Only nouns belonging to Class 1 have unlauded forms in compounds (Vätersitte, Mütterverschickung). Only nouns in Classes 4 or 5 have -n forms in compounds (Staatenbund). Only nouns with r-stem allomorphs (Class 3) have r-stems in compounds (Geisterseher, Bücherfolge). We thus seem to have two contradictory states of affairs. Some compounding in German (i.e., (13)) seems to be arbitrary and independent of the class to which a noun belongs, whereas other compounding is closely tied to the class membership of the compounding noun.

The theory in which inflectional stem allomorphs are listed in the lexicon accounts for the data above in the following way: since this theory assumes that class membership is defined by a set of morpholexical rules and that both the roots and the stem allomorphs related by those rules are listed segmentally in lexical entries, this theory actually predicts that compounds like those in (14) should exist: although it provides no explanation, in any given case, whether a noun with more than one stem will have compounds on each existing stem allomorph, it predicts that the use of any root or stem form in compounding should be possible. The sorts of compounds listed in (13), however, are

problematic for this theory of inflection: since the stem form exhibited in the compounds does not correspond to any stem form in the nominal paradigms for these nouns, we have no choice but to consider these forms as exceptions -- e.g., lexical entries for derived words in -heit, -keit, -ung, and -schaft would have to have a special feature indicating that they take an -s extension in compounds. However, the sorts of forms found in (13) represent a minority of German compounds (only one other masculine noun taking an arbitrary -n in compounds exists: Schelm 'rogue'); the majority of compounding in German follows the pattern of (14).<sup>5</sup>

A traditional framework for inflection hardly fares as well in explaining the kinds of compounds found in German. Consider what Wurzel has to say about compounds: on the basis of the compounds in (13), Wurzel claims that the stem forms of compounding nouns are completely arbitrary, and that each noun must therefore be individually marked for the stem forms it will exhibit in compounds. Wurzel fails to distinguish compounds like those in (14) as different from those in (13), let alone to indicate that this type constitutes the majority. He therefore introduces a far greater level of exceptionality into his grammar than is necessary. Nouns like those in (13) must ostensibly be marked as exceptions in any framework, but to claim that all 'compounding stems' are arbitrary implies that each German noun, regardless of how it compounds, must have idiosyncratic information in its lexical entry as to its compounding stem(s). Moreover, it will certainly turn out that in the majority of cases (i.e., those resulting in compounds like (14)), this 'idiosyncratic' information about

compounding stems will exactly replicate the features specifying the lexical class membership of that noun. That is, if we find a compound like Geisterseher, we will have to list a compounding stem feature [+r-stem] for the noun Geist, even though Geist is already specified [+r-stem] as a part of its inflectional class membership. Similarly, we will have to indicate that Vater forms compounds with an umlaut stem, in addition to assigning it a feature [+ plural umlaut] for its inflectional class. Wurzel's proposal thus results not only in unjustified exceptionality, but also in unjustified redundancy in lexical entries.

However, a traditional framework for inflection runs into problems explaining German compounds even if it accepts that in the general case class membership determines the possible stem forms in compounds. Although the traditional framework would now claim no more exceptionality in compounding than the morpholexical treatment (i.e., (13)), it will still run into purely mechanical difficulties in producing the proper compounds. Compounding is a process that takes lexical items and joins them into a single lexical item (in German having the category of the second of the two original items, but cf. Chapter 2). It is a process which operates wholly within the lexicon. According to the strongest form of the lexicalist hypothesis (cf. Lapointe 1978), no rule outside of the lexicon can affect the internal structure of the word. A traditional treatment of inflection will have lexical class membership indicated as a matrix of features (e.g., [+r-stem, + plural umlaut]) in the lexical entry of a noun, but will not have the actual segmental morphological material corresponding to

this feature available in the lexicon. Instead, this segmental material will only be added to nouns at surface structure when morphological readjustment takes place. Thus, the traditional framework of inflection will not have the proper stem forms available in the lexicon for compounding to make use of. Only roots will be available for the purposes of compounding. The stem forms which actually do show up in compounds will only come into existence in a component of the grammar to which compounding has no access. Thus, the traditional framework again fails to explain the basic data of German compounds. In contrast, the morpholexical theory actually predicts the form of the majority of compounds we find in German.

## 2. Old English Strong Verbs

### 2.1. Vowel Gradation in Old English Strong Verbs

If it were the case that only stem allomorphs associated with German noun paradigms ever appeared in complex words, the case for listing inflectional stem allomorphs in the lexicon would not be particularly strong. Moreover, it would be rather uninteresting if the property of having stem allomorphs listed in the lexicon should be a property peculiar to German. A much more interesting claim, and the one I wish to make here, is that the inclusion of at least this portion of inflection in the lexicon is a property of universal grammar. We should therefore expect to find that wherever a language exhibits stem allomorphy<sup>6</sup> in inflectional paradigms, these stem allomorphs appear as inputs to other processes of derivation and compounding. Such examples are not hard to find outside of German. For example, the theory in which stem allomorphs have some sort of

segmental representation in the lexicon also makes correct predictions with respect to the strong verbs of Old English.

My strategy in this section will be similar to the one in the previous section. I will first provide an analysis of vowel gradation in the OE strong verbs along the lines of the theory of inflection proposed in § 1., and then I will show how this analysis makes predictions about OE word formation processes and actually accounts for a class of OE nominalizations which are problematic for more traditional treatments of inflection.

For the purposes of this discussion, I will confine myself to the first five classes of strong verbs. Classes 6 and 7 could easily be subsumed within this analysis, but Classes 1-5 will suffice to make the relevant point about OE nominalizations. Classes 1-5 exhibit the following stem alternations, at least in surface forms:

(15)	INFINITIVE	PRET 1	PRET 2	PPLE
CLASS 1	drīfan 'drive'	drāf	drifon	drifen
CLASS 2	clēofan 'cleave'	clēaf	clufon	clofen
CLASS 3	helpan 'help'	healp	hulpon	holpen
	drinkan 'drink'	drank	drunkon	drunken
	weorpan 'throw'	wearp	wurpon	worpen
CLASS 4	beran 'bear'	baer	bāeron	boren
CLASS 5	sprecan 'speak'	spraec	sprāecon	sprecen

Traditionally, analyses of the strong verbs in OE start out by abstracting away from the surface forms all alternations which are the result of phonological rules independently motivated for the grammar of OE. The analysis to be presented here accepts this strategy. I therefore assume the following phonological rules for OE (some of which are adopted from Dresher (1978a) and O'Neil (1970)):

$$(16) \quad u \longrightarrow o \quad [+bk] \longrightarrow [-hi] / \text{---} \begin{bmatrix} +cons \\ -nas \end{bmatrix} C_o \begin{bmatrix} +syl \\ -bk \end{bmatrix}$$

$$(17) \quad a \longrightarrow ae \quad \begin{bmatrix} +bk \\ -rd \end{bmatrix} \longrightarrow [-bk] / \text{---} (V) \begin{bmatrix} +cons \\ -nas \end{bmatrix}$$

$$(18) \quad \text{Breaking (Dresher)} \quad \emptyset \longrightarrow \partial / \begin{bmatrix} +syl \\ -bk \end{bmatrix} \text{---} \begin{bmatrix} +cons \\ +son \\ -nas \end{bmatrix} [-syl]$$

$$(19) \quad e \longrightarrow i \quad \begin{bmatrix} -lo \\ -bk \end{bmatrix} \longrightarrow [+hi] / \text{---} [+nas]$$

Abstracting away from the forms in (15) the effects of rules (16)-(19), and also the inflectional endings for the infinitive, PRET 2 and PPLE forms, we are left with the following underlying stem allomorphs, which constitute the real substance of the vocalic ablaut series in OE:



(20)		INFINITIVE	PRET 1	PRET 2	PPLE
	CLASS 1	drīf	drāf	drif	drif
	CLASS 2	clēf	clāf <sup>7</sup>	cluf	cluf
	CLASS 3	help	halp	hulp	hulp
		drenk	drank	drunk	drunk
		werp	warp	wurp	wurp
	CLASS 4	ber	baer	bāer	bur
	CLASS 5	sprec	spraec	sprāec	sprec

A number of sample derivations starting with the underlying forms in (20) are illustrated in (21):

(21)	a.	cluf+on	cluf+en	
		---	o	(16) u → o
		clufon	clufen	
	b.	drank	warp	
		---	waerp	(17) a → ae
		---	waeǣrp	(18) Breaking
		drank	wearp	OE Spelling

(21a) illustrates the derivation of the PRET 2 and PPLE forms of cleofan and (21b) illustrates the derivation of PRET 1 forms of two CLASS 3 verbs drinkan and weorpan.

The theory of inflection in which stem allomorphs are listed in the lexicon assumes a series of morpholexical rules such as those in (22) characterizing the regularities between roots and stem allomorphs that do exist:

- (22) a.  $C_o \begin{bmatrix} +syl \\ \alpha lg \end{bmatrix} C_o \sim C_o \begin{bmatrix} +syl \\ +bk \\ +lo \\ \alpha lg \end{bmatrix} C_o$
- b.  $C_o [+syl] C_o \sim C_c \begin{bmatrix} +syl \\ -lg \end{bmatrix} C_o$
- c.  $C_o [+syl] C_o \sim C_o \begin{bmatrix} +syl \\ +hi \\ +bk \\ -lg \end{bmatrix} C_o$
- d.  $C_o VC_o \sim C_o \begin{bmatrix} +syl \\ +lo \\ -bk \\ -lg \end{bmatrix} C_o$
- e.  $C_o VC_o \sim C_o \begin{bmatrix} +syl \\ +lo \\ -bk \\ +lg \end{bmatrix} C_o$

One more assumption needs to be clarified at this point, before I go on to define the strong verb classes of OE. That is, most traditional treatments of the OE strong verbs (also O'Neil (1970), within a generative framework) assume that the underlying root forms of the five classes are respectively CeiC, CeuC, CeRC, CeR, and CeC, where R represents a sonorant consonant. Presumably, these are roughly the forms that the verbal roots had at some period prior to OE proper. Differences in stem forms in OE could originally be traced to phonological effects of the vowel or consonant following the stem vowel e. Here, I have chosen to maintain the traditional assumption only insofar as the effects of the following vowel or consonant constitute plausible synchronic phonological processes in OE. This decision has the effect primarily of forcing us to abandon the CeiC for CLASS 1

verbs and the CeuC form for CLASS 2. Postulating the CLASS 1 form as CeiC is completely unmotivated by any surface alternations: neither verbal forms nor nominalizations show up with the surface vowel e. For both classes, the sort of phonological rules necessary to derive drīf from dreif, clēof from clēuf, drāf from draif, or cleaf from clauf are not otherwise necessary in OE. Loosening the restrictions on the form of verbal roots also allows us to account for so-called 'aorist present' verbs with no difficulty. Regardless of the origin of the root forms of these verbs (originally from the PRET 2 forms), the synchronic representation of the root in the OE lexicon does not have to conform to the Ce(R)(C) pattern -- e.g., a verb like brucan whose other stem allomorphs conform to CLASS 2 patterns, simply has the root bruc, and is related by morpholexical rules to its stem allomorphs exactly as other CLASS 2 roots are.

Given these assumptions, the OE strong verb classes might now be represented as follows:

(23) CLASS 1: morpholexical rules (22a), (22b)

root: drīf

stems: drāf, drif

CLASS 2: morpholexical rules (22a), (22c)

root: clēf

stems: clāf, cluf

CLASS 3: morpholexical rules (22a), (22c)

root: help, drenk, werp

stems: halp, hulp, drank, drunk, warp, wurp

CLASS 4: morpholexical rules (22c), (22d), (22e)

root: ber

stems: baer, bāer, bur

CLASS 5: morpholexical rules (22d), (22e)

root: sprec

stems: spraec, sprāec

Notice, first of all, that CLASS 2 and CLASS 3 turn out to be identical under this analysis, since the two traditional classes are defined by the same two morpholexical rules. Here, I will continue to refer to the two classes by their traditional designations, but nothing hinges on this decision. Again, in classes 1-5, both the roots and the various stem allomorphs related to them by the morpholexical rules are listed in some fashion in the lexicon.

While this analysis may not seem to be particularly revealing in terms of explaining the morphological alternations in the strong verbs of OE, it is in fact no less revealing than any other analysis of these verbs to date. Although Lass and Anderson (1975) attempt to motivate a phonological basis for the verb stem alternations, it is clear that the phonological conditions for the stem alternations no longer existed in OE (cf. Dresher's (1978) review of Lass and Anderson), stem forms having

been completely morphologized by the OE period. O'Neil (1970) analyzes the stem alternations to be the result of morphological readjustment rules operating prior to the phonological component. His analysis differs fairly little in substance from the one offered here, the chief difference between the two analyses being the organization of the grammar assumed. Where the theory of word formation in which inflectional stem allomorphs have lexical representations proves its superiority, is in the predictions it makes for word formation possibilities in OE. Again, the theory proposed here predicts that the stem forms in (20) should all be available to further word formation whereas a traditional readjustment rule theory fails to make this prediction.

## 2.2. OE Nominalizations in -i

Both traditional treatments of vowel gradation in OE (cf. Quirk and Wrenn 1955) and generative treatments (O'Neil (1970)) have pointed out the existence of a class of nominalizations, productive at some stage of OE or pre-OE, formed from a verbal stem plus the derivational suffix -i. When the effects of phonological processes such as those in (24) (as stated in Kiparsky and O'Neil (1976)) are abstracted away from surface forms, we get the underlying representations in (25):

### (24) OE Phonological Rules

#### a. Umlaut

$$[+syl] \rightarrow \left[ \begin{array}{c} -bk \\ \langle 1 \rangle \end{array} \right] / \left\langle \left[ \begin{array}{c} \overline{\quad} \\ \{ [-bk] \\ [-stress] \} \end{array} \right] \right\rangle C_0 \left[ \begin{array}{c} -cons \\ +hi \\ -bk \\ -str \end{array} \right]$$

## b. Verner's Law

$$\begin{bmatrix} +\text{cons} \\ +\text{cont} \\ \langle +\text{ant} \rangle \\ \langle +\text{cor} \rangle \end{bmatrix} \longrightarrow \begin{bmatrix} +\text{voice} \\ \langle -\text{cont} \rangle \end{bmatrix} \quad / \quad \text{in certain morphologically conditioned environments}$$

## c. /i/-Lowering/Glide Syllabification

$$\begin{bmatrix} -\text{cons} \\ -\text{str} \\ \langle -\text{bk} \rangle \end{bmatrix} \longrightarrow \begin{bmatrix} +\text{syl} \\ \langle -\text{hi} \rangle \end{bmatrix} \quad / \quad \text{C \_\_\_}$$

## (25) a. CLASS 1

bīte 'bite' ← [bīt+i] (by umlaut (vacuous), i-Lowering)

## b. CLASS 2

cyre 'choice' ← [cus+i] (umlaut, Verner's, i-Lowering)

## c. CLASS 3

drink 'drink' ← [drenk+i] (umlaut (vacuous), Rule (19), i-Lowering)

wyrp 'throw' ← [wurp+i] (umlaut, i-Lowering)

## d. CLASS 4

cyme 'coming, advent' ← [cum+i] (umlaut, i-Lowering)

## e. CLASS 5

drepe 'slaying' ← [draep+i] (umlaut, i-Lowering)

What is curious about these nominalizations is that the verbal stem forms from which the nouns can most transparently be derived are stem allomorphs not necessarily identical to the root (identified here with the infinitive stem): bīt, drenk, and cum<sup>8</sup> are infinitive stems, draep is a PRET 1 stem, and cus and wurp are PRET 2 and PPLE stems.

Obviously, this state of affairs is rather disturbing within a standard readjustment rule type of framework. Such a theory has only the root form available in the lexicon for processes of word formation. Since the infinitive stem is identified with the root here, this would allow us to derive bīte from [bīt+i], drink from [drenk+i], and cyme from [cum+i]. However, the rest of the forms in (25) are more problematic. To get the proper verbal stem form to give us wyrp and cyre, we would have to start out with underlying forms [werp+i] and [cēs+i], and add the context 'nominalization' to whatever morphological readjustment rules later give the PRET 2/PPLE stem forms wurp and cus from the roots werp and cēs. Notice that we cannot simply add the context 'nominalization' to these readjustment rules, since not every nominalization on CLASS 2 and CLASS 3 verbs is formed upon the PRET 2/PPLE stem. Drink, as we have seen, is a nominalization on the infinitive stem of a CLASS 3 verb. We would therefore have to mark lexical roots werp and cēs specially to undergo the morphological readjustment rule for nominalizations. Moreover, nominalizations such as drepe, which are formed on the same verbal stem as the PRET 1, rather than on the infinitive or PRET 2 or PPLE stems, would require further morphological readjustment rules and further marking of lexical items.

In contrast, the morpholexical theory of inflection has no need to resort to a multiplication of rules and lexical exceptions; in fact, the morpholexical theory of inflectional stem allomorphy again predicts that nominalizations such as those in (25) should exist. The stems necessary to form the nominalizations in (25) are already listed in

the lexicon, and available for the word formation rule for nominalizations. As in the case of German compounds, this theory cannot predict what stem form for any given verb will be used in nominalizations, but it does allow any stem to be used. Therefore, once again, what was difficult to account for within a traditional morphological readjustment rule framework needs no explanation under the assumption that at least this portion of inflection is a lexical process.

### 3. Farther Afield

The appearance of inflectional stem allomorphs within complex derived words and compounds is not confined to Germanic languages: it appears repeatedly in Indo-European languages from Spanish to Sanskrit, and far beyond Indo-European languages as well. I do not intend to give an exhaustive survey of this phenomenon here. In what remains of this chapter, I will merely discuss the interaction of stem allomorphy and derivation with respect to two languages that will play an important role in later chapters, namely Latin and Tagalog.

#### 3.1. Latin

All students of Latin will be familiar with the division of Latin verbs into five classes or conjugations. The division is traditionally made on the basis of a vowel that appears with the verb root in the present indicative and a number of other tenses. Below are representative verb roots with their present indicative forms:



(26)	<u>root</u>	<u>am</u> 'love'	<u>mon</u> 'warn'	<u>dic</u> 'say'	<u>cap</u> 'seize'	<u>aud</u> 'hear'
	sg. 1	amō	moneō	dicō	capīō	audiō
	2	amās	monēs	dicis	capis	audīs
	3	amat	monet	dicit	capit	audit
	pl. 1	amāmus	monēmus	dicimus	capimus	audīmus
	2	amātis	monētis	dicitis	capitis	audītis
	3	amant	monent	dicunt	capiunt	audiunt

## (27) Person/Number Endings

sg.	1	-ō	pl.	1	-mus
	2	-s		2	-tis
	3	-t		3	-unt

I will set aside, for the moment, questions of vowel length alternations, of the presence or absence of the characteristic vowel before first person singular -ō and third person plural -unt, and of the nature, in general of the characteristic vowel in the conjugation of dicō, all of which will be dealt with in great detail in Chapter 2. What is relevant to the present discussion about the Latin conjugations is the following: if the actual person/number endings are assumed to be uniformly those in (27), the Latin verb roots differ arbitrarily and unpredictably in the stem allomorph on which they form their present indicative paradigm. It is not independently predictable that the verb root am forms its present stem with ā rather than i, ē, or ī, mon with ē rather than i, ī or ā. This is information which we must somehow represent as peculiar to each individual verb root, i.e., as part of its lexical entry.

How this information is to be represented, again, is open to argument. Following the pattern I have set in sections 1 and 2, I will first sketch an analysis utilizing morpholexical rules and lexical listing of all inflectional stem allomorphs, and then a more traditional morphological readjustment rule analysis. Again, these two possibilities make predictions about possible derivational word formation in Latin which can easily be tested.

A morpholexical analysis of Latin stem allomorphy entails a number of morpholexical rules like those in (28). (For the purposes of the remainder of this argument, I will confine discussion to verb roots like am, mon, cap and aud. Once the problem of the nature of the theme vowel of dic is dealt with in Chapter 2, the analysis will automatically extend to this class of stems.)

- (28) a.  $X \sim X\bar{a}$   
 b.  $X \sim X\bar{e}$   
 c.  $X \sim Xi$   
 d.  $X \sim X\bar{i}$

The morpholexical rules in (28) define lexical classes, as illustrated in (29):

- (29) CLASS 1: morpholexical rule (28a)  
 roots: am, cert  
 stems: amā, certā
- CLASS 2: morpholexical rule (28b)  
 roots: mon, deb  
 stems: monē, debē

CLASS 3: morpholexical rule (28c)

roots: cap, fac

stems: capi, faci

CLASS 4: morpholexical rule (28d)

roots: aud, ven

stems: audī, venī

Again, both roots like am, deb, cap, and ven, and stem allomorphs with characteristic vowels, or theme vowels, as I will sometimes refer to them, will be listed in full segmental form in the lexicon.

Alternatively, we could conceive of an analysis in which only roots are listed in the lexicon, but with some sort of diacritic indicating which conjugational class they fall into:

(30)     am     [+class 1]  
           mon    [+class 2]  
           cap    [+class 3]  
           aud    [+class 4]

After the syntax, but before the operation of phonological rules, inflected verbs in Latin would presumably have representations like those in (31):

(31)     am     + s  
           [+CL 1]  
           mon    + t  
           [+CL 2]  
           cap    + mus  
           [+CL 3]  
           aud    + unt  
           [+CL 4]

The readjustment rules in (32) will act upon the underlying forms in (31) to give surface forms of Latin present indicative verbs:

(32) Readjustment Rules

- a. [root]  $\rightarrow$  [root]ā / [+CL 1]
- b. [root]  $\rightarrow$  [root]ē / [+CL 2]
- c. [root]  $\rightarrow$  [root]i / [+CL 3]
- d. [root]  $\rightarrow$  [root]ī / [+CL 4]

The two analyses, while identical with respect to their ability to account for the inflectional stem allomorphs of Latin, differ with respect to their predictions about word formation possibilities in Latin. The former predicts automatically derivations on both the root and the stem allomorph with the theme vowel. The latter analysis predicts only derivations on the root, and would therefore have to be complicated to account for any derivations on other stem allomorphs which do occur.

Consider now the derived forms in (33):

(33) derived adjectives

certābundus	'contending'	(certāre 'contend')
vitābundus	'avoiding'	(vitāre 'shun')
moribundus	'dying'	(morīri 'die')
gaudebundus	'rejoicing'	(gaudēre 'rejoice')
cupīdus	'desirous'	(cupīre 'desire')

(33) derived nouns

certāmen	'contest'	(certāre 'contend')
monēla	'admonition'	(monēre 'warn')
accipiter	'hawk'	(accipere 'take')

derived verbs

dormītō	'be sleepy'	(dormīre 'sleep')
fugitō	'flee eagerly'	(fugere 'flee')
ardescō	'take fire'	(ardēre 'burn')
augescō	'begin to grow'	(augēre 'increase')
amascō	'begin to love'	(amāre 'love')

All of these examples could plausibly be analyzed as the theme vowel stem allomorph of the verb plus a derivational suffix (-bundus, -dus, -men, -la, -t, -sc). Many other such examples can be found. Numerous examples can also be found where the verb root alone is the base for derived words in Latin -- i.e., although some derivation uses the theme vowel stem, not all derivation does.

These examples are entirely unproblematic if we assume a theory of word formation encompassing morpholexical rules and the listing of all inflectional stem allomorphs: the existence of forms derived on any listed stem allomorph of the verb is, again, predicted by such a theory. The standard readjustment rule theory makes no such prediction, and in fact, is at a loss to explain the examples in (33) without the addition of extra machinery. Minimally, we would have to add features to the lexical entries of verbal roots like am, cert, etc. indicating that they take a theme vowel ā in certain derivations as well as in verb paradigms. We could not use the feature [+Class 1] and the readjustment

rule (32a) we used for inflectional paradigms, since this would predict that only the theme vowel stem would occur in derived words; i.e., if am always has the designation [+Class 1], readjustment rule (32a) would always insert a theme vowel ā, and we would never produce such existing forms as amor (=am+or) 'love'. Instead, the features we would have to add to the lexical entries for verb roots would have to be rather specific; a general feature like [+ ā in derivations] would again predict that all derivations with those roots would have to use the theme vowel stem. The only alternative open to us is to use features like [+ ā in derivative with -bundus] or [+ ā in derivative with -sc], and to add these features to the environment of our readjustment rule:

$$(34) \quad [\text{root}] \longrightarrow [\text{root}]\bar{a} / \left\{ \begin{array}{l} [+Class 1] \\ [+ \bar{a} \text{ w/ } -bundus] \\ [+ \bar{a} \text{ w/ } -sc] \\ \vdots \end{array} \right\}$$

Such a solution, in addition to being unnecessarily complex, also loses the generalization that a given verb root is never [+Class 1] with respect to its inflectional paradigm, but [+ ē with -bundus] or [+ i with -sc]. That is, it is, in fact, always the same theme vowel that shows up in derivatives and inflectional paradigms, although the readjustment rule theory could just as easily assign a different theme vowel to a given verb root in each morphological context in which it appears. Obviously, the conclusion we should draw here is that the theory of word formation incorporating morpholexical rules and listed stem allomorphs makes the correct predictions, and that the

readjustment rule framework does not. The former theory is therefore to be preferred.

### 3.2. Tagalog

Tagalog provides a final example outside of Indo-European of a language in which inflected forms must clearly be an input to further word formation processes. My data in this section come from Carrier (1979), which contains an intensive and detailed analysis of the internal structure of Tagalog verbs. Carrier herself comes to approximately the same conclusion which I reached above for German, Old English, and Latin, namely that inflected forms of verbs must be listed in lexical entries, and therefore available as bases for derivational word formation rules. I will summarize a portion of her argument below.

Verb roots in Tagalog do not occur by themselves as independent words in sentences, but rather occur only with one of a variety of affixes, called topic markers (TM), which indicate which nominal argument of the verb is focused in that sentence. Nearly any noun in a sentence -- subject, object, indirect object, benefactive, locative, etc. -- can be made the topic of a sentence. Each verb root chooses from the inventory of affixes illustrated in (35) a characteristic affix to mark it as a subject topic (ST), object topic (OT), or indirect object topic (IOT) form (Carrier 1979:220):

(35)	Subject Topic	Object Topic	Indirect Object Topic
	-um-	?i-	-in
	mag-	-an	-an
	mang-	-in	
	ma-	(ma-)	
	maka-		

Which of the affixes listed in (35) a given verb will take as its array of topic markers cannot be predicted from any independent characteristic of that verb root (e.g., its argument structure): this information is idiosyncratic, and must simply be part of the lexical entry for a given verb root. For example, the root bukas 'open' has a subject topic form mag-bukas and an object topic form buks-an, kula 'bleach' has ST mag-kula and OT ?i-kula, and sukat 'measure' takes a ST infix -um-. If we choose to treat Tagalog in the same way that we treated German, Old English and Latin above, we might choose to group Tagalog verb roots into lexical classes defined by the morphological rules in (36):<sup>9</sup>

- (36) a.  $X \sim \text{mag}X$   
         $\sim$  **mag-bukas**  
       **kula**  $\sim$  **mag-kula**
- b.  $X \sim ?iX$   
       **kula**  $\sim$  **?i-kula**
- c.  $X \sim X\text{an}$   
       **bukas**  $\sim$  **buks-an**  
       :  
       :  
       :

Both the verb roots and the stem forms with topic markers would be listed in the lexicon.

If both verbal roots and topic marked affixes are listed in the lexicon, they should be available to other word formation processes. Carrier points out that this is in fact the case: both roots and ST



forms, at least, are frequently used as bases for further word formation. For example, from the verbal root, nouns can be derived with the meaning 'object of the action designated by the verb', and from ST forms, agentive nouns can be derived. The former are illustrated in (37a), and the latter in (37b):

- (37) a. bilih 'sell'       $N[V[bilh] in]$       'something to buy'  
           labah 'launder'     $N[V[labah] in]$       'something to launder'
- b. ST mag-bilih       $N[taga V[pag-bilih]]$     'seller'  
           ST mag-labah      $N[taga V[pag-labah]]$     'person who launders'

(The p-initial form of the ST affix is an allomorph that occurs when ST forms in mag- are subject to further derivation.) The ST form of the verb is also the stem on which the Benefactive Topic form of the verb is built: the benefactive topic marker ?i- is added to ST verbs in mag- or mang-: ?i-pang-kuhah 'gather-BT', ?i-pag-bigay 'give-BT'. Carrier gives no examples where other topic marked forms (e.g., OT or IOT) act as bases for further word derivation. Nevertheless, a traditional readjustment rule theory of inflection would have difficulty in explaining the frequent examples of derivation on ST forms. Tagalog therefore provides a bit more support for our hypothesis that inflection should be treated in the lexicon as a lexical word formation process.

#### 4. Conclusion

My argument in this chapter has been simple and straightforward: if forms which are usually associated with inflectional paradigms are generated in some way in the morphological component, we predict that

these forms should be available for further word formation. Rules of derivation and compounding should be able to apply to such inflectional stem allomorphs. Examples from languages such as German, Old English, Latin and Tagalog support this prediction. Moreover, these examples prove intractable for any theory which does not assume lexical representation of inflectional stem allomorphy, e.g., the theory under which readjustment rules operating post-syntactically create stem allomorphs. We therefore have the prima facie evidence we originally sought to support a theory of word formation which treats inflection and derivation as the same sort of word formation.

## CHAPTER 1: FOOTNOTES

1. The array of root and stem classes in (3) differs from the set of classes given by Wurzel in the following way. Wurzel considers nouns like Karpfen to constitute a class by themselves: they differ from other strong nouns in having an n stem extension throughout the paradigm. I fail to see, however, what is gained by having the final n added as a stem extension in every inflectional form; if the roots in these nouns are considered to already contain the final n, this class may be collapsed with the class of nouns like Hund which take neither s-plural, r-stem, nor plural umlaut. Similarly, nouns like Garten do not constitute a separate class taking the n stem extension and plural umlaut. Instead, they fall into the same class as nouns like Bach which merely have plural umlaut.

2. It is assumed that e-epenthesis is ordered before e-deletion. Degemination can be ordered either before or after these rules.

3. Morpholexical rules (9) and (11) are approximations. These noun classes will be further discussed and the morpholexical rules revised in light of the discussion of Umlaut in Chapter 4.

4. Class 4 differs from Class 5 not in stem forms or morpholexical rules, but in the diacritics borne by the particular stems. To foreshadow Chapter 2, actual case endings subcategorize particular stem forms, and must therefore be able to distinguish between them. The difference between Class 4 and Class 5 is that plural case endings subcategorize the n stem in Class 4, but all case forms except nominative

singular subcategorize the n stem in Class 5.

5. Readers familiar with modern German will have noted correctly that I have ignored here an entire class of German compounds such as Vatersbruder 'father's brother', Mannsleute 'menfolk', and Gänsebraten 'roast goose', which seem to have genitive singular -s or genitive plural -e internal to the compound. At this point, there is little to be said about such forms, since we have only argued that stem allomorphs are listed in the lexicon, and have said nothing about the 'location' in the lexicon of actual case endings such as the dative plural -n and the genitive singular -s. To foreshadow Chapter 2 again, it will be argued there that all inflection should be performed in the lexicon, including the affixing of actual inflectional endings. Given this conclusion, we must find some way of generating compounds with genitive -s or -e, but not with dative plural -n. One way to do this might be the following. Suppose that compounding in German is restricted to stems, so that the forms in (14) can be generated in the lexicon, but not either the occurring genitive compounds or the non-occurring dative -n compounds. Genitive compounds might then be the result of a highly constrained sort of syntactic reanalysis. Genitive nouns are the only case-marked nouns which occur structurally adjacent to another noun within a noun phrase:

a.

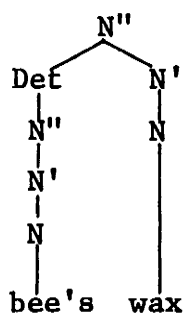

b.

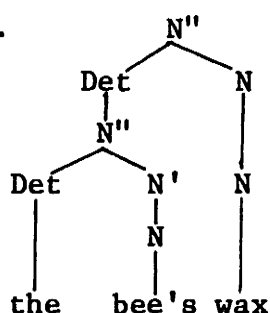

It would be possible to have a rule which reanalyzed a structure like (a) to be an N, but would not reanalyze a structure like (b) in which other lexical material occurred in the NP.

6. Later on in Chapter 2, I will qualify this statement somewhat. Only stem allomorphy which is arbitrary and unpredictable will be represented in the lexicon by means of listed stems and morpholexical rules. Cases in which it is predictable that, for example, all stems containing back vowels have variants with corresponding front vowels (i.e., umlaut) in certain environments will not have these stem variants listed. See Chapter 2, § 1.3, and Chapter 4 for a discussion of cases where stems vary predictably.

7. The underlying forms clēf and clāf may have to be lexically marked to undergo Breaking, even though they do not meet the structural description of this rule. Their surface forms could not be derived otherwise by our phonological rules. Alternatively, both forms might be represented with ə already present in underlying forms: clēəf, clāəf. We would assume that the surface spelling of such forms could be cleof and clēaf respectively.

8. Cuman is considered to be a Class 4 verb because its principle parts cuman, c(w)om, c(w)omon, cumen presumably derive from underlying forms c<sup>w</sup>eman, c<sup>w</sup>aem, c<sup>w</sup>aemon, c<sup>w</sup>umen. I am not certain whether the phonological processes which give us the former from the latter are to be considered synchronic processes. If not, we would be forced to consider cuman and similar verbs as constituting a separate lexical class with morpholexical rules giving us the principal parts more

directly.

9. Carrier proposes that root and topic marked forms are all listed in the lexicon, but lacks the morpholexical rule device introduced here to express existing regularities among listed items.

## CHAPTER 2: THE ORGANIZATION OF THE LEXICON

In Chapter 1, I argued that at least a certain portion of the inflected word, namely the stem variants according to which lexical items fall into conjugation or declension classes must be represented in the lexicon, since they can act as input to such lexical processes as derivation and compounding. There, I proposed that lexical items fall into lexical classes which were to be defined by means of a new type of lexical rule, called a morpholexical rule. Thus, the German noun Mutter 'mother' belonged to a class defined by a morpholexical rule 'Plural Umlaut'. Both Mutter and its related stem variant Mütter were to be listed as segmental lexical items, and both were available to word formation processes; the presence of compounds on both stems (Mutterfreuden 'maternal joy', Mütterverschickung 'evacuation of expectant mothers') was thereby both predicted and explained. Such evidence suggested at least a partial reorganization of the lexicon as it has been discussed in the literature to date. However, the reorganization proposed there -- the substitution of morpholexical rules in the morphology for readjustment rules operating before the phonology -- was no more than a rough characterization, and the notion of morpholexical rule entirely pretheoretic. Moreover, nothing was said in Chapter 1 about inflected forms other than the inflectional stems, although the fact that part of the inflected form must appear in the lexicon seriously raises the possibility that all inflection should be integrated into the morphology.

One goal of this chapter is to examine the formal characteristics of morpholexical rules and to justify the assimilation of all

inflectional processes into the lexicon. In order to do this, of course, a general theory of morphology will have to be elaborated: the place of morpholexical rules and of inflection, in general, in a theory of word formation will become clear only through their interaction with other morphological rule types. My strategy will be the following. The first half of this chapter will be devoted to an outline of the word formation component of a generative grammar, as I conceive it. Such a component will be composed of subcomponents including a permanent lexicon containing lexical entries, morpholexical rules and redundancy relations; a lexical structure component consisting of binary branching unlabeled trees, and general node labeling conventions; and a string dependent rule component containing productive morphological rules sensitive to the segmental nature of the string on which they operate. I will argue that these three morphological subcomponents comprise the "syntax" of word formation; the semantics of word formation will be assigned to a different component of our grammar. Throughout this section, I will draw general examples from various languages including English and German, and will discuss the relation of my proposals to other recent proposals in morphology such as Selkirk's lexical structure theory, Williams' Head Principle, and Allen's Adjacency Condition.

The argument for not distinguishing inflection and derivation may seem somewhat circuitous. I will assume throughout that all theoretical mechanisms needed for a generative morphology will be available both to inflectional processes and derivational processes. Using this assumption, I will present a detailed analysis of Latin verb paradigms, covering in depth a large portion of Latin morphology, both



inflectional and derivational. The strongest argument that will emerge from this study for not distinguishing inflection and derivation is that just those mechanisms needed for handling derivational processes in Latin are also needed for inflectional processes. Since it is not logically necessary that inflectional processes and derivational processes require the same theoretical machinery, this provides strong motivation for the sort of morphology being outlined. The discussion of Latin verb paradigms will have other ramifications as well. First, it will lead to a redefinition of the notion of morphological productivity, and second, it will lead to a significant clarification of our notion of lexical structure.

## 1. A Morphological Framework

### 1.1. The Permanent Lexicon

Most theories of morphology within the generative framework have assumed that one important portion of the word formation component of a grammar is a dictionary or list of lexical entries of one sort or another. Aronoff's framework (1976), for example, assumes lexical entries for unanalyzable words in English, as well as for lexicalized complex words, i.e., words like transmission 'part of a car' which appear to have a complex structure but have a noncompositional meaning. Affixes like -ness or -ity do not have lexical entries in the way that words like box or transmission do. Instead, they are attached by word formation rules which specify all of the sorts of idiosyncratic information that is specified for words in lexical entries; that is, the semantic representations, category information, conjugation or declension class membership, etc., of affixes are written into the word

formation rules. Selkirk (1978) proposes a system which differs from Aronoff's crucially in that all lexical items, including words, stems, and affixes had lexical entries: in addition, she proposes a set of rewrite rules similar to phrase structure rules producing trees into which affixes and stems are inserted. The theory to be proposed below essentially adopts a framework such as Selkirk's in which all lexical elements, stems and affixes alike, are given entries in a dictionary, these elements then undergoing insertion into lexical trees. My framework differs from Selkirk's in many respects, however, both in the degree and kind of organization ascribed to this dictionary, which I will hereafter call the permanent lexicon, and in the nature of the rewrite rules forming tree structures. Throughout, I will attempt to compare my system to Selkirk's, as well as to a framework developed by Williams (1979) which is similar to Selkirk's in many ways.

Section 1.1.1. will discuss the contents of lexical entries; what I will have to say here is very little different from other recent works on morphology, but is necessary for developing the rest of my system. In section 1.1.2., I will ascribe a greater organization to these lexical entries than is done in any of the works mentioned above: here, I will discuss the place of stem allomorphy, morpholexical rules, and category specifications in our permanent lexicon, borrowing a number of useful notions from set theory. Section 1.2. will be devoted to lexical structure.

### 1.1.1. Lexical Entries

All unanalyzable morphological elements will be referred to as lexical terminal elements, and will have lexical entries. The purpose

of a lexical entry is to specify all information about a terminal element which is arbitrary, unpredictable, and idiosyncratic to that element. Such information clearly includes the following:

(a) The category and conjugation or declension class of an item. Since most of 1.1.2. will be devoted to these two subjects, I only mention them in passing here.

(b) Phonological representation. It is assumed that morphemes are listed in their underlying phonological forms. Such underlying forms are fitted together and operated on by other morphological rules before they enter the phonology.

(c) Semantic representation. Each unanalyzable terminal element comes associated with a representation of its semantic content, although I will argue in section 1.4. that how these semantic representations are eventually put together is not necessarily to be dealt with within the word formation component of a grammar itself.

(d) Subcategorization. Within the system being developed here, affixes differ from non-affix morphemes only in that affixes have as part of their lexical entries frames indicating the category of items to which they attach as well as the category of items produced. In addition to category (N,V,A, etc.), subcategorization frames can indicate other diacritic features of the items to which they attach (cf. (e) below). For example, the prefix un- in English attaches to adjectives of all sorts, and will therefore have a lexical entry with subcategorization frame  $[_A \_\_\_ ]_A$ . -ive attaches to verbs in English, but with the added restriction that it only attaches to verbs with a diacritic feature

[+L<sup>at</sup>inate] (preventive, abusive, \*understandive, \*findive). -ive will be listed with a subcategorization frame [+Lat]]<sub>V</sub> ]<sub>A</sub>.

(e) Diacritics. Much of the current morphological literature has been devoted to showing that when affixation of a given derivational affix is not absolutely free or productive, it is often quite productive with a well defined subset of lexical terminals -- e.g., a given suffix will not attach to all nouns, but only to a certain class of nouns. Often, there is little or nothing to distinguish such a subclass from non-members on synchronic structural grounds. In such cases, subclasses of items can be distinguished by providing them with diacritic features. Dell and Selkirk (1978) motivated a feature [+Learned] for French. Williams (1979) uses the diacritic [+L<sup>at</sup>inate] for English to distinguish for example, the verbs to which -ive will attach from those to which it will not attach. Perhaps the most well-documented need for diacritics, however, is the case of so-called Level Ordering which has been widely accepted for English (Siegel 1974, Allen 1978). To summarize the arguments, there are affixes in English which affect the phonological representation of the words to which they attach, both with respect to segmental phonological operations and stress assignment. There are other affixes which have no phonological effect on their bases. Moreover, the former are found inside the latter, but not vice versa. Much of the behavior of derivational affixation in English can be explained by assuming that affixes are specified for which group they belong to and that the phonology affecting affixes are attached in a block before the non-phonology affecting affixes. The particular workings of a level-ordered morphology are not relevant to the present



- b. SUFFIX: -ize (phonological representation)  
 semantic representation: causative  
 category/subcategorization: ]<sub>N</sub>\_\_\_]V  
 Insertion frame: NP\_\_(NP)  
 diacritics: Level II
- c. STEMS: run (phonological representation)  
 semantic representation: ...  
 category: V[\_\_\_]V  
 insertion frame: NP\_\_(NP)  
 diacritics: [-Linate]<sup>1</sup>
- product (phonological representation)  
 semantic representation: ...  
 category: N[\_\_\_]N  
 insertion frame: (whatever insertion frames  
 for Ns look like)  
 diacritics: [+Linate]

Especially important for the theory to be developed below is the fact that lexical entries for affixes are identical to lexical entries for non-affix morphemes, except for the presence of subcategorization information in the entries of the former. That is, embodied in the idiosyncratic information expressed in lexical entries is the distinction between free morphemes, or stems, and bound morphemes, or affixes. Affixes or bound morphemes obligatorily require the presence of some other lexical constituent, the nature of which is represented in their lexical entries. Stems, or free morphemes, have no such requirement. The distinction in lexical entries will therefore be made on the basis of the definitions of stem and affix within this theory.

- (2) DEFINITIONS: stem: a morpheme whose lexical entry does not subcategorize another morpheme.

affix: a morpheme whose lexical entry specifies some sort of lexical terminal to which it can attach.<sup>2</sup>

The term stem is used here intentionally rather than the term root.

Root will be given another, slightly more specialized definition in 1.2. below. For the time being, it will suffice to say that roots are a subset of stem and affix morphemes.

I should also point out here that the term affix is meant to subsume both inflectional and derivational affixes. The claim is that inflectional affixes need to be specified for all the idiosyncratic information which derivational affixes must be specified for, and in fact that complex inflectional paradigms can be built up using all and only those means available for forming complex derived words. Much of the section of this chapter on the Latin verb paradigms will be devoted to showing that this is the case.

#### 1.1.2. Category Classes, Lexical Classes, and the Nature of Morpholexical Rules

Thus far, the theory I have been setting forth differs little from other morphological frameworks which have been proposed; most theories of generative morphology to date have assumed some sort of dictionary-like component containing lexical entries corresponding to what I have called the permanent lexicon. Such theories have paid little or no attention, however, to the question of whether or how lexical entries are ordered within the permanent lexicon, i.e., to whether or not there is any internal structure to this component of a morphology. Of course, it is logically possible that no such internal structure exists, or that lexical terminals are simply listed

alphabetically, as if the permanent lexicon were a sort of internal Webster's Third. What I wish to do here, however, is to propose a more highly structured permanent lexicon, one which is not unordered, or alphabetically ordered. In essence, I would like to claim that the permanent lexicon constitutes a distinct component or level in morphology (the term level being used here in the sense of Chomsky 1955), with its own set of primitives and its own formally distinct class of rules. In the course of this section, I will suggest a particular way of representing the category and conjugation or declension class of a lexical terminal, something which was not discussed in the section on lexical entries above, and will clarify the formal nature of morpholexical rules. The discussion will make use of a number of concepts from elementary set theory. Throughout this chapter, and in chapters which follow, I will try to show that a number of interesting consequences follow from the proposals to be made in this section.

As set forth in 1.1., the permanent lexicon consists of a set of all those terminal items which cannot be decomposed into smaller parts, along with their lexical entries. The set of lexical terminals which comprises the permanent lexicon will be further partitioned into a number of subsets which are mutually exclusive and collectively exhaustive of all elements in the permanent lexicon. These subsets can be seen as equivalence classes which are defined by the following relation:

(3) CATEGORY RELATION:  $R_C = x$  is of the same category as  $y$



The inventory of categories,  $\{N, V, A, \emptyset, \dots\}$ , is taken to be primitive, and presumably universal. The null symbol  $\emptyset$  is included in this inventory to cover lexical terminals which are category-less. Such items, including prefixes like counter- and suffixes like Spanish diminutive will be discussed more thoroughly in 1.2. Simply put, the relation in (3) states that each and every item in the permanent lexicon is assigned to a category. Groups of lexical items of the same category will be termed category classes here.

In languages with a certain amount of inflection (and perhaps even in English, as will be suggested in Chapter 3), category classes must have further structure. That is, lexical items belonging to a given category will often fall into different subclasses depending on how they inflect; traditionally, these subclasses have been referred to as conjugation and declension classes. In Chapter 1, I argued that the stem allomorphy that resulted from membership in different conjugation and declension classes should not be represented by means of diacritic features (e.g., [+Conjugation 3]) in lexical entries and morphological readjustment rules producing segmental stem forms in the phonology (e.g.,  $V \rightarrow [+hi] / [\overline{+Conj\ 3}]$ ). Instead, it was argued that many facts about derivation and compounding could be explained if inflectional stem allomorphs were listed in segmental form in the lexicon. Clearly, since the sort of allomorphs a given lexical terminal has is information idiosyncratic to that morpheme, this information is properly a part of the permanent lexicon. What we therefore need are mechanisms for related listed stem allomorphs, and for defining classes of morphemes that form allomorphs in the same way.

The mechanisms that we need can easily be given formal expression by borrowing a number of concepts from set theory (Halmos 1960). To account for differences in conjugation or declension among members of a category class, category classes will be partitioned (although not necessarily exhaustively, cf. below) into subsets; each subset of a category class is to be considered a partial ordering, where a partial ordering  $\varphi$  is a set of ordered pairs of lexical terminals in which the second member of every ordered pair  $(a,b) \in \varphi$  bears a specified relation R to the first member of that pair, and the following conditions hold:

- (4) a. If  $aRb$  and  $bRa$ , then  $a=b$  (i.e.,  $\varphi$  is asymmetric).  
 b. If  $aRb$  and  $bRc$ , then  $aRc$  ( $\varphi$  is transitive).

The set theoretic definition of a partial ordering also requires, besides asymmetry and transitivity, that a partial ordering be either strict or weak. If strict, the partial ordering is also reflexive -- i.e., for every  $a \in \varphi$ ,  $aRa$ . If weak, the ordering is irreflexive. By this criterion, the partial orderings into which category classes are partitioned are usually weak partial orderings: that is, for every  $a \in \varphi$ , it is not necessarily the case that  $aRa$ . The partial orderings being discussed here will be termed lexical classes as a general term to subsume both 'conjugation class' and 'declension class.'

The relation referred to as R above is what I called a morpholexical rule in Chapter 1. A morpholexical rule is a relation defined between pairs of lexical items which are listed in the permanent lexicon. Thus, German has pairs of lexical terminals like

the following which fall into the category class noun: (Bach, Bäch), (Vater, Väter), (Mann, Männer), (Geist, Geister), (Staat, Staaten), (-schaft, -schaften), (-heit, -heiten). These pairs are further grouped into lexical classes by means of the morpholexical rules listed in (5) (repeated from Chapter 1), which specify the relation between members of a pair in any given class:

- (5) a. umlaut  $C_0 VC_0 \sim C_0 \check{V} C_0$   
 b. r-stem  $C_0 VC_0 \sim C_0 \check{V} C_0 r$   
 c. weak  $X \sim Xn$

The German nouns and nominal suffixes listed above thus fall into three lexical classes within their common category class (more lexical classes are needed for a full analysis of the German noun paradigms):<sup>3</sup>

- (6) CLASS 1 morpholexical rule (5a)  
 defines the set {(Bach, Bäch), (Vater, Väter),...}  
 CLASS 3 morpholexical rule (5b)  
 defines the set {(Mann, Männer), (Geist, Geister),...}  
 CLASS 4 morpholexical rule (5c)  
 defines the set. {(Staat, Staaten), (-schaft, -schaften),  
 (-heit, -heiten),...}

Both members of the ordered pairs are represented segmentally as lexical terminals, and each is available to processes of derivation and compounding. Derivational suffixes can also belong to lexical classes, as illustrated by -schaft and -heit, since they have nominal paradigms identical to those of underived words like Staat.

The question may be raised at this point what the formal properties of the morpholexical rules under discussion are -- for example, whether

they are redundancy rules, or rules which generate the second member of an ordered pair from the first, or perhaps rules of a different sort. We can rule out immediately the possibility that they are redundancy rules. Redundancy rules are implicational relations of the sort "If X, then Y": they are not absolutes, but in a sense form part of the evaluation metric of a grammar. In other words, a redundancy rule " $X \longleftrightarrow Y$ " is a statement to the effect that, all other things being equal, it is less costly to a grammar which has X to also have Y, than it is for this grammar to have only X or only Y. Morpholexical rules cannot be redundancy rules, since they are not implicational relations in this sense; instead, morpholexical rules state absolutely that lexical items X are related to lexical items Y.

On the other hand, it is not completely clear that morpholexical rules are generative rules either, or at least generative rules of the same sort as phrase structure or transformational type generative rules. Phrase structure rules are rewrite rules which relate both terminal and non-terminal elements: the categories S, NP, VP, etc. are non-terminals from which the hierarchical structures underlying sentences are built. In contrast, morpholexical rules do not relate members of a non-terminal vocabulary, but only terminal elements, i.e., members of pairs like (Mann, MÄnner), (Geist, Geister), which otherwise have equal status within the permanent lexicon.<sup>4</sup> Nor are morpholexical rules like transformational rules. If a string is analyzable by the structural condition of a transformation, that string generally can (and sometimes must) undergo the rule. In contrast, it is purely arbitrary whether or not any lexical item conforms to the specifications

of a given morpholexical rule, or 'undergoes' that rule; lexical items either conform to the relation specified by a morpholexical rule, in which case they belong to the class defined by that rule, or they do not.

Morpholexical rules, moreover, do not define a uniform formal relation between two lexical items, but instead mimic all of the sorts of relations defined by productive morphological operations. The most obvious sort of relation is affixation: within this framework, stems and affixes are concatenated in a productive lexical structure component. Mimicking this sort of relation are morpholexical rules like (5t,c) which relate two stems, one being like the other except for the addition of an affix-like extension. Other morpholexical rules mimic string dependent morphological rules (cf. 1.3., and Chapter 4). (5a) is a rule of this sort, where the relation defined by the morpholexical rule is a more or less phonological one. Even more striking are morpholexical rules which mimic processes like reduplication and infixing. For example, a small class of verbs in Latin form past stems by means of reduplication:

(7)	mordeō	momordi
	spondeō	spopondi
	currō	cucurri
	poscō	poposci

This is clearly not a productive process of morphology, since only a handful of verbs have reduplicative pasts. Instead, stems like mord and momord, spond and spopond, etc. will be listed in the permanent lexicon, and a morpholexical rule which looks like a rule of productive

reduplication will relate the pairs of stems:

$$(8) \quad C_0 CVC^2 \overset{5}{\sim} \\ 1 \ 234 \sim 123234$$

Similarly, Latin also has a class of verbs which form some stems with a nasal infix:

(9)	finḡ, finxi, fictus	'fashion'
	tangḡ, tetigi, tactus	'touch'
	pingḡ, pinxi, pictus	'paint'

Again, this is not a productive morphological process. Certain Latin verbs simply have two stems, one with the n (finḡ, tangḡ, pingḡ) and one without (fig, tag, pig).<sup>6</sup> The two will be related by a morpholexical rule like (10):

$$(10) \quad C_0 VC_0 \sim C_0 VnC_0$$

It should be stressed that these processes are considered to be morpholexical relations in Latin because only an arbitrary set of stems exhibit these relationships. In a language where, for example, all verbs formed past stems by reduplicating or by infixing a segment, reduplication and infixing would be productive rules of the morphology, specifically, within this framework, lexical transformations.

(11) summarizes some of the defining characteristics of morpholexical rules:

- (11) a. Morpholexical rules are predicates which define sets of ordered pairs of lexical items, both of which are listed in

the permanent lexicon. The relationships defined by morpholexical rules mimic the sorts of relationships defined by more productive morphological processes.

- b. Morpholexical rules are purely classificatory in nature. Unlike other rules of word formation, they do not change category, alter subcategorization, or add to, change or subtract from semantic content, however that is characterized. They merely define the limits of a class of items, and specify relatedness between pairs of those items.
- c. It is purely arbitrary whether or not any given lexical item conforms to the specifications of a lexical class as defined by its morpholexical rules.<sup>7</sup>

A few more comments are relevant here before we go on to discuss the lexical structure component of our morphology.

First, it might be thought that generalizations are being lost by saying that it is purely arbitrary whether a given item belongs to a lexical class *n* or not: for example, most feminine nouns in German belong to lexical class 4, and many masculine nouns to class 1. Although such generalizations are valid to a great extent, it is well known that there are also many nouns which do not conform to them: Staat, for example, is masculine, but belongs to the same class as feminine nouns such as Schule 'school', and Spur 'trace'. Bett 'bed' is a neuter noun which belongs to this class. Similarly, although most members of class 1 are masculine, Mutter and Hand are feminine, Kloster 'cloister' and Floss 'raft' are neuter. The theory being developed here considers

lexical class membership to be arbitrary; such a position covers both the situation in these nouns, and also the situation in the German verb paradigms, where synchronically it is clearly arbitrary (i.e., unpredictable on phonological or semantic grounds) whether a given verb is strong or weak, and if strong, which ablaut class it belongs to. Such generalizations as there are, however, can easily be captured by redundancy rules in the permanent lexicon of the form [+Fem]  $\longleftrightarrow$  [Class 4], [+Masc]  $\longleftrightarrow$  [Class 1]; these redundancy rules merely state that, all other things being equal, it is more highly valued in the grammar of German for feminine nouns to be in Class 4 and masculine nouns in Class 1.

Second, if lexical classes are defined as partially ordered sets with morpholexical rules being the relations specifying the members of these sets, we immediately have a way of referring to the root, or the more elementary item in a pair of lexical terminals: if a lexical class  $\varphi$  has an element a such that  $aRx$  for every  $x$  in  $\varphi$ , then a is the least element in  $\varphi$  (borrowing the set theoretic terminology). The least element in a partial ordering of lexical terminals will be called the root. Therefore, in a partial ordering of nouns in German consisting of  $\{(\text{Mann}, \text{Männer}), (\text{Geist}, \text{Geister}), (\text{Buch}, \text{Bücher}), \dots\}$ , the items Mann, Geist, and Buch are roots, since Männer, Geister, and Bücher are related to them by morpholexical rule (5b), and they themselves are not related to other items by this rule. Notice that given this definition, an affix morpheme as well as a stem morpheme can be a root; that is, items like -heit and -schaft are least elements in their ordered pairs, just as Staat is in its pair. Roots are thus a



subset of stems and affixes, if stems and affixes are defined as in (2). This use of morphological terminology is admittedly non-standard with respect to earlier works on morphology, both traditional and generative, but will be used consistently within this framework with the above definitions. In addition, in what follows, the contents of any ordered pair (e.g., Buch, Bücher) will be referred to as stem variants or morpheme variants.

Finally, at this point we can summarize the discussion so far by illustrating some lexical entries in German which are organized by means of the principles developed in this section:

(12) Category Class NOUN

Lexical Class: 4 morpholexical rules (5c)

(Staat, Staaten) phonological rep.

sem. rep.: 'state'

insertion frame: whatever  
insertion frames for Ns  
look like

(-ung, -ungen) phonological rep.

sem. rep.: 'abstract noun'

subcategorization: ]<sub>V</sub>—] <sub>N</sub>  
insertion frame: ...

3 morpholexical rules (5b)

(Mann, Männer) phonological rep.

sem. rep.: 'man'

insertion frame: ...

Similarly, the category class verb in German will be divided into lexical classes with morpholexical rules relating the various stems of strong verbs -- e.g., (bind, band, bund), (find, fand, fund) for the verbs binden 'bind' and finden 'find'.

## 1.2. Lexical Structure

In order to form complex derived words and compounds, the morphemes listed in the permanent lexicon must be fitted together with some sort of linear and hierarchical structure. The idea to be pursued here is that there exists another subcomponent of our morphology which is parallel to the phrase structure component in a generative syntax. Within the syntactic component of a grammar, there exist context free rewrite rules such as those in (13) which generate an array of permissible structures for a given language:

$$\begin{array}{l}
 (13) \quad S \longrightarrow N'' V'' \\
 \quad \quad N'' \longrightarrow \text{Spec } N' \\
 \quad \quad \quad \vdots
 \end{array}$$

Words are inserted into trees generated by these rules to produce the underlying structures of the language.

I assume here that languages also contain a set of context free rewrite rules generating lexical structure into which the terminal elements in the permanent lexicon are inserted. To my knowledge, this idea was first developed in a paper by Lisa Selkirk (1978). Although the version of lexical structure which I will argue for here differs in important ways from Selkirk's version, I owe a great deal to her original insight. A second version of lexical structure is given in Williams (1979). Again, my system differs significantly from Williams' and I will try to make relevant comparisons in the course of this section.

Selkirk's system for generating lexical structure for English

contains the following rules:

(14) Inflectional Morphology

$$X \longrightarrow \dots (\text{Af}) X_s (\text{Af}) \dots$$

Compound Formation

$$X_s \longrightarrow Y_s Z_s$$

Derivational Morphology

$$(i) X_s \longrightarrow (\text{Af}) Y_s$$

$$X_s \longrightarrow Y_s (\text{Af})$$

$$(ii) X_s \longrightarrow X_r$$

$$(iii) X_r \longrightarrow (\text{Af}) Y_r$$

$$X_r \longrightarrow Y_r (\text{Af})$$

X, Y and Z represent the major lexical categories. The subscripts s and r stand for stem and root respectively. Selkirk uses these terms rather differently from the way they are used here: a root is an item to which a Level I or non-phonology neutral affix can attach, a stem an item to which a Level II affix attaches -- i.e., the level ordering facts are accounted for by subcategorizing affixes to attach to either a root or a stem.

The rewrite rules ensure that inflectional affixes such as case markings and person/number endings are always on the outside: inflectional affixes attach to stems, but their outputs are lexical words rather than stems. Since derivational affixes attach to roots or stems, they will never attach outside of inflectional affixes. Stems

rewrite as compound stems, as stems preceded or followed by affixes, or as roots. Roots rewrite as roots optionally preceded or followed by an affix. With the insertion of morphemes, we have structures like those in (15):

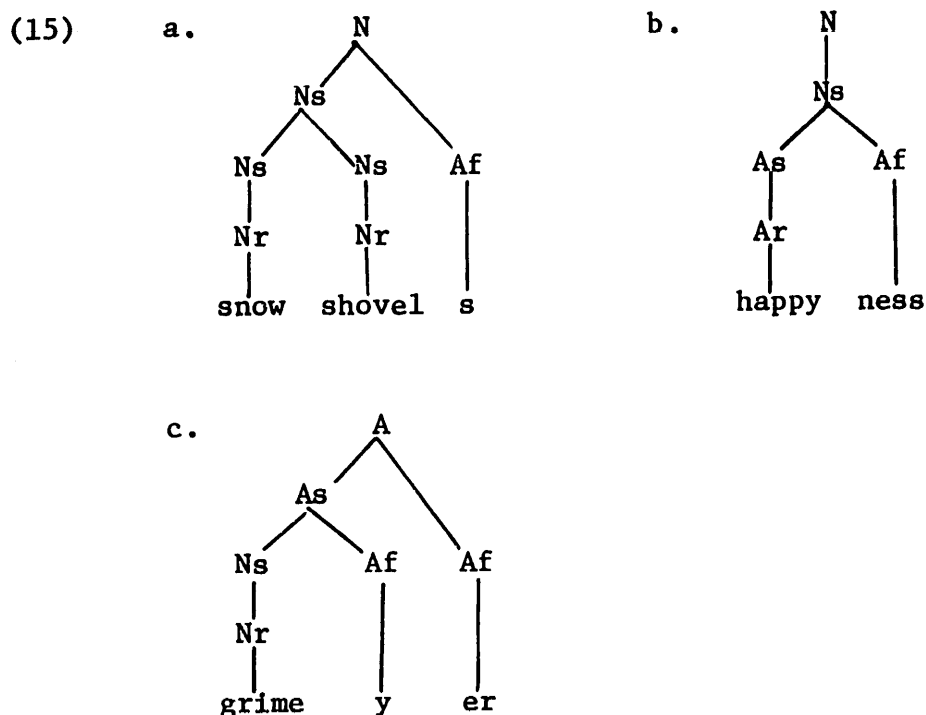

The motivation for the particular forms of these rules is unimportant at this point; Williams' set of rewrite rules in fact differs from Selkirk's in a number of ways. The comments to be made below, however, pertain to any set of rewrite rules making use of the terms  $X_s$ ,  $X_r$ , Af, etc., where X stands for any lexical category.

One reason for questioning the form of lexical structure rules such as those in (14) is the following: although the intent is clearly to parallel the form of syntactic phrase structure rules, rules using terms like Affix and Noun Stem have a crucial dissimilarity to phrase structure rules. Phrase structure rules conforming to any reasonable

formulation of X' Theory contain primitives of two types. One is category, i.e., N,V,A, etc., which is represented as a function of binary valued features such as  $\underline{+N}$ ,  $\underline{+V}$ . The second primitive is the notion of type level, where each type level  $X^n$  (X is some category) introduces a characteristic structural configuration containing as head a constituent of the same category, but of type n-1; e.g.,  $N^3 \rightarrow \text{Spec } N^2$ . Lexical structure rules are presumably intended to be analogous to syntactic PS rules on both counts: the use of categories as primitives is clearly maintained, and type level is encoded in the terms stem, root, and affix. That is, the term stem is meant to introduce characteristic structural configurations in the same way that terms like  $N^3$  or  $V^2$  are in syntactic PS rules ( $\text{stem} \rightarrow \text{stem af}$ ).

We have seen in 1.1., however, that the terms stem, affix and root are not primitives as syntactic type levels are, but are derivable instead from idiosyncratic information independently needed in the permanent lexicon. Affixes are morphemes with subcategorization frames. Stems are morphemes which lack subcategorization frames. Within the theory being developed here, roots are the least elements in the partial orderings defined upon pairs of lexical terminals. To use terms like stem, affix and root as primitives in our phrase structure rules then introduces a bit of redundancy into our morphology that might be better dispensed with.

A second part of redundancy is inherent in Selkirk's lexical structure system as well. That is, rules may rewrite stems of a given category as a stem of another category plus an affix. For example, (15c) presupposes a rewrite rule  $N_s \rightarrow A_s \text{ Af}$  generating the structure

into which happy and ness are inserted. But I have already argued that the lexical entry for the stem happy contains the information that happy belongs to the category class A, the lexical entry for ness the information that ness forms nouns by attaching to adjectives. This information, as argued above, is entirely unpredictable and therefore clearly necessary in the lexical entries. Moreover, this subcategorization information is expressed by means of labeled bracketings. Labeled bracketings are equivalent to tree structures. This means that all of the information contained in lexical structure rules is already encoded as bits of tree structure in the lexical entries of specific morphemes that could be inserted into the structures generated by those rules. Clearly, we could simplify our system by eliminating this redundancy.

At this point, I would like to propose an alternative to a system of lexical structure rules like those in (14) which will eliminate both the use of terms like stem and affix as primitives and will reduce the amount of redundant information expressed in our lexical structure component. In addition, this system will make a number of predictions different from those made by previous lexical structure proposals.

First, instead of a whole group of rewrite rules such as those in (14), my system contains a single context-free rewrite rule which will generate unlabeled binary branching tree structures. Nothing in the following discussion hinges on the choice of binary branching, as opposed to n-ary branching tree structure: there simply seem to be no phenomena in the languages I have examined so far for which n-ary branching lexical structure is necessary. A hypothetical example that

might justify ternary branching structure, for example, would be a discontinuous affix X...Y such that XZY is a complete word formed by affixing X...Y to some Z belonging to a specified category, and neither XZ nor ZY are words. In the absence of phenomena like discontinuous affixes, however, our lexical structure rule will give us a variety of binary branching structures of the following sorts:

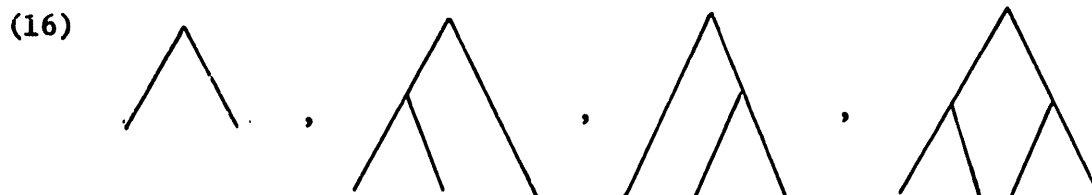

Lexical terminals are inserted into these tree structures subject to their subcategorization restrictions, as illustrated in (17):

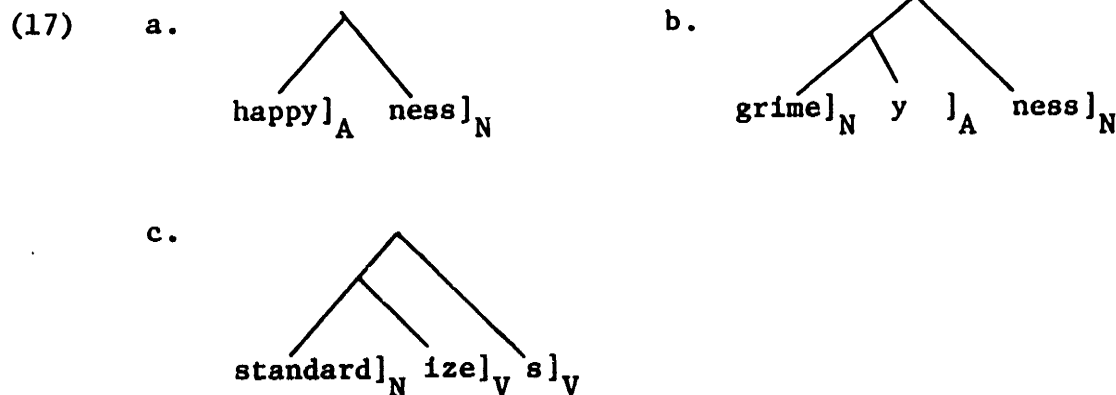

We now need some sort of mechanism for labeling tree structures on the basis of information about individual morphemes inserted into those structures. I therefore propose the following two labeling conventions:

- (18) a. Convention I: a stem morpheme (i.e., a morpheme lacking a subcategorization frame) labels the first non-branching node dominating it.

- b. Convention II: an affix morpheme labels the first branching node dominating it.

The mechanics of (18a-b) are illustrated in (19):

(19) a.

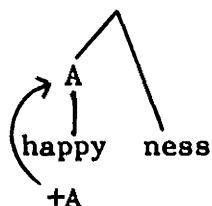

b.

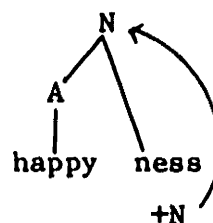

By (18a) we label the first non-branching node above happy with the category of this morpheme, namely, A. By (18b), we label the branching node N, after the category membership of the morpheme ness.

Our lexical structure system in essence consists, then, of a single rewrite rule giving unlabeled structure, insertion of morphemes into this structure subject to subcategorization restrictions, and node labeling according to the conventions in (18). In practice, however, this skeleton needs to be elaborated at a number of points.

First, it is not only category membership that must pass from a lexical morpheme to a node of tree structure. It is well known that in languages like German and Latin which have gender, and in English which apparently has a diacritic distinction between [+L<sub>atinate</sub>] and [-L<sub>atinate</sub>] morphemes, the entire feature content of a morpheme is percolated up a tree along with the category features of that morpheme. That is, derived words as a whole characteristically adopt all feature values of their outermost morphemes, and not only the category of the outside morphemes. Consider the examples in (20):



(20) a.

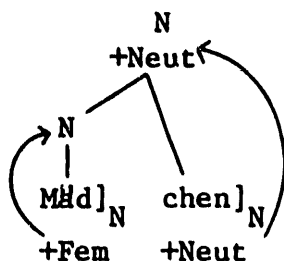

b.

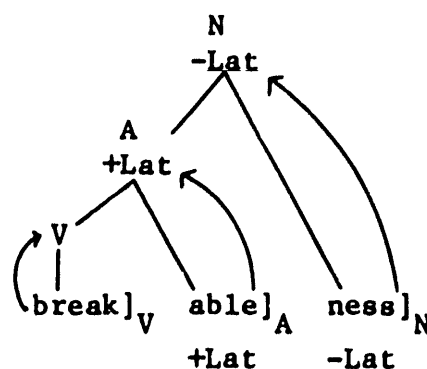

In German, words derived with the diminutive -chen are neuter regardless of the gender of the base to which -chen attaches. In English, if morphemes are classified as either [+Linate] or [-Linate], a word will take its value for this feature from the value of its outermost affix. So breakable is [+Linate] by virtue of the feature value of the affix -able; this predicts that breakable can undergo further affixation by a suffix or prefix that subcategorizes [+Linate] forms -- e.g., breakability alongside breakableness. Notice that this state of affairs is not an a priori necessary one: it is at least conceivable that words should receive the category of their outermost affix, but the gender of an inner morpheme. The possibility seems never to occur, however.

The feature percolation facts can easily be explained (and the non-occurring possibility ruled out) within the system being developed here by simply extending Conventions I and II in (18) in a natural way:

(21) FEATURE PERCOLATION CONVENTIONS:

- a. Convention I: all features of a stem morpheme, including category features percolate to the first non-branching node dominating that morpheme.
- b. Convention II: all features of an affix morpheme, including

category features, percolate to the first branching node dominating that morpheme.

That is, category features are just one sort of feature among a whole group of lexically idiosyncratic features that must be percolated. Such feature percolation mechanisms, it should be pointed out, would be necessary even in a lexical structure system like Selkirk's where tree structures are already labeled for category. In a structure like (21a) the information that the derived word is neuter and not feminine must be expressed regardless of how we express the category of the word. In combining the category labeling and feature percolating mechanisms, we therefore effect a significant simplification of our system. Below, I will compare this feature percolating mechanism with another theory that has been proposed to account for the same facts, Williams' lexical head theory.

Before I do so, however, there is another point at which my theory must be elaborated. Above, it was stated that derived words adopt all of the features of their outermost morphemes, but the examples in (22) suggest that lexical structure is not always as simple as that:

- (22)
- |   |          |   |              |
|---|----------|---|--------------|
| V | [counter | V | [sign]]      |
| A | [counter | A | [intuitive]] |
| N | [counter | N | [weight]]    |

Counter- seems to attach to nouns, verbs and adjectives: the resulting word is a verb when the base is a verb, a noun when the base is a noun, and an adjective when the base is an adjective. That is, the words in

(22) seem to have the features of their bases, rather than the features of the outermost morpheme, as was the case in the examples in (20).

(22) is only apparently a counterexample to our claim, however. We do not have a case here where the features of an outermost morpheme are ignored in favor of the features of an inner morpheme. Instead, counter seems in some sense to be transparent to category, or to lack any category features of its own. Whatever category of item it attaches to, the resulting word bears that category as well.

These facts can be explained if we adopt the following assumptions: counter and morphemes like it have no category membership at all, i.e., counter belongs to the null category class, which is to say that it lacks category features entirely, and has a lexical entry something like that in (23):

- |      |          |                             |                                   |
|------|----------|-----------------------------|-----------------------------------|
| (23) | counter- | Category Class: $\emptyset$ | phonological rep. ...             |
|      |          |                             | semantic rep. ...                 |
|      |          |                             | subcategorization: [ <u>  </u> X[ |
|      |          |                             | where X is a lexical category     |

Counter- thus has a phonological representation and a semantic representation, but differs from an affix like -ness in that it is subcategorized to attach to any lexical category. When counter- is inserted into a tree and Feature Percolation Conventions I and II are applied, we derive the following trees:

- (24)
- |   |   |  |
|---|---|--|
| <pre>       /  \      /    \     /      \    /        \   /          \  counter      V                 \                                     v[sign]             </pre> | <pre>       /  \      /    \     /      \    /        \   /          \  counter      N                 \                                     N[weight]             </pre> | <pre>       /  \      /    \     /      \    /        \   /          \  counter      A                 \                                     A[intuitive]             </pre> |
|---|---|--|

Our feature percolation mechanisms fail to label the branching nodes in (24) because there are no inherent category features belonging to the affix counter- which could be percolated up the tree. We must therefore add the following convention:

(25) FEATURE PERCOLATION CONVENTIONS (cont'd)

Convention III: If a branching node fails to obtain features by Convention II, features from the next lowest labeled node are automatically percolated up to the unlabeled branching node.

By this convention, the trees in (24) are labeled as in (26):

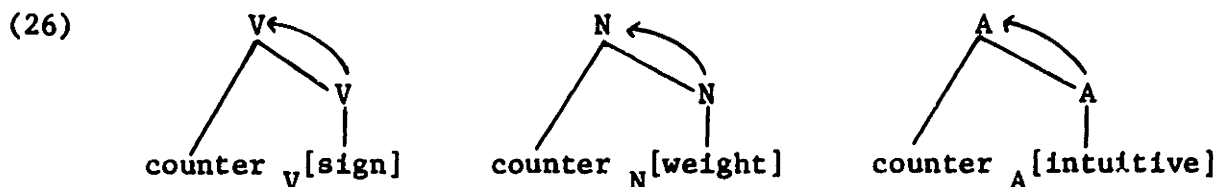

Feature Percolation Convention III will prove useful for other cases as well. For example, it is clearly necessary in the syntactic component for purposes of agreement or choice of adverbs to know the full feature composition of a verb form.<sup>8</sup> However, it is often the case that only a single morpheme in a derived verb form might be inherently specified for each feature. Consider, for example, the Latin verb form in (27):

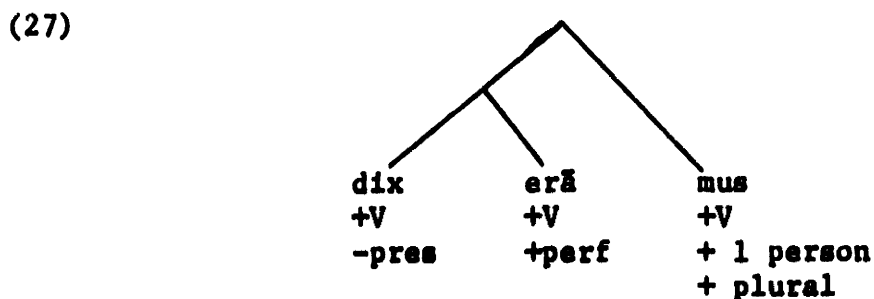

The Latin verb paradigms will be discussed in detail later in this chapter. For the time being it is enough to know that dixerāmus is the first person plural pluperfect of dicere 'to say', and that it consists roughly of three morphemes, dix, the past stem of dicere, erā the perfect morpheme, and mus the first person plural morpheme. If we conceive of the category [+V] in Latin as having a matrix associated with it with features like [+perfect] for aspect, [+present] for tense, [ $\alpha$ person], [ $\beta$ plural] for person and number, and if we assume that some morphemes which are [+V] may be unspecified for some features, Feature Percolation Convention III will ensure that tense, aspect, and P/N features will percolate from more deeply embedded morphemes up to the top of a tree, if morphemes between them and the highest node are otherwise unspecified for the relevant features. So the tree in (27) will be filled in as follows, first by Conventions I and II (28a), and then by Convention III (28b):



In the trees above,  $\emptyset$  indicates a feature which is unspecified for the morpheme in question. Feature Percolation Conventions I and II have operated in (28a): Convention I labels the non-branching node above the stem dix with all of the features of this morpheme, and Convention II labels the first branching nodes above erā and mus. Since each of these morphemes are unspecified for some of the verbal features, Convention III automatically fills in values from lower nodes wherever they are available. Thus, in (28b) the highest branching node in dixerāmus is fully specified for tense, aspect, person and number features, and these values will therefore be available for the syntax. Presumably, feature matrices for nouns and adjectives will work the same way with unspecified features (e.g., for gender or number) being filled in by Convention III.

Moreover, in cases where nodes in a lexical tree are dominated by different category labels, features belonging to one category class will be blocked from percolating up a tree to a node dominating another category and its associated matrix of features:

(29)

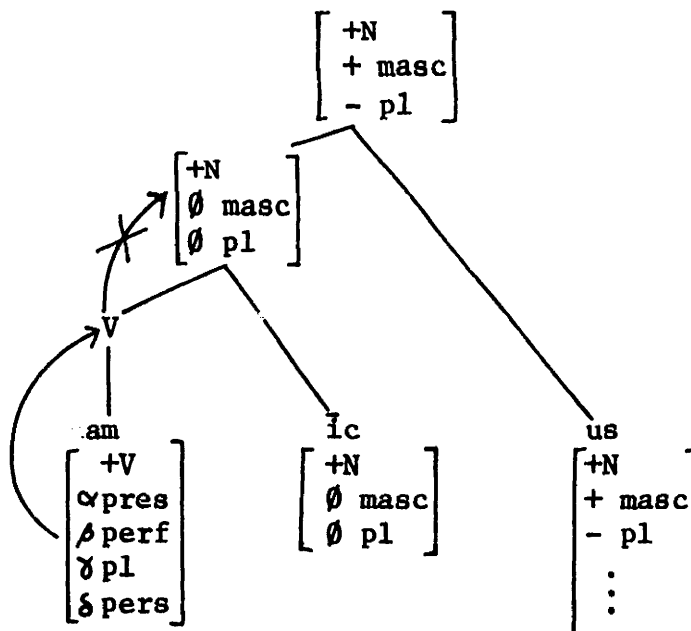

So, although the noun amīcus 'friend' is derived from the verbal root am which is specified for at least some of the verbal features, none of these features will percolate up to the branching node dominating am and īc, since this node will first receive the nominal feature matrix by Convention II. Convention III thus fills in unspecified values for features in a series of nodes of the same category, or fills in an entire matrix including category in cases like that of counter above, where a morpheme is completely 'transparent'; it will not, however, pass verbal features onto a noun node, nominal features onto an adjective node, etc. The claim embodied in this device, then is that it will never be necessary either in the morphological component or in the syntax to have access to verbal features in a deverbal noun or adjective, or nominal features in a denominal verb.

Only one more point needs to be elaborated before I compare my lexical structure system to that of Williams. So far, I have said nothing about the internal structure of compound words. The feature percolation conventions needed above only allow us to label the tree in (30) as far as the non-branching nodes dominating the stems:

(30)

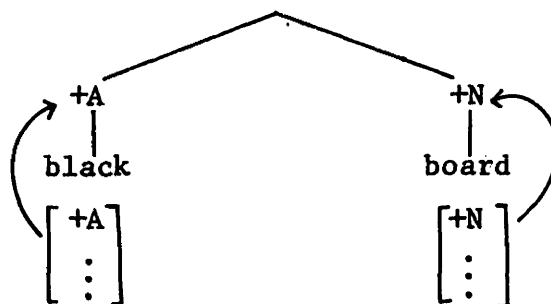

Convention I allows the features of the stems black and board to percolate to the non-branching nodes, but it gives us no way of labeling the branching node. Conventions II and III are of no help



here either: blackboard contains no affixes, so II is inoperative, and III simply tells us to percolate features from wherever possible. This is uninterpretable in the case of (30), since the branching node would thereby receive two full (and different) sets of features. Yet it is clear to speakers of English that blackboard is a noun, and not an adjective or a combination of noun and adjective. We therefore need to add a feature percolating convention specifically for compounds:

(31) Feature Percolation Convention

Convention IV (Compounds): In compound words in English features from the righthand stem are percolated up to the branching node dominating the stems.

Although this may seem to be an ad hoc addition to our theory, it has empirical consequences that will prove to be important later in this discussion. Conventions I-III are intended to be language universal principles of word formation. Convention IV, however, is specifically meant to be language particular: English needs this rule, as do German and most of the other Indo-European languages. It is predicted, however, that there may be languages that need a different feature percolating mechanism for compounds, or lack a mechanism for compounds entirely (i.e., they do not have compounds). The significance of this claim will become apparent in the context of the discussion to follow.

Williams' (1979) lexical structure system contains essentially the same elements as the system proposed here, namely lexical rewrite rules, and a device which allows features to percolate up nodes of a lexical tree in a highly constrained way. His lexical structure rules are as

follows:

(31) Lexical Structure Rules (Williams)

root → af root, root af  
 stem → root  
 stem → af stem, stem af  
 word → stem  
 word → word word

The rules in (31) differ in a number of ways from Selkirk's (cf. Williams (1979) for arguments in favor of this array of rules), but at least one of the arguments against Selkirk's system holds here too. The terms root, stem and affix need not be taken as primitives, given a standard conception of the structure of lexical entries.

Williams' real innovation is the addition to lexical structure theory of the notion of lexical head, with the concomitant Righthand Head Rule (RHR):

(32) "In morphology, we define the head of a morphologically complex word to be the righthand member of that word -- thus, the head is underlined in the following:



Call this definition the Righthand Head Rule (RHR). (1979:5)

In syntax, the head of a phrase is the element in the phrase that has the same distribution, and belongs to the same category as the phrase itself. The definition of morphological head is meant to be analogous: the head of a word is the element that has the same category and other properties as the word itself. Although not couched in such terms, the

notion of morphological head, and the Righthand Head Rule in fact serve to define the allowable routes along which features can percolate up nodes of a lexical tree. Heads, in Williams' system determine the category membership of the items to which they attach, as well as their composition in terms of syntactic and diacritic features. So a word formed from an adjective to which ness has been affixed takes the category of the affix, namely noun, and a word formed from a verb stem to which a past tense morpheme -ed has been attached takes on the feature [+tense] from -ed. Pictured in tree-structural form (which Williams uses as well), we can see that the RHR amounts to a form of feature percolation:

(33)

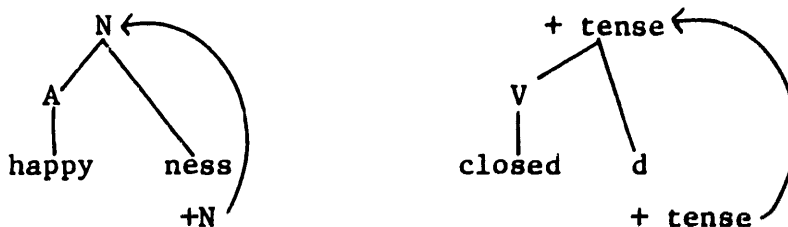

Williams' theory and the one proposed here differ, however, in the ways that they allow features to percolate. Williams specifically forbids features from percolating from lefthand constituents: his RHR states that only righthand constituents are heads, and only category and diacritic features of heads are passed on to words as a whole. Similarly, his theory implies that all righthand constituents are heads, i.e., all righthand constituents should have features to percolate. The theory sketched above, in contrast, simply states that features percolate to branching nodes from affixes, regardless of whether they occur to the left or to the right of the stem. There also exist affixes

which are transparent, and therefore have no features to percolate: convention III takes over in these cases, and ensures that all branching nodes receive labels, and that all 'empty slots' in feature matrices are filled. The empirical difference between the two systems is straightforward, and easily testable. Williams' theory predicts that morphology is universally asymmetrical: no language ought to have category changing prefixes or 'lefthand' compounds, and no language ought to have suffixes (righthand constituents) which are transparent in the way that the prefix counter- is in English. The lexical structure theory advocated here is symmetrical: both left and righthand heads and left and righthand transparent (or non-head) constituents should be possible.

Category changing prefixes clearly do occur, although they are rarer in English and German, at least, than category changing suffixes. Williams mentions the prefix en- in English, which attaches to nouns and adjectives to form verbs:

(34)

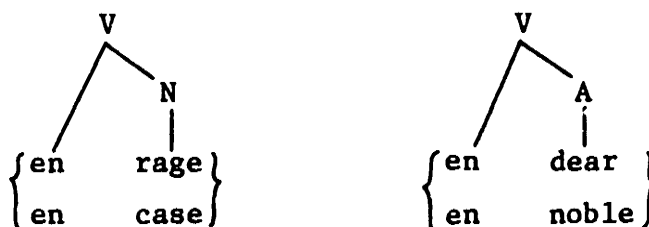

According to Williams, en- displays all of the characteristic behavior of heads: besides systematically creating verbs, it 'potentiates' certain other affixes. By 'potentiation', Williams means that the presence of a given affix usually allows another affix to attach productively to a derived form; so the suffix -ment attaches

productively to forms with the affix en-. Potentiation is a characteristic of head constituents. Williams therefore concludes that en- is a systematic exception of the RHR; in effect, this is an admission that there are lefthand heads.

German has at least two prefixes which behave like en- in English. ver- and be- attach to nouns, adjectives, verbs and occasionally adverbs to form verbs:

- (35) a.  $[_V \text{ --- } [_N$
- |           |        |            |          |
|-----------|--------|------------|----------|
| verholzen | (Holz) | benutzen   | (Nutz)   |
|           |        | befreunden | (Freund) |
- b.  $[_V \text{ --- } [_A$
- |               |            |            |          |
|---------------|------------|------------|----------|
| verbessern    | (besser)   | beruhigen  | (ruhig)  |
| verjüngen     | (jung)     | belastigen | (lastig) |
| verwirklichen | (wirklich) | beleidigen | (leidig) |
| versichern    | (sicher)   |            |          |
- c.  $[_V \text{ --- } [_V$
- |            |           |          |          |
|------------|-----------|----------|----------|
| verlaufen  | (laufen)  | benehmen | (nehmen) |
| verbringen | (bringen) | belieben | (lieben) |
- d.  $[_V \text{ --- } [_{Adv}$
- |              |           |  |  |
|--------------|-----------|--|--|
| verlangsamen | (langsam) |  |  |
|--------------|-----------|--|--|

Presumably, these forms have structures like those in (36):

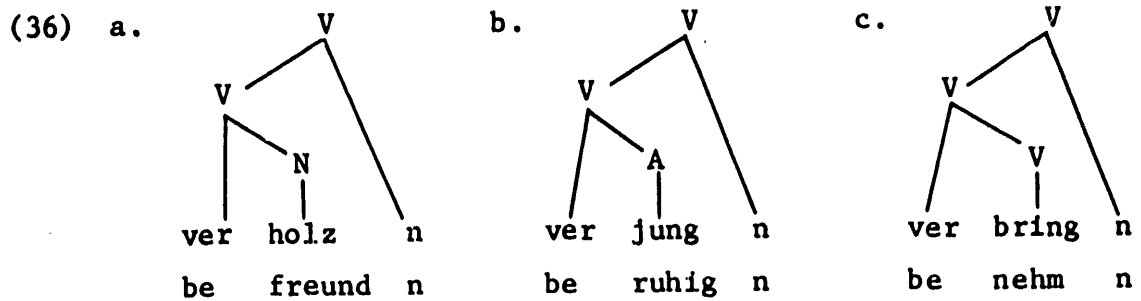

In other words, the category features of the derived words are those of the prefixes, rather than those of the righthand constituent.

Therefore, be- and ver- will also have to be systematic exceptions to Williams' RHR -- i.e., lefthand heads.

In contrast, the theory developed above predicts the facts in (34)-(35): en- in English, be- and ver- in German have lexical entries which are specified for the category V. Feature Percolation Convention II will label the lowest branching node in (36) with this category (and its other associated features) in the same way that it will label a branching node dominating a suffix containing category features. There is no exceptionality involved.

My system of lexical structure also predicts that in some languages lefthand compounds should exist, that is, compounds in which the feature matrix of the lefthand stem is percolated to the branching node dominating both stems, as in (37):

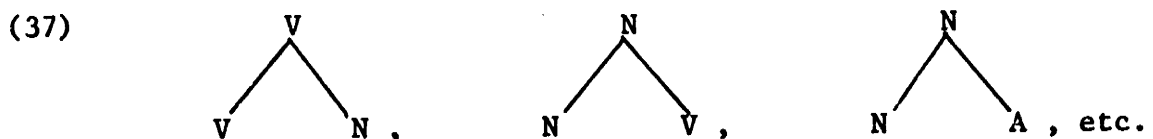

Since Conventions I-III fail to label the branching node dominating compounds, I added a convention specifically for English compounds that

allows features to percolate from the righthand stem. The implication was, of course, that this convention doesn't necessarily apply in languages other than English. In fact, there do appear to exist languages with lefthand compounds. For example, Thompson (1965) gives examples of compounds in Vietnamese consisting of either a noun stem followed by a verb stem, or a verb stem followed by a noun stem: the former compounds act like lexical nouns, the latter like lexical verbs:

- (38) a. người ở'  
           person be located = servant
- b. nhà thương  
           establishment be wounded = hospital
- c. làm việc  
           do, make matter, affair = to work
- d. làm ruộng  
           do, make rice field = engage in farming

Thompson argues that the forms above are compounds, rather than syntactic phrases on the following grounds: a) their meanings are usually lexicalized, b) they consist of only two stems, c) they have a characteristic stress contour with weak stress on the initial stem and heavier stress on the second stem, and d) no modifying constituent can intervene between the two stems (forms where a constituent is inserted between the two stems are interpreted without the lexicalized compound meaning, but with a compositional phrasal meaning). In my framework, the forms in (38) would be assigned structures as in (40) via Convention I, which is universal, and another language particular labeling convention stated in (39):<sup>9</sup>

## (39) FEATURE PERCOLATION CONVENTION

Compounds (Vietnamese): In compound words in Vietnamese, features from the lefthand stem are percolated up to the branching node dominating the stems.

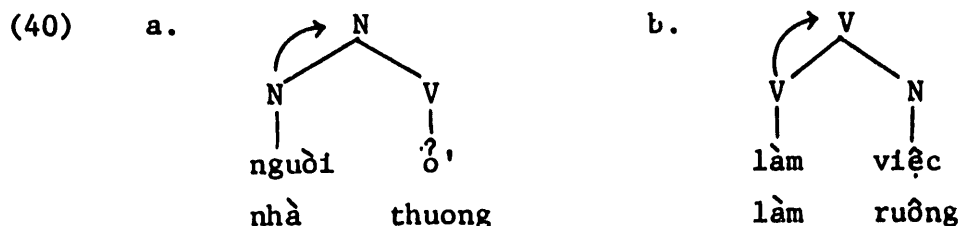

The existence of lefthand compounds is problematic for Williams' lexical structure theory. Since lefthand stems are never heads (and therefore never percolate features), these too must be considered exceptions.

The final sort of phenomenon which is predicted not to exist by Williams' RHR is a suffix, or righthand constituent which is transparent in the same way that the prefix counter is transparent in English. Since all and only righthand constituents are heads, in Williams' sense, all and only righthand constituents should have features to be percolated; a suffix which lacks its own feature matrix would therefore be a counterexample to Williams' system.

An example of such a transparent suffix is the Spanish diminutive. Jaeggli (1977) presents an analysis of the Spanish diminutives which distinguishes between an infix diminutive -it- and a suffix diminutive sit+V, where V indicates a phonologically unspecified theme vowel. The precise conditions under which one form is used rather than the other and the precise mechanism which specifies which theme vowel will occur in sit+V will not concern us here. A number of properties of the suffix sit+V are relevant to the present discussion, however. First, sit+V,



and Spanish diminutive affixes in general, attach to both nouns and adjectives to form, respectively, nouns and adjectives. More precisely, they attach to the root form of the nouns or adjectives, that is, the stem without the theme vowel.

- (41)            grandesito            'quite large'  
                    madresita            'mother-dimin.'

Thus, the suffix sit+V behaves exactly like the prefix counter in English; it adds no category features of its own. Nor does it add any gender features of its own: the diminutivized form has the gender of the undiminutivized form. We must therefore have a lexical entry with a subcategorization frame like that for counter: (42) illustrates such a frame, where the outer bracket lacks a category specification:

- (42)            sit+V                    ]<sub>N,A</sub> — ]

Within the framework developed here, features percolate to the non-branching nodes via Convention I. Convention II fails to operate, since the suffix lacks a feature matrix. Convention III then fills in the stem features on the branching node:

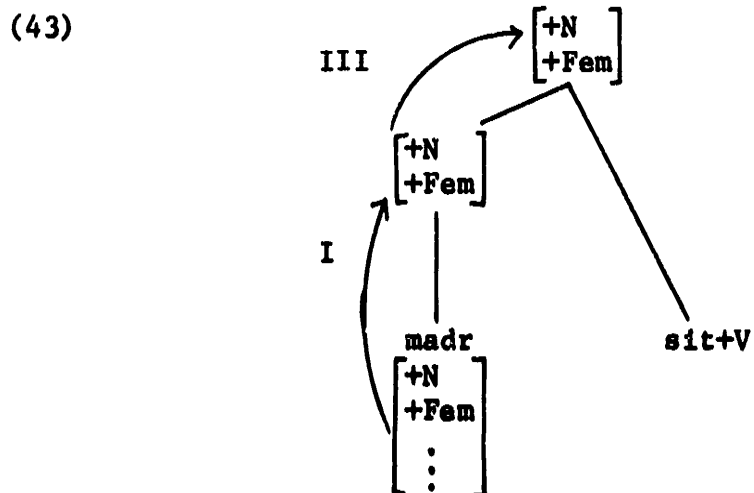

The Spanish diminutive is another example which is intractable within Williams' lexical structure system. Since the features which ultimately determine the gender as well as the category of the whole word, must come from the lefthand constituent (the righthand constituent lacking features entirely), this phenomenon must again be written off as an exception to RHR. It is entirely consistent with a symmetrical lexical structure system, however. In fact, we have seen three sorts of phenomena which all argue for the existence of lefthand heads, and therefore for symmetrical structure. These phenomena all provide support for the lexical structure system developed here.

It should be noted, before we leave the subject of lexical structure entirely, that I have virtually done away with the notion of 'Word Formation Rule' (WFRs) which has been a part of generative morphology since its inception. WFRs, as conceived by Aronoff (1976) were operations which attached an affix to a specified category of stem, producing a word of a specified category:

$$(44) \quad {}_A [ \quad ] \longrightarrow [ {}_N [ {}_A \quad ] \text{ness} ]$$

There were as many WFRs as there were affixes in a language. Each WFR was a distinct process. Selkirk took the first step towards eliminating individual WFRs by proposing lexical structure rules of a general sort; lexical structure morphologies do not conceive of affixation as a series of separate processes, but rather as a phenomenon analogous to lexical insertion in syntax. Moreover, once we have changed our system from one with WFRs to one with lexical entries and general lexical structure rules, we must make another change. That is, the so-called Adjacency

Condition, formulated independently by Siegel (1977) and Allen (1978) was originally stated as a condition on WFRs:

(45) Adjacency Condition (Allen 1978:49):

No WFR can involve X and Y, unless Y is uniquely contained in the cycle adjacent to X.

The reader is referred to Siegel (1977) and Allen (1978) for explanation and justification of this principle. Here, I would simply like to point out that this principle can be adopted into a lexical structure morphology in a rather simple way: since we have no 'rules' in Aronoff's sense, Adjacency must be seen instead as a condition on subcategorization:

(46) Adjacency (revised):

No subcategorization frame can state a dependency between X and Y if there is more than one bracket between X and Y; i.e.,

\*X/ Y]Z]\_\_\_

\*X/ \_\_\_[Z[Y

where Z may be  $\emptyset$

As far as I know, no empirical consequences result from making this change.

To end this section, I would like to summarize the points at which lexical structure systems surpass Aronovian WFRs in theoretical simplicity and explanatory force. By conceiving of affixation as a form of lexical insertion, and by giving affixes lexical entries of the same sort as stem morphemes, lexical structure morphologies isolate a large portion of lexical idiosyncrasy in a single place: we expect affixes,

for example, to bear the same sorts of diacritic features as stems, and to belong to the same lexical classes. Within a WFR morphology, there are presumably no lexical entries for affixes; it is therefore not clear that we should expect affixes to share any of the properties of stem morphemes. However, since they do share properties -- diacritic features and membership in the same lexical classes, for example -- this information must be written into the WFR for each affix. Identical sorts of information are then represented in two different parts of our morphology: in lexical entries for stem morphemes, and in WFRs for affixes. Lexical structure morphologies are more streamlined in some sense. Moreover, lexical structure systems, in particular the one developed here, allow us to expand the explanatory force of our morphology; with a very small amount of theoretical machinery, we can give real content to the terms root, stem and affix, predict the sorts of derived words and compounds we expect to find in human language, and explain their feature composition and membership in lexical classes.

### 1.3. Lexical Transformations and String Dependent Rules

So far, we have divided the morphological component of our grammar into two subcomponents, a permanent lexicon containing lexical entries organized into category classes and lexical classes, and a lexical structure component. Each of these subcomponents was characterized by specific rule types. The permanent lexicon contains morphological rules and redundancy relations,<sup>10</sup> the lexical structure component a lexical structure rewrite rule and a number of feature percolation conventions. These devices, however, are not by themselves sufficient to characterize the full range of word formation processes in natural language.

Specifically, there clearly exists a class of morphological processes which are productive, but non-affixational. Reduplication, infixing, vowel ablaut and umlaut processes belong to this class.

For example, a form of gerund is derived in Tagalog by prefixing the morpheme pag- and repeating the first consonant and vowel of the stem, the vowel of the copy being [-lg], regardless of the length of the stem vowel (this reduplication process and others in Tagalog will be discussed in some detail in Chapter 4). Carrier (1979) gives the examples in (47), and formulates the rule as in (48):

- (47) a. lākad                      pag-la-lākad  
           walk (vb. stem)        walking
- b. sunod                    pag-su-sunod  
           obey (vb. stem)        obeying

(48) R1 Reduplication (Carrier 1979:190)

$$\begin{array}{ccccccc} C & V & & & & & \\ 1 & 2 & \longrightarrow & 1 & \overset{2}{-lg} & 1 & 2 \end{array}$$

Tagalog also has a productive rule of infixing which metathesizes an affix um with the first consonant of a stem to form a verb stem.

- (49) um-bukas             $\longrightarrow$         bumukas  
       'open'
- um-tiktik           $\longrightarrow$         tumiktik  
       'spy'
- um-dikit             $\longrightarrow$         dumikit  
       'get stuck to'

Presumably such a rule would have to be written as in (50):

(50) Tagalog Infixing

$$\begin{array}{ccccccc} \text{um} & \text{C} & \text{V} & & & & \\ 1 & 2 & 3 & \longrightarrow & 2 & 1 & 3 \end{array}$$

In Chapter 4, I will argue that the process of umlaut in German involves a morphological rule of the following sort:

(51) [+syl]  $\longrightarrow$  [-bk] / \_\_\_\_ C<sub>0</sub> [+U]

This rule states roughly that a stem vowel is fronted in the environment of a morpheme bearing an abstract umlauting feature [+U]: German affixes such as -lich, and the diminutive -chen possess this feature.

Rules (48), (50), and (51) share two important properties: first, they are productive. Unlike morpholexical rules which apply to a small, arbitrary set of forms, these rules can potentially apply to any form which meets their structural descriptions. Second, unlike affixational word formation, processes of reduplication, infixing, and umlaut are dependent upon the nature of their base forms. Affixation involves the concatenation of a set string to another string. The internal makeup of the strings is largely irrelevant. (48), (50) and (51), however, are string dependent rules in that they must refer to segmental properties of the items to which they apply. Reduplication copies segments of its base, infixing reorders an affix with segments of its base, and umlaut changes the vowel of its base form. My strategy so far has been to attribute to each level of morphological structure its own unique rule types. The presence of productive string-dependent word

formation rules therefore suggests that we add yet another level of morphological structure to our morphology.

I will have little to say about string dependent rules in this chapter. Chapter 4, however, will be devoted to a discussion of these rules, and their formal statement. I will concentrate there on the processes of reduplication in Tagalog and umlaut in German, and show that these rules share a number of properties. Here, I will merely suggest that such a subcomponent of rules is necessary in our morphology, and that all string dependent rules belonging to this subcomponent apply in a block to the structures created in the lexical structure subcomponent. (52) illustrates the general model intended.

(52)

PERMANENT LEXICON		
CATEGORY: N	CATEGORY: V	CATEGORY: A
Lexical Class i (Morphological rules) --- Lexical Class i+1 (ML rules)		

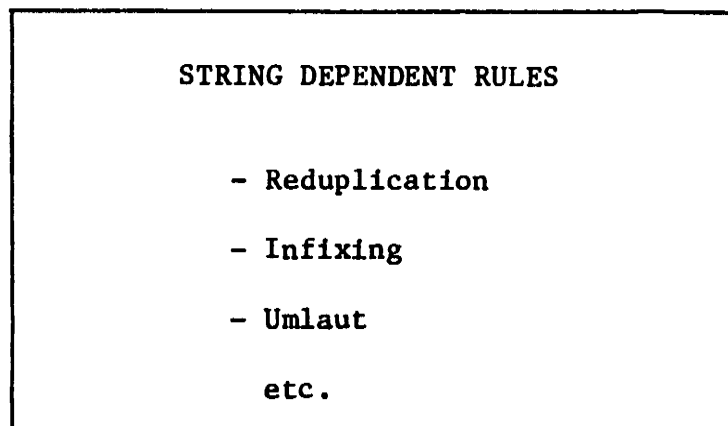
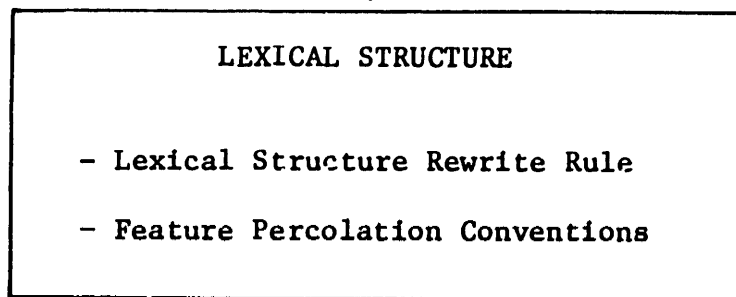



#### 1.4. Lexical Semantics

Up to this point I have said nothing about the roles of various subcomponents of our morphology in determining the meanings of morphologically complex words. Lexical entries for morphemes, it was argued, have semantic representations, but so far we have no way of putting these representations together to derive complete semantic representations. This section is intended to review and assess the assumptions about lexical semantics which have been made in previous theories of word formation, and to explore the place of semantics in the theory being developed here. I will not propose a full theory of lexical semantics in this section. Rather, I will argue that there is no more reason to believe that semantics should be a part of the formal mechanics of word formation, than there is to suppose that semantics is a part of the formal mechanics of sentence syntax (i.e., phrase structure, transformations). It has long been a basic tenet of generative syntax that syntax and semantics constitute autonomous components of the grammar. The claim will be made below that the "syntactic" or structural aspects of word formation should also be autonomous from lexical semantics.

Autonomy of morphological syntax and semantics was clearly not assumed in the earliest works on generative morphology. For example, for Aronoff, a word formation rule was an operation which added a fixed segmental string to a base of a specified structural and semantic sort, and at the same time specified the structural and semantic properties of its outputs. The semantic representations of derived words were thus built up step by step with the structure of those words. That is,

the semantics of words derived by WFRs was always compositional. If a word, for example transmission (of a car) had a clearly non-compositional meaning, it had a separate lexical entry, and therefore a separate semantic representation. The implication was that a word which was semantically opaque was also necessarily structurally or syntactically opaque. Thus the major claim about lexical semantics within a theory like Aronoff's was that lexical structure and lexical semantics were isomorphic.

Word formation rules, in Aronoff's framework, could also refer to semantic properties of their bases, for example, by stating that affix X could only attach to verbs with semantic characteristic Y:

More detailed, and a little more exotic, is the constraint on the base for the prefix re#, which forms words such as repaint, and rewire. ... This prefix attaches only to verbs whose meanings entail a change of state, generally in the object of the verb.  
(1976:47)

Compositional but semantically deviant words like rekill could no more be generated than syntactically deviant words like unpeace (where the negative affix un- is subcategorized to attach only to adjectives), since the WFR for re- would state necessary semantic properties of its base verb.

A number of examples have appeared in the recent literature which suggest that lexical semantics is not necessarily isomorphic with lexical structure. The first, pointed out by Williams, and also discussed by Allen and Pesetsky concerns words like hydroelectricity, macroeconomic, and ungrammaticality. These words must have the

structure shown in (53):

(53)

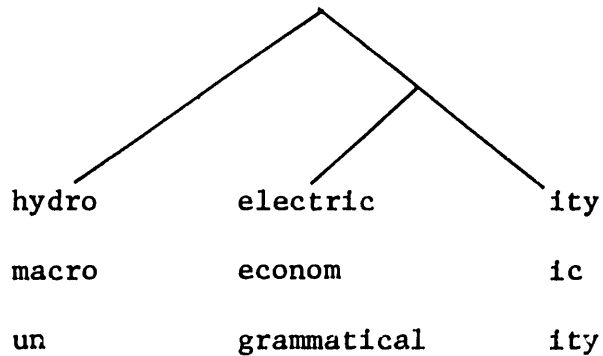

The grounds for assuming a right-branching structure are the following. It has been argued (Allen 1978, Siegel 1974) that ity and ic are + boundary or Level I affixes, whereas hydro, macro, and un are # boundary or Level II affixes. -ity and -ic are phonology affecting affixes, since both change stress contours, and ity, in addition, conditions Velar Softening. macro, hydro and un have no such effects, and therefore are Level II affixes. Within a Level-Ordering morphology, Level II or # affixes always attach outside Level I or + affixes, thus ruling out left-branching analyses for the structure of the words in (53). Yet our intuitive sense of the semantic composition of these words is the following:

- (54)
- a. hydroelectric ity
  - b. macroeconom ic
  - c. ungrammatical ity

Similarly, there exist compound forms such as those in (55):

(55)

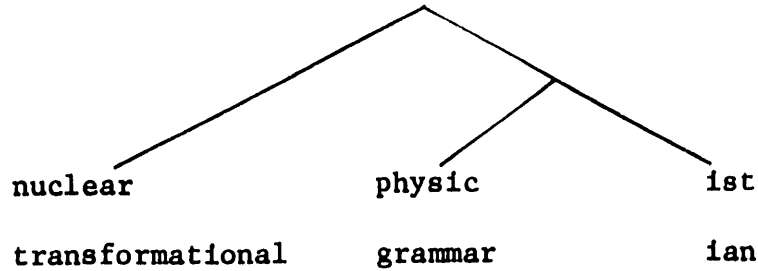

Clearly, we also want right-branching structures here, since we don't in general want to allow derivational affixes to attach to compounds. Semantically, however, the compounds nuclear physicist and transformational grammarian are related to the compounds nuclear physics and transformational grammar: a nuclear physicist is a person who does nuclear physics, and not a physicist who is nuclear. Similarly, transformational grammar has a specialized meaning, and a transformational grammarian is someone who engages in that sort of specialized activity. That is, any reasonable system of lexical semantics would assign meanings to these following a left-branching pattern:

- (56) a. nuclear physicist ist
- b. transformational grammarian

No theory of word formation which assumes an isomorphism between lexical structure and lexical semantics could account for such cases.<sup>11</sup>

A second example of a regular word formation process in which lexical structure and lexical semantics seem not to be isomorphic comes from Pesetsky (1979). Consider the following paradigms:

- (57) a. dušit' 'to strangle'  
 b. dušitel' 'strangler'  
 c. dušitel'n±j 'suffocating' (of a room, etc.)  
 d. dušitel'sk±j 'of a strangler'
- (58) a. mučit' 'to torture'  
 b. mučitel' 'torturer'  
 c. mučitel'n±j 'excruciating, agonizing'  
 d. mučitel'sk±j 'of a torturer'

According to Pesetsky, the forms in (57, 58c-d) are all derived with the forms (57, 58b) as bases. The forms in (57, 58d) are perfectly compositional, and therefore present no difficulties. The forms in (57, 58c), however, have the peculiarity that their meaning consists of the meaning of the root (57, 58a) plus the meaning of the last suffix, whose underlying form is Yn, regardless of what affixes intervene. Thus, the meaning of the agentive suffix (57, 58b) is "wiped out" by the presence of -Yn. Clearly, this is not merely semantic idiosyncrasy: according to Pesetsky -Yn has this effect with whatever suffixes intervene between it and the root. Rather, this seems to be another case where semantic structure and syntactic structure are systematically non-isomorphic. No semantic rule for deriving the meaning of these forms could be written within Aronoff's framework. Such a rule might easily be formulated, however, if we separate rules of lexical semantics from rules of lexical structure.

A third argument for separating rules of lexical semantics from rules of lexical structure comes from compounds like paleface, redcap and blackboard. Such compounds have idiosyncratic meanings: a paleface is not someone whose face is pasty, but rather a whiteman in the lingo

of Hollywood Westerns. A redcap is a porter in a train station. Presumably, within Aronoff's theory, these forms would not be put together by productive compounding rules. Instead, like semantically noncompositional derived words (e.g., transmission), they would simply be given separate lexical entries with separate semantic representations. The implication again would be that they are structurally as well as semantically noncompositional. This sort of analysis clearly misses a generalization, however. That is, if these compounds were formed as a part of our productive lexical structure component, we would have an explanation for the fact that they are all nouns, and not adjectives or verbs:

(59)

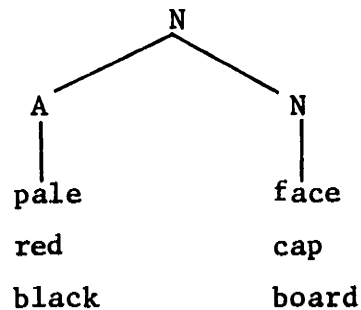

If these compounds were formed by the regular process of lexical insertion into unlabeled tree structures, Feature Percolation Convention IV would label the trees as in (59). We would therefore predict the category membership of such forms. The fact that compounds can be semantically noncompositional and at the same time structurally regular again argues for the autonomy of lexical semantics.

The autonomy of lexical semantics is, in fact, implied by a theory of word formation which chooses a lexical structure subcomponent over a system of word formation rules. Obviously, since a theory which

subsumes a lexical structure system does away with Aronovian word formation rules entirely, semantic representations cannot be put together via these WFRs. Semantic interpretation therefore requires a separate set of devices within such a theory. So far, we have argued that part of the lexical entries for terminal elements in the permanent lexicon is their semantic representation. Lexical terminals are inserted into structural trees which are labeled according to our Feature Percolation Conventions. The meanings of these terminal elements must then be put together in some way.

We might start out, as an initial hypothesis, with a set of Katz and Fodor type (1964) projection rules. Such semantic rules work up a lexical tree from smaller constituents to larger constituents amalgamating semantic representations. This proposal, in fact, has a certain advantage over Aronoff's sort of semantic interpretation; that is, it gives us a way of dealing with selectional deviance in derived words without ruling out such words entirely. Within Aronoff's framework, words like rekill and unkill (reversative un) could not be generated at all. re and un could only attach to verbs involving a change of state, and kill is not such a verb. But rekill and unkill sound far less deviant than words like \*unpeace and \*refusity. The former violate semantic restrictions. The latter involve violations of subcategorization: un (negative) attaches only to adjectives, un (reversative) to verbs, and ity only to adjectives. The theory using lexical structure and semantic projection rules accounts for the difference in deviance in the following way. unpeace and refusity cannot be generated at all, since it would violate subcategorization

restrictions on un and ity to insert them into trees containing peace and refuse. rekill and unkill will be generated however. When our semantic projection rules come to amalgamate the meanings of the individual morphemes, they will register some deviance as a result of a conflict in some semantic feature specification of affix and stem. In this way, we can more naturally account for the difference in 'grammaticality' between the two sorts of case.

Once we have postulated an autonomous set of semantic projection rules for compositional lexical semantics, it is not a major step to postulate other autonomous semantic rules to account for non-compositional lexical semantics. For cases like transmission, paleface, redcap, etc. we can postulate a series of semantic rules which map an idiosyncratic meaning onto a sequence of morphemes. The effect of this proposal is that words can be structurally compositional (i.e., possess the expected internal structure) while at the same time being semantically noncomplex. One ramification of this proposal is that compounds like paleface and redcap are predicted to be nouns. A second ramification is that the semantic interpretation of these forms is now analogous to that of idioms and verb-particle constructions. It is often said that phrases like kick the bucket and call up have lexicalized meanings; the meaning of the whole phrase is not the sum of the meanings of its parts. Yet idioms and particle verbs exhibit structural similarities to phrasal constituents which do have compositional meanings. In terms of morphology, for example, inflection appears on the outside of the verb, just as it would if the phrases had compositional meanings -- i.e., kicked the bucket, calls up.



These properties are easily accounted for in a framework where lexical semantics is autonomous from word formation. Rules of semantic interpretation similar to the ones needed for transmission, paleface, etc., map idiosyncratic meanings onto the sequences kick the bucket and call up. Structurally, however, these are still phrases, just as paleface is a normal compound. Within an Aronovian WFR framework, the observation that idioms and verb-particle combinations have lexicalized meanings in the same way that some derived words and compounds do can only be taken to mean that these phrases have individual lexical entries with their own semantic representations, just as transmission and paleface would. But this is an untenable position: once we list phrases in the lexicon, we imply that they lack internal structure. We would then predict wrongly that inflection occurs on the outside of these phrasal "words": \*kick the bucketed, \*call ups. Within an Aronovian morphology we would thus be forced to conclude that the semantics of idioms and verb-particle combinations must be treated differently from that of words and compounds with idiosyncratic meanings, despite the a priori similarity of the cases.

Within a theory of lexical semantics which contains autonomous projection rules and mapping rules of the sort needed for semantically idiosyncratic words and phrases, it no longer seems strange that there should exist a need for semantic rules that refer to structural non-constituents (e.g., the transformational grammarian cases), or semantic rules that wipe out the meanings of certain lexical constituents in the presence of a certain affix (Pesetsky's Russian example). What a theory of lexical semantics should look like, what sorts of rules are

needed, and what sorts of constraints must be placed on rules of lexical semantics are questions which must be answered if we accept the autonomy of lexical semantics, but they are questions which I cannot answer here. In any case, we must accept that lexical semantics is in principle autonomous from the structural aspects of generative morphology, which will be the main concern throughout the rest of this thesis.

## 2. Latin Verb Paradigms

The verbal system of Latin provides fertile grounds for a study which takes as its goal the integration of inflectional morphology and derivational morphology into a single system of word formation. Latin has abundant inflectional stem allomorphy and abundant inflectional affixation as well. Latin also possesses a well-developed system of derivational word formation, allowing for comparisons between inflectional and derivational processes. This section will therefore be largely descriptive. I will illustrate the sorts of verbal stem allomorphy found in Latin and set up the classes needed for the verbs. It will be argued that Latin does not have five monolithic conjugations, as traditional grammars have always claimed. I will also propose lexical entries for the inflectional affixes of the indicative paradigms, and show how complex verb forms are built up using the lexical structure system motivated above. Finally, I will propose a structure for Latin prefix verbs, and present an argument in favor of this structure.

A number of theoretical points will emerge from this description, however. To foreshadow my results, I will argue that inflection and

derivation are not in principle different sorts of word formation: exactly the same devices which are needed to form complex derived words are also needed to form complex inflected forms such as amābamus, first person plural indicative imperfect of 'love' and amāveram, first person singular pluperfect of 'love'. If inflection and derivation were different sorts of word formation, one would not expect this to be the case. Second, I will argue that we need no special representation of inflectional 'paradigm' within this system; i.e., the notion of paradigm has no theoretical status here, and will be dispensed with. Finally, parts of the analysis presented below will suggest a redefinition of the notion of morphological productivity.

## 2.1. Latin Phonology

Any description of the morphology of Latin presupposes that we have first determined which phenomena in Latin are truly morphological, and which are to be accounted for by phonological rules. For the purposes of this thesis, it will be sufficient to discuss a number of vowel deletion, vowel mutation, and vowel length rules which obscure morphological regularities in both the verbal and the nominal paradigms. Consider first the paradigms in (60):

(60)	a.	amō	moneō	capīō	audiō	legō
		amās	monēs	capis	audīs	legis
		amat	monet	capit	audit	legit
		amāmus	monēmus	capimus	audīmus	legimus
		amātis	monētis	capitis	audītis	legitis
		amant	monent	capiunt	audiunt	legunt

b.	amābō	monēbō	capiam	audiam	legam
	amābis	monēbis	capīēs	audiēs	legēs
	amābit	monēbit	capiet	audiet	leget
	amābimus	monēbimus	capīēmus	audiēmus	legēmus
	amābitis	monēbitis	capīētis	audiētis	legētis
	amābunt	monēbunt	capient	audient	legent

(60a) are the present indicative paradigms for the five traditional Latin conjugations, and (60b) the future indicative paradigms. These conjugations have traditionally been distinguished on the basis of a characteristic vowel which shows up before other inflectional endings: these vowels, hereafter referred to as theme vowels, are for the first four verbs, left to right, ā, ē, i, and ī. The nature of the theme vowel in verbs like lego will be the subject of much of the discussion below. Besides a verb stem with theme vowel, these paradigms illustrate the person/number inflections and the future morphemes, which are traditionally said to have the following forms:

(61) a. P/N Endings

sg. 1 -ō/-m	pl. 1 -mus
2 -s	2 -tis
3 -t	3 -nt/-unt

b. Future

-bi- (for ā and ē verbs)

-ē- (for verbs like capīō, audiō, and legō)

A number of minor phonological rules delete and shorten vowels. First, I assume a rule which deletes ā before ō (this will be refined below);

this accounts for the difference between amō (from amā+ō) and moneō, capiō, and audiō. Two more rules alter the length of vowels in verb forms.<sup>12</sup>

(62) a. V → [-lg] / \_\_\_\_ V

b.  $\left[ \begin{array}{c} V \\ -\text{str} \end{array} \right] \rightarrow [-lg] / \text{---} \left[ \begin{array}{c} +\text{cons} \\ -\text{strid} \end{array} \right]$

(62a) shortens a vowel when it precedes another vowel: audi+unt → audiunt, monē+ō → moneō. (62b) shortens an unstressed vowel before non-strident consonants: amā+nt → amant, amā+t → amat, but amā+s → amās. The theme vowel in amāmus remains long because it is stressed.

With these minor rules out of the way, we can begin to attack the question of what the theme vowel is for verbs like legō. Superficially, legō seems to have the same theme vowel as capiō, at least in the 2,3 person singular, and 1,2 person plural: legis, capis; legit, capit; legimus, capimus; legitis, capitis. But legō lacks a theme vowel in 1 singular present and 3 plural present, and throughout its future paradigm. That is, legō, and verbs like it, lack theme vowels before all vowel initial inflections:

(63)	<u>capi</u> -ō	<u>leg_</u> -ō
	<u>capi</u> -unt	<u>leg_</u> -unt
	<u>capi</u> -ē-...	<u>leg_</u> -ē-...

Redenbarger (1976) argues that verbs like legō are unlike verbs like amō, moneō, capiō, and audiō in that they are athematic; legō lacks an underlying theme vowel corresponding to the ā, ē, i, and ī theme vowels

of these other verbs. Redenbarger claims that the partial similarity between the conjugations of capiō and legō is to be attributed to the following phonological rule:

(64)  $\emptyset \rightarrow i / C \_ +C$

(64) inserts the segment i when a stem ending in a consonant is followed by a consonant initial affix. The rule epenthesizes i in second and third person singular contexts, for example, but not in first person singular or third person plural:

(65)

leg+s	→	legis
leg+t	→	legit
leg+ō	→	legō
leg+unt	→	legunt

Redenbarger suggests that (64) also accounts for the future paradigms with bi:

(66)

amābō	amābimus
amābis	amābitis
amābit	amābunt

Here, too i occurs before consonant initial affixes (-s, -t, -mus, -tis) but not before vowel initial affixes (-ō, -unt). If the underlying form of this future affix is b, rule (66) will operate to insert i in the proper environments.

There are a number of reasons for considering this analysis incorrect, however. First, rule (64) fails to give the correct output for the nominative singular of the noun dux. Since this form has the underlying representation duc+s, Redenbarger's rule predicts the form

ducis for the nominative singular; he is forced to postulate a minor rule deleting the epenthetic i in just this environment.

Even with such a minor rule added to the grammar, there is evidence that Redenbarger's analysis does not work. Consider the following forms:

- (67)    dic+t+ō            'to reiterate' from dicō  
           dic+tit+ō        'to say frequently' from dicō  
           ag+men            'something driven or moved' from agō  
           mūnus+culum       'a little gift'    diminutive affix -culum

All of the forms in (67) are words derived with consonant initial suffixes. Since the stems in question are consonant final as well, Redenbarger's rule predicts the forms \*dicitō, \*dicititō, \*agimen, and mūnusiculum. The correct forms all lack the epenthetic i.

This evidence might seem to suggest, in fact, that the generalization concerning the theme vowel in verbs like legō is not a phonological generalization at all, but rather is a morphological generalization idiosyncratic to this particular class of verbs. For example, it might be suggested that verbs like legō are not athematic at all, but rather that they have a theme vowel i specified by morpholexical rule, just as verbs like amō have the theme vowel ā specified by morpholexical rule (see below, section 2.2.1.). The theme vowel for legō would have to appear in a more limited context than the other theme vowels:

- (68)    a.        X ~ Xi  
           b.        X ~ Xi / \_\_\_ [+cons]

The morpholexical rule defining the class of verbs to which capiō belongs is illustrated in (68a): this simply states that a verb stem is related to another verb stem with theme vowel i. (68b) would have to be the morpholexical rule defining the class of verbs like legō: again, this states that a verb stem is related to another verb stem with theme vowel i but that the i stem only occurs before [+cons] segments. This latter sort of information, however, is information that we would not normally want to express in a morpholexical rule. All morpholexical rules needed for Latin are context free. We might therefore want to rule out the use of phonological contexts on morpholexical relations as in (68b) on general theoretical grounds.

Another alternative for stating the facts about legō verbs would be to build into the subcategorization frames for all vowel initial inflectional suffixes that they take the verb stem without the theme vowel only for verbs belonging to the legō class (i.e., they take the verb stem with theme vowel for amō, moneō, audiō, etc.):

$$(69) \quad -\bar{o} \quad / \quad \left\{ \begin{array}{l} ]_{\text{root}} \text{ --- (for } \underline{\text{leg}\bar{o}} \text{ verbs)} \\ ]_{\text{TV}} \text{ --- (elsewhere)} \end{array} \right.$$

Below, I will propose a way of stating that an affix attaches to a verb stem with theme vowel or to a verb stem without theme vowel. Even with the informal notation used above, it is obvious that stating the generalization about the theme vowel in legō verbs in the subcategorization frames of inflectional affixes leads to a great deal of complication in those subcategorization frames. We need to use disjunctive ordering of subcategorization frames, and we must also



mention the specific verb class in question in the subcategorization frame. In addition to building information about legō verbs into the subcategorization frames of -ō, we would have to build the same information into the frames for -unt, -ē (future), and -ēbā (imperfect). But nowhere would we state the generalization that it is only vowel initial affixes that have this property. In fact, under either of the morphological alternatives available to us within this theory, the mechanics of the morphology becomes hopelessly complicated in trying to state what seems to be a rather straightforward generalization: the theme vowel in legō verbs, whatever it is, appears before consonant initial suffixes and is absent before vowel initial suffixes.

Having ruled out a phonological epenthesis analysis and a morphological analysis, I would like to suggest that there is actually a fairly simple phonological explanation for the distribution of the theme vowel in legō verbs. Suppose that verbs like legō have a theme vowel which is present in all environments in morphological structure, e.g., leg<sup>\*</sup>V+ō, leg<sup>\*</sup>V+unt. This theme vowel is underlyingly distinct from the i of capiō, or any of the other theme vowels, for that matter. There exists in the phonology, however, a rule which deletes this theme vowel when it appears before vowels. At some point after this vowel deletion rule operates, V<sup>\*</sup> is converted to i where it is not deleted, thus merging with the theme vowel of capiō verbs. In order to specify the exact nature of these phonological rules, however, we must first determine what the proper features of V<sup>\*</sup> are.

A certain amount of evidence can be brought to bear on this question. As can be seen in the paradigms in (60), verbs like legō

pattern with verbs like capiō and audiō in two ways. First, all three verb classes take the -unt variant of the third person plural marker, whereas the verb classes including amō and moneō take a variant of this suffix with the shape -nt. Second, the amō and moneō classes form future stems with the affix bi,<sup>13</sup> whereas legō, capiō and audiō take the affix ē to form the future. Notice that the theme vowels for amō and moneō are both [-hi] vowels, whereas those for capiō and audiō are [+hi]. If we assume that the theme vowel  $\check{V}$  of legō verbs is also [+hi], then we can easily state the distribution of the third person plural and future affixes:

- (70) a.        -unt     /   [+hi]]<sub>TV</sub> —  
                  -nt       /   [-hi]]<sub>TV</sub> —
- b.        bi-       /   [-hi]]<sub>TV</sub> —  
                  -ē-       /   [+hi]]<sub>TV</sub> —

As in (69) above, TV is an informal notation for specifying that the affix attaches to the form of the verb stem with the theme vowel.

We have now seen some reason to believe that the theme vowel of legō is [+hi]. This vowel cannot, however, be either i or ī, since these vowels do not delete before vowel initial suffixes. At this point, I would like to make a somewhat speculative suggestion as to the rest of the feature composition of  $\check{V}$ , and to state the rules which delete it or merge it with i. Suppose that  $\check{V}$  is actually the glide y, i.e., a segment which is [+hi, -cons, -syl, -bk]. The theme marker y would delete before vowels, and become [+syl] elsewhere:

$$(71) \quad \begin{bmatrix} -\text{syl} \\ -\text{cons} \end{bmatrix} \rightarrow \begin{cases} \emptyset & / \text{C} \_ \text{V} \\ [+syl] & / \text{C} \_ \{ \text{C} \} \\ & \_ \# \end{cases}$$

Derivations for first person singular legō and second person singular legis are illustrated in (72):

(72)	legy+ō	legy+s	
	∅	--	
	--	i	
	legō	legis	

The glide deletion rule will delete theme marker y, leaving in tact the vowels of all the other verb classes. Where a glide remains, between consonants, it will be vocalized.

Notice that if we assume that the future marker bi actually has the underlying form by analogous to verbs like legy, we can account for the appearance and non-appearance of i before various P/N endings in the future paradigms. So (71) will produce amābunt, and amabō from amāby+unt, amāby+o, but amābis from amāby+s.

Rule (71) can be refined to account for another sort of alternation which seems to pervade both the verbal and the nominal paradigms. Consider the nominal paradigms below:

(73)	sg. N	stella	amīcus	turris	manus	prīnceps
	G	stellae	amīcī	turris	manūs	prīncipis
	D	stellae	amīcō	turrī	manuī	prīncipī
	A	stellam	amīcum	turrim	manum	prīncipem
	Ab	stellā	amīcō	turrī	manū	prīncipe

pl.	N	stellae	amīcī	turrīs	manūs	prīncipēs
	G	stellārum	amīcōrum	turrium	manuum	prīncipum
	D	stellīs	amīcīs	turribus	manibus	prīncipibus
	A	stellās	amīcōs	turrīs	manūs	prīncipēs
	Ab	stellīs	amīcīs	turribus	manibus	prīncipibus

We can first make a number of preliminary observations about the noun paradigms in (73). There seem to be two obvious super-classes into which Latin nouns fall: stella and amīcus use the genitive singular ī,<sup>14</sup> the nominative plural ī, the genitive plural -rum, and the dative and ablative plural -īs, whereas turrīs, manus and prīnceps have genitive singular -s, nominative plural -s, genitive plural -um, and dative and ablative plurals -ibus. Other endings appear across all five noun classes:

(74)	sg.	N	-s (masc)	pl.	N	-ī/-s
		G	-ī/-s		G	-rum (+length)/ -um
		D	-ī <sup>15</sup>		D	-īs/-ibus
		A	-m		A	-s (+length)
		Ab	(length)		Ab	-īs/-ibus

Latin nouns clearly have theme vowels in exactly the same way that Latin verbs do. The vowel a appears before most case endings in the paradigm of stella, as does i in turrīs, and u in manus. The theme vowel in amīcus and prīnceps will be the subject of the discussion immediately below. Some of the case endings, however, clearly attach to the noun stem without the theme vowel (i.e., to the root in the sense defined in section 1). Dative and ablative endings -īs/-ibus never appear with a preceding theme vowel, for example.

Once we have sorted out the nominal paradigms thus far, we cannot

fail to notice two things. First, some case forms of amīcus and prīnceps lack theme vowels where other forms show them: amīcī (Gsg, Npl) vs. stellae; prīncipī (Dsg), prīncipum (Gpl) vs. manuī, manuum. Note that all of the case forms in question are characterized by vowel initial suffixes -ī, -um. Before consonant initial case endings, (or in the Ablative singular, whose morphological manifestation is lengthening of the theme vowel) nouns in these classes do show theme vowels:<sup>16</sup> amīcus, amīcum, amīcōrum, amīcōs; prīncepis, prīncipem, prīncipēs, prīncipe. The second point that is obvious is that just the noun classes which lack theme vowels before vowel initial suffixes also show a great deal of variation in the character of their theme vowel. For amīcus, where the theme vowel does show up, it sometimes appears as o, and sometimes as u. For prīnceps, the theme vowel sometimes shows up as i, sometimes as e. Both of these observations can be explained by slightly extending the rules I have already postulated for deriving verbs like legō.

Suppose that the theme vowel for amīcus and nouns like it is the glide w (the high back glide), and the theme vowel for prīnceps and nouns like it is the glide y (theme vowel is obviously being used in an extended sense here, since w and y are not vowels). Rule (71), as it is stated above will delete this segment before vowel initial suffixes, and convert it to a vowel before a consonant or word finally. We must amend (71), however, to lower this vowel in certain environments. The paradigms in (73) indicate that the mid variant of the theme vowel in amīcus and prīnceps most often shows up in open syllables: amīcō, amīcōrum, prīncipe. The high variant most often shows up in closed

syllables: amīcus, amīcum, prīncipis. We might therefore alter (71) to simultaneously vocalize and lower the theme markers y and w in this environment:

(75)

$$\begin{bmatrix} -\text{syl} \\ -\text{cons} \end{bmatrix} \rightarrow \left\{ \begin{array}{l} \emptyset / \text{C\_V} \\ \left[ \begin{array}{l} +\text{syl} \\ \langle \text{ i } \rangle \end{array} \right] / \text{C\_} \langle \text{ CV } \rangle \end{array} \right\}$$

(76) illustrates some derivations:

(76)	amīcw+ <u>s</u>	amīcw+ <u>ī</u>	amīc <sup>w</sup> + <u>rum</u>	prīncipy+ <u>s</u>	prīncipy+ <u>um</u>	
	u	∅	ō	i	∅	(75)
	amīcus	amīcī	amīcōrum	prīncipis	prīncipum	

This analysis, of course, predicts that vowel lowering should be found in open syllables in the verb paradigms as well, and in fact it is: the infinitive legere, and the imperative singular lege regularly show the mid variant of the theme vowel, as do forms of the passive of legō, e.g., legeris.

This account of Latin phonology is at best speculative. Obviously, there are a number of problems in deriving the proper length on forms in the noun paradigms, given the inflectional endings in (74): the theme vowels in manūs and prīncipēs (Nom. Pl.) are long, whereas that in turris is short, and Abl.Sg. prīncipe has a short theme vowel, rather than a long one, as in all other ablative singulars. Worse than this, there are numerous forms in the noun and verb paradigms where a theme vowel in an open syllable remains high (legimus, legitis), and where a theme vowel in a closed syllable lowers (amīcōs, prīncipēs, prīncipem). I have no acceptable explanation for these forms; the best we could do

here is to introduce a rule feature triggering the lowering rule in forms where its environment is not met or suppressing this rule where its environment is met, but it fails to occur.<sup>17</sup>

I should point out, however, that although this analysis leaves a great deal to be explained, it is at least preferable in a number of ways to other analyses which have been suggested. Redenbarger's (1976) analysis has already been dealt with above. The only other possibility for analyzing this data that I am aware of was suggested to me by Morris Halle, and entails the following assumptions.<sup>18</sup> The mystery theme vowels in the nominal and verbal paradigms are ě and ǫ, rather than the glides y and w. Rather than a rule which deletes glides prevocally, and vocalizes them otherwise, lowering them as well word finally and in open syllables, we would have a rule like (77), which deletes ě and ǫ prevocally, and raises them in closed syllables:

$$(77) \quad \begin{bmatrix} -hi \\ -lo \\ -lg \\ -str \end{bmatrix} \longrightarrow \begin{cases} \emptyset / \text{---} V \\ [+hi] / \text{closed syllable} \end{cases}$$

We must assume that only unstressed ě and ǫ are subject to (77), since short stressed ě does not raise, e.g., infectum, acceptum, etc. This analysis would give derivations such as those in (78):

(78)	Nsg.	Gsg.	Apl.	Gsg.	Apl.	
	amīcō+s	amīcō+ī	amīcō+s	prīncipě+s	prīncipē+s	
	u	∅	---	i	---	(77)
	amīcus	amīcī	amīcōs	prīncipis	principēs	

Although this analysis consistently gives correct derivations in the

accusative plural for nouns with the mystery theme vowel, where the earlier analysis did not (i.e., my analysis predicted \*amīcūs, prīncipīs), there prove to be nearly the same number of intractable cases in this analysis, as in the earlier. For example, (77) gives us accusative singular \*prīncipim, rather than the correct prīncipem, and also fails to apply in the first and second person indicative plural verbs, giving us \*legemus, \*legetis, rather than legimus, legitis. Moreover, the raising rule in (77) cannot explain the vowel alternation in the infinitive, imperative sg. and passive forms of verbs like capīō (i.e., capere, cape, caperis, etc.) any better than the earlier analysis could (cf. fn. 17). In addition to requiring nearly as many ad hoc rule features for otherwise intractable examples like prīncipem and legitis, this solution also carries with it the following unattractive consequence. Since the neutralized theme vowels here are underlyingly mid rather than high, as in the earlier analysis, we no longer have a natural way of stating the subcategorization of the third person plural allomorphs -nt and -unt, and the future allomorphs -ē- and -bi (under this analysis underlyingly be). -nt and bi would have the subcategorization frame in (70a') and -unt and -ē- that in (70b'):

(70a')                     $\left. \begin{array}{l} -nt \\ -bi \end{array} \right\} / \left[ \begin{array}{l} -hi \\ +lg \end{array} \right] \text{ TV } \text{---}$

(70b')                     $\left. \begin{array}{l} -unt \\ -ē- \end{array} \right\} / \left\{ \begin{array}{l} [+hi] \\ [-lg] \end{array} \right\} \text{ TV } \text{---}$

(70b') must be stated as a disjunction of environments: these affixes attach either to theme vowel stems ending with a high vowel or to theme



vowel stems ending with a short vowel. Given the apparent state of affairs that neither of the two available analyses is far superior to the other with respect to the number of intractable cases, the fact that the subcategorization frames in (70') are much less natural than those in (70) provides at least a weak argument in favor of my earlier analysis. I will therefore accept that analysis in what remains of this chapter as the basis on which an analysis of the morphology of the Latin verb paradigms may be built.

## 2.2. Morphology of the Latin Verbs

Figure 1 illustrates a representative sample of the indicative verb paradigms in Latin.

INDIC. PRES.	amō amās amat amāmus amātis amant	crepō ↓	iuvō ↓
IMPF.	amābam amābās amābat amābāmus amābātis amābant	crepābam ↓	iuvābam ↓
FUT.	amābō amābis amābit amābimus amābitis amābunt	crepābō ↓	iuvābō ↓
PERF.	amāvī amāvistī amāvit amāvimus amāvistis amāvērunt	crepuī crepuistī crepuit crepuimus crepuistis crepuērunt	iūvī iūvistī iūvit iūvimus iūvistis iūvērunt
PLU- PERF.	amāveram amāverās amāverat amāverāmus amāverātis amāverant	crepueram crepuerās crepuerat crepuerāmus crepuerātis crepuerant	iūveram iūverās iūverat iūverāmus iūverātis iūverant
FUT.- PERF.	amāverō amāveris amāverit amāverimus amāveritis amāverint	crepuerō crepueris crepuerit crepuerimus crepueritis crepuerint	iūverō iūveris iūverit iūverimus iūveritis iūverint

FIGURE 1.

INDIC. PRES.	moneō monēs monet monēmus monētis monent	deleō ↓	augeō ↓	pendeō ↓	sedeo
IMPF.	monēbam monēbās monēbat monēbāmus monēbātis monēbant	delēbam ↓	augēbam ↓	pendēbam ↓	sedebam
FUT.	monēbō monēbis monēbit monēbimus monēbitis monēbunt	delēbō ↓	augēbō ↓	pendēbō ↓	sedebo
PERF.	monuī monuistī monuit monuimus monuistis monuērunt	delēvī delēvistī delēvit delēvimus delēvistis delēvērunt	auxī auxistī auxit auximus auxistis auxērunt	pependī pependistī pependit pependimus pependistis pependērunt	sēdī sēdistī sēdit sēdimus sēdistis sēdērunt
PLU- PERF.	monueram monuerās monuerat monuerāmus monuerātis monuerant	delēveram delēverās delēverat delēverāmus delēverātis delēverant	auxeram auxerās auxerat auxerāmus auxerātis auxerant	pependeram pependerās pependerat pependerāmus pependerātis pependerant	sēderam sēderās sēderat sēderāmus sēderātis sēderant
FUT.- PERF.	monuerō monueris monuerit monuerimus monueritis monuerint	delēverō delēveris delēverit delēverimus delēveritis delēverint	auxerō auxeris auxerit auxerimus auxeritis auxerint	pependerō pependeris pependerit pependerimus pependeritis pependerint	sēderō sēderis sēderit sēderimus sēderitis sēderint

FIGURE 1 (cont'd.)

INDIC.	alō	dicō	pedō	legō	agō
PRES.	alis alit alimus alitis alunt	↓	↓	↓	↓
IMPF.	alēbam alēbās alēbat alēbāmus alēbātis alēbant	dicēbam	pedēbam	legēbam	agēbam
		↓	↓	↓	↓
FUT.	alam alēs alēt alēmus alētis alent	dicam	pedam	legam	agam
		↓	↓	↓	↓
PERF.	aluī aluistī aluit aluimus aluistis aluērunt	dixī dixistī dixit diximus dixistis dixērunt	pepedī pepedistī pepedit pepedimus pepedistis pepedērunt	lēgī lēgistī lēgit lēgimus lēgistis lēgērunt	egī egistī egit egimus egistis egērunt
PLU- PERF.	alueram aluerās aluerat aluerāmus aluerātis aluerant	dixeram dixerās dixerat dixerāmus dixerātis dixerant	pepederam pepederās pepederat pepederāmus pepederātis pepederant	lēgeram lēgerās lēgerat lēgerāmus lēgerātis lēgerant	egeram egerās egerat egerāmus egerātis egerant
FUT.- PERF.	aluerō alueris aluerit aluerimus alueritis aluerint	dixerō dixeris dixerit dixerimus dixeritis dixerint	pepederō pepederis pepederit pepederimus pepederitis pepederint	lēgerō lēgeris lēgerit lēgerimus lēgeritis lēgerint	egerō egeris egerit egerimus egeritis egerint

FIGURE 1 (cont'd.)

INDIC. PRES.	cupiō cupis cupit cupimus cupitis cupiunt	speciō	fugiō
IMPF.	cupiēbam cupiēbās cupiēbat cupiēbāmus cupiēbātis cupiēbant	speciēbam	fugiēbam
FUT.	cupiam cupiēs cupiet cupiēmus cupiētis cupient	speciam	fugiam
PERF.	cupivī cupivistī cupivit cupivimus cupivistis cupivērunt	spexī spexistī spexit speximus spexistis spexērunt	fūgī fūgistī fūgit fūgimus fūgistis fūgērunt
PLU- PERF.	cupiveram cupiverās cupiverat cupiverāmus cupiverātis cupiverant	spexeram spexerās spexerat spexerāmus spexerātis spexerant	fūgeram fūgerās fūgerat fūgerāmus fūgerātis fūgerant
FUT.- PERF.	cupiverō cupiveris cupiverit cupiverimus cupiveritis cupiverint	spexerō spexeris spexerit spexerimus spexeritis spexerint	fūgerō fūgeris fūgerit fūgerimus fūgeritis fūgerint

FIGURE 1 (cont'd.)

INDIC. PRES.	capiō	audiō audīs audit audīmus audītis audiunt	amiciō ↓	sanciō ↓	veniō ↓
IMPF.	capiebam	audiēbam audiēbās audiēbat audiēbāmus audiēbātis audiēbant	amiciēbam ↓	sanciēbam ↓	veniēbam ↓
FUT.	capiam	audiam audiēs audiēt audiēmus audiētis audient	amiciam ↓	sanciam ↓	veniam ↓
PERF.	cepī cepistī cepit cepimus cepistis cepērunt	audīvī audīvistī audīvit audīvimus audīvistis audīvērunt	amicuī amicuistī amicuit amicuimus amicuistis amicuērunt	saxī saxistī saxit saximus saxistis saxērunt	vēnī vēnistī vēnit vēnimus vēnistis vēnērunt
PLU- PERF.	ceperam ceperās ceperat ceperāmus ceperātis ceperant	audīveram audīverās audīverat audīverāmus audīverātis audīverant	amicueram amicuerās amicuerat amicuerāmus amicuerātis amicuerant	sanxeram sanxerās sanxerat sanxerāmus sanxerātis sanxerant	vēneram vēnerās vēnerat vēnerāmus vēnerātis vēnerant
FUT.- PERF.	ceperō ceperis ceperit ceperimus ceperitis ceperint	audīverō audīveris audīverit audīverimus audīveritis audīverint	amicuerō amicueris amicuerit amicuerimus amicueritis amicuerint	sanxerō sanxeris sanxerit sanxerimus sanxeritis sanxerint	vēnerō vēneris vēnerit vēnerimus vēneritis vēnerint

FIGURE 1 (cont'd.)

The purpose of this section is to illustrate the mechanics of the morphological theory proposed above. I will present here a fragment of the permanent lexicon of Latin. This fragment, together with the theory of lexical structure worked out above should be substantial enough to generate the indicative paradigms of Latin illustrated in Figure 1. Later, in 2.3., it will be extended to the subjunctive and passive non-periphrastic paradigms as well. Latin verbs will be divided into a number of morpholexical classes on the basis of their idiosyncratic stem variants, and morpholexical rules will be proposed. I will argue that the Latin verb system does not consist of five monolithic conjugations, as traditional grammars assume, but instead that membership in classes forming theme vowel stems and past stems are largely independent: it is unpredictable from the theme vowel stem of a Latin verb which class the past of that verb will fall into. I will also give lexical entries for the various productive inflectional affixes of Latin, including the future, imperfect, and person/number endings. A system of binary valued features distinguishing various stem variants will be proposed. Such a system is crucial to the statement of subcategorization frames for both inflectional and derivational affixes. In fact, I will argue that the similarities between the lexical entries needed for inflectional affixes and those needed for derivational affixes suggests that it is correct to assume inflection and derivation to be in principle the same sort of word formation. Two points of theoretical interest will arise from this discussion of the permanent lexicon of Latin. First, the use of diacritic features to refer to cross-cutting groups of lexical terminals which is needed to state

subcategorization in Latin morphology suggests a way of expressing the extent of morphological productivity for a given affix: the notion of productivity to be developed here is slightly different from that used in Aronoff (1976) or Allen (1978). Second, constraints placed on our theory of morphology allow us to choose between two possible analyses of Latin prefix-stem verbs.

### 2.2.1. Morpholexical Classes

It should be quite obvious from looking at the verb paradigms in Figure 1 and from glancing through any Latin dictionary or grammar that the stem used in forming the non-perfect indicative verb forms is not predictable on any independent phonological or semantic grounds. It is purely arbitrary that the verb root am forms its present stem with the theme vowel ā, or that dico takes the theme vowel we have designated y. Given that the non-perfect stems (hereafter referred to as the theme vowel stems) are idiosyncratic to particular verb roots, they must be listed in the permanent lexicon along with the corresponding verb roots; (79) below contains the morpholexical rules needed for the five theme vowel classes in Latin, as well as examples of ordered pairs belonging to those classes.

- (79)
- a.  $X \sim X\bar{a}$   
 $\{(am, am\bar{a}), (crep, crep\bar{a}), (iuv, iuv\bar{a}), \dots\}$
  - b.  $X \sim X\bar{e}$   
 $\{(mon, mon\bar{e}), (del, del\bar{e}), (aug, aug\bar{e}), \dots\}$
  - c.  $X \sim Xy$   
 $\{(al, aly), (dic, dicy), (ped, pedy), \dots\}$
  - d.  $X \sim Xi$   
 $\{(cup, cupi), (spec, speci), (fug, fugi), \dots\}$



- e.  $X \sim X\bar{i}$   
 {(aud, audī), (amic, amicī), (sanc, sancī),...}

The morpholexical rules in (79a-e) indicate that a root is related to a stem which contains the root plus a theme vowel.

This much is perfectly straightforward. Everyone with some knowledge of Latin, however, knows that Latin verb forms often have more than one stem form: in many cases, the perfect tenses are built on a different stem than the non-perfect tenses (e.g., dicō ~ dixī). The form of this stem, and indeed that a separate stem exists at all is information which must be memorized, as every student who has wrestled with the principal parts of the Latin verbs knows. So iuuō, sedeō, legō, fugiō, and veniō form their perfect tenses on stems which consist of the verb root with a lengthened vowel (iūv, sēd, lēg, fūg, vēn), whereas augeō, dicō, conspiciō and sanciō have perfect stems consisting of root plus an s extension (aux, dix, conspix, sanx). pendeō, pedō and a number of other verbs have reduplicative perfect stems. Since this information is idiosyncratic to particular verbs, perfect stems must be listed and morpholexical rules formulated to define permissible classes.

It is in the formulating of perfect stem classes that my analysis begins to diverge from traditional grammars of Latin. Latin verbs are traditionally divided into five monolithic conjugations on the basis of their theme vowel stems. One would expect that each conjugation should have its particular way of forming a perfect stem different from other conjugations, as well as a characteristic way of forming the theme vowel stem. School grammars of Latin, however, always fail to note that the separate perfect stems, in whatever conjugation they are found, are of

only five types: idiosyncratic perfect stems are either sigmatic (i.e., consist of a root plus an s extension), reduplicative (pependī, sponpōndī), vowel length stems (iūv, vēn, etc.), vowel change stems (agō ~ egī), or stems identical to the verb root which directly take person/number endings. The vowel length type of perfect occurs across all five theme vowel classes, and the other four in more than one theme vowel class. There seems to be no correlation at all between the theme vowel taken by a particular root and the form of its perfect stem, if it has one. Rather, the various stems of a Latin verb seem, to a large extent, to be independent of one another. Theoretical parsimony therefore suggests that we do not divide Latin verbs into five monolithic conjugations. Here, I will assume no dependency between a root's membership in a theme vowel stem class and its membership in a perfect stem class; membership in one of the perfect stem forming classes is arbitrary, and in no way contingent upon membership in a theme vowel class.<sup>19</sup> (80) illustrates the perfect stem classes for Latin:

(80) a. Sigmatic  $X \sim Xs$

{(dic, dics), (aug, augs), (spec, specs), ...}

b. Vowel Length  $C_0 VC_0 \sim C_0 \begin{bmatrix} V \\ +lg \end{bmatrix} C_0$

{(iuv, iūv), (sed, sēd), (leg, lēg), ...}

c. Vowel Change  $C_0 VC_0 \sim C_0 \begin{bmatrix} V \\ -lo \\ -bk \end{bmatrix} C_0$

{(ag, eg), (cap, cep), (fac, fec), ...}

d. Reduplication  $C_0 CVC^2$

1 234 ~ 1 2  $\begin{bmatrix} 3 \\ -lo \\ -hi \end{bmatrix}$  2  $\begin{bmatrix} 3 \\ -ld \end{bmatrix}$  4

{(pend, pepend), (ped, peped), (spond, sponpōnd), ...}<sup>20</sup>

e. Perfect Stem = Root     $X \sim X$   
                                    $\{(ru, ru), (bib, bib), \dots\}$

(80) illustrates well the claim made above that morpholexical rules can mimic other sorts of productive word formation rules. The morpholexical rules in (79a-e) and (80a) mimic affixation in that the listed stems differ only in the presence of some segment at the periphery of one that is absent in the other. (80b-d) resemble string dependent morphological rules in that the righthand member of the ordered pair differs segmentally from the other member of the pair in some way that is dependent on the analysis of the first member of the pair. None of the morpholexical rules in (80) can be considered productive morphological rules, however, since it is arbitrary whether a given lexical item will "undergo" these rules. Instead, they define classes of listed stems.

The morpholexical classes illustrated in (79) and (80) capture a large part of the stem allomorphy in the Latin verb paradigms. However, certain revisions and refinements will certainly be necessary. For example, some verb roots (all belonging to the  $y$  theme vowel class) have extra stems exhibiting an infix  $n$ : again, the presence of a nasal infix stem is purely idiosyncratic to a given verb, i.e., unpredictable on any independent phonological, semantic or morphological grounds:

(81) lists the traditional principal parts of some of these verbs, i.e., the present, perfect and participle stems:

(81)	a.	fingō, finxī, fictus	'fashion'
		pingō, pinxī, pictus	'paint'
		stringō, strinxī, strictus	'bind'

b.	pangō, pepigī, pāctus	'fasten'
	tangō, tetigī, tāctus	'touch'
	fundō, fūdi, fūsus	'pour'

In (81a), the nasal infix stem is the basis of the present stem and the perfect stem, the stem without the nasal segment the basis of the participle form. In (81b) only the present stem has the nasal infix form. Clearly, the presence of a nasal infix is as arbitrary as the choice of a particular theme vowel for a given verb root, and indicates that two distinct stems must be listed for nasal infixing verbs. We might therefore elaborate the permanent lexicon of Latin in the following way: suppose there exists a morpholexical class such as that illustrated in (82):

$$(82) \quad C_0 VC_0 \sim C_0 VnC_0$$

{(fig, fing), (pig, ping), (pag, pang), (fud, fund), ...}

Either of the forms in the ordered pairs in (82) can belong, in turn, to the lexical classes delimited in (79) and (80). So the verb fundō will have a root and stem belonging to the nasal infix class in (82). The nasal stem will then belong, with a related theme vowel stem to class (79c), and the non-nasal stem with a vowel length stem to class (80b):

$$(83) \quad \text{Lexical stems of } \underline{\text{fundō}}:$$

Nasal Infix	$C_0 VC_0 \sim C_0 VnC_0$	(fud, fund)
Theme Vowel	$X \sim Xy$	(fund, fundy)
Vowel Length	$C_0 VC_0 \sim C_0 \overset{V}{+lg} C_0$	(fud, fūd)

Morpholexical rules (79), (80) and (82) therefore define a network of

relatedness among the unpredictable stem allomorphs of Latin verbs.

Of course, the theory being developed here predicts that any stem variant which is listed in the permanent lexicon should be available for further word formation. In general, this seems to be true:

(84) a. derivation on root:

am+or	'love'	(amō)
ag+men	'something moved'	(agō)
figūra	'form, shape'	(fingō)
pāgina	'written page or leaf'	(pangō)

b. derivation on theme vowel stem:

vitābundus	'avoiding'	(vitō)
certāmen	'contest'	(certō)

c. derivation on nasal infix stem:

figibilis	'imaginary seeming'	(fingō)
funditō	'hurl, sling at'	(fundō)

Roots, theme vowel stems, and stems with or without nasal infixes appear in derived nouns, adjectives and verbs. It is not clear, however, whether or not an idiosyncratic perfect stem can be the base for further derivation. (85) contains a number of possible examples.

- (85) sēdō 'cause to sit' from sedeō 'sit' whose perfect stem is sēd  
consēdō 'to wholly still' from considō 'sit down, settle', whose perfect stem is consēd.  
lēgō 'send as ambassador' from legō 'read out, elect', whose perfect stem is lēg.

Such examples, if indeed they are real examples of derivation from perfect stems, are rare. I have been unable to find derived words using

sigmatic, reduplicative or vowel change perfects as bases. If it proves to be the case that perfect stems in Latin do not undergo further derivation, this must be considered an accidental gap in the present framework, on the same order as the failure of past stems (sat, ran) in English to undergo further derivation.

### 2.2.2. Inflectional Affixes

So far, we have discussed only morpholexical stem variants in Latin. In order to show that all Latin verb paradigms can be generated with the simple machinery of our permanent lexicon and lexical structure subcomponents, we must now propose lexical entries for the tense, aspect and person/number morphemes from which those paradigms are built.

Lexical entries, as indicated in section 1.1.1., consist of phonological representation, semantic representation, category and subcategorization information, diacritics, and in general, of all information which is idiosyncratic to a particular lexical terminal.

(86) illustrates some of the information present in the lexical entries for Latin inflectional affixes:

#### (86) a. Person/Number Endings I

-ō, -m	+V	[1 pers, -pl, ∅ perf, ∅ pres, ∅ fut]	(1sg)
-s	+V	[2 pers, -pl, ∅ perf, ∅ pres, ∅ fut]	(2sg)
-t	+V	[3 pers, -pl, ∅ perf, ∅ pres, ∅ fut]	(3sg)
-mus	+V	[1 pers, +pl, ∅ perf, ∅ pres, ∅ fut]	(1pl)
-tis	+V	[2 pers, +pl, ∅ perf, ∅ pres, ∅ fut]	(2pl)
-nt/-unt	+V	[3 pers, +pl, ∅ perf, ∅ pres, ∅ fut]	(3pl)

## b. Person/Number Endings II

-ī	+V	[1 pers, -pl, ∅ perf, ∅ pres, ∅ fut]	(1sg)
-istī	+V	[2 pers, -pl, ∅ perf, ∅ pres, ∅ fut]	(2sg)
-it	+V	[3 pers, -pl, ∅ perf, ∅ pres, ∅ fut]	(3sg)
-imus	+V	[1 pers, +pl, ∅ perf, ∅ pres, ∅ fut]	(1pl)
-istis	+V	[2 pers, +pl, ∅ perf, ∅ pres, ∅ fut]	(2pl)
-ērunt	+V	[3 pers, +pl, ∅ perf, ∅ pres, ∅ fut]	(3pl)

## c. Other Inflectional Affixes

-ēbā	+V	[∅ pers, ∅pl, -perf, ∅pres, ∅fut]	imperfect
-by	+V	[∅ pers, ∅pl, ∅perf, ∅pres, +fut]	future
-ē	+V	[∅ pers, ∅pl, ∅perf, ∅pres, +fut]	future
-erā	+V	[∅ pers, ∅pl, ∅perf, -pres, ∅fut]	past
-eri	+V	[∅ pers, ∅pl, ∅perf, ∅pres, +fut]	future

Nothing particularly crucial to the workings of the morphology hinges on the choice of features here. In fact, it is at least plausible that features such as [+pres] or [+future] should be part of the semantic representation of these morphemes, rather than part of their syntactic feature matrices. Some representation of the aspect, tense, person, and number content of inflectional morphemes is necessary, however, and the lexical entries in (86) will suffice for now.

These lexical entries lack one crucial piece of information as they are formulated in (86), namely, the subcategorization of the inflectional affixes. At the grossest level of observation, all of the morphemes attach to verbs and form verbs, but subcategorization frames of the sort ]v—]v are clearly inadequate: such frames by themselves would imply that affixes in (86) could attach to verb stems and to each other in any order at all. The paradigms in Figure 1, of course, show that

inflectional affixes appear in a more or less rigid order, imperfect, future, or perfect occurring closest to the verb stem, past occurring to the right of the perfect, person/number endings at the rightmost periphery. Moreover, inflectional affixes characteristically choose to attach to only one of the listed stem forms: the imperfect ēbā attaches to the theme vowel stem, as do the future affixes by and ē. erā attaches to the perfects in y (cf. below) and to the idiosyncratic perfect stems already discussed. Indications are, then, that subcategorization frames for Latin verbs must be able to differentiate roots, theme vowel stems and perfect stems, and to refer to each of these separately.

Suppose that individual lexical stems in Latin have as part of their lexical entries a small number of diacritic features which allow us to make reference to particular stem types, regardless of the morphological class a given stem belongs to. Such a system of diacritic features is illustrated in (87):

(87)	$\begin{bmatrix} -T \\ +D \end{bmatrix}$	$\begin{bmatrix} +T \\ +D \end{bmatrix}$	$\begin{bmatrix} +T \\ -D \end{bmatrix}$
	am	amā	
	crep	crepā	
	iuv	iuvā	iūv
	mon	monē	
	aug	augē	augš
	al	aly	
	dic	dicy	dics
	cap	capī	cep
	aud	audī	

The features  $\begin{bmatrix} +T \\ +D \end{bmatrix}$ ,  $\begin{bmatrix} +T \\ -D \end{bmatrix}$  provide an arbitrary way of referring to roots, theme vowel stems and perfect stems independent of their lexical class membership. Any other set of features would do just as well. The use



of two binary valued features instead of, for example, simple designations like "theme vowel stem" or "perfect stem" does have some advantages, however. First, it predicts that some morpheme should subcategorize certain pairs from among the three possible stems, for example, the root and theme vowel stems, but not the root and perfect stems. We will see below that subcategorization frames of the predicted sort are needed for both inflectional and derivational affixes. Second, the use of these features can be extended slightly to allow us to refer to affixes themselves. Clearly, some inflectional affixes will need to subcategorize a subset of the other inflectional affixes, as well as one or another of the stems, although no inflectional affix has a "theme vowel stem" or a "perfect stem". So, for example, the P/N I affixes attach either to theme vowel stems, or to affixes like ēbā, by, ē, etc. If theme vowel stems and the relevant inflectional affixes share the feature [+T], the subcategorization frame of the P/N I affixes can be somewhat simplified.

Given the system of diacritic features proposed here, the subcategorization frames for Latin inflectional affixes relevant to the indicative paradigms are quite straightforward:

(88)	a.	ēbā	(IMPERFECT)	/	]+T___] +T +D
		by	(FUTURE)	/	[-hi]] +T___] +T +D
		ē	(FUTURE)	/	[+hi]] +T___] +T +D
		erā	(PAST)	/	]+T___] +T -D
		eri	(FUTURE)	/	]+T___] +T -D

b. P/N I

$$\left. \begin{array}{l} -\bar{o}/-m \\ -s \\ -t \end{array} \right\} \begin{array}{l} -mus \\ -tis \\ -nt/-unt \end{array} / \quad ] \begin{array}{l} +T \\ (+D) \end{array} \text{---} ]_V$$

c. P/N II

$$\left. \begin{array}{l} -\bar{i} \\ -ist\bar{i} \\ -it \end{array} \right\} \begin{array}{l} -imus \\ -istis \\ -\bar{e}runt \end{array} / \quad ] \begin{array}{l} +T \\ -D \end{array} \text{---} ]_V$$

A number of comments about the subcategorization frames in (88) are relevant at this point. First, the three morphemes labeled FUTURE are distinguished as follows: by attaches only to theme vowel stems with non-high theme vowels, i.e., those belonging to the ā and ē classes, ē to theme vowel stems with high vowels, i.e., to stems of the i, y and ī classes. eri attaches only to [-D] morphemes, namely the perfect stems. The P/N I endings in (88b) attach to theme vowel stems or to the inflectional affixes in (88a). However, a certain amount of complication is needed to state the difference in subcategorization between the first person singular morphemes -ō and -m. In general, -ō attaches to morphemes ending in high vowels, -m to morphemes ending in non-high vowels. -ō however, attaches to all  $\left[ \begin{array}{l} +T \\ +D \end{array} \right]$  stems, regardless of the quality of the theme vowel. The only way of stating these facts seems to be by using angle notation and conditions within subcategorization frames:

(89)  $-\bar{o} / \left\langle \begin{array}{l} [+hi] \\ \end{array} \right\rangle_b ] \left\langle \begin{array}{l} +T \\ +D \end{array} \right\rangle_a \text{---}$

Condition:  $\sim a \rightarrow b$

$-m / \left[ \begin{array}{l} -hi \end{array} \right]_{+T} \text{---}$

Since this solution makes use of highly powerful devices it is not particularly attractive. Until a better statement of the distribution of these morphemes is available, however, I will use (89) to state the facts. As mentioned in 2.1., the distinction between the third person singular morphemes -unt and -nt hinges on vowel height again:

- (90)
- |      |   |        |    |    |
|------|---|--------|----|----|
| -unt | / | [+hi]] | +T | __ |
|      |   |        | +D |    |
| -nt  | / | [-hi]] | +T | __ |
|      |   |        | +D |    |

The P/N II endings attach to perfect stems.

One characteristic of this subcategorization system that is significant is that person/number endings do not themselves bear the diacritic features [+T] or [+D]. This ensures that P/N endings are always the outermost inflections in a word. Since all of the affixes in (88) subcategorize morphemes with some value of the features [+T] and [+D], they are prevented on internal grounds from occurring outside P/N endings. The fact that P/N endings are always outermost required a special lexical structure rule within Selkirk's (1978) system of morphology (cf. (14) above). Within the morphological framework being developed here, no peculiarities must be ascribed to the lexical structure component in order to generate inflectional affixes in the proper order.

Before I go on to discuss the perfect morpheme v, which I have not yet mentioned, I will only point out one more property of these subcategorization frames. That is, although the subcategorization frames ensure that the inflectional affixes will occur in the correct

order when they occur, nothing ensures that any of the affixes will occur at all. Thus, nothing requires that a P/N ending be inserted into a tree into which the  $\begin{bmatrix} +T \\ +D \end{bmatrix}$  stem amā has been inserted, nor that anything will be attached to a root mon which has been inserted into a tree. The morphology of Latin proposed here thus has the property that it overgenerates, i.e., generates forms which are in some sense morphologically incomplete. This characteristic is not necessarily a problem, however. Any reasonable account of the syntax of Latin will require some sort of agreement mechanism to check that subject and verb have the same features of person and number. Whatever mechanism is used (e.g., an agreement filter (Rivas (1977))), this mechanism will surely rule out sentences in which the verb lacks a P/N marker: that is, if a P/N marker is missing from a verb, agreement criteria will fail to be met, and the sentence in which such a form occurs will be marked ungrammatical.

The only inflectional affix needed for generating the indicative paradigms of Latin which we have not yet discussed is the perfect morpheme v. According to traditional grammars of Latin, verbs which do not have idiosyncratic sigmatic, reduplicative, or other perfect stems form a "regular" perfect by adding a morpheme which sometimes has the shape v and sometimes has the shape u. This implies that the v morpheme is predictable in a way that the other perfect stems are not. It is not at all clear, however, that v is an affix with an independent lexical entry like by or ēbā. Consider the first person singular perfect forms in (91):

(91)	amāvī	(amāre)	153
	crepuī	(crepāre)	
	delēvī	(delēre)	
	monuī	(monēre)	
	aluī	(alere)	
	cupivī	(cupere)	
	audīvī	(audīre)	
	amicuī	(amicīre)	

The first thing which appears in examining these forms is that u and v are in complementary distribution. v occurs intervocalically, u after a consonant. We can therefore say that the underlying form of the morpheme is v and that u is derived by the phonological rule in (92):

(92) [-cons] → [+syl] / [+cons] \_\_

((92) assumes that the morpheme spelled v is phonetically the glide w, and u the corresponding vowel.) Notice that this generalization is independent of the morphological analysis we choose for the v morpheme: the phonological rule in (92) will operate on underlying strings like monv or crepv, regardless of whether these stems are listed, or formed by concatenation in the lexical structure component.

What is crucial about the examples in (91), however, is that it is not predictable on the basis of phonological form, theme vowel class or anything else, whether the regular past morpheme will attach to the root or to the theme vowel stem of a given verb. (91) shows verbs from all five theme vowel classes. Three of the five have v perfects based on both the root (crepuī ~ crep; monuī ~ mon; amicuī ~ amic), and on the theme vowel stem (amāvī ~ amā; delēvī ~ delē; audīvī ~ audī)<sup>21</sup> (the y and i theme vowel classes have few v perfects). It would seem that the only way to state the subcategorization of an independent

v morpheme, given these facts, would be to mark either the root or theme vowel stem of particular verbs which lack other perfect stems with yet another diacritic feature; v would then have the subcategorization frame in (93), where [+P] is the special feature for 'regular' perfects:

$$(93) \quad v / ]_{+P} \text{ --- } ]_{-D}$$

The fact that we must introduce a feature like [+P], however suggests that v is not an affix like by or ēbā, but instead that past stems with v are listed, just as sigmatic, reduplicative, vowel change and vowel length perfect stems are listed. This is the analysis which will be accepted here. Latin therefore has another perfect ( $\left[ \begin{smallmatrix} +T \\ -D \end{smallmatrix} \right]$ ) stem class, which is represented in (94):

$$(94) \quad X \sim Xv \\ \{ (amā, amāv), (delē, delēv), (mon, monv), (al, alv), \dots \}$$

Either the root or the theme vowel stem can be related to the perfect stem by the morpholexical rule in (94):

The same sort of case can be made for the necessity of listing the participle stems in Latin. Whereas superficially it might seem that participles can be formed by affixing an independently listed t morpheme to one of the other stems, it again proves to be impossible to predict which stem t will attach to. Consider the forms in (95):

(95)	a.	amātus	(amāre)
		delētus	(delēre)
		audītus	(audīre)
		peditus	(pedere)
		ponitus	(ponere)

b.	sectus	(secāre)
	auctus	(augēre)
	lectus	(legere)
	captus	(capere)
	ventus	(venīre)

Examples in (95a) have t attached to the theme vowel stem. Those in (95b) have t attached directly to the root. Both classes are found for verbs belonging to each of the five theme vowel classes. Consider further the examples in (96):

(96)	haesus	(haerēre)
	iussus	(iubēre)
	mulsus	(mulgēre)
	mansus	(manēre)
	pressus	(premere)
	cessus	(cedere)
	sessus	(sedēre)

The participles lack the t affix entirely, and it is clear that there can be no phonological alternation between t and s in these forms to account for the surface absence of t. We find a participle cursus, but we also find rt as an acceptable cluster in another participle reper tus. Similarly, fallō has the participle falsus, but lt occurs in indultus, the participle of indulgeō. Other near minimal pairs are haesus, participle of haereō, vs. haustus, participle of hauriō, and mansus, participle of maneō vs. ventus participle of veniō. Many of the verbs whose participles fall into the class illustrated in (96) also have sigmatic perfects (e.g., haesi, iussi, mulsi), but others do not:

(97)	sedeō	sēdī	sessus
	pellō	pepulī	pulsus

Again, to maintain the claim that t is an independent affix, we would have to mark roots or theme vowel stems with a diacritic which t would be subcategorized to take. Nor could this diacritic be the same one as that needed for the v morpheme, were we to try to maintain that both were independent affixes: v and t choose different stems in ēmicō, ēmicuī, ēmicātus. And besides this new diacritic, we would still have to find some way of representing the idiosyncratic participle stems in (96).

Again, the alternative to proliferating ad hoc diacritics is to list the participle stem of each verb. This move will prove to have interesting consequences, as we will see below.

Suppose that Latin has two morpholexical classes for participle stems, as illustrated in (98):

- (98) a.  $X \sim Xt$   
 { (amā, amāt), (audī, audīt), (sec, sect), (aug, augt), ... }
- b.  $X \sim Xs$   
 { (haer, haes), (mulg, muls), (sed, sess), ... }

Again, either the root or the theme vowel stem is related to the participle stem by the morpholexical rules in (98). Participle stems in general can be designated with the feature matrix  $\begin{bmatrix} -T \\ -D \end{bmatrix}$ : this is the last possible combination of the two features we began with.

Of course, the listing of the participial stem brings with it the prediction that this stem is available for further word formation. This, in fact, proves to be the case:



(99)	cantor	'singer'	canere	pple.	cantus
	victor	'conqueror'	vincere	pple.	victus
	tonsor	'barber'	tondere	pple.	tonsus
	petitor	'candidate'	petere	pple.	petitus

The Latin agentive affix -or attaches regularly to the participle stem.

The use of the feature  $\begin{bmatrix} -T \\ -D \end{bmatrix}$  to designate this class of stems makes a further prediction about word formation possibilities in Latin as well. The participle stem shares with the root in Latin the feature [-T]. This predicts that there might be some word formation process which refers to these two sorts of stems but not the other two, for example, an affix which subcategorizes all and only [-T] stems. Such examples are not hard to find.

(100) a. -iō

legiō	'a collecting'	legere	root	leg
regiō	'a direction'	regere	root	reg
vocātiō	'a calling'	vocāre	pple	vocātus
mōlītiō	'a toiling'	mōlīri	pple	mōlītus

b. -īvus

recidīvus	'restored'	recidere	root	recid
captīvus	'captive'	capere	pple	captus

c. -ilis

agilis	'active'	agere	root	ag
habilis	'handy'	habēre	root	hab
altilis	'fattened'	alere	pple	altus

Allen and Greenough (1975) list these three affixes as having two allomorphs, one with t, and one without. All three attach to verb

stems, however, and when the t appears, it always appears on verbs with participle stems in t. Clearly, our morphology is simplified by saying that the affixes have only a single form -- -iō, -īvus, and -ilis, respectively, and that they are subcategorized to attach to [-T] stems. These examples therefore provide striking confirmation of the prediction made above.

Implicit in the discussion of -iō, -īvus, and -ilis above is the claim that derivational affixation shares an important property with inflectional affixation in Latin, namely that derivational affixes must refer to the diacritic features [+T, +D] in their subcategorization frames in exactly the same way that inflectional affixes do. Consider the examples in (101):

(101)	a.	<u>-or</u>		
		timor	'fear'	timēre
		amor	'love'	amāre
	b.	<u>-āx</u>		
		pūgnāx	'pugnacious'	pūgnāre
		audāx	'bold'	audēre
	c.	<u>-men</u>		
		agmen	'line of march'	agere
		regimen	'rule'	regere
		certāmen	'contest'	certāre

The abstract noun forming suffix -or (to be distinguished from the agentive suffix -or) attaches only to verb roots, i.e., to  $\begin{bmatrix} -T \\ +D \end{bmatrix}$  forms. -āx, an abstract adjective forming suffix, attaches

exclusively to roots as well. -men forms abstract nouns from verbs, but it attaches to either roots or theme vowel stems -- i.e., to [+D] forms. Note that this is another example where the cross-classifying system of diacritic features predicts patterns of word formation which actually do exist. (102) summarizes the subcategorization information for the derivational affixes mentioned so far.

(102)	-or (agentive)	]-T ___]N -D
	-or (abstract)	]-T ___]N +D
	-iō	]_T ___]N
	-men	]_+D ___]N
	-īvus	]_T ___]A
	-ilis	]_T ___]A
	-āx	]_T ___]A +D

The fact that derivational affixes require precisely the same machinery for stating their subcategorization restrictions as inflectional affixes do actually provides strong evidence that the two sorts of word formation are not distinct processes. It is not a priori necessary that this should be the case. In fact, if inflection and derivation were different types of word formation as has been argued both in traditional grammars and in generative grammar, we would expect them to make use of very different sorts of mechanisms; the convergence of subcategorization properties that we do find in Latin would remain accidental. Within the theory of morphology being developed here,

however, such convergence is expected.

The fragment of the permanent lexicon I have elaborated above, together with the general lexical structure component developed in section 1. is sufficient to generate all of the indicative verb paradigms in Figure 1, as well as some of the derived nouns and adjectives of Latin. To summarize this section, I have included a number of derivations below. Although not shown here, aspect, tense, and person/number information percolate as usual along with the category and diacritic features I have illustrated here.

(103) PRESENT

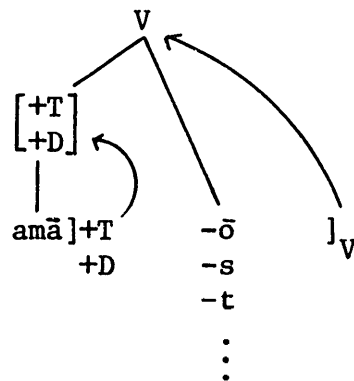

IMPERFECT

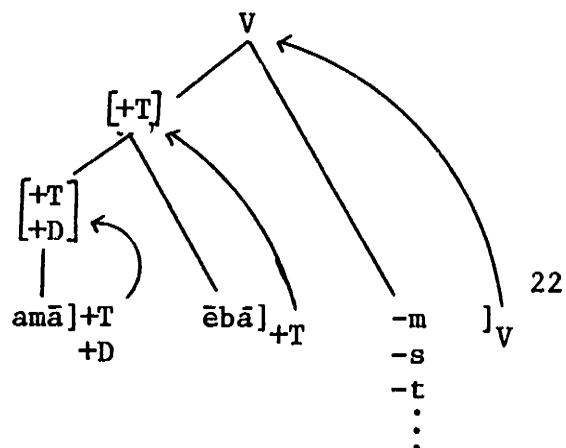

FUTURE

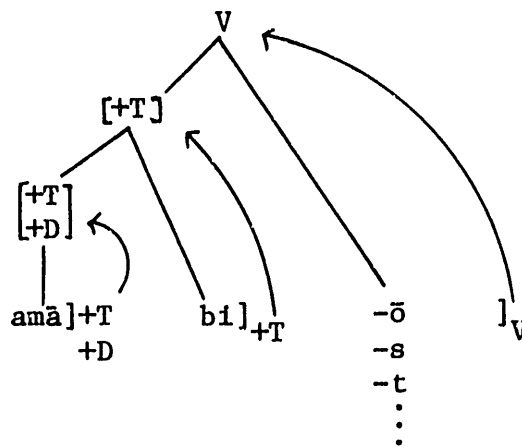

PERFECT

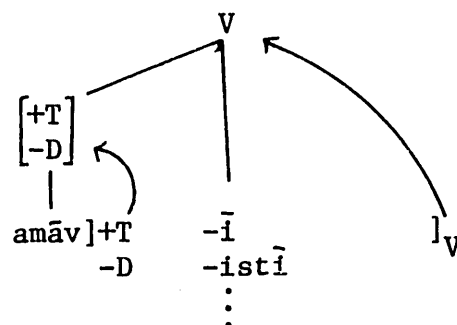

PLUPERFECT

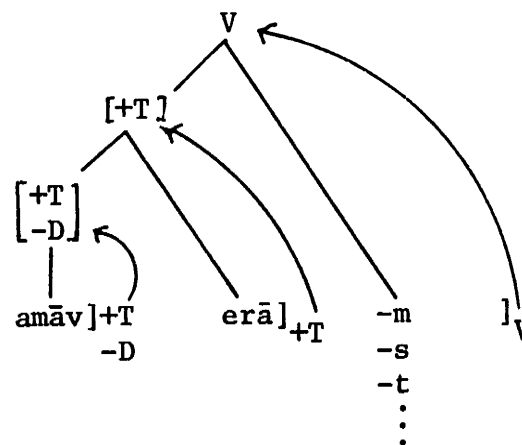

FUTURE PERFECT

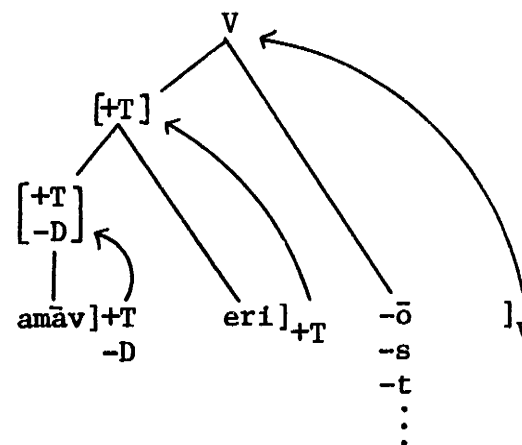

(104)

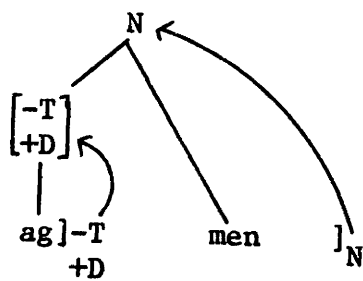
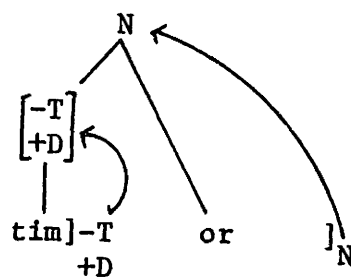
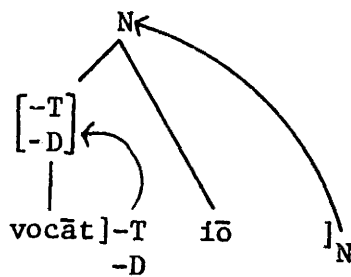
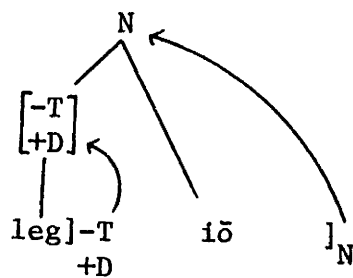
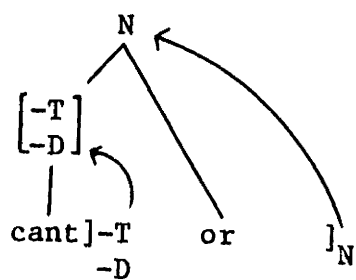

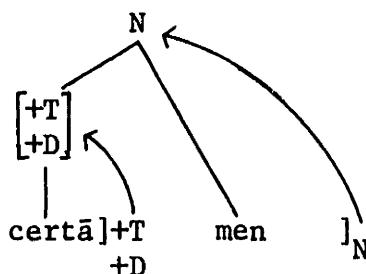

### 2.3. More Latin Paradigms

The analysis proposed above for the indicative paradigms of Latin can easily be extended to cover the rest of the non-periphrastic paradigms of Latin. For the sake of thoroughness, I will do this here, before going on to discuss the Latin prefix verbs and the question of morphological productivity. Figure 2 contains the subjunctive forms of the Latin verbs, and Figure 3 the non-periphrastic passive forms:

FIGURE 2

#### SUBJ

Pres:	amem	moneam	tegam	capiam	audiam
	amēs	moneās	tegās	capiās	audiās
	amet	moneat	tegat	capiat	audiat
	amēmus	moneāmus	tegāmus	capiāmus	audiāmus
	amētis	moneātis	tegātis	capiātis	audiātis
	ament	moneant	tegant	capiant	audiant
Impf:	amārem	monērem	tegerem	caperem	audīrem
	amārēs	monērēs	tegerēs	caperēs	audīrēs
	amāret	monēret	tegeret	caperet	audīret
	amārēmus	monērēmus	tegerēmus	caperēmus	audīrēmus
	amārētis	monērētis	tegerētis	caperētis	audīrētis
	amārent	monērent	tegerent	caperent	audīrent
Perf:	amāverim	monuerim	tēxerim	cēperim	audīverim
	amāveris	monueris	tēxeris	cēperis	audīveris
	amāverit	monuerit	tēxerit	cēperit	audīverit
	amāverimus	monuerimus	tēxerimus	cēperimus	audīverimus
	amāveritis	monueritis	tēxeritis	cēperitis	audīveritis
	amāverint	monuerint	tēxerint	cēperint	audīverint
Plupf:	amāvissem	monuissem	tēxissem	cēpissim	audīvissem
	amāvissēs	monuissēs	tēxissēs	cēpissēs	audīvissēs
	amāvisset	monuisset	tēxisset	cēpisset	audīvisset
	amāvissēmus	monuissēmus	tēxissēmus	cēpissēmus	audīvissēmus
	amāvissētis	monuissētis	tēxissētis	cēpissētis	audīvissētis
	amāvissent	monuissent	tēxissent	cēpissent	audīvissent





The subjunctive present affixes  $-\bar{e}$  and  $-\bar{a}$  are in complementary distribution,  $\bar{e}$  attaching to theme vowel stems with theme vowel  $\bar{a}$  and  $\bar{a}$  attaching to theme vowel stems elsewhere. This analysis presupposes a phonological deletion rule (106), deleting theme vowel  $\bar{a}$  before subjunctive  $\bar{e}$ :

$$(106) \quad \bar{a} \longrightarrow \emptyset / \text{---} \begin{bmatrix} +\text{syl} \\ -\text{h1} \\ -\text{1o} \\ +\text{1g} \end{bmatrix}$$

This rule, in fact, is meant to collapse the deletion of  $\bar{a}$  before subjunctive  $\bar{e}$  and also the deletion of theme vowel  $\bar{a}$  before first person singular  $\bar{o}$  discussed in section 2.1. Subjunctive imperfect re attaches to theme vowel stems, and the subjunctive perfect and past affixes eri and isse attach to perfect stems, i.e., those with the feature array  $\begin{bmatrix} +\text{T} \\ -\text{D} \end{bmatrix}$ . All subjunctive affixes form [+T] constituents, which means that the P/N I endings in (88b) attach to them.

For the passive paradigms in Figure 3, we need only add to our inventory of affixes a third set of P/N endings:

(107) P/N III (Passive)

$$\begin{array}{l} \text{Sing. 1} \\ \text{Pl. 1} \\ \text{Pl. 2} \end{array} \left\{ \begin{array}{l} -\text{or} \\ -\text{r} \\ -\text{ris} \\ -\text{tur} \\ -\text{mur} \\ -\text{min}\bar{i} \end{array} \right\} / \begin{array}{l} \langle [-\text{syl}] \rangle_{\text{b}} \begin{bmatrix} +\text{T} \\ +\text{D} \end{bmatrix}_{\text{a}} \text{---} \\ \text{---} \\ \text{---} \\ \text{---} \\ \text{---} \\ \text{---} \end{array} \quad \text{Condition: } \sim \text{a} \longrightarrow \text{b}$$



## 2.4. Latin Prefix Verbs

The system of lexical structure developed in this chapter and the fragment of the Latin permanent lexicon proposed in 2.2. and 2.3. provide a skeleton on which to build a more refined analysis of the Latin verbal system. So far, I have discussed only the paradigms of underived verbs in Latin, i.e., verbs whose  $\begin{bmatrix} \alpha T \\ \beta D \end{bmatrix}$  stems are unanalyzable morphemes. Latin, however, also possesses an extensive system of derived verbs consisting of prefixes like e, ad, re, de, in, prae, ab, etc. and otherwise freely occurring verb stems. Examples of such verbs are listed in (109):

(109)	ablegō	circumagō	extrahō	pereō
	abrogō	circumeō	inveniō	praeēō
	abstrahō	cohaeriō	ineō	praeiaceō
	accurrō <sup>24</sup>	concedō	interveniō	subeō
	adhaereō	deamō	interiaceō	subiaceō
	adiaceō	dēcēdō	obiaceō	subiaciō
	antecapiō	distrahō	obeō	superiaciō
	antecedō	disparō	peragō	transeō

Prefix verbs such as these will prove to be of some theoretical interest in light of some recent work on Russian prefix verbs by Pesetsky (1979).

First, however, it is necessary to provide some argument that prefixing is a productive morphological process in Latin. It is at least conceivable that all of the prefix verbs in (109) and others like them have their own lexical entries, and that they really lack any sort of internal structure. Perhaps the most compelling argument that this is not the case, however, is that prefixed verb stems by and large belong to the same morpholexical classes as their corresponding

unprefixed stem forms. Whatever stem classes a given verb belongs to for forming its theme vowel stem, perfect stem and participle stem, the verb plus any prefix will belong to the same classes:

(110) amō, amāre, amavī, amātum	deamō, deamāre, deamavī, deamātum
audiō, audīre, audivī, audītum	exaudiō, exaudīre, exaudivī, exaudītum
scribō, scribere, scripsī, scriptum	praescribō, praescribere, praescripsī, praescriptum
teneō, tenēre, tenuī, tentum	obtineō, obtinere, obtinuī, obtentum

The alternative to having prefixing as a productive morphological process would be to list each prefix verb separately. amō and deamō, faciō, conficiō, and efficiō would each have a separate lexical entry, and would be unrelated by any word formation process. But if each of these verbs were listed separately, it would be an accidental fact that the array of stem forms for any given verb and its corresponding prefixed forms largely are identical: we would expect to find arbitrary variations in these stem forms. If ab, ad, ex, de, etc., are prefixes, however, and verb stems have only a single lexical entry with a single array of verb stems, we would predict the facts illustrated in (110). There would be no possibility of generating prefix verbs with different stems from their non-prefix forms.

If Latin prefix verbs are put together in the lexical structure subcomponent, we must determine what the internal structure of those verbs is. A number of a priori logical possibilities are illustrated in (111):

(111) a.

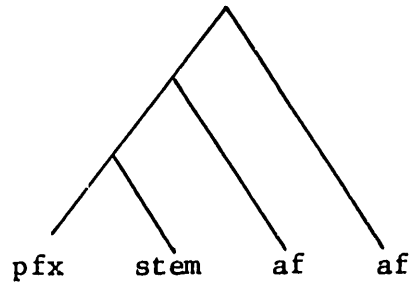

b.

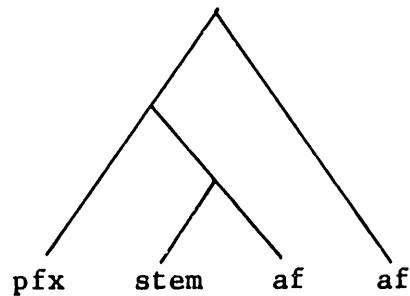

c.

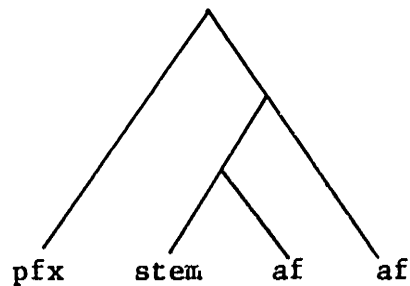

One reason that this question is especially interesting is the following. Russian has a large number of verbs which are like those in (109) in that they consist of productively attached prefixes and stems. Pesetsky (1979) has argued, on the basis of phonological evidence in Russian that the internal structure of prefix verbs in Russian must be that in (111c): [pfx [[[stem] af] af]]. If prefixes are affixed to the outside of verb stems to which inflectional affixes have already been attached, the phonological rules of Yer-Lowering and Yer-Deletion will apply to give the proper surface forms (cf. Pesetsky 1979). I

will argue here that this structure certainly cannot be the correct one for Latin prefix verbs. In Latin, these verbs must have the structure in (111a); the prefix must be attached most closely to the verb stem, and inflections added only to the outside of the prefix-stem constituent. In order to make this argument, we must consider a particular subclass of prefix verbs in Latin, those in which the stem vowel in prefixed forms is different from the stem vowel in non-prefixed forms.

Although in the majority of prefixed verbs, the verb stem in the prefixed and non-prefixed forms is identical, this is not always the case. Consider the forms in (112):

- (112) a. arō            exarō, inarō, perarō, subarō  
          amō            deamō, redamō  
          natō            adnatō, ěnatō, innatō, praenatō
- b. faciō          adficiō, conficiō, deficiō, efficiō, inficiō  
          teneō          contineō, dētineō, distineō, obtineō  
          scandō        ascendō, conscendō, dēscendō, ēscendō

Verbs formed by a prefix plus arō, amō, or natō always maintain the stem vowel a. Prefix verbs on faciō, teneō, scandō and a number of other verbs (e.g., agō, rapiō, caedō, cadō, capiō, laedō, sedeō,...) consistently show raising of the stem vowel in the prefixed forms. It is not predictable on any independent grounds, however, either which verbs will show stem vowel raising in prefixed forms or what vowel the stem vowel will be raised to, if it is raised. faciō has the stem vowel i in prefixed forms (conficiō, inficiō), scandō the stem vowel e (ascendō, conscendō). Verbs with the stem vowel e in non-prefixed



If both the raised stem and the non-raised stems are represented in the permanent lexicon, we must somehow also represent the information that the raised stem occurs only in prefixed forms, and cannot be a freely occurring form: \*ficiō, \*scendō. This information must be represented regardless of the internal structure we ascribe to prefix verbs. We will see that the choice of internal structure for prefix verbs makes a great deal of difference in the way we state this information: if we choose structure (111a), the distribution of raised stems can be stated straightforwardly, but if (111c) is chosen, no such straightforward solution is available.

Suppose that prefix verbs in Latin have the internal structure of (111a). The verbs derived from faciō would have the structure in (114):

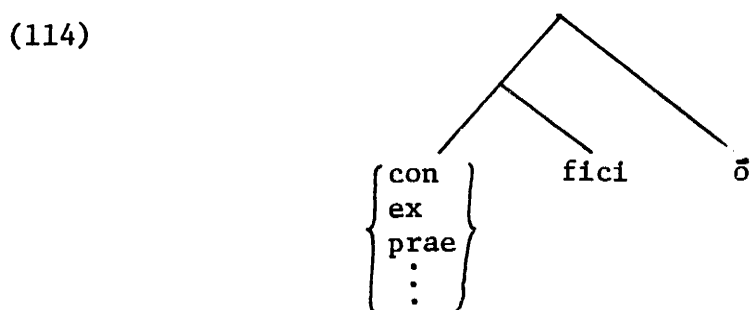

If this is the internal structure of conficiō, etc., we can say that the raised stem fic differs from its freely occurring counterpart fac in having a subcategorization frame, which is illustrated in (115):

(115)                    fic / [X [ \_\_\_\_

That is, fic and other raised stems will have subcategorization frames that state that they can only be inserted into a tree with a non-null left constituent, i.e., a prefix. The variable X is used to represent



the fact that any such left constituent will do: fic and raised stems are thus represented as bound morphemes corresponding to the non-raised free morphemes.

Notice that we have no trouble in getting inflectional affixes to attach properly to our prefix-stem constituent given the feature percolation mechanisms already developed in this chapter. Since the verbal prefixes con, ad, ex, etc. have no specifications of their own for the features  $\begin{bmatrix} \alpha T \\ \beta D \end{bmatrix}$ , these features will automatically percolate to the branching node dominating the prefix and stem:

(116)

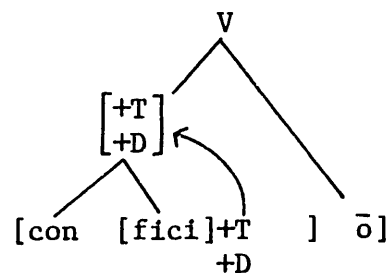

The  $\begin{bmatrix} +T \\ +D \end{bmatrix}$  specification will be available for the P/N endings, and their subcategorization will therefore be satisfied. The derivation of Latin prefix verbs thus goes smoothly if we choose structure (111a).

Consider what we would have to do to derive these verbs with structure (111c), the structure Pesetsky has advocated for Russian prefix verbs. Some relevant forms are shown in (117):

(117) a.

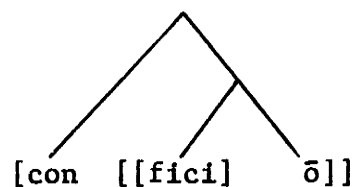

b.

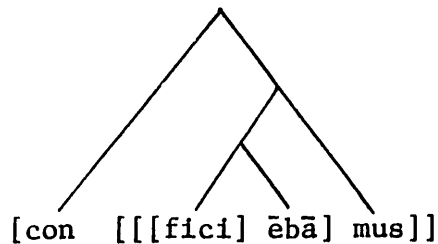

Inflectional tense, aspect, and P/N endings attach directly to the stem, and the prefix attaches to the already inflected constituent. Given these structures, we still have to state the fact that fic is not a freely occurring morpheme. However, the stem and prefix, since they are no longer bound to each other, are separated by an unpredictable number of brackets, two in (117a) and three in (117b). The number of intervening brackets depends on the depth of inflection of the verb. I know of no way of writing this fact into a subcategorization frame for fic and other raised stems. In fact, to write even two brackets into a subcategorization frame -- i.e., fic / [X [[ \_\_ -- would be a violation of the Adjacency Condition, which I argued in section 1 was a condition on subcategorization frames. Such a condition would automatically rule out this frame.

The result we are left with here is that only one of the logically possible structures for Latin prefix verbs allows us to derive the prefix verbs with raised stems. If we are to state the subcategorization on raised stems, prefixes must attach directly to stems before inflectional affixes are added. The framework developed here thus highly constrains the number of possible analyses for this set of facts in Latin.

### 3. Morphological Productivity

The question of how relative morphological productivity is to be expressed in a grammar is a complex one, and one that has been much discussed in the current literature. It is also an issue that has become entangled with another issue, that of how our lexicon is to distinguish possible well-formed words from actual well-formed words: our way of computing productivity must differ depending on whether we are judging productivity within a set of actual words or productivity within all possible words. In this section, I would like, first, to disentangle these two issues, to argue that a lexicon need only provide for the generation of possible words (i.e., need have no independent representation of actual words), and given this conclusion, that our theory of word formation already provides us with an index of productivity.

Morphological frameworks such as Halle (1973), Aronoff (1976), and Allen (1978) to a large extent agree that although the main function of a morphology is to enumerate all and only possible words, the lexicon must also contain a list or dictionary containing all of the actually occurring words of the language. Aronoff's version entails that word formation rules apply to form new words. New words are listed in a speaker's "actual word list", and can be analyzed by the same rules which generated them to begin with:

One important peculiarity of the conception of the rules of word formation I am outlining is that I do not view these rules as applying every time the speaker of a language speaks. They are rules for making up new words which may be added to the speaker's lexicon. We can think of them as once-only rules.

One motivation for this sort of a lexicon is that the listing of already coined words provides a place for semantic drift to occur: once words are listed as actual words, they can begin to take on meanings which are not generable via the usual set of word formation rules. So, for example, in an Aronovian sort of a morphology, the word transmission would first be coined by the word formation rules of English, and assigned a transparent or compositional meaning, as in the transmission of the message. Once coined, this word would be listed as actual, and then would be free to adopt a new meaning -- as in the transmission of a car. The actual words of a language are therefore not merely a subset of the words generable by the word formation rules, but include words with meanings not directly generable.

Given this conception of the lexicon, it is not immediately obvious whether we must try to gauge the productivity of a word formation rule with respect to the words actually existing, i.e., listed, or with respect to the words that could potentially be derived by the word formation rules. As Aronoff points out, a first approximation to a definition of productivity might easily be based on the set of actual words: one word formation rule might be said to be more productive than another if the list of words formed by one is longer than the list of words formed by the other. However, this method of computing productivity is at best quite misleading. For example, the affix -ity attaches to [+Lat] adjectives to form nouns: reality, legality, rapidity, \*weirdity, \*fastity. On some intuitive level, it is less productive than the affix -ness which also attaches to adjectives to form nouns (weirdness, rapidness), but doesn't have the [+Lat]

restriction. However, if we count entries in a backwards dictionary (i.e., actual words), we find that -ity has a huge number of listings where it is affixed to adjectives derived with -able (approximately 2200 forms in Lehnert (1971)). If we define the productivity of -ity as the number of actual words containing -ity, the productivity of -ity is skewed upward each time we find a suffix to which -ity frequently attaches. Yet we would surely not want to count -ity as a very productive suffix because it attaches to 2200+ forms in -able. It is only the fact that -able is itself fairly productive, and that -ity can attach to any form with -able that is conveyed by counting individual items in -ability.

Another plausible way of viewing morphological productivity might be the following: the productivity of an affix might be the number of forms that could potentially be derived with that suffix -- i.e., we are now judging productivity with respect to possible words rather than actual words. One way of computing potential productivity is to compute the size of the class to which a given affix can attach. That is, if affix X can attach to all nouns and all verbs to form adjectives, it will be considered more productive than a second suffix Y which can only attach to [+Lat] nouns to form adjectives. This formulation of productivity is also problematic within Aronoff's framework: within a theory which contains a representation of actual words, we are forced to ask why forms derived with rather productive affixes sometimes don't exist. For example, the affix -ity in English attaches to [+Lat] adjectives to form nouns. -ity attaches in some cases to adjectives in -ous -- curiosity, scrupulosity -- indicating

that -ous must be considered a [+Lat] affix. But many of the potential words in -ousity do not seem to be actual words in English:

\*ridiculousity, \*hideosity, \*gloriousity. Aronoff seems to take this fact to mean that -ity must therefore be considered less productive. The net result of this is that it is not clear that any mechanical method of computing productivity can be formulated.

At this point, I would like to step back from the Aronovian framework, to make explicit an assumption that has remained tacit in my framework so far, namely that there exists no representation at all of actual words in the lexicon (except insofar as unanalyzable stems like dog and run are also actual words), and to show how this assumption allows us to maintain a simple and straightforward way of computing productivity. Remember that the chief reason for including a list of actual words within Aronoff's framework was to provide a locus for representing semantic idiosyncrasy. Since word formation rules in Aronoff's sense built up semantic representations along with structure (cf. 1.4.), the rules which coined words could not produce a form like transmission 'part of a car'. Such a word was first coined productively, then listed, and therefore open to semantic drift; semantic drift could only take place on listed items. Coined words had to be listed as actual words to allow the production of semantically non-compositional forms. Within my framework, I have argued that lexical semantic interpretation must be the function of a separate component: we must have semantic projection rules building compositional meanings, special rules mapping idiosyncratic meanings onto otherwise regularly derived forms like transmission, and a variety

of other semantic rules which ignore lexical structure entirely. There is no need to have a list of actual words within a theory assuming an autonomous lexical semantics.

In fact, there is something to be gained by having no representation of actual words in the lexicon: once we have eliminated this list, it is possible to maintain a definition of productivity based solely on possible words. The productivity of an affix is simply a function of the size of the class it attaches to. The fact that a given speaker does not use the form ridiculousity has nothing to do with the productivity of -ity, or in fact with the well-formedness of the word, but rather might be a function of the speaker's educational background, or the fact that ridiculousness is heard frequently, or some other factor not to be accounted for in the morphological component.

It is easy to see, given this conception of productivity, that the sort of subcategorization frames developed in this chapter give us an immediate way of computing the relative size of the class of items to which a given morpheme attaches, and therefore its productivity. Category features (+N, +V, etc.) divide the permanent lexicon into classes. Diacritic features such as [+Latinate], [+T], [+D], etc., divide the permanent lexicon into still smaller subclasses. The [+Latinate] adjectives are a subset of the adjective category class for any speaker of English, regardless of how many items actually belong to the adjective class for that speaker. The [+T] verb stems in Latin represent a larger subset of the verb stems than do the [+T] stems: any affix subcategorizing only [+T] stems will have a

productivity that is automatically smaller than an affix which subcategorizes [+T] stems. The subcategorization frame in the lexical entry of an affix will therefore contain an index of the potential productivity of that affix.

This sort of index of productivity is especially useful in that it gives us some insight into the case mentioned above, namely the productivity of -ity with -able, and what this case says about the productivity of -ity in general. Within my framework, -ity has the subcategorization frame in (118):

$$(118) \quad \text{-ity} / \begin{array}{c} ]_A \quad \text{---} ]_N \\ +\text{Lat} \end{array}$$

The affix -able will have its own lexical entry, and among its diacritic features, it will have the specification [+Lat]. Its productivity will be determined by its own subcategorization frame. What is crucial however, is that -able is just one more item, no different than [+Lat] stems like real, rapid, and rigid. Its contribution to the total productivity of -ity is the same as the contribution of each of these stems, i.e., one, regardless of its own productivity.



## FOOTNOTES: CHAPTER 2

1. At this point, we are ignoring the representation of stem allomorphy in lexical entries. In 1.2., this subject will be fully discussed, and lexical entries amended according to the results of this discussion.
2. By these definitions, morphemes like cran- and rasp- (cranberry, raspberry) are to be counted as bound morphemes or affixes. The fact that they have no isolable semantic representation poses no problem within the theory developed here, since it is possible for a morpheme to have a lexical entry which lacks a semantic representation entirely. The case of words like cranberry and raspberry will be treated in the same way as transmission (part of a car), and other words with lexicalized meanings (cf. section 1.4. on Lexical Semantics).
3. The unlabeled classes will be revised slightly in Chapter 4.
4. Thus, unlike transformational rules or phrase structure rules, morpholexical rules allow only a derivational depth of one -- i.e., there can be no "intermediate" structure mediating between two lexical terminals related by a morpholexical rule. This places a very strong constraint on the sort of relations among items in the permanent lexicon permitted by this theory (this was pointed out to me by Joan Bresnan): that is, there can be no lexical class such that this class is defined by two morpholexical rules X and Y, where X must be ordered with respect to Y. Morpholexical rules must be unordered.
5. This rule has been simplified to a certain extent. In addition to

pairs of stems like mord and momord, spond and spopond, Latin has pairs of stems like cad and cecid, tag (tangō) and tetig. These latter pairs suggest that the morpholexical rule in (8) must be refined to relate stems which differ both in the repetition of a portion of the first syllable and in the height of their vowels.

6. tangō obviously has three stems instead of two. In addition to the stems tag and tang related by the morpholexical rule in (8), there is another stem tetig related to tag by some version of the morpholexical rule for reduplicative past stems.

7. The 'arbitrariness' criterion is of crucial importance in determining whether or not a relationship is to be treated as morpholexical or not. For example, in English it is arbitrary that a small number of verb stems like sing, ring, etc., form past stems by lowering their stem vowel (sang, rang), and a small number of other verb stems by other ablaut processes (bring ~ brought) (cf. Halle 1978 for details of these processes). Since it is not predictable on any independent semantic or phonological grounds that any given verb stem should have a particular ablauted past stem (or should have an ablauted past stem at all), this relationship must be represented within the theory developed here as a morpholexical one; i.e., {sing, sang}, (ring, rang), ...} belong to a lexical class defined by a morpholexical rule. Both stems are listed. If it had been the case that every verb in English formed its past stem by lowering the stem vowel, however, this would no longer be a morpholexical relationship. We would have no reason to list past stems in the permanent lexicon. Instead, past

stems could be derived by a productive string dependent morphological rule (cf. section 1.3., and Chapter 4 on the nature of string dependent rules).

8. I am assuming that the feature matrix assigned to each lexical category is a language particular matter. Obviously, the sort of feature matrix necessary for expressing morphological distinctions among Latin verbs would be inappropriate for English verbs: for example, English verbs distinguish between 3-sg. and non-3-sg. in the present, but there are no P/N distinctions elsewhere. One way of expressing the relative poverty of morphological distinctions in English might be to assume a feature matrix containing only three non-category features for verbs: [+V,  $\alpha$  P/N,  $\emptyset$  Pres,  $\gamma$  Pst]:

$$\text{laugh} \begin{bmatrix} +V \\ -P/N \\ \emptyset \text{Pres} \\ -Pst \end{bmatrix} ; \quad -s \begin{bmatrix} +V \\ +P/N \\ +\text{Pres} \\ -Pst \end{bmatrix} ; \quad -d \begin{bmatrix} +V \\ -P/N \\ -\text{Pres} \\ +Pst \end{bmatrix}$$

[+P/N] is to be interpreted as third person sg., [-P/N] as non-3-sg., [ $\emptyset$  Pres] indicates that the verb is inherently unmarked for tense, which is to be interpreted in the following way: the non-tense marked form of the verb is compatible with any non-past syntactic context (e.g., infinitive, future, present, modal contexts, etc.).

9. Vietnamese has righthand compounds as well as lefthand compounds. The former are either direct loans from Chinese, or, presumably, compounds formed on analogy to Chinese compounds.

10. A sort of redundancy relation in the permanent lexicon will be

discussed extensively in Chapter 3.

11. Williams (1979) introduces a new notion of relatedness to account for examples like these: "...two words can be related if one can be gotten from the other by varying one of its heads" (p. 25). So transformational grammarian is related to transformational grammar not because the latter constitutes a structural subconstituent of the former, but because the latter can be obtained from the former by suppressing its head -- i.e., -ian.

12. The rules in (64) are essentially adopted from Redenbarger (1976). My analysis of Latin phonology departs from Redenbarger's at this point. Specific differences will be discussed below.

13. I will argue below that the underlying form of this suffix is slightly different.

14. Spelled ae instead of ai in the ā declension.

15. i never appears in the dative singular of amicus (we find amicō instead). I have no explanation for this fact. I should point out, however, that no account of Latin phonology to date has offered an explanation for this fact.

16. The nominative singular ending idiosyncratically attaches to the root form in the class to which princeps belongs.

17. Even messier is the fact that the theme vowel i is lowered in the infinitive and imperative singular of verbs like capiō (capere, cape). I have no explanatory way of accounting for this fact.

18. The general idea here was suggested by Halle (it recapitulates a historical stage in the development of Latin as well), but the particular form of the rule in (77) is my own interpretation of Halle's suggestion.

19. To the extent that correlations exist between theme vowel class and perfect stem class, they can be treated in the same way as correlations between lexical class membership for nouns and gender in German, i.e., by redundancy rule.

20. The way I have formulated the morpholexical rule relating roots and reduplicative perfects in Latin will allow us to relate cad (cadō) to its perfect stem cecid, as well as ped and spond to their perfect stems peped and sponpond. The righthand side of the morpholexical rule is to be interpreted more or less as a template requiring identity of the numbered consonants, but allowing vowels which have the possibility of differing with respect to height in the two stems. The second vowel must be [-lo] (its specification for the feature [hi] is not indicated), whereas the first vowel in the reduplicative stem must be mid.

21. Again, to the extent that certain theme vowel classes favor the use of one class or the other, we can use a redundancy rule to express the generalizations that do exist.

22. A phonological rule not discussed above will delete ē in ēbā when it follows ā. That the form of the imperfect affix is ēbā and not bā is supported by forms like capiēbam or audiēbam. In monēbam (underlying monē+ēba+m), we would assume degemination.

23. A rule something like this was also proposed in Redenbarger (1976).
24. Latin also has a number of phonological assimilation rules, the exact nature of which are not crucial to the present discussion. These assimilation rules obscure the underlying forms of some of these prefixes.

## CHAPTER 3: MORPHOLOGICAL CONVERSION

The model of morphology developed in the first two chapters of this thesis allows us to integrate inflection and derivation into a single, unified system of word formation, but it has further consequences as well. In this chapter, I will try to show that accepting such a model forces us to abandon an analysis in which morphological conversion rules -- the rules which relate, for example, paint (N) to paint (V) in English or Ruf (N) 'call' to rufen (V) 'call' (where -en is inflectional) in German, are rules of zero affixation (i.e., rules of word formation in which the affix attached is phonologically null). My strategy here will be to show that the so-called  $\emptyset$  affix does not, in fact, behave like an overt derivational affix. I will argue further that no directional rule of word formation (a rule, for example, which would change the category of a word without adding bracketing or null phonological material), can account for the facts of morphological conversion in English or German; all directional rules will be subject to the same criticisms that the zero-affixation analysis is open to. I will argue instead that morphological conversion should be expressed as a redundancy relation in the permanent lexicon. Individual items like paint (N) and paint (V) will have separate lexical entries, and the permanent lexicon will contain a redundancy relation stating that such phonologically and semantically related pairs are highly valued in the grammar of English. In addition, I will try to argue that morphological conversion is another area of word formation in which lexical structure and lexical semantics are not isomorphic: whereas the "syntax" of conversion is

non-directional, the semantics of conversion may be governed by directional rules. In addition to considerably simplifying our lexicon, the analysis to be proposed here will also make predictions about morphological conversion on complex derived words. The analysis will also lead us to a reanalysis of forms for which Aronoff (1976) proposed rules of root and suffix allomorphy and truncation.

### 1. Against Zero-Affixation

It seems to be a more or less iron-clad assumption of both traditional and current work on morphology (cf. Allen 1978), that morphological conversion, the relating of two lexical items which are phonologically identical and semantically related,<sup>1</sup> but which differ only in category, is a process of zero-affixation. One reason for such an assumption is that derivational suffixes characteristically change category: e.g., -ness attaches to adjectives to form nouns. If morphological conversion is analyzed as suffixation of a phonologically null morpheme, the concomitant category change is then explained. Another reason for the persistence of the zero affixation analysis might also be simply that generative morphology, in its few years of existence, has been heavily biased towards English. English morphology is largely affixational; the need for morphological rule types distinct from affixation does not emerge clearly from the study of English alone. We have seen that other types of morphological rules are necessary, however -- namely, morpholexical rules for languages with inflectional paradigms and string dependent morphological rules for processes like reduplication. In light of such refinements to the theory of morphology, it is worth reconsidering



the status of conversion as a morphological process.

In fact, languages like German which have complex inflectional classes provide us with a cogent argument against analyzing conversion as zero affixation. A typical example of morphological conversion in German is the large number of nominalizations directly taken from the various stems of the strong verbs:

- |              |                                  |   |
|--------------|----------------------------------|---|
| (1) der Riss | 'tear'                           | from PERF/PPLE of reiss(en), riss, (ge)riss(en) |
| der Stich    | 'prick,<br>puncture'             | from 2-3 SG. INDIC of stech(en)                 |
| der Drang    | 'pressure'                       | from PERF of dring(en), drang, (ge)drung(en)    |
| Der Fund     | 'find'                           | from PPLE of find(en), fand, (ge)fund(en)       |
| der Ruf      | 'call'                           | from PRES/PPLE of ruf(en), rief, (ge)ruf(en)    |
| das Grab     | 'grave'                          | from PRES/PPLE of grab(en), grub, (ge)grab(en)  |
| das Band     | 'ribbon'                         | from PERF of bind(en), band, (ge)bund(en)       |
| der Band     | 1. 'tie'<br>2. 'binding, volume' |   |

The parenthesized morphemes in the verb forms of (1) are inflectional affixes for the infinitive and the participle which we can assume to be added as part of lexical structure. We may also assume that the strong verbs of German can be analyzed into a number of lexical classes within the category class V. These lexical classes are defined, as usual, by morpholexical rules which will specify the nature of the vowels in each stem. I will not provide such an analysis here, but instead, assume that such an analysis would be analogous to the one given for the strong verbs of Old English in Chapter 1. Notice also that the presence of nouns derived from all parts of the strong verbs, including the 2-3

eg. indicative stem, again supports the hypothesis that stem variants are listed as separate segmental items in the permanent lexicon.

Suppose now that the nouns in (1) are to be derived from the verbal stem variants by means of a rule of zero-affixation. As described in Chapter 2, all derivational suffixes are to be listed in the permanent lexicon as members of some lexical class. For example, the nominalizing suffixes -heit and -keit are listed as members of the same lexical class as the nouns Staat and Spur; all of these have plural stems in -en (-keiten, -heiten, Staaten, and Spuren). Every noun derived with -keit and -heit will form its plural in the same way. We must assume, then, that the zero affix which forms nouns from strong verb stems is also represented in the permanent lexicon as a member of some lexical class -- that is, all of the nouns in (1) must have plural stems, and since they are derived by affixation of  $-\emptyset$ , they must adopt their mode of pluralizing from this affix. What we find when we look at the plurals of the nouns in (1), however, is the following: unlike nouns formed with -heit, -keit or other overt derivational suffixes, nouns formed with  $\emptyset$  do not fall into a single lexical class:

- (2)
- |    |         |   |           |   |            |                   |
|----|---------|---|-----------|---|------------|-------------------|
| a. | rufen   | → | der Ruf   | ~ | die Rufe   |                   |
|    | finden  | → | der Fund  | ~ | die Funde  |                   |
|    | binden  | → | der Band  | ~ | die Bande  | 'tie, bond'       |
| b. | klingen | → | der Klang | ~ | die Klänge |                   |
|    | binden  | → | der Band  | ~ | die Bände  | 'volume, binding' |
| c. | graben  | → | das Grab  | ~ | die Gräber |                   |
|    | binden  | → | das Band  | ~ | die Bänder | 'ribbon, tie'     |

The nouns in (2a) belong to the same lexical class as noun stems like

Hund and Sommer (the -e in the plural is inflectional, and is deleted after unstressed e + sonorant, cf. Chapter 1). Those in (2b) belong to the same lexical class as the nouns Bach and Vater. Those in (2c) belong to the same class as Mann and Geist. We cannot postulate a single zero affix analogous to suffixes like -heit and -keit, then, since nouns formed on  $\emptyset$  fall into at least three different classes. If we want to maintain that morphological conversion is zero affixation, we must postulate a minimum of three different zero affixes, each listed as a member of a different lexical class (call them  $\emptyset_1$ ,  $\emptyset_j$ ,  $\emptyset_k$ ).

The complications to the analysis don't stop at this point, however. Not only must we postulate three distinct  $\emptyset$  affixes to account for the differences in plural stems among  $\emptyset$ -derived nouns, but we must also mark each verbal stem variant which can undergo  $\emptyset$  affixation for the particular  $\emptyset$  affix it will take. Thus, Ruf, Fund, and Band<sup>1</sup> will be marked to take  $\emptyset_1$ , Klang and Band<sup>2</sup> to take  $\emptyset_j$ , and Grab and Band<sup>3</sup> to take  $\emptyset_k$ . This is an especially undesirable consequence: lexical entries for affixes regularly subcategorize the type of stem to which they attach, but stems do not normally specify that they must take a particular affix.<sup>2</sup> Stems, or free morphemes, were distinguished from affixes, or bound morphemes in that the former systematically lacked subcategorization frames. To allow verb stems to subcategorize the particular  $\emptyset$  affix they take would therefore lead to an undesirable weakening of our theory.

Moreover, the three nominal  $\emptyset$  affixes will not suffice to account for all of the conversion phenomena in German. German also has what

seem to be denominal verbs:

- (3) Pflug 'plow' ~ pflügen 'plow'  
 Land 'land' ~ landen 'land'  
 Frühstück 'breakfast' ~ frühstücken 'breakfast'

If the nouns in (3) form the bases for the corresponding verbs, then we need to postulate yet another  $\emptyset$  affix belonging to the category V. German also has a morphological conversion rule relating adjectives to verbs (grün 'green', grünen 'make green' -- I will discuss this rule at greater length below), so one more  $\emptyset$  verbal affix would be required.

This multiplication of  $\emptyset$  affixes cannot be discounted as a freak accident in German; an exactly analogous argument can be made for Old English as well, on the basis of the weak verbs. The weak verbs are traditionally divided into two classes which exhibit different patterns of vowel deletion before inflectional affixes (cf. Keyser 1979, and Kiparsky and O'Neil 1976, for discussion of the phonology of these verbs. For the purposes of the argument here, we need only refer to underlying representations). These two classes are distinguished by their choice of theme vowel:

- |     |         |                          |                            |                         |
|-----|---------|--------------------------|----------------------------|-------------------------|
| (4) | WEAK I  | dēm+i+endings<br>'judge' | frem+i+endings<br>'profit' | ner+i+endings<br>'save' |
|     | WEAK II | lōc+a+endings<br>'look'  | luf+a+endings<br>'love'    |                         |

The theme vowel a of class II is fronted and raised to i when it precedes another vowel (lufian). Within the morpholexical theory of inflection, weak verbs would therefore be divided into two lexical classes with the following morpholexical rules and sets of stem

variants:

- (5) CLASS I: morpholexical rule  $X \sim Xi$   
 $\{(d\bar{o}m, d\bar{o}mi), (frem, fremi), (ner, neri), \dots\}$
- CLASS II: morpholexical rule  $X \sim Xa$   
 $\{(l\bar{o}c, l\bar{o}ca), (luf, lufa), \dots\}$

According to the handbooks (cf. Wright 1925), many of these weak verbs are actually formed from nouns, adjectives and parts of strong verbs. For the sake of this argument, we will confine ourselves to those that derive from nouns. If lufian and dēman, for example, derive from nouns, there are no underlying verbal stems luf and dēm, as listed in (5). Instead, the nouns dōm 'judgment' and lufu 'love' (the -u is the nominative singular inflection) have undergone conversion to become verbal stems. Still assuming the zero-affixation analysis of conversion, we must postulate a conversion rule which takes dōm, lufu, and nouns like them, and attaches a verbalizing  $\emptyset$  affix to them. It is this affix that belongs to the lexical classes in (5). And obviously, just as in the case of German noun-verb conversion, a single  $\emptyset$  affix will not suffice. One  $\emptyset$  affix will have to belong to class I, and a second to class II. The nouns which form class I weak verbs (e.g., dōm, lār) will have to be marked to take  $\emptyset_I$ , and those which form class II weak verbs (lufu, lof) marked to take  $\emptyset_{II}$ . Thus, in Old English, as well as German, the conversion-as-zero-affixation analysis results in both a multiplication of  $\emptyset$  affixes and an unmotivated marking of stems for the affixes they subcategorize.

There is yet another reason for arguing against the zero-affixation analysis. It was argued in Chapter 2 that part of the lexical entry for

a lexical terminal should be a frame or argument structure into which that item can be inserted in the syntax. Since suffixes have separate lexical entries just as roots and stems do, they would be expected to appear with such insertion frames as well. For example, the verbalizing suffix -ize in English uniformly forms transitive verbs, i.e., verbs with two NP argument positions: demoralize, industrialize, standardize, etc.<sup>3</sup> The verbalizing suffix -ieren in German is analogous: duplizieren 'duplicate', komplizieren 'complicate', explizieren 'explicate', etc., are all transitive. -ieren might therefore be listed within its lexical class with an insertion frame having two argument positions (like the verb stem eat NP\_\_ (NP)). If  $\emptyset$  is an affix listed in the permanent lexicon, we would expect it to be analogous to -ize and -ieren, and to have an insertion frame into which all  $\emptyset$  derived verbs would be inserted. However, this seems not to be the case. In both German and English, there are  $\emptyset$  derived verbs which require different insertion frames:

- (6) a. pflügen            NP\_\_NP  
       frühstückten    NP\_\_
- b. condition        NP\_\_NP  
       culture            NP\_\_NP  
       orbit             NP\_\_NP  
       prejudice        NP\_\_NP  
       gesture            NP\_\_  
       feud                NP\_\_  
       figure             NP\_\_

The insertion frames in (6) are rudimentary at best, but they illustrate the essence of the problem. German pflügen and frühstückten are both

verbs derived from nouns by  $\emptyset$  affixation, yet the former is transitive and the latter intransitive. The English verbs in (6b) are also derived from nouns by  $\emptyset$  affixation (cf. Allen 1978 for the argument to this effect), and as with the German verbs, half are transitive and half intransitive. Thus, unlike normal verbal suffixes, -ize and -ieren,  $\emptyset$  cannot be listed in the permanent lexicon with a single insertion frame. At best, to maintain the standard form of lexical entries argued for in Chapter 2, we would have to multiply our  $\emptyset$  affixes yet again, having one transitive  $\emptyset$  and another intransitive  $\emptyset$ , and concomitant subcategorization features on the nouns which undergo each  $\emptyset$  affixation rule. But clearly, this multiplication of  $\emptyset$  affixes has been pushed to the point of absurdity. All of the evidence in this section actually points towards an analysis in which conversion rules are formally distinct from affixation rules.

## 2. Against Any Directional Rule of Conversion

One way of doing conversion which is formally distinct from zero-affixation immediately suggests itself. Consider the rules in (7):

$$(7) \quad \begin{array}{l} N \longrightarrow V \\ V \longrightarrow N \end{array}$$

Such rules do not add any affixes, phonologically null or otherwise, nor do they add bracketing to the derived structure of a word. Instead, they merely change the category label on a bracket, changing a noun to a verb or a verb to a noun. In this section, I would like to argue that rules of the form (7), and indeed any rule which directionally changes one category to another, are subject to exactly the same

proliferation problem to which the zero affixation analysis was subject. That is, I will argue that the multiplication problem of the zero affixation analysis is not specifically a property of the zero affix, but a property of directional analyses in general.

As argued in Chapter 2, certain information must be available about each word generated by our morphology, whether derived or non-derived. This information includes such idiosyncratic properties as category, lexical class, and insertion frame. For underived (monomorphemic) words, such information is available in the lexical entry for that word. For words derived with derivational affixes, the necessary information is provided in the lexical entry for the affix, and is transmitted to the whole derived word by means of our feature percolation mechanisms. Words derived by the rules in (7) must also have information about lexical class membership and insertion frame specified (the rules, as stated above, only specify category). Since these derived words have no lexical entries, the information needed can only be written into the rules themselves.

Once we admit the need for specifying lexical class membership and insertion frames as part of the conversion rules, we can see why this analysis is subject to the same proliferation problem as the zero-affixation analysis. If nouns derived by the  $V \rightarrow N$  rule must be specified for their plural forming class in German, we need at least three different  $V \rightarrow N$  rules, one for each lexical class into which nouns fall:  $V \rightarrow N_i$  would produce the nouns in (2a),  $V \rightarrow N_j$  nouns in (2b), and  $V \rightarrow N_k$  nouns in (2c). And, of course, we would also have to mark verb stems for the particular  $V \rightarrow N$  rule they undergo.



Similarly, if verbs derived by the  $N \rightarrow V$  rule must be specified for the sort of insertion frame they will have, and if there exist denominal verbs like those in (6) which are both transitive and intransitive, then we will need at least two  $N \rightarrow V$  rules, one specifying that the derived verbs take two arguments, and another specifying that the derived verbs take a single argument. Again, lexical marking of noun stems would be needed in order to express which of the  $N \rightarrow V$  rules they may undergo.

The point to be made here is not that the zero-affixation analysis and the general directional conversion analysis are impossible. Both can be made, with a certain amount of complication, to account for the observable facts. These analyses are undesirable, however, on the grounds that they force us to weaken the theoretical constraints on our morphology. Within a well-constrained morphology, affixes have certain clearly defined properties: like individual stem morphemes, they belong to a unique lexical class and impose a unique argument structure on their outputs. The zero-affixation analysis requires us to allow an affix ( $\emptyset$ ) which does not exhibit these properties. Similarly, within a well-constrained morphology, lexical idiosyncrasy is confined to lexical entries in the permanent lexicon; information as to lexical class membership, gender, category, etc., which is unpredictable on independent grounds, is expressed there. The directional analysis requires us to express lexical idiosyncrasy not only in lexical entries but also as a part of morphological rules.

An optimal analysis of the German and English facts described above should allow none of these theoretical dilutions. That is, an analysis which both accounts for these facts, and allows us to maintain constraints

on the statement of lexical idiosyncrasy and the properties of affixal morphemes should be a more highly valued analysis.

### 3. Conversion as a Redundancy Rule in the Permanent Lexicon

Suppose that conversion, instead of being an affixation process, or some other sort of directional process, is a redundancy rule within the permanent lexicon. Conversion would be defined as a relation R such that lexical terminals X and Y satisfy R if and only if they differ only with respect to their category class membership. X and Y would thus have to be phonologically identical and semantically related, where the notion of 'semantic relatedness' will be explored more fully below. Conversion processes are thus entirely distinct from affixation: we can view N-V conversion, for example, as a statement in the permanent lexicon to the effect that, all other things being equal, it is less costly in a grammar of language L for lexical terminals to form both nouns and verbs than for these terminals to belong to only one of those categories. Put another way, such an N-V redundancy rule says that the grammar of L values highly multiple use of existing lexical items, but values less highly the creation of a new item for a single use. In detail, the proposal entails the following:

a) Separate lexical entries for e.g., Band (N) and band (V), each specified individually as to their lexical class and category membership:

(8) Category Class: V

Lexical Class:	1
	⋮
	⋮
	n
	{(bind, band, bund),...}
	[+ Semantic rep.
	insertion frame,...]
	etc.

Category Class: N

Lexical Class: i  $\{(Band), \dots\}$   
 $\left[ \begin{array}{l} +semantic\ rep. \\ insertion\ frame \\ etc. \end{array} \right]$

Lexical Class: j  $\{(Band, B\grave{a}nd), \dots\}$   
 $\left[ \begin{array}{l} +semantic\ rep. \\ insertion\ frame \\ etc. \end{array} \right]$

k  $\{(Band, B\grave{a}nder), \dots\}$   
 $\left[ \begin{array}{l} +semantic\ rep. \\ insertion\ frame \\ etc. \end{array} \right]$

b) A relation  $R=N \longleftrightarrow V$  (or whatever formalism we want to use for expressing redundancy relations), which relates pairs of lexical items like  $(Band_N, band_V)$  which differ only in category. Pairs of lexical terminals related by R will be called conversion pairs. Each member of a conversion pair will be called the conversion mate of the other.

Notice that conversion rules like R can now be stated in a maximally general fashion. First, lexical items belonging to conversion pairs are simply listed as members of lexical classes, as are lexical items not belonging to conversion pairs. Since one member is not formed from the other by an affixation rule, there is no need to specify what lexical class items formed by a given  $\emptyset$  belong to, and no need to subcategorize stems for the  $\emptyset$  they take. The multiplication of  $\emptyset$  affixes (or of directional rules) and the need to subcategorize stems vanishes, greatly simplifying our permanent lexicon. Second, since members of conversion pairs have separate entries, rather than all being derived by a  $\emptyset$  affix, or a directional rule, there is no reason to expect them to have identical insertion frames. Each verb belonging to a conversion pair specifies its insertion frame separately, whereas all verbs derived with

-ize must have the insertion frame of this suffix (i.e., the insertion frame is stated for -ize, and not for its individual outputs).

The zero affixation and redundancy analysis differ in another important respect, which we have not yet discussed. That is, the affixation analysis claims that one member of every conversion pair is derived from the other, and therefore that one member of each pair must be underlying or basic. The redundancy analysis claims, to the contrary, that neither member of a conversion pair is derived from the other; both members are basic and have entries in the permanent lexicon. The affixation analysis thus differs from the redundancy analysis in that it must provide criteria for every conversion pair for determining the basic and non-basic members of the pair. The redundancy rule analysis requires no such criteria. Since the two theories make different claims, it is worth looking at possible arguments for deriving one member of a conversion pair from another.

One such argument, and, in fact, the only argument in the literature that I know of, is due to Margaret Allen. Allen argues that some members of English N-V conversion pairs will take -ive, which attaches to verbs, and others will take -al, which attaches to nouns. According to Allen, no conversion pair member takes both:

(9) a.	condition <sub>N,V</sub>	conditional	*conditionive
	gesture <sub>N,V</sub>	gestural	*gesturive
	feud <sub>N,V</sub>	feudal	*feudive
	culture <sub>N,V</sub>	cultural	*culturive

b.	respect <sub>N,V</sub>	*respectal	respective
	support <sub>N,V</sub>	*supportal	supportive
	affect <sub>N,V</sub>	*affectal	affective
	exhaust <sub>N,V</sub>	*exhaustal	exhaustive

Both -ive and -al are Level I affixes within Allen's framework (i.e., they are non-stress neutral affixes). The behavior of items like those in (9) can be explained, Allen argues, if (i) conversion is zero-affixation, (ii) if zero affixation is level ordered after Level I, and if (iii) the noun members of the conversion pairs in (9a) are underlying, and the verb members of the pairs in (9b) are underlying. Thus, of the forms in (9a), only the nouns will be available to Level I affixes, and only -al, which attaches to nouns, will be able to affix to them. The verbs are formed after Level I, at which point they are no longer accessible to the Level I affix -ive. Exactly the opposite situation holds for the items in (9b). Here, the verbs are underlying and are available at Level I for -ive to attach. The nouns are formed after Level I, and are therefore outside the scope of Level I affixes.

In contrast, if both members of the pairs in (9) are listed individually in the permanent lexicon, there is no immediate reason for the apparent complementary distribution of -al and -ive. Williams (classnotes) has proposed an alternative explanation for Allen's facts, however. He points out that -ive attaches primarily to a stem with a diacritic [+Linate]. Thus, it will attach to permit (permissive), conduct (conductive), transmit (transmissive), repel (repulsive), effect (effective), and many of the other Linate prefix-stem combinations. It will not attach to non-Linate verbs such as feud and throw. In addition (something to my knowledge not pointed out by

Williams), -ive attaches very productively to verbs in -ate: contemplative, representative. In fact, the only true non-Latinate verbs with -ive only take -ive with an intervening -ate: talkative (\*talkive), formative (\*formive). This fact suggests that -ate is actually a [+Latinate] element as well (cf. below for a discussion of the status of forms in -ate). Williams points out, furthermore, that -al only occasionally attaches to Latinate stems, and then, only with an intervening segment: conceptual, contractual (contractive), ineffectual (ineffective). Williams' point, then, is that independently needed restrictions on these suffixes explain their distribution without appeal to Allen's level ordering argument.

Moreover, even if Allen's criterion for distinguishing the underlying members of the pairs in (9) were correct, it would not be sufficient to determine the underlying member of every conversion pair. Many lexical items which belong to conversion pairs take neither -al nor -ive:

(10)	claw <sub>N,V</sub>	*clawal	*clawive
	paint <sub>N,V</sub>	*paintal	*paintive
	throw <sub>N,V</sub>	*throwal	*throwive
	chair <sub>N,V</sub>	*chairal	*chairive
	sing <sub>N,V</sub>	*singal	*singive

The advocate of zero affixation would therefore have to come up with another criterion for picking out the underlying form for conversion pairs such as these.

As far as I know, the only other argument that has ever been offered for determining the underlying member of a conversion pair

comes from the feeling that speakers of English and German have that one member is semantically more or less basic than its conversion mate. Marchand's (1969) classification of zero-affixation cases, for example, is completely based on semantic criteria: denominal verbs are classified into groups on the basis of what argument position the corresponding noun occupies in the interpretation of the verb:

The noun is the object of the verb in calve, for instance, the object complement in cash 'convert into cash', the subject complement in corner 'put in a corner', butter 'coat with butter',...

I will not try to argue against the semantic directionality of conversion here. In fact, I believe it to be the case that native speakers have clear intuitions about the semantic relationships between members of conversion pairs. Instead, I will claim that an analysis of the semantics of conversion is, in principle, independent of our syntactic analysis of conversion, and in particular that the semantic analysis can involve directionality without arguing in any way against the non-directionality of the syntactic analysis. If this is true, then there are no cogent arguments against my claim that neither member of a conversion pair is structurally more basic than its mate.

#### 4. The Semantics of Conversion

In Chapter 2, I argued that the semantics of word formation need not be isomorphic with the structural or 'syntactic' aspects of word formation; there, I gave a number of examples where semantic rules partially or totally ignore the structure of a complex word. For the

issue at hand, this means that the analysis of the structural aspects of morphological conversion need not be paralleled by the semantic analysis: the two are in principle independent. Notice further that all of the arguments I have given so far for the non-directionality of conversion have been structural sorts of arguments. A non-directional redundancy rule for conversion allowed us to state facts about lexical class membership and insertion frames in the simplest possible manner. At this point, I would like to suggest that both the feeling that native speakers have that one member of a given conversion pair is more basic than the other, and the intuition that underlies Marchand's classification of denominal verbs are to be explained by directional semantic rules relating one member of a conversion pair to the other.

At the beginning of this chapter, it was assumed that we must require some degree of semantic relatedness between items said to be members of the same conversion pair. For example, we would probably not want to say that the noun bank 'edge of a river' is related to the verb bank 'perform transactions at a financial institution' via conversion. We might, however, want to say that the noun chair and the verb chair are semantically related, at least in some metaphorical sense, and we would clearly want to say that such pairs as cough<sub>N</sub> and cough<sub>V</sub>, paint<sub>N</sub> and paint<sub>V</sub>, and claw<sub>N</sub> and claw<sub>V</sub> are related. The notion of 'semantic relatedness' can now be more fully explained. Suppose that lexical terminals which belong to conversion pairs have lexical entries which are like those of other lexical terminals in all respects, except that one member of a conversion pair may lack a semantic representation (or have one which is significantly underdetermined). In



the case of N-V conversion, either the noun or the verb can be underdetermined semantically. The missing semantic representations might then be filled in or fleshed out by directional semantic rules of the following sort:<sup>4</sup>

(11) a. N  $\longrightarrow$  V Semantic Rule:

Given a semantically specified noun X, and a related, but semantically underspecified verb Y, X must serve as an argument in the interpretation of Y.

e.g.,  $\text{claw}_N \longrightarrow \text{claw}_V$  'scratch with claws'  
 $\text{paint}_N \longrightarrow \text{paint}_V$  'cover with paint'

b. V  $\longrightarrow$  N Semantic Rule:

Given a semantically specified verb Y and a related, but semantically unspecified noun X, X is interpreted as "an instance of Y-ing".

e.g.,  $\text{throw}_V \longrightarrow \text{throw}_N$  'an instance of throwing'  
 $\text{clap}_V \longrightarrow \text{clap}_N$  'an instance of clapping'

My analysis, in some sense, claims that members of conversion pairs can be structurally equal, while at the same time one member of semantically derivative of the other. Rule (11a), in fact, embodies Marchand's observation that a semantically denominal verb incorporates its related noun into its interpretation either as object, object of some preposition, object complement, subject complement, etc. For the case of bank described above, bank<sub>N</sub> 'side of a river' and bank<sub>V</sub> 'perform transactions at a financial institution' are not a conversion pair; although they could be related by the structural N  $\longleftrightarrow$  V

conversion redundancy rule, they have totally distinct semantic representations and therefore could not be related by either (11a) or (11b).

One interesting concomitant of this proposal is that it is at least theoretically possible for both rules (11a) and (11b) to operate in a single conversion pair to produce a fairly complex pattern of semantic interrelatedness. Consider, for example, the noun table and the verb table. Intuitively, in this case, the verb is semantically derivative of the noun: rule (11a) would give us a semantic reading for table<sub>V</sub> something like "put something on a table (and forget about it)". There is no reason, however, for excluding the possibility that rule (11b) then derives another nominal meaning from the already derived verbal meaning: a table<sub>N</sub> might then be interpreted as 'an instance of tabling' (picture a context in which Congressmen on some committee are sorting through legislation; one might say "This one is a definite table"). Rules such as (11a) and (11b) thus allow us to derive extended senses of members of conversion pairs without actually deriving new (structural) words.

## 5. The Scope of Conversion

Assuming morphological conversion to be a redundancy rule in the permanent lexicon makes further claims as well. If, in German and English, we postulate a  $N \leftrightarrow V$  redundancy relation for N-V conversion pairs, we actually predict that any of the sorts of lexical terminal which can belong to the category classes N and V could conceivably be a member of a conversion pair. In this section, I will survey a number of different sorts of lexical terminals; in light of the fact

that it is usually assumed that only monomorphemic stems are related by conversion (cf. Marchand 1969), the data to be presented here should be of some theoretical interest.

We have abundant examples from both English and German of roots and stems being related to other roots and stems via conversion. Thus, English has hundreds of monomorphemic pairs like paint<sub>N</sub>, paint<sub>V</sub>; chair<sub>N</sub>, chair<sub>V</sub>. In fact, nearly every monomorphemic noun has a corresponding verb form. Since this is the most obvious case of conversion, no more need be said about it here.

Less obvious are the large number of pairs in English of the form pérmít<sub>N</sub>, perμίt<sub>V</sub>; cónduct<sub>N</sub>, conúct<sub>V</sub>, etc. Although these pairs are clearly semantically related, they are phonologically distinct in that the nouns are stressed on the initial syllable and the verbs on the final syllable. Within the SPE framework, such pairs were related by a morphological process of zero affixation, or at least by a process which took the verbs as underlying and derived the nouns by adding a set of noun brackets. Such an analysis was necessary in order to get the proper stress on the noun: Chomsky and Halle observed that all forms like perμίt<sub>V</sub>, conúct<sub>V</sub>, tormént<sub>V</sub> have final stress. The corresponding nouns have stress shifted to the initial syllable, but retain secondary stress on the final syllable: the final vowel in tórmént<sub>N</sub> is unreduced (cf. an analogous underived noun tórrént). SPE handled these stress facts with the use of the phonological cycle:

- (12)                    [[torment]<sub>V</sub>]<sub>N</sub>
- |   |   |         |
|---|---|---------|
| 1 | 1 | Cycle 1 |
| 1 | 2 | Cycle 2 |

If the nouns were derived directionally from the verbs, the secondary stress on the final syllable of the nouns could be attributed to a subordinated primary stress introduced during the previous verb cycle.

Clearly, if the only way of accounting for stress placement in pairs like pérmít<sub>N</sub>, permít<sub>V</sub> is via a phonological cycle, this would cause problems for the analysis of morphological conversion proposed above. We could not at the same time maintain that conversion is non-directional, and that pairs like pérmít<sub>N</sub>, permít<sub>V</sub> are related by conversion, and still express the stress relations in these pairs. In other words, we would be forced either to claim that pairs like pérmít<sub>N</sub> and permít<sub>V</sub> were not conversion pairs, or that the non-directional analysis of conversion was in general incorrect.

Lieberman and Prince (1977), however, have proposed an alternative analysis of English stress, which does not force a cyclic account of the stress facts in permit cases, and hence does not require a directional analysis. Their system incorporates a segmental stress assigning rule, the ESR, which attaches a [+stress] feature to certain syllables; this rule, whose precise workings are irrelevant to the present argument, scans a string from right to left creating a pattern of [+stress] and [-stress] syllables. One of the conditions on Lieberman and Prince's ESR is that it cannot leave the entire stem of a word unstressed. This is relevant to permit cases in that in some sense the final syllable mit constitutes the entire stem in both the noun and the verb. The ESR, as formulated by Lieberman and Prince, will also attach, by general principles, the feature [+stress] to the first syllables of these forms:

(13)                    permit<sub>N</sub>                    permit<sub>V</sub>  
                           + +                                    + +

The real innovation in Liberman and Prince's stress system, however, is the following: the relative prominence of the [+stress] syllables in a word is determined by the metrical structure for that word. A unique tree structure is built for each word, and nodes of trees labeled either S (strong) or W (weak) on the basis of the Lexical Category Prominence Rule (LCPR), which in its most general form says that of two sister nodes  $[N_1, N_2]$ ,  $N_2$  is S iff it branches. A general condition on the labeling of tree structure is that a [-stress] syllable cannot be immediately dominated by S. For the case under discussion here, another clause of the LCPR is relevant, however: Liberman and Prince's condition D states that in the configuration  $[N_1, N_2]_\alpha$ , where  $N_1$  and  $N_2$  are sister nodes of a tree,  $N_2$  is strong if  $\alpha = V$  and  $N_2$  dominates a stem. The forms in (13) have the following trees:

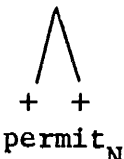
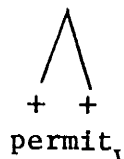
(14)            a.                                        b.                    

For (14b), Liberman and Prince's condition D is relevant: the second syllable of the verb gets as S label, since it totally exhausts the stem:

(15)                    

Condition D is not relevant for (14a), however, since this form is a

noun. Instead, the LCPR labels nodes according to its most general clause: since  $N_2$  does not branch in (14a),  $N_1$  is labeled S:

(16)

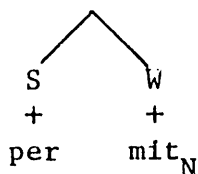

The primary stressed syllable in a word is the [+stress] syllable dominated exclusively by S nodes; this gives initial stress in (16), and final stress in (15). No [+stress] syllable will undergo vowel reduction, however, thus accounting for the unreduced second vowel in forms like pémit<sub>N</sub> and tórment<sub>N</sub>.

Crucial to my conversion analysis is the fact that Liberman and Prince's stress system can account for the stress patterns in pairs like permit<sub>N,V</sub> and torment<sub>N,V</sub> without deriving one form from the other. For the purposes of the lexicon, then, such forms can have individual lexical entries. The noun and the corresponding verb will be phonologically identical in their underlying representations, stress being added as a part of the productive phonology. Since these forms will be phonologically identical, and semantically related in one of the ways discussed above, they will be related by our  $N \longleftrightarrow V$  redundancy rule in the same way that monomorphemic items like paint<sub>N,V</sub>, etc., are.

The redundancy rule hypothesis also makes the following prediction: since suffixes are lexical terminals listed as members of the N and V category classes, they should exhibit the conversion relation as well, i.e., in some language with this relation, there should be a noun forming suffix X and a phonologically identical (and semantically

related) verb forming suffix X' which are related by the rule. Such conversion pairs of suffixes apparently do exist. Consider the following data from German:

(17)	Deckel	'cover'	deckeln	'cover with a lid'
	Hebel	'lever'	hebeln	'move with a lever'
	Schlüssel	'key, code'	schlüsseln	'encode, encipher'
	Flügel	'wing, vane'	flügeln	'furnish with wings'

The nominal suffix -el has a verbal conversion mate -el (the -n is inflectional, and does not appear in the lexical representation of the verbs). For every noun in -el, there is a corresponding verbal form. Thus, there is no reason why the  $N \longleftrightarrow V$  conversion rule should not relate the nominal -el and the verbal -el suffixes, just as it relates nominal and verbal stems.

German has yet a better example of conversion pairs of suffixes. Note, first of all, that German requires a redundancy rule relating adjectives to verbs, as well as one relating nouns to verbs:

(18)	grün	'green'	grünen	'to make green'
	karg	'stingy'	kargen	'to be stingy'
	starr	'stiff, staring'	starren	'to stiffen, stare'

The first member of each pair is a simple adjective, and the second, a verb. If we postulate an  $A \longleftrightarrow V$  redundancy relation for German, we also predict that there might exist phonologically and semantically related adjective and verb forming suffixes. Such a pair does, in fact occur:

(19)	Ängstig	'afraid'	Ängstigen	'frighten'
	kräftig	'strong'	kräftigen	'strengthen'
	einig	'united'	einigen	'unite'
	gewärtig	'expectant'	gewärtigen	'expect'
	nötig	'necessary'	nötigen	'necessitate'
	nächtig	'dark, gloom.'	nächtigen	'spend the night'
	fertig	'ready, prepared'	fertigen	'make, prepare'
	tätig	'active'	tätigen	'effect'
	mässig	'moderate'	mässigen	'moderate'
	steinig	'stony'	steinigen	'stone'

Thus, we have an adjective forming -ig suffix and a verb forming -ig suffix. Each -ig is listed independently in the permanent lexicon as a member of its own category class, but the two are related by the independently needed  $A \longleftrightarrow V$  conversion relation.

Notice that the redundancy analysis also makes predictions about the 'productivity' of conversion processes. For any given non-complex noun or adjective, i.e., an item which is listed individually in the permanent lexicon, there may or may not exist a verb which is phonologically identical. For example, any particular monomorphemic noun in English may or may not belong to a conversion pair: chair does, but peace does not (i.e., there is no verb peace). It is not predictable from the lexical entry of a given affix whether a corresponding verb will exist, or vice versa. Similarly, it is not predictable from the lexical entry of a given affix whether or not it will belong to a conversion pair. -ize in English is a verbalizing suffix which does not have a conversion mate. But if a nominal or adjectival suffix like -el or -ig in German does have a verbal conversion mate, it ought to be predictable that every complex word



formed from these suffixes should have a conversion mate. This is the case because words derived with these suffixes are the output of the lexical structure component, and are not listed individually in the permanent lexicon. If we require identity of subcategorization for suffixes which belong to conversion pairs, each suffix will have the same potential outputs, and therefore each output in one category class should have a corresponding conversion mate in the other category class. We should therefore never find a case where a suffix X has a conversion mate X' in some category class, but where not all of the outputs of X have conversion mates with the suffix X'. As a concrete example, we should not expect to find adjectives Y-ig in German such that no corresponding verbs Y-igen are possible. As a matter of fact, such seems to be the case for the two examples of suffix conversion illustrated here. All German nouns in -el seem to have corresponding verbs in -el, all adjectives in -ig corresponding verbs in -ig.

However, English seems immediately to offer a number of counter-examples to this claim. Consider the following forms with the suffixes -eer and -ate.

(20) a. -eer with conversion pairs:

sloganeer <sub>N</sub>	sloganeer <sub>V</sub>
mountaineer <sub>N</sub>	mountaineer <sub>V</sub>
engineer <sub>N</sub>	engineer <sub>V</sub>
pioneer <sub>N</sub>	pioneer <sub>V</sub>
electioneer <sub>N</sub>	electioneer <sub>V</sub>
profiteer <sub>N</sub>	profiteer <sub>V</sub>
volunteer <sub>N</sub>	volunteer <sub>V</sub>

b. -eer without conversion

*commandeer <sub>N</sub>	commandeer <sub>V</sub>
buccaneer <sub>N</sub>	*buccaneer <sub>V</sub>
*domineer <sub>N</sub>	domineer <sub>V</sub>
auctioneer <sub>N</sub>	*auctioneer <sub>V</sub>

(21) a. -ate with conversion<sup>5</sup>

associate <sub>N</sub>	associate <sub>V</sub>
affiliate <sub>N</sub>	affiliate <sub>V</sub>
initiate <sub>N</sub>	initiate <sub>V</sub>
deviate <sub>N</sub>	deviate <sub>V</sub>
flagellate <sub>N</sub>	flagellate <sub>V</sub>
estimate <sub>N</sub>	estimate <sub>V</sub>
syndicate <sub>N</sub>	syndicate <sub>V</sub>
delegate <sub>N</sub>	delegate <sub>V</sub>
segregate <sub>N</sub>	segregate <sub>V</sub>

B. -ate without conversion

*appreciate <sub>N</sub>	appreciate <sub>V</sub>
*extricate <sub>N</sub>	extricate <sub>V</sub>
*lubricate <sub>N</sub>	lubricate <sub>V</sub>
*locate <sub>N</sub>	locate <sub>V</sub>
*suffocate <sub>N</sub>	suffocate <sub>V</sub>
*educate <sub>N</sub>	educate <sub>V</sub>
*obfuscate <sub>N</sub>	obfuscate <sub>V</sub>
*demarcate <sub>N</sub>	demarcate <sub>V</sub>
*invalidate <sub>N</sub>	invalidate <sub>V</sub>

These two suffixes seem to go counter to the claim made above, namely that conversion is an all or nothing affair for suffixes (i.e., if a suffix is related to another suffix by conversion, all of its outputs should belong to conversion pairs, and if it does not undergo conversion,

none of its outputs should belong to conversion pairs). With -eer and -ate, conversion pairs exist sporadically and idiosyncratically. The items in (20a) and (21a) seem to be perfectly natural as both nouns and verbs. The (b) items are possible as one or the other, but not both. The redundancy analysis of conversion at first glance seems not to account for these facts.

Notice that -ate and -eer differ from well-behaved suffixes like -ize and -ig in another respect, however. It was argued in Chapter 2 that all lexical entries, roots, stems and affixes alike, come with insertion frames or argument structures indicating the context into which they can be inserted in a syntactic tree. Thus -ize and -ig are verb forming suffixes which have insertion frames just as unanalyzable verb stems do:

- (22)
- |    |       |          |
|----|-------|----------|
| a. | throw | NP__NP   |
| b. | -ize  | NP__(NP) |
| c. | -ig   | NP__NP   |

In the case of -ize and -ig, the claim is that all verbs with these suffixes must have the same insertion frame; the insertion frame is represented only once for the suffix, and not individually for each verb in -ize or -ig, since they do not have entries in the permanent lexicon. This seems to be a correct prediction: verbs like industrialize, demoralize, standardize, eulogize, etc. in English (cf. fn. 3), and Angstigen, tätigen, fertigen, etc. in German all seem to have two argument positions. We might therefore expect all of the verbs formed on -eer and -ate to share the same argument structure, if -eer and -ate are suffixes listed in the permanent lexicon. But this

is not the case; specifically, both suffixes form both transitive and intransitive verbs:

(23)	a.	deviate	NP___(PP)
		defecate	NP___
		duplicate	NP___
		obfuscate	NP___NP
	b.	mountaineer	NP___
		domineer	NP___
		engineer	NP___NP
		volunteer	NP___NP

The affixes -eer and -ate therefore seem to show a convergence of at least two properties which differentiate them from -ize and German -ig. (i) they show idiosyncratic conversion, and (ii) they do not impose uniform insertion frames on their outputs. Also suggestive is that complex words in -ate and -eer seem to be much less compositional in meaning than complex words in -ize and -ig. Both Xize and Xigen usually mean something transparently like "make something X". In contrast, -ate and -eer do not seem to have a transparent meaning which they add to their bases.

All of these properties can be explained simply, however, if we say that -ate and -eer are not suffixes listed in the lexicon at all, but rather that all words ending in -ate and -eer are listed individually. Thus, delegate, deviate, obfuscate, suffocate, mountaineer, engineer, domineer, etc. all have separate entries. If each item is listed separately, each has its own insertion frame. There is therefore no more necessity for deviate and obfuscate to have

the same frame. Similarly, if each form in -ate and -eer is listed separately, each item is independent of all others with respect to its conversion properties. There is no more reason to expect both deviate and suffocate to have conversion mates than there is to expect chair and peace to have conversion mates. Finally, since individual lexical entries have individual semantic representations, there is no reason to attach a fixed meaning to -eer and -ate, and no reason to believe these suffixes to make a set addition to the semantic representations of their bases. The fact that items in -eer and -ate are less consistently compositional in meaning than items in -ize and -ig is thus explained. By claiming that -ate and -eer are not really suffixes in English, we can maintain the claim that suffixes impose uniform insertion frames on their outputs, and that the outputs of suffixes which belong to conversion pairs will uniformly have conversion mates.

#### 6. Diversion on Root and Suffix Allomorphy and Truncation Rules

It may have occurred to the reader that there is an immediate problem with the analysis of forms in -ate presented above. That is, although listing the -ate forms individually allows us to explain their insertion frames, idiosyncratic conversion properties, and semantic representations, it claims, in effect, that these are unanalyzable forms. In a framework in which -ate is an affix, forms like explicate and stimulate are related to forms like explicable, stimulable, and stimulant by virtue of the fact that the affixes -ate, -ant and -able share the same set of bases. But if the -ate forms are unanalyzable, it seems that we have no way of expressing relatedness between forms in -ate and forms in -ant and -able. In this section,

I will show that the framework sketched in Chapter 2 actually does provide us with a way of relating these forms. In order to see this, however, we will first have to make a digression, and discuss what seems to be an unrelated issue in generative morphology, namely, whether or not we should allow rules of truncation and allomorphy in our theory, as was argued in Aronoff (1976).

Aronoff (1976) takes the position that in a generative morphology both the input and the output of word formation rules must be words. Thus, to produce a form nominee, -ee cannot attach to a stem nomin, since nomin is not a word. Instead, -ee, which takes as input verbs (e.g., payee), takes the full word nominate as its base. A further rule of adjustment truncates the morpheme -ate in the presence of the morpheme -ee. Aronoff postulates two sorts of adjustment rules formally distinct from WFRs to maintain his claim that generative morphology is word based: truncation rules like the one for -ee and allomorphy rules. The functioning of such rules is illustrated by Aronoff's analysis of the suffix -ion.

Aronoff claims that the English suffix -ion has a number of different allomorphs:

(24)	realize	realiz	ation
	commune	commun	ion
	resume	resump	tion
	repeat	repet	ition
	resolve	resol	ution

-ation attaches freely both to words like realize and represent and to words in -ate like educate and lubricate. A rule of truncation similar to that for -ee deletes the first -at in the presence of ation for

these latter verbs (educat+ation → education). Latinate roots which end in noncoronals take -tion: resume → resump+tion; deduce → deduc+tion; absorb → absorp+tion, etc. Latinate roots ending in coronals take -ion: rebel → rebell+ion; commune → commun+ion, decide → decis+ion. Aronoff postulates a rule of allomorphy to account for the distribution of the -tion and -ion variants (1976:104):

$$(25) \quad +\text{Ation} \longrightarrow \left\{ \begin{array}{l} +\text{ion} \\ +\text{tion} \end{array} \right\} / X \left\{ \begin{array}{l} +\text{cor} \\ -\text{cor} \end{array} \right\}$$

where  $X \neq \text{cor}$  is one of a set of specified Latinate roots.

Aronoff also argues that there exist a set of allomorphy rules to account for the difference in root between, for example, invert and inversion, adhere and adhesion, permit and permission, decide and decision, etc. That is, some Latinate roots undergo an allomorphy rule in the presence of -ion (the exact form of these need not concern us here). Thus, Aronoff postulates adjustment rules to alter the shape of both roots and affixes.

The affix -ive, in addition, exhibits allomorphy identical to that of -ion. Words which take the -ation allomorph in Aronoff's analysis also take -ative.

(26)	form	formation	formative
	declare	declaration	declarative
	represent	representation	representative

Forms in -ate which take -ation and subsequently undergo truncation of the first -at would presumably take -ative as well:

(27)	evaporate	evaporation	evaporative
	duplicate	duplication	duplicative

Finally, Latinate stems ending in noncoronals which take -tion also take -tive. Latinate stems ending in coronals take -ive as well as -ion:

(28)	a.	deduce	deduction	deductive
		describe	description	descriptive
	b.	decide	decision	decisive
		digest	digestion	digestive

These facts can be expressed within Aronoff's system by collapsing the allomorphy and truncation rules for -ion and -ive in the following way:

(29)	a.	truncation	at $\rightarrow \emptyset / \underline{\quad} \left\{ \begin{array}{l} -ation \\ -ative \end{array} \right\}$
	b.	allomorphy	At $\left\{ \begin{array}{l} ion \\ ive \end{array} \right\} \rightarrow \left\{ \begin{array}{l} \{+ion\} \\ \{+ive\} \\ \{+tion\} \\ \{+tive\} \end{array} \right\} / X \left\{ \begin{array}{l} +cor \\ -cor \end{array} \right\}$

where  $X \propto cor$  is one of a set of specified Latinate roots

One way in which the theory being developed here differs from Aronoff's is that it is not a word based theory; no restriction is placed on word formation such that words can only be derived from other words. Clearly, much of the analysis of Latin presented in Chapter 2 depended upon the assumption that words (e.g., amīcus, monēbam) could be derived from morphemes which were not themselves occurring words (e.g., am, mon). It is therefore possible within this theory to derive a word like nominee directly from a stem nomīn without the mediation of the actually occurring verb form nominate, and therefore without Aronoff's truncation rules. Moreover, this theory already provides the



mechanisms needed for representing allomorphy without requiring the postulation of the distinct class of allomorphy rules that Aronoff needs. At this point, I would therefore like to propose a reanalysis of the  $\left\{ \begin{array}{l} \text{-ion} \\ \text{-ive} \end{array} \right\}$  facts of English within the limits of my theory, to show how facts necessitating allomorphy and truncation rules à la Aronoff will be dealt with here, and to discuss how this reanalysis bears upon the problem with forms in -ate raised above.

Suppose we say that the affixes -ion, -ive, -ant, -able, etc. in English all have invariable forms, and that all allomorphy is confined to stems. Given the organization of the lexicon argued for above, we already have an independently motivated way of representing stem allomorphy: assume that English contains lexical classes just as German and Latin do. These classes differ from those in real inflecting languages like German or Latin only in that they are completely closed, possibly consisting of a single entry, and not exhaustive of all stems in the category class V (i.e., in German or Latin, every verb belongs to some class). They are petrified classes, as it were. These lexical classes will be defined, as always, by morpholexical rules:

- (30) Class a: Xduce  $\sim$  Xduct  
 {(produce, product), (conduce, conduct), (induce, induct), (reduce, reduct),...}
- Class b: Xscribe  $\sim$  Xcript  
 {(prescribe, prescript), (inscribe, inscript), (describe, descript),...}
- Class c: Xmit  $\sim$  Xmis  
 {(permit, permis), (commit, commis), (transmit, transmis),...}

Similarly, we must postulate a lexical class for those items which Aronoff claimed to take the allomorph -ation:

- (31) Class d:  $X \sim Xate$   
 $\{(form, formate), (represent, representate),$   
 $(procrastin, procrastinate), (evapor, evaporate), \dots\}$

Notice that this class subsumes both verbs which in Aronoff's system simply took ation (form, represent), and those that took ation with subsequent truncation of ate (procrastinate, evaporate).

One more obvious point must be dealt with before we begin to explore the ramifications of this proposal: clearly, one member of each ordered pair in lexical classes a-d above is not an independently occurring lexical item. As it stands, however, we have no restrictions built into our lexical entries which would block items such as permis, formate, and evapor from occurring unaccompanied by any affix. I would like to suggest that such restrictions can be stated quite straightforwardly, in fact, in the same way that we stated that Latin stem variants like cip and fic (from capio and facio) are not freely occurring morphemes (cf. Chapter 2). For the Latin cases, I introduced a subcategorization frame which stated that the stems cip, fic, etc. occur only if preceded by a prefix:

- (32)  $\left. \begin{array}{l} cip \\ fic \end{array} \right\} / X [ \_\_\_$

The non-occurring stems in classes a-d can be treated in a similar fashion by giving them subcategorization frames which require a following suffix:

(33)

produce	}	/	_	j	X
prescript					
permis					
formate					
evapor					

(33) states that verb stems like product, prescript, etc., are, in effect, bound morphemes.

Treating allomorphy as membership in lexical classes in English has several desirable results. First, we need only state that -ive and -ion attach to the non-root member of each ordered pair, where root is defined as in Chapter 2. -ant and -able attach to the root morpheme in each pair. This information will be stated as part of the subcategorization frame of these suffixes. All of these mechanisms -- lexical classes, morphological rules, and subcategorization -- have already been shown to be independently necessary devices in a morphology. The formation of words in -ion and -ive therefore receives a much simpler analysis within the framework developed here. Rules of allomorphy and truncation can be dispensed with.

Second, we now have a way of relating forms in -ate to corresponding derived words in -ant and -able, exactly the issue that was raised at the beginning of this section. Verbs in -ate are unanalyzable, and are listed individually in the permanent lexicon, but they belong to a lexical class which is defined by the morphological rule  $X \sim Xate$ . Thus, every individual form Xate is related by morphological rule to the corresponding X which is the base for affixation of -ant and -able.

Third, the analysis presented here makes further predictions which

seem to be borne out by the data. Notice that it claims the following: forms like deduce, produce, reduce, and prescribe, inscribe, and describe are all listed individually, as members of lexical classes (a) and (b) in (30). That is, this analysis claims that the so-called Latinate prefix+stem verbs are not derived from productive prefixes de, con, pre, re, etc. which attach to morphemes duct, scribe, and mit. Listing these forms as members of lexical classes, rather than deriving them in lexical structure accounts for both their relatedness, and the well-known observation that the Latinate roots duct, scribe, etc. have no easily isolable meaning. As an individual listing, each form has its own semantic representation. There is no need for these individual semantic representations to ascribe any fixed meaning to duct, scribe, and mit; they need only represent the meaning of the word as a whole.

Claiming that root allomorphs fall into lexical classes such as those in (30)-(31) also makes a prediction about morphological conversion. Since the two allomorphs of each verb are listed as members of ordered pairs, they have equal status with respect to word formation processes. We might therefore expect that each member of an ordered pair belonging to such a lexical class could have a nominal conversion mate. And since each pair is independent of all other pairs, we might expect them to differ from one another in their conversion properties. Thus, we find as nouns both produce and product. We find also conduct and transcript, but not conduce or transcribe. Neither induce nor induct, inscribe nor inscript have nominal conversion mates. Just as predicted, both members of the ordered pairs in (30) can belong to a conversion pair or either member alone, or neither.

The morphological rule approach therefore allows us to dispense with rules of allomorphy and truncation, to state relatedness between forms in -ate and forms in -ant and -able, and finally to make proper predictions about semantic compositionality and conversion properties.

#### 7. Zero-Affixation: Possible Real Cases

To recapitulate the analysis up to this point, I have argued that phenomena in English and German which have been described as zero-affixation cannot be so analyzed, nor can they be accounted for by any sort of directional morphological rules, at least insofar as their "syntax" or structural aspects are concerned (semantically, it was argued, they may be directional). This argument was based on the fact that the so-called zero affix does not exhibit the properties which are characteristic of overt derivational affixes, and presumably of any directional rules; the so-called zero affix in English and German did not fix its output in a single lexical class, nor did it impose a uniform argument structure on its output, as we would have expected a typical derivational affix to do. Suppose it were the case, however, that we were to find phonologically identical and semantically related pairs  $(X_N, X_V)$  or  $(Y_A, Y_V)$  such that all  $X_N$ s or all  $Y_A$ s behaved as though they were derived by affixation, all  $X_N$ s or  $Y_A$ s belonging to a single uniform lexical class, for example, and having identical argument structures. In such a case, there would be nothing to be gained from a non-directional redundancy analysis: in fact, such cases would be better derived by zero-affixation, or some other sort of directional rule. The point is not that the zero-affixation analysis is a priori undesirable, but rather that an analysis which makes use of

zero-affixation should not be allowed in a well-constrained morphology unless we attribute to the zero affix all and only those properties which we attribute to phonologically non-null affixes.

In fact, there do seem to be phenomena readily apparent in natural languages which are analogous to our hypothetical example above, and which therefore might be counted as genuine cases of zero affixation. For example, supine forms in Latin seem to be zero-derived from participle stems in Latin:

(34)	participle	supine
sedeō	sessum	sessum
admoneō	admonitum	admonitum
flagitō	flagitatum	flagitatum
nubō	nuptum	nuptum
queror	questum	questum
perdō	perditum	perditum

In each case, the supine stem (the supine is an abstract deverbal noun) is identical in form to the participle stem, and in each case, the deverbal noun belongs to the 4th declension. Particularly important is the fact that whatever the allomorphy exhibited by the participial stem, the peculiarities of the participial stem are preserved in the supine stem (cf. Chapter 2 for a discussion of the allomorphy exhibited by participles in Latin). Both the allomorphy facts and the fact that all supines in Latin are fourth declension nouns can be explained by claiming that there exists a zero affix belonging to the same class as underived 4th declension nouns, which attaches to participle stems. Notice that if the supine and the past participle had separate lexical entries and were related by a  $N \leftrightarrow V$  redundancy rule rather than the

noun being directionally derived from the verb, we would have no explanation for the allomorphy facts: if supine and participle have independent entries there is no reason that we should not find examples such as those in (35), rather than the ones we do find in (34):

(35)		participle	supine
	sedeō	sessum	scditum
	nubō	nuptum	nubitum
	admoneō	admonitum	admontum

That is, there should be no apparent connection between the allomorphy in the participle and the allomorphy in the supine. Deriving the noun from the verb in this case allows us to express the uniformity of these forms; the allomorphy of the participle is handled as suggested in Chapter 2, and need only be stated once.

There is a phenomenon in English which is analogous to the Latin facts discussed above, and which therefore would also seem to require a zero affixation analysis. A number of recent works (Freidin (1975), Siegel (1974), Wasow (1977), Allen (1978), Lieber (1979)) have drawn attention to the fact that modern English has both verbal and adjectival passive participles. Examples (36) illustrate participles which are clearly adjectival, and (37) participles which are clearly verbal:

- (36) a. Antarctica is uninhabited  
 b. Joe seemed very annoyed with Sylvia  
 c. Harry wanted me to finish the opened box of PuppyChow before starting the unopened one.
- (37) a. John was considered a fool.  
 b. John was given a book

Participles such as those in (36a,c) occur with negative un-: un- normally attaches only to adjectives. Participles can occur as complements to verbs like seem, become, act, and can occur preceded by the degree modifier very (36b); again, these are characteristics shared with lexical adjectives. Finally, participles appear in prenominal position as in (36c) exactly as adjectives do. In contrast, the participles of the verbs consider and give in (37) must be considered verbal participles, since they occur in a position in which lexical adjectives normally could not occur: \*John was obvious a fool, \*John was sure a book. Adjectives do not otherwise occur in English phrase structure immediately followed by a noun phrase. Therefore, unless we accept an otherwise unnecessary extension of English phrase structure rules to allow adjectival participles to be generated with a following NP, we must accept that considered and given in (37) are verbal participles. Notice, finally, that we also want verbs like consider and give to have adjectival as well as verbal participles to account for phrases such as those in (38):

- (38) a. an unconsidered action  
 b. a recently given talk

That is, we want verbs like consider and give to have both adjectival and verbal participles, just as we would want other verbs (e.g., inhabit, annoy and open) to have both.

Two different analyses are conceivable for the participles in English. One analysis would claim that English participles should be treated in the same way that pairs like paint<sub>N</sub>, paint<sub>V</sub> are, namely by



our non-directional conversion analysis. An alternative analysis would claim that English participles are like the Latin supine, and therefore should be treated with a rule of zero-affixation. Initially, it would seem that English provides us with little evidence for or against either analysis: unlike German or Latin, English has no need for lexical classes determining the ways in which nouns and adjectives are inflected. For example, we have no evidence that participial adjectives belong to either the same or different lexical classes, since there are no lexical classes at all for adjectives in English. The evidence that we do have for deciding between the two analyses is rather indirect, and requires fleshing out both analyses more fully.

The non-directional analysis entails the following: minimally, an affix forming verbal participles has a lexical entry as part of the category class V, and an affix forming adjectival participles has a separate lexical entry in category class A. The adjectival and verbal affixes would be related by an  $A \longleftrightarrow V$  redundancy relation for conversion. In practice, however, a single affix related by  $A \longleftrightarrow V$  will not suffice, as the data in (39) indicate:

(39)	V: sing	participle <sub>A,V</sub> :	sung
	fight		fought
	write		written
	give		given
	consider		considered
	inhabit		inhabited

Some verbs (consider, inhabit) form participles by adding -ed to the verb stem. Within the analysis in question, there would be a lexical entry for -ed<sub>A</sub> and an independent one for -ed<sub>V</sub>, the two being related

by  $A \leftrightarrow V$ . Other verbs form participles by adding -en (write, give); this means that we need another pair of participle forming suffixes -en<sub>A</sub> and -en<sub>V</sub>. Finally, a number of verbs in English (e.g., sing, fight) form participles by means of vocalic ablaut. However this is to be handled in English, our solution requires that the ablauted forms (sung, fought) have lexical entries as both adjectives and verbs, the pairs again being related by  $A \leftrightarrow V$ .

This analysis has an obvious flaw, however: if the adjectival participles and the verbal participles are derived from independent adjectival and verbal suffixes, there is no explanation in this system for the fact that the verbal and adjectival forms are always identical.<sup>6</sup> If the participle forming suffixes have independent entries, we might expect to find numerous cases where a verb, e.g., write, has a verbal participle written but an adjectival participle writed, or vice versa. Alternatively, we would have to build an ad hoc constraint into our system to the effect that whatever means a verb used to form its verbal participle, it also uses to form its adjectival participle.

Such ad hoc constraints can be dispensed with, however, if we accept for English participles an analysis analogous to that proposed above for the Latin supine. Within such an analysis, verbal participles would be derived as other members of the verbal paradigm are derived (cf. discussion of Latin verb paradigms in Chapter 2, and German verb paradigms in Chapter 4). Adjectival participles would then be derived from the verbal participles via zero affixation. If adjectival participles are directionally derived from verbal participles, their formal identity is both predicted and explained. Notice that the zero

affixation analysis also explained the allomorphy facts in the case of the Latin supine forms. What is lacking, in the case of the English participle is the additional evidence we had from lexical class membership in Latin. However, in the absence of contradictory evidence, I will assume that the zero affixation analysis is optimal for the English participles as well.

## CHAPTER 3: FOOTNOTES

1. What constitutes 'semantic relatedness' will be explored below.
2. As argued in Chapter 2, Latin stems like fac and cap (faciō, capiō) have stem variants fic and cip which occur in all prefixed verb forms, but do not occur unprefixed. These stems must have a subcategorization frame which specifies that they must occur with a prefix, but with any prefix. This case is therefore different from the German case here, where a particular stem would have to subcategorize a particular  $\emptyset$  affix.
3. There are a handful of -ize verbs which are intransitive (agonize) or which take that S complements (theorize). These must be listed rather than derived productively with -ize. What my claim about the argument structure of -ize amounts to is that all possible forms coined with -ize will be transitive:
 

e.g. They venutianized the Martians.  
\*They venutianized that John was a Martian.
4. Cf. Aronoff (1979) "Contextuals" for an account of conversion which assumes semantic interpretation of conversion pairs something like that assumed here, within a theory in which conversion is structurally a directional rule. Cf. also Clark and Clark (1979) for a detailed semantic analysis of conversion pairs.
5. Nouns and verbs in -ate are phonologically distinct in that the final vowel is reduced in nouns (-ət), but unreduced in verbs. Presumably, these can be treated on analogy to the permit cases

discussed above: nouns and verbs will be phonologically identical in their lexical entry forms, but the stress rules and concomitant vowel reduction processes will operate differently depending on the category of the -ate form.

6. As far as I know, the only two cases where the adjectival and verbal participles may differ in form are the following: burnt vs. burned, proven vs. proved.

## CHAPTER 4: STRING DEPENDENT WORD FORMATION AND LEXICAL TRANSFORMATIONS

Thus far, I have limited attention to processes of word formation which are appropriate to two levels of generative morphology, namely the permanent lexicon and the lexical structure component. The formal mechanisms of these two subcomponents allow us to account for stem allomorphy, affixational morphology, and morphological conversion in a simple and highly constrained fashion. Such mechanisms, however, do not by themselves characterize all sorts of word formation: early in Chapter 2, I mentioned such string dependent morphological rules as reduplication and umlaut, and stipulated that the model of morphology to be developed here would contain a third subcomponent powerful enough to allow the statement of such rules. The purpose of this chapter is to provide arguments that this third subcomponent is in fact necessary, to explore the properties of the rules it will allow, and to show that these properties follow from the organization of the lexicon already motivated.

I will concentrate primarily on two distinct non-affixational morphological processes: reduplication in Tagalog and umlaut in German. Carrier (1979) has claimed that reduplication in Tagalog must be stated as a transformational word formation rule. I will argue that this analysis is necessary, although with a number of modifications, and that McCarthy's (1979) recent proposal to prohibit transformational power in the lexicon cannot be correct. However, the addition of transformational power to the lexicon will not prove to be a completely undesirable and unmotivated move. Reduplication, in addition to requiring formal statement as a transformational rule, has other properties which

distinguish it from the word formation processes discussed in Chapters 1-3. Reduplication in Tagalog is a pervasive process in that a single formal rule characterizes a large number of seemingly distinct word formation processes; the corollary of this property is that no single semantic representation can be attributed to the reduplication rule itself. Rules of reduplication in Tagalog are often triggered by affixes, and in fact, never change the category of a lexical item unless triggered by an affix. Moreover, as Carrier argues, affixation must always precede reduplication. Finally, although Tagalog reduplication rules must refer to lexical structure in their structural descriptions, they do not themselves build lexical structure. What is rather interesting about this cluster of properties is that it is also found in a word formation rule which is superficially very much unlike reduplication in Tagalog, namely umlaut in German. First, I will propose an analysis of umlaut, and argue for a morphological umlaut rule which cannot be subsumed in either the permanent lexicon or the lexical structure component, although its statement does not require transformational power. What umlaut in German will turn out to have in common with reduplication in Tagalog is simply that both must be stated as string dependent morphological rules. It will be argued that the cluster of properties which the two rules share in fact follows from already motivated constraints on the permanent lexicon and lexical structure subcomponents, together with the string dependent nature of these rules. That is, although it is necessary to allow the increased power of transformational rules within the morphological framework proposed here, it will be possible to place strong constraints on such

rules. If lexical transformations and all string dependent rules are required to have a certain clearly defined set of properties, it will be possible to rule out many conceivable sorts of lexical transformations.

#### 1. On Restricting the Power of Word Formation Rules

McCarthy (1979) argues that morphological processes which seem to involve repetition or reduplication of consonants and/or vowels in Semitic can be accounted for using formal mechanisms which do not require transformational power. Since McCarthy's sort of formal morphology represents the only proposal I know of to date for non-transformational rules of reduplication, I will provide first a brief summary of his proposal, and the general constraint on word formation which he draws from his analysis. I will then attempt to show that McCarthy's constraint is certainly too strong with respect to rules of reduplication in Tagalog, and is perhaps even too strong for certain cases in Semitic.

McCarthy's analysis of Semitic morphology makes use of the principles of autosegmental phonology which allow reference within phonological theory to levels of phonological representation or tiers other than the surface segmental representation of a string. Every unit represented on one level must be associated with at least one unit on another level, and lines of association may not cross. McCarthy extends autosegmental theory to allow morphemes, entities presumably having some semantic representation and dominated by a node labelled  $\mathcal{N}$ , to constitute separate autosegmental tiers and to be associated with what he calls a prosodic template, or "the level on



which gross distribution of consonants and vowels is stated" (p. 232). The word in Semitic therefore consists of what McCarthy calls a consonantal melody -- e.g., ktb 'write', -- and a vocalic melody -- e.g., a 'perfective active' -- which are mapped into a highly constrained set of prosodic templates. Each template represents a conjugation, or 'binyan' in the terminology of Hebrew grammarians; in each binyan, the meaning of the verbal stem, or its argument structure is modified in some way. For example, an Arabic first binyan verb katab means simply 'write'. The second binyan verb formed from the same root ktb is kattab which means 'cause to write'. The templates in (1) abbreviate all and only the occurring prosodic templates needed for Arabic (McCarthy p. 246):

- (1) a. CV((CV)[+seg])CVC  
 b. CCV([+seg])CVC

The mapping between consonantal roots, vocalic roots and the templates shown in (1) is straightforward when the number of consonants and vowels in each morpheme is equivalent to the number of consonants and vowels in the template. This is the case at least for the consonants in (2):

(2)

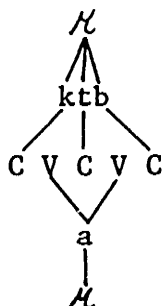

The cases which are most interesting for our purposes here, however,

are those in which, for example, there are more consonantal slots in the template than there are consonants in the root. In the ninth and eleventh binyanim, McCarthy provides the prosodic templates in (3):

- (3) a. IX CCVCVC  
 b. XI CCVVCVC

McCarthy argues that in the most general case consonants are associated with slots in a template from left to right. In order to produce an autosegmentally well-formed structure, a rightmost consonant will associate with more than one slot in the template if there are fewer consonants than consonantal slots.<sup>1</sup> Lines of association may therefore spread to form a one-to-many mapping between a morpheme and a prosodic template:

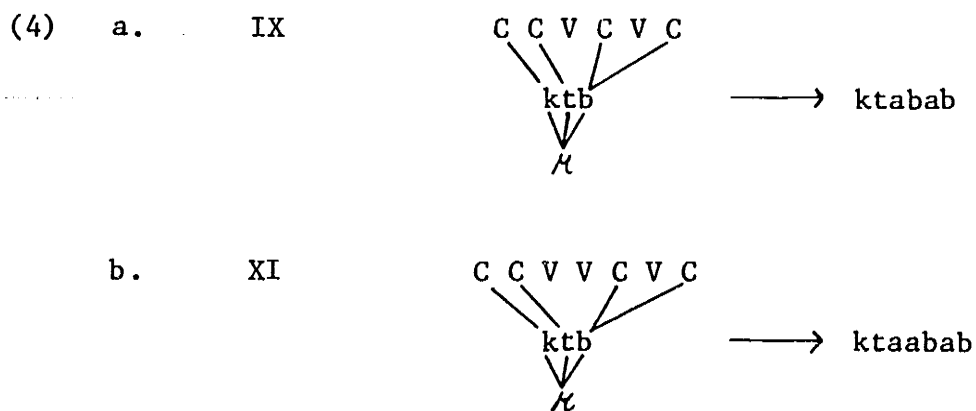

The result of this spreading of lines of association is what appears to be reduplication within the segmental string: the final C of an Arabic triliteral root, and the final vowel of the vocalic melody will be repeated by these autosegmental processes to create a morphologically complex form.

According to McCarthy, reduplication must be allowed to occur in

another way as well: in some cases, an entire root morpheme can be repeated, and the doubled root then associated with the prosodic template in the normal way. For example, Hebrew has a number of biliteral roots, e.g., gl 'roll', which occurs in one binyan as gilgel 'to roll (trans.)'. The appropriate template is CVCCVC, and the form is represented autosegmentally as in (5):

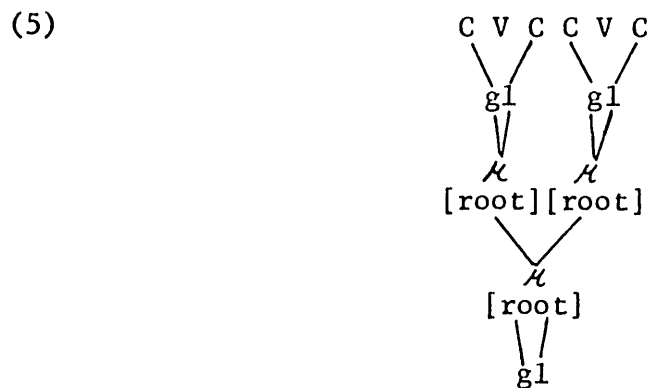

What is reduplicated here is the biliteral root, rather than a single segment of the root. McCarthy also provides arguments that syllables can be reduplicated: a syllable constitutes a discrete metrical constituent which can be mapped into a two-syllable representation, which is in turn mapped normally onto a prosodic template. McCarthy gives as an example of this sort of reduplication the following case, where the consonant melody is shr:

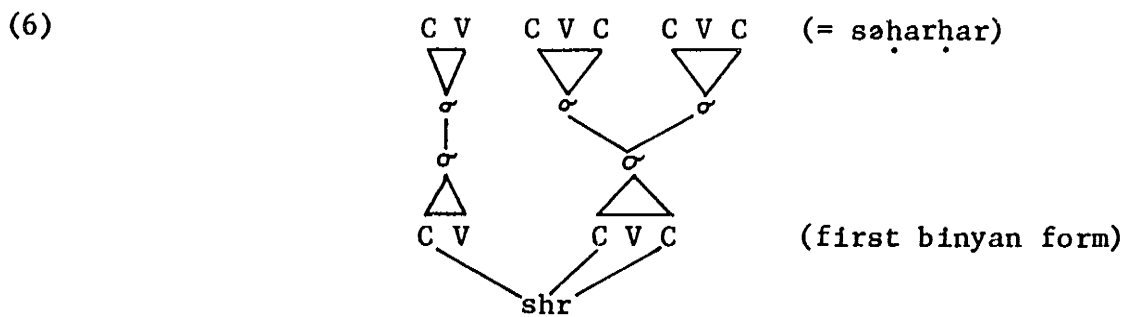

In other words, reduplication in McCarthy's framework is a byproduct of independently motivated principles of association of autosegmental tiers. Associations can occur directly between consonant and vowel melodies and the prosodic templates, or between different layers of metrical structure, including the layers at which morphemes ( $\mathcal{H}$ ) or syllables ( $\sigma$ ) are represented.

On the basis of this autosegmental analysis of Semitic, McCarthy proposes a strong constraint on word formation rules in general:

(7) Morphological Transformation Prohibition (MTP):

All morphological rules are of the form  $A \rightarrow B/X$ , where A, B and X are (possibly null) strings of elements. That is, morphological rules must be context-sensitive rewrite rules, and no richer rule type is permitted in the morphology (p. 357-8).

Such a restriction on morphological theory is a priori rather desirable. Unconstrained, morphological transformations have the power to form words by permuting the first and last consonant of a string, reversing the order of segments, or deleting every other segment, possibilities which presumably never occur in natural languages. McCarthy's prohibition automatically rules out such possible but non-occurring operations. But ruling out transformational power in the lexicon also rules out the sort of statement for reduplication rules we are most familiar with. Apparently, our alternative within McCarthy's framework is to reanalyze all rules of reduplication using autosegmental means.

Consider what this would mean for a language with reduplication

rules such as those in Tagalog, however. Carrier's first approximation to the statement of the three reduplication rules is illustrated in (8):<sup>2</sup>

- (8) a. R1  $\left[ \begin{array}{c} \text{stem} \\ \text{C V} \end{array} \right]$   
 $1,2 \xrightarrow{2} 1 \text{ -lg, } 1, 2$   
 e.g. (um)-lākad  $\xrightarrow{\quad}$  pag-la-lākad  
 '(ST)-walk' 'walking' (gerund)
- b. RA  $\left[ \begin{array}{c} \text{stem} \\ \text{C V} \end{array} \right]$   
 $1,2 \xrightarrow{2} 1 \text{ +lg } 1 \ 2$   
 e.g. mag-linis  $\xrightarrow{\quad}$  mag-lī-linis  
 'ST-clean' 'ST-will clean'
- c. R2  $\left[ \begin{array}{c} \text{stem} \\ \text{C V C}_o \text{ V (C+) X} \end{array} \right]$   
 $\underbrace{1, 2} \quad 3 \quad 4 \xrightarrow{2} 1 \text{ +lg } 3 \ 1 \ 2 \ 3 \ 4$   
 e.g. mag-linis  $\xrightarrow{\quad}$  mag-līnis-linis  
 'ST-clean' 'ST-clean a little'

R1 Reduplication copies the first consonant and vowel of the stem, making the copy vowel short. RA is similar to R1, except that the copy vowel is invariably long. R2 copies the first syllable of a word, and at least part of the second syllable. (If the second syllable ends with a C, that C is copied only if it is stem final or part of a suffix; in trisyllabic stems, a syllable final C is not copied by R2.)

It is not clear that the sort of reduplication facts which Carrier discusses can be easily fit into an autosegmental mold. Consider what we would have to do to analyze Tagalog reduplication in the way that McCarthy analyzes most of the reduplication facts of Semitic. As a first approximation, let us say that Tagalog, like Semitic, has a set of prosodic templates, or permissible arrays of consonants and vowels

onto which morphemes would be mapped. Tagalog might then have a template such as that in (9), allowing long sequences of open and closed syllables:

(9) [C V (C)]\*

The asterisk in (9) indicates that any number of CVC<sub>0</sub> sequences can be repeated to form Tagalog prosodic templates. Morphemes, such as the verb stem sulat 'write' would be mapped onto templates in the same way that morphemes are mapped onto templates in Semitic:

(10)

Presumably, to form a reduplicated form of this verb stem, we would first associate the stem sulat with a reduplicative template, i.e., one with one more CV than the stem (for Rl and RA):

(11)

Since reduplication seems to copy a sequence of consonants and vowels on the lefthand side of the word in Tagalog, we might start out by assuming that consonants and vowels in a morpheme are associated with slots in a template from right to left, rather than the left to right association needed for Semitic. This would give us the partial association in (12):

(12)

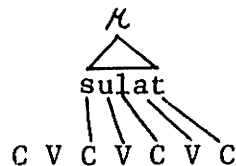

Following this, we must assume McCarthy's principle of spreading association lines takes over to fill in the slots in the template which are unassociated at this point:

(13)

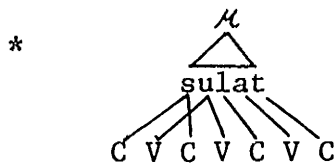

However, as (13) illustrates, the normal process of spreading would always result in a crossing of association lines, a state of affairs which is automatically ruled out by general principles of autosegmental theory. That is, assuming a root like sulat to be a morpheme or  $\mathcal{M}$  constituent in McCarthy's sense, makes it impossible to characterize reduplication in Tagalog as an automatic spreading of autosegmental association lines.

Since the normal means of accomplishing reduplication within McCarthy's framework, the spreading of association lines, is closed to us, we must attempt to recast reduplication in Tagalog as a doubling of some metrical constituent (i.e., treat Tagalog in the same way that McCarthy treated the gilgel and səharhar cases in Semitic). It is clear, first of all, that reduplication in Tagalog cannot be stated as doubling of a syllable. For R1 and RA, the first CV of a stem is copied whether or not it is a syllable. For example, R1 applies to a stem with a closed first syllable, kandīlah 'candle', to give the form

pag-ka-kandīlah 'candle vendor'. The first CV of this form does not even constitute a sub-constituent of the first syllable kan: k is the syllabic onset. a is the syllabic nucleus, which, according to most theories of the syllable (Halle, classnotes) forms a constituent with the coda (i.e., the nucleus and coda together make up the syllabic rime), but not with the onset.

The only other autosegmental alternative for Tagalog reduplication would be to consider reduplication to be a doubling of morphemes. This option is, in fact, possible for Tagalog, as Marantz (1980) has shown. If we assume (i) that the whole verb stem is doubled in Tagalog reduplication, (ii) that segments of the original (rightmost) morpheme are associated with the prosodic template from right to left, (iii) that segments of the copied (leftmost) stem are associated to the remaining template slots from left to right, and (iv) that extra, unassociated segments in the morpheme melody are deleted, we can produce the following autosegmental derivation for a reduplicated form like susulat:

- (14)      a.      sulat      →      b.      sulat sulat
- C V C V C V C                                      C V C V C V C
- c.                                      sulat sulat
- C V C V C V C
- d.                                      sulat sulat
- C V C V C V C
- e.                                      su sulat
- C V C V C V C



Such a solution works mechanically for Tagalog, and remains well within the spirit of McCarthy's solution for the gilgel and səharḥar cases in Semitic. However, it is questionable whether this solution really allows us to do without transformational power in our morphology, as McCarthy claims it does. Unlike the normal Semitic cases where spreading of association lines accounts for the repeated Cs and Vs, in these cases, there must be some extra mechanism within the morphology to copy segments belonging to the doubled morpheme, syllable or other metrical constituent in question. The need for such a mechanism is hidden in McCarthy's discussion, and also within Marantz's adaptation of it to Tagalog. In making this mechanism explicit, it appears to me that some sort of transformational power will inevitably be necessary: while an indefinitely long prosodic template can be generated by the schema in (9), some rule must make reference to the segments in the morpheme melody, specify that each must be repeated, and in the order in which they occur in the original. Once we have admitted this hidden need for a transformation copying whole morphemes, we can see that McCarthy's Morphological Transformation Prohibition is too strong, both for Tagalog, and for the Semitic gilgel and səharḥar cases.

Marantz (1980) pursues the idea of constraining morphological transformations through a version of the autosegmental approach (e.g., transformations can copy entire morphemes, but not subparts of morphemes). Here, I would like to pursue the idea that lexical transformations can be constrained in other ways as well. For the purposes of the following discussion, I will drop the autosegmental framework, and adopt a more traditional segmental representation of

reduplication. Nothing important hinges on the formal statement of the rule, as long as it is agreed that some sort of reduplication transformation dependent upon the segmental nature of strings is necessary.

## 2. Reduplication as a Transformation

As mentioned above, I would like to argue here that if reduplication in Tagalog must be formulated as a lexical transformation<sup>3</sup> (whether in an autosegmental framework or not), lexical transformations of only a highly constrained sort need be permitted. The logic of my argument will be as follows. In 2.1., I will present Carrier's statement of the reduplication rules of Tagalog and discuss the array of properties which seem to cluster around those rules; these properties will prove to be rather unlike the properties of affixational morphology we have discussed above. I should point out here that Carrier's theoretical framework differs from the one developed here in a number of respects. For example, she does not presuppose the sort of lexical structure component in which morphemes are inserted into tree structures subject to subcategorization restrictions. Instead, Carrier accepts a basically Aronovian sort of morphology where morphemes are concatenated by means of word formation rules (cf. Chapter 1). Where the differences between our frameworks are unimportant, I will preserve Carrier's presentation of the facts. However, at certain points I will modify the description to be consistent with my framework. These modifications will eventually lead to some insight into the properties to be discussed. In particular, 2.2. will focus on a particular property which Carrier ascribes to Tagalog reduplication rules: in order to state the proper

environment for reduplication rules, Carrier allows the use of variables as well as the use of transformational notation. I will propose a reanalysis of Carrier's material in which reduplication is a strictly local operation; the added power of variables will not be necessary, given independently motivated features of my framework. The point of this lengthy summary and refinement of Carrier's work will become apparent later in this chapter: although we need to increase the power of our morphology by introducing a third subcomponent of morphological rules and permitting lexical transformations, we will see that the properties which cluster around Tagalog reduplication rules are in fact shared by other string dependent but non-transformational morphological rules. The final part of this chapter will be devoted to exploring why this group of properties should be displayed by string dependent rules, and to proposing constraints on such rules.

### 2.1. Properties of Reduplication

Assume, for the moment, the simplified version of the reduplication rules in (8). What properties do these rules have? First, Carrier argues convincingly that there are only three rules of reduplication in Tagalog, although each of these rules appears repeatedly in a variety of word formation processes. R1 is used to form, among other things, gerunds from verb stems, to pluralize comparative adjectives formed with the prefix ka+sing, and with the prefix mang-, to form occupational nouns from verbs:

## (15) R1 Reduplication

a. gerunds

(um)-lākad → pag-la-lākad  
 'ST-walk' 'walking' (gerund)

(um)-sunod → pag-su-sunod  
 'ST-obey' 'obeying'

b. plural comparative adjectives

ka+sing-talino → ka+sing-ta-talino  
 'as intelligent as (sg.)' 'as intelligent as (pl.)'

c. occupational nouns

(um)-tahi? → mang-tahi?<sup>4</sup> → ma-nahi? → mananahi?  
 'seamstress'

Similarly, *ka* is used in a variety of word formation processes. In (16a), RA marks aspect on a verb stem, resulting in a future reading, and in (16b), RA applies to a noun or verb stem to which the affix na+ka has also attached to form causative adjectives:

## (16) RA Reduplication

a. aspect

mag-linis → mag-lī-linis  
 'ST-clean' 'ST-will clean'

(um)-takboh → (um)-tā-takboh  
 '(ST)-run' 'ST-will run'

b. causative adjectives

?antok → na+ka-?antok → nakāka?antok  
 'sleepiness' 'causing sleepiness'

And finally, R2 appears in a number of kinds of derived words. Intensive verbs are formed by R2, as well as moderate verbs:

(17) a. moderative verbs

mag-linis	→	mag-līnis-linis
'ST-clean'		'ST-clean a little'

mag-walis	→	mag-wālis-walis
'ST-sweep'		'ST-sweep a little'

b. intensive verbs

mag-sugat	→	(mag-)ka-sūgat-sugat
'ST-have wounds'		'be thoroughly covered with wounds'

Reduplication rules in Tagalog therefore have the property of being pervasive -- i.e., of appearing in the same form over and over again with different 'functions', as it were. Of course, we could consider each of the uses of these three reduplication rules to constitute a separate word formation process, but to do so would amount to a claim that it is accidental that the same three reduplication patterns occur repeatedly. Many other conceivable types of reduplication could appear, one for each unique word formation process, but this logically possible state of affairs does not occur. By separating the three reduplication rules from the particular word formation processes that utilize them, Carrier captures the generalization that these are the only possible patterns.

Within the framework developed here, separating the statement of reduplication rules from the word formation processes that utilize them means that reduplication has another unique property. Normally, in affixing-type morphology, a morphological unit -- stem or affix -- is associated with some sort of unique semantic representation. The affix mag-, for example, is a ST affix, and therefore is associated with an appropriate semantic representation in its lexical entry. Some

affixes have several homophonous forms: that is, a single phonological sequence may be associated with more than one unique semantic representation -- e.g., -in and -an in Tagalog are both OT and IOT affixes for different verbs. Presumably, in such cases we simply have more than one lexical entry for each affix, each lexical entry having its own distinct semantic representation. Tagalog reduplication rules cannot be said to have this property. The examples in (15)-(17) clearly show that R1, RA, and R2 cannot be assigned a single unique semantic representation, since each occurs in a number of distinct word formation processes. Neither can we treat these three rules as if they were analogous to homophonous morphemes like -in and -an: unlike these morphemes, the reduplication rules can only be interpreted in conjunction with other features of lexical structure. R1 is interpreted as 'plural' only in a word with the adjective prefix ka+sing-, as 'occupational' only in conjunction with the prefix mang-. RA is interpreted as one verbal aspect or another depending upon the prefix occurring on the verb (cf. below); it is interpreted as causative only together with the prefix na+ka. It would be impossible to assign these rules even several semantic representations without mentioning the presence of the prefix forms in these representations -- something which is apparently never necessary in the semantic representations of morphemes (e.g., there exists no morpheme that I know of which requires a semantic representation indicating that the morpheme in question has a given interpretation only in the presence of another morpheme. Instead, it might be better to assume here that the rules of reduplication have no semantic representation(s) of their own, that they are by themselves

'semantically neutral' in some sense, and that there exist independent rules of interpretation in our autonomous semantic component which scan a word for some combination of affix plus reduplication, assigning a meaning on the basis of these mutually dependent and discontinuous aspects of lexical structure.

Further, Carrier points out that reduplication rules may not need to create morphological structure in the same way that affixational morphology creates structure. Since Carrier is working within a basically Aronovian type morphology, which lacks the constraints on lexical structure proposed above, it is formally possible to add new brackets around reduplicated segments. The actual motivation for doing so is by no means obvious, however:

There are cases where it appears that reduplication actually has to go inside already attached affixes to do its work. For example, comparative adjectives formed with the prefix ka+sing can be pluralized by R1-reduplicating the stem. The reduplicated syllable has to be inserted inside the already affixed ka+sing. Given the standard assumptions about the bracketing of derived words, it is not clear how the derived word is to be bracketed. ...

(16) [<sub>A</sub>(ka)+sing [<sub>A</sub> talīnoh]] → [<sub>A</sub> (ka)+sing [<sub>?</sub>ta[<sub>A</sub> talīnoh]]]  
 'as intelligent as (sg.)'      'as intelligent as (pl.)'

As far as I can tell from Carrier's work, no word formation rule in Tagalog has to refer to a bracket created by reduplication, i.e., to the constituent [ta], as opposed to the bracket around the reduplicated stem as a whole (i.e., [tatalīnoh]). We might say of Tagalog reduplication, then, that it has the property of being structure

preserving, in spite of the formal possibility within Carrier's theory of having structure building lexical transformations.

Reduplication in Tagalog has another property which distinguishes it from other word formation processes we have looked at so far. Rules of reduplication in Tagalog must often apply in conjunction with the affixation of some morpheme. So occupational nouns are formed by affixing mang- and R1 reduplicating the verb stem, and causative adjectives by affixing na+ka to a noun or verb stem and RA reduplicating. In some sense, the word formation processes involving reduplication are often two-part word formation processes: neither the affix nor the reduplication alone produces an occupational noun or a causative adjective. Moreover, Carrier also argues that reduplication rules must often apply after affixation (it is logically possible, within Carrier's theory, that both parts of the word formation process apply at once):

Finally, there are word formations which involve both affixation and reduplication in which the affixed material itself can be reduplicated and therefore attached before reduplication. For example, causative adjectives are formed by adding na+ka and an RA copy to a noun or verb stem. RA can apply to reduplicate the newly added ka

25. [<sub>N</sub> ?antok]<sub>N</sub> → [<sub>A</sub> na+ka[?antok]] — nakāka?antok  
                   'sleepiness'    'causing sleepiness'

(1979:201)

Even more striking cases of this phenomenon can be found: in the presence of a topic marker, a verb stem can be RA reduplicated to change the aspect of the verb form (cf. below). In complex derived verb stems,



the presence of a topic marker as the outermost constituent of a word can apparently condition RA reduplication deep inside a word:

ma-?i-pag-?abut → ma-?i-pag-?ã?abut. This 'long distance' property of reduplication will be discussed extensively in §2.2. For now, suffice it to say that Tagalog reduplication has the property that it can be triggered by the presence of a previously affixed morpheme.

Rules of reduplication in Tagalog also seem to have the property that they do not, by themselves, trigger a change of category on their base forms. Reduplication rules which apply in conjunction with affixation (i.e., are triggered by affixes), may change category, but the more common state of affairs is that the lexical item derived by reduplication alone preserves the same category as its base. So the reduplication processes illustrated in (15)-(17) are typical: reduplication can form intensive or moderative verbs from verb stems, plural nouns or adjectives from noun and adjective stems, and so on. Accompanied by affixation, reduplication processes can, for example, form nouns from verbs. However, there is no example in Carrier's work which suggests that reduplication alone can form nouns from verbs or nouns from adjectives, and so on.

## 2.2. The Locality of Reduplication

Above, I pointed out that reduplication rules in Tagalog do not seem to create structure. Carrier devotes a good deal of discussion, however, to arguing that reduplication must refer to already existing structure, i.e., to the internal bracketing of words, to be stated properly. In fact, a large part of Carrier's work focusses on the question of how the reduplication rule should be stated. In the course

of this discussion, Carrier motivates an internal structure for complex words in Tagalog. I will first summarize Carrier's findings, and then present the set of facts which makes the formal statement of Tagalog reduplication rules an interesting and theoretically important question. The basic problem I will be dealing with is this: it is often the case that in a given verb form, reduplication can apply at more than one place in the lexical string, with no difference in meaning. However, reduplication never applies more than once in any given form, even if its environment is met in several places. These facts forced Carrier to introduce the use of variables into lexical transformations, thereby implying that reduplication has the property of non-locality, or unboundedness. I will argue instead that within the framework developed here, reduplication can be stated without the use of variables: Tagalog reduplication rules are therefore strictly local rules.

Tagalog verbs consist minimally of a verb stem to which is affixed a topic marker, an affix which specifies the noun in the verbal diathesis (e.g., subject, object, indirect object) which is being focussed in the sentence. So lagay 'put' is a verbal stem which takes as a subject topic marker the prefix mag- (mag-lagay), as an object topic marker the suffix -in (lagay-in), and as an indirect object marker the suffix -an (lagay-an). The array of topic markers required of a given verb stem is more or less arbitrary, and must therefore be represented in the lexical entry for each stem. Carrier proposes that topic-marked verbs have the internal structure illustrated in (18):

- (18) a.  $[_V, \text{mag } [_V \text{ lagay}]_V ]_V$   
 b.  $[_V, [_V \text{ lagay}]_V \text{ in}]_V$

c.  $[_{V'} [_V \text{lagay}]_V \text{an}]_{V'}$

The motivation for distinguishing two different layers of verb structure is first that topic-marked verbs are words; they occur freely in sentences as independent lexical items. Verb stems are not independently occurring words. Carrier captures this distinction with the stipulation that only derived verbs contained in V' brackets can undergo lexical insertion into syntactic base structures. Carrier also bases the distinction between V and V' bracketing on another factor, however. Only V' affixes can trigger reduplication. To make clear the connection between V' affixes and reduplication, I will concentrate in the following discussion on a single word formation process, namely Aspectual RA reduplication.

Any Tagalog verb can undergo Aspectual RA reduplication: the particular aspectual interpretation ascribed to RA reduplication, however, is dependent upon the nature of the topic marker of the verb. First of all, an RA reduplicated verb stem without topic marker receives no aspectual interpretation at all, a fact which leads Carrier to argue that RA is triggered only by the presence of a topic affix. The particular shape of the topic marker, together with the presence or absence of RA yield an aspect interpretation for the verb. Neither alone has a fixed interpretation. The possible joint interpretations are represented schematically in (19), which is adapted from Carrier (1979:345):

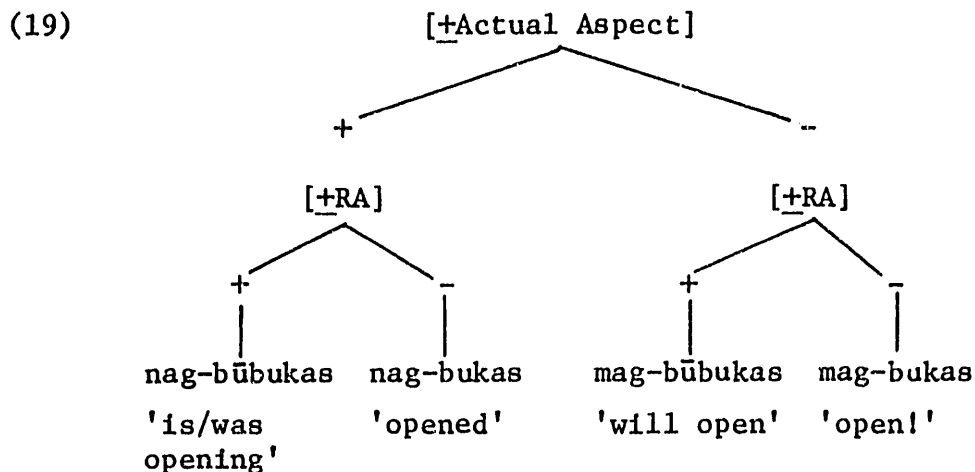

[+Actual] aspect generally subsumes an action which has begun, and is indicated by the n-initial form of the subject topic marker in this case.<sup>5</sup> [-Actual] aspect, indicated by the m-initial form of the subject topic affix, generally covers actions which have not yet started. Within this general division, however, verbs which are both [+Actual] and [+RA] are imperfective, verbs which are [+Actual] and [-RA] are perfective. [-Actual] verbs which are also [+RA] are interpreted as future, and finally [-Actual], [-RA] as imperative.

With respect to verbs with the simple structure of those in (18), the application of RA reduplication is quite straightforward; in the presence of a topic marker, RA reduplication locates the first CV following the topic marker, and reduplicates. Thus, Carrier gives a preliminary version of RA as follows (1979:241):

(20) RA (preliminary)

```

[V', (TM)  C V
           ⏟
           copy
  
```

Through a variety of word formation processes (the exact nature of which need not concern us here), however, verbs with rather complex

layerings of V and V' bracketings are built up. Both V and V' forms can be the input to further word formation:

- (21) a.  $[_{V'} \text{ ?i } [_{V'} \text{ pag } [_{V'} \text{ bilih}]_{V'}]_{V'}]_{V'}$   
 b.  $[_{V'} \text{ ma } [_{V'} \text{ ?i } [_{V'} \text{ pag } [_{V'} \text{ linis}]_{V'}]_{V'}]_{V'}]_{V'}$

Perhaps the most interesting and remarkable fact about reduplication in Tagalog only emerges in an examination of the application of RA to complex forms like these. The future forms of these verbs can be derived by RA reduplication, but neither form has a unique future representation. Instead, any of the following possibilities can occur:

- (22) a.  $\text{?ipāpagbilih}$  'DOT-will sell'  
 $\text{?pagbībilih}$   
 b.  $\text{ma?ī?ipaglinis}$   
 $\text{ma?ipāpaglinis}$  'will manage to clean for'  
 $\text{ma?ipaglīlinis}$

What do not occur are forms in which reduplication has occurred more than once:

- (23)  $*\text{?ipāpagbībilih}$   
 $*\text{ma?ī?ipāpaglinis}$   
 $*\text{ma?ipāpaglīlinis}$   
 $*\text{ma?ī?ipāpaglīlinis}$

In other words, in a complex verb containing more than one V' affix, reduplication can start at any point after a V' affix, but only once

within a word -- i.e., RA chooses one V' affix in a word and copies the first CV after that affix. Carrier considers a number of possible analyses for this phenomenon, but finally decides on (24) as the proper formulation of the rule:<sup>6</sup>

(24) a. +RA Attachment

$$\#\#[_{V'} \dots \longrightarrow \#\#+RA[_{V'} \dots$$

b. RA Reduplication

$$\begin{array}{ccccccc} \#\#+RA & X & [_{V'} & (TM) & C & V & Y \\ & \underbrace{\hspace{1.5cm}} & & & & & \\ & 1 & & 2 & 3 & 4 & \longrightarrow & 1 & 2 & \overset{3}{+lg} & 2 & 3 & 4 \end{array}$$

(24a) is a word formation rule that optionally attaches an abstract triggering feature [+RA] to the outside of a word. RA reduplication applies only once, at word level, and analyzes a string, looking for a V' affix anywhere in the word, no matter how deeply embedded. The use of the variable allows alternative analyses depending upon how many V' affixes occur in a string, and the stipulated word level application accounts for the "once only" character of RA.

Carrier's solution to this reduplication problem, although it works mechanically, has a number of unattractive properties. First, it requires the introduction of the variable into our repertoire of devices available to word formation, and this adds unwanted power to our morphology: this criticism is especially important in light of the fact that no rules of Tagalog other than reduplication, and no word formation processes that I have encountered outside of Tagalog require such unbounded operations. Other word formation processes,

both affixational and non-affixational are local. And connected with this problem, Carrier herself points out that an unbounded formulation of reduplication requires a violation of the Adjacency condition (Siegel 1977, Allen 1978):

(25)        ##+RA [<sub>V</sub>, ?t [<sub>V</sub>, pag [<sub>V</sub> bilih]]]

The statement of RA using a variable allows us to relate morphological elements, and to perform an operation over an indefinite number of intervening brackets. The Adjacency Condition prohibits word formation processes from "looking" more than one bracket down in a complex word. Finally, Carrier's solution gives no insight into why it should be the case that reduplication can only apply once; rule (24) is an adequate description of the facts, but falls short of explanation.

At this point, I would like to propose that the formal mechanisms already motivated within my framework of morphology will allow us to develop a more explanatory solution to the Tagalog "anywhere, but only once" problem. Principles of lexical structure discussed in Chapter 2, together with an independently needed condition on morphological rules will interact to give all and only the possible reduplicated forms of Tagalog.

Suppose, to begin with, we assume the system of lexical structure with the sorts of lexical entries, unlabeled trees, lexical insertion, and feature percolation mechanisms motivated earlier for English, German, and Latin. What we then must say about Tagalog is that all of the affixes which Carrier calls V' affixes bear an abstract diacritic feature [+RA], whereas morphemes which Carrier calls V morphemes (e.g.,

verb stems) lack this feature entirely. In terms of the feature matrices associated with categories that I discussed in Chapter 2, this means that the matrix of a V' node differs from the matrix of a V node in that the former has a "slot" for the feature [+RA], and the latter lacks this slot entirely. The feature matrices for both V and V' morphemes, however, will have a slot for another feature, which we will call [+Aspect 2]. (This, in fact, is the term Carrier uses to distinguish the aspect triggered by RA from the [+Actual] aspect indicated by choice of topic marker.) The reason for introducing two features into verb matrices will become apparent shortly.

Let us say, further, that topic marker or V' morphemes must be inserted into lexical trees bearing, at random, either the + or - value of the RA feature. The feature [Aspect 2] will not be inherently specified as + or - for any morpheme, however: instead, each morpheme in Tagalog will be inherently [ $\emptyset$  Aspect 2]. The two rules which we then need to account for the aspectual RA phenomena are the following:

(26) Aspect 2 Rule

$$[\emptyset \text{ Aspect 2}] \longrightarrow [+ \text{Aspect 2}] / [+ \text{RA}]$$

(27) RA Reduplication

$$\begin{array}{cccc} [+ \text{RA}] & & [ \text{C V X} & \\ \underbrace{\hspace{1.5cm}} & & & \\ 1 & 2 & 3 & 4 \end{array} \longrightarrow \begin{array}{cccc} & & 3 & \\ 1 & 2 & + \text{lg} & 2 & 3 & 4 \end{array}$$

The Aspect 2 Rule simply adds the + value to the [Aspect 2] feature if it occurs in a matrix with a [+RA] feature. RA is stated locally: it locates any [+RA] feature, and starts copying at the nearest left bracket. Consider the possible derivations for a simple subject topic



verb mag-bigay. If mag- is a [+RA]V' affix, we start out with the underlying structure in (28):

(28)

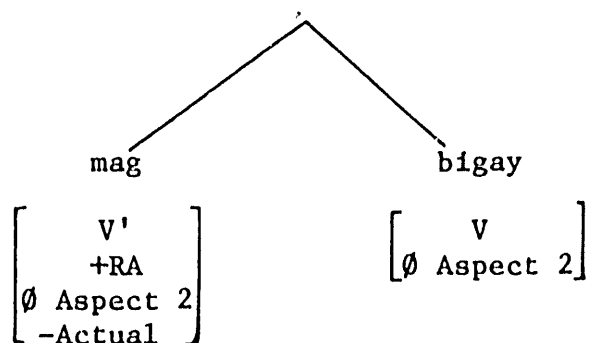

By our independently motivated feature percolation mechanisms, we get the following intermediate structure:

(29)

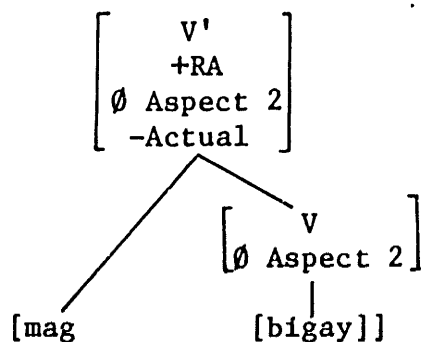

Rule (26) then applies to give the feature value [+Aspect 2], and RA reduplication applies as illustrated in (30):

(30)

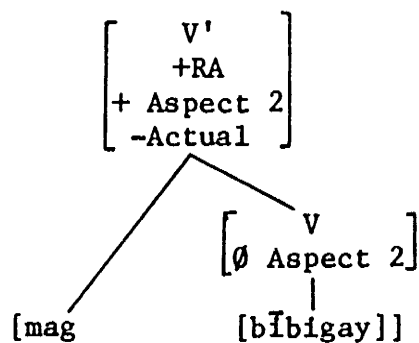

We might assume that there is a semantic interpretation rule in our

autonomous semantic component which reads the features [-Actual, +Aspect 2] off the highest nodes of Tagalog verbs, and produces the future interpretation that results from this particular conjunction of features. Notice that if mag- had been [-RA] in this derivation, neither rule (26) nor rule (27) would have applied, and the aspect interpretation of the verb would have been imperative, rather than future.

Consider now the possible derivations for a more complex form [<sub>V</sub>, ?i [<sub>V</sub>, pag [<sub>V</sub> bilih]]]. Since this form has two V' affixes, either of which can be [+RA] or [-RA], there are four separate underlying structures:

- (31) a. [<sub>V</sub>, ?i [<sub>V</sub>, pag [<sub>V</sub> bilih]]]  
           -RA       -RA
- b. [<sub>V</sub>, ?i [<sub>V</sub>, pag [<sub>V</sub> bilih]]]  
           +RA       -RA
- c. [<sub>V</sub>, ?i [<sub>V</sub>, pag [<sub>V</sub> bilih]]]  
           -RA       +RA
- d. [<sub>V</sub>, ?i [<sub>V</sub>, pag [<sub>V</sub> bilih]]]  
           +RA       +RA

Case (31a) is of no intrinsic interest, since it does not involve reduplication at all; this form of the verb will receive the imperative interpretation, and no more need be said about it here. (31b) will have the derivation mapped out in (32):

## (32) a. Feature Percolation Conventions I-II

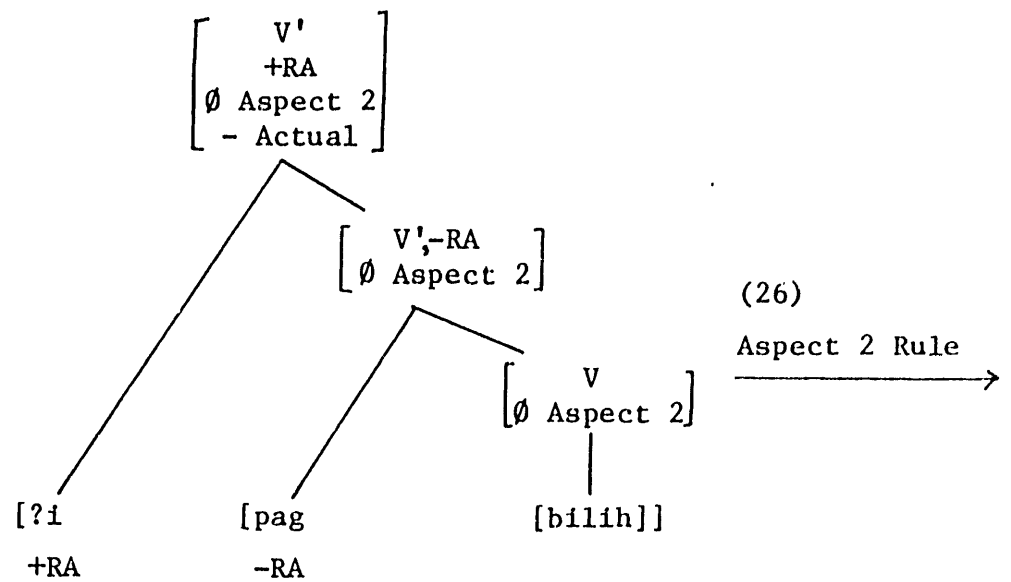

b.

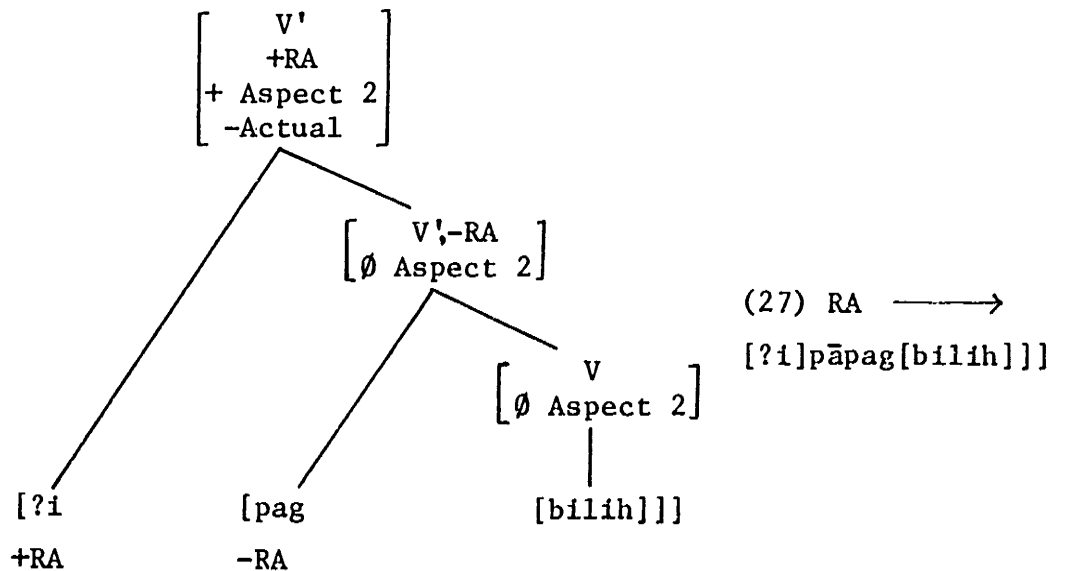

Case (31b), where the first V' affix ?i is [+RA], and the second V' affix pag is [-RA] yields a reduplicated form ?ipāpagbilih. Case (31c) has a slightly different derivation:

## (33) a. Feature Percolation Conventions I-II

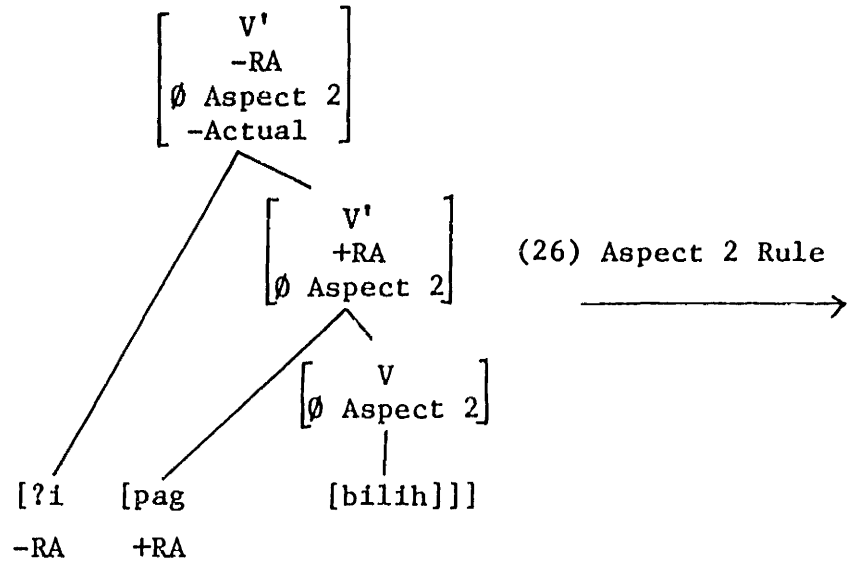

b.

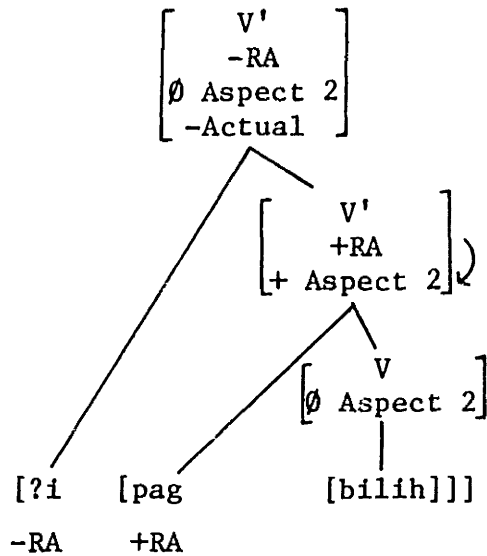

At this point, Feature Percolation III automatically percolates the [+ Aspect 2] feature up to the highest node, since the V' matrix contains a slot for this feature which is unspecified:

(33) c.

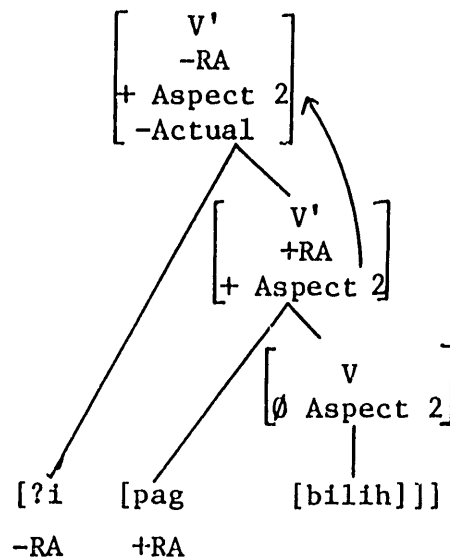

(27) RA →  
 [?i[pag[b̄ibilih]]]

When the first affix ?i is [-RA] and the second pag is [+RA], the reduplication starts copying at the bracket immediately to the left of pag, giving us the second possible reduplication for this form, ?ipagb̄ibilih. Example (31c) also provides a good illustration of why both the features [+RA] and [+ Aspect 2] are necessary: reduplication must apply locally, sometimes deep within a word, but aspect is interpreted only in conjunction with another feature [+ Actual] which is determined by the outermost affix. That is, the feature [+RA] must be available only at the exact point in the string where reduplication is to occur, but the aspect feature, which allows the interpretation of this word formation process must be available at the root of the lexical tree. The feature [+ Aspect 2] will percolate from anywhere in a tree to the highest node through a path of inherently unmarked [∅ Aspect 2] slots, and thus will enable the semantic interpretation rules to function properly. The RA feature will never, in fact, percolate. If it is dominated by a V node there will be no slot in the V matrix for the feature to percolate into. If it is dominated by

a V' affix, the RA slot will already be filled, since every V' affix must be inserted as either [+RA] or [-RA]. All we need to stipulate about Tagalog, under this analysis, is that some morphemes are V' morphemes and other not, and that all morphemes are inherently (i.e., in their lexical entries) unmarked for [Aspect 2]. The feature percolation devices and the actual reduplication rule work in the most simple and general way possible.

The most interesting case for the reduplication rules, namely (31d), has yet to be dealt with, of course. In this case, both V' affixes are inserted into lexical structure bearing the feature [+RA]. From what I have argued so far, we would expect (34) to be the proper derivation resulting from this underlying structure:

(34) a. Feature Percolation Conventions I-II

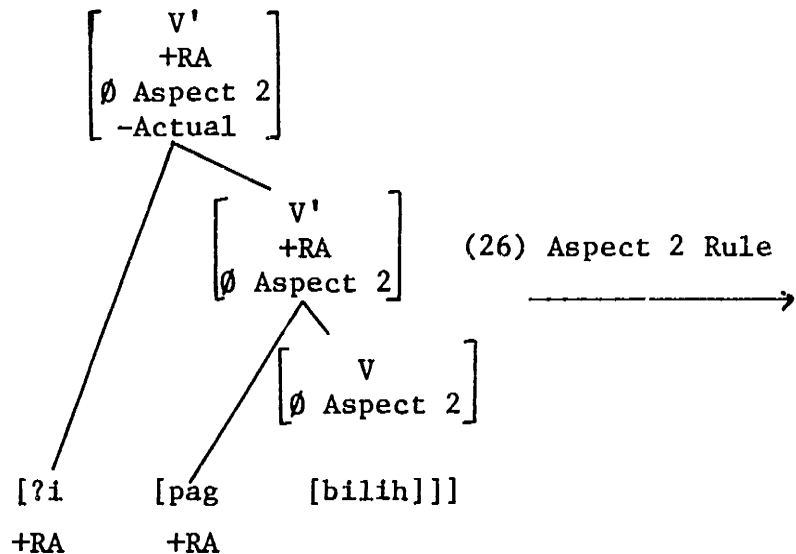

b.

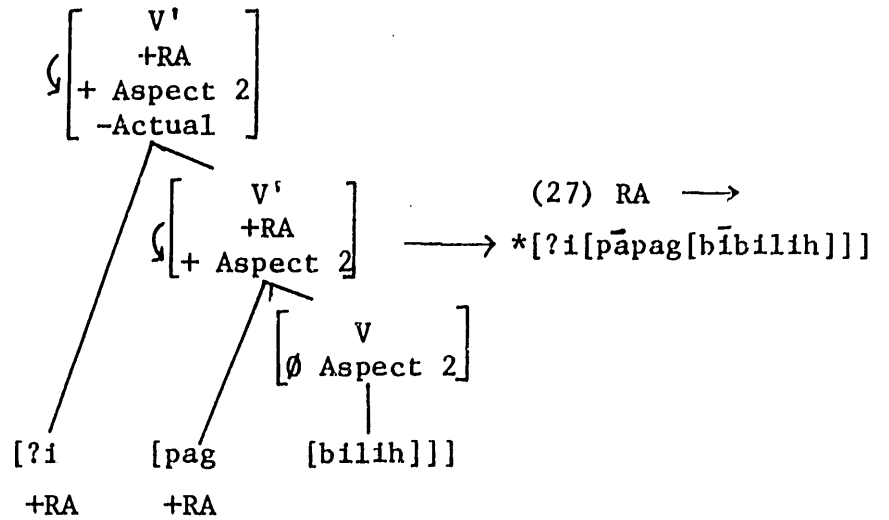

Notice that the output from the underlying structure in (31d) is \*ʔipāpagbībih, exactly the case of double application of RA that we need to rule out. There is nothing in the general framework of our theory or in the particular rules of Tagalog to prohibit this derivation.

At this point, I would like to argue that this state of affairs is exactly as it should be: the particular rules necessary for Tagalog word formation, and specifically the reduplication rules, should not be engineered to prevent derivations like those in (34) because this phenomenon of "no double application" is not unique to Tagalog. Instead, if we consider it to be part of a much broader set of phenomena, we can begin to approach a more explanatory analysis of Tagalog reduplication.

Consider the examples in (35), none of which, to my knowledge is a well-formed word:

(35) a. English

\*blueishishish

\*unununhappy

b. German

\*Mädchenchen

\*Vögleinleinlein

c. Spanish

\*pequeñititito

\*muchachototote<sup>7</sup>

All of the affixes in question have the same property: their subcategorization frames are of the sort  ${}_{\alpha} [ \_{}_{\alpha} [ \text{ or } ]_{\alpha} \_{}_{\alpha} ]_{\alpha}$ , where  $\alpha$  ranges over the set of categories, and must be the same on both brackets for any choice of  $\alpha$ . The particular subcategorization frames needed are illustrated in (36):

- (36)    -ish /  $]_{\text{A}} \_{}_{\text{A}}$   
           un- /  $[_{\text{A}} \_{}_{\text{A}}$
- chen } /  $]_{\text{N}} \_{}_{\text{N}}$   
           -lein }
- it } /  $\left\{ \begin{array}{l} ]_{\text{N}} \_{}_{\text{N}} \\ ]_{\text{A}} \_{}_{\text{A}} \end{array} \right.$   
           -ot }

Given these subcategorization frames, there is as yet nothing within our theory to prevent the generation of the forms in (35), and, in fact, the generation of forms with indefinite strings of iterated un's, -ish's, -chen's, and so on. Yet, as far as I know, even one extra iteration of such an affix yields a morphologically ill-formed word. Moreover, this ill-formedness is certainly not a semantic phenomenon.



It is fairly clear that \*Mhdchenchenchen should be a very, very, little girl (that the putative meaning of the word is easily expressible by an iteration of very's alone suggests that semantic deviance is not in question). Nor is \*unununhappy semantically incoherent: it would certainly mean "not not unhappy" if it were a morphologically acceptable form.

Rather, I would like to suggest that we have here some sort of general constraint or condition on morphological rules analogous to the conditions on syntactic rules (Complex NP Constraint, Subjacency, Specified Subject Constraint, Tensed S Constraint, cf. Ross (1967), Chomsky (1973,...)) which have been proposed within recent years. The analogy is quite fitting, in fact. Sentences like \*Who did I believe the story that John likes \_\_\_\_\_. (i.e., violations of Subjacency or Complex NP) are not semantically incoherent; their unacceptability seems to be a purely syntactic matter, just as the ill-formedness of \*blueishish, etc., seems to be a matter of the syntax of word formation. We might therefore tentatively assume a general constraint on word formation such as that illustrated in (37):

(37) The Multiple Application Constraint (MAC):

No word formation process, e.g., insertion of a given morpheme into a lexical tree, or string dependent rule, can apply iteratively to its own output.

Such a constraint will rule out both the case of double application of RA in Tagalog (31d), and the iterated affix cases in (35). I should stress that the statement of the Multiple Application Constraint in

(37) is quite tentative. At this stage, it does no more than identify a class of phenomena which seem to share the same property. Within a truly explanatory theory of word formation, it ought to follow from some general property of the theory that multiple applications of word formation processes are unacceptable. This must be taken as one of the important goals of the theory of word formation, and as a direction for future research. Here, I merely offer the MAC as a first approximation to a condition on word formation processes. One clear result of accepting such a condition is that one of the chief problems within Carrier's work, the problem of preventing multiple applications of reduplication, is removed from the grammar of Tagalog itself, and associated with a set of similar but equally problematic phenomena in other languages. Whatever the particular condition on word formation turns out to be, RA reduplication (and other reduplication in Tagalog) can be stated as a strictly local operation.

### 2.3. Reduplication Summary

The conclusions that we can draw so far are that it is necessary to allow a set of rules within our lexicon that are string dependent, and that some of these rules require transformational power for their statement. Tagalog reduplication rules must be stated as lexical transformations. We also found that a number of interesting properties are associated with reduplication in Tagalog; these are summarized in (38):

- (38) a. Reduplication is pervasive in that what appears to be the same formal process appears over and over again in a

variety of morphological constructions.

- b. Reduplication cannot be associated with any unique semantic representation.
- c. Rules of reduplication are 'structure-preserving'.
- d. Reduplication is 'triggered' by certain affixes, and must apply after affixation, rather than simultaneous with affixation.
- e. Reduplication does not, by itself, change the category of the base to which it applies.
- f. Reduplication is a strictly local rule.

So far, nothing has been said about why this particular group of properties should be associated with reduplication in Tagalog. It might be purely accidental that these properties and no others accompany reduplication. The next section of this chapter will therefore be devoted to a detailed investigation of another morphological process, namely umlaut in German. It will emerge in section 3 that German umlaut is also a string dependent morphological rule (although not requiring a transformational statement), and that the cluster of properties accompanying Tagalog reduplication also accompanies umlaut. Such a correspondence of properties in rules as different as reduplication and umlaut suggests that this particular clustering of properties is not at all accidental. The ultimate goal of this chapter is to show that all of the facts about reduplication and umlaut in fact follow from the

organization of the lexicon developed in Chapter 2, and thereby provide strong evidence in favor of this theory of lexical organization.

### 3. Umlaut

Umlaut is the term used to refer to the fronting of vowels in certain environments in German: for example, in some nouns, plural stems differ from corresponding singulars in that the plural stem vowel is fronted: Vater ~ Väter, Mann ~ Männer (the latter also has an r-stem extension in the plural, as already discussed in Chapter 1). Similarly, the comparative forms of some adjectives have stem vowels related to their non-comparative counterparts by some sort of vowel fronting process: gross ~ grösser. In general, umlaut is one of the most strikingly pervasive processes in German grammar, occurring in verb paradigms, derivational word formation, and what seem to be conversion pairs, in addition to the noun and adjective paradigms already mentioned. Umlaut is also one of the most extensively discussed phenomena in German linguistics. I will not review here the copious literature that already exists on this subject, since my main purpose is simply to find the best analysis of umlaut consistent with the framework developed above. Instead, I will present the basic arguments from Wurzel (1970) for considering umlaut to be a fundamentally morphological process, rather than a phonological one, and discuss a number of drawbacks of Wurzel's own morphological analysis. I will then consider the two analyses for the umlaut phenomena which are available within my theory of morphology: it will be argued that umlaut is a productive string dependent rule in German belonging to the third subcomponent of our morphology, rather than a morpholexical phenomenon

represented in the permanent lexicon. The discussion will draw upon a number of ideas already explored in earlier chapters, for example non-directional morphological conversion, the identity of inflectional and derivational processes, and the formal nature of morphological rules. It will range quite broadly over the various morphological processes of German, and a number of rather subtle, and seemingly correct predictions will emerge from the discussion. However, what will be of most interest are the properties which accompany the umlaut rule to be motivated here.

### 3.1. Umlaut as a Morphological Process

Wurzel (1970) argues quite convincingly that umlaut can no longer be considered a purely phonological phenomenon in the synchronic grammar of modern German (cf. also Strauss 1976). While it must have been the case at some point in the history of German that a front non-low vowel always caused the fronting of a vowel in a preceding syllable, this is certainly no longer the case. First, it is necessary in any case to postulate some underlying front rounded vowels for German. These are needed to account for monomorphemic umlauted forms such as Bär 'bear' and Tür 'door'. Such forms never alternate with unumlauted forms, nor is there any independent motivation for postulating underlying forms such as Bari and Turi, where umlaut would first front the stem vowel, following which an ad hoc rule of vowel deletion would delete the final i. That is, the final front vowel that we would need to postulate for such forms would merely serve as a diacritic for the operation of umlaut. Nor is it apparent from a superficial appraisal of the cases where alternations between umlauted and non-umlauted vowels do occur, that umlaut occurs in every case in which a stem vowel is followed by a

front non-high vowel: umlaut has occurred in forms like Völker 'folk-pl.', Güte 'goodness', Büchlein 'book-dimin.', and Hündchen 'dog-dimin.', but not in Hunde 'dogs', Fahrer 'driver', or froher 'happier', similarly Dümmling 'simpleton', zärtlich 'tender', Hündin 'bitch', höhnisch 'scornful', bärtig 'bearded' vs. Beamtin 'female official', lautlich 'phonetic', Wagnis 'chance', and wolkig 'cloudy'. To maintain a purely phonological rule of umlaut, it would be necessary to postulate final vowels in Hunde, Fahrer, Beamtin, lautlich, etc. which are underlyingly distinct from the final vowels in Güte, Völker, bärtig, etc. Mass neutralization of these underlying distinctions would have to occur to derive the surface forms. This sort of solution is especially unappealing with respect to cases such as those in (39) (examples from Wurzel (1970)):

(39)	a.	Hü	ndin	Bea	mtin
		Kü	chin	Ga	tin
	b.	Bä	cker	Fa	hrer
		Stä	dter	Ma	ler
	c.	Begrä	bnis	Befu	gnis
		Gelö	bnis	Wa	gnis
	d.	Ä	rtlich	am	tlich
		stü	ndlich	la	utlich
	e.	b	ärtig	gr	asig
		mü	ssig	w	olkig

The simplest thing we can say about the morphological structure of the

forms in (39a-e) is that they are derived words containing the suffixes -in, -er, -nis, -lich, and -ig. -in forms feminine nouns, -er agentive nouns, -nis abstract nouns, and -lich and ig adjectives. The lexical structure of the derived words seems to be identical for the umlauted and unumlauted forms, yet the purely phonological approach to umlaut would force us to postulate two distinct underlying forms for each suffix to account for the fact that each suffix forms both derived words with umlaut and derived words without umlaut. Thus, instead of a single suffix -in, we would be forced to postulate two suffixes, say -in and  $\overset{*}{V}n$ , the latter containing some vowel, as yet to be specified, which is neutralized to i only after the operation of umlaut. Similarly, we would need pairs of suffixes -er and  $\overset{*}{V}r$ , -nis and  $\overset{*}{nVs}$ , -lich and  $\overset{*}{lVch}$ , -ig and  $\overset{*}{Vg}$ , with more neutralization. Moreover, stems would have to be lexically marked to indicate the suffix variant they choose. Nor is it obvious what vowel  $\overset{*}{V}$  should be: German has suffixes with back vowels a (-bar, -schaft), o (-los), and u (-tum, -ung), which must not get neutralized to e or i by whatever processes neutralize  $\overset{*}{V}$ ;  $\overset{*}{V}$  therefore cannot be a, u or o. Clearly,  $\overset{*}{V}$  looks like a diacritic vowel concocted merely to prevent the umlaut rule from applying in certain environments. These complications, taken together, argue strongly against a purely phonological analysis (cf. Wurzel (1970) for a much more detailed discussion of these facts, and previous analyses advocating purely phonological umlaut).

Wurzel himself takes this array of facts to mean that umlaut is no longer a phonological process in modern German; rather, it must be seen as part of the morphology of the language. Umlaut, where it is not

underlyingly present in stems, is triggered by the presence of certain suffixes in a complex derived word. Some suffixes trigger umlaut on preceding stems, and others do not. Moreover, of the suffixes which do trigger umlaut, some trigger umlaut on every stem to which they attach, and others do so only sporadically. Wurzel provides a classification of German suffixes with respect to their umlaut triggering capacities, of which (40) is a partial summary:<sup>8</sup>

(40) a. Affixes regularly conditioning umlaut

1. Plurals in -er (Männer)
2. -e forming abstract nouns from adjectives (Güte)
3. Ge...e forming abstract nouns (Gebäude)
4. Diminutives in -chen and -lein (Mädchen, Vöglein)
5. Nouns in -ling (Dümmling)

b. Affixes only sometimes conditioning umlaut

1. Noun plurals (Füchse vs. Hunde)
2. -in forming feminine nouns (Hündin vs. Beamtin)
3. -er forming agentive or instrumental nouns (Bäcker vs. Fahrer)
4. -lich forming adjectives (ärztlich vs. amtlich)
5. -ig forming adjectives (bärtig vs. wolzig)

c. Affixes never conditioning umlaut

1. -schaft
2. -bar
3. -los
4. -ung



Other affixes could be added to these classes. Presumably, a partial 'memory' of the original phonological conditioning of the rule is preserved in that no suffix containing a back vowel conditions umlaut. But of the suffixes with front vowels, some regularly condition umlaut, and others condition umlaut in some forms, but not in others. A number of morphological analyses have been proposed for these facts. Here, I will only discuss one, namely Wurzel's (1970), as a background for the analysis to be proposed within the theory of lexical organization developed above.

Wurzel's framework allowed only one sort of analysis for this data: umlaut had to be formulated as a sort of readjustment rule applying after affixation, but before the phonological component. This readjustment rule (actually a whole series of readjustment rules) was triggered by a number of morphological features inherent to stems and affixes. For example, suffixes which always umlaut their stem vowels, such as those in (40a) would be given the feature [+UE] (from the German for "umlaut inducing"). A simplified form of Wurzel's first umlaut readjustment rule would then be the following:

$$(41) \quad [+syl] \longrightarrow [-back] / \text{ \_\_\_ } C_0 [+UE]$$

e.g., Gut +  $\begin{bmatrix} e \\ [+UE] \end{bmatrix} \longrightarrow \text{G} \ddot{u}t + e$

Such a rule will not suffice, however, for suffixes such as those in (40b). Suffixes which sometimes, but not always umlaut their stem vowels are given a different umlaut triggering feature, [+UB] (for "umlaut conditioning"). This feature does not automatically trigger umlaut, but works only if it is preceded by a root morpheme marked with

another feature [+DU] (for "derivative umlaut"). Wurzel's second readjustment rule is something like the slightly simplified version in (42):

$$(42) \quad [+sy1] \longrightarrow [-bk] / \text{---}C_o [+UB] / [\overline{+DU}]$$

e.g.,  $\begin{bmatrix} \text{arzt} \\ +DU \end{bmatrix} + \begin{bmatrix} \text{lich} \\ +UB \end{bmatrix} \longrightarrow \text{Ärztlich}$

amt +  $\begin{bmatrix} \text{lich} \\ +UB \end{bmatrix} \longrightarrow \text{amtlich}$

Already we can see that Wurzel's solution has a number of unattractive properties. We now have three features and two readjustment rules with identical structural changes. Even these two readjustment rules, however, will not suffice within Wurzel's theory to account for the appearance or non-appearance of umlaut in German derivational word formation. Wurzel himself notes (1970:124):

Wie bereits angedeutet, folgen nicht alle Derivative aus (4) [my (40b)] den diskutierten Regularitäten. Während beispielweise Ärztlich, jämmerlich, mündlich, mütterlich, örtlich und wörtlich heisst, stehen daneben Formen wie (ver)arzten, jammrig, Munde/munden/ (voll)mündig, (be)muttern, Orte/orten/ (ander)ortig und Worte/worten/ (viel)wortig. Andererseits zeigen Beispiele wie Orte-orten-ortig, Düfte-duften-duftig, Lüfte-lüften-luftig und Häute-häuten-häutig, dass das Auftreten des Umlauts bei den starken /e/-Pluralen, denominalen Verben und den mit -ig /g/ gebildeten Adjektiven nicht durch ein einheitliches Merkmal zu erfassen ist.

That is, the features [+UB] and [+DU] imply that a given [+DU] stem

should always be umlauted when followed by any suffix which sometimes, but not always umlauts stems. Yet of the suffixes which sometimes do and sometimes don't condition umlaut (i.e., those in (40b) and others like them), a given stem may umlaut with one, but not the others:

jämmerlich ~ jammrig; mühdlich ~ mundig. A given stem might have an umlauted plural, but no umlaut in other variable suffix derivatives. To account for the fact that the occurrence of umlaut in one derived form does not guarantee the occurrence of umlaut in another derived form, Wurzel begins to add still more umlaut triggering features: roots can therefore be marked [± -ig Umlaut] if they occur umlauted with the affix -ig, or [± Plural Umlaut] if they have an umlauted plural stem. So Wurzel adds still another readjustment rule, something like (43):

$$(43) \quad [+syl] \longrightarrow [-bk] / \left\{ \begin{array}{l} \left[ \begin{array}{l} +pl \text{ uml} \\ +pl \end{array} \right] C_C \left. \vphantom{\begin{array}{l} +pl \text{ uml} \\ +pl \end{array}} \right]_N \\ \left[ \begin{array}{l} +ig \text{ uml} \\ \phantom{+ig} \end{array} \right] C_O \left. \vphantom{\begin{array}{l} +ig \text{ uml} \\ \phantom{+ig} \end{array}} \right]_N \text{ ig} \left. \vphantom{\begin{array}{l} +ig \text{ uml} \\ \phantom{+ig} \end{array}} \right]_A \end{array} \right\}$$

e.g.,  $\left[ \begin{array}{l} \text{Duft} \\ +pl \text{ uml} \\ +pl \end{array} \right] \longrightarrow \text{Düfte}$

$\left[ \begin{array}{l} \text{haut} \\ +ig \text{ uml} \end{array} \right] + \text{ig} \longrightarrow \text{häut+ig}$

More features and more readjustment rules are eventually added to Wurzel's analysis to account for umlaut in verb paradigms, derived verb stems, and so on.

Despite its enormous complexity, Wurzel's readjustment rule analysis cannot account for some of the real intricacies of the German umlaut data. It will produce mechanically the majority of cases where a given stem morpheme with a given suffix always has the same form,

regardless of the prefixes intervening structurally between the suffix and the stem, e.g., (44a), but it does not predict the existence of a non-infrequent pattern like that in (44b):

- (44) a.      k uflich  
               abk uflich  
               erk uflich  
               verk uflich  
               unverk uflich
- b.      tonig                              eint nig  
                   tieftonig                        vielt nig  
                   hochtonig                        hocht nig  
   misst nig

In (44b), some derivatives with the morpheme ton and the suffix -ig have umlaut, and others do not. But ton must bear either the feature [+ig uml] or [-ig uml] within Wurzel's analysis. There is no apparent way of generating both tonig and eint nig without contradiction. Nor is there any way of generating doublets such as those in (45):

- (45)            f rmlich                              formlich  
                   vertr glich                        vertraglich  
                   s chlich                              sachlich  
                   Schl ger                              Schlager  
                   Kr mer                                Kramer  
                   Schl chter                              Schlachter

By doublets, I mean pairs which differ structurally only in that one form has umlaut and the other one does not; some of these pairs differ in meaning, others are dialectal, or perhaps idiolectal variants, but all seem to be derived from the same morphemes. Again, for Wurzel, the

stems would have to be both [+DU] and [-DU].

### 3.2. Two Possible Reanalyses of Umlaut

Of course, given the arguments in Chapters 1-3 for unifying all word formation processes in a single component of our grammar, Wurzel's analysis would be ruled out on a priori grounds: even if it were not flawed by excessive complexity, readjustment rules no longer exist as a morphological rule type within the system of lexical organization advocated here. We must therefore begin to explore the sorts of reanalysis available to us within my theory. Below, I will formulate two analyses which are logically possible within this framework, one which postulates umlauted and non-umlauted stem variants listed in the permanent lexicon, and another which entails a productive string dependent umlaut rule triggered by a diacritic feature on morphemes. Both solutions are reasonably simple, and both avoid the major pitfalls of Wurzel's analysis. In the latter half of this section, however, I will provide a number of arguments in favor of the second of these analyses. A byproduct of these arguments will be a more highly constrained notion of morpholexical rule than was offered in Chapter 2.

The following are the two distinct analyses of umlaut available to us:

#### Analysis A (MORPHOLEXICAL)

- (i) Stem morphemes in German can be listed in both an umlauted form and a non-umlauted form, e.g., {(form, f $\ddot{u}$ rm), (trag, tr $\ddot{a}$ g), (arzt,  $\ddot{a}$ arzt),...}. The regularity existing between the members of each ordered pair will be represented by a morpholexical rule:

$$[C_o \begin{bmatrix} V \\ +bk \end{bmatrix} C_o] \sim [C_o \begin{bmatrix} V \\ -bk \end{bmatrix} C_o]$$

The first member of each pair will be designated with the diacritic [-U] and the second member with the diacritic [+U].

- (ii) Suffixes will have lexical entries like those in Chapter 2, including the expected subcategorization frame. Some suffixes will subcategorize exclusively [-U] stems, e.g., -bar, -schaft, -ung. Others will subcategorize exclusively [+U] stems, e.g., -chen, -lein, -e. Other suffixes, namely the "umlaut variable" suffixes like -lich and -ig will not specify either [+U] or [-U] as part of their subcategorization. Hence, they will not discriminate between the two sorts of stems.
- (iii) Thus, stems are inserted into trees already umlauted, and only suffixes subcategorizing [+U] stems or suffixes not distinguishing [+U] from [-U] stems can be inserted to form a well-formed word. There is no productive rule umlauting stem vowels, however.

#### Analysis B (PRODUCTIVE STRING DEPENDENT RULE)

- (i) Suffixes in German are divided into three major groups in the permanent lexicon. One group is marked with the feature [+U], which will trigger an umlaut rule. The second group of suffixes will be [-U]. The final group will have the designation [+U] which will be taken to mean that such suffixes can be either [+U] or [-U] in a given derivation (they are never simultaneously [+U]).
- (ii) Stems and affixes are put together subject to the principles of

lexical structure discussed in Chapter 2. At this stage in the derivation only those stem vowels will be umlauted which are underlyingly umlauted. That is, the output of the lexical structure component will be structures such as these:

$$\begin{array}{cc} [[\text{form}]_N & \text{lich}]_A \\ & +U \end{array} \quad \quad \quad \begin{array}{cc} [[\text{form}]_N & \text{lich}]_A \\ & -U \end{array}$$

$$\begin{array}{cc} [[\text{Hund}]_N & \text{chen}]_A \\ & +U \end{array}$$

(iii) Finally, in the third subcomponent of our morphology, there will be a string dependent rule of the following sort:

$$\text{UMLAUT:} \quad [+syl] \longrightarrow [-bk] / \text{ \_\_\_\_\_\_ } C_0 [+U]$$

This rule states simply that a vowel is fronted when followed by a morpheme bearing the feature [+U].

Neither of these two solutions is particularly complex. First, there is no reason to expect that stems which occur umlauted with one umlaut-variable suffix, say -lich, ought to occur umlauted with another umlaut-variable suffix, e.g., -ig. Within either analysis, the umlauting possibility of each stem is independent from affix to affix. Second, since it is a feature of the framework as a whole that inflectional affixes are treated no differently from derivational affixes, it is to be expected that both work the same way with respect to umlaut. Under Analysis A, inflectional affixes such as the comparative -er are treated like all umlaut-variable suffixes: comparative -er subcategorizes adjectives without regard to their umlaut feature. Under Analysis B, -er will be a [+U] affix, just as

the derivational suffixes -lich and -ig are (I will have more to say about umlaut and inflection below). Both solutions do away with Wurzel's proliferation of umlaut-triggering features, and both predict the existence of doublets and paradigms like that in (44b). As discussed in Chapter 2, it is the goal of this theory of morphology to generate all and only possible forms, rather than all and only actual forms (however that term is to be interpreted): both Analysis A and Analysis B will overgenerate as far as actual words are concerned, since either will allow derivations with both umlauted and unumlauted variants on any given stem for umlaut-variable suffixes like -lich and -ig. But this is exactly as it should be: the grammar of German generates possible forms from which individual speakers and dialects choose, thus adding texture to the language which cannot be captured by an analysis like Wurzel's. Actual doublets and paradigms such as that in (44b) are simply the most obvious manifestation of overgeneration.

So far, both analyses seem to be reasonable hypotheses as to the place of umlaut in our morphology of German. It is therefore necessary to consider at this point what would count as evidence for deciding between the morpholexical and the string dependent analyses of umlaut. A number of arguments can be brought to bear on this issue: these arguments will show, in fact, that structure already added to this theory for independent reasons highly constrains our choice of possible analyses for umlaut, and indeed narrows the possibilities down to a single one, Analysis B.

Initially, a number of brief arguments can be made against Analysis A. First, notice that the morpholexical analysis requires us to list a



great many stem forms, in fact all stem forms with back vowels in the root form, with both an umlauted stem variant and a non-umlauted stem variant. This has the obvious undesirable consequence of multiplying drastically the number of individual items listed in the permanent lexicon. Whatever this fact means in terms of language processing or memory load, it seems to be an undesirable complication on a priori grounds. In contrast, Analysis B requires only a single stem form for each root; German suffixes must be distinguished in the permanent lexicon as to whether they bear the feature [+U], [-U], or [+U]. It is the suffixes which have extra idiosyncratic information in their lexical entries rather than the stems, and the amount of idiosyncratic information concerned with umlaut is thereby greatly reduced.

Second, it is somewhat problematic, within the morpholexical analysis of umlaut, what to do about stems which have underlying front vowels (e.g., Kind 'child'). Suffixes, whether subcategorized to attach to [+U] stems, or [-U] stems, or either, do attach to stems with underlying front vowels. So a suffix -chen which has the subcategorization frame  $\left. \begin{array}{c} ]_N \quad \text{---} \\ [+U] \end{array} \right]_N$  attaches to Kind to form Kindchen.

And a suffix like -haft which has the subcategorization frame  $\left. \begin{array}{c} ]_N \quad \text{---} \\ [-U] \end{array} \right]_A$  attaches to Kind to form kindhaft. But it would certainly be absurd to postulate one stem kind which is [+U], and another stem kind which is [-U]. The alternative is to attach some complicated, and rather ad hoc condition to the subcategorization frame of each affix to the effect that they attach to any stem which has an underlying front vowel. The string dependent rule of Analysis B has a much more

straightforward and natural way of dealing with stem morphemes like Kind. Since the structural change of the string dependent rule is essentially phonological in nature, it will automatically apply to morphemes with [-bk] vowels in the environment of a [+U] suffix, but it will apply vacuously. The front vowel in Kind will remain unchanged. Again, the matter of simplicity is at issue, and Analysis B seems superior in this respect.

The next two arguments in favor of the string dependent analysis of umlaut are somewhat more substantial in nature. The first requires delving into some of the internal intricacies of lexical structure in German.

It often seems difficult to say for sure what the internal structure of a German word is, since affixes frequently can attach to more than one category of lexical item. For example, un- can attach to nouns or adjectives to form nouns and adjectives respectively, in accordance with our labeling conventions: Unmensch<sub>N</sub>, unwahr<sub>A</sub>. The suffix -lich attaches to verbs and nouns to form adjectives: freundlich, empfindlich. Therefore, in a form like unmenschlich, we could either have the structure in (46a) or the structure in (46b):

- (46) a.            [ <sub>A</sub> un [ <sub>A</sub> [ <sub>N</sub> mensch ] lich ] ]  
           b.            [ <sub>A</sub> [ <sub>N</sub> un [ <sub>N</sub> mensch ] ] lich ]

In the former, un- has attached to the adjective menschlich, and in the latter, -lich has attached to the noun Unmensch. I am not sure if any difference in semantic interpretation accompanies this distinction in structure.

However, there are also cases where it is possible to determine uniquely the proper bracketing of a lexical item. For example, the word unlässlich must have the bracketing [un [[läss] lich]], since -lich will attach to the verb stem läss (lassen), whereas un- will not attach directly to verb stems. Un- will attach to the adjective lässlich, however. Similarly, the form Abkömmlich must have the bracketing [[Ab [kömm] lich]: ab- attaches only to verb stems, and -lich forms nouns. ab- would never attach directly to a noun kömmlich. For the purposes of the argument to follow, I will limit myself to cases like unlässlich and Abkömmlich, where internal structure is uniquely determined by the subcategorizations of affixes.

Consider the data in (47):

- (47) a.                    [[pfx [stem]] sfx]
- |             |             |
|-------------|-------------|
| abkömmlich  | traulich    |
| bekömmlich  | vertraulich |
| herkömmlich | zutraulich  |
| auskömmlich |             |
- b.                    [pfx [[stem] sfx]]
- |            |               |
|------------|---------------|
| lässlich   | nachahmlich   |
| unlässlich | unnachahnlich |
- c.                    [[pfx [stem]] sfx]
- |              |             |
|--------------|-------------|
| abtrüglich   |             |
| nachtrüglich |             |
| ertrüglich   |             |
| zutrüglich   |             |
| vertrüglich  | vertraglich |
- d.                    [pfx [[stem] sfx]]
- |            |          |
|------------|----------|
| unpässlich | passlich |
|------------|----------|

The examples in (47a) and (47c) must have the bracketing that we assigned to AbkÜmmeling, with the prefix attached inside the suffix. ab, be, her, aus, etc. are all so-called separable prefixes which attach only to verbs. The examples in (47b) and (47d) have precisely the opposite bracketing, with un- attached outside the suffix; läss, nachahm, and pass are all verb stems to which un- could not attach directly. What this data is meant to show is that umlaut behaves exactly the same way, regardless of the internal structure of a word. The majority of derived words in German are like the (a) and (b) cases. That is, in most cases, if the stem vowel in one derivative is umlauted, the stem vowel is umlauted in all derivatives. Conversely, if the stem vowel is unumlauted in one, it is unumlauted in all, regardless of internal structure. Examples like (47c) and (47d), where umlauted and unumlauted forms of the same stem exist side by side in derivatives, can be found, but they are significantly less frequent than the (a) and (b) patterns.

These are merely observations about the frequency of patterns of occurrence of umlaut. Analysis A and Analysis B, however, actually make slightly different predictions about these facts, with Analysis B coming a bit closer to the state of affairs described above than Analysis A.

Within Analysis A, the morpholexical analysis, stems are listed in unumlauted and non-umlauted forms, and suffixes are subcategorized to occur with [+U] stems, [-U] stems, or either. In words with structures like [un [[läss] lich]], the suffix attaches directly to the stem with the [+U] designation. It is therefore not hard to see why forms like

[[X] lich] and [un [[X] lich]] frequently share umlaut properties (i.e., they are both umlauted or both unumlauted). Since the un- form is built on the base of the [[X] lich] form, we would expect them most often to be identical. Forms like abkømmlich and bekømmlich, however, have the opposite bracketing. A full tree structure is illustrated in (48):

(48)

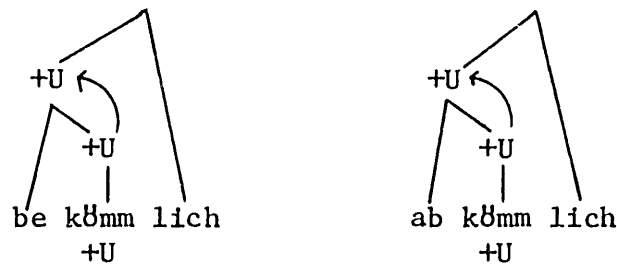

As illustrated in (48), our independently motivated feature percolation mechanisms will allow the feature [+U] to percolate to the first branching node dominating kømm: since prefixes like ab and be are not specified for the umlaut feature, this feature can percolate from the righthand constituent. Notice that this allows us to state the subcategorization of -lich with no violation of the Adjacency condition. Without the percolation convention, -lich would have to cross two brackets to "see" the umlaut feature on kømm:

(49)

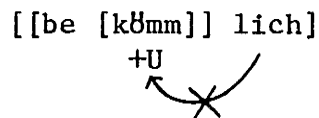

Instead, with feature percolation, the umlaut feature is structurally adjacent to the suffix even in forms with left-branching internal structure.

Because of the way that forms like abkømmlich and bekømmlich are bracketed, the morpholexical analysis might lead us to expect them to

behave differently with respect to umlaut properties from right-branching words like unl<sup>ä</sup>sslich. The -lich adjectives in (47a,c) are not formed on identical bases, namely k<sup>ö</sup>mm or tr<sup>ü</sup>g. Instead, they are derived from distinct morphological constituents abk<sup>ö</sup>mm, bek<sup>ö</sup>mm, ausk<sup>ö</sup>mm, zut<sup>r</sup>ü<sup>g</sup>, abtr<sup>ü</sup>g, and so on. Each of these constituents is independent of the others, and there is therefore no more reason for them to behave alike with respect to umlaut than there is for two entirely phonologically distinct stems like l<sup>ä</sup>ss and nachah<sup>m</sup> to behave alike. We should expect to find numerous cases of prefix-stem constituents, say abX and beX, where X is umlauted in abX with the suffix -lich, but unumlauted in beXlich. That is, because of their left-branching internal structure, we might expect forms like those in (47a,c) to exhibit more variability in umlaut with affixes like -lich than we find in right-branching forms like those in (47b,d). As indicated at the outset of this argument, we simply do not find this distinction in the data. The variable pattern of umlauting is equally infrequent in right-branching and left-branching structures. So Analysis A seems to make a faulty prediction here.

In contrast, Analysis B makes no distinction between these two sorts of structures. The umlaut rule in Analysis B requires string adjacency of a vowel rather than structure adjacency: string dependent lexical rules, as their name suggests, can be blind to lexical structure. This was the case with reduplication, where R2 in Tagalog regularly copied sequences of consonants and vowels across morpheme boundaries, and this seems to be the case with umlaut in German as well. So, for example, a suffix like the diminutive -lein, which is

always [+U] will not umlaut a stem vowel if it is not string adjacent to a stem vowel:

(50)

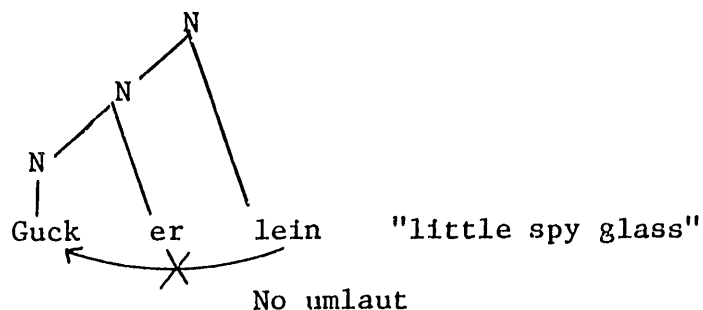

But the string dependent umlaut rule will make no distinction between the left-branching (abk~~u~~mmlich) type structures, and the right-branching (unl~~u~~sslich) type structures, since the stem vowel, in both cases, is string adjacent to the umlaut-triggering suffix. Although Analysis B gives us no clue at all as to why the majority of paradigms of both structural types are uniform with respect to umlaut (i.e., why the pattern in (47a,b) predominates), it at least makes no false predictions.

Notice that the string dependent analysis of umlaut also make a further prediction. If a strictly [+U] suffix attaches outside another suffix with a back vowel, we predict that the back vowel suffix should be umlauted. Unfortunately, it seems that the combinatorial properties of German suffixes are such that no examples of this sort are well-formed words. The closest we can come to the case we want are forms like Machtlosigkeit, wissenschaftlich, Glaubhaftigkeit which have [+U] suffixes -ig, and -lich outside of suffixes with back vowels -schaft, -haft, -los. Although none of the latter vowels appear umlauted, we can always appeal in these cases to the fact that -lich and -ig often do not umlaut underived stems. It would seem that the German data will

not allow us conclusively to test out the prediction about stacked suffixes.

One final objection may be offered to Analysis A, the morpholexical solution to the German umlaut problem. Early in Chapter 2, I made an attempt to define the characteristics that distinguished morpholexical rules from other rule types. Morpholexical rules were created to account for unpredictable variation in the stem forms of languages with inflectional paradigms more complex than those of English. I repeat my summary of their characteristics in (51):

- (51) a. Morpholexical rules are predicates which define sets of ordered pairs of lexical items, both of which are listed in the permanent lexicon. The relationships defined by morpholexical rules mimic the sorts of relationships defined by more productive morphological processes.
- b. Morpholexical rules are purely classificatory in nature. Unlike other rules of word formation, they do not change category, alter subcategorization, or add to, change or subtract from semantic content, however that is characterized. They merely define the limits of a class of items, and specify relatedness between pairs of those items.
- c. It is purely arbitrary whether or not any given lexical item conforms to the specifications of a lexical class as defined by its morpholexical rule.

The morpholexical analysis of German umlaut does not conform to all of these requirements. Although the morpholexical rule we would need



for umlaut defines a set of ordered pairs both of which are listed in the permanent lexicon, and is purely classificatory (it does not affect category, subcategorization, or semantic representation), it is not at all clear that membership in the lexical class defined by this morpholexical rule is arbitrary. All German stems with back vowels must have umlaut stems, and front vowels are problematic, as discussed above. By allowing the umlaut relationship to be expressed by a morpholexical rule, we weaken our definition of morpholexical rule and open the door to allowing all sorts of other non-arbitrary morphological relationships to be expressed as morpholexical relationships.

In contrast, the string dependent analysis allows us to maintain a more highly constrained model of morphology, with the result that only information which really is arbitrary is treated as arbitrary, and all that information about word formation which is general and rule governed is represented as such. Thus, it is arbitrary that a given suffix is [+U], [-U] or [+U], but what happens to a stem when it occurs in a [+U] environment is not arbitrary: this much is accounted for by a general string dependent rule of umlaut. For the remainder of this chapter, I will therefore accept Analysis B as the proper analysis of umlaut within my framework.

### 3.3. Umlaut and Inflection

So far, our discussion of umlaut has been confined exclusively to the interaction of umlaut and derivational affixation. Any student of German knows, however, that umlaut also pervades the inflectional system of German. Throughout this thesis, I have tried to argue that inflectional morphology and derivational morphology should not be

distinguished in the lexicon. If this is true, we would expect that inflectional affixes should be treated like derivational affixes with respect to umlaut as well; our string dependent rule of umlaut should go a long way towards accounting for the umlaut that appears in inflectional paradigms. In this section, I will cover umlaut phenomena in noun, verb and adjective paradigms, and show that this is to a large extent true.

### 3.3.1. Nouns

In the beginning of this work, I discussed German nominal paradigms in the context of justifying morpholexical rules, and illustrating that inflectional stems can act as input to other word formation processes. There, it was argued that the actual inflectional endings for case inflected forms were:

(52)		sg.	pl.
	N	-∅	-e
	A	-∅	-e
	G	-s (M,N), -∅ (F)	-e
	D	-∅	-n

All idiosyncrasy in the nominal paradigm was to be attributed to membership in a number of lexical classes, governed, as usual, by a number of morpholexical rules. Two of these classes actually included morpholexical rules which expressed an umlaut relationship between the stem vowels of two stem variants. The relevant facts are as follows: among other nominal stem classes, German has one class which has only a single stem, to which the endings in (52) are attached (Hund 'dog', Sommer 'summer'). A second class is distinguished from these only in

that it has a second stem with an unlauded vowel:  $\{(\underline{\text{Bach}}, \underline{\text{B}\ddot{\text{a}}\text{ch}}), (\underline{\text{Vater}}, \underline{\text{V}\ddot{\text{a}}\text{ter}}), \dots\}$ . The umlaut stem occurs with the plural case endings. Yet a third class has two stems, where one stem differs from the other in the presence of umlaut and an r-stem extension:  $\{(\underline{\text{Buch}}, \underline{\text{B}\ddot{\text{u}}\text{cher}}), (\underline{\text{Mann}}, \underline{\text{M}\ddot{\text{a}}\text{nn}\text{er}}), \dots\}$ . These three noun classes are of interest to the present discussion of umlaut.

First, it was argued earlier (Chapter 1) that ordered pairs of stems like  $(\underline{\text{Buch}}, \underline{\text{B}\ddot{\text{u}}\text{cher}})$  and  $(\underline{\text{Mann}}, \underline{\text{M}\ddot{\text{a}}\text{nn}\text{er}})$  are related by a morpholexical rule something like that in (53):

$$(53) \quad C_o \vee C_o \sim C_o \vee\! \! \! \vee C_o \text{ r}$$

(53) implies that the r stems are listed in the permanent lexicon already unlauded. This no longer has to be the case, however. Suppose that we say that (54a) are the stems which are listed in the permanent lexicon and (54b) the morpholexical rule relating them:

$$(54) \quad \text{a.} \quad \{(\underline{\text{Buch}}, \underline{\text{B}\ddot{\text{u}}\text{cher}}), (\underline{\text{Mann}}, \underline{\text{M}\ddot{\text{a}}\text{nn}\text{er}}), \dots\}$$

+U
+U

$$\text{b.} \quad X \sim \begin{array}{c} Xr \\ | \\ [+U] \end{array}$$

That is, if the r extension of this lexical class is designated as [+U], just as derivational affixes like -chen and -lein are, the umlaut rule will automatically umlaut all stems with the r extension. By counting the stem extension r as a [+U] element and unlauding by general rule, we account for the fact that there is no stem class in German with stem variants like  $(\underline{\text{Mann}}, \underline{\text{M}\ddot{\text{a}}\text{nn}\text{er}})$ .

The class of nouns  $\{(\underline{\text{Bach}}, \underline{\text{B}\ddot{\text{a}}\text{ch}}), (\underline{\text{Vater}}, \underline{\text{V}\ddot{\text{a}}\text{ter}}), \dots\}$  are not quite as straightforward as the class in (54), however. First, unlike the  $(\underline{\text{Mann}}, \underline{\text{M}\ddot{\text{a}}\text{nn}\text{er}})$  class, the stems are not distinguished by any affix-like extension. Umlaut is the sole difference between the singular and plural stems. Moreover, this class is distinguished from the Hund, Sommer class only by the presence of an umlauted stem; it is completely arbitrary whether a morpheme that takes no affix-like stem extension has an umlaut stem or not: Bach does, but Hund does not. This array of facts suggests a number of possible analyses. On the one hand, since umlaut is the sole difference between the singular and plural stems, and since it is purely arbitrary which stems will belong to this class, we might be justified in saying that we have lexical pairs such as those in (55a), and a morpholexical rule expressing the umlaut relationship:

- (55) a.  $\{(\text{Bach}, \text{B}\ddot{\text{a}}\text{ch}), (\text{Vater}, \text{V}\ddot{\text{a}}\text{ter}), \dots\}$
- b. 
$$c_o \vee c_o \sim c_o \vee\vee c_o$$

Thus, this analysis claims that umlaut can be represented as a morpholexical relation as well as a productive string dependent rule. There is another alternative open to us, however. Suppose that the lexical class in question is represented as in (56), rather than (55):

- (56) a.  $\{(\text{Bach}, \underset{+U}{\text{Bach}}), (\text{Vater}, \underset{+U}{\text{Vater}}), \dots\}$
- b. 
$$X \sim \underset{[+U]}{X}$$

This latter class has two stems which are phonologically identical, one

differing from the other in the presence of the umlaut triggering feature. In the third sub-component of our lexicon, the regular umlauting rule will apply in the environment of this feature in the normal way, yielding the plural stems Büch, Väter, etc.

At this point, we have little or no basis on which to decide between these two possible analyses. However, in light of some yet to be discussed facts about the German verb paradigms (specifically the analysis of umlaut in the 2nd-3rd singular of certain verbs), I will argue that the analysis which makes use of the umlaut triggering feature is the preferable one. This allows us to maintain the claim that umlaut is a single, unified process in German.

### 3.3.2. Verb Paradigms

Umlaut occurs in a number of places in the verb paradigms of German as well. For the discussion below, we will limit our attention to paradigms such as those in (57). I will first present a partial analysis of the German verb paradigms along the lines of that given for Latin in Chapter 2, and then discuss the instances of umlaut which appear.

(57)		INDIC PRES	INDIC PST	SUBJ I	SUBJ II
		<u>sagen</u> 'say'			
	sing. 1	sage	sagte	sage	sagte
	2	sagst	sagtest	sagest	sagtest
	3	sagt	sagte	sage	sagte
	pl. 1	sagen	sagten	sagen	sagten
	2	sagt	sagtet	saget	sagtet
	3	sagen	sagten	sagen	sagten
		<u>kommen</u> 'come'			
	sing. 1	komme	kam	komme	k $\ddot{u}$ me
	2	kommst	kamst	kommest	k $\ddot{u}$ mest
	3	kommt	kam	komme	k $\ddot{u}$ me
	pl. 1	kommen	kamen	kommen	k $\ddot{u}$ men
	2	kommt	kamt	kommet	k $\ddot{u}$ met
	3	kommen	kamen	kommen	k $\ddot{u}$ men
		<u>schlagen</u> 'hit'			
	sing. 1	schlage	schlug	schlage	schl $\ddot{u}$ ge
	2	schl $\ddot{u}$ gst	schlugst	schlagest	schl $\ddot{u}$ gest
	3	schl $\ddot{u}$ gt	schlug	schlage	schl $\ddot{u}$ ge
	pl. 1	schlagen	schlugen	schlagen	schl $\ddot{u}$ gen
	2	schlagt	schlugt	schlaget	schl $\ddot{u}$ get
	3	schlagen	schlugen	schlagen	schl $\ddot{u}$ gen

sagen is a so-called weak verb, which, in the theory being developed here, means that it has a single stem morpheme from which all other verbal forms are derived. kommen and schlagen are strong verbs; they have two stems (for the purposes of this discussion we can ignore the existence of other

stems from which the participle is formed). We can distinguish the German stems, as we did for Latin, with the use of a diacritic [D]:

(58)	[+D]	[-D]
	sag	
	kom	kam
	schlag	schlug

The ablaut classes to which strong verbs in German belong can presumably be analyzed along the lines of the analysis presented for the Old English strong verbs in Chapter 1. That is, (komm, kam) and (schlag, schlug) will be pairs of stem variants belonging to lexical classes defined by some set of morpholexical rules.

The verbal affixes of German will have the following subcategorization frames as parts of their lexical entries:

(59)	a. <u>Past</u>		-te / ]+V +D    ___] +V
	b. <u>Subjunctive</u>		-e / ]+V <+U> <-D> ] +V
	c. <u>P/N Endings</u>	Sing. 1	-e / ]+V ___ +D
		2	-st / ]+V ___
		3	-t / ]+V ___ +D
		Pl. 1	-en / ]+V ___
		2	-t / ]+V ___
		3	-en / ]+V ___

As usual, stems and affixes are inserted into lexical trees subject to subcategorization restrictions. A number of comments on these subcategorization frames will be useful here. First, the weak past ending -te is subcategorized to attach only to [+D] (present) stems. We must also assume that the existence of a listed [-D] stem in strong verbs blocks the formation of a regular weak past form. The use of angle brackets in the subcategorization frame for subjunctive -e certainly merits comment, but this will be discussed below. As for the person/number endings, these attach straightforwardly to any stem, or to the past or subjunctive affixes, with the following two exceptions: the difference between first person singular present komme and first person singular past kam indicates that the first person singular ending attaches only in the present (the final e in the subjunctive forms comes from the subjunctive e affix). Similarly, we find the third person singular t only in present forms. Therefore e and t have been subcategorized to attach only to [+D] stems; they will not attach to [-D] stems or to forms which have past tense te or subjunctive e. Remember that German independently needs a degemination rule, so the stacking up of affixes in, e.g., a third person plural Subjunctive I form [[[komm] e] en] is no problem. Notice also that the subjunctive e affix can attach to any kind of verb stem. If it attaches to a [+D] stem, we get what is traditionally called the Subjunctive I form. If it attaches to a [-D] stem, or to a stem with a weak past te, we get the Subjunctive II forms.<sup>9</sup>

With this partial analysis of the German verb paradigms accomplished, we can now go on to investigate the appearance of umlaut in these paradigms.



Consider first the paradigm of schlagen: here, the second and third person singular indicative forms schlägst and schlägt are umlauted. Initially, this might suggest to us that -st and -t are [+U] suffixes, but there are a number of reasons to believe that this is not the case. First, -st attaches to past and subjunctive forms, as well as to present indicative forms, but these forms are never umlauted (Subjunctive II forms are umlauted throughout the paradigm, but this will be discussed below). Minimally, the subcategorization frame for -st would have to say that -st is [+U] if and only if it is attached directly to a [+D] stem. A second and much more important reason for questioning whether the regular rule of umlaut is at work here is this: the vowel changes that occur in 2-3 sg. umlauting do not parallel those that occur in other umlauting contexts. In particular, front vowels as well as back vowels undergo changes:

(60)	ö	→	i	auslösch	~	auslischt
	e	→	ie	befehl	~	befiehlt
	e	→	i	bergen	~	birgt
	ä	→	ie	gebären	~	gebiert

Front vowels are never affected in stems occurring before the other [+U] suffixes we have investigated. Moreover, vowels which normally do umlaut before [+U] suffixes often do not umlaut in 2-3 sg. forms: au sometimes umlauts (saufen ~ säuft vs. saugen ~ saugt), o umlauts in only one verb (stossen) and u never umlauts (rufen ~ ruft). In other words, it is purely arbitrary in a given strong verb in German whether or not there will be umlaut in the 2-3 sg. forms.

Given these facts, I would like to argue that this sort of umlaut

should be analyzed as a morpholexical relation, rather than as an umlaut relation to be accounted for by our string dependent rule. Unlike the case of the plural class  $\{(\underline{\text{Bach}}, \underline{\text{B}\ddot{\text{a}}\text{ch}}), \dots\}$  discussed above, there is nothing to be gained by assigning the feature [+U] to the inflectional -t and -st affixes: even if we could state the subcategorization so that only present stems were umlauted, the general rule would never produce the vowel alternations in (60). Some verbs in German must simply be listed in the permanent lexicon with an extra 2-3 sg. stem, the relationship between this stem and the verbal root being specified by morpholexical rule. This sort of analysis captures the arbitrariness of the 2-3 sg. umlauting process. In contrast, the case of the plural class  $\{(\underline{\text{Bach}}, \underline{\text{B}\ddot{\text{a}}\text{ch}}), \dots\}$  should rightly be subsumed under the regular umlauting rule: not to do so (i.e., to propose the morpholexical rule in (55b)) would be to claim that it is accidental that the vowel alternations exhibited in this class of noun stems are exactly the same as the alternations found in derivational umlaut and elsewhere.

In contrast to the 2-3 sg. umlaut, umlaut in Subjunctive II forms is relatively straightforward. In the strong verbs the stem vowel is always umlauted in Subjunctive II. For weak verbs, however, no umlauting occurs in Subjunctive II. In other words, only when the subjunctive e affix is attached to a [-D] stem does umlauting occur. This has been represented in the subcategorization of the subjunctive affix e, repeated in (61):

$$(61) \quad e / \begin{matrix} ]+V \\ \langle -D \rangle \end{matrix} \langle +U \rangle ]+V$$

The angle bracket notation is used to indicate that the subjunctive e suffix is [+U] only in conjunction with a [-D] stem. Alternatively we could represent these facts as in (62):

$$(62) \quad \begin{array}{c} e \\ +U \end{array} / \begin{array}{c} ] \\ -D \end{array} \text{ ---} \\ \\ e / \begin{array}{c} ] \\ +V \end{array} \text{ ---} \\ \text{elsewhere}$$

(62) suggests that there are two subjunctive e suffixes in complementary distribution. Either (61) or (62) must be used at some cost to the grammar, since both angle brackets and 'elsewhere' conditions are powerful devices. At this point, there seems to be no empirical basis for deciding between them. However, either is to be preferred to an analysis in which umlauted stems are listed for all strong verbs, since the umlaut alternations that appear in the Subjunctive II are identical to those that are produced by the regular umlaut rule.

### 3.3.3. Adjectives

One last case in which umlaut occurs in inflection will be discussed. As the examples in (63) indicate, the comparative and superlative forms of some adjectives show umlaut:

- (63) a.           alt,    Älter,    Ältest  
                   arg,     Ärger,    Ärgest  
                   arm,     Ärmer,    Ärmest
- b.           bang,    { banger } ,    { bangst }  
                           { bÄnger }    { bÄngst }

blass,	{ blasser } ,	{ blassest }
	{ bl�sser }	{ bl�ssest }
from,	{ frommer } ,	{ frommst }
	{ fr�mmer }	{ fr�mmst }

c.           bar,     barer,   barest  
               froh,    froher,   frohest  
               dumm,   dummer,   dummest

Moreover, as the examples in (63) show, some adjectives with -er and -est always have umlaut, others have both umlauted and nonumlauted variants, and still others (perhaps the majority) do not umlaut. A first approximation to characterizing the data in (63) would be to say that -er and -est are suffixes exactly like the derivational suffixes -lich and -ig. They would be listed in the permanent lexicon with the feature [+U], meaning that they can be [+U] or [-U] in any given derivation. They would have the subcategorization frames in (64):

(64)

$$\begin{array}{l} \text{-er} \\ \text{[+U]} \end{array} / \quad ]_A \text{ --- } ]_A$$

$$\begin{array}{l} \text{-est} \\ \text{[+U]} \end{array} / \quad ]_A \text{ --- } ]_A$$

Thus, we seem to have cases of umlaut-variable inflectional affixes as well as cases of umlaut variable derivational affixes. This state of affairs is exactly as predicted by the theory of word formation I have been developing here.

The subcategorization frames in (64) are not quite correct, however. That is, as they stand, it is possible to generate paradigms

in which the comparative form of a given adjective is unumlauted and the superlative form unumlauted, or vice versa (e.g., from, frömmer, frommest, or from, frommer, frömmest). As far as I know, variation of this sort does not occur. Instead, whatever value of the umlaut feature is chosen for -er is also chosen for -est. The two, in some sense, are not independent affixes in the way that -lich and -ig are. At present, I have no interesting way of accounting for this observation, and merely bring it up here as a problem for further study.

#### 3.4. Umlaut and Conversion

One area of German morphology remains to be discussed in order to complete our survey of umlaut phenomena in German, namely the interaction of umlaut and morphological conversion. I argued in Chapter 3, largely on the basis of German facts, that morphological conversion is not the affixation of a zero morpheme, nor any other directional morphological process. Instead, I argued that members of conversion pairs are individually listed in the lexicon, along with their semantic representations (partial or whole), insertion frames, and subcategorization information. A single, general redundancy rule, perhaps symbolized as  $N \leftrightarrow V$ , states that such pairs are highly valued in the grammar of German. This redundancy rule, as it stands now, requires phonological identity of nouns and verbs for the conversion relationship to hold. However, along with pairs of nouns and verbs like those in (65a), German also has pairs like those in (65b):

- (65) a.           Aal   'eel'                    aalen  
                   Fuss  'foot'                  fussen

- b.           Ader (pl. Adern)    ʏdern  
               Affe (pl. Affen)   ʏffen

For the pairs in (65a) we must simply assume that the verb stems and noun stems are listed in the permanent lexicon in something like their surface phonological form. The pairs will automatically be related by the redundancy rule. The pairs in (65b) are less straightforward, however. If we assume here too that both the noun stem (e.g., Aff) and the verb stem (ʏff) are listed with their surface phonological forms, these stems would not be related by the redundancy rule for conversion. One member of these pairs is umlauted and the other is unumlauted. Yet these pairs of stems intuitively stand in the conversion relation to one another.

Of course, it is possible to rewrite the conversion relation so that it relates stems which are phonologically identical, except with respect to the backness of the stem vowel:

$$(66) \quad [C_o \quad \begin{bmatrix} +syl \\ \alpha hi \\ \beta lo \\ \gamma rd \end{bmatrix} C_o]_N \longleftrightarrow [C_o \quad \begin{bmatrix} +syl \\ \alpha hi \\ \beta lo \\ \gamma rd \end{bmatrix} C_o]_V$$

This solution is unattractive in a number of respects. First, it obviously builds umlaut into the conversion rule itself. Since the vowel alternations that occur between noun and verb pairs are exactly those that are produced by our independently needed umlaut rule, we should be suspicious of an analysis which allows a rule like (66). Moreover, allowing a rule like (66) opens the door to permitting all sorts of unconstrained redundancy rules for conversion. If we allow

umlaut to be built into the conversion rule itself, there is no reason why other sorts of stem differences between members of conversion pairs couldn't be sanctioned as well. This is a consequence we should try to avoid.

Another analysis is possible within the present framework, however. Suppose that the noun stems and verb stems are in fact phonologically identical as far as their entries in the permanent lexicon go. The verb stems will differ from the noun stems in bearing the feature [+U], as illustrated in (67):

(67)	<u>NOUN</u>	<u>VERB</u>
	Affe	aff [+U]
	Fuhre	fuhr [+U]
	Krone	kron [+U]
	Mass	mass [+U]
	Schande	schand [+U]
	Schmuck	schmuck [+U]
	Schranke	schrack [+U]
	Futter	futter [+U]

Within the permanent lexicon, noun stems and verb stems will be related by the regular  $N \longleftrightarrow V$  conversion relation. This relation can then be stated in its most general and highly constrained form. The umlaut rule will apply in its most general form as well to umlaut the verb stems. The number of verbs in German requiring the [+U] feature is really quite small (perhaps 40-50), so the complication involved in assigning the umlaut triggering feature to these stems would not be particularly great.

The above analysis makes yet another prediction about the occurrence of [+U] verb stems in other word formation processes. That is, once the

verb stem has been entered in the permanent lexicon with the idiosyncratic [+U] marker, this feature ought to be present whenever such a verb stem acts as the base for further derivation: in other words, it ought to be the case that these verb stems occur with umlaut regardless of the sorts of suffixes which attach to them. This seems, in fact, to be the case. The suffix -ung in German attaches to verb stems to form nouns:

(68)	tragen	Tragung
	bilden	Bildung

Since -ung has a back vowel, it is automatically a [-U] suffix. Yet when it attaches to the idiosyncratic [+U] stems listed in (67), the stems are always umlauted:

(69)	Führung
	Fütterung
	Krönung
	Mässung
	Schändung
	Schmückung

The umlauting must obviously be attributed to properties of the stem, rather than to properties of the suffix, and the use of the [+U] feature captures this observation nicely.

### 3.5. Umlaut Summary

In this section, I have proposed an analysis of umlaut in which morphemes in the permanent lexicon, usually affixes, are assigned a feature [+U]. A string dependent morphological rule, repeated below as



(70), operates within the third subcomponent of our morphology to front vowels in the environment of this feature:

(70)                    [+sy1] → [-bk] / \_\_\_ C<sub>o</sub> [+U]

This analysis accounts for the presence of doublets (i.e., forms which are identical in structure, but differ in that one has umlaut and the other lacks umlaut) and makes no false predictions about the patterns of umlauting illustrated in (47). From the discussion here, some of the salient properties of this rule, besides its string dependent nature should have become apparent. These properties are made explicit in (71), partly by way of summary, and partly as a prelude to the final section of this chapter in which I will try to draw together the facts about German umlaut and Tagalog reduplication we have gathered.

- (71) a. Umlaut is a pervasive rule in that it appears over and over again in the same form in word formation processes which are otherwise quite distinct. Umlaut appears in derivation, in noun, verb, and adjective paradigms, and in conversion pairs, triggering identical vowel alternations in each case.
- b. Consequently, umlaut can be assigned no fixed semantic representation. In fact, it is doubtful whether we would consider umlaut to have any semantic effect at all. That is, unlike Tagalog reduplication which has a semantic effect only in conjunction with another affix or feature, umlaut adds nothing to the semantic representation of a word:<sup>10</sup> -lich or -ig have identical semantic representations in forms in which they condition umlaut and in forms in which they do not

condition umlaut. Plural stems with umlaut are no different from plural stems without umlaut, etc.

- c. Umlaut does nothing to derange the structure of a word once this has been built up in the lexical structure component: it merely fronts a preceding vowel. In this sense, umlaut is structure preserving rather than structure creating.
- d. The umlaut rule is a 'triggered' rule in that the fronting process applies only in the environment of the feature [+U] which is assigned in the permanent lexicon to certain suffixes and stems.
- e. Umlaut never by itself changes category in word formation. In conjunction with affixation, whether inflectional or derivational, we might say that it is the affix which provides the category of the derived word. For example, -lich must have the subcategorization frame:

$$\begin{array}{c} ]_V \text{ --- } ]_A \\ N \end{array}$$

whether or not it triggers umlaut in any given derivation. Umlaut itself has no part in the category change. Moreover, there are no pairs  $[C_o V C_o]_\alpha$  and  $[C_o \check{V} C_o]_\beta$  such that  $\alpha$  and  $\beta$  are different categories, and the latter stem must be derived from the former by umlaut. Even in conversion pairs, where this superficially seems to be the case, I argued that phonologically identical morphemes are listed as nouns or verbs in the permanent lexicon, the verbs bearing the feature [+U]; there is no process of umlaut which creates a verb Yffen

from a noun Affe.

- f. Umlaut is a strictly local rule. An umlaut feature never triggers umlaut on stem vowels in cases such as [[Guck] er] lein], where another vowel intervenes between the back vowel and the umlaut trigger (on -lein). Rather, umlaut only affects the vowel immediately to the left of the trigger.

#### 4. Theoretical Speculations

A quick comparison of the characteristics of umlaut listed in (71) and the characteristics of Tagalog reduplication listed in (38) yields the rather surprising observation that the two rules display precisely the same cluster of properties. Both are pervasive, semantically neutral in some sense, structure preserving, triggered, non-category changing, and (if my reanalysis of reduplication proves to be correct) local. With respect to the sets of data we are describing with these rules, there would seem to be no reason a priori to expect this to be the case; superficially, at least, umlaut and reduplication are quite different sorts of processes. I would like to argue here, however, that with respect to the theory of word formation I have been developing, we have every reason to believe that this coincidence of properties is not, in fact, accidental. Instead, the appearance of just this cluster of properties follows directly from the organization of the lexicon proposed in Chapter 2, together with the fact that both umlaut and reduplication are string dependent morphological processes.

In order to explain the occurrence of these properties, it is necessary to unpack an assumption that has been implicit in the

discussion all along. In the course of this discussion, I have claimed that all morphemes which are listed in the permanent lexicon have certain idiosyncratic information represented in their lexical entries. All morphemes have lexical entries containing semantic representation, category and subcategorization information, insertion frames or argument structures, and diacritic features, if necessary. I have also been assuming, however, that only morphemes listed in the permanent lexicon have a representation of such idiosyncratic information. That is, the only proper repository within my theory for idiosyncratic information is in lexical entries, and hence, in the permanent lexicon. Idiosyncratic information can therefore be assigned only to morphemes. The theory of the lexicon advocated here differs from a word formation theory like Aronoff's in this respect. It is only in my lexical structure theory that idiosyncratic information is isolated in one specific subcomponent of the morphology. In contrast, within Aronoff's theory, idiosyncratic information can be assigned to rules as well as to lexical entries. Affixation is done by rule, for Aronoff, and it is therefore part of a word formation rule that, e.g., -ness forms nouns, attaches to adjectives, is [-Latinate], and so on. With respect to affixational morphology, the strong generative capacity of the two theories might seem to be the same: derived words with -ness are assigned the same internal structure and the same properties by either theory. However, the strength of the constraints on the representation of idiosyncratic information imposed by my lexical structure system becomes much more apparent when we turn to string dependent rules. Within Aronoff's

theory, it is possible to assign to a string dependent morphological rule such as umlaut or reduplication the same sort of idiosyncratic information we can assign to an affixational word formation rule, namely semantic representation, category and subcategorization, insertion frames, diacritics, and so on. Within my theory, there is no mechanism for assigning this sort of information to string dependent rules. String dependent rules are not like morphemes, they lack lexical entries, and therefore lack the information which belongs in lexical entries.

Whether or not string dependent morphological rules are "like" morphemes in that they bear semantic representations, attach diacritic features, have subcategorization, etc. is clearly an empirical issue; it is logically possible that string dependent rules have exactly the same properties as non-string dependent morphology. In fact, the two analyses worked out in this chapter provide evidence that string dependent rules have their own unique set of properties which are not the properties of lexical structure morphology: a number of properties we observed for both umlaut and Tagalog reduplication are properties which follow directly from a lack of idiosyncratic "lexical entry" sort of information.

Both reduplication in Tagalog and umlaut in German, it was argued earlier, lacked any easily identifiable semantic representation. Reduplication had some semantic effect in Tagalog words, but this effect could only be determined in conjunction with other affixes, or → other features (e.g., [<sub>±</sub> Actual Aspect]); moreover, this effect varied from one morphological context to another. Umlaut had no discernable

semantic effect at all. But this is exactly as predicted by my theory of lexical organization: unique semantic representations belong to the sort of idiosyncratic information only assigned to morphemes in their lexical entries.

Neither umlaut nor reduplication, by itself, ever operates to form a derived word which differs in category from its base. Again, this property follows from the claim that string dependent rules are not like morphemes. Only morphemes belong to category classes and have subcategorization frames, since this is information represented in lexical entries. In conjunction with an affix (which is itself category-changing) umlaut and reduplication may work to form derived words different in category from their bases, but by themselves, they cannot.

Connected with this lack of category and subcategorization is the property that umlaut and reduplication are triggered rules. Since these string dependent rules lack subcategorization, their environments must be signalled in some way. In the absence of triggering features such as the [+RA] feature on Tagalog V' suffixes and the [+U] feature on German morphemes, neither reduplication nor umlaut would "know" where to apply. Again, the fact that umlaut and reduplication are triggered rules follows from their lack of permanent lexicon information.

Also connected with the lack of lexical entry sort of information on string dependent rules is the apparent pervasiveness of umlaut and reduplication. We might imagine that in the absence of any particular characterization of the semantic effect, category, subcategorization

and other idiosyncratic features of these rules, they might be available for a wide variety of functions. The repeated appearance of the same reduplication and umlaut rules in derivation and inflection, noun, verb and adjective morphology therefore becomes a function of their relative lack of specific lexical information.

One final property which we observed in both umlaut and reduplication can be made to follow from my theory of lexical organization, but not this time from the difference between morphemes and string dependent rules. We observed earlier that both umlaut and reduplication were structure preserving in that they did not need to change or add structural bracketing, but instead merely operated on the consonants and vowels in the segmental string. Implicit in my framework so far has been the assumption that all string dependent rules apply in a block following affixational (lexical structure) morphology. String dependent rules cannot operate until all insertion of morphemes into a tree has been completed. All structure has been created by the rule which generates binary branching unlabeled trees before string dependent rules ever operate. Accepting this organization for the lexicon therefore predicts that rules such as umlaut and reduplication would have to be structure preserving. The fact that umlaut and reduplication in fact seem to have this property provides strong confirmation for the lexical organization proposed here. Notice, moreover, that this state of affairs is not the only logical possibility. For example, in Aronoff's theory of word formation, affixation and string dependent rules were accomplished by the same formal mechanisms, and these rules could therefore

theoretically be interspersed. If rules of affixation could create new bracketings, string dependent word formation rules could also create new bracketings. But neither umlaut nor Tagalog reduplication take advantage of this option allowed by Aronoff's theory. The more restrictive theory of lexical organization developed here is therefore to be preferred.

The only property shared by umlaut and reduplication I have not yet discussed is the property of locality. Here, however, I have little to say: it follows neither from our restrictions on lexical entries nor from the restriction on the ordering of morphological rules that string dependent rules must be local. However, as a theory which requires that string dependent rules be local is more restrictive than a theory which allows unbounded rules, the fact that both umlaut and reduplication are local is consistent with the more highly valued theory. We might therefore stipulate as a part of the theory that string dependent rules are local.

It should be clear, by now, that the theory of lexical organization developed here is a highly restrictive theory of word formation. I started this chapter with an attempt to restrict our theory by prohibiting morphological rules with transformational power. I argued that the only proposal to date which allowed rules of reduplication to be stated non-transformationally, namely McCarthy's autosegmental sort of morphology, did not yield a coherent analysis for Tagalog. Given this, it was necessary to weaken our theory to permit transformational rules. However, the discussion here suggests that the theory of lexical structure developed in Chapters 1-3 already places fairly stringent constraints on possible lexical transformations



and possible string dependent lexical rules in general:

(72) Constraints on String Dependent Rules

- a. No string dependent rule can be assigned lexical entry information.
- b. String dependent rules must follow lexical structure in a block, and therefore must be structure preserving.
- c. String dependent rules must be local.

Such constraints rule out many conceivable morphological rules: unbounded lexical transformations, string dependent rules which turn nouns into verbs or verbs into nouns, or merely change the internal bracketing of words. The analyses of umlaut in German and reduplication in Tagalog presented earlier yield rules which obey these constraints and exhibit exactly the properties which follow from them. The conclusion we may therefore draw is that strong empirical support exists for a lexicon organized in the way I have argued for here.

## CHAPTER 4: FOOTNOTES

1. In some cases where there seems to be internal reduplication of a stem consonant, e.g., second binyan kattab, McCarthy argues that association of melody and template slots first proceeds from left to right. Following this, a special rule severs the association between the melody tier and the penultimate consonant of the template. The general principle of association then reassociates the template slot with the second consonant of the melody:

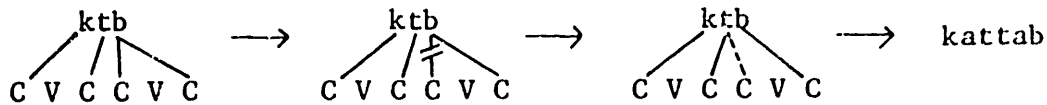

2. Carrier's refinements to these rules are primarily concerned with the proper statement of the environment for their application. This subject will be discussed later in this chapter. For my present purposes, a simpler statement of the rules will suffice, however.

3. Notice that it would not do to consider Tagalog reduplication to be a morpholexical process with the reduplicated stems having their own lexical entries alongside the non-reduplicated stems (e.g., (sulat, susulat)). In Chapter 2, I gave a number of characteristics distinguishing morpholexical rules from other sorts of morphological processes, one of which was the following: it is purely arbitrary whether or not a given lexical item conforms to the specifications of a lexical class as defined by its morpholexical rule(s). It is certainly not arbitrary, however, that lexical items in Tagalog undergo reduplication. For example, any verb stem can undergo RA and

have the concomitant aspectual interpretation (cf. below). If we were to formulate reduplication as a morpholexical relation, then, we would be representing as arbitrary a morphological process which is in fact not arbitrary at all.

4. According to Carrier (1979), the occupational prefix mang- chooses a nasal initial stem allomorph of the verb stem tahí?. See Carrier (1979) and Marantz (1979) for discussion of these facts, and arguments to the effect that the "nasal assimilation" process in Tagalog must be treated as stem allomorphy rather than as a regular phonological process.

5. Of course, where the subject topic marker is not mag-, the two aspects are distinguished slightly differently. See Carrier for a discussion of these facts, and for a statement of the morphological alternation between nag- and mag-.

6. Cf. Carrier (1979) for a discussion of these other analyses.

7. Iteration of the diminutive and augmentative affixes in Spanish can occur in only three forms: chico, poco 'small' can iterate the diminutive, presumably indefinitely, and grande 'large' can iterate the augmentative (cf. Harris (1979)). Whatever the explanation for these three forms, it is clearly the case that the augmentative and diminutive affixes do not iterate freely.

8. It is possible for speakers to differ as to the classification of a given suffix without damaging in any way the force of the arguments to follow: e.g., -chen could belong to class (40a) for some speakers, but to (40b) for others.

9. This oversimplifies the German paradigms a bit, since there exist verbs like senden and brennen, which have both stem changes and the suffix te in the past tense forms.

10. With respect to semantic interpretation, umlaut in German and reduplication in Tagalog differ in the following way: there will be semantic rules for Tagalog which refer to reduplicated stems in conjunction with other features of lexical structure. Where umlaut has no semantic effect -- e.g., in conjunction with derivational affixes like -chen, -lich, -ig, etc., verb paradigms, comparative adjectives, and so on, no rule of semantic interpretation will make reference to umlaut at all (i.e., this feature of lexical structure will be irrelevant to semantic interpretation). (In at least one case, namely plurals like Büch and Väter, there will be a rule of semantic interpretation which does make reference to umlaut -- i.e., in the presence of the category N on underived stems, [+U] will be interpreted as plural. In this case umlaut and reduplication are analogous.) Neither umlaut nor reduplication can have semantic representations in the way that morphemes do, however.

## BIBLIOGRAPHY

- Allen, M. (1978) Morphological Investigations, unpublished thesis, University of Connecticut, Storrs, Conn.
- Allen and Greenough (1975) New Latin Grammar, Caratzas Bros. Pub., N.Y.
- Ansre, G. (1963) "Reduplication in Ewe", Journal of African Languages 2:1, 128-132.
- Aronoff, M. (1976) Word Formation in Generative Grammar, MIT Press, Cambridge, Mass.
- (1978) "Lexical Representations", in D. Farkas et al., eds., Papers from the Parasession on the Lexicon, CLS, Chicago, Ill.
- (1979) "Contextuals", unpublished ms., SUNY Stony Brook, Stony Brook, N.Y.
- Aronoff, M. and F. Anshen (1979) "Morphological Productivity", unpublished ms., SUNY Stony Brook, Stony Brook, N.Y.
- Bender, B.W. (1971) "Micronesian Languages", in T. Sebeok, ed., Current Trends in Linguistics, Vol. 8, Mouton, The Hague, 426-465.
- Berlin, B. (1963) "Some Semantic Features of Reduplication in Tzeltal", IJAL xxix:3, 211-218.
- Bloomfield, L. (1933) Language, Holt, Rinehart and Winston, N.Y.
- Bosworth, J. and T. Toller (1898) An Anglo-Saxon Dictionary, Oxford University Press, Oxford.
- Brame, M. (1978) "The Base Hypothesis and the Spelling Prohibition", Linguistic Analysis, 4:1, 1-30.
- Bresnan, J. (1978) "A Realistic Transformational Grammar", in Halle, M., J. Bresnan and G. Miller, eds., Linguistic Theory and Psychological Reality, MIT Press, Cambridge, Mass.
- (1980a) "Polyadicity: Part I of a Theory of Lexical Rules and Representations", unpublished ms., MIT.
- (1980b) "Passivization: Part II of a Theory of Lexical Rules and Representations", unpublished ms., MIT.
- Campbell, A. (1959) Old English Grammar, Oxford University Press, Oxford.
- Carrier, J. (1979) The Interaction of Morphological and Phonological Rules in Tagalog: A Study in the Relationship Between Rule Components in Grammar, unpublished thesis, MIT.

- Carstairs, A.D. (1979a) "Inflectional Morphology I: Clitics, Affixes, Sensitivity and Closed Systems", unpublished ms., School of Oriental and African Studies, London.
- (1979b) "Inflectional Morphology II: The Status and Function of Paradigms", unpublished ms., School of Oriental and African Studies, London.
- Cassells Latin-English and English-Latin Dictionary (1953), Funk and Wagnalls Co., N.Y.
- Chomsky, N. (1955) The Logical Structure of Linguistic Theory, Plenum Press, N.Y. (1975).
- (1970) "Remarks on Nominalizations" in Studies on Semantics in Generative Grammar, Mouton, The Hague.
- (1980) "On Binding", Linguistic Inquiry 11:1, 1-46.
- Chomsky, N. and M. Halle (1968) The Sound Pattern of English, Harper and Row, N.Y.
- Christaller, J.G. (1875) A Grammar of the Asante and Fante Language Called Tshi (reprinted, 1964, by Gregg Press, England).
- Clark, E.V. and H.H. Clark (1979) "When Nouns Surface as Verbs", Language 55:4, 767-811.
- Dell, F. and E. Selkirk (1978) "On a Morphologically Governed Alternation", in S.J. Keyser, ed., Recent Transformational Studies in European Languages, MIT Press, Cambridge, Mass.
- Dresher, E. (1978a) Old English and the Theory of Phonology, unpublished thesis, UMass., Amherst.
- (1978b) "Review of Lass and Anderson, Old English Phonology", Language 54:2, 432-445.
- Ernout, A. (1974) Morphologie Historique du Latin, Editions Klincksieck, Paris.
- Freidin, R. (1975) "The Analysis of Passives", Language 51:2, 384-405.
- Gordon, E.V. (1957) An Introduction to Old Norse, The Clarendon Press, Oxford.
- Haeberlin, H.K. (1917) "Types of Reduplication in the Salish Dialects", IJAL 1:2, 154-174.
- Halle, M. (1973) "Prolegomena to a Theory of Word Formation", Linguistic Inquiry 4:1, 3-16.

- Halmos, P. (1960) Naive Set Theory, Van Nostrand Reinhold Co., N.Y.
- Harris, J. (1979) "Explorations in Spanish Word Structure: an X-bar Theory (pre-preliminary version)" unpublished ms., MIT.
- (1980) "Nonconcatenative Morphology and Spanish Plurals", unpublished ms, MIT.
- Hayes, B. (1980) A Metrical Theory of Stress Rules, unpublished thesis, MIT.
- Hust, J. (1978) "Lexical Redundancy Rules and the Unpassive Construction", Linguistic Analysis 4, 61-89.
- Jackendoff, R. (1974) "Morphological and Semantic Regularities in the Lexicon", Indiana University Linguistics Club.
- (1977) X̄ Syntax: A Study of Phrase Structure, MIT Press, Cambridge, Mass.
- Jaeggli, O. (1977) "Spanish Diminutives", unpublished ms., MIT.
- (1978) "On Abstract Case", unpublished ms., MIT.
- Joseph, B. (1979) "Lachmann's Law Once Again", Linguistic Inquiry 10:2, 363-365.
- Kaplan, R. and J. Bresnan (1980) "A Formal System for Grammatical Representation", unpublished ms., MIT.
- Katz, J.J. and Fodor, J.A. (1964) "The Structure of a Semantic Theory", in The Structure of Language, J.A. Fodor and J.J. Katz, eds., Prentice-Hall, Inc., Englewood Cliffs, N.J.
- Keyser, S.J. (1978) "Metrical Structure and Surface Regularity in Old English", unpublished ms., MIT.
- Kiefer, F. (1970) Swedish Morphology, Skriptor.
- Kiparsky, P. and W. O'Neil (1976) "The Phonology of Old English Inflections", Linguistic Inquiry 7:4, 527-558.
- Klausenburger, J. (1976) "(De)Morphologization in Latin", Lingua 40, 305-320.
- (1979a) "Is Lachmann's Law a Rule?", Linguistic Inquiry 10:2, 362-3.
- (1979b) Morphologization: Studies in Latin and Romance Morphophonology, Niemeyer, Tübingen.

- Lapointe, S. (1978) "Subcategorization and Cooccurrence Restrictions", unpublished ms., UMass., Amherst.
- Lass, R. and J. Anderson (1975) Old English Phonology, Cambridge University Press, Cambridge.
- Lederer, H. et al. (1969) Reference Grammar of the German Language, Scribners, N.Y.
- Lehnert, M. (1971) Reverse Dictionary of Present-Day English, Veb Verlag Enzyklopädie, Leipzig.
- Lewis, C.T. and C. Short (1975) A Latin Dictionary, Oxford University Press, Oxford.
- Lieberman, M. and A. Prince (1977) "On Stress and Linguistic Rhythm", Linguistic Inquiry 8:2, 249-336.
- Lieber, R. (1979) "Inflection and the Lexicon", unpublished ms., MIT.
- Maniet, A. (1975) La Phonétique Historique du Latin, Editions Klincksieck, Paris.
- Marantz, A. (1979) "Reduplication: Pseudo-problems and Para-paradoxes", unpublished ms., MIT.
- (1980) "Reduplication and C-V Skeleta", unpublished ms., MIT.
- Marchand, H. (1969) English Word Formation, C.H. Beck'sche Verlagsbuchhandlung, München.
- Mater, E. (1965) Rückläufiges Wörterbuch der Deutschen Gegenwartssprache Veb Bibliographisches Institut, Leipzig.
- Matthews, P.H. (1972) Inflectional Morphology, Cambridge University Press, Cambridge.
- (1974) Morphology: An Introduction to the Theory of Word Structure, Cambridge University Press, Cambridge.
- McCarthy, J. (1979) Formal Problems in Semitic Phonology and Morphology, unpublished thesis, MIT.
- Meillet, A. and J. Vendres (1963) Traité de Grammaire Comparée des Langues Classiques, Librairie Ancienne Honoré Champion, Paris.
- Miyagawa, S. (1980) "On 'Blocking' and Organizations within the Lexicon", unpublished ms., University of Arizona.
- Moravcsik, E. (1978) "Reduplicative Constructions", in J. Greenberg, ed., Universals of Human Language, Vol. 3, 297-334, Stanford University Press, Stanford.



- O'Neil, W. (1970) "Explaining Vowel Ablaut in Old English", General Linguistics, 10, 149-163.
- Perini, M.A. (1978) "The Latest Note on Lachmann's Law", Linguistic Inquiry 9:1, 144-5.
- Pesetsky, D. (1979) "Russian Morphology and Lexical Theory", unpublished ms., MIT.
- Platzack, C. (1979) "The Swedish Participle", unpublished ms., University of Lund.
- Quirk, R. and C.L. Wrenn (1955) An Old English Grammar, Methuen & Co., Ltd., London.
- Redenbarger, W. (1976) "Vowel Lowering and i-Epenthesis in Classical Latin", in Luján, M. and F. Hensey, eds., Current Studies in Romance Linguistics, Georgetown University Press, Washington, D.C.
- Reichard, G. (1959) "A Comparison of Five Salish Languages: V", IJAL XXV:4, 239-253.
- Rivas, A. (1977) A Theory of Clitics, unpublished thesis, MIT.
- Robins, R.H. (1970) Diversions of Bloomsbury, North-Holland, Amsterdam.
- Roeper, T. and M. Siegel (1978) "A Lexical Transformation for Verbal Compounds", Linguistic Inquiry 9:2, 199-260.
- Schachter, P. (1976) "A Non Transformational Account of Gerundive Nominals in English", Linguistic Inquiry 7:2, 205-242.
- Schane, S. (1979) "The Rhythmic Nature of English Word Accentuation", Language 55:3, 559-602.
- Selkirk, E. (1978) untitled, unpublished ms., UMass., Amherst.
- Siegel, D. (1973) "Non-sources for Unpassives", in J. Kimball, ed., Syntax and Semantics 2, Academic Press, N.Y.
- (1974) Topics in English Morphology, unpublished thesis, MIT.
- (1977) "The Adjacency Condition and the Theory of Morphology", Proceedings of NELS VIII, Amherst, Mass.
- Stephens, L. (1979) "Once Again Lachmann's Law", Linguistic Inquiry 10:2, 365-369.
- Strauss, S.L. (1976) "The Nature of Umlaut in Modern Standard German", CUNYFORUM, 1, 121-144.
- (1979) Some Principles of Word Structure in English and German, unpublished thesis, CUNY.

- Sturtevant, E.H. (1940) The Pronunciation of Greek and Latin, 2nd edition, William Dwight Whitney Series, Philadelphia.
- Thompson, L. (1965) A Vietnamese Grammar, University of Washington Press, Seattle.
- Wasow, T. (1977) "Transformations and the Lexicon", in P. Culicover, T. Wasow and A. Akmajian, eds., Formal Syntax, Academic Press, N.Y.
- Watkins, C. (1971) "A Further Remark on Lachmann's Law", in M. Tsiapera, ed., Generative Studies in Historical Linguistics, Linguistic Research, Inc., Edmonton, Alberta.
- Westermann, D. (1907) Grammatik der Ewe-Sprache, Dietrich Reimer, Berlin.
- Wilbur, R. (1973) The Phonology of Reduplication, Indiana University Linguistics Club.
- Williams, E. (1979) "On the Notions 'lexically related' and 'head of a word'", unpublished ms., UMass., Amherst.
- Wurzel, W. (1970) Studien zur deutschen Lautstruktur, Studia grammatica VIII, Akademie-Verlag, Berlin.

## BIOGRAPHICAL NOTE

The author was born in New York City, New York, on May 27, 1954, and attended Long Beach High School, Long Beach, N.Y. In 1976, she earned the A.B. degree, Phi Beta Kappa, with general honors and departmental honors in Anthropology from Vassar College. The recipient of an NEH Youthgrant, she spent January-August, 1976 doing ethnohistorical and linguistic fieldwork with the Hualapai Tribe of northern Arizona. At MIT she held research and teaching assistantships in the Department of Linguistics and Philosophy, and published the following articles: "On Middle English Lengthening in Open Syllables", Linguistic Analysis, 5:1, and "The English Passive: An Argument for Historical Rule Stability", Linguistic Inquiry, 10:4. In addition, she worked as Graduate Resident at McCormick Hall, MIT from 1978-1980. She has accepted a position as assistant professor in the Department of English at the University of Alabama in Birmingham, starting in September, 1980.