

Novel Design of a Rotary Valve using Axiomatic Design

by

Robert (Beto) Bilgor Peliks  
S.B., Mechanical Engineering (2003)  
Massachusetts Institute of Technology

Submitted to the Department of Mechanical Engineering  
in Partial Fulfillment of the Requirements for the Degree of  
Master of Science

at the

Massachusetts Institute of Technology  
June 2005

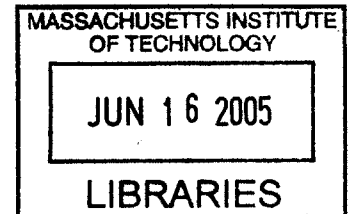

© 2005 Massachusetts Institute of Technology  
All rights reserved

Signature of Author.....  
Department of Mechanical Engineering  
~~March 25, 2005~~

Certified by.....  
Nam Pyo Suh  
Ralph E. Cross Professor of Mechanical Engineering  
Thesis Supervisor

Accepted by.....  
Lallit Anand  
Professor of Mechanical Engineering  
Chairman, Department Committee on Graduate Studies

**BARKER**

# NOVEL DESIGN OF A ROTARY VALVE USING AXIOMATIC DESIGN

by

Robert (Beto) Bilgor Peliks

Submitted to the Department of Mechanical Engineering  
on March 25, 2005 in partial fulfillment  
of the requirements for the Degree of Master of Science

## ABSTRACT

Rotary valves have existed for millennia; and while they have developed tremendously since the first Roman valves, many of the same problems have persisted. The basic problems are caused by the coupling of functional requirements, which limits the valve's performance. Using axiomatic design (AD), two of these couplings, including the coupling of the friction-sealing FRs, are studied and resolved. Although more work can be done to improve the patent-pending designs, the concepts presented represent advancements over existing rotary valve designs. The proposed designs have been analyzed for their merits as a valve and for their potential applications, such as in automotive engines.

Thesis Supervisor: Nam Pyo Suh

Title: Ralph E. Cross Professor of Mechanical Engineering



# ACKNOWLEDGEMENTS

Prof. Suh,  
Your knowledge, your experience, and your understanding—I aspire to reach. At times it was frustrating—it felt like I was lost—but, you had faith through it all, even without me knowing it, and I have so much more confidence than I did before embarking on this journey. Thank you for the opportunity—I am grateful for my fortune of having you as an undergraduate advisor and for the relationship continuing on through grad school.

LMP lab,  
Gerry, Mark, Pat and Dave—thank you all for your help. I wouldn't be here without your help. You guys made it easy and efficient for me to develop and test my valve. I have learned so much from you guys—this thesis is also a testament of your knowledge...and I didn't forget: a few million when it gets big...

B.J. Park,  
Thank you very much for setting up such a generous fund and sponsoring my research. Your focus on education has benefited a number of students, and I hope I met your expectations when setting up the fund.

The parents,  
I guess this is the first real, 'public' acknowledgement of your effort (...not that anyone will read the thesis). So, thanks. There's not much more to say than that—I could thank you for paying my tuition so far, for feeding me, clothing me, teaching me, supporting me, and so on; but the list is too long. There's just so much to say, that I can only say 'thanks'.

The lab,  
Thanks for the ideas, the help and the fun. It was a good ride and I hope you all the best...Hrishi as a world class professor (with a ScD, no less!), AJ as the first professor to win the Iron Man, Peter as the head of NASA and Kris in G'06...and every 4 years after that. I'd love to hang around with you guys for another few years in Boston...except for the PhD part and the weather.

The brother,  
Thanks for the help—I'll get you some Kings when you sell it.

MIT, CMI, TLO,  
The sponsors,  
Thanks for your generous donations: John Fanner and Keith Schorr (Cummins); Richard Comeau (harmonic-drive.com); John Greer (jgreer.com); Dr. Evans (Coates); Tanya Bradby (Mid-Mountain Materials); Prof. Gutowski (MIT)

# TABLE OF CONTENTS

ACKNOWLEDGEMENTS .....	3
TABLE OF CONTENTS .....	4
<b>1. INTRODUCTION .....</b>	<b>6</b>
<b>2. INTERNAL COMBUSTION ENGINE.....</b>	<b>7</b>
2.1. THE IC ENGINE.....	7
2.2. THE ECOGIN.....	7
<b>3. ROTARY VALVE.....</b>	<b>11</b>
3.1. PRIOR ART.....	11
3.1.1. Valves.....	11
3.1.2. Rotary Valves.....	12
3.1.3. AD Applied to Rotary Valves.....	14
3.2. ROTARY VALVE REVOLUTION.....	23
3.2.1. THE MAIN IDEA.....	23
3.2.2. SOME VARIABLES.....	25
3.2.2.1. GEOMETRY.....	25
3.2.2.2. ORIENTATION (GEOMETRIC / PRESSURE).....	26
3.2.2.3. MATERIALS.....	28
3.2.2.4. ACTUATION.....	28
3.2.2.5. OPENING.....	29
3.2.3. THE SAMPLES.....	30
3.2.3.1. D01A.....	30
3.2.3.2. D01B.....	39
3.2.3.3. D02A.....	46
3.2.3.4. D02B.....	54
3.2.3.5. D03A.....	59
3.2.3.6. D03B.....	64
<b>4. TECHNICAL.....</b>	<b>69</b>
4.1. WEAR.....	69
4.2. CYCLIC FATIGUE.....	71
4.3. DYNAMICS.....	76
4.4. POWER.....	79
4.4.1. Inertial Power.....	79
4.4.2. Drag Power.....	80
4.4.3. Pressure Power.....	81
4.4.4. Frictional Power.....	81
4.4.5. Total Power.....	82
4.5. FORCES.....	83
<b>5. EXPERIMENTAL (SEALING).....</b>	<b>85</b>
5.1. INTRODUCTION AND SETUP.....	85
5.2. RESULTS.....	87
5.2.1. Large Port.....	87
5.2.2. Meshed Port.....	88
5.3. SUMMARY.....	88
<b>6. CONCLUSION.....</b>	<b>91</b>
<b>7. APPENDIX.....</b>	<b>93</b>





7.1. PRESSURE TESTS—RAW DATA .....	93
7.2. IMAGES .....	94
<b>8. ADDENDUM: THE FR-DP MAP.....</b>	<b>97</b>
8.1. ABSTRACT .....	97
8.2. INTRODUCTION .....	97
8.3. PAST WORK .....	98
8.3.1. <i>Design Matrix</i> .....	98
8.3.2. <i>Tree Diagram</i> .....	98
8.3.3. <i>Flow-Chart</i> .....	99
8.4. FR-DP MAP.....	100
8.4.1. <i>The Basics</i> .....	100
8.4.2. <i>Demo</i> .....	100
8.4.2.1. Solving the Design .....	103
8.4.2.2. FR/DP Hubs .....	104
8.4.2.3. Islands .....	105
8.4.2.4. Degree of Relation .....	105
8.4.2.5. Coupled loops .....	105
8.5. CONCLUSION .....	105
8.6. APPENDIX (FR-DP MAP).....	107
8.6.1. <i>Uncoupled</i> .....	107
8.6.2. <i>Decoupled</i> .....	107
8.6.3. <i>Coupled</i> .....	108
<b>9. BIBLIOGRAPHY .....</b>	<b>110</b>



# 1. INTRODUCTION

Axiomatic Design (AD) is a design methodology developed by Prof. Nam P. Suh which can be used to quantitatively compare designs and highlight problematic areas in a system. The main focus of AD is to create systems which can be easily produced and controlled with minimal effort. The methodology has been applied to a number of designs—ranging from organizational structures to CMP wafer polishing machines. A more detailed explanation of axiomatic design can be found in Suh's book, [Axiomatic Design: Advances and Applications](#)<sup>1</sup>.

One recent use of AD has been in the development of a low-emission engine developed by Ecogin Systems, Inc (US Patent 6,789,514). The engine—developed by several engineers, including Prof. Nam P. Suh—was based on an axiomatic design which would, in theory, provide better fuel-air mixing and thus minimize harmful engine emissions. WAVE simulations show the benefits of the Ecogin, but test results from the prototype are inconclusive. The causes of these poor results include improper testing equipment, insufficient time and money, as well as some design faults. One known design problem is that poppet valves do not provide fast enough actuation speeds, which was the main impetus for my research into the use of rotary valves in engines. The power required to actuate the poppet valves increases as the actuation speed becomes faster. The EcoGin design called for a design which required the poppet valves to use very stiff springs and thus negatively affected the power production of the engine. Because rotary valves need not oscillate, they can provide extremely high actuation speeds with higher efficiencies than poppet valves.

Although rotary valves are very common—they can be found in home plumbing and French horn valves, for instance—and have been used in engines to a limited extent, I discovered that existing rotary valves (even those used in engines) suffer from a number of couplings which jeopardize their success. Using AD, I not only highlighted these couplings but developed an innovative valve system which eliminates two of these couplings and can thus provide superior performance.

The valve technologies developed, however, can work in a number of environments. While the main impetus for the rotary valve design was for an engine, some embodiments of the valve are better suited for other applications—such as MEMS or cryogenics. Because the technology developed can be applied in a number of manners, not all of the embodiments were tested and thoroughly analyzed. In addition, due to time and budget constraints, an in-depth experimental study of the valve (including an engine test) was not conducted.

While working on the above projects, I gained a better understanding of AD which led to some of my own innovations to the theory. The FR-DP map, discussed in an addendum here, is an AD visualization tool which may provide a uniquely powerful insight into certain AD elements.

---

<sup>1</sup> See [11]



## 2. INTERNAL COMBUSTION ENGINE

### 2.1. THE IC ENGINE

Useful heat engines have been used for almost three centuries now, the first engines being defined as steam engines, which transferred chemical energy to kinetic energy via an intermediate fluid.<sup>2</sup> In 1860, J.J.E Lenoir developed the first marketable internal combustion engine. In this two-stroke engine, the air-gas would be drawn in and then ignited with a spark in the second-half of the first stroke. The charge would then be exhausted in the next stroke. Despite the low power (6 hp) and poor efficiency (~5%), approximately 5000 engines were sold from 1860 to 1865.<sup>2</sup>

In 1867, Otto and Langen introduced a more powerful and efficient internal combustion engine, but it was not until 1876, when Otto introduced his four-stroke engine, that IC engines really 'took off'. With the four-stroke cycle, the engine could be approximately a quarter the weight and the piston displacement was an order of magnitude less than previous designs. By 1890, over fifty thousand units had been sold.<sup>2</sup>

Since then, a number of advancements have been introduced, including Diesel engines, Wankel engines, fuel port injection, variable valve timing, and others. While engines become more efficient every year, they are often based on incremental improvements, such as a lighter poppet valve or modified fuel injection angles. While any improvement is great, it appears that more and more time is being spent on smaller advancements. Perhaps the modern IC engine is so far advanced that it is reaching that point in the curve where an extraordinary amount of effort is required for a less-than-impressive improvement.

### 2.2. THE ECOGIN

The Ecogin theoretically decouples the standard 4-stroke internal combustion engine by providing two separate cylinders: one for mixing and one for combustion. In doing so, one can better control the properties of the air-fuel mixture which is combusted. However, as the engine has two cylinders, to maintain a comparable power/weight ratio, the Ecogin must be 2-stroke instead of 4-stroke. To gain a better understanding of the Ecogin cycle, following are some schematic cross-sectional diagrams of the Ecogin engine during operation<sup>3</sup>:

---

<sup>2</sup> See p.2 of [7]

<sup>3</sup> See pp. 6 – 8 of [3]



### Operation at [1] ( $45^\circ$ ATDC)

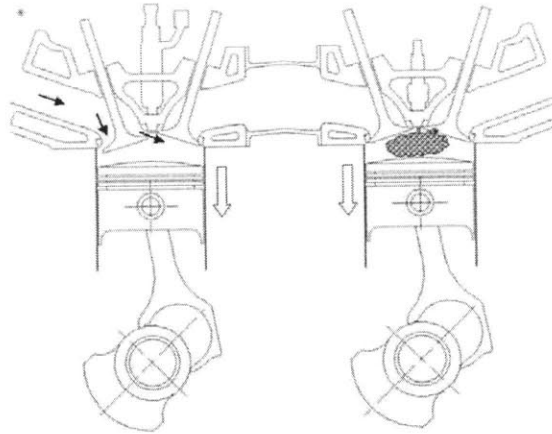

Figure 2.1

The mixing cylinder is drawing in fresh air as the power cylinder undergoes combustion.

### Operation at [2] ( $135^\circ$ ATDC)

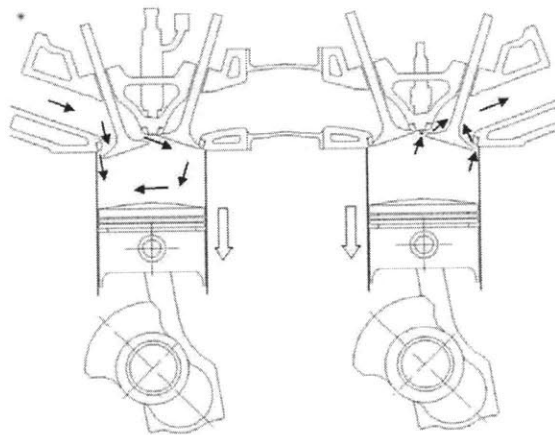

Figure 2.2

The mixing cylinder continues to draw in fresh air, but—similar to a 2-stroke engine—the power stroke is 'ending early' as the exhaust valve opens.

### Operation at [3] ( $270^\circ$ ATDC)

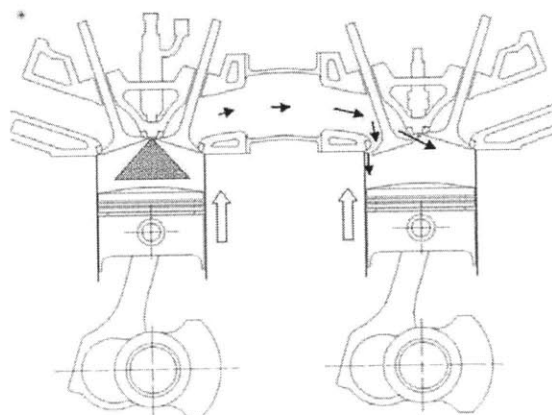

Figure 2.3

As the mixing cylinder compresses the fresh air, fuel is injected and begins to mix in the mixing cylinder. Once most of the burned fuel is exhausted, the fuel-air—which was stored under high pressure in the conduit—can be injected into the power cylinder.



By introducing two new reservoirs (a separate mixing cylinder and a conduit between the cylinders), the Ecogin can better control its processes. For instance, in the Ecogin, one may adjust the size of the mixing and power cylinders to better optimize their respective functions. In addition, by separating the two cylinders with a conduit—and guaranteeing that the cylinders are never in direct contact with each other—the Ecogin can provide better mixing and superior control over valve timing. There are numerous other benefits, which can be better understood by directly contacting Ecogin Systems, Inc.

Unfortunately, a number of problems exist with this design, which may explain a part of the reason that the Ecogin has not been successful yet. Referring specifically to the Ecogin executive summary, because of the high pressures used and the relatively short valve durations—and thus high valve speeds required—a “very stiff valve spring had to be used”<sup>4</sup>. This led to high friction losses and a compromise had to be made between high friction, minimizing leakage and providing optimal valve timing. As can be seen in *figure 2.2.6*, a 10 CAD overlap between IVO and EVC of the power cylinder was conceded to remain below the required EGR level.

Also, knock was prevalent in the engine, and can most likely be explained by the high pressures used in the system. For instance, although probably not designed as such—from the combustion test data provided, it appears that the pressure in the power cylinder is over 15 bars before spark. This is most likely the cause of the excessive knocking and can be solved relatively easily by adjusting the clearance volume in the power cylinder. Moreover, the pressure in the conduit is often over 40 bars—which, as a self-contained unit with proper cooling, may be fine—and may result in knock when injecting high pressure gas into a hot combustion chamber. While some other problems are noted, a detailed description of the Ecogin engine is outside the scope of this paper.

The Ecogin 1.0 was a brave attempt to revolutionize a well-defined field. While thousands of engineers are improving engines every year, few try breakthroughs as significant as the Ecogin team have done. Although their first attempt did not yield conclusive results, it is that kind of mentality which will help push us to new levels. Indeed, it is out of the Ecogin project from which my research began. A new valve system was needed to contain high pressures while providing low-friction and high actuation speeds—and thus the rotary valve was studied.

---

<sup>4</sup> See p. 3 of [3]

## 3. ROTARY VALVE

### 3.1. PRIOR ART

#### 3.1.1. Valves

Although it is well believed that valves were used several thousand years ago, little is known about them prior to Greek and Roman times. The earliest type of valve was in fact a type of rotary valve, called a 'Plug valve' or 'Plug cock'.<sup>5</sup> The plug valve is designed with a through-port such that one can control the fluid flow through the port by rotating the plug relative to a housing. Since then, a number of valves, and valve-types, have been developed, but it was not until the industrial revolution—specifically with the invention of engines—that there arose a significant need for new valves.

Valves can be categorized into three main types: 1) 'multi-turn' or 'straight-line' valves which move in a linear fashion; 2) 'quarter-turn' or 'rotary-valves' which rotate about an axis; and 3) 'special' valves which do not seem to fit into the previous categories—but are not significant enough to warrant their own individual categories.

A reed valve is perhaps one of the simplest valves used—and it can still be found on many 2-stroke engines. Depending on the design one would most likely classify it as a special valve. It provides an elegant solution for a passive one-way valve, but can only be used under limited capacities in engines—such as an intake valve, in certain 2-stroke engines. In addition, it does not provide the precision control now desired by most engineers and can result in a relatively low volumetric efficiency.

A poppet valve is a type of 'Globe valve', which is straight-line valve. It is so defined because the motion of the valve is perpendicular to the port. One of the main benefits of the poppet valve is that it can seal almost any pressure (because it uses self-help) and it is a relatively simple system. However, it also has some disadvantages. First, while a minimum spring force is required to close the valve, the springs used in engines are significantly more powerful because they are not just required to lift the valve, but to do so quickly. Thus, the faster the valve must be actuated, the stiffer the spring, and thus the higher the friction loss. Second, because poppet valves oscillate, energy must be wasted in constantly accelerating and decelerating the valve. A number of other problems can be attributed to poppet valves, including noise and hotspots—but for the most part, they have worked well.

It is only now that we are pushing the limits of our engines—wanting them to run faster, cleaner and more efficient—that we are finally realizing the constraints of our current system. For instance, one very exciting field is Variable Valve Timing (VVT)—the ability to independently control valve timings so as to gain better efficiencies and possibly even eliminate a throttle—but to introduce such a system using poppet valves is extremely complicated. The best applications of VVT thus far have been rather modest: changing the valve phasing (i.e.—valve durations are the same, but the ability to change the start time) or providing high/low settings. Although the elegant designs have been

---

<sup>5</sup> See p. 31 of [14]



successful, they are not yet harnessing the ultimate capabilities of VVT—the ability to independently control all timing aspects of all valves.

One may argue that engineers are diligently working on the next great valve—a solenoid valve—but electro-magnetic valves are currently very large, delicate and energy intensive, so it will be a number of years before they are commercially packaged. However, even when they are small and robust enough, they still face many of the same problems as poppet valves; specifically, they are energy intensive—and, although perhaps being more efficient and more flexible than standard poppet valve, will not eliminate the problems inherent in the design, but only minimize them.

### ***3.1.2. Rotary Valves***

Rotary valves can be found in a number of applications, including mechanisms as common as French horns or a domestic turn cock for water/gas.<sup>6</sup> They can also be found in more demanding systems, such as engines, but are less widespread, because they are ideal for either low-friction or high-sealing applications but have difficulty achieving both simultaneously.

Rotary valves offer several advantages over other automotive valves. First, they can reduce energy losses for two main reasons: 1) there is no reciprocating motion, so there are minimal inertial losses; and 2) depending on the valve design, the force necessary to seal the port is resisted by bearings—thus the energy needed to actuate the valves is minimal. In addition, when coupled with a variable valve timing mechanism (which is a simple and low-cost design in a rotary valve), a rotary valve can eliminate the need for an engine throttle and thus minimize pumping losses.<sup>7</sup> There are several other advantages to rotary valves, such as high actuation speed and low cost.

There are two main categories of rotary valve geometries: cone and spherical. Using a broad definition of a cone, this category can include cylindrical (an angle of  $0^\circ$  with the vertical axis), disk (an angle of  $90^\circ$  with the vertical axis) and a cone of any angle between the two extremes. In the spherical geometry, the valve is a sphere which rests in a ring-shaped housing (i.e.—a ball valve).

Each design has its own merits. For instance, using a cylindrical geometry, one can use a lengthy valve to control the flow through several in-line cylinders (thus minimizing the total part count); however, thermal expansion can be a significant problem. Coned geometries help solve the thermal expansion problem because a slight shift in the vertical direction can accommodate for any change in angle or diameter; however, manufacturing can be more expensive and each cylinder will need its own independent valve. Spherical geometries can provide very good sealing but manufacturing is expensive and tolerances can be difficult to achieve/maintain.

In addition to the basic geometries, a number of other rotary valve advancements have helped improve their performance. These range from mechanisms which apply lubrication oil to floating seals (which help minimize friction while improving sealing).

---

<sup>6</sup> See p. 17 of [8]

<sup>7</sup> See [5]



In addition, advancements in materials have been applied to rotary valves to help manage the extreme temperature and stress conditions in engines.

The first production rotary valve engine appeared in 1886 from Messrs. Crossley Bros., Ltd. of Openshaw, Manchester. The 4-stroke engines were manufactured for a period of sixteen years and indicate that at the time rotary valves were “accepted by engineers as a sound mechanical device.”<sup>8</sup> While the cylindrical rotary valve geometry was robust (i.e.—it did not break), it was a very delicate system which required many precision adjustments. For instance, a retaining spring for the valve had to be fine-tuned frequently: “if the spring load was too light, the oil would be blown out each time the engine fired, and if too heavy, any extra expansion of the rotor due to [thermal expansion] resulted in so much additional friction that...the engine would lose speed.”<sup>9</sup>

This initial design was followed closely by numerous other noteworthy achievements, including:

- National Gas and Oil Engine Co., Ltd (1895) built two types of engines using rotary valves—and it is believed that some engines continued to be used until 1935.<sup>10</sup>
- C. Lorenzen Rotary Valve with Balanced Pressure (1909) which minimized friction by reducing the contact area of the valve with the housing and attempted to use a pressure-balance system to help seal against high pressures.<sup>11</sup>
- Adams Manufacturing Co., Ltd (1908) used rotary valve engines in the cars it sold. A combination of rotary valves and reed valves were used (the rotary valves controlled the amount of air, the reed valves prevented air from returning—thus minimizing the high-pressure sealing of the rotary valve).<sup>12</sup>
- Mr. Howard E. Coffin—once head of the American Society of Automotive Engineers—declared at a 1911 meeting of the Institution of Automobile Engineers that “there are several American valve mechanisms which seem to promise well. Every one is of a rotary or rotary valve type.”<sup>13</sup>
- Cross engine (1922) dealt with many problems, including: sealing (by minimizing length of contact seal), friction (by applying oil effectively, and scraping off excess oil), thermal expansion (by cooling valve and matching expansion rates)<sup>14</sup>
- Aspin (1937) was among the first to successfully employ a conical valve geometry as well as other advancements in engine cooling.<sup>15</sup>

Several other rotary valves were developed later, including the Burt-McCollum Engine, which, in 1924, the Air Ministry claimed had “an output and efficiency far

---

<sup>8</sup> See p. 74 of [8]

<sup>9</sup> See p. 78 of [8]

<sup>10</sup> See p. 81 of [8]

<sup>11</sup> See p. 84 of [8]

<sup>12</sup> See p. 95 pf [8]

<sup>13</sup> See p. 15 of [8]

<sup>14</sup> See p. 113 of [8]

<sup>15</sup> See p. 129 of [8]

beyond anything that had been attained at that date.”<sup>16</sup> However, skipping ahead a few decades to 1994, the most recent significant rotary valve venture was undertaken by Coates Engines, Inc., which developed the Coates Spherical Rotary Valve (CSRV). As shown in *figure 3.1*, the CSRV uses a spherical valve system resting on a ‘floating ceramic-carbon seal’. Among other claims, Coates states that the CSRV could decrease fuel consumption by 20%.<sup>17</sup> While this valve has been used in some engines, it has not yet obtained a significant market share in the automotive market.

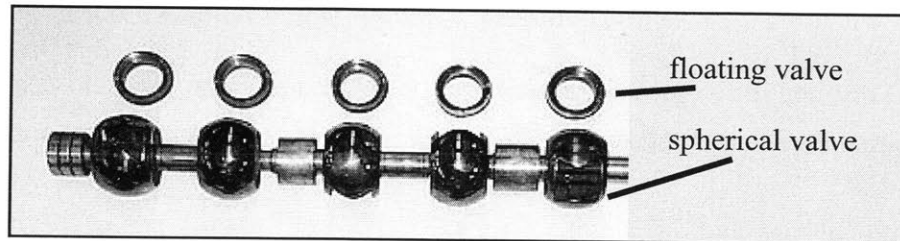

(Figure 3.1<sup>18</sup>: CSRV components)

### 3.1.3. AD Applied to Rotary Valves

While rotary valves have improved in the last century, none have been truly successful in entering the commercial automotive valve market. Aside from cost, there are several hurdles hindering the wide-spread use of the valve, but the most significant difficulties can be shown using axiomatic design. Below is an abbreviated AD design of a typical rotary valve in which I tried to blend together the best aspects of existing rotary valves.

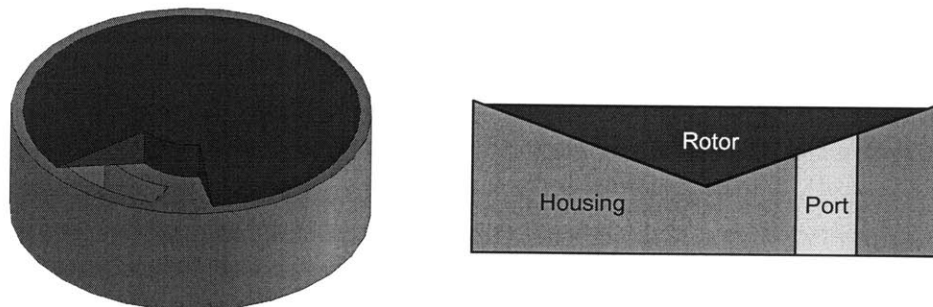

(Figure 3.2: conical rotary valve)

<sup>16</sup> See p. 145 of [8]

<sup>17</sup> See [1]

<sup>18</sup> See [15]

## BASIC DESIGN

---

**FR0: Control flow of high pressure gas through port**

**DP0: Conical rotary valve system**

**C1: Function between 0° C and 400° C**

**C2: Be non-reactive to air/fuel**

**C3: Function for 10<sup>8</sup> cycles**

**C4: Low-cost**

**C5: Low-energy loss**

---

The main FR of a valve is to control the flow of a substance through a port. The substance may be solid, liquid, gas, or any combination thereof. Although during a cold-start the fuel is still a liquid, one can assume that an automotive valve must control the flow of a high pressure gas—composed of air and vaporized fuel. As such, the valve cannot react with the fluid and must be stable under a wide temperature range. In addition, for marketing reasons, the valve must be low-cost and should last for several years (a reasonable lifetime is on the order of 10<sup>7</sup> or 10<sup>8</sup> cycles) Finally, one of the main reasons for using a rotary valve is that it can be more energy efficient than other valve types.

To satisfy these requirements, a conical rotary valve has been chosen. The reasons for studying a rotary valve have been described in earlier sections. Although other geometries could have been chosen (such as cylindrical, disk or spherical), conical was chosen for its conceptual simplicity and good functionality.

---

**FR1: Seal port**

**DP1: Sealing system**

**FR2: Open port**

**DP2: Open-flow system (cut in rotor)**

**FR3: Control timing**

**DP3: Actuation system**

**FR4: Minimize friction**

**DP4: Friction reduction system**

---

X	0	X	X
0	X	0	0
0	X	X	0
X	0	X	X

FR0 can be decomposed into a number of children. The valve must be able to control the flow through the port, but only as a binary switch—in other words, the flow should be on/off and need not work in any flow regimes between the two extremes. Invariably, any valve will have a transition phase between open and closed, but that region need not be ‘controlled’ in our valve and should in fact be minimized (so as to allow maximum flow). As with any actively actuated valve, one should be able to control the timing. Finally, to satisfy C5, an FR has been added to reduce the friction.

The DPs are still quite broad in this high level, but a matrix has been developed (it was modified once the design had been decomposed further). Already, one can see a

coupling between FR1 and FR4. In other words, it is difficult to provide adequate sealing and low-friction in the existing design. Upon further inspection, one may notice that the couplings occur because it is difficult to find materials and geometries which can provide low-friction while still maintaining a seal (the complete design matrix can be found at the end of this decomposition). This problem is especially difficult to solve because of the design constraints. For instance, because of C1 (temperature range), only metals and ceramics may be used (with the exception of some materials which are unpractical due to cost). In addition, the parts should be low-cost, withstand wear and be non-reactive. To seal, the material must be stiff, have a smooth surface finish and must have a specific rate of thermal expansion. To be low-friction, the material should contain micro-voids and the rotor/housing materials should be different. Already, one can observe a coupling between FR1 and FR4.

To satisfy these couplings, some interesting designs have been developed. For instance, many rotary valves use a floating valve seat to provide superior sealing while lowering the overall friction. However, most innovations are in better materials which can minimize the coupling between friction and sealing. For instance, as noted above, the CSRV uses a patented ceramic carbon valve seat—but this ‘expensive’ material only serves to minimize the effect of the coupling as opposed to eliminating it. While material solutions can improve the valve performance, they typically only provide incremental improvements over previous valve systems. To achieve substantial improvements, a new design must be developed (this situation seems analogous to the incremental improvements achieved in poppet valves, while a new valve system could potentially offer a substantial improvement).

***FR1.1: Provide/maintain micro-level sealing around port***  
***DPI.1: Surface finish***

***FR1.2: Provide/maintain macro-level sealing around port***  
***DPI.2: Geometric alignment***

X	X
X	X

The other significant coupling in this design is between FR1.1 and FR1.2. As can be seen in the complete design matrix below, this coupling is in fact a number of smaller couplings.

First, let us consider the manufacturing of the valve. To seal, the rotor and housing must be perfect complements—in other words, they must be cut at precise angles. Although the specific angle is not critical (it can be plus-or-minus several degrees), it is imperative that the rotor and housing cones are the same angles. If the angles are off by even a fraction of a degree, the valve will leak. Ordinarily, one might consider using an O-ring or a thick lubricant to minimize the tolerance required—however, because of the temperature constraints, both solutions are impractical. Another potential solution might be to place the rotor in the housing with an abrasive between the two surfaces and then rotate the rotor until the two parts are matching each other (i.e.—lapping). However, such a process is less-than-ideal because while the angles may match each other, the surface finish will be far from smooth; on the contrary, the surface finishes will have several circumferential grooves (similar to a record, only concentric grooves). Thus, to satisfy FR1.1, the surfaces must be polished, but doing so may alter the angle of the cones. Perhaps EDM or laser-cutting may be employed to satisfy both FR1.1 and FR1.2, but these processes may be quite expensive.

Second, although this coupling may be avoided in a perfect design, it is likely that thermal expansion of the parts will affect the surface finish and/or geometric alignment. While one can choose appropriate materials to manage the thermal expansion rates of the parts, it is extremely difficult to manage the temperature gradient within the components. As such, it is quite difficult for FR1.1 and FR1.2 to remain with their design range. Overall, the system can be described as being very ‘stiff’.

***FR1.1.1: Manufacture smooth surface finish***

***DPI.1.1: Manufacturing processes***

***FR1.1.2: Maintain smooth surface finish***

***DPI.1.2: Surface material properties***

$$\begin{vmatrix} X & 0 \\ 0 & X \end{vmatrix}$$

Although some of these FRs are coupled with other FRs in the design, FR1.1.1 and FR1.1.2 can be satisfied independently. Under some extreme cases, it may be difficult to polish certain materials, but a process can be developed—and most likely has already been used somewhere.

***FR1.1.1.1: Provide smooth surface finish on port surface***

***DPI.1.1.1: Port surface grinding operation***

***FR1.1.1.2: Provide smooth surface finish on rotor surface***

***DPI.1.1.2: Rotor surface grinding operation***

$$\begin{vmatrix} X & 0 \\ 0 & X \end{vmatrix}$$

As noted above, one can create smooth surface finishes via a number of processes. One of the most practical may be to grind the surfaces, although one could potentially use a laser or some other manufacturing technique.

***FR1.1.2.1: Maintain smooth surface finish on port surface***

***DPI.1.2.1: Port surface hardness (or coating)***

***FR1.1.2.2: Maintain smooth surface finish on rotor surface***

***DPI.1.2.2: Rotor surface hardness (or coating)***

$$\begin{vmatrix} X & 0 \\ 0 & X \end{vmatrix}$$

To maintain the smooth surface finish, the surfaces have to be quite hard and resistant to wear and corrosion. A number of processes can be used to ensure a hard surface—such as Nitriding or a Titanium coating (many other options are available, including other hardening processes and coatings). As noted above, however, DPI.1.2.1 and DPI.1.2.2 will have an affect on the friction of the valve.

---

**FR1.2.1: Matching port/rotor geometries**

**DP1.2.1: Turning operation**

**FR1.2.2: Maintain matching port/rotor geometries**

**DP1.2.2: Deformation management system**

**FR1.2.3: Maintain vertical alignment**

**DP1.2.3: Floating port (i.e.—floating valve seat)**

**FR1.2.4: Provide/maintain concentricity**

**DP1.2.4: Precision aligned bearings**

$$\begin{vmatrix} X & 0 & 0 & 0 \\ 0 & X & X & 0 \\ 0 & 0 & X & 0 \\ 0 & X & X & X \end{vmatrix}$$

A number of devices may be employed to achieve the required geometric alignment between the rotor and housing. Under ideal conditions, they can be part of an uncoupled system, although it is possible (and relatively easy) for the above matrix to become coupled if any detail is overlooked. Perhaps the most innovative device in this branch is the ‘floating valve seat’ used to satisfy FR1.2.3.

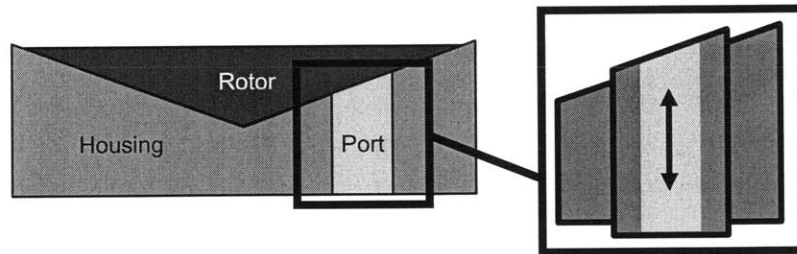

*(Figure 3.3: floating valve seat sketch)*

As shown in the figure above, DP1.2.3 provides vertical compliance between the rotor and housing. In doing so, one can reap a number of benefits. First, one need not worry about designing a complex system to provide vertical alignment between the rotor and housing. Instead, the valve seat can accommodate for slight imperfections in design. Second, DP1.2.3 can adapt to changes in vertical position due to thermal expansion. This is especially critical in a conical system, which accommodates for radial expansion by moving axially (i.e.—vertically). Third, the floating valve seat can dramatically reduce the system friction. It is almost impossible to design and maintain a negligible gap between the rotor and housing in a very stiff system. As the gap between the two parts increases, the sealing dramatically reduces. A number of other methods can be used to reduce this gap. One option is to shift the orientation of the valve so that the high pressure would push the rotor into the housing. Such a self-help system is very similar to DP1.2.3 only it requires the rotor to be placed inside the engine cylinder—this may be impractical, but is still a reasonable option. Another option is to keep the rotor outside the cylinder, but to have it be made from a very stiff spring. The spring would have to be stiff enough to resist the maximum pressure reached in the engine (300 psi) and would thus provide a high contact force between the rotor and housing—and thus high friction. However, the floating valve seat only provides the required contact force

to seal the valve. In other words, the contact force between the rotor and housing is proportional to the pressure in the cylinder, and thus the overall friction would be much lower than in the previous design.

Nonetheless, the DPs are still quite difficult to design. For instance, the bearings used to satisfy FR1.2.4 must be low-friction and work in a large temperature range. They should also be able to withstand high off-axis loads and last for several years under continued use. Similarly, the deformation system is difficult to manage and critical to the success of the valve.

***FR1.2.2.1: Manage thermal deformation***

***DP1.2.2.1: Matching thermal expansion rates/temperature gradients***

***FR1.2.2.2: Min. pressure-induced material deformation***

***DP1.2.2.2: Rotor stiffness***

$$\begin{array}{|c|c|} \hline X & X \\ \hline 0 & X \\ \hline \end{array}$$

DP1.2.2.2 is relatively self-explanatory: the rotor must be stiff enough to resist the high forces applied. The DP can be further decomposed into both geometric and material design elements to achieve the required stiffness. However, both the materials and geometry will affect the thermal expansion of the rotor and thus must be designed carefully. To manage thermal deformation, the most common technique used is studying and then managing the material properties of the components. This is a very difficult process and results in a ‘stiff’ design. Not only is it difficult to understand how the valve geometry changes as it is heated (or cooled), but it is impossible to predict or control the precise temperature gradient in the valve. After all, even the ‘steady-state condition’ of the engine changes over time. It is impressive that rotary valves are still able to work so well with such a stiff design.

***FR3.1: Control frequency***

***DP3.1: Actuation speed***

***FR3.2: Control % time open***

***DP3.2: Port size (circumferential arc length)***

$$\begin{array}{|c|c|} \hline X & 0 \\ \hline 0 & X \\ \hline \end{array}$$

Similar to a poppet valve, the valve frequency can be adjusted relatively easy by controlling the actuation speed of the valve. The actuation can be synchronized with the drive-shaft (just like a standard camshaft) or it can be controlled independently with a motor.

FR3.2 is affected by both DP3.2 and DP2. In fact, the duration of the opening is the sum of DP3.2 and DP2 (the sum of the angular opening of each). As shown below, the maximum flow condition is when DP3.2 and DP2 are equal.

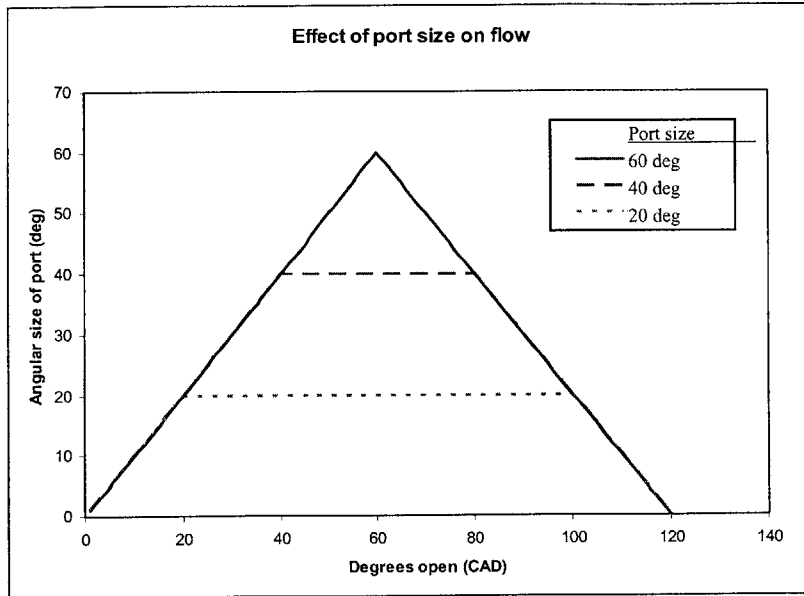

(Figure 3.4: effect of port size on flow)

**FR4.1: Minimize port/rotor coefficient of friction**

**DP4.1: Port/rotor surface properties**

**FR4.2: Minimize port/rotor contact force**

**DP4.2: Raised valve seat/port contact area**

$$\begin{vmatrix} X & 0 \\ 0 & X \end{vmatrix}$$

A number of factors affect FR4.1. As noted above, the ideal conditions cannot be met without compromising the sealing of the valve. Nonetheless, some factors can still be adjusted to create a relatively low-friction system. For instance, using different materials can still provide good sealing and low friction (although the friction might not be as low as it could have been).

One way of minimizing the rotor/housing contact force is to raise the port so as to minimize the contact area between the rotor and housing. The most significant difficulty with such a system is manufacturing the raised port (keeping in mind FR1.1).





are a number of reasons that rotary valves have not become successful in engines (including marketing, etc.), one of the main drawbacks has been the design problems listed above. An engine presents a very difficult environment and magnifies any slight flaw in a design. While the rotary valve seems like a promising candidate for an engine valve, the designs studied are still too 'stiff' to be successful.

## ***3.2. ROTARY VALVE REVOLUTION***

The patent-pending designs shown below were developed over the course of a little over a year. The first demonstration models for the invention were built on 03/17/04—however, these were only for visualization purposes. The concept was not patented until later to allow for further development of the valve. The concepts presented here are covered in the patent.

I will initially discuss the improvements, and then discuss how they—in conjunction with previous design elements—may be applied to create valves that can exceed current limitations. The concepts presented can be employed in a number of embodiments—I have tried to include a thorough sampling of the different variations to provide a deeper understanding, the varied applications and to show how they can be readily molded into a number of other forms—many of which have not yet been designed.

The main invention, hereafter called the WaveFlex system, decouples the friction from the sealing of the valve, meaning that the valve can provide high sealing and low friction in a simple and low-cost system. This idea is repeated in all forms of the invention and might be described as the heart of this valve system. As such, it will be described in depth first; while other innovative concepts have been developed, they do not pertain to all forms, so they will be discussed when illustrating specific valve geometries.

As so many different forms have been designed, they have not all been thoroughly tested. Instead, critical concepts which are common and standard for all designs—such as wear of the flexible member—have been researched, while a less-extensive study has been performed for the individual forms.

### ***3.2.1. THE MAIN IDEA***

The WaveFlex is an offspring of both rotary valve and harmonic drive technologies. It provides the same functionality of a rotary valve (that is, to control flow through a port), but does so in a manner that appears similar to harmonic drive. Thus, to gain a better understanding of the valve, a brief introduction into harmonic drive is provided:

In harmonic drive, a thin flexible member (called a flexspline) is placed between a slightly larger tube (circular spline) and an oval-shaped wave generator. The wave generator ensures that the flexspline contacts the circular spline in just two points, and, as the wave generator rotates within the flexspline, the flexspline rolls within the circular spline. The key point to note is that as the flexspline rolls on the circular spline, it rotates very slowly as well. In doing so, harmonic drive gearing units can efficiently achieve very large gear ratios in a very small volume.

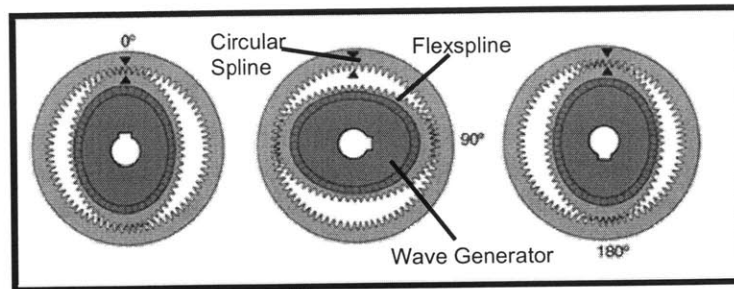

(Figure 3.5<sup>20</sup>: harmonic drive)

The WaveFlex system is very similar to harmonic drive—only it achieves low-friction sealing as opposed to low-friction power transmission. Similar to a rotary valve, the WaveFlex has an outer housing with a port leading into the engine cylinder, which is periodically covered by a rotor. However, similar to a harmonic drive system, the WaveFlex uses a flexspline and uses a low-friction surface between the rotor (i.e.—wave generator) and flexspline.

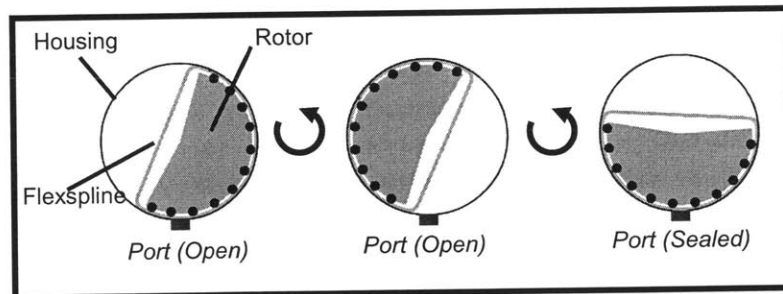

(Figure 3.6: WaveFlex system sketch)

The flexspline serves to decouple the friction from the sealing in the rotary valve. When in contact, the flexspline-port interface has very high friction and also provides very good sealing—however, because the flexspline rolls on the housing, the friction is negligible. The rotor-flexspline interface has very low friction, but provides absolutely no sealing—instead, it provides a force to rotate the buckle and to ensure that the flexspline is in contact with the housing. Thus, the rotor can be made from low-friction materials, use low-friction geometries (such as an undulated surface), or even use lubricants (depending on the temperature constraints). In other words, unlike existing rotary valves, the WaveFlex system has two interfaces: 1) a low-friction, non-sealing surface between the rotor and the flexspline; and 2) a high-friction, high-sealing surface between the flexspline and housing. Combining these two interfaces, one can achieve a very low-friction valve with high sealing characteristics. Because this division of friction and sealing allows one to design cheaper components which are better suited to each FR, the entire valve can provide surprisingly low friction with high sealing characteristics.

<sup>20</sup> from [16]

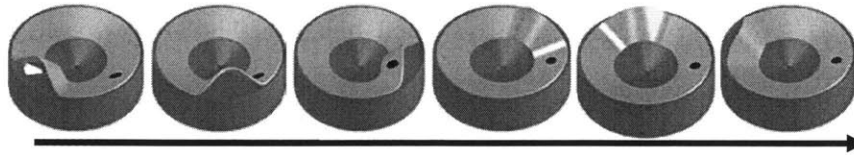

(Figure 3.7: WaveFlex actuation cycle; the dot on the flexible member is used to show how it rolls on the housing)

### 3.2.2. SOME VARIABLES

Although the WaveFlex system can be a very effective sealing system, it is a simple enough design that it can be uncoupled or decoupled from many other parts of the rotary valve design. In other words, the WaveFlex system can be relatively easily applied in a number of forms, including: different geometries, different orientation, different materials and different actuation systems (to name a few variables).

For instance, the WaveFlex system can be used in a cylindrical geometry similar to a harmonic drive system. In this case, the port(s) would be placed circumferentially on the housing. However, the rotating cam could be placed inside or outside the housing to accommodate for geometric or pressure-related concerns. Similarly, one would need to decide which side the high-pressure should be on—should the pressure be on the side of the housing with the flexible member (best for low-friction and high-sealing) or on the opposite side (possibly less interference). In addition, one should decide how to actuate the flexible member. Thus far, only a mechanical actuation system has been described, although—depending on some of the other parameters and constraints—one could also use a magnetic system, a pneumatic system, or other actuators.

Following is a more detailed description of some of the variables applicable to a WaveFlex system:

#### 3.2.2.1. GEOMETRY

- Cylindrical: In a cylindrical system, one uses a tubular housing (with circumferential ports) and flexible member. Depending on the design, the flexible member may be placed within the housing (similar to a harmonic drive system) or externally. Some advantages include being able to control a number of different ports with a single cylinder which may reduce part count and increase system robustness. However, the biggest difficulty is manufacturing a smooth, precision tubular flexible member. Fortunately, depending on the actuation system and other parameters, the tolerance of the flexible member may not need to be too high—but in other designs, the tolerances required may make the design very expensive.

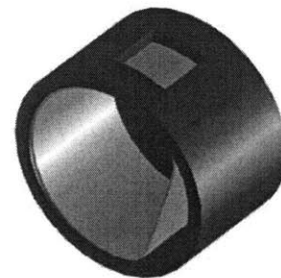

(Figure 3.8: cylindrical)

- Conical: In a conical system, an annular shaped flexible member is placed on a conically-shaped housing. The actuator ensures that a portion of the flexible member ‘buckles’, while the rest contacts the housing concentrically. Conical geometries may be advantageous because of their ability to manage thermal expansion with a slight vertical adjustment along the conical axis. In addition, the flexible member may be stamped from a flat sheet of shimstock—reducing costs while increasing precision.

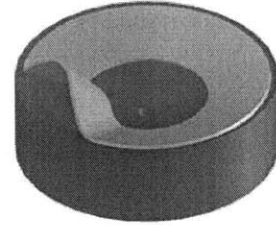

(Figure 3.9: conical)

- Disk: In a disk system, the housing is a flat disk. Ideally, the flexible member would be circumferentially stretched from an annular shape such that the ‘circle’ contains over 360 degrees and could thus not lay flat. In doing so, the system would have a buckle similar to that in the conical system. Alternatively, one may use an annular flexible member in which less than 180 degrees is in contact with the housing at any given time. To increase the percentage of sealing, two annular flexible members may be placed on the housing mirroring each other. In doing so, one could almost double the sealing time. Depending on the ultimate geometry used, a disk system may be easier and cheaper to manufacture if it uses entirely flat components. However, the disk geometry is better suited to an on-off system or a continuous system which requires a much greater percentage of opening time than sealing time.

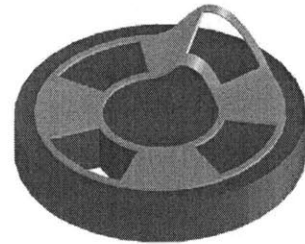

(Figure 3.10: disk)

- Other: In addition, one can employ other geometries—such as a spherical system, where the flexible member might be contoured to conform to the spherical rotor shape. The valve need not even be rotary—it could be a linear system, where the ‘rotor’ would reciprocate (as shown in figure 3.11).

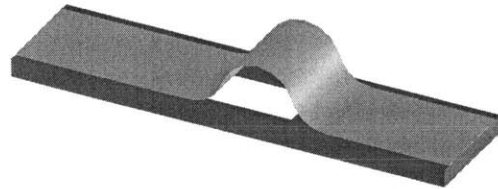

(Figure 3.11: linear)

### 3.2.2.2. ORIENTATION (GEOMETRIC / PRESSURE)

As noted earlier, each geometry can be oriented in two different manners. As an example, take the following sketch:

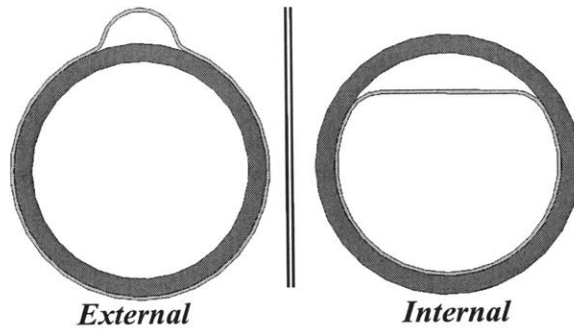

(Figure 3.12: WaveFlex cylindrical valve in external and internal modes)

While one cannot say that one orientation is better than another, there are a number of differences between the two which may be advantageous in certain situations. For instance, the maximum induced stress in the flexible member is lower in the ‘external’ mode of *figure 3.12*. One can also observe how the two orientations might interact with the environment differently—for instance, in an engine, one may find the ‘internal’ mode to offer superior combustion dynamics.

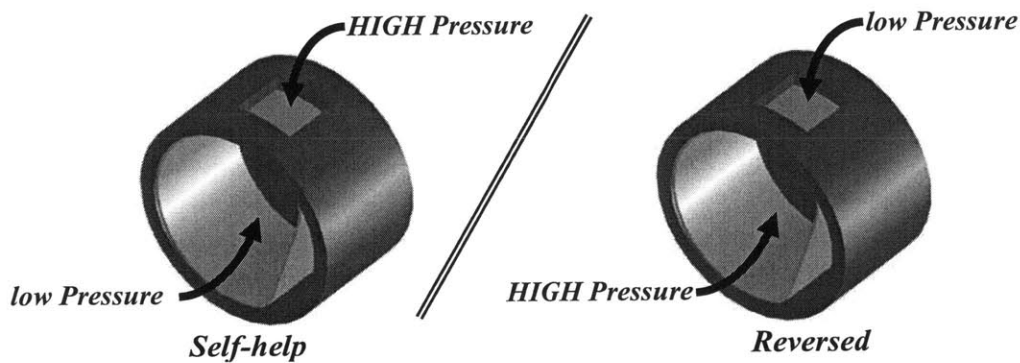

(Figure 3.13: WaveFlex cylindrical valve in self-help and reversed modes)

In addition, one can adjust the valve with respect to the pressure differential. By placing the valve outside the cylinder (in the ‘reversed’ position) we can minimize interference with current cylinder/piston designs. Although the intake manifold and cylinder head will have to be modified, identical piston/cylinder parts used in engines with poppet valves can be used in this configuration. In fact, as the valve never enters the cylinder, the piston can be designed to achieve superior engine performance than with current valve systems. In addition, one has more flexibility in the design and maintenance of the rotary valve as it is less physically constrained. However, it is more difficult to seal in this configuration because the high pressure is pushing the flexible member away from the port. While this problem can be addressed by adding elements such as floating seals, the overall cost and difficulty of manufacturing both increase.

Alternatively, one can use the valve in the ‘self-help’ orientation. In this geometry, it is much easier to achieve sealing as the high pressure actually helps to improve sealing. In addition, the friction (which is already low in either design) can be dropped significantly because the contact force between the rotor-flexible member interface is minimal. Indeed, the rotor need only rotate the buckling and does not have to help resist the high pressures in any way. Also, the rotating member within the cylinder

will provide a high-degree of swirl within the combustion chamber which may improve the combustion dynamics. Unfortunately, this design may be more difficult to design for an engine as it is more likely to interfere with the piston and the combustion process.

### 3.2.2.3. *MATERIALS*

Depending on the valve application, a number of different materials may be used in the valve. One would obviously want to maximize the sealing between the housing and flexible member, reduce the friction between the flexible member and actuation system, and provide a flexible, yet highly elastic flexible member—but even these constraints are quite loose and allow for a high degree of versatility. As will be shown later, some constraints in earlier rotary valve designs, such as thermal expansion, can now be ignored because of a more robust system design. For engines, one would most likely want to limit the material selection to metals and ceramics, although some plastic composites have been developed which can sustain the high temperatures and pressures present in engines. For instance, although the flexible member is currently made from steel, it could potentially be made from a composite material with superior material properties. For other applications, cost may be the driving factor, or perhaps maximum sealing pressure (...just to name a few). In fact, many of the components may even be injection molded, cast or stamped.

### 3.2.2.4. *ACTUATION*

The valve may be actuated a number of ways and using a number of different forces.

- **Mechanical:** Most valves are actuated mechanically. In this design, it would be very similar to a harmonic drive system. The flexible member would be placed between a housing and a rotor—and as the rotor rotates, it would control the movement of the flexible member with respect to the housing. The friction interface between the flexible member and rotor could be rubbing or rolling (as in harmonic drive).
- **Pneumatic:** In this system, the pneumatic system could be placed within the housing—and periodically ‘suck’ the flexible member into the housing—or on the other side of the flexible member—and ‘push’ the flexible member into the housing, similar to an air-bearing. In both cases, the friction interface would almost be negligible.
- **Magnetic:** Similar to a pneumatic system, the magnets may be placed within the housing. If electro-magnets were placed within the housing (and periodically turned off and on) the magnetic flexible member could be controlled precisely and with very little energy loss. In addition, magnets could be used to remotely control the position of a mechanical rotor.
- **Piezo-electric:** In this system, the flexible member could self-contort itself such that it could control how the buckling would move.



### 3.2.2.5. OPENING

Although there is only one way to seal the port in the WaveFlex system, there are two ways of opening the port. To understand this, one should first study how the flexible member interacts with the housing. As the flexible member is actuated, two things happen: 1) the buckle rotates with respect to the housing; and 2) the flexible member itself translates a small fraction every time the buckle completes a revolution (the precise degree of shift depends on the size of the buckling). One may use either of the two transformations to open the port.

First, one may use only the buckling to open the port. Considering a cylindrical geometry, the flexible member is a thin-walled tube. When the buckled portion is over the port, the port is open; when the buckled portion is not over the port, the port is sealed. Second, one may use the flexible member shifting to control the flow through the port. Here, the flexible member would have circumferentially cut holes in the tube. As the flexible member shifts (due to the buckling), the holes would periodically line up with the port. Although this design offers higher volumetric efficiency, it is better suited as an on-off valve and may not be as ideal in an engine application. The main disadvantage of such a system is that two factors control the opening of the port (the buckling and the holes)—so, while the valve can remain open for a long time, it can only remain sealed for one revolution (before the buckle passes over the port again).

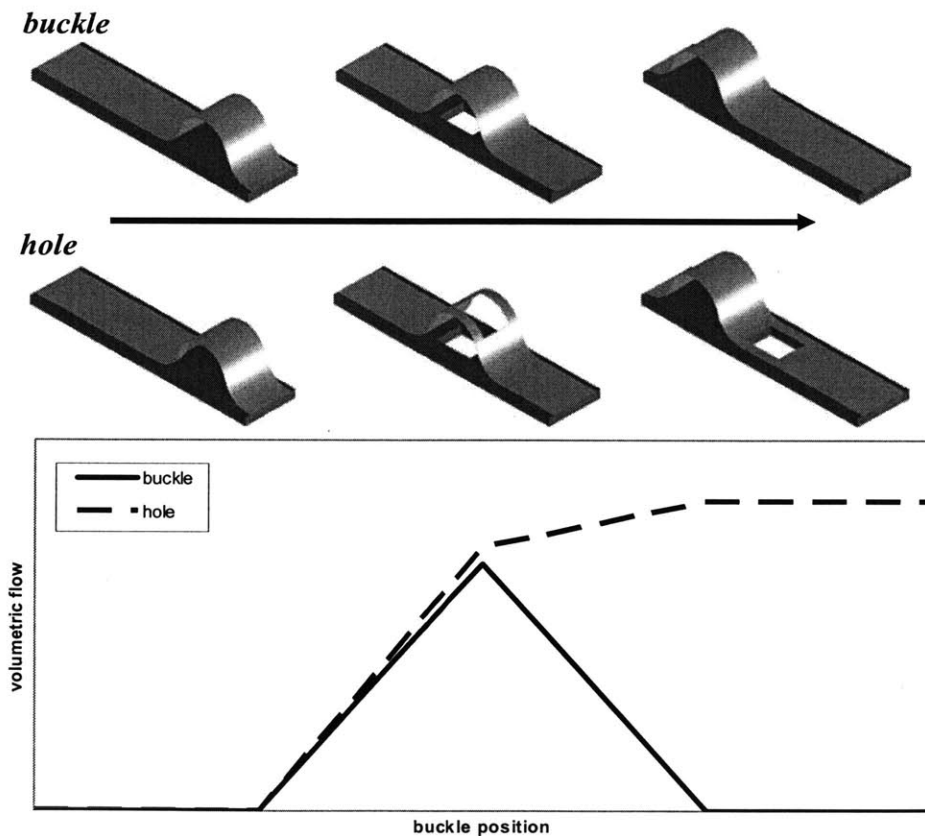

(Figure 3.14: WaveFlex opening modes & effect on flow)

### 3.2.3. THE SAMPLES

To better understand how the WaveFlex system can be applied to a valve—and to understand some other innovations developed in the course of my research—following are a series of potential valve designs. They do not represent a full-spectrum of WaveFlex designs, but provide a broad enough sampling to demonstrate the potential of the system.

#### 3.2.3.1. D01A

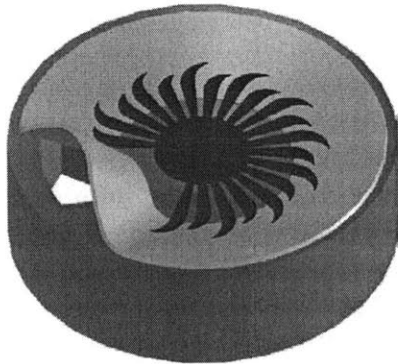

GEOMETRY:	<i>Cone</i>
ACTUATION:	<i>Mechanical</i>
PRESSURE:	<i>Self-help</i>
OPENING:	<i>Buckle</i>

*Figure 3.15*

Above is one design using the WaveFlex technology. Although this specific valve is still in its trial stages, of all the valves designed, this form seems to have much promise. The friction is surprisingly low, the design is robust and it can seal the high pressures required. Another significant benefit is the low manufacturing cost of this system. The valve uses relatively inexpensive materials and uses low-cost manufacturing processes, such as die-casting and stamping, which are well-suited to mass-production. One of the most significant hurdles in this design being used in an engine is a potential for interference with the piston.

It is a metal conical valve and uses a solid flexible member. The actuation system presented is mechanical, with the rotor rubbing on the surface of the flexible member. In this design, the rotor is a compliant flexure which pushes gently on the flexible member and can account for geometric deformations due to manufacturing errors or thermal expansion. The valve is oriented such that the pressure differential is used to help seal the system.

As will be demonstrated below, most couplings have been eliminated and the design is much more 'compliant'. Even the couplings that exist are in the design stage, and will not affect the functionality of the valve when it is in use. Feasible solutions can be found (after some iteration) and once they have been found, they need not be adjusted while the valve is running. The design allows for a much more robust and 'easy-to-control' low-friction/high-sealing valve. Although friction is not entirely eliminated here, the friction interface is entirely separated from the sealing interface, meaning that

materials with lower coefficients of friction can be used without considering their sealing properties (and vice-versa).

**FR0: Control flow of high pressure gas through port**

**DP0: Conical rotary valve system**

**C1: Function between 0° C and 400° C**

**C2: Be non-reactive to air/fuel**

**C3: Function for 10<sup>8</sup> cycles**

**C4: Low-cost**

**C5: Low-energy loss**

Note that FR/DP0 for this design are the same as in the prior-art decomposition. Indeed, this valve does have many similarities to the previous valve, but adds some interesting design features which improve the valve performance.

**FR1: Seal port**

**DP1: Sealing system**

**FR2: Open port**

**DP2: Open-flow system**

**FR3: Control timing**

**DP3: Actuation system**

**FR4: Minimize friction**

**DP4: Friction reduction system**

<i>X</i>	<i>X</i>	0	0
<i>x</i>	<i>X</i>	0	0
<i>x</i>	<i>X</i>	<i>X</i>	0
<i>X</i>	<i>X</i>	0	<i>X</i>

Perhaps the first observation the reader will make is that this design appears to be coupled. Indeed, it is—but very slightly (as shown by the lower-case ‘x’). As will become clearer in further decompositions, the flexible member must be stiff enough to seal the port without deforming, but must also be compliant enough to allow a buckling to form so that the port can be opened. Thus, some iteration between the material properties and geometry of the flexible member may be required. However, the design ranges overlap enough such that both FR1 and FR2 can be satisfied under most conditions.

It is important to stress that this coupling is different from most of those in the prior-art case in that a solution can be developed where both FR1 and FR2 are satisfied without compromising the performance of the valve. Moreover, unlike some other couplings, this one can be very well modeled and understood. Thus, a design can be developed which has a large enough design range.

The second observation may be that the friction and sealing are now decoupled, rather than coupled. In fact, the friction is not coupled with any other functional requirements and can thus be optimized relatively independently of other parameters. This can be easily seen when looking at the rotor in *figure 3.15*. The only sliding occurs at the interface

between the rotor and the flexible member, and, as will be shown in further decompositions, that interface can be readily modified to minimize friction.

**FR1.1: Provide/maintain micro-level sealing around port**

**DPI.1: Surface finish**

**FR1.2: Provide/maintain macro-level sealing around port**

**DPI.2: Geometric alignment**

$$\begin{vmatrix} X & 0 \\ X & X \end{vmatrix}$$

By using the WaveFlex system, we are also able to decouple the micro-level sealing from the macro-level sealing. In other words, one can easily provide both a smooth surface finish and a matching rotor/housing interface.

To better understand this, let us first consider the manufacturing processes required. As the reader may recall from the prior-art decomposition, we are required to manufacture two matching cones with smooth surface finishes. In this design, however, we add some compliance which allows the rotor to easily conform to the geometry of the housing. Thus, the angle of the housing need not be precise. In fact, it may be possible for the housing to even be die-cast. Once the rough cone angle is made, it can be polished with a grinding operation—or depending on the casting process, further grinding may not be necessary. The other matching interface, the flexible member, is rolled and then stamped out in an annular shape; and because it is cold-rolled, it can be made very smooth. The flexible member is then pressed into the housing and conforms perfectly to the conical shape. As will be shown in other designs, there are a number of techniques which are used to ensure that the flexible member is ‘pressed’ into the housing and can adapt to the appropriate geometry.

The second issue presented in the prior-art case was the difficulty in managing the thermal expansion of the rotor and housing. However, by allowing the flexible member to adapt its shape while the valve is running, the thermal expansion of this system can be almost negated. Essentially, the WaveFlex system is allowing us to exchange a very stiff system for a compliant one with a large design range.

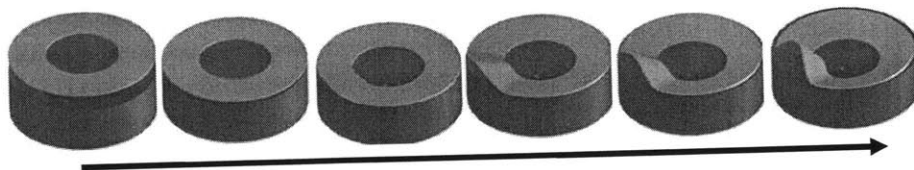

(Figure 3.16: flexible member conforming to conical housing)

---

**FR1.1.1: Manufacture smooth surface finish**

**DP1.1.1: Manufacturing processes**

**FR1.1.2: Maintain smooth surface finish**

**DP1.1.2: Surface material properties**

$$\begin{array}{|c|c|} \hline X & 0 \\ \hline x & X \\ \hline \end{array}$$

The techniques used to manufacture and maintain a smooth surface finish are mostly uncoupled, although some decoupling may occur. For instance, considering the flexible member, a rolling operation provides a smooth surface on the shim stock. However, the rolling operation also affects the grain structure of the material (if it is metallic) and thus affects the surface properties. As such, one should consider both FR1.1.1 and FR1.1.2 when specifying DP1.1.1.

---

**FR1.1.1.1: Provide smooth surface finish on port surface**

**DP1.1.1.1: Die-cast operation (optional port surface grinding operation)**

**FR1.1.1.2: Provide smooth surface finish on flexible member**

**DP1.1.1.2: Rolling operation**

$$\begin{array}{|c|c|} \hline X & 0 \\ \hline 0 & X \\ \hline \end{array}$$

FR1.1.1.1 and FR1.1.1.2 affect two different parts, and as such are uncoupled. It is interesting to note how DP1.1.1.1 and DP1.1.1.2 differ between this design and the prior-art rotary valve, while the FRs remain constant. The operations specified in this design are more efficient—in that they are cheaper and faster (Note: It may be that DP1.1.1.1 would require an additional grinding operation, in which case it would be identical to the previous design)

---

**FR1.1.2.1: Maintain smooth surface finish on port surface**

**DP1.1.2.1: Port surface hardness (or coating)**

**FR1.1.2.2: Maintain smooth surface finish on flexible member**

**DP1.1.2.2: Flexible member surface hardness (or coating)**

$$\begin{array}{|c|c|} \hline X & 0 \\ \hline 0 & X \\ \hline \end{array}$$

Again, FR1.1.2.1 and FR1.1.2.2 affect two separate parts and have similar solutions to the prior-art rotary valve design. DP1.1.2.2 would most likely require a different treatment as it has to satisfy different requirements—more specifically, the affected part is much thinner and must bend. The thinness of the material allows for some different techniques from the previous design (such as rolling, as mentioned above), while the need to flex adds some limitations to the design.

One of the significant difficulties with the WaveFlex system is preventing wear of the flexible member. Although wear and friction are greatly reduced in the valve, because of the thinness of the flexible member, the impact of the wear is much more significant. Thus, DP1.1.2.2 is a critical design element for the success of the valve.

---

**FR1.2.1: Maintain flexible member ‘flatness’**

**DP1.2.1: Flexible member thickness**

**FR1.2.2: Prevent crack formation in flexible member**

**DP1.2.2: Crack prevention mechanism**

**FR1.2.3: Provide port/flexible member contact**

**DP1.2.3: Rotor**

**FR1.2.4: Maintain port/flexible member vertical contact**

**DP1.2.4: Pressure differential (self-help)**

**FR1.2.5: Provide/maintain concentricity of flexible member**

**DP1.2.5: Circumferential magnets or friction or etc.**

---

X	0	X	x	0
X	X	0	0	0
x	0	X	0	0
0	0	0	X	0
0	0	0	0	X

One of the potential difficulties with the WaveFlex system is ensuring that the flexible member remains flush with the housing. To control the deformation of the flexible member, it must be above a minimum thickness. This thickness depends on a number of other factors, including the material properties of the flexible member, the pressure differential, and the size of the port. For instance, in a larger port, the flexible member will more likely be ‘sucked’ into the port, and thus create some small wrinkles near the port edge—which could affect the sealing. If the current solution cannot satisfy FR1.2.1, then another potential DP would be a mesh structure over the port (but flush with the housing) to minimize the effective port size.

As noted above, the flexible member is potentially the weakest (and most important) element in the design. If the flexible member wears significantly (as noted in FR1.1.2.2) or develops cracks (FR1.2.2), then the valve will cease to function. A number of parameters affect FR1.2.2, so it is decomposed further.

Two FRs are used to ensure that the flexible member contacts the port. DP1.2.3 presses the flexible member into the housing, but only loosely. However, the rotor creates a small enough gap so that a pressure differential is formed on either side of the flexible member and can create a tight seal between the flexible member and port. Indeed, it is DP1.2.4 which creates the tight seal whereby the valve can seal large pressures; however, without the rotor, the pressure differential would not exist. In addition, the rotor is responsible for the actuation of the system.

Another difficulty with the flexible member is ensuring that it remains nearly concentric with the housing. If the flexible member wobbles too much, then a number of potential problems can ensue. First, to seal, it is necessary that the flexible member cover the port—if the flexible member slides off course, however, then it may not cover the port entirely and thus sacrifice the sealing of the valve. Second, if the flexible member is outside a prescribed range, then it may contact other objects—such as the rotor—and such interferences would inevitably lead to the flexible member tearing. To ensure the concentricity, a number of DPs can be employed. If the flexible member is made of a magnetic material, then magnets may be placed circumferentially within the housing, and provide an equalizing force. This solution works very well, but may not be applicable in all

situations (due to costs or temperature constraints, for instance). Other solutions include increasing the friction between the flexible member and housing or providing some sort of lip/track for the flexible member to roll in.

***FR1.2.2.1: Avoid interference***

***DPI.2.2.1: Flexible member diameter***

***FR1.2.2.2: Avoid cyclic fatigue***

***DPI.2.2.2: Flexible member guide (i.e.—fillets on rotor)***

$$\begin{vmatrix} X & x \\ 0 & X \end{vmatrix}$$

To prevent failure of the flexible member, one must consider a number of design elements. Although two significant ones are listed above, other elements may be added to improve the design. FR1.2.2.1 is similar to FR1.2.5, but deals with another mode of interference. The diameters of the annular-shaped flexible member will affect how the valve interferes with other components. For instance, if this specific valve design was employed in an engine, it would have to be placed upside-down in the cylinder. Thus, the flexible member would have to be sized appropriately such that it would not contact the piston.

However, one of the more significant modes of failure of the flexible member is cyclic fatigue. To prevent cyclic fatigue for the specified lifetime, the stresses in the flexible member must be below the fatigue limit. A number of DPs affect FR1.2.2.2, including the shim stock thickness and Young’s modulus of elasticity—however, one of the more significant design constraints is the minimum radius of curvature of the flexible member. As one familiar with the valve will realize, the sharpest curve is at the base of the rotor—so a fillet or guide can be added to control the curvature. Similar analysis is performed in harmonic drive gearing systems.

***FR1.2.3.1: Provide sufficient force***

***DPI.2.3.1: Rotor flexure stiffness***

***FR1.2.3.2: Provide sufficient force distribution***

***DPI.2.3.2: Rotor flexure radial/circumferential distribution***

***FR1.2.3.3: Allow for angular variation of cone***

***DPI.2.3.3: Travel of rotor flexure***

$$\begin{vmatrix} X & 0 & 0 \\ 0 & X & 0 \\ 0 & 0 & X \end{vmatrix}$$

The rotor has to gently press the flexible member against the housing—except where the buckle occurs (optionally, at the buckle, the rotor may press the flexible member away from the housing). While a stiff rotor would work under some conditions, it would not provide the compliance required for such a system. As mentioned previously, it is likely that the shape of the housing may not be manufactured perfectly and will most likely change over time (due to thermal expansion). To provide these extra degrees of freedom, a flexure is used as the rotor. In doing so, one can ensure that a near-constant load is applied to the flexible member under all conditions.

In one embodiment, the flexure has a number of ‘fingers’ radiating from the central



hub (which is attached to a shaft). The cantilevered beams then apply a force to the flexible member. The force applied is affected by the stiffness of the flexure (which is in turn controlled by the beam material and geometry). As mentioned above, the force required is affected by a number of parameters, including the cone angle and flexible member properties. In addition, the rotor flexure requires a minimum travel (in the elastic regime), so that the rotor can still ‘contact’ the housing, even if the housing geometry changes (due to thermal expansion). The required travel is quite small, but depends on the valve form and environment.

Finally, the flexure must distribute the force evenly over the flexible member. As a further decomposition would reveal, that requires distributing the load both circumferentially and radially—meaning that the flexure fingers must be relatively small and well-distributed. If the force is not distributed evenly circumferentially, then it is possible that the flexible member would buckle in areas where it was not intended to. If the force were not distributed well radially, then the flexible member might not cover the port well enough to create a sufficient pressure differential; in addition, by distributing the load radially, the wear on the flexible member can be reduced/spread more evenly.

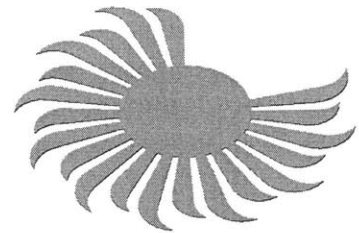

Figure 3.17

**FR2.1: Provide buckling**

**DP2.1: Cone angle**

**FR2.2: Manage size of buckled portion**

**DP2.2: Cut in rotor**

**FR2.3: Manage height of buckled portion**

**DP2.3: Flexible member Young’s modulus of elasticity**

$$\begin{vmatrix} X & 0 & 0 \\ X & X & 0 \\ X & X & X \end{vmatrix}$$

To permit flow through the port, a controlled buckle in the flexible member must be formed. In a conical system, a buckle is created when an annular shaped piece of shim stock is pressed into the housing. To calculate the degree of buckling, two equations can be used:

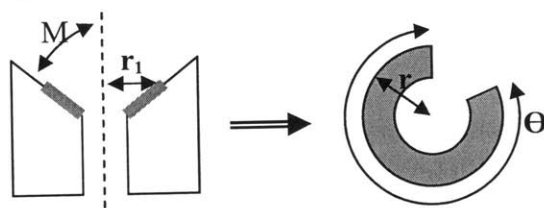

Figure 3.18

Imagine that there is a cone with a hole bored through the center of it (figure 3.18). Now, imagine that a thin slice on the surface of the cone (marked in gray) is removed from the housing. When that thin layer is flattened down, it will look like the image on the right in figure 3.18.

The equations to the right describe how the two diagrams relate to each other. For instance, if we want the flexible member to extend to radius  $r_1$  on the cone, the radius of the ring should be  $r_1/\sin \phi$ . We can then determine how much material will be in the buckle by comparing the total angle of the ring (2B) with the transformed angle of the cone

$$\begin{aligned} \bullet r &= \frac{r_1}{\sin \phi} \\ \bullet \theta &= 2\pi * \sin \phi \end{aligned}$$



$(2\pi * \sin \phi)$ .

In addition, we can control the size of the buckled portion by varying the size of the cut in the rotor. A larger cut will result in a wider/shallower buckle. One can also control the height of the buckled portion by adjusting the Young's modulus of elasticity of the flexible member. The height and stiffness of the flexible member is especially important in this design, as the buckle will affect the volumetric efficiency of the engine. Finally, a minimum stiffness is required so that sufficient force can be generated to lift the flexible member from the port (the force from the pressure differential resists the 'valve lift').

---

**FR3.1: Control frequency**

**DP3.1: Actuation speed**

**FR3.2: Control % time open**

**DP3.2: Port size (circumferential arc length)**

X	0
0	X

This branch is almost identical to that from the prior-art rotary valve design. The only potential difference, however, is that at certain speeds, the flexible member may resonate and thus affect the valve opening. It is not shown here, however, because the stiffness of the flexible member has been sufficiently high in previously run experiments that no significant waves have been formed. If they did develop, however, a simple guide system could be added to constrain the profile of the buckled portion (and thus dramatically increase the stiffness of the system).

In addition, as explained earlier, FR3.2 is the sum of DP2.2 and DP3.2. The maximum flow occurs when the two DPs are equal *figure 3.1.4*.

---

**FR4.1: Minimize flexible member/rotor coefficient of friction**

**DP4.1: Flexible member/rotor surface properties**

**FR4.2: Minimize flexible member/rotor contact force**

**DP4.2: Raised valve seat/port contact area**

X	0
0	X

By definition, friction is a function of the surface properties and the normal force. While DP4.2 is similar to that from the previous design, here, one can use much better solutions for DP4.1 because the friction interface is isolated from the sealing interface. Thus, one can apply a low-friction coating (which has poor sealing characteristics) or even an undulated surface (which is inherent in the rotor design used, but can be modified easily by adding a compliant interface between the rotor and flexible member). In addition, because self-help is used in this design, the rotor only needs to apply a very light load to the flexible member to press it into the housing and to control the position of the buckle.



### 3.2.3.2. D01B

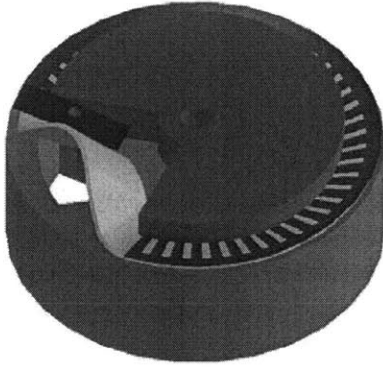

Figure 3.19

GEOMETRY:	<i>Cone</i>
ACTUATION:	<i>Mechanical</i>
PRESSURE:	<i>Reverse</i>
OPENING:	<i>Buckle</i>

This design is very similar to D01A, except that it has been oriented with the low pressure on the same side as the flexible member. To accommodate for this change, the rotor design is dramatically changed. Although this new system may still have very low friction, the friction may be several times higher than the previous design. As with the earlier system, a number of designs may be employed.

To reap the benefits of the pressure differential, a floating valve seat can be used. This provides two significant benefits: (1) it ensures that the flexible member will be in contact with the port; and (2) the overall system friction can be reduced by minimizing the normal force between the flexible member and port (at high pressures it will provide the high sealing force, at low pressures, it will press with less force).

However, the significant problem in this design is manufacturing and maintaining matching rotor and port geometries. As described in the prior-art design, it is very difficult to manufacture/maintain two complementary conical surfaces. There are a number of potential solutions, such as the patent-pending pressure plate, which are discussed in the decomposition.

---

**FR0: Control flow of high pressure gas through port**  
**DP0: Conical rotary valve system**

- C1: Function between 0°C and 400°C**
- C2: Be non-reactive to air/fuel**
- C3: Function for 10<sup>8</sup> cycles**
- C4: Low-cost**
- C5: Low-energy loss**
- C6: Low interference with piston**

-----  
This design is similar to D01a, with the added constraint that the valve should not

interfere with the piston. As will be revealed in the decomposition, the valve must be oriented reverse from D01a.

**FR1: Seal port**

**DP1: Sealing system**

**FR2: Open port**

**DP2: Open-flow system**

**FR3: Control timing**

**DP3: Actuation system**

**FR4: Minimize friction**

**DP4: Friction reduction system**

$$\begin{array}{|cccc|} \hline X & X & 0 & 0 \\ x & X & 0 & 0 \\ 0 & X & X & 0 \\ X & x & X & X \\ \hline \end{array}$$

As in D01a, this design is also slightly coupled, but the coupling should not have a significant impact on the performance of the valve (as described in D01a). Again, one can observe that, while a number of elements affect the friction of the valve, the friction reduction system does not affect other system functionalities.

**FR1.1: Provide/maintain micro-level sealing around port**

**DP1.1: Surface finish**

**FR1.2: Provide/maintain macro-level sealing around port**

**DP1.2: Geometric alignment**

$$\begin{array}{|cc|} \hline X & 0 \\ X & X \\ \hline \end{array}$$

(see p.32)

**FR1.1.1: Manufacture smooth surface finish**

**DP1.1.1: Manufacturing processes**

**FR1.1.2: Maintain smooth surface finish**

**DP1.1.2: Surface material properties**

$$\begin{array}{|cc|} \hline X & 0 \\ x & X \\ \hline \end{array}$$

(see p.33)

**FR1.1.1.1: Provide smooth surface finish on port surface**

**DP1.1.1.1: Die-cast operation (optional port surface grinding operation)**

**FR1.1.1.2: Provide smooth surface finish on flexible member**

**DP1.1.1.2: Rolling operation**

$$\begin{array}{|cc|} \hline X & 0 \\ 0 & X \\ \hline \end{array}$$

(see p.33)



**FR1.1.2.1: Maintain smooth surface finish on port surface**

**DP1.1.2.1: Port surface hardness (or coating)**

**FR1.1.2.2: Maintain smooth surface finish on flexible member**

**DP1.1.2.2: Flexible member surface hardness (or coating)**

X	0
0	X

(see p.33)

**FR1.2.1: Maintain flexible member ‘flatness’**

**DP1.2.1: Flexible member thickness**

**FR1.2.2: Prevent crack formation in flexible member**

**DP1.2.2: Crack prevention mechanism**

**FR1.2.3: Allow for port/flexible member contact (matching angles)**

**DP1.2.3: Pressure plate**

**FR1.2.4: Provide/maintain port/flexible member vertical contact**

**DP1.2.4: Floating valve seat**

**FR1.2.5: Provide/maintain concentricity of flexible member**

**DP1.2.5: Circumferential magnets or friction or etc.**

X	0	X	X	0
X	X	0	0	0
0	0	X	0	0
0	0	0	X	0
0	0	0	0	X

Although this design uses almost identical FRs, because of the new orientation, DP1.2.3 and DP1.2.4 must be different. Although the pressure differential can still be used to help seal the valve, another solution must be developed. The first two FRs and their respective DPs are the same as in D01a; in addition, FR/DP1.2.5 is the same. FR1.2.3 and FR1.2.4—which deal more with the specific action of sealing—require two ‘unique’ solutions, which are now described.

The discussion will begin with FR1.2.4, because it uses pre-existing technology. Some research has been done on developing floating valve seats which can provide the necessary compliance without sacrificing sealing. Most of them involve several rings—similar to piston rings—although some other variations have been developed. For the floating valve seat to work, as with the previous design, a light load must be applied so that the port and flexible member contact each other and create a pressure differential—which will then create a tight

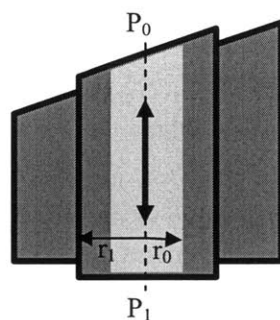

Figure 3.20

to seal:

$$F_{wall} \geq F_{hole}$$

$$(P_1 - P_0)A_{wall} \geq (P_1 - P_0)A_{hole}$$

$$A_{wall} \geq A_{hole}$$

$$\pi r_1^2 - \pi r_0^2 \geq \pi r_0^2$$

$$r_1 \geq \sqrt{2}r_0$$

seal. The light load can be created a number of ways. For instance, a small spring may be connected to the valve which pushes the valve seat toward the flexible member. Also, the port may be designed with some resistance to flow so that the flow of the fluid through the port will push the valve upwards—although this technique may reduce the volumetric efficiency of the valve. Once a pressure differential is formed, the valve seat should be pushed into the flexible member/rotor. To ensure that a sufficient force is applied, one can vary the wall thickness. A thicker wall will result in more force, as the force is a function of both pressure and contact area. Depending on the solution for FR1.2.3, the wall area should be greater than or equal to the port area.

To ensure that FR1.2.3 is satisfied under all conditions, a number of solutions can be developed. One option would be to transform the rotor into a very stiff flexure (which, unlike the above system, would contact the shimstock at all radii). The disadvantage with such a system, however, is that the system friction could be quite high (as the flexure would always need to be pushing down on the flexible member). I developed the ‘pressure plate’ as a potential solution for FR1.2.3. Unlike the stiff flexure, the pressure plate provides a resistive force, rather than applying a constant force—meaning that the overall friction is greatly reduced. The concept and design of the pressure plate are described in more detail in the decomposition.

**FR1.2.2.1: Avoid interference**

**DPI.2.2.1: Flexible member diameter**

**FR1.2.2.2: Avoid cyclic fatigue**

**DPI.2.2.2: Flexible member guide (i.e.—fillets on rotor)**

$$\begin{vmatrix} X & x \\ 0 & X \end{vmatrix}$$

(see p.35)

**FR1.2.3.1: Provide resistive force**

**DPI.2.3.1: Pressure plate thickness and material**

**FR1.2.3.2: Provide circumferential compliance**

**DPI.2.3.2: Radial cutouts**

**FR1.2.3.3: Allow for angular variation of cone**

**DPI.2.3.3: Pivot/hinge rotor/pressure plate**

$$\begin{vmatrix} X & 0 & 0 \\ X & X & 0 \\ X & X & X \end{vmatrix}$$

The purpose of the pressure plate is to provide a resistive force which will adapt to the shape of the housing (i.e.—the valve seat). More specifically, the pressure plate should provide a surface which the flexible member can rest against as the floating valve seat presses upwards with substantial force. To better understand the pressure plate, I will begin by presenting a simple linear sealing system. Imagine a flat plate with a hole in it (plate A in figure 3.21). To seal the hole, another plate (plate B) drops down and covers the port. However, if the two plates are not parallel, then the port will not seal. To solve this problem, we introduce a degree of freedom in plate B—a hinge that will allow plate B to match the angle of plate A.

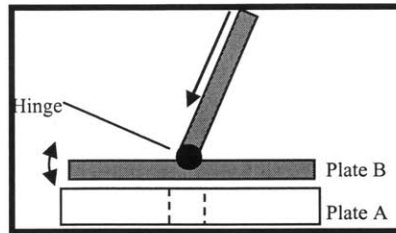

Figure 3.21

One may apply a similar concept in a rotary system. Instead of having just one plate (plate B), there will be several smaller beams hinged to a central disk:

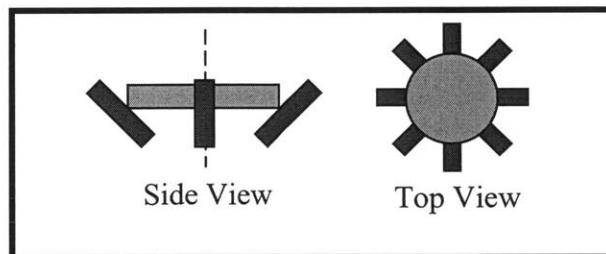

Figure 3.22

In the above geometry, the beams would rest on the flexible member described in the WaveFlex system above. Each beam would align with the angle of the housing perfectly and, assuming that the beam is thick enough such that it will not bend, can resist the high pressure applied to it. However, between the beams, the flexible member can deform. Thus, a number of beams would need to be used, and a minimum flexible member thickness used. In addition, one could use several layers so as to increase the beam resolution. A potential one-layered system might look as follows:

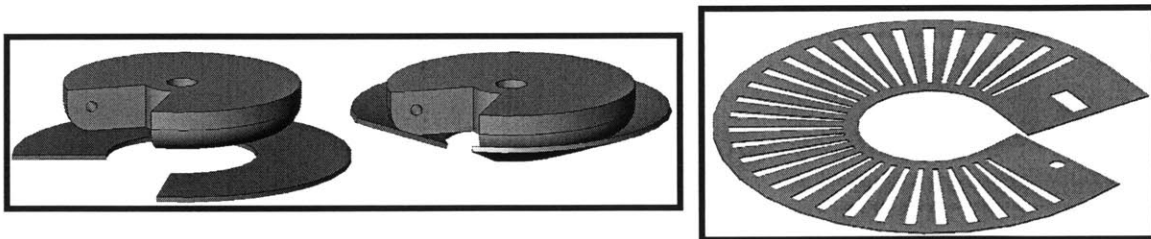

Figure 3.23

However, the system illustrated above does not function well. This is because if the beams are not perfectly radial, then rather than getting line contact, each beam will only

provide point contacts at the beam ends. Thus, although the pressure plate is required to provide uniform resistive force at all points, it is only providing resistance along two circles. Accounting for this, the following system better distributes the point contact by distributing the beams:

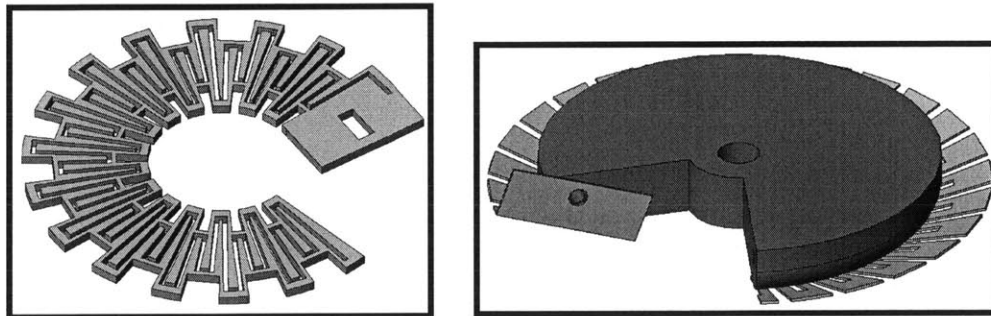

Figure 3.24

The critical parameters in the pressure plate design are noted in FR1.2.3.1 through FR1.2.3.3. The above design was prototyped using a waterjet cutting machine, although a stamping or laser cutting operation might be better suited to the design. This flat part is then hinged to a disk—which must be very hard (to prevent deformation) and should be formed within specific tolerances. Although the surface finish of the disk is not a critical parameter—the ‘macro-scale’ tolerance is critical to the success of the pressure plate.

**FR2.1: Provide buckling**

**DP2.1: Cone angle**

**FR2.2: Manage size of buckled portion**

**DP2.2: Cut in rotor**

**FR2.3: Manage height of buckled portion**

**DP2.3: Flexible member Young’s modulus of elasticity**

X	0	0
X	X	0
X	X	X

(see p.36)

**FR3.1: Control frequency**

**DP3.1: Actuation speed**

**FR3.2: Control % time open**

**DP3.2: Port size (circumferential arc length)**

X	0
0	X

(see p.37)





### 3.2.3.3. D02A



Figure 3.25

GEOMETRY:	<i>Cylinder</i>
ACTUATION:	<i>Magnetic</i>
PRESSURE:	<i>Self-help</i>
OPENING:	<i>Holes</i>

The above design introduces a new geometry, actuator and WaveFlex system. Here, the outer housing is filled with electro-magnets which control the position (and motion) of the flexible member placed concentrically inside. As the flexible member rolls in the housing, it translates a controlled amount, and can thus periodically cover/open the port. As this device uses self-help to aid in sealing, the magnets only need to provide a very small force to seal the valve—however, a significant force is required to open the valve and ‘lift’ the flexible member off the port. The main benefit with a magnetic system is that it can provide precise control with very little valve friction/wear. Unfortunately, the system can be more expensive than a purely mechanical system. Another difficulty with such a design is manufacturing a thin-walled tube to act as the flexible member.

---

**FR0: Control flow of high pressure gas through port**  
**DP0: Cylindrical rotary valve system**

- C1: Be non-reactive to air/fuel**
  - C2: Function for  $10^8$  cycles**
  - C3: Low-energy loss**
  - C4: High volumetric efficiency**
- 

The cylindrical geometry called for with DP0 means that the valve system looks similar to a harmonic drive system. As mentioned earlier, a cylindrical geometry can be difficult to seal because—unlike a cone—diametrical tolerances can be hard to maintain. Using the WaveFlex system, a number of solutions can be developed, including the magnetic system (as decomposed below). In addition, to satisfy the fourth constraint, a second WaveFlex design has been developed. Depending on the design, the buckled geometry can allow for high flow, but the buckle (similar to a poppet valve) does provide some interference.

---

**FR1: Seal port**

**DP1: Sealing system**

**FR2: Open port**

**DP2: Open-flow system**

$$\begin{array}{|c|c|c|} \hline X & x & 0 \\ \hline X & X & 0 \\ \hline x & X & X \\ \hline \end{array}$$

**FR3: Control timing**

**DP3: Actuation system**

---

Because of this different design, the FR for low-friction has been removed. Although low-friction is still a requirement, it is inherent in the design and is covered in a later branch. A minor coupling is still present between FR1 and FR2. The coupling is present because this specific design uses the new WaveFlex system with a magnetic actuation system. To actuate the flexible member, the shim stock must be ‘magnetic enough’—and the holes in the flexible member (due to the new WaveFlex design) hinder the magnetic attraction. Naturally, one can utilize a different actuation system—but even with a magnetic system, depending on the design, the holes in the flexible member may be small enough such that they do not present a significant hurdle. Even with the coupling however, a suitable design may still be found that exceeds the required sealing.

---

**FR1.1: Provide/maintain micro-level sealing around port**

**DP1.1: Surface finish**

**FR1.2: Provide/maintain macro-level sealing around port**

**DP1.2: Geometric alignment**

---

$$\begin{array}{|c|c|} \hline X & 0 \\ \hline X & X \\ \hline \end{array}$$

(see p.32)

---

**FR1.1.1: Manufacture smooth surface finish**

**DP1.1.1: Manufacturing processes**

**FR1.1.2: Maintain smooth surface finish**

**DP1.1.2: Surface material properties**

---

$$\begin{array}{|c|c|} \hline X & 0 \\ \hline x & X \\ \hline \end{array}$$

(see p.33)

---

**FR1.1.1.1: Provide smooth surface finish on port surface**

**DP1.1.1.1: Die-cast operation (optional port surface grinding operation)**

**FR1.1.1.2: Provide smooth surface finish on flexible member**

**DP1.1.1.2: Extrusion followed by rolling operation**

---

$$\begin{array}{|c|c|} \hline X & 0 \\ \hline 0 & X \\ \hline \end{array}$$

The only main deviation in this branch from earlier designs is that a smooth tube must be formed, as opposed to a smooth annular-shaped piece of shim stock. Forming a thin-



walled tube can be a difficult manufacturing process—especially considering the size and tolerances required. Depending on the material and valve-design, the wall thickness would likely be less than 0.01” thick; and the tolerance for the wall thickness—again, depending on other parameters—would probably be less than  $\forall 0.0005$ ”. A potential process would involve extrusion of a tube followed by a rolling operation. The extruded tube would be slightly thicker and more-undersized than required, and then one would roll the tube until the proper thickness and size were reached. This is a very difficult (and potentially coupled) process, because the rolling process is responsible for satisfying two FRs (thickness and diameter). Alternatively, one could attempt to butt-weld together a sheet of shim stock to form the tube—although this would be a very difficult process and the weld could affect sealing, wear and fatigue. To create a more successful system, without changing the manufacturing process, one could develop a more compliant design. For instance, a material with a lower elastic modulus would allow for a larger variation in wall-thickness. Similarly, a flexure rotor (or magnetic system) would create a larger allowable wall-thickness tolerance. In addition, as will be described further in the decomposition, the actuation system may reduce the effective size of a tube by introducing a small buckling (*figure 3.28*)

**FR1.1.2.1: Maintain smooth surface finish on port surface**

**DP1.1.2.1: Port surface hardness (or coating)**

**FR1.1.2.2: Maintain smooth surface finish on flexible member**

**DP1.1.2.2: Flexible member surface hardness (or coating)**

$$\begin{vmatrix} X & 0 \\ 0 & X \end{vmatrix}$$

(see p.33)

**FR1.2.1: Maintain flexible member ‘flatness’**

**DP1.2.1: Flexible member thickness**

**FR1.2.2: Prevent crack formation in flexible member**

**DP1.2.2: Crack prevention mechanism**

**FR1.2.3: Provide port/flexible member contact**

**DP1.2.3: Magnet actuation system**

**FR1.2.4: Maintain port/flexible member contact**

**DP1.2.4: Pressure differential (self-help)**

**FR1.2.5: Provide/maintain axial location of flexible member**

**DP1.2.5: Magnet locations or friction or etc.**

$$\begin{vmatrix} X & x & x & 0 & 0 \\ X & X & 0 & 0 & 0 \\ X & 0 & X & 0 & 0 \\ 0 & 0 & 0 & X & 0 \\ 0 & 0 & X & 0 & X \end{vmatrix}$$

Similar to D01a, this design uses the same DPs to satisfy FR1.2.1, FR1.2.2, FR1.2.4 and FR1.2.5. The key difference is that a magnetic actuation system is used to control the position of the flexible member. In doing so, a small coupling is developed between FR1.2.1 and FR1.2.3—an issue which is further complicated by the potential complications in the manufacturing of the system, as described above. Although FR/DP1.2.3 is decomposed further, a brief description the concept is provided below.



One of the key advantages with the magnetic system is that it replaces a mechanical interface with a magnetic one—which can significantly decrease friction and wear. In one embodiment of the magnetic system, a series of circumferentially-arranged electromagnets are placed in the housing, close to the surface. When a magnet is turned on, it attracts the magnetic flexible member toward the housing. As an example, if there are 12 magnets, and nine of them are turned on—such that a ‘continuous’ magnetic field covers approximately 270°—then the flexible member will be pulled into the housing except for a small ‘buckle’, where the magnetic field is not present. If one of the electromagnets is then switched off, while another is turned on, the magnetic field will shift slightly, and so will the buckle in the flexible member. Thus, by periodically turning the magnets on-and-off, one can rotate a magnetic field and actuate the flexible member (*figure 3.26*). In addition to using an electromagnetic system, one can use permanent magnets. The magnets could be placed on a rotor outside the housing. As the rotor moves, so would the magnetic field, and just as before the flexible member could be actuated.

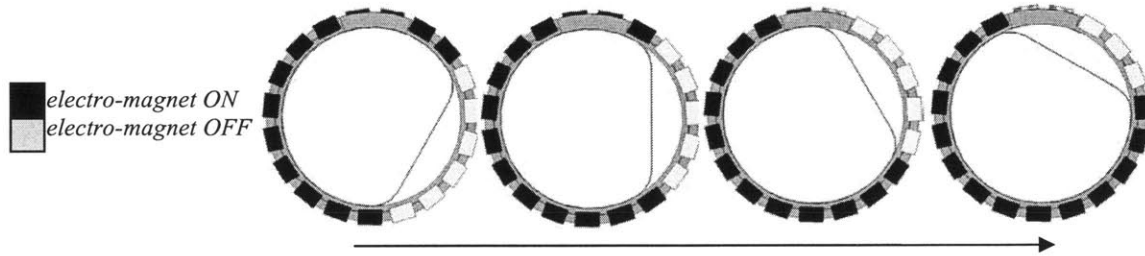

(Figure 3.26: WaveFlex magnetic actuation system)

Although this design allows one to control the flexible member remotely and with little friction/wear, it may be impractical in certain situations. For instance, permanent magnets can become less effective at higher temperatures, and an electronic control system may not always be effective.<sup>21</sup> Perhaps the most significant problem, however, with such a system is creating a powerful enough magnetic force. When using a self-help system (as in DP1.2.4), a relatively weak magnetic field can be used to pull the flexible member into the housing and thus seal the valve; however a strong force is required to open the system. A force must be applied which is powerful enough to pull the flexible member away from the port. Thus, a magnetic system is better suited to low-pressure sealing, although with more powerful equipment, a high-pressure system could be developed.

The main difficulty in creating a large force is the flexible member: which is very thin, and thus tends to not be very magnetic. To counter this, a more magnetic material or coating can be applied (it can be difficult to find a material with an appropriate stiffness and high magnetic permeability). In addition, one can generate a stronger magnetic field and place the magnets closer to the flexible member (the magnetic field reduces with the inverse-squared of the distance); both can be difficult for geometric and pressure constraints, respectively. Another advantage with the magnetic system is that the same magnets can be used to satisfy DP1.2.5.

<sup>21</sup> The material property of the magnet determines the maximum operating temperature. If one were to use permanent magnets in an engine, the most likely candidates would be Alnico, Ferrite, or SmCo. Electromagnets may be used as well, but again appropriate materials must be selected.

---

**FR1.2.2.1: Avoid interference**  
**DP1.2.2.1: Flexible member axial width**

**FR1.2.2.2: Avoid cyclic fatigue**  
**DP1.2.2.2: Flexible member Young's modulus of elasticity**

---

$$\begin{vmatrix} X & 0 \\ 0 & X \end{vmatrix}$$

(see p.35)

---

**FR1.2.3.1: Provide sufficient force**  
**DP1.2.3.1: Magnetic force system**

**FR1.2.3.2: Provide sufficient force resolution**  
**DP1.2.3.2: Electro-magnet area and distribution**

---

$$\begin{vmatrix} X & 0 \\ 0 & X \end{vmatrix}$$

Just as with the flexure rotor from D01a, the magnetic rotor must provide enough force and distribute that force evenly. The force is a function of several parameters which are decomposed below. The force *resolution* is controlled by a number of variables, but in this design, only the magnet area and physical distribution of the magnets are considered (alternatively one could use distance from surface—the magnetic field spreads as the distance increases—but that would hurt FR1.2.3.1 and not allow a large drop in the magnetic field where the gap should be, instead the magnetic field would gradually drop to zero).

---

**FR1.2.3.1.1: Provide powerful magnetic field**  
**DP1.2.3.1.1: Electro-magnet strength (#coils, voltage, etc.)**

**FR1.2.3.1.2: Provide sufficient attractive force**  
**DP1.2.3.1.2: Flexible member magnetic permeability**

---

$$\begin{vmatrix} X & 0 \\ X & X \end{vmatrix}$$

To create a large magnetic force, one needs a powerful magnetic field and a material that is affected by that field (i.e.—high magnetic permeability). To control the magnetic field strength, one can adjust a number of parameters, as noted in DP1.2.3.1.1. One of the difficulties in this design, however, may be finding a material with a high magnetic permeability that can also satisfy the other FRs and constraints presented in the design. If a suitable material cannot be found, then one may be able to apply a coating or even attach small magnets (or magnetic components) to the flexible member.

---

**FR2.1: Provide controlled circumferential shift of flexible member**  
**DP2.1: Buckle**

**FR2.2: Allow flow**  
**DP2.2: Hole in flexible member**

---

$$\begin{vmatrix} X & 0 \\ 0 & X \end{vmatrix}$$

As described earlier, the 'buckling' in a cylindrical system can be formed by using an

under- or over-sized tube. An over-sized tube would form a buckling that is comparable to that in D01—a steep profile which can provide high volumetric efficiency. An under-sized tube forms a gap (similar to harmonic drive) which is not technically a buckling, but serves the same function as one. Both geometries have their advantages and are each better suited to different conditions (including interference, number of cycles, size, cost constraints, etc.).

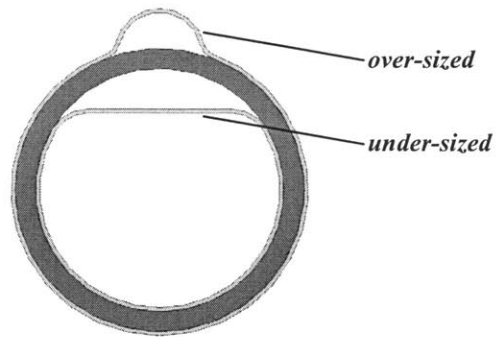

Figure 3.27

In addition, an under-sized tube can be perfectly constrained (as shown in figure 3.2.24) or it may have extra compliance. The constrained system means that the amount of exposed surface on the housing will always be constant;

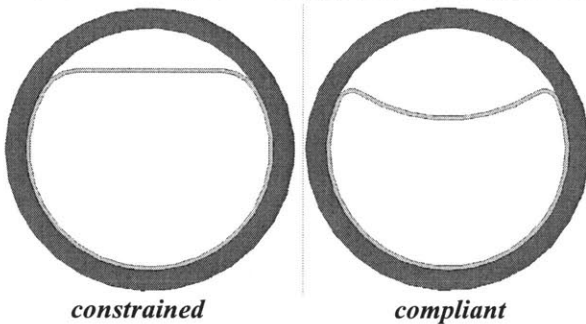

Figure 3.28

which may be advantageous in certain designs because the percent of valve opening may be enforced better. However, the compliant system can also be advantageous. For instance, here the amount of exposed housing is a function of the actuator, and not the diameter of the flexible member (as noted earlier, it may be difficult to manufacture diametrical tolerances and it may be difficult to maintain them on account of thermal expansion). Thus, assuming a

good actuator design, one can have better control of the valve opening and closing—and, under some actuation systems (such as magnetic), can even vary the percent opening while the valve is running (i.e.—VVT, which is a must sought after goal in engine designs)

Instead of using the buckling to open the port, DP2.2 calls for a series of holes to be placed in the flexible member. As the buckling passes over the port, the flexible member translates a controlled amount (depending on the size of the buckling). Thus, when the hole is lined up with the port, the valve is open—and there is no resistance to the flow. When the hole is not over the port, then the valve is sealed (as it was in earlier designs). This design can be considered a multi-turn design (as opposed to the previous WaveFlex system, which was a quarter-turn) because the valve can be open for an entire revolution—or even several revolutions, if the holes are stretched larger. However, because the valve is opened when the hole in the flexible member lines up with the port and when the buckling passes the port, while the valve can be open for several revolutions, it cannot remain fully sealed for more than one revolution (whenever the buckling passes over the port, the valve opens momentarily). Of course the profile of the buckling can be changed to minimize the angular size of the buckled portion so it will have less of an impact on the valve sealing (i.e.—the buckle can be very small).

As noted earlier, the hole(s) in the flexible member will reduce the net magnetic attraction of the flexible member to the housing. However, one can minimize this effect by increasing the axial width of the flexible member (so that the holes present a smaller percentage of the overall surface area), by using a thicker flexible member, by using more

powerful magnets, or by using a material with a higher magnetic permeability—to name just a few alternatives. Thus, although DP2.2 does affect the sealing system, the problem can be solved in any number of ways.

---

**FR2.1.1: Control size of buckling**

**DP2.1.1: Flexible member tube circumference (oversized)**

**FR2.1.2: Prevent slipping of flexible member**

**DP2.1.2: High friction or notches**

$$\begin{array}{|c|c|} \hline X & 0 \\ \hline 0 & X \\ \hline \end{array}$$

Two important FRs must be controlled to ensure the success of the valve. First, the size of the buckling should be controlled. Not only should the appropriate size be manufactured (with appropriately sized holes), but the flexible member should not expand (due to wear or thermal expansion)—or, if it does expand, it should be done in a controlled manner so that the holes will remain lined up with the housing. Second, to prevent the flexible member from sliding on the housing, a very high friction interface should be created between the housing and flexible member. Additionally, one could create notches in the flexible member which would line up with posts on the housing.

An alternative approach—or addition to the above—would be to re-initialize the system periodically. One method of doing so would be to rotate the valve clockwise for a number of rotations and then counter-clockwise for the same number of rotations. This might not be ideal in an engine, because the engine would have to be temporarily shut off to allow for this transition—however, it could work in a hybrid car, where the engine could be turned off periodically without having a noticeable effect on the vehicle's ability to drive.

---

**FR3.1: Control frequency**

**DP3.1: Actuation speed**

**FR3.2: Control % time open**

**DP3.2: Port size (circumferential arc length)**

$$\begin{array}{|c|c|} \hline X & 0 \\ \hline 0 & X \\ \hline \end{array}$$

(see p.37)





### 3.2.3.4. D02B



GEOMETRY:	<i>Cylinder B</i>
ACTUATION:	<i>Pneumatic</i>
PRESSURE:	<i>Reverse</i>
OPENING:	<i>Buckle</i>

*Figure 3.29*

The above design combines the cylindrical geometry from D01a with an earlier WaveFlex design, while introducing another actuation system. Similar to the magnetic system, this design pulls the flexible member into the housing—only using a pneumatic suction system. On the inner surface of the housing are small holes. A series of holes (parallel to the axis of the cylinder) are inter-connected and can be controlled via a pneumatic tube which is attached to a vacuum control system. It may seem unpractical to control one valve via another valve or set of valves, although it may prove practical in some scenarios (in fact, a similar rotary valve could be used to control this valve!). As with the magnetic system, the friction and wear are very low, but the system can be expensive to employ.

---

***FR0: Control flow of high pressure gas through port***  
***DP0: Cylindrical rotary valve system***

***C1: Be non-reactive to air/fuel***  
***C2: Function for  $10^8$  cycles***  
***C3: Low-energy loss***  
***C4: Low interference with piston***

---

Although D02b calls for a cylindrical valve, it adds an extra constraint—that the valve not be placed in the cylinder. To satisfy C4, the valve is re-oriented as shown in *figure 3.29*. There are other ways which the valve can be modified to minimize piston interference, but only this option will be decomposed.

---

**FR1: Seal port**

**DP1: Sealing system**

**FR2: Open port**

**DP2: Open-flow system**

X	0	0
X	X	0
0	0	X

**FR3: Control timing**

**DP3: Actuation system**

---

(see p.47)

---

**FR1.1: Provide/maintain micro-level sealing around port**

**DP1.1: Surface finish**

**FR1.2: Provide/maintain macro-level sealing around port**

**DP1.2: Geometric alignment**

---

X	0
X	X

(see p.32)

---

**FR1.1.1: Manufacture smooth surface finish**

**DP1.1.1: Manufacturing processes**

**FR1.1.2: Maintain smooth surface finish**

**DP1.1.2: Surface material properties**

---

X	0
x	X

(see p.33)

---

**FR1.1.1.1: Provide smooth surface finish on port surface**

**DP1.1.1.1: Die-cast operation (optional port surface grinding operation)**

**FR1.1.1.2: Provide smooth surface finish on flexible member**

**DP1.1.1.2: Extrusion followed by rolling operation**

---

X	0
0	X

(see p.47)

---

**FR1.1.2.1: Maintain smooth surface finish on port surface**

**DP1.1.2.1: Port surface hardness (or coating)**

**FR1.1.2.2: Maintain smooth surface finish on flexible member**

**DP1.1.2.2: Flexible member surface hardness (or coating)**

---

X	0
0	X

(see p.33)

---

**FR1.2.1: Maintain flexible member ‘flatness’**

**DPI.2.1: Flexible member thickness**

**FR1.2.2: Prevent crack formation in flexible member**

**DPI.2.2: Crack prevention mechanism**

**FR1.2.3: Provide/maintain port/flexible member contact**

**DPI.2.3: Pneumatic actuation system**

**FR1.2.4: Provide/maintain axial location of flexible member**

**DPI.2.4: Magnet locations or friction or etc.**

---

X	x	X	0
X	X	0	0
0	0	X	0
0	0	0	X

This decoupled system uses an elaborate pneumatic control system as a rotor. The system can be likened to a magnetic actuation system—where the flexible member is pulled into the housing, rather than pushed—only a different force is applied. A series of holes opening to the flexible member are placed in the housing. Each hole (or sub-group of closely-placed holes) is connected via a channel to a vacuum system. As each channel is actuated, the holes pull the flexible member into the housing. To realize success, there must be enough suction force and the flexible member must be close enough to the holes that it will be pulled inwards by the vacuum. This is especially an issue at the ‘buckle’, where the gap between the housing and flexible member can be considerably large—so large that the pneumatic system may not draw the flexible member in. To avoid this dilemma, the hole resolution must be very fine and the suction must be powerful. If the pneumatic system has sufficient resolution then the gap between the flexible member and the housing can be minimized (see figure 3.30)

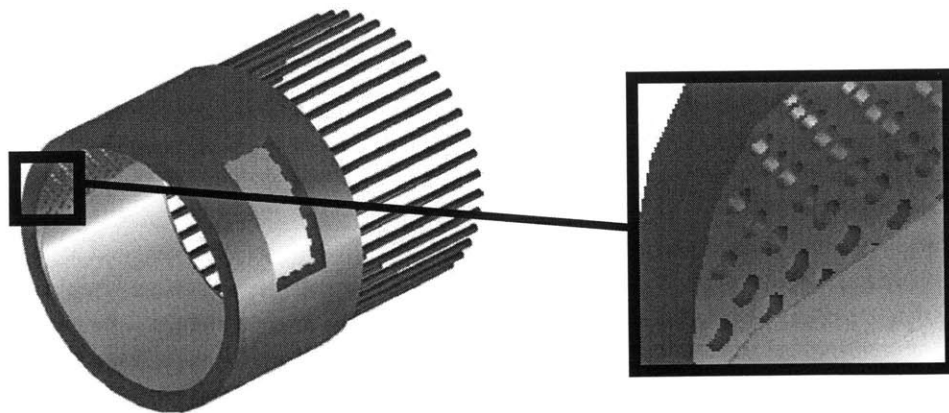

(Figure 3.30: WaveFlex pneumatic actuation system)

Although not applicable in this design because of C4, one could also transform a mechanical rotor into an air-bearing, so that one would use a solid rotor that pushed the flexible member into the housing. Thus, rather than a mechanical rubbing or rolling

interface, one could use a high-pressure fluid interface—where the only friction would be within the fluid (and could be minimized by choosing a fluid with low viscosity).

---

**FR1.2.2.1: Avoid interference**

**DP1.2.2.1: Flexible member axial width**

**FR1.2.2.2: Avoid cyclic fatigue**

**DP1.2.2.2: Flexible member Young's modulus of elasticity**

$$\begin{array}{|c|c|} \hline X & 0 \\ \hline 0 & X \\ \hline \end{array}$$

(see p.35)

---

**FR1.2.3.1: Provide sufficient force**

**DP1.2.3.1: Total pneumatic hole area & suction pressure**

**FR1.2.3.2: Provide sufficient force resolution**

**DP1.2.3.2: Vacuum hole resolution**

$$\begin{array}{|c|c|} \hline X & 0 \\ \hline 0 & X \\ \hline \end{array}$$

As noted earlier, the pneumatic system must be powerful enough and have a fine enough resolution to pull the flexible member into the housing and resist the powerful pressure differential pushing the flexible member away from the port.

---

**FR2.1: Provide 'buckling'**

**DP2.1: Flexible member tube circumference (undersized)**

**FR2.2: Manage size of 'buckled' portion**

**DP2.2: Gap in 'pneumatic field'**

$$\begin{array}{|c|c|} \hline X & 0 \\ \hline 0 & X \\ \hline \end{array}$$

While a buckle is formed by the tube-size, the angular size of the buckling is controlled by the pneumatic actuation system. To shrink the buckling, at any given moment, more holes will be activated. Similarly, one can create a wider rotor gap by actuating a smaller section of the holes.

---

**FR3.1: Control frequency**

**DP3.1: Actuation speed**

**FR3.2: Control % time open**

**DP3.2: Port size (circumferential arc length)**

$$\begin{array}{|c|c|} \hline X & 0 \\ \hline 0 & X \\ \hline \end{array}$$

(see p.37)





### 3.2.3.5. D03A

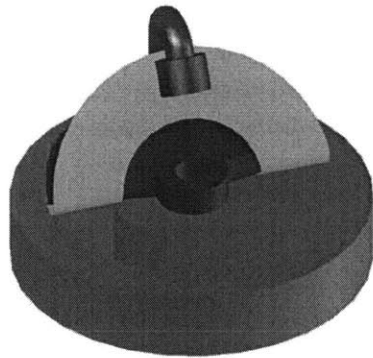

*Figure 3.31*

GEOMETRY:	<i>Disk A</i>
ACTUATION:	<i>Mechanical</i>
PRESSURE:	<i>Reverse</i>
OPENING:	<i>Buckle</i>

Although other geometries exist, the last geometry to be introduced here is a disk. This design calls for a mechanical actuation system. The main difference between this design from other presented is that D03a is better suited for a valve which stays open longer than it stays closed—in theory, a cone is better suited for a valve which should stay sealed longer and a cylinder can work under both extremes. In fact, in the design described here, the valve cannot stay sealed longer for more than 50% of the time, unless the actuator speed is adjusted while running.

The rotor here has a vertical guide that pulls the flexible member off of the housing surface—however, a number of guide designs may be developed. Perhaps the most significant benefit with a disk geometry is that it can be easier to manufacture than other geometries because the surfaces are flat. Indeed, with some minor modifications, this design could be entirely stamped (although the shaft—not shown—should probably be made by some other process).

---

***FR0: Control flow of high pressure gas through port***

***DP0: Disk rotary valve system***

***C1: Be non-reactive to air/fuel***

***C2: Function for  $10^8$  cycles***

***C3: Low-energy loss***

***C4: Low interference with piston***

---

Although D03a calls for a new geometry, the constraints are repetitions from earlier designs. As such, some unique DPs will be developed, but a significant portion of the decomposition will overlap with earlier designs.

---

---

**FR1: Seal port**

**DP1: Sealing system**

**FR2: Open port**

**DP2: Open-flow system**

**FR3: Control timing**

**DP3: Actuation system**

**FR4: Minimize friction**

**DP4: Friction reduction system**

---

X	X	0	0
0	X	0	0
0	X	X	0
X	0	X	X

(see p.31)

---

**FR1.1: Provide/maintain micro-level sealing around port**

**DP1.1: Surface finish**

**FR1.2: Provide/maintain macro-level sealing around port**

**DP1.2: Geometric alignment**

---

X	0
X	X

(see p.32)

---

**FR1.1.1: Manufacture smooth surface finish**

**DP1.1.1: Manufacturing processes**

**FR1.1.2: Maintain smooth surface finish**

**DP1.1.2: Surface material properties**

---

X	0
x	X

(see p.33)

---

**FR1.1.1.1: Provide smooth surface finish on port surface**

**DP1.1.1.1: Die-cast operation (optional port surface grinding operation)**

**FR1.1.1.2: Provide smooth surface finish on flexible member**

**DP1.1.1.2: Rolling operation**

---

X	0
0	X

(see p.33)

---



---

**FR1.1.2.1: Maintain smooth surface finish on port surface**

**DP1.1.2.1: Port surface hardness (or coating)**

**FR1.1.2.2: Maintain smooth surface finish on flexible member**

**DP1.1.2.2: Flexible member surface hardness (or coating)**

X	0
0	X

(see p.33)

---

**FR1.2.1: Maintain flexible member 'flatness'**

**DP1.2.1: Flexible member thickness**

**FR1.2.2: Prevent crack formation in flexible member**

**DP1.2.2: Crack prevention mechanism**

**FR1.2.3: Allow for port/flexible member contact (parallel surfaces)**

**DP1.2.3: Rotor**

**FR1.2.4: Provide/maintain port/flexible member vertical contact**

**DP1.2.4: Floating valve seat**

**FR1.2.5: Provide/maintain concentricity of flexible member**

**DP1.2.5: Circumferential magnets or friction or etc.**

X	0	X	0	0
X	X	0	0	0
0	0	X	0	0
0	0	0	X	0
0	0	0	0	X

This design is similar to D01b, except that DP1.2.3 is a solid rotor (rather than a pressure plate). This device can be easier to manufacture than others because all the components are flat—it is much easier to manufacture a flat, smooth surface than to make a smooth conical/cylindrical surface. Because of this ease in manufacturing, one can produce more precise parts which are less compliant.

---

**FR1.2.2.1: Avoid interference**

**DP1.2.2.1: Flexible member diameter**

**FR1.2.2.2: Avoid cyclic fatigue**

**DP1.2.2.2: Flexible member guide (i.e.—fillets on rotor)**

X	X
0	X

(see p.35)

---

**FR1.2.3.1: Provide resistive force**

**DP1.2.3.1: Rotor stiffness**

**FR1.2.3.2: Provide flat surface**

**DP1.2.3.2: Machining operation**

X	0
0	X

The rotor is designed such that it is stiff enough to resist the high forces from the in-cylinder pressure. A decomposition of the component would include requirements related to both material and geometric properties. Providing a flat surface is subject to both the stiffness of the rotor and the manufacturing of the rotor—as noted earlier, a die-cast operation might even be sufficient. Similarly, it is imperative that the shaft be perpendicular to both the housing and rotor. While a small degree of compliance could be added in the design, it seems that manufacturing such precision on a ‘flat’ system would be a low-cost and relatively simple operation.

**FR2.1: Provide ‘buckling’**

**DP2.1: Flexible member lifting guide**

**FR2.2: Manage size of buckled portion**

**DP2.2: Cut in rotor**

<i>X</i>	<i>0</i>
<i>X</i>	<i>X</i>

(see p.36)

**FR3.1: Control frequency**

**DP3.1: Actuation speed**

**FR3.2: Control % time open**

**DP3.2: Port size (circumferential arc length)**

<i>X</i>	<i>0</i>
<i>0</i>	<i>X</i>

(see p.37)

**FR4.1: Minimize flexible member/rotor coefficient of friction**

**DP4.1: Rotor surface properties**

**FR4.2: Minimize flexible member/rotor contact force**

**DP4.2: Raised valve seat/port contact area**

<i>X</i>	<i>0</i>
<i>0</i>	<i>X</i>

(see p.37)



3.2.3.6. D03B

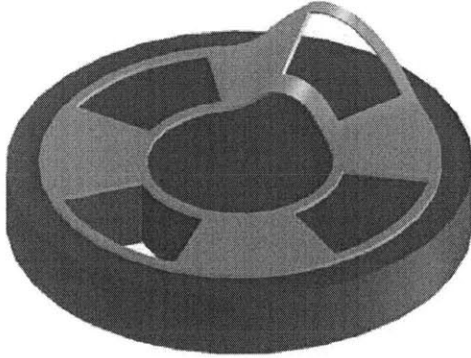

Figure 3.32

GEOMETRY: *Disk B*  
 ACTUATION: *Magnetic*  
 PRESSURE: *Self-help*  
 OPENING: *Holes*

The above design is a combination of earlier designs, with a few minor modifications. The most significant adjustment is that to allow a disk system to use the second WaveFlex form, the flexible member cannot be a simple annular piece as before; instead, it must be stretched as shown above. This flexible member could be produced in a stamping operation, although it might be difficult to repeatedly produce the part in such a process.

**FR0: Control flow of high pressure gas through port**  
**DP0: Disk rotary valve system**

- C1: Be non-reactive to air/fuel**
- C2: Function for  $10^8$  cycles**
- C3: Low-energy loss**
- C4: Low interference with piston**
- C5: High volumetric efficiency**

D03b adds an extra constraint from D03a, meaning that the second WaveFlex form will be utilized. As in earlier decompositions, although the constraints do not require certain elements present in this design, they have been used to introduce some variety.

**FR1: Seal port**  
**DP1: Sealing system**

**FR2: Open port**  
**DP2: Open-flow system**

**FR3: Control timing**  
**DP3: Actuation system**

<i>X</i>	<i>x</i>	<i>0</i>
<i>X</i>	<i>X</i>	<i>0</i>
<i>x</i>	<i>X</i>	<i>X</i>

(see p.31)

---

**FR1.1: Provide/maintain micro-level sealing around port**

**DP1.1: Surface finish**

**FR1.2: Provide/maintain macro-level sealing around port**

**DP1.2: Geometric alignment**

$$\begin{array}{|c|c|} \hline X & 0 \\ \hline X & X \\ \hline \end{array}$$

(see p.32)

---

**FR1.1.1: Manufacture smooth surface finish**

**DP1.1.1: Manufacturing processes**

**FR1.1.2: Maintain smooth surface finish**

**DP1.1.2: Surface material properties**

$$\begin{array}{|c|c|} \hline X & 0 \\ \hline x & X \\ \hline \end{array}$$

(see p.33)

---

**FR1.1.1.1: Provide smooth surface finish on port surface**

**DP1.1.1.1: Die-cast operation (optional port surface grinding operation)**

**FR1.1.1.2: Provide smooth surface finish on flexible member**

**DP1.1.1.2: Rolling operation**

$$\begin{array}{|c|c|} \hline X & 0 \\ \hline 0 & X \\ \hline \end{array}$$

(see p.33)

---

**FR1.1.2.1: Maintain smooth surface finish on port surface**

**DP1.1.2.1: Port surface hardness (or coating)**

**FR1.1.2.2: Maintain smooth surface finish on flexible member**

**DP1.1.2.2: Flexible member surface hardness (or coating)**

$$\begin{array}{|c|c|} \hline X & 0 \\ \hline 0 & X \\ \hline \end{array}$$

(see p.33)

---

**FR1.2.1: Maintain flexible member 'flatness'**

**DP1.2.1: Flexible member thickness**

**FR1.2.2: Prevent crack formation in flexible member**

**DP1.2.2: Crack prevention mechanism**

**FR1.2.3: Provide port/flexible member contact**

**DP1.2.3: Magnet actuation system**

---

**FR1.2.4: Maintain port/flexible member contact**  
**DPI.2.4: Pressure differential (self-help)**

X	x	x	0	0
X	X	0	0	0
X	0	X	0	0
0	0	0	X	0
0	0	X	0	X

**FR1.2.5: Provide/maintain axial location of flexible member**  
**DPI.2.5: Magnet locations or friction or etc.**

(see p.48)

---

**FR1.2.2.1: Avoid interference**  
**DPI.2.2.1: Flexible member diameter**

**FR1.2.2.2: Avoid cyclic fatigue**  
**DPI.2.2.2: Flexible member Young's modulus of elasticity**

X	0
0	X

(see p.35)

---

**FR1.2.3.1: Provide sufficient force**  
**DPI.2.3.1: Magnetic force system**

**FR1.2.3.2: Provide sufficient force resolution**  
**DPI.2.3.2: Electro-magnet area and distribution**

X	0
0	X

(see p.50)

---

**FR1.2.3.1.1: Provide powerful magnetic field**  
**DPI.2.3.1.1: Electro-magnet strength (#coils, voltage, etc.)**

**FR1.2.3.1.2: Provide sufficient attractive force**  
**DPI.2.3.1.2: Flexible member magnetic permeability**

X	0
X	X

(see p.50)

---

**FR2.1: Provide controlled circumferential shift of flexible member**  
**DP2.1: Buckle**

**FR2.2: Allow flow**  
**DP2.2: Hole in flexible member**

X	0
0	X

(see p.50)

---

---

**FR2.1.1: Provide buckling**

**DP2.1.1: Stretched flexible member**

**FR2.1.2: Manage size of buckled portion**

**DP2.1.2: Gap in magnetic field**

$$\begin{vmatrix} X & 0 & 0 \\ 0 & X & 0 \\ 0 & 0 & X \end{vmatrix}$$

**FR2.1.3: Prevent slipping of flexible member**

**DP2.1.3: High friction or notches**

---

Unlike in D02a, the buckling here is formed by stretching the flexible member (as described above). Stretching such a part while maintaining the required tolerances can be difficult. Fortunately, the magnetic system allows for some compliance, so that the thickness of the flexible member can vary more than in other designs. Nonetheless, it can be difficult to stretch the material the desired amount while maintaining the desired concentricity. Potential solutions include stamping and rolling operations, or a combination of the two. Both processes can be modified to ensure that the proper FRs/constraints are still satisfied, but the system of producing the flexible member will most likely be more expensive than the conical one (where a flat sheet could simply be stamped, without any stretching). However, manufacturing the disk-shaped housing (as opposed to a cone) would most likely be cheaper and could thus offset other added costs.

---

**FR3.1: Control frequency**

**DP3.1: Actuation speed**

**FR3.2: Control % time open**

**DP3.2: Port size (circumferential arc length)**

---

$$\begin{vmatrix} X & 0 \\ 0 & X \end{vmatrix}$$

(see p.37)

---





## 4. TECHNICAL

### 4.1. WEAR

As noted in the decompositions, wear of the rotary valve is a critical design consideration. Fortunately, significant wear only occurs on a few surfaces. From experiments performed, it seems that the flexible member is the component most likely to fail—so the bulk of the analysis presented will be on preventing failure associated to the wear of the thin shim stock. In addition, although the flexible member can be made of any number of materials, including plastics, the analysis will focus on an all-metal system.

Due to the flexible member's thickness, significant wear can only occur on two surfaces. One side of the flexible member rolls on the housing, and thus the only significant wear associated with this face can be corrosive or chemical wear from the hot gasses (and possibly particulates) flowing over the surface. The other face is also susceptible to corrosive and chemical wear, but may also experience sliding and abrasive wear if the actuator is mechanical as in D01 (there is no sliding in a magnetic or pneumatic system). As wear analysis is highly experimental by nature—and time did not permit a thorough study—the discussion will be mostly qualitative in nature and focus on potential solutions to minimize wear. It is also important to understand that, because of the relative thicknesses, it is much more favorable for the rotor to wear at a faster rate than the flexible member. The geometry of the rotor can be easily modified (i.e.—enlarged so that there is more material to 'wear out'—and can thus function longer) without affecting other FRs, while the thickness of the flexible member is tied to a number of other FRs, including cyclic fatigue.

On the highest level, one may consider the following wear equation:

$$V = K \frac{LS}{3H} \quad 22$$

*;where V is the approximate volume of material lost by wear; L is the normal load; S is the relative distance slid between the two contact surfaces; and H is the material surface hardness. K, the wear coefficient, is a dimensionless proportionality constant which depends on a number of conditions (including material properties, geometric properties and the wear mechanisms).*

As one might expect, the wear rate is reduced with a harder surface because fewer wear particles are generated and abrasive particles will be less like to deform the surface of the material. Also, for many of the same reasons, one can reduce the wear rate by applying a lighter normal load.

However, much research has been applied into developing more advanced techniques which can reduce the wear much more than the simple wear equation describes. Wear is also affected by other parameters, such as the loading conditions and face geometries. Following is a potential design for the interface between the flexible member and mechanical rotor as described in D01a. A number of DPs specifically related to the wear of the system are discussed.

---

<sup>22</sup> See p. 13 of [12]

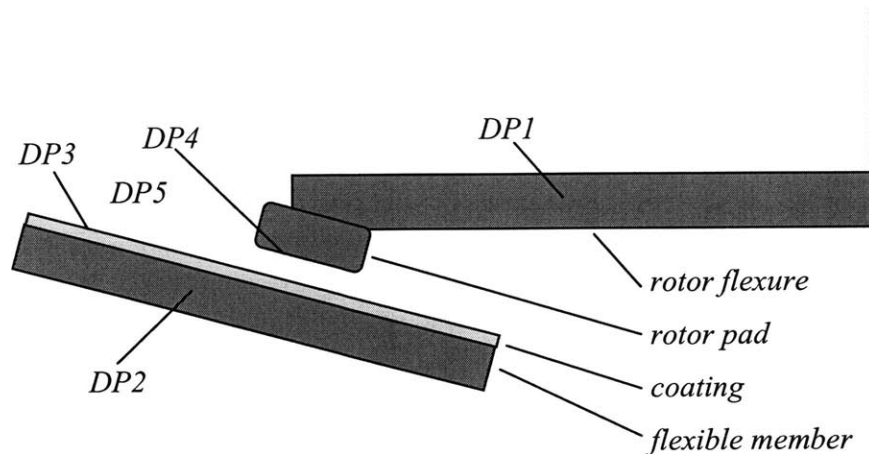

(Figure 4.1: wear analysis)

DP1 As described in the wear equation, the wear volume is proportional to the normal load applied. In reality, the relationship is not entirely linear, but the trend is still present. The most significant counter example is in asperity deformation and fracture in the initial life of the system. The manufactured surfaces will be relatively rough and wavy, so for the first cycles of the valve, the surface asperities are removed until a smooth surface is created. Although a heavier load will remove the material faster initially, over time, both will ‘polish’ the rough surface. However, once steady-state is reached, the heavier load will have a higher wear rate.

Thus, the rotor flexure should be designed to provide enough load to allow the valve function properly, but any excess load will negatively impact the wear.

DP2 As described in the wear equation, the wear volume is inversely proportional to the surface hardness (as noted earlier, however, the wear can also be controlled by managing loading conditions and other factors). Thus, the flexible member should be made of a relatively hard material. While one can determine a lower bound for the hardness of the material, the upper bound would most likely be determined by some other factor—such as cost or induced stresses (i.e.—cyclic fatigue).

DP3 One way of achieving the required hardness and providing superior chemical stability, without affecting the bulk material properties, is to apply a coating or surface treatment. Surface hardness is especially important in avoiding abrasive wear. As Suh notes, “the role of the hard layer is to prevent plowing”<sup>23</sup> A number of processes may be used to apply the required chemical bond between the surface layer and the bulk material, ranging from chemical vapor deposition (CVD) to activated reactive evaporation. When deciding on an appropriate coating, one must

<sup>23</sup> See p. 454 of [12]

consider the environment (such as temperatures and chemicals) as well the substrate properties. Some potential surface treatments include TiO and Al<sub>2</sub>O<sub>3</sub>.

However, while a harder surface is more resilient to abrasive wear, some studies have shown that a thin layer of a soft metal helps prevent delamination. For instance, the wear rate was orders of magnitude lower after an AISI 4140 steel was coated with a 1 μm layer of nickel.<sup>24</sup> The thin nickel layer provides a tough medium which is more resilient to crack nucleation and propagation than a harder steel would be on its own. A more thorough study would need to be conducted, however, as the nickel coating does not seem to work to well in air, because of oxidation. Potential metals might include gold or copper.<sup>25</sup>

To determine the appropriate surface treatment, an experimental study would need to be performed simulating the appropriate conditions.

DP4 The surface of the rotor pad should be hard and contain micro-voids. A hard surface—such as bearing steel—should produce lower friction when encountering the soft metal coating in DP3. In addition, it will be less susceptible to abrasive wear. The undulated surface of the pad will also minimize abrasive wear by trapping small particles before they increase in size and/or plow into the surfaces. An undulated surface has been shown to reduce wear and friction significantly.<sup>26</sup>

DP5 Depending on the application of the valve, one may apply a lubricant between the surfaces. The effect of oil would significantly reduce wear and friction by creating a hydrodynamic system. However, due to temperature constraints, the valve may be required to run dry. In addition, in an engine, the oil would most likely leak into the engine and hurt emissions.

## 4.2. CYCLIC FATIGUE

As with most engine components, one must carefully consider the effects of cyclic fatigue when designing the rotary valve. The valve will experience a number of cyclic loads—including the shock from combustion and the piston movement—but the most significant stresses are found in the flexible member and are induced by the actuation of the valve itself. As the valve opens and closes, the buckle in the flexible member translates and generates high cyclic stresses at the bends.

One can approximate that, in an engine, the valve should last for several years without needing to be replaced—meaning that the valve should endure on the order of 10<sup>8</sup> cycles without succumbing to cyclic fatigue (even if it is just a low-cost flexible member, the cost and hassle of maintenance require this constraint). However, for most materials, the fatigue limit is well below 10<sup>8</sup>, meaning that one need design the flexible

---

<sup>24</sup> See p. 446 of [12]

<sup>25</sup> See p. 454 of [12]

<sup>26</sup> See p. 420 of [12]

member such that the stresses in the part are below the fatigue limit (which is often approximated as  $10^6$  or  $10^7$  cycles). Moreover, if appropriately designed to prevent cyclic fatigue for up to  $10^8$  cycles, the valve should theoretically last much longer (even infinitely... although something will fail eventually).

To conduct an appropriate analysis, the flexible member would need to be tested experimentally, using a fatigue-testing machine. However, for my analysis, I will use techniques that have been developed to estimate the fatigue limit of materials based on other material properties. Although different sources use different equations, the most basic typically appear as follows:

$$\sigma_d = S_{rb} C_L C_D C_s (C_q C_a)^{27}$$

*;where  $\sigma_d$  is the fatigue limit of a smooth specimen,  $S_{rb}$  is the experimentally determined fatigue limit of an un-notched specimen in rotating-bending,  $C_L$  accounts for the actual type of loading (which equals one if the part is under rotating-bending loading),  $C_D$  scales the limit depending on specimen size,  $C_s$  describes the surface finish,  $C_q$  accounts for the shape of the cross-section, and  $C_a$  the anisotropy of the fatigue properties (although this factor can be avoided if corresponding test results can be obtained).*

In the studies conducted at MIT, I used 1095 spring steel that was quenched at 800C and tempered at 480C. For this steel,  $S_{rb}$  is approximately 88 ksi.<sup>28</sup> Also, in our design, the flexible member is a very thin and smooth part with a rectangular cross-section that is under cyclic bending; as such, the following values may be used for the flexible member:

$C_L=1$  because the part will be loaded approximately as in the study to determine  $S_{rb}$

$C_D=1$  the flexible member is so thin that the thickness should not create a significant stress gradient in the cross-section. There are other technological and statistical reasons, but are beyond the scope of this paper.<sup>29</sup>

$C_s=0.8 - 1$  As the tests for fatigue limit are conducted with smoothly polished specimens, a mirror finish provides unity, while a coarse finish can drop the fatigue limit much lower; even a fine ground surface will drop this factor to 0.8 (or below, depending on the material tensile strength). As the flexible member will be cold-rolled, one can expect a surface factor value near 0.9.<sup>30</sup>

$C_q=0.8$  The fatigue limit of a rectangular cross-section is slightly lower than a round specimen because of the “detrimental effect of the interior surface quality at the specimen corners”.<sup>31</sup>

Thus, without a safety factor, for a smooth, non-coated flexible member as described in earlier designs, the fatigue limit will be approximately:

$$88 \text{ ksi} * 1 * 1 * 0.9 * 0.8 = \mathbf{65 \text{ ksi}} ;$$

<sup>27</sup> See p. 58 of [2]

<sup>28</sup> See p.335 of [2]

<sup>29</sup> See p. 54 of [2]

<sup>30</sup> See p. 52 of [2]

<sup>31</sup> See p. 58 of [2]

Another analysis must be performed on the flexible member with holes in it (see D03b), as the holes can introduce stress concentrations which may decrease the fatigue limit. Once again, a thorough experimental study must be conducted to determine the precise effect of the holes on the fatigue strength, but approximations can be made using the following equations:

$$\sigma_{dn} = \frac{\sigma_d}{K_F} \quad ; \text{where } \sigma_{dn} \text{ is the fatigue limit (at } N=10^7 \text{ cycles) of a notched specimen, and } \sigma_d \text{ is the fatigue limit of an un-notched specimen; } K_F \text{ is the fatigue notch factor; } K_T \text{ is the theoretical stress concentration factor (a geometric variable); and } q \text{ is the notch sensitivity factor (} q \text{ equals zero for a perfectly notch-insensitive material, and unity for a perfectly sensitive material).}$$

$$K_F = 1 + (K_T - 1)q$$

From experimentally derived data sheets,  $K_T$  for D03a can be approximated as under 2, and close to 1.5.<sup>33</sup> Similarly, for the hole size and material hardness,  $q$  can be approximated as close to unity. Accordingly, the adjusted fatigue limit for this design would be approximately 2/3 of the earlier value, or 45 ksi.

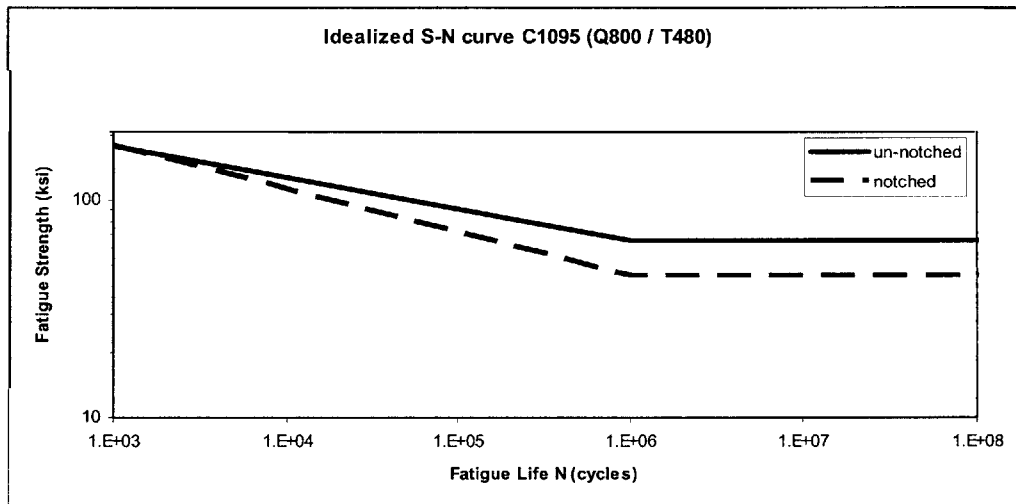

(Figure 4.2: Idealized S-N curve for AISI C1095 steel quenched at 800C and tempered at 480C)

However, it should be noted that this calculation ignores some conditions. For instance, in some designs (such as D02a/b) the mean stress in the flexible member is not equal to zero, which can reduce the fatigue limit of the part. The detrimental effect of a “tensile mean stress upon the fatigue properties is associated with the opening of micro defects due to the tensile loading, with earlier crack initiation, and with a shorter crack propagation life.”<sup>34</sup> However, with the exception of D02a/b, the mean stress should always be near zero, and in the cylindrical design, a reverse buckle—as shown in the ‘external’ mode in figure 3.12—may be employed to lower the mean stress to zero. While

<sup>32</sup> See pp. 70 – 71 of [2]

<sup>33</sup> See p. 347 of [2]

<sup>34</sup> See p. 136 of [2]

significantly large mean stresses can lower the fatigue limit by a factor of two or three, modest mean stresses will only alter the fatigue limit by a small percentage. In addition, the flexible member may be formed with residual stresses to adjust the mean stress.<sup>35</sup> Using the Goodman relation, the maximum alternating stress with a non-zero mean stress ( $\sigma_{dm}$ ) would be reduced by a factor proportional to the mean stress and the ultimate tensile strength [ $\sigma_{dm} = \sigma_d(1 - \sigma_m/S_{rb})$ ]. However, an experimental analysis would need to be performed to determine specific values.

The microstructure of the material also has an important role in fatigue. Some work has shown that as the size of the grain in certain steels increases, the endurance limit goes down. Although this study has not been performed on 1095 steel, the trend of data suggests that the assumption would hold true.<sup>36</sup>

Also, elevated working temperatures can decrease the fatigue strength of the part. High temperatures increase the mobility of atoms, which should facilitate greater slip and deformation prior to fracture. In addition to creep, heating of the part (and subsequent cooling) can introduce changes in the grain structure of the steel.

Finally, the fatigue limit can be improved by certain surface treatments, such as Nitriding or carburizing. As Nitriding will “always build up residual compressive stress...it can be expected to increase the fatigue strength.”<sup>37</sup>

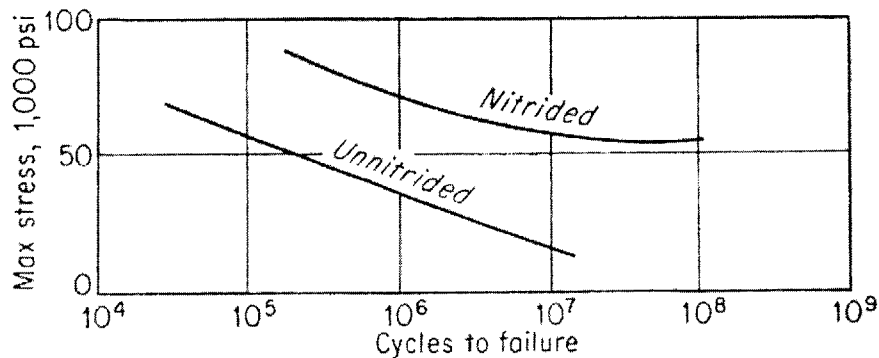

(Figure 4.3<sup>38</sup>: Effect of surface treatment on cyclic fatigue)

In addition, cold-rolling, peening, or similar processes can be used to harden the surface and improve fatigue strength. In one study, on unrolled crankpins “measurable cracks appear at stresses as low as 5,000 psi...[whereas on surface-rolled pins] the cracks are only about one-tenth as deep for the same stress and break at twice the ‘unrolled’ limit.”<sup>39</sup>

With an estimated upper-bound, we can now satisfy FR1.2.2.2, by adjusting certain DPs. The maximum stress in the flexible member occurs at the bend of the

<sup>35</sup> See p. 63 of [4]

<sup>36</sup> See p. 28 of [10]

<sup>37</sup> See p. 32 of [10]

<sup>38</sup> See p. 33 of [10]

<sup>39</sup> See p. 213 of [10]

buckle, and thus, the stress in this region must be below the fatigue limit determined above. Theoretically, the stress in the bend can be calculated as follows:

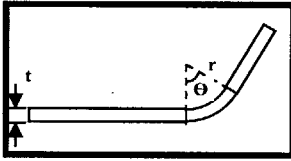
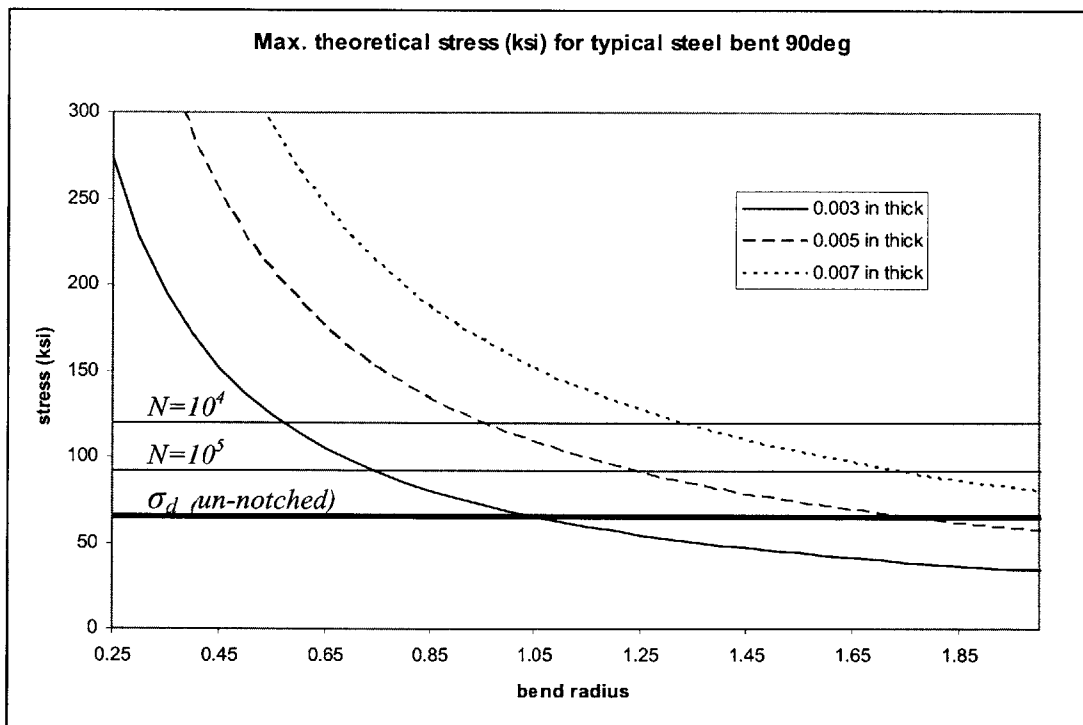

Figure 4.4

;where  $E$  is the modulus of elasticity,  $\theta$  is the bend angle,  $r$  is the radius along the bend where the maximum stress occurs, and  $r_o$  is the radius along the bend where there is minimum strain.

$$\sigma(r) = E * \theta * \left( \frac{r - r_o}{r_o} \right)$$

Using this equation, we can predict the maximum stress in the flexible member as a function of both material and geometric properties. Following is a graph showing the stress in the flexible member when bent 90 degrees (as in D01a).



(Figure 4.5: affect of thickness and bend radius on cyclic fatigue)

Thus, one can see that for the cyclic conditions described earlier, the flexible member should be very thin and have a minimum bend radius on the order of 1 inch. For instance, in a conical system, the lower bends are typically less than 90 degrees, so the bend radius can afford to be smaller, whereas on the upper bend, the radius will be larger.

In a cylindrical system, however, the bend angle will typically be less than 90 degrees, so that a steeper bend can most likely be achieved, although the fatigue limit will likely be different between the conical and cylindrical systems on account of varying mean stresses.

### 4.3. DYNAMICS

Although rotary valves can theoretically function at much higher speeds than other valves, one must consider the dynamics of the valve at higher speeds. This is especially true in a conical geometry, where the buckle tends to be quite compliant (in contrast, a cylindrical system may have a very small buckle—which is often well-constrained on either side). Depending on the mode shape, the resonance may or may not have a significant effect on the valve performance—however, it is more ideal to eliminate any dynamic effects. To perform a thorough analysis, the mode shapes should be determined experimentally. However, a reasonable estimate can be determined using FEA (or analytically, using Raleigh-Ritz, for instance).

First, the existing poppet valve will be considered—where a large mass is reciprocated by rotating an eccentric cam. A simplified analysis of the cam dynamics are provided by Shigley:

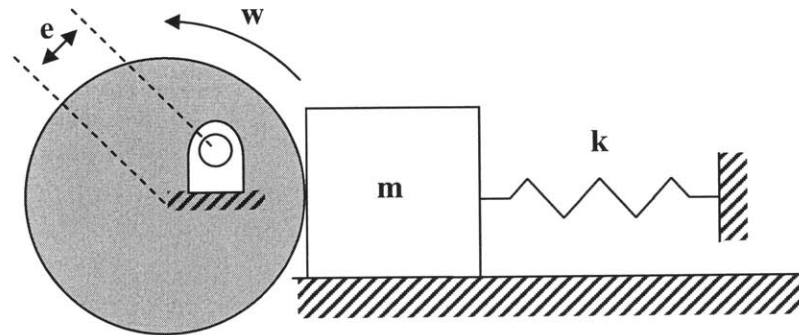

(Figure 4.6<sup>40</sup>: cam analysis)

An analysis will show that:

$$w = \sqrt{\frac{2ke + P}{me}} \quad ; \text{ where } P \text{ is the preload in the spring } (k\delta), \text{ and all other variables are described in figure 4.7}$$

Thus, one can solve that the minimum preload to avoid ‘jump’ (i.e.—no contact between the cam and follower), should be:

$$P > e(mw^2 - 2k) \Rightarrow k\delta > e(mw^2 - 2k) \Rightarrow k > \frac{emw^2}{\delta + 2e}$$

In the Honda Marine Engine used to prototype the Ecogin,  $e$  is approximately equal to 0.0017m and  $m$  is approximately 22.3 grams. Thus, the following graph

<sup>40</sup> See p. 521 of [9]



describes the relationship between the initial spring compression and the spring stiffness required:

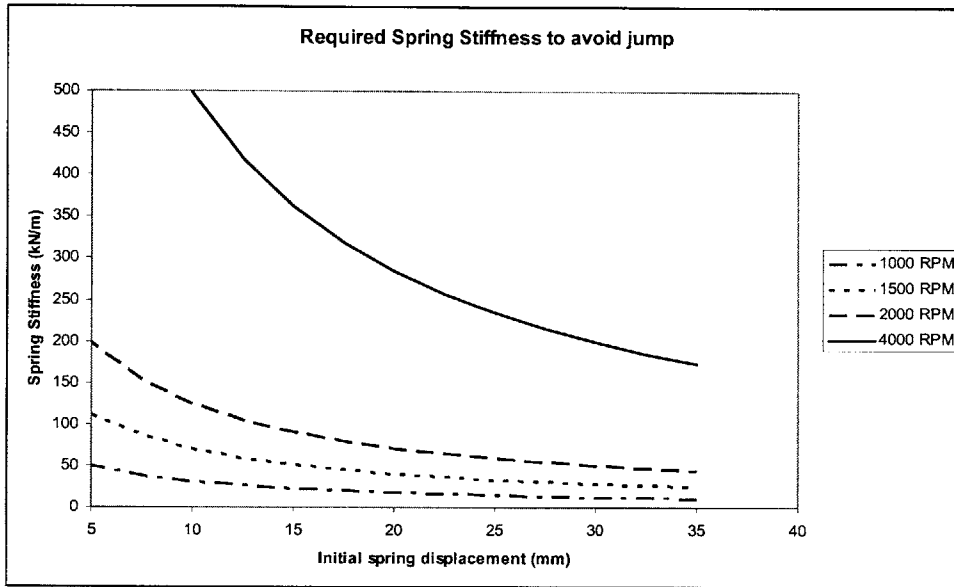

(Figure 4.7: required spring stiffness to avoid jump in a simplified camshaft/poppet valve model)

As described in the Ecogin final report, the spring stiffness for the intake valve of the mixing cylinder was 16.76 kN/m with a compression height of 14mm, and the stiffness for the exhaust valve in the same cylinder was 30.1 kN/m with a compression height of 17.5mm<sup>41</sup>. Thus, from our analysis, it would appear that the spring stiffness selected was below the target range for operating at high rpm's. Moreover, the initial normal force on the exhaust valve will be over 500N—suggesting that the net work required to actuate the valve will be extremely high (which was one of the reasons for researching rotary valves as an alternative).

Now considering the rotary valve, an FEA analysis was conducted where a thin sheet of the flexible member was placed flat and constrained on the two sides. The constraints placed on the ends allowed zero degrees of freedom—which is a reasonable assumption for a cylindrical valve. A number of slight model variations were performed—including varying mesh size and geometry. Below are illustrations and averaged modes from these studies.

<sup>41</sup> See p. 33 of [3]

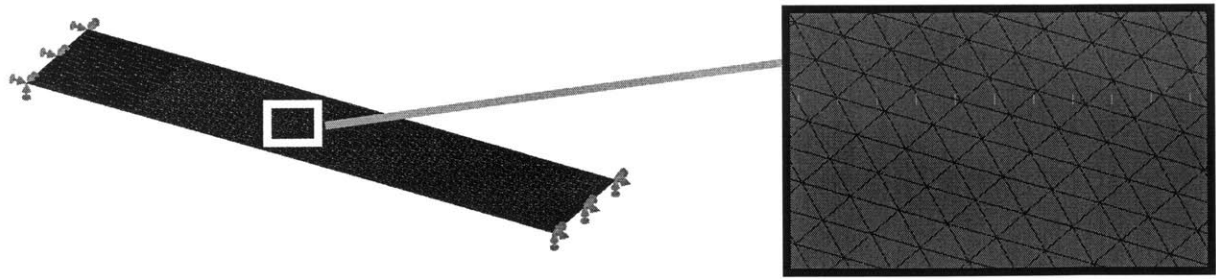

Restraints and Mesh

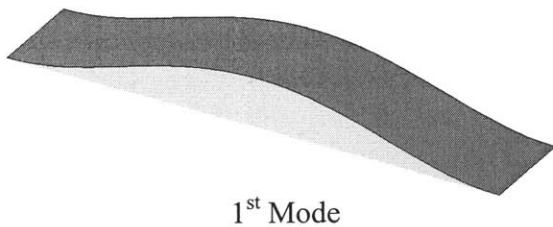

Mode Number	Frequency in Hertz (RPM)	
	For L=1in	For L=5in
1	1,075 (64,200)	42 (2,520)
2	1,420 (85,200)	115 (6,900)
3	2,940 (176,400)	205 (12,300)
4	2,960 (177,600)	335 (20,100)
5	3,470 (208,200)	490 (29,400)

(Figure 4.8: dynamic analysis w/ FEA)

To determine a more approximate resonant frequency for the buckle in the conical valve, one can scale the frequencies from the first analysis by the square root of the stiffness of the buckled portion (assuming similar masses). As can be expected, the stiffness of the buckle varies, but has been experimentally determined as on the order of 5,000 N/m (depending of course, on thickness, size, material and other parameters). The stiffness, however, of the flexible member in the FEA model was on the order of  $20.3 \times 10^6$  N/m. Scaling the natural frequencies from the FEA model to the more realistic scenario reveals a first mode near 1000 rpm, assuming a relatively small buckle (i.e.—1 in)—a mode which is too low for an automotive application—but is sufficiently high for many other valve uses. The cylindrical valve would have a stiffness closer to the FEA model.

Nonetheless, solutions may be developed to raise the natural frequency of the valve. Perhaps one of the most attractive solutions is to use a guide to control the profile of the buckle. This device would increase the stiffness of the buckled portion and thus raise the mode frequencies. The limitations on this profile guide would most likely be geometric (i.e.—the device cannot interfere with other components) but might also be thermal or mechanical (i.e.—

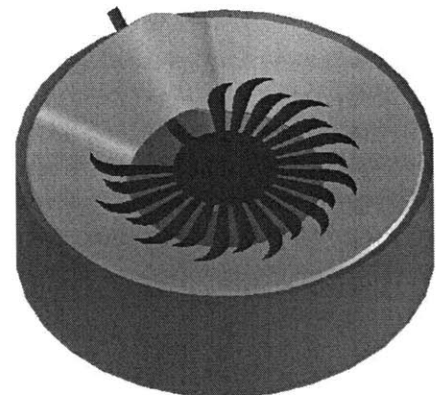

(Figure 4.9: a rotary valve w/ profile guide)

stress). Nonetheless, under most conditions, a suitable component could be developed. *Figure 4.6* is a sketch of one such device—where the rotor has a small pin pushing the buckle upward—and thus constraining the profile.

## 4.4. POWER

One can approximate the power required to run a rotary valve and relate it with that required in a typical poppet valve. There are a number of force that must be overcome to drive the rotary valve—as such, only the significant ones will be considered. As shown in *figure 4.9*, the main resistive forces include the inertia of the flexible member (which must reciprocate up-and-down), the air drag acting on the buckle in the flexible member, the friction between the rotor and flexible member and, in some designs, the force required to ‘lift’ the flexible member off of the port. Following, we will consider each of the forces and approximate the power required to overcome each one.

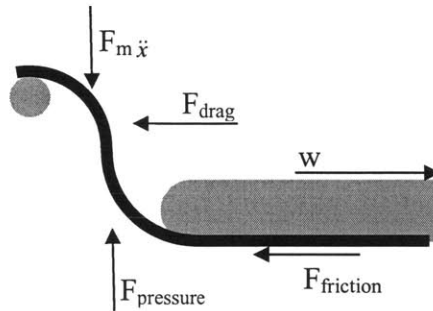

(*Figure 4.10: rotary valve free-body diagram*)

### 4.4.1. Inertial Power

To determine the inertial force of the flexible member, one must first predict the required vertical acceleration (the horizontal acceleration of the flexible member is minimal). Let us assume that the rotary valve is actuated at 4,000 rpm (i.e.—66 rot/sec) and that the discontinuity in the rotor is approximately 60 degrees, then an element of the flexible member will enter the buckle for approximately 0.002 seconds. In a reasonably-sized valve, the flexible member should not raise much higher than a couple centimeters—in our case, we will assume a vertical displacement of 2 cm. We will also assume that the profile of the buckle can be approximated with a sinusoidal wave (as shown in *figure 4.10*)

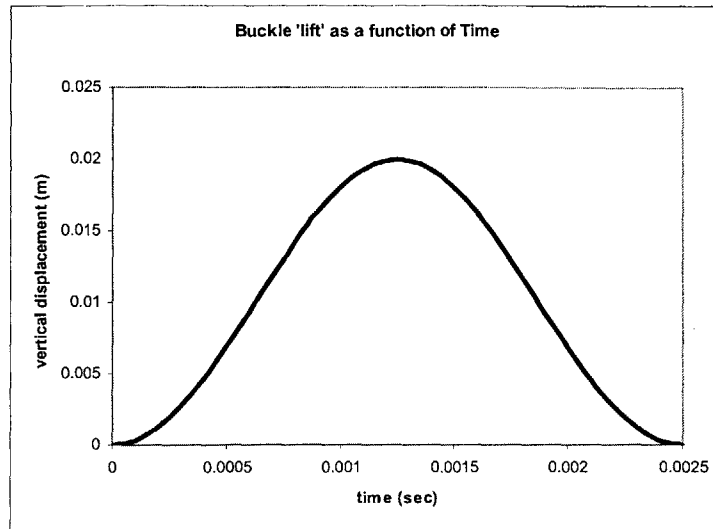

(Figure 4.11: height of flexible member during buckle as a function of time)

The required velocities and accelerations can be determined by taking the first and second derivatives (respectively) of the position function. The maximum acceleration occurs at the ‘humps’ of the sinusoidal wave and can be approximated as  $60,000 \text{ m/s}^2$ —an overly-conservative estimate. Multiplying this by  $0.0008 \text{ kg}$  (a conservative estimate of the total shimstock mass), one can assume a required force on the order of  $48\text{N}$  / rotation. The energy used to lift a portion of the flexible member is approximately  $48\text{N} * 0.02\text{m}$ , or  $0.96 \text{ Joules}$  / rotation. The power involved in actuation of the flexible member buckle is thus approximately  $0.96 \text{ J/rot} * 66 \text{ rot/sec} = 65 \text{ Watts}$ .

The above value should then be multiplied by the number of required valves—in our case we will choose four valves (2 per cylinder). Thus, the total power required in actuation the valve buckles should be on the order of  $260 \text{ Watts}$ . This value may be higher in larger valves, but can also be reduced by modifying the buckle profile.

#### 4.4.2. Drag Power

The drag force will mostly only affect the buckled portion of the flexible member, as other faces of the valve will be reasonably flat. In a rather conservative estimate, one may assume that the geometry of the buckle will have a drag coefficient of approximately  $0.5^{42}$ . In addition, as in section 4.4.1, we will assume that the valve will be actuated at  $4,000 \text{ rpm}$ —meaning the buckle will be traveling on the order of  $10 \text{ m/s}$ . In addition, we will assume that the density of fluid will be approximately  $1 \text{ kg/m}^3$  and that the buckle frontal area is approximately  $0.00075 \text{ m}^2$ . Thus, as follows:

$$F_{drag} = \frac{1}{2} c_d \rho A v^2 = (0.5)(0.75) \left( 1 \frac{\text{kg}}{\text{m}^3} \right) (0.00075 \text{m}^2) \left( 100 \frac{\text{m}}{\text{s}} \right)^2 = 2.8 \text{N}$$

<sup>42</sup> See p. 460 of [13]

The energy used will thus be approximately  $2.8\text{N} * 0.2 \text{ m/rotation} = 0.56 \text{ J}$ ; and the power will be  $0.56 \text{ J} * 66 \text{ rot/sec} = 35 \text{ Watts}$ .

Again, the above value should be multiplied by four, illustrating that the total 'drag' power will be approximately 140 Watts. This value can be reduced significantly by placing an aerodynamic element before the buckle to reduce the drag coefficient.

#### ***4.4.3. Pressure Power***

In a 'self-help' geometry, the pressure differential will provide a significant force which must be overcome to open the exhaust valve. This pressure differential, however, only exists for a short time—for once the valve opens, the force acting on the flexible member reduces significantly as the pressure differential equalizes and the flexible member is translated to a region with a less significant pressure gradient. In a typical 4-stroke engine, the valve should not have to open against a pressure differential much higher than 5 bar—if it is, then significant work is being lost in the engine cycle. Assuming that the port area is approximately  $1\text{in}^2$ , the total force acting against the flexible member will be approximately 300 N. This force, however, will only be present for a relatively short time period (using data from the Ecogin tests, the differential disappears in less than a quarter of the total valve opening time). Thus, one may estimate that an average force of 150N will be acting against the flexible member for approximately the first half of the 'valve-lift', or approximately 1 cm. Thus, the energy required will be approximately  $150\text{N} * 0.01\text{m} = 1.5 \text{ Joules}$ ; and the power will be  $1.5 \text{ Joules/rot} * 66 \text{ rot/sec} = 100 \text{ Watts}$ . This seems to be a very conservative estimate.

The above power should be doubled to account for the two cylinders, meaning that the total power to overcome the pressure differential will be on the order of 200 Watts. It should also be noted, though, that the energy required to close the valve will be lower than that estimated in 4.4.1, because the pressure differential will help to seal the port (and thus minimize the forces that must be applied to overcome the inertia of the flexible member).

#### ***4.4.4. Frictional Power***

The frictional force in this valve can be significantly reduced because a low-friction interface can easily be developed. As calculated in section 4.4.1, the maximum force applied to the flexible member at any given moment will be on the order of 10N. The coefficient of friction can easily be dropped to a level on the order of 0.1, by using the techniques described earlier. Thus, the total frictional force will be approximately  $10\text{N} * 0.1 = 1 \text{ N}$ . The energy required to overcome this friction will be  $1 \text{ N} * 0.2\text{m} = 0.2 \text{ Joules/rotation}$ . The power required to drive the system will be  $0.2 \text{ J/rot} * 66 \text{ rot/sec} = 13 \text{ Watts}$ .

Multiplying this value by the four valves being used, an approximate frictional load will be on the order of 50 Watts. This value may be lowered by utilizing superior materials or

a rolling interface between the rotor and flexible member; similarly, it may be raised if cost or other conditions prohibit reaching a lower frictional coefficient.

#### 4.4.5. Total Power

Summing together the above elements, the total power required to actuate the valves for 2 cylinders (i.e.—4 valves), will be:

$$P_{total} = P_{inertia} + P_{drag} + P_{pressure} + P_{friction}$$

$$P_{total} = 260W + 140W + 200W + 50W = 650W$$

It should be noted again, however, that the above calculations were conservative, and that the realized power should be significantly lower. Nonetheless, this value is significantly lower than other valve-trains, which typically account for 15-20% of the frictional loss in an engine. The Ecogin engine was not run above 2000 rpm—but motoring tests reveal that at 1,000rpm, the base friction “from valve train and pistons, etc.” was 2.93 Nm<sup>43</sup>. Unfortunately, the friction does not scale linearly with speed (at higher speeds one must deal with the dynamics of the valve, the friction may enter a different regime, etc.). As such, a repetition of the above analysis will be performed at 1,000 rpm:

- Inertial Power:
  - Max. Accel: 4,000 m/s<sup>2</sup>
  - Power = 4\*M\*a\*I\*RPS = 4\*(0.0008 kg)(4,000 m/s<sup>2</sup>)(0.02 m)(17 rev/sec)
  - Power = 5 W
- Drag Power:
  - $F_{drag} = \frac{1}{2} c_d \rho A v^2 = (0.5)(0.75) \left( 1 \frac{kg}{m^3} \right) (0.00075 m^2) \left( 25 \frac{m}{s} \right)^2 = 0.17 N$
  - Power = 4\*F\*I\*RPS = 4\*(0.17 N)(0.2 m)(17 rev/sec)
  - Power = 2.5 W
- Pressure Power:
  - Power is ¼ as that calculated earlier
  - Power = 50 W
- Frictional Power:
  - Power = 4\*F\*I\*RPS = 4\*(3 N)(0.2 m)(16 RPS) = 40 W
- Total Power:
  - Power = 5W + 2.5W + 50W + 40W = 100W

Thus, at 1,000 RPM, the estimated power required to run the valve will be approximately 100 W—which is significantly less than the 300 Watts used to actuate the current valve system. At higher RPMs, the difference will become even more evident, as a significantly stiffer spring will be required in the poppet valve (as shown in section 4.3). Thus, although the rotary valve already shows significant promise in reducing energy loss to approximately 1/3, this efficiency will most likely improve at higher speeds.

<sup>43</sup> See p. 26 of [3]

## 4.5. FORCES

As noted in the decompositions above, one area of minor coupling occurs because a solution must be reached where the flexible member must be stiff enough such that it does not deform enough to create a gap between the port/housing and flexible member; however, it must be compliant enough to avoid cyclic fatigue. However, while a coupling does exist, there is no reason that a viable solution cannot be reached which can satisfy both FRs. The flexible member must be stiff enough to not bend significantly, but compliant enough to avoid cyclic fatigue—thus, upper and lower bounds can be determined—and, as long as they do not overlap, a viable solution can be developed.

Because of the different geometries, actuators and other DPs, a unique analysis must be performed for each design. In a simple linear ‘self-help’ system, the design might look as follows:



(Figure 4.12: flexible member bending)

Thus, a relatively simple model can be developed based on uniform loading of a beam. According to the above model, the bound would be that the flexible member must be stiff enough such that the edges of the member do not get ‘sucked’ into the port. However, the main difficulty, which is not accounted for in this analysis, are the corners of the port. If the member gets ‘sucked’ into the port, then at these ‘edges’, a mild buckling will occur. This buckling will clearly sacrifice the sealing ability of the port.

Thus, a number of potential solutions can be studied. Initially, one should determine how much bending is allowable. Any plate with a finite thickness will bend in such a condition, however, a ¼ in steel plate will most likely bend so little that the sealing will not be affected. An FEA analysis may be performed; however an experimental study should also be conducted and may be a far simpler approach. Once an appropriate bound has been created, one may choose between varying a number of DPs—depending on the individual design.

First off, this specific issue is moot in a ‘reverse-pressure’ geometry—while sealing is also difficult in such a design as the flexible member will not be ‘sucked’ into the port, but instead pressed into the rotor. In the ‘self-help’ geometry, on the other hand, several parameters may be used to control the degree of bending. These parameters include material, geometric and other variables—the main ones being shown below:

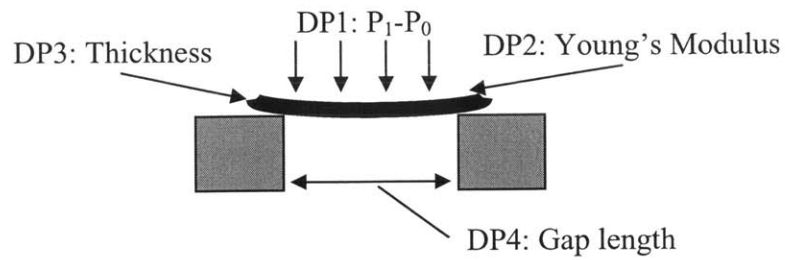

(Figure 4.13)

Depending on the design, the actuator may also affect the bending. In some cases, it may help reduce the bending by maintaining the flexible member and housing coincident. However, in other cases, it may in fact help to pull the flexible member further into the port.



## 5. EXPERIMENTAL (SEALING)

### 5.1. INTRODUCTION AND SETUP

Due to time and budget constraints, only a limited experimental test was conducted. The test involved measuring the rate-of-leakage on a valve of the form D01a, as described earlier. The rotary valve used, hereafter called D01a, was a simplified model of the design created earlier. The flexible member in was a 0.004 in thick sheet of hardened spring steel (AISI c1095) purchased from McMaster. The flexible member was cut on a water jet machine and the edges were filed down. The rotor used was made of 0.015 in thick steel plate, which was also water jet. The housing was turned on a lathe at the LMP and the ports were milled/drilled. Some effort was made to create a smooth surface finish on the housing by polishing the housing surface with sandpaper and 5micron diameter SiO<sub>2</sub> abrasive—but was not very effective. As will be described later, in some tests, a small rubber gasket was used—the neoprene rubber used was cut by hand or using a hand punch. Unfortunately, due to budget constraints, the valve was not manufactured as well as it should have been—and was of lower quality than an ultimate product would be. For instance, a raised valve seat was not created, because the extra effort was not deemed necessary, and would have minimal effect on the sealing test. Also, the ideal surface finish could not be made because of the available tools. As will be shown later, this relatively poor surface finish was clearly out of the specified design range. In addition, materials used were selected for ease of availability and manufacturability (i.e.—the housing was made from aluminum—rather than steel, the flexible member did not contain a coating, etc.).

Two forms of D01a were tested to study the effect described in section 4.5. It was predicted that a smaller port size would improve valve sealing by minimizing the deflection of the flexible member. In the first form, a large, roughly rectangular port with an area of 0.48 in<sup>2</sup> was used. When a gasket was used, the area of the gasket was approximately equal to that of the port. The second contained several smaller holes, with a total area of 0.3133 in<sup>2</sup>. The area of the holes in the gasket summed to approximately 0.3 in<sup>2</sup>. A testing apparatus, as shown in *figure 5.1*, was created to study the valve leakage rate:

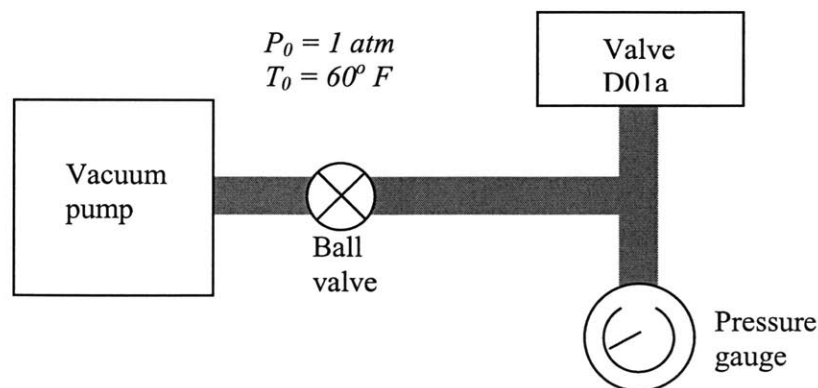

(Figure 5.1)



Initially, the rotary valve was sealed, the ball valve opened, and the vacuum pump turned on. Once the desired vacuum was reached (as shown by the pressure gauge), the ball valve was sealed and the vacuum pump turned off. Time was recorded as the pressure rose in the 'chamber'. The volume of the chamber (i.e.—tubing, pressure gauge and D01a) was determined to be approximately 18 mL.

To calibrate the system, D01a was sealed completely and the leakage in the chamber was measured. This error, which was due to leaks in the piping and the quick-disconnect fitting between D01a and the chamber, was then subtracted from the subsequent experimental results. The pressure loss was calibrated before beginning a significant test series.

Once the pressure loss as a function of time was determined, the data was converted to an approximate volumetric flow rate of leakage at a number of pressure points. For instance, if it took 5 seconds for the vacuum pressure to raise from 0.5 in Hg to 1.0 in Hg, then the total mass flow rate through the port over this period would be approximately  $7.3 \text{ E-}09 \text{ kg/sec}$  (as calculated using the ideal gas law—assuming a temperature of  $60^\circ\text{F}$ ). Thus, one can approximate that this would be the mass flow rate at 0.75 in Hg. Again, using the Ideal Gas law, the mass flow rate was easily converted to a volumetric flow-rate, which can be scaled up to higher pressures (i.e.—the volumetric flow rate should be approximately equal at equal pressure-differentials, even if the base pressures are different).

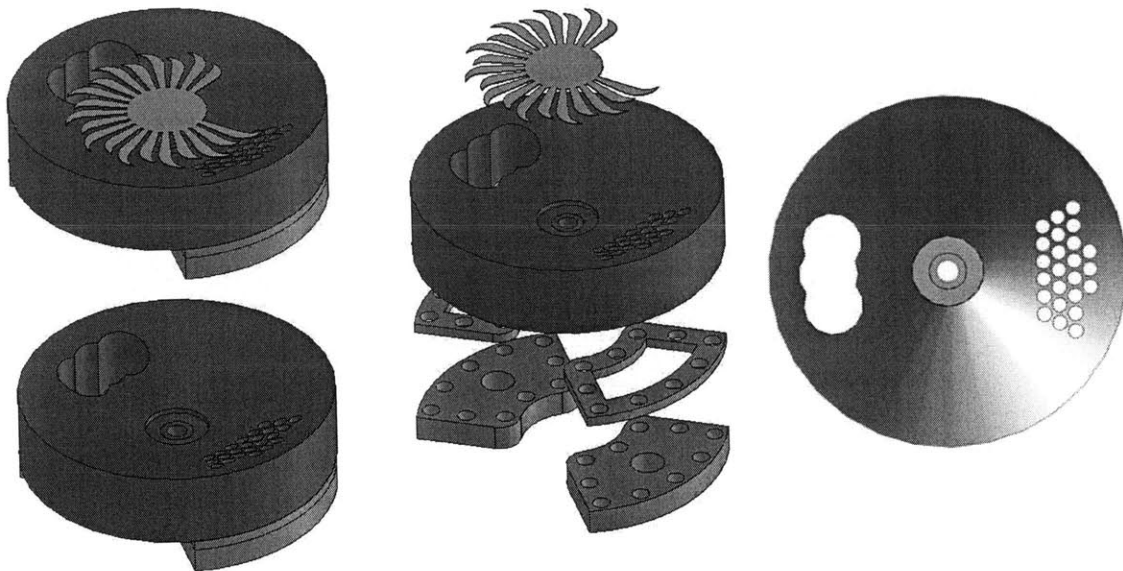

*(Figure 5.2: different views of solid models of test valve)*

## 5.2. RESULTS

### 5.2.1. Large Port

In the first form, three test-types were conducted, as described in *figure 5.3*. Test A involved using the rotary valve as it was initially designed. Under such a configuration, the valve should work under a number of different temperatures (i.e.—all materials are metal, and capable of high temperature use). In test B, a rubber gasket was used to create a superior housing surface finish. No rotor was used—and the force maintaining the seal of the valve was based solely on the pressure differential. In test C, both a rubber gasket and the rotor were used. Each test was performed several times and the results averaged. Then, a linear, best-fit line was used to determine a rough estimate of the leakage rate as a function of pressure differential. The main use of such an equation was to compare the leakage between different test conditions. Following is a graphical representation summarizing the results of the experimental data collected.

Test #	A	B	C
Gasket used?	N	Y	Y
Rotor used?	Y	N	Y

(Figure 5.3)

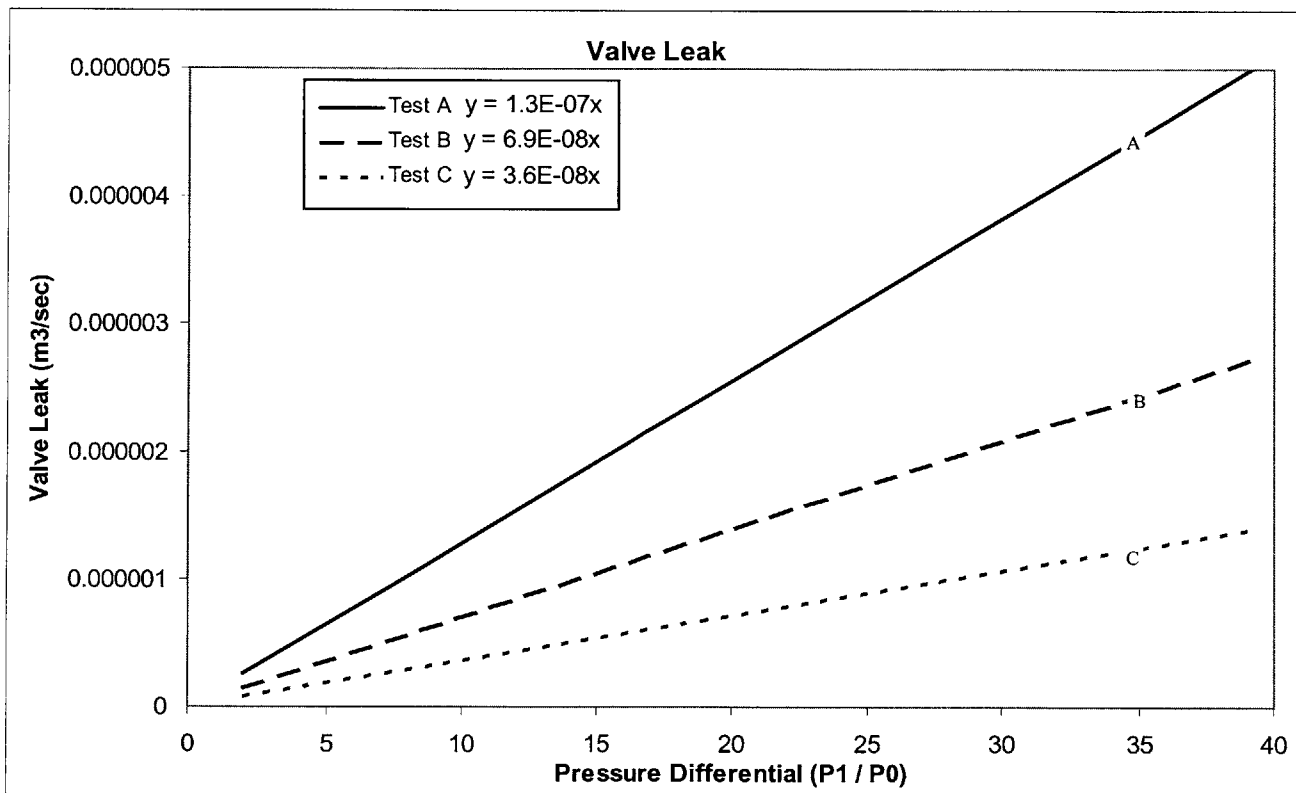

(Figure 5.4: valve leak for a large port)

### 5.2.2. Meshed Port

In the second form, the same tests were performed as above. Here, however, in tests A and C2, a broader force was applied over the flexible member (whereas in test C1, a single rotor was used). This was used to study the effect of rotor design on sealing (i.e.—how important is it that the rotor distribute the load over the entire flexible member, as opposed to one or two circumferences). Following is a graphical representation summarizing the results of the experimental data collected.

Test #	A	B	C1	C2
Gasket used?	N	Y	Y	Y
Rotor used?	Y(5)	N	Y(1)	Y(5)

(Figure 5.5)

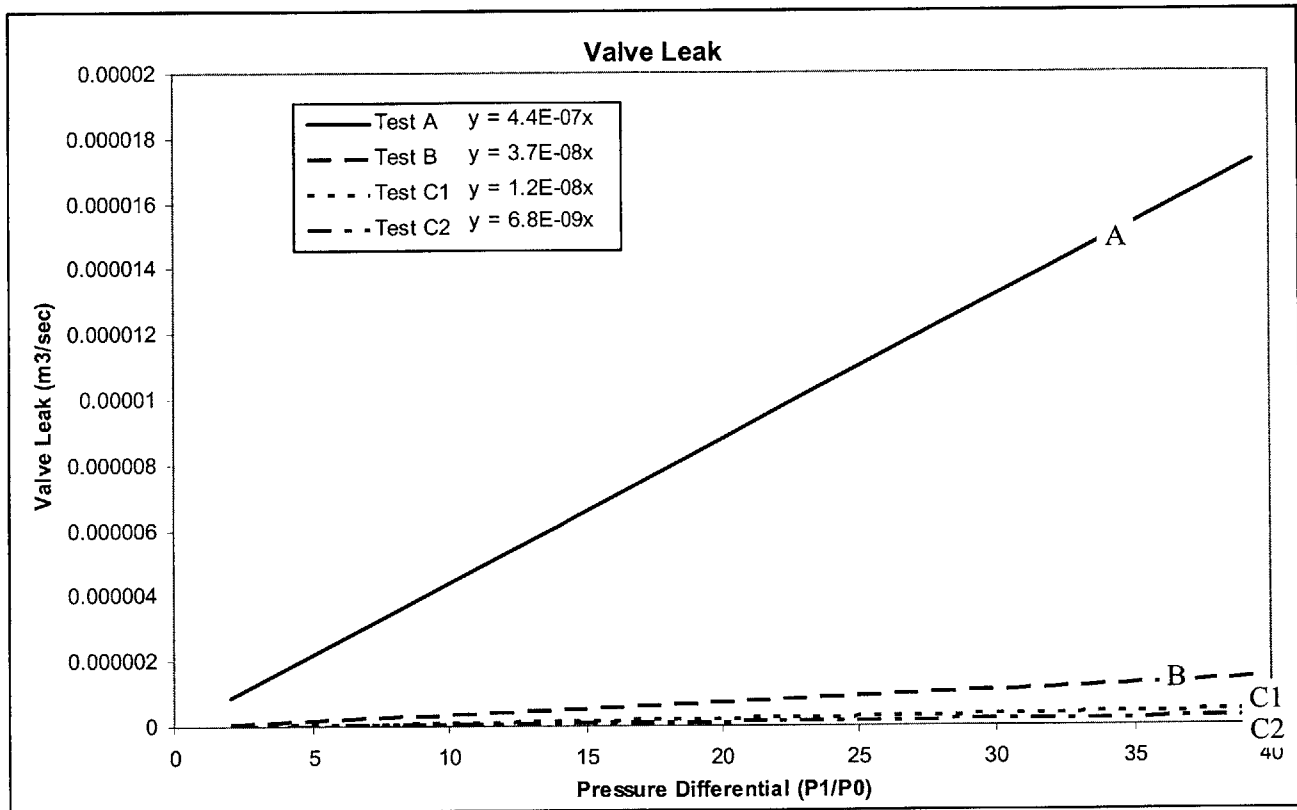

(Figure 5.6: valve leak for a meshed port)

### 5.3. SUMMARY

As shown in section 5.2, the rotary valves tested showed signs of leakage. As expected, in all cases, the highest leak rate occurred with a metal-on-metal contact. A metal-on-metal system is very stiff, and requires precision manufacturing techniques—which are often expensive and difficult to achieve (especially with our resources used). A ‘smoother’ surface finish was achieved by introducing a thin rubber gasket between the two metal surfaces. In doing so, the gasket conformed to the sealing faces and thus minimized both the number of gaps and the overall gap size. Thus, the gasket ensured

that the surface finish was within the appropriate design range. Using a gasket, the sealing improved significantly. As described in the decomposition of D01a, the purpose of the rotor was not to directly seal the valve. Instead, the rotor was supposed to initially press on the flexible member—until a significant pressure differential was reached, which would then press the flexible member against the port (and thus seal the valve). However, the tests showed that the rotor does have a more direct effect on the sealing of valve. The rotor plays an important role in sealing by constraining (or attempting to constrain) the flexible member on the housing. As described earlier, under large pressure differentials, the flexible member deflects into the port—and in doing so, ‘wrinkles’ are formed in the flexible member through which fluid can flow. The rotor helps to minimize this deflection by constraining certain points of the flexible member. This effect can be seen when considering tests C1 and C2. C2 shows significantly better sealing than C1, the only difference being the resolution of the rotor.

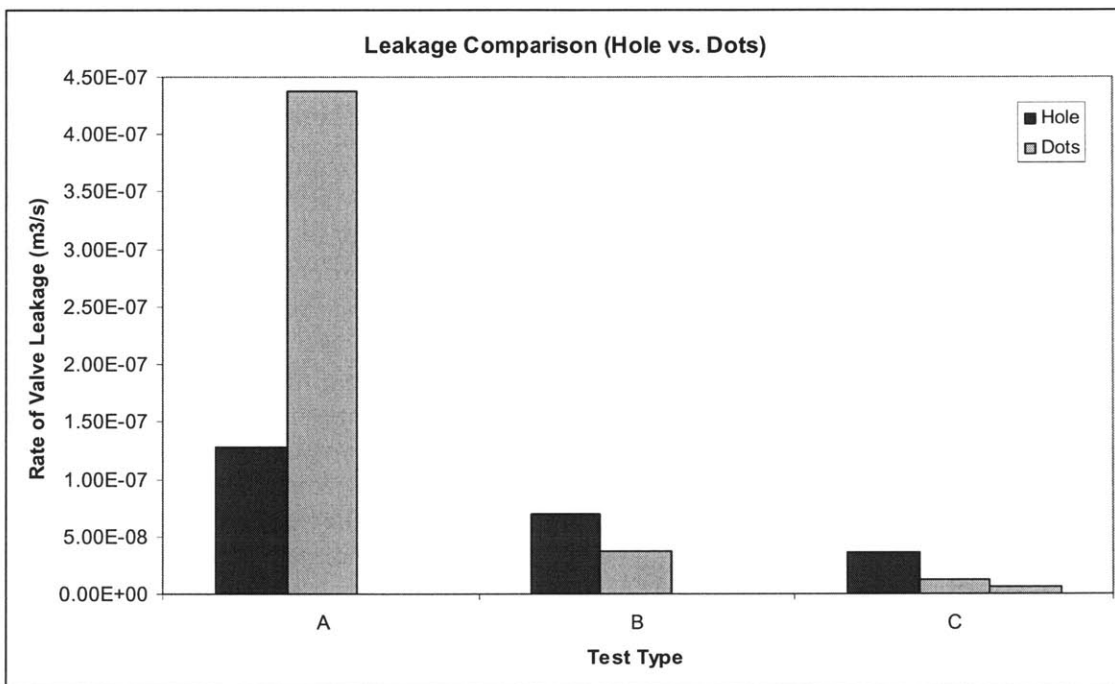

(Figure 5.7: valve leak comparison for meshed and unmeshed ports)

Interestingly, as shown in figure 5.7, a ‘meshed’ port provided poorer metal-on-metal sealing, but superior sealing when used with a rubber gasket. This implies that with ideal surface finishes, the meshed port would be superior; however, it is more difficult to achieve an appropriate surface finish with a meshed surface. The poor surface finish is most likely a result of the manufacturing process. When polishing a part with a hole on a lathe—it is difficult to ensure a smooth surface finish on the area immediately following the hole. Thus, a meshed surface can be more difficult to polish than one using a single large port. However, the most significant cause of the high leak rate is the large net circumference of the meshed port. Whereas the single port valve has a port-circumference of approximately 2.75 in, the overall port-circumference of the meshed valve is 9.6 in. With all other parameters equal, a valve with a higher circumference-to-area ratio will perform worse. This is for a number of reasons, including: a lower

distributed force pressing the flexible member against the valve seat and a higher probability of a gap existing between the flexible member and valve seat.

However, once the surface finish was improved (by using a rubber gasket), the valve with the mesh performed significantly better. Although a number of parameters affect this result—the most significant is the smaller net-deflection of the flexible member. In doing so, there was less ‘wrinkling’ of the flexible member and thus fewer and smaller gaps between the housing and flexible member.

A more in-depth study must be conducted, but it appears that according to the FCI-70-2-2003 valve standard, this valve (as it stands now) falls under a Class IV rating—which requires that the maximum seat leakage be no more than 0.01% of the rated valve capacity. In fact, it appears that the only condition which fails this criteria (and instead goes under Class III) is Test A with the meshed port. It should be noted, however, that this test was conducted with a significant pressure differential (even with a relatively low  $\Delta P$ ,  $P_1/P_0$  was relatively high). As such, the leakage class may be lower than that calculated. Nonetheless, this valve shows significant promise in that even with a relatively simple and low-cost construction, the valve performed reasonably well.

Lastly, as this valve was originally designed for an automotive application, the effect on engine performance of valve leakage should be briefly discussed. Because engines run at such high speeds, valve tightness is not nearly as critical as it is under other applications. For instance, the valve tested here should provide minimal power loss when compared with other power losses, such as friction or heat transfer. Considering the Ecogin engine, with a cylinder size of 110cc (i.e.— $0.00011 \text{ m}^3$ ) and running at 2,000 rpm—even with a constant valve leakage of  $2 \text{ E-}6 \text{ m}^3/\text{sec}$  (see *figure 5.4*), the volume loss in the compression and power strokes would be less than  $6 \text{ E-}8 \text{ m}^3$ , or less than 0.06% of the total cylinder volume. This, of course, is a very simplified analysis—ignoring the truly complicated nature of an engine, but it is conservative. Even if the power loss associated to valve leakage was significantly higher—the gains from lower power loss in actuating the valve would most definitely overcome the leakage loss.

## 6. CONCLUSION

I have presented here my work in the development of a novel valve design, including an analysis of the existing problem, development of a potential solution, and analysis validating the design. However, the valve is far from being used in a real application. Although it has been shown to seal adequately well, it must be tested under additional conditions and for additional issues, such as friction, wear and fatigue—to name a few. Also, while a modest attempt was made at considering the manufacturing of the valve—a more thorough study should be conducted.

Although the rotary valve was originally designed for an automotive application, the valve may be better suited to other applications. One advantage with designing a valve for an automotive setting is that the conditions are typically more extreme than in other, more ‘mainstream’ applications (i.e.—the temperature is hotter, pressures higher, and speeds faster). Thus, if a valve can withstand the harsh engine conditions, it is likely to work well in milder environments. Because the design is unique, it poses several advantages over other valves. Some have been described earlier, such as the ability to develop the valve at low-cost and its ability to provide high sealing with low energy loss. Others were not discussed. For instance, one potential benefit that this design may have in cryogenic applications is its low mass—“valves that are lightweight in construction are better suited to cryogenic use since the valve mass which must be cooled down from ambient to cryogenic temperatures on start-up is much reduced.”<sup>44</sup>. Perhaps the main advantage with this valve is the low-cost of manufacturing, which may enable mass-production of a light-weight valve using standard materials. Others have suggested the valve being used to aid in the mixing of fluids.

Perhaps one of the most significant advantages with the rotary valve design is that the design is so simple. Although the design requires significant analysis before it can be used—the basic concept is relatively basic and flexible—such that it can be modified, adapted or combined with any number of other technologies. The WaveFlex system can be used in several geometries (conical, disk, etc.), be actuated by a number of forces (mechanical, magnetic,...), be rotary or reciprocating, and so on. The valve can be used in conjunction with a floating valve seat, a variable valve timing system, and other technologies which have been developed. Indeed, this paper is more of a presentation of a novel technology than a thorough study of a product. It is my hope that this thesis not be an analysis of a mechanism, but instead an introduction to a concept which can be further developed in industry. The designs presented here each have their own merits, but commercial designs will likely differ. Perhaps the valve will be similar to D01a, only it will use bearings on the rotor (to eliminate *all* sliding) and perhaps a rubber flexible member. The possibilities are almost endless.

In addition, it is important to mention the process of designing the rotary valve and how that impacted the results. Rotary valves have been used for millennia, and the modern rotary valve has been used in engines over the last century. Nonetheless, problems have always existed with the rotary valve—after all, nothing is perfect. However, by using AD, I was able to isolate two specific problems with existing rotary

---

<sup>44</sup> See p. 768 of [6]

valves and develop a solution to these. Indeed, AD provided a relatively easy entrance into an established field which I knew little about.

The valve is currently under the direction of the MIT TLO. I may manufacture further devices, but they will be minimal and more likely to be for visual demonstration purposes than for experiments. Future steps will most likely be a combination of analysis and business—attempting to further develop the valve and prove its worth. Basic studies have shown that it does contain some intrinsic value, and benchmarking studies have shown that there is a potential market for such a device, but the hurdles are high and many. This is especially true in the automotive industry, where advancements are typically modest and research is often focused on minor improvements (such as 0.1% higher efficiencies) or on major advancements (such as fuel cells). However, the valve industry as a whole is large enough and the barriers to entry low enough that the market is more favorable to new entrants.



## 7. APPENDIX

### 7.1. PRESSURE TESTS—RAW DATA

Below is a portion of the raw data from the pressure tests conducted with the valve (with the mesh). The first three columns represent a full sealing test to determine the leakage in the system (for calibration). The next two columns test the valve with a gasket, but with no rotor (just to determine the need for a rotor—clearly the valve would need to be run with some form of rotor to actuate the system). The last two columns run the valve as it was intended—with a gasket and a rotor.

Hole or Dots		Dots	Dots	Dots	Dots	Dots	Dots	Dots	Dots
Gasket?		No	No	No	Rubber	Rubber	Rubber	Rubber	Rubber
Cover?		Rubber	Rubber	Rubber	0.004	0.004	0.004	0.004	0.004
Press?		No	No	No	No	No	No	1R	1R
In Hg.	Atm	Time (s)	Time	Time	Time	Time	Time	Time	Time
-29.5	1 / 59.1								
-29	1 / 29.5								
-28.5	1 / 19.7	0	0	0	0	0	0	0	0
-28	1 / 14.8	11	10	12	21	8	9	32	24
-27.5	1 / 11.8	20	18	22	32	16	14	61	51
-27	1 / 9.8	31	27	32	45	24	19	96	77
-26.5	1 / 8.4	39	34	41	55	30	24	126	97
-26	1 / 7.4	48	42	50	65	37	29	152	117
-25.5	1 / 6.6	57	49	59	77	43	35	177	138
-25	1 / 5.9	68	57	67	88	49	40	210	160
-24.5	1 / 5.4	78	67	79	100	57	47	238	182
-24	1 / 4.9	88	77	89	113	64	53	270	203
-23.5	1 / 4.5	100	85	99	125	72	60	301	225
-23	1 / 4.2	109	93	110	134	78	66	330	250
-22.5	1 / 3.9	120	101	120	144	85	70	355	272
-22	1 / 3.7	130	111	131	157	92	77	382	296
-21.5	1 / 3.5	141	120	142	168	98	82	413	316
-21	1 / 3.3	150	128	152	178	105	88	440	339
-20.5	1 / 3.1	163	139	163	187	112	96	475	366
-20	1 / 3	175	149	175	197	119	102	506	392
-19.5	1 / 2.8	188	158	187	206	126	108	532	416
-19	1 / 2.7	198	168	199	216	132	115	566	440
-18.5	1 / 2.6	209	177	211	224	139	121	600	465
-18	1 / 2.5	221	187	223	233	145	127	633	488
-17.5	1 / 2.4	235	198	235	239	151	134	663	515
-17	1 / 2.3	245	208	248	244	156	141	691	538
-16.5	1 / 2.2	257	218	261	250	162	147	722	558
-16	1 / 2.1	269	228	273	255	167	154	749	579
-15.5	1 / 2	278	237	284	259	172	160	775	599
-15	1 / 2	290	247	298	263	177	168	808	623

## 7.2. IMAGES

Below are some images of different valve embodiments.

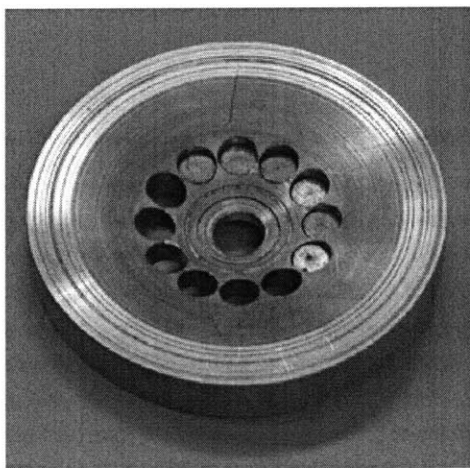
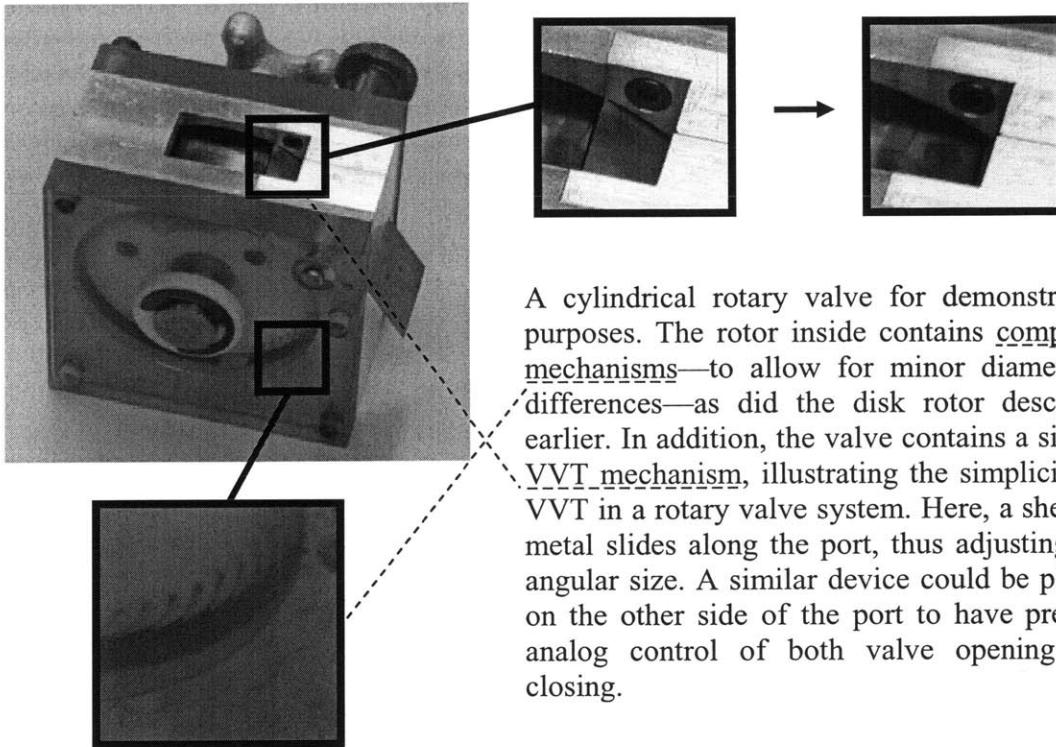

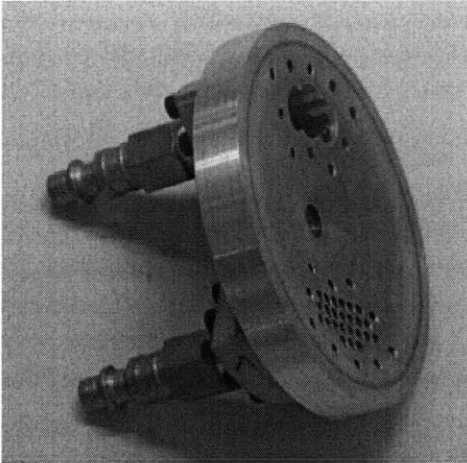

This valve was used for the experimental tests conducted. The rubber gasket is not shown here.

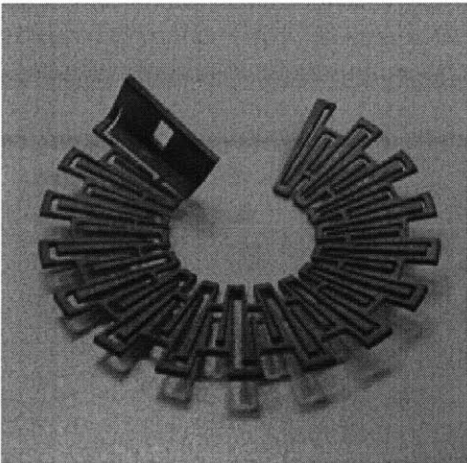

Shown here is a portion of the pressure plate used in D01b. It was waterjet, then bent. The disk—which this piece is hinged too, is not shown.

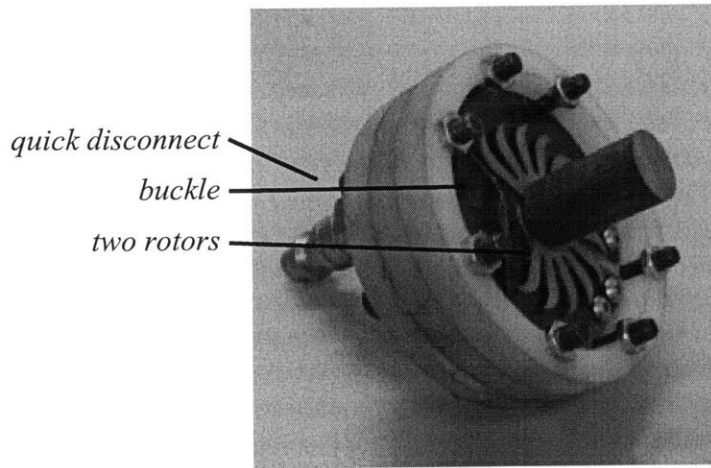
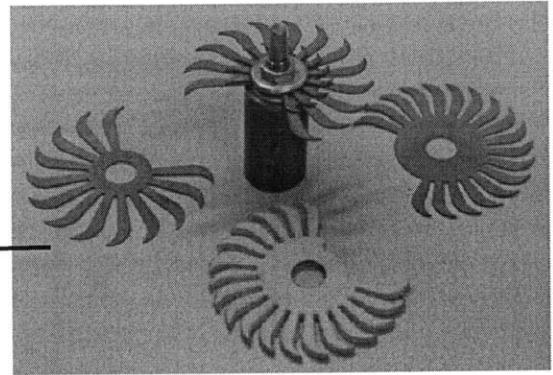
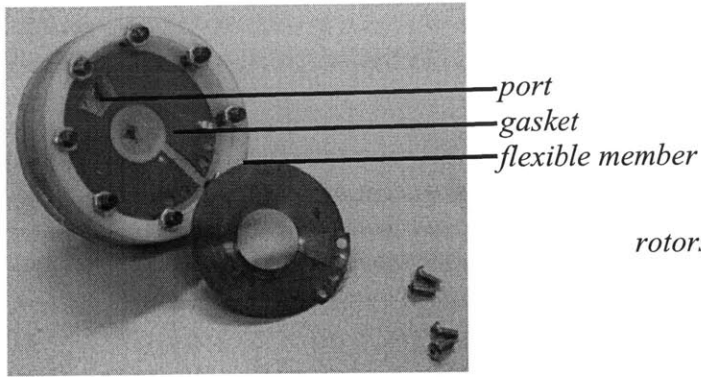

Shown here is a reciprocating 'rotary valve'. It is slightly conical (85° cone) covered with a rubber gasket and uses two concentric rotors (as shown above). This valve proved to seal even better than those used for the experimental data analyzed earlier.

## 8. ADDENDUM: THE FR-DP MAP

### 8.1. ABSTRACT

Axiomatic Design (AD) was originally developed with the intent of creating a powerful tool to direct the design process. It provides a quantitative method for identifying problematic areas in existing designs and can be used to aid in the selection of alternate designs. There are a number of visualization tools which can be used to implement axiomatic design, each having their own benefits. In this paper I propose an innovative visualization tool: the FR-DP map. In addition to providing a fluid interface, the FR-DP map allows designers to use AD in ways hereto for unknown.

### 8.2. INTRODUCTION

In 1977, Nam P. Suh introduced Axiomatic Design to the world through his textbook, *The Principles of Design*. AD employs a top-down approach, where one starts with the most general goal, and subsequently decomposes the design. At the heart of Axiomatic Design are two fundamental axioms. The *independence axiom* suggests that one should maintain the independence of the functional requirements (FRs). This means that in a system with two or more FRs, the design solution should be such that one can control the FRs independent of each other. In other words, each design parameter (DP) should only affect only one FR. Such a system is called an *uncoupled* system. If some DPs influence multiple FRs, but there is a specific order through which one can adjust the DPs without a need for iteration, the design is called *decoupled*. In a *coupled* system iteration is required to satisfy all FRs. The *information axiom* states that one should minimize the information content of the design (i.e.—the design with the highest probability of success is the best design).<sup>45</sup>

AD offers its users a number of advantages. First, it lets users create designs without a pre-conceived solution. AD forces designers to start with the most general FRs, which are then decomposed into the final design. Thus, one is free to consider any number of FRs/DPs. Second, it provides a basis by which one can quantitatively evaluate a design. For instance, numerous designs are coupled—meaning that they can be hard to control. AD can be used to identify these couplings and develop uncoupled solutions. Third, it provides a powerful design documentation tool that can be easily understood by people uninvolved in the process. Not only is it clear which DPs satisfy which FRs, but it is easily understood how the system has been decomposed.

However, there are some other ‘undiscovered’ advantages which AD has. These ‘powers’ have remained hidden because different AD visualization tools highlight different aspects of the design. For instance, while the design matrix clearly shows the couplings in a design, a flow-chart is specially suited for showing a design process. The FR-DP map, presented here, provides a fluid, easy-to-understand method for presenting

---

<sup>45</sup> See Chapter 1 of [11]





understand what components are in a system, and how they functionally fit into the system (i.e.—one can easily see what components make up a pump, and how different elements contribute to higher-level tasks).

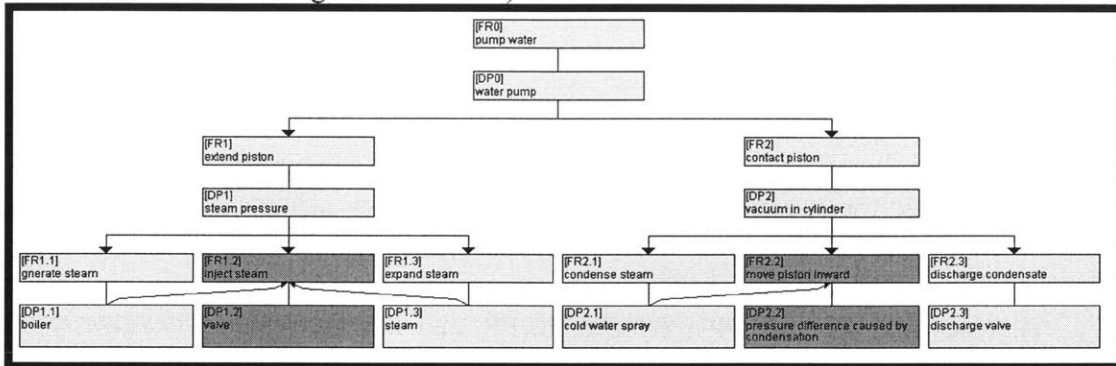

Figure 8.2

### 8.3.3. Flow-Chart

The flow-chart displays the same information that is contained in a tree diagram, but is a method better suited to understanding the operation of a system. In the flow-chart, one can still understand how a design is decomposed, as the children are nested within a larger envelope representing the parent FR/DP; but it orients the children such that one can easily see how entities depend on each other. This can be especially useful in a decoupled system.

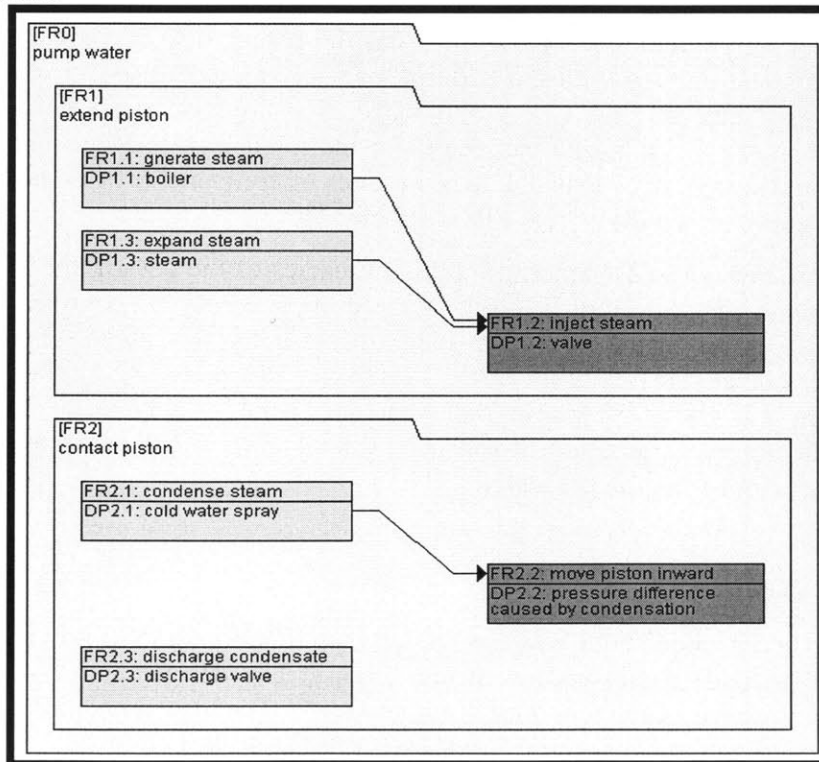

Figure 8.3

## 8.4. FR-DP MAP

### 8.4.1. The Basics

From this ‘need’ for an easy-to-understand visualization tool with maximum information content comes the FR-DP map. The FR-DP map combines the benefits of all three visualization tools while adding some extra features. These elements do not represent the power of the FR-DP map, but are instead simple tools which combine to make a powerful visualization machine.

- **Division of FRs and DPs:** By default,  $FR_i$  and  $DP_i$  are related; however, in a coupled/decoupled design it is important to know the degree of connection between all entities—information that is only provided in the design matrix. In tree diagrams and flow-charts,  $FR_i$  and  $DP_i$  are joined together as one ‘set’; however, by separating  $FR_i$  and  $DP_i$ , one can treat all relationships equally, and thus provide a clearer representation of the associations in a design.
- **Degree of Connection:** Aside from the design matrix, degrees of connection are not represented in the AD visualization tools. Although the connection itself is represented, the ‘weight’ of the connection is unknown. In the FR-DP map, a degree of association is represented by the length of the lines connecting the FRs and DPs.
- **Easy Interface:** The FR-DP map has the potential to become a highly effective visualization tool with the addition of many features used in other visualization tools—such as flow-charts and maps. For instance, the FRs and DPs can be different colors. Shape can represent the total degrees of connections emerging from the specific FR or DP hub. Pictures of components or extra information can be added in the individual FR or DP envelopes.
- **Children only:** Depending on the intricacies of the design, the FR-DP map may contain just children. While in some designs it may be possible to envelope the children (as in the flow-chart diagram), in some designs the ‘parental envelope’ can hinder the flexibility of the design. By just including children, the designers can see the correlations between the actual components, rather than the assemblies. In addition, it can help simplify the visualization by minimizing the excess information presented.

### 8.4.2. Demo

To better understand how the FR-DP map functions and its power, we shall create an FR-DP map of a Newcomen Steam Engine. The design matrix is borrowed from *Axiomatic Design: Advances and Applications*.<sup>46</sup> The decomposition, with a slightly revised design matrix, to account for degrees of relationship, follows:

---

<sup>46</sup> See p. 25 of [11]





FR <sub>1</sub> : Extend the piston	
FR <sub>2</sub> : Contract the piston by creating a vacuum in the cylinder	
DP <sub>1</sub> : Pressure of the steam	$\begin{Bmatrix} X & 0 \\ 0 & X \end{Bmatrix}$
DP <sub>2</sub> : Vacuum in the cylinder/piston by condensation of the steam	

FR <sub>11</sub> : Generate the steam	
FR <sub>12</sub> : Inject the steam	
FR <sub>13</sub> : Expand the steam and move the piston outward	
DP <sub>11</sub> : Boiler	$\begin{Bmatrix} X & 0 & 0 \\ X & X & x \\ 0 & 0 & X \end{Bmatrix}$
DP <sub>12</sub> : Valve	
DP <sub>13</sub> : Steam	

FR <sub>21</sub> : Condense the steam	
FR <sub>22</sub> : Move the piston inward	
FR <sub>23</sub> : Discharge the condensate	
DP <sub>21</sub> : Cold water spray	$\begin{Bmatrix} X & 0 & 0 \\ X & X & 0 \\ 0 & 0 & X \end{Bmatrix}$
DP <sub>22</sub> : Pressure difference caused by condensation	
DP <sub>23</sub> : Discharge valve	

*Note: in our design we will also add cross-coupling between:*

*DP<sub>21</sub> has a small effect on FR<sub>13</sub> (x)*

*DP<sub>13</sub> has a strong effect on FR<sub>21</sub> (X)*

table 1

From this design, we can now create our FR-DP map. The rules in designing an FR-DP map are quite simple, although it may become more involved in complex designs (with a larger number of cross-links). The main goal in developing an FR-DP map is to keep it neat and easily readable (i.e.—one should avoid cluttering entities, especially if they are not related; one should minimize lines from crossing; and so on). Ideally software will help create the FR-DP map, but a suggestion in creating the FR-DP map by hand follows:

1. **Begin with a hub:** Begin with the FR/DP with the highest number of connections. In our case, we can begin with either FR<sub>12</sub>, DP<sub>13</sub> or DP<sub>21</sub>.

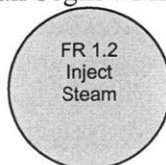
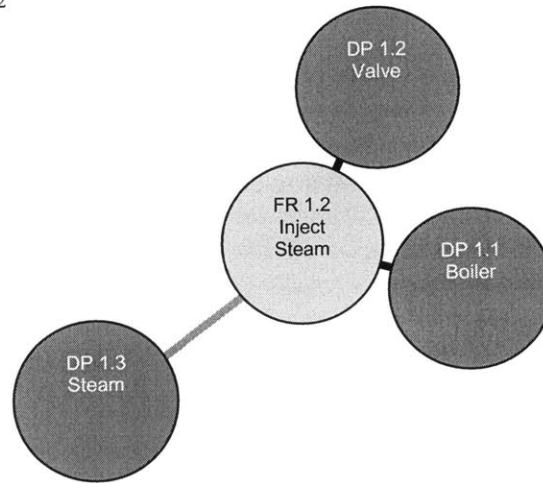

Figure 8.4



2. **Branch outwards:** Supposing we choose to start with  $FR_{12}$ , we then add  $DP_{11}$ ,  $DP_{12}$  and  $DP_{13}$ —all spaced evenly apart to avoid clutter (i.e.—they are each  $120^\circ$  apart from each other). We are careful to place the DPs at appropriate distances from  $FR_{12}$  (note that  $DP_{13}$  should be spaced further than the others, as it has a weaker relationship). We draw connecting lines to show the relationships between the DPs and  $FR_{12}$



*Figure 8.5*

3. **Move on to the next hub:** From  $FR_{12}$ , we should then proceed to  $DP_{13}$ , as it is a more significant hub than  $DP_{12}$  or  $DP_{11}$ .

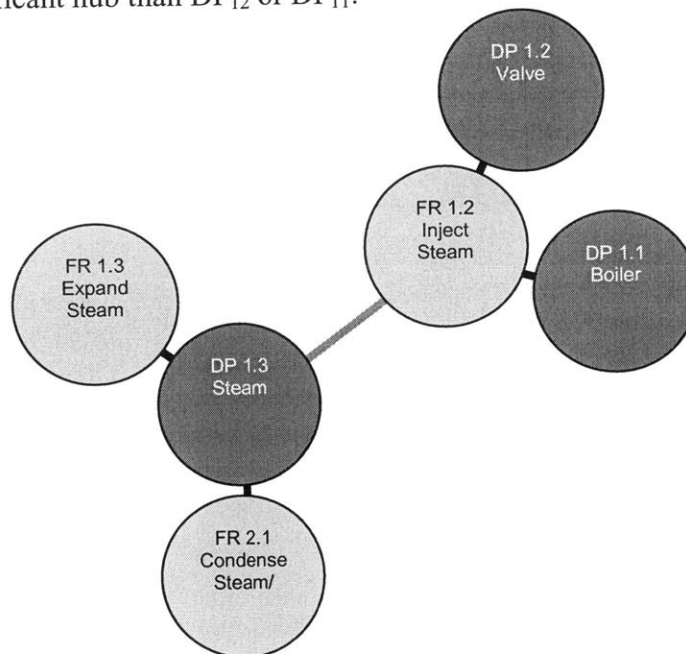

*Figure 8.6*

4. **Repeat until figure is completed:** Note that the positions of the figures may need to be adjusted to avoid clutter, depending on the intricacies of the design.

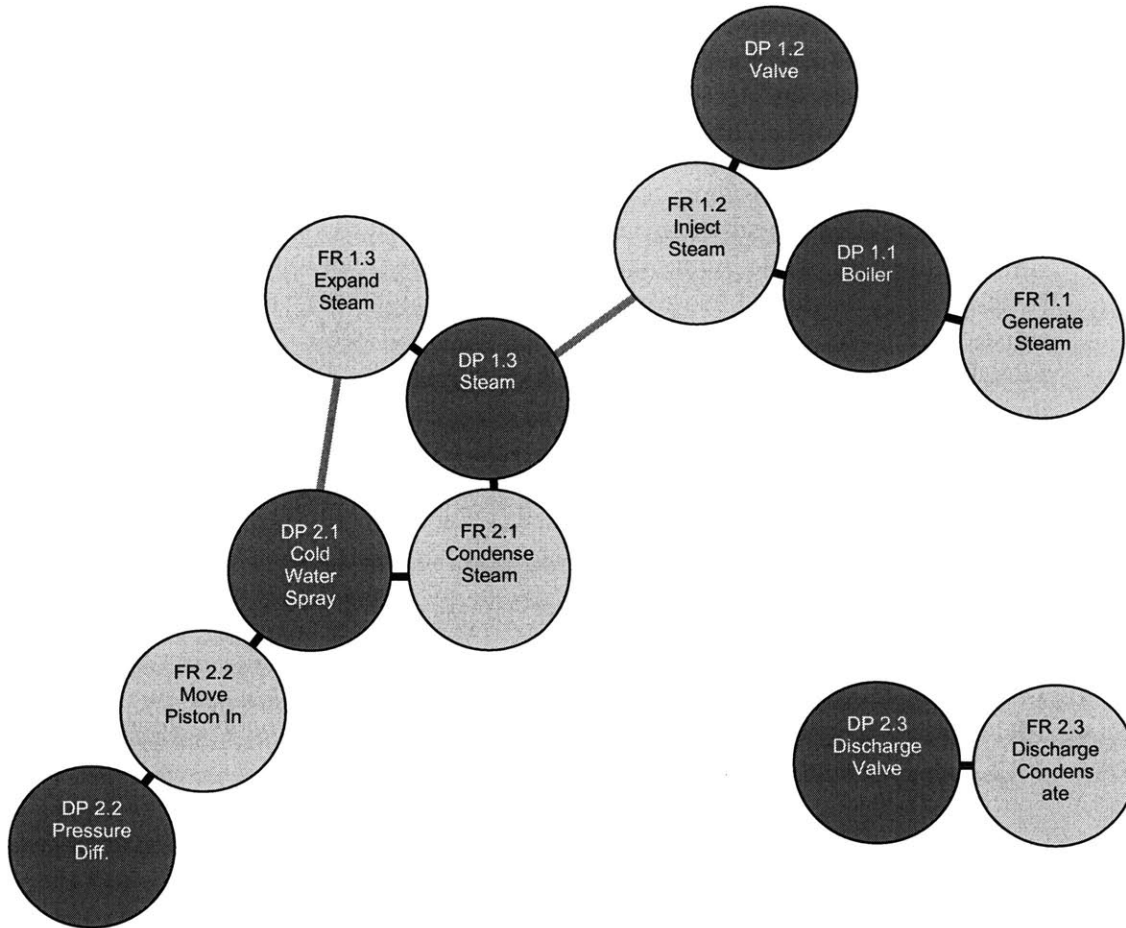

**Figure 8.7**

Figure 4 shows the complete design in the FR-DP map format. Once a map has been created, there are a number of ways which one can analyze it. First, the FR-DP map can be used to solve a design (i.e.—determine values for the DPs). Second, the FR-DP map can shed light on specific FR and DP hubs which should be monitored/maintained strictly. In addition, the map helps to visually and functionally divide the system-level design into distinct ‘islands’ which can be used to create and manage more robust designs. Finally, one can introduce a new metric of performance, based on the relationships.

#### *8.4.2.1. Solving the Design*

Solving the design is a rather easy process and should be done using the following basic rules:

1. **FRs first:** By nature, DPs are used to satisfy FRs; thus, by beginning with an FR, we know how to adjust the DP.

2. **Take the higher road:** When we reach a coupled loop in our map, we must decide between at least two directions to follow. Always proceed to the path with the highest degree of connection.
3. **uncoupled→serial-decoupled→coupled→parallel-decoupled:** *Note: for a better understanding of these design-types, please go to the Appendix.* This order is not the only way to solve an FR-DP map, but in most cases it should offer the simplest method while minimizing excess design iterations. Uncoupled areas (where an FR is affected by only one DP) are the simplest to solve, and should be satisfied first. Serial decoupled designs are also simple, in that once the first FR/DP pair is set, the subsequent FRs can be adjusted by a DP directly downstream (it behaves like a domino-effect). Next, we should target the coupled areas. These are the most difficult to satisfy and can often involve several iterations. Once the coupled area is solved, we can move on to the remaining areas (parallel-decoupled), which can be satisfied without effecting previous steps.

Using the above rule set to satisfy our FR-DP map, we will proceed as follows:

- FR2.3 → DP2.3 (*uncoupled*)
- FR1.1→DP1.1 (*serial-decoupled*)
- FR1.3→DP1.3→FR2.1→DP2.1 (*coupled...note: some iteration may be required*)
- FR2.2→DP2.2 and FR1.2→DP1.2 (*parallel-decoupled*)

#### 8.4.2.2. FR/DP Hubs

A hub is a node which should be monitored closely. The definition of a hub is rather subjective, but under its broadest form, it is an FR or DP with two or more connections. The definition of a hub depends on the size of the design, the type of design (i.e.—coupled, uncoupled...) and the discretion of the designer. For instance, in the above Newcomen Steam Engine design, I would consider only FR1.2 and DP1.3 as hubs, because the number of nodes with two connections is so high. However, in a mostly uncoupled design, a hub might only have two connections.

In the case of an FR hub, there are a number of DPs which influence the FR. This has two large affects on the FR. First, because there are so many factors affecting the FR, the variation may be significant. Naturally, as the number of connections increases, the ‘noise’ will be higher. However, while it may be difficult to minimize the disturbances in the system, the probability of the FR staying satisfied may increase as the number of connections increases. By maximizing the influencing factors, one could, in theory, have a higher probability of maintaining the FR with a specified design range.

A DP hub requires much different action than an FR hub. In a DP hub, a DP influences a number of FRs. Thus, any small variation in this DP may have a significant and far-reaching impact on the system. In such a case, the DP should be monitored very closely. In addition, based on this analysis alone, the importance of such a DP could be more important than other nodes.

### 8.4.2.3. *Islands*

An entire FR-DP map is considered a system. However, this system can be divided into a number of islands. An island is defined as an 'isolated' group of nodes. Although these islands may be bridged together, they are separate enough such that what happens in one island will have little or no impact on the other island. In the Newcomen Steam Engine design, there are two islands (i.e.—a change in DP1.3 will have no affect on FR2.3). Although islands are often siblings (they come from the same branch), in certain cases, such as the Newcomen Steam Engine, some islands may contain children from multiple branches.

Understanding islands can be useful for a number of reasons. First, the size of the island is important. A smaller island is stabler and easier to control than a larger one. If there are critical design modules—such as a life support system in the space shuttle—the islands should be as small as possible. Second, the higher the number of islands, the more uncoupled the system is—and thus the easier it is to control. Third, a knowledge of islands can be useful when designing or maintaining a system. For instance, in a system as complex as a space shuttle, it would make sense to have specialized teams working on certain islands. In addition, it would be important to know how many bridges the island may have and how long those bridges are. It is important to know which islands the bridges connect, and specifically where in the islands the bridges connect (which specific nodes). Also, a longer bridge means a looser connection, which means the islands are more isolated (i.e.—more uncoupled) from each other. Finally, the arrangement of islands can affect the function of a system. Islands, like nodes, can be hubs, and can be uncoupled, decoupled and coupled. Rules of analysis of these island connections is similar to that of nodes.

### 8.4.2.4. *Degree of Relation*

One unique attribute which the FR-DP map provides us is the ability to provide an additional measure of performance—the 'degree' of relation of a design. This can be used to provide insight into both the performance of individual nodes and the entire system. The relationship between two nodes is a function of a number of parameters, including the number of nodes separating them and the number of paths between them (i.e.—in a decoupled system there is only one path, but in a coupled system there may be a number of potential paths).

### 8.4.2.5. *Coupled loops*

One interesting feature, which can be analyzed using other visualization tools, but may be easier to view using the FR-DP map, is an ability to characterize a 'degree' of coupling in coupled loops. Two potential measures include the loop size (i.e.—how many nodes compose the coupling?) and the degree of cross-linking (i.e.—how many integrated loops are there?).

## 8.5. **CONCLUSION**

The FR-DP map can provide designers with a very powerful tool. Although it uses only information embedded in the design matrix, it does so in a unique manner which can

provide engineers and designers alike with a unique perspective into the system design. Specifically, it can provide some of the following benefits:

- **Easy visualization:** The FR-DP map provides a visualization tool which can be easily understood by designers, engineers and other staff (who need not be very familiar with axiomatic design or engineering). Like a tree-diagram, the format is intuitive and universal (i.e.—maps of airplane routes follow a similar format to the FR-DP map). In addition, the ability to embed pictures or other descriptive information can be particularly useful for staff. For instance, the DPs can include pictures of components, estimated costs, and can link to helpful information (such as maintenance information, time to availability/time to repair, etc.)
- **Determine Hubs (for either FR or DP):** The FR-DP map easily displays FR/DP hubs. A DP hub is most likely a very important component in the success of the entire design and should be robust or maintained very well. An FR hub means that several components affect it, and that it may be difficult to maintain at its target range.
- **Coupled designs:** The FR-DP map shows the optimal path to follow in a coupled design. Specifically, we can carefully decide how to solve a coupled design in the most time-efficient method. In addition, we can evaluate the degree of coupling of a design. The degree of coupling is affected by two parameters: 1) the number of coupled loops in the design; and 2) the size of the coupled loop. Coupled designs are sometimes unavoidable (because of existing components, cost, etc) and the FR-DP map can be a powerful tool in allowing axiomatic design to aid in these areas where it previously could not.
- **Serial vs. Parallel decoupling:** The FR-DP map clearly shows the difference between serial and parallel decoupled designs. (*note: see appendix for better understanding of design-types*)
- **Maintenance:** As the FR-DP map is easy to understand, it can be used to help maintain a complex system. For instance, one can easily determine how certain changes will affect the system by observing the links between FRs and DPs. The **effective relationship** between two entities (i.e.—FR to FR, FR to DP, DP to DP) can be measured using the following parameters: 1) number of links separating entities; 2) distance between entities (certain links may be longer than others); 3) type of design areas separating entities (coupled, parallel-decoupled, serial-uncoupled); and 4) number of routes between entities (this only occurs in coupled designs).
- **Complexity management:** The above factors can all be used to help minimize the complexity of a system. The complexity can be measured by the max/min/mean effective relationship between entities in the design. In addition, one can minimize the complexity by following certain other AD standards.

## 8.6. APPENDIX (FR-DP MAP)

### 8.6.1. Uncoupled

Uncoupled designs are the most favorable, as they are easy to control; to change an FR, one must only change its corresponding DP, and that DP has no parasitic effects.

In the FR-DP map, an uncoupled design area is essentially an island. In a completely uncoupled design, islands will be composed of a linked FR-DP pair. In addition, it is possible to have larger ‘uncoupled design zones’. For instance, a design might have two or three different ‘uncoupled islands’, while some form of coupling may exist within the island.

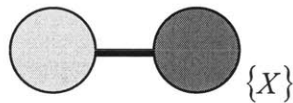

Figure 8.8

### 8.6.2. Decoupled

Decoupled designs are favorable to coupled designs, as they are still easy to control, but one must follow a specific order to adjust a system. There are two forms of decoupled designs: parallel decoupled and serial decoupled. A parallel decoupled design is a preferable system to a serial decoupled system as the FR's and DP's are more independent of each other. In a serial decoupled system, any change will affect all downstream entities, while some entities in a parallel decoupled system can remain unaffected. Metaphorically, a serial decoupled system can be represented as one mountain stream (which may separate into multiple streams) which drains to a river basin; a parallel decoupled system is better represented as multiple streams emanating from different mountain sources, which all join together into a major river.

In the FR-DP map, a serial decoupled system has a DP as a hub, while a parallel decoupled system has an FR as the hub.

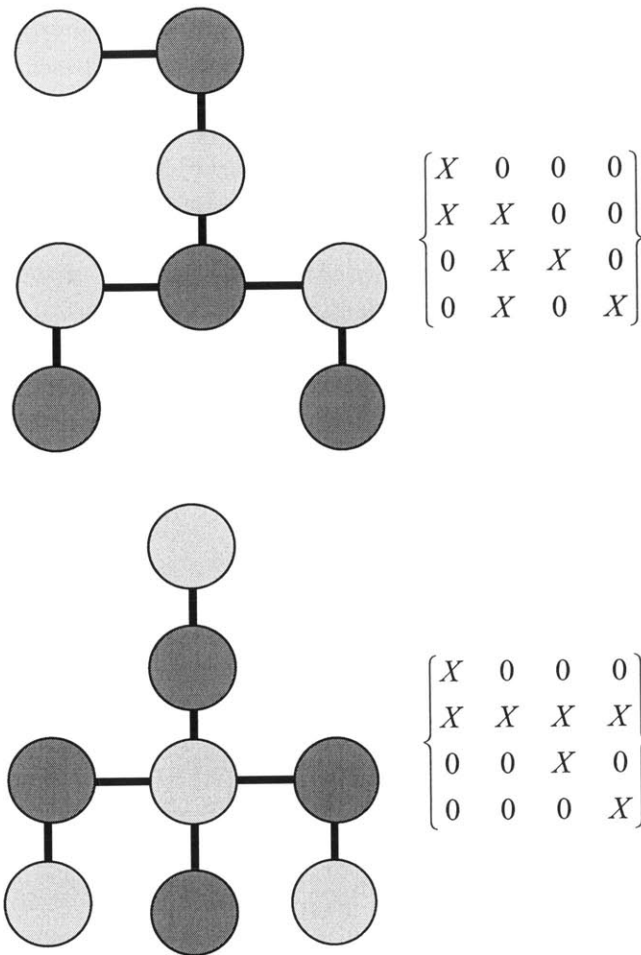

Figure 8.9

### 8.6.3. Coupled

A coupled design is the least favorable as multiple iterations may be required to satisfy all FRs. In addition, any slight change to a component will affect the entire system and require a subsequent iteration to satisfy the FRs again—a coupled system can be very difficult to control.

In the FR-DP map, a coupled design area is symbolized by any loop. Depending on the degree of coupling, the loop may be composed of any number of entities and may even contain sub-loops.



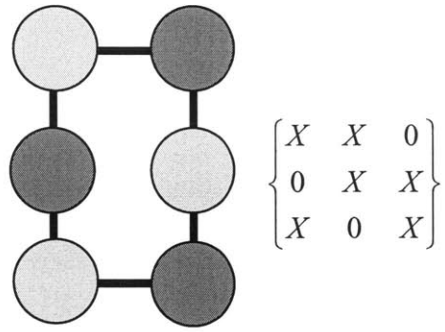

*Figure 8.10*

## 9. BIBLIOGRAPHY

1. Bohacz, Ray T., "Look Mom, No Camshaft!" Engine Masters. 2000, pp.32-35
2. Burch, A., Fatigue Strength Calculation. Brookfield, VT: Trans Tech Publications, 1988.
3. Cho, Nam-Hyo, "A Final Report on the Design and Development of a Prototype Ecogin Engine". IAE Korea, 2003.
4. Collins, Jack, Mechanical Design of Machine Elements and Machines. New York: John Wiley & Sons, Inc., 2003.
5. Cross, P.C., Hansen C.N., Martin J.K., A Rotary Valve Combustion System with Throttleless Inlet Charge Control. SAE Paper 940813
6. Dickenson, T. Christopher, Valves, Piping and Pipelines Handbook. Oxford: Elsevier Advanced Technology (Cambridge University Press), 1999.
7. Heywood, John B., Internal Combustion Engine Fundamentals. New York: McGraw-Hill, 1988.
8. Hunter, Marcus C. Inman, Rotary Valve Engines. New York: John Wiley & Sons, Inc., 1946
9. Shigley, J.E. and Uicker Jr., J.J., Theory of Machines and Mechanisms. London: McGraw-Hill International Editions, 1981.
10. Sines, George and Waisman, J.L., Metal Fatigue. New York: McGraw-Hill, 1959.
11. Suh, Nam P., Axiomatic Design: Advances and Applications. New York: Oxford University Press, 2001.
12. Suh, Nam P., Tribophysics. New Jersey: Prentice-Hall, Inc., 1986.
13. White, Frank M., Fluid Mechanics. New York: McGraw-Hill, 1999.
14. Whitehouse, R.C., The Valve and Actuator User's Manual. London: Mechanical Engineering Publications Limited, 1993.
15. [www.coatesengine.com/eGallery/pages/replaced-parts.htm](http://www.coatesengine.com/eGallery/pages/replaced-parts.htm)
16. [www.harmonic-drive.com/support/principals.htm](http://www.harmonic-drive.com/support/principals.htm)