

Quantifying the Economic Potential of a Biomass to Olefin Technology

by

Nicholas Chiang

B.S. Electrical Engineering (2004)
California Institute of Technology

Submitted to the Department of Materials Science and Engineering in Partial Fulfillment
of the Requirements for the Degree of Master of Engineering in Materials Science and
Engineering

at the

Massachusetts Institute of Technology

September 2005

© 2004 Massachusetts Institute of Technology. All rights reserved.

Signature of Author: 
Department of Materials Science and Engineering
August 11, 2005

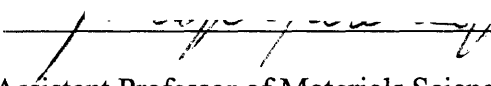
Certified by: 
Randolph E. Kirchain, Jr.
Assistant Professor of Materials Science and Engineering and Eng. Sys. Div.
Thesis Supervisor

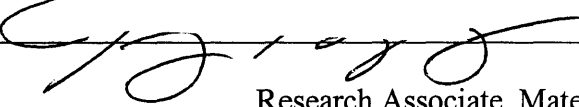
Certified by: 
Jeremy Gregory
Research Associate, Materials System Laboratory
Thesis Supervisor

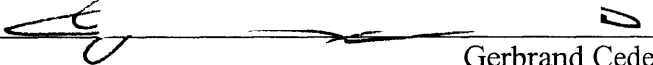
Accepted by: 
Gerbrand Ceder
R.P. Simmons Professor of Materials Science and Engineering
Chair, Departmental Committee on Graduate Students

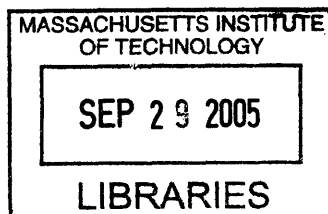

ARCHIVES

Quantifying the Economic Potential of a Biomass to Olefin Technology

by

Nicholas Chiang

Submitted to the Department of Materials Science and Engineering on August 12, 2005
in Partial Fulfillment of the Requirements for the Degree of Master of Engineering in
Materials Science and Engineering

ABSTRACT

Oil is one of the most valuable natural resources in the world. Any technology that could possibly be used to conserve oil is worth studying. Biomass waste to olefin (WTO) technology replaces the use of oil as a feedstock. WTO technology is actually a combination of two different processes: the waste to methanol (WTM) process and the methanol to olefins (MTO) process. However, WTO technology is still not commercially applied. Despite the environmentally beneficial advantages of biomass waste to olefins technology, the economic advantages or disadvantages still need to be explored further. This thesis tries to determine under what operating conditions (production volumes, feedstock prices, etc.) make the biomass waste to olefins technology most competitive. The WTM process is the economical limiting factor in the WTO technology. However, for relatively significant production volumes, the WTO technology is still competitive with a slight decrease in biomass feedstock price.

Thesis supervisor: Randolph E. Kirchain, Jr.

Title: Assistant Professor of Materials Science and Eng. Sys. Div.

Acknowledgements

I would like to thank Dr. Randy Kirchain and Dr. Jeremy Gregory for all of their suggestions and advice while I was writing my thesis. They were always generous with their time and offered a great deal of guidance. I would not have been able to finish without their support.

I would also like to thank Selim Nouri. He is doing research at Chalmers University in Sweden on the environmental impacts of biomass waste to olefins technology. Although I never got the opportunity to meet him in person, he provided me with data needed to complete my thesis. His timely email responses were greatly appreciated.

And finally, I would like to thank my family. My mom and dad have always supported me throughout my life. Even my younger brother, Alex, seems to have his moments at times. Thank you for everything!

Table of Contents

1. Introduction	6
2. WTM Technology Background	10
2.1 Pretreatment	10
2.2 Gasification	10
2.3 Gas Cleaning	11
2.4 Syngas Processing	11
2.5 Methanol Synthesis	11
3. MTO Technology Background	13
4. Cost Modeling Background	15
5. WTM Cost Model	18
5.1 Material Costs	18
5.2 Equipment Costs	20
5.3 Labor Costs	21
5.4 Energy Costs	22
5.5 Building Space Cost	23
5.6 Maintenance Costs	23
5.7 Overhead Costs	23
6. MTO Cost Model	24
6.1 Material Costs	24
6.2 Equipment Costs	25
6.3 Labor Costs	25
6.4 Energy Costs	25
6.6 Building Space Cost	26
6.6 Maintenance Costs	26
6.7 Overhead Costs	26
7. WTM Cost Model Analysis	27
7.1 Product Cost Versus Production Volume	27
7.2 Product Cost Versus Investments in Equipment	28
7.3 Product Cost Versus Biomass Feedstock Price	28
7.4 Product Cost Versus Production Volume and Biomass Feedstock Price	29
8. MTO Cost Model Analysis	31
8.1 Product Cost Versus Production Volume	31
8.2 Product Cost Versus Investments in Equipment	32
8.3 Product Cost Versus Methanol Feedstock Price	33
8.4 Product Cost Versus Production Volume and Methanol Feedstock Price	33

9. Analysis of WTM and MTO Cost Models Combined	35
9.1 Olefin Product Cost Versus Olefin Production Volume	35
9.2 Olefin Product Cost Versus Biomass Feedstock Price	36
9.3 Olefin Product Cost Versus Olefin Production Volume and Biomass Feedstock Price	37
10. Conclusion	38
11. References	39

1. Introduction

The United States consumes more oil than any other country in the world. The United States currently consumes approximately 20 million barrels of oil a day, which is nearly four times that of Japan, the country with the second highest consumption of oil in the world [1,2]. The United States' demand for oil is expected to grow significantly during the next couple decades. With growing demand for oil as well as higher oil prices, the conservation of oil has becoming an increasingly important issue.

Oil is not solely used to produce fuel for vehicles. It can also be refined to produce plastics. One possible method of conserving oil is to find a substitute feedstock to produce plastics. Using today's technology, it is possible to produce plastics using biomass waste as a feedstock. Biomass waste is any kind of organic matter that can be burned to produce heat. Another advantage of using biomass waste as opposed to oil as a feedstock is that it is a renewable resource while oil is not. Some examples of biomass waste include wood, agricultural waste such as crop residues or livestock manure, and municipal waste such as sewage.

The technology evaluated in this thesis converts biomass waste to olefins, with particular emphasis on using wood as a feedstock. Olefins are a group of unsaturated hydrocarbons that have double the number of hydrogen atoms as carbon atoms per molecule. They are also known as alkenes. Ethylene and propylene are the two types of olefins that are produced. Some examples of products that are made with or derived from ethylene and propylene include: antifreeze, detergents, cosmetics, and adhesives. However, most of the ethylene and propylene produced are linked with molecules of the same kind to produce polyethylene and polypropylene which are two of the most commonly used plastics in the world.

In 2003 the worldwide demand for ethylene was estimated to be 103 million tonnes while the worldwide demand for propylene was estimated to be 61 million tonnes [3]. By the end of 2009, the worldwide demand for ethylene is expected to grow to 128 million metric tones while the worldwide demand for polyethylene is expected to grow to 78 million metric tons. One thing to note from this data is that the demand for propylene is expected to grow relatively faster than that of ethylene.

The dominant technology used today to produce ethylene and propylene is steam cracking, which is a process in which saturated hydrocarbons are broken down into smaller, usually unsaturated, hydrocarbons. The main feedstock used in steam cracking is naphtha, which is a mixture of different volatile flammable hydrocarbon liquids. Naphtha is produced by distilling oil.

The biomass waste to olefins process is actually a combination of two separate technologies: the biomass waste to methanol (WTM) process and the methanol to olefins (MTO) process. Both technologies have been studied extensively in the past independent of the other. Most of the research in the WTM technology has been geared toward creating a sustainable fuel. The methanol was to be used in fuel cells to power cars. The idea was that fuel cell vehicles would cause less pollution and also reduce the United States' dependence on importing oil from other countries.

Currently the WTM technology has not found any widespread commercial use. However, there is a company based in Ft. Lauderdale, FL still exploring this technology. Ener1 is a company that makes lithium batteries and fuel cells [4]. Ener1 is toying with the idea of using orange peels as a feedstock to produce methanol. It is estimated that Florida produces about 8 million tons of orange peels a year, which are usually used to make cattle feed. Ener1 was recently awarded a five hundred thousand dollar grant to

carry out their research. Ener1 is planning to use the methanol as an energy source to power an interstate highway rest area in Florida.

Mobil did the majority of the original research in MTO technology during the energy crisis of the 1970s [5]. The MTO process was an intermediate step in creating gasoline from methanol. As a result, Mobil developed the MTO process alongside the methanol to gasoline process. Since that time other groups have focused research on the MTO process by itself. The MTO process was recently commercialized due to the collaborative efforts of two different companies: UOP and Hydro [5]. UOP constructed a demonstration plant in 1995 capable of processing one metric ton of methanol per day. According to their studies, UOP claimed that they could scale this production by about a factor of 8000 to produce one million metric tons of ethylene and propylene per year. UOP currently licenses their MTO process and the catalyst that they use.

The purpose of the Master of Engineering thesis is to evaluate a new technology and determine the feasibility of its commercialization. Many factors influence the commercialization of a technology. Some examples include technological barriers, intellectual property issues, and government regulations. This thesis is focused primarily on evaluating the operational costs of the biomass waste to olefins (WTO) process as a means to describe its potential for commercialization. The operational costs encompass the fixed and variable costs of the entire process. Fixed costs include expenses for equipment, maintenance, overhead, and building space. Variable costs include expenses for materials, labor, and energy. These expenses are measured with an analytical technique called cost modeling. The objective of a cost model is to determine the operational costs of a technological process by analyzing the process. A more detailed description of the basics and methods of cost modeling will be discussed later.

After determining the operational costs of the biomass waste to olefins process, these values can be compared to recent prices of ethylene and propylene. The feasibility of commercializing biomass waste to olefin technology, in terms of operating costs, can be estimated through this comparison. This thesis tries to determine under what operating conditions (production volumes, feedstock prices, etc.) make the biomass waste to olefins technology most competitive.

This thesis attempts to develop accurate cost models for the WTM and MTO processes. The WTM cost model is independently analyzed and the calculated cost of producing methanol with WTM technology is compared to the cost of producing methanol with current technology. The MTO cost model is analyzed with a set price for methanol feedstock. The WTM and MTO cost models are then combined and analyzed. The calculated cost of producing olefins with biomass waste to olefins technology is compared to a recent price for olefins.

The backgrounds and descriptions of the WTM and MTO processes will be given. Then there will be an introduction to the basics of cost modeling. Finally, the results and analysis of the WTM and MTO cost models will be discussed.

2. WTM Technology Background

The WTM process can be broken down into a number of steps: 1) pretreatment, 2) gasification, 3) gas cleaning, 4) syngas processing, and 5) methanol synthesis [6-9].

Figure 1 displays a block diagram of the WTM process.

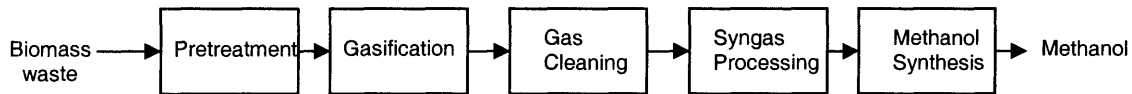

Figure 1. Block diagram of the waste to methanol process.

2.1 Pretreatment

The first step is to pretreat the waste. This involves chipping and grinding the waste into particle sizes of roughly 0 to 50 mm in diameter. The feedstock is then dried to a moisture content of approximately 10% to 15%.

2.2 Gasification

The waste is then passed on to a gasification reactor where it is heated in the presence of steam and oxygen to produce a synthetic gas composed of hydrogen, steam, carbon monoxide, carbon dioxide, methane, and ethylene. The gasification step usually takes place between temperatures of 800 to 1000 degrees Celsius. There are also some by-products produced such as tar, sulphur, and ash. Figure 2 is a diagram of a typical IGT gasifier.

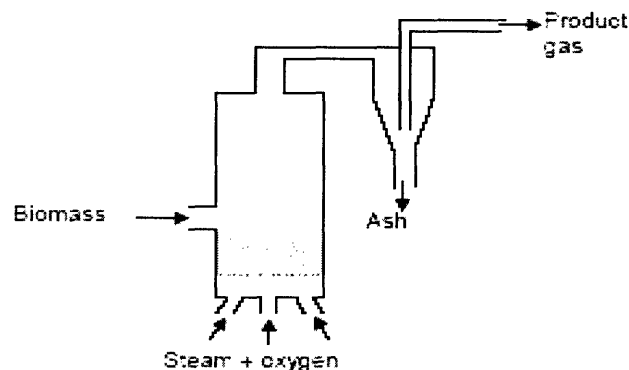

Figure 2. Diagram of a typical IGT gasifier [6].

2.3 Gas Cleaning

These by-products are removed during the gas cleaning step. It is important to remove these contaminants because they cause wear and corrosion throughout the plant, and they also lower the activity of the catalysts that are used later on in the chemical reactions that take place in the following steps.

2.4 Syngas Processing

During syngas processing, the product gas is further refined. The methane and ethylene are converted into carbon monoxide and hydrogen with the aid of a catalyst in a process called reforming. The addition of the catalyst is needed for these reactions to take place.

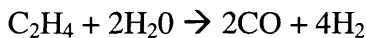
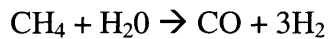

The amount of carbon monoxide is then adjusted using the water-gas shift reaction, which is shown below. Once again, a particular catalyst is needed for this reaction to occur. The amount of carbon dioxide can be adjusted using carbon dioxide scrubbing. Typically, a hydrogen to carbon monoxide ratio of 2:1 with relatively small amounts of carbon dioxide is desired. This ratio is important because it ensures that the stoichiometry of the chemical reactions during methanol synthesis is satisfied. This step is crucial in converting the feedstock into methanol because a certain ratio of carbon dioxide, hydrogen, and carbon dioxide is required for optimal methanol production. And if necessary, carbon monoxide can be reacted with water to produce carbon dioxide and hydrogen as described by the following chemical reaction to further control this ratio.

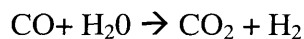

2.5 Methanol Synthesis

During methanol synthesis, the carbon monoxide and carbon dioxide react with hydrogen to form methanol. These reactions take place in the presence of a copper oxide or zinc oxide catalyst. The first reaction produces the majority of the methanol. The relatively small amount of carbon dioxide in the gas acts as a promoter for the primary reaction and helps maintain the catalyst activity.

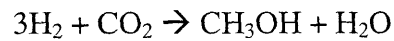
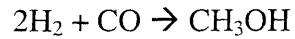

As mentioned earlier, the molar ratio of carbon monoxide, hydrogen, and carbon dioxide is important for optimal methanol production. The quantity

$$R = \frac{\text{H}_2 - \text{CO}_2}{\text{CO} + \text{CO}_2}$$

should have a minimal value of 2.03. Figure 3 shows a typical methanol reactor.

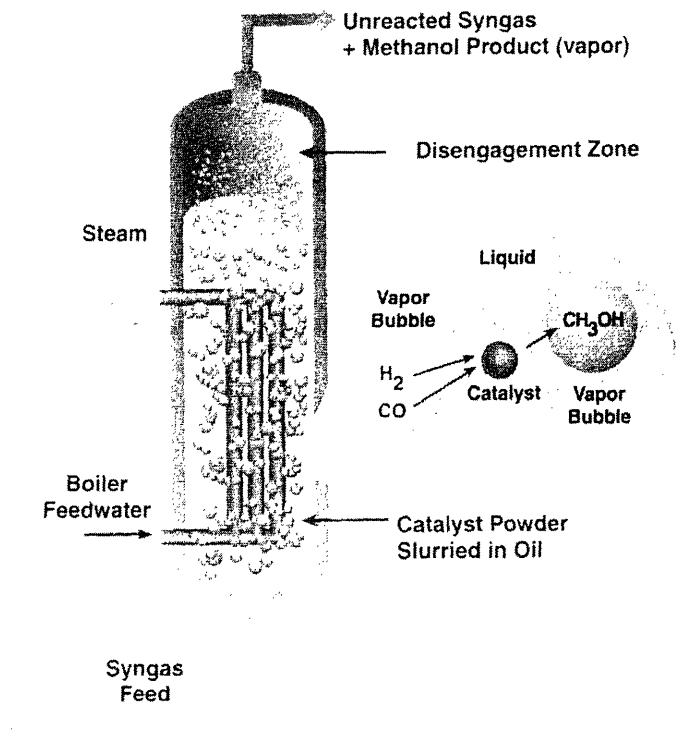

Figure 3. Diagram of a typical methanol reactor [10].

3. MTO Technology Background

The MTO process can be split into two parts: the reactor section and the product recovery section [5,11]. Methanol is preheated and fed into the reactor. The conversion of methanol to olefins requires a catalyst. During the reaction the catalyst accumulates carbon which reduces its activity. So the catalyst is cycled through a regenerator where the carbon is removed and then fed back into the reactor. The reactor operates between the temperatures of 350 to 550 degrees Celsius. The product gas formed by the reactor is composed of ethylene, propylene, carbon dioxide, steam, propane, ethane, and methane.

The product gas is then cooled, causing some of the steam to condense into water which can be removed. The carbon dioxide is then chemically absorbed and the remaining water in the product gas is removed with a dryer.

During the ethylene and propylene recovery step, the propane, ethane, and methane are separated from the ethylene and propylene by through the use of chemical splitters. The entire process produces approximately one metric ton of ethylene and propylene for every three tonnes of methanol. Also, the ratio of the propylene to ethylene produced can be somewhat influenced by the operating conditions of the methanol reactor. Figure 4 shows a diagram of the UOP MTO process.

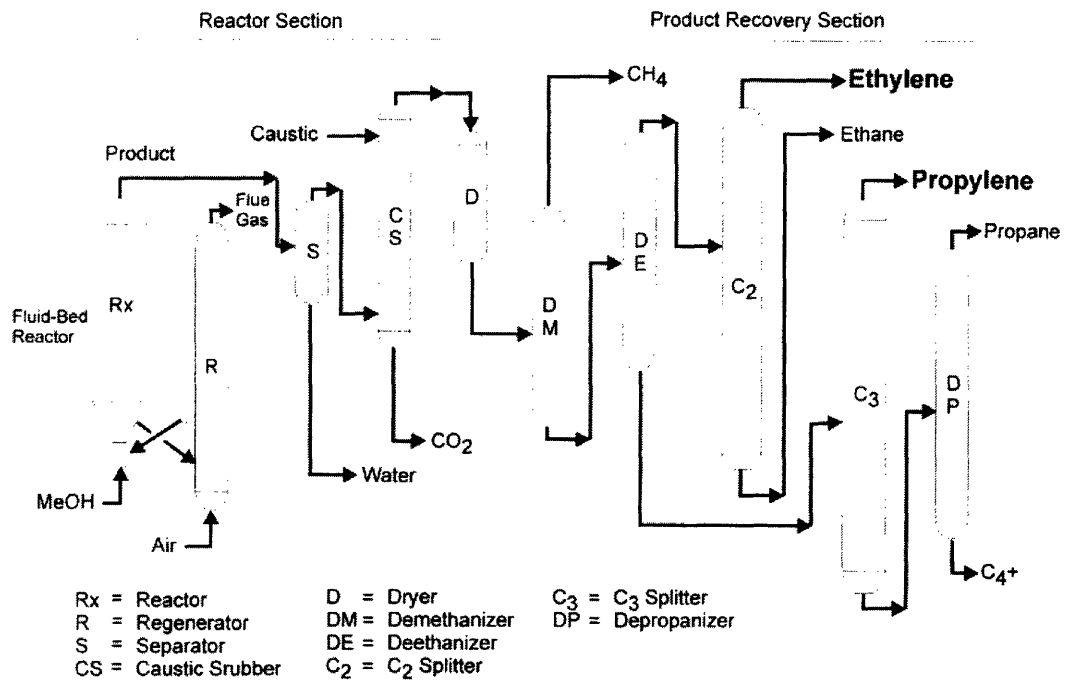

Figure 4. Diagram of the UOP MTO process [5].

4. Cost Modeling Background

A cost model uses technical information about a process to determine the operational costs [12-14]. The model should also be able to address issues such as changes in product design or process operation such as the production volume. Eventually the goal is to have the model measure the operational costs in terms of two rates: cost per unit and cost per time period. Usually, the cost per unit is a good measure for comparing different technologies. Cost models are developed by working backwards. The resulting cost is linked to a sequential number of characteristics that can be eventually quantitatively described by the technical information given about the process. Cost modeling is used as a tool to make decisions concerning a particular technology before it is implemented.

There are four basic steps in creating a cost model: 1) define the question to be answered, 2) identify relevant cost elements, 3) diagram the process operations and material flows, and 4) relate the costs to what is known.

The first step is to define the question to be answered. What is the process being modeled? A solid understanding of the process is necessary since the technical information about the process acts as the basis of the cost model. Who would be providing the money to finance this technology? The perspective of the financier is needed in the following step when determining the relevant costs. Are there any alternative or competing technologies? The costs of alternative or competing technologies can act as a standard of measure for the process being modeled.

The second step is to identify the relevant costs. This relevance depends on the process itself as well as the question being answered by the cost model. When the purpose of a cost model is to compare different technologies used to create functionally

equivalent products, the common relevant costs include material, energy, labor, overhead, building, and equipment costs. These relevant costs can be divided into two groups: variable and fixed costs.

Variable costs are directly proportional to the production volume of a process. Variable costs include expenses for materials, labor, and energy. Material costs are primarily determined by the amount of raw material needed by the process and the price of the raw material. Material losses during the process as well as process consumables such as catalysts also need to be considered. Labor costs are determined by wages and the number of workers needed. Energy costs are determined by the amount of electricity needed to run the equipment as well as any other energy inputs required by the process such as heat.

Fixed costs are not directly proportional to the production volume of a process. Fixed costs include expenses for equipment, maintenance, overhead, and building space. Equipment costs include the cost of the machinery used for production along with the installation costs for the machinery. The equipment costs are usually paid in installments over the lifetime of the machinery. Maintenance costs are taken as a proportion of the equipment costs. Overhead costs include managerial labor and other support services. Building space cost is simply the cost of the space required by the process machinery and utilities. Building space cost is also paid in installments over the lifetime of the building. Table 1 lists common relevant costs in cost modeling.

Table 1. Table of the common relevant costs in cost modeling.

Common Relevant Costs	
Variable Costs	Fixed Costs
Materials	Equipment
Labor	Maintenance
Energy	Overhead
	Building Space

The third step is to diagram the process operations and material flows. This involves breaking the process down into a number of steps. The material flowing in and out of each step needs to be determined. It is often more convenient to record the material flow of each step with a common unit of measure. And also, the equipment, labor, and energy requirements need to be tracked for each process step.

For the last step, the costs are related to what is known by multiplying the requirements that were catalogued in the previous step by their respective unit costs. Sensitivity analyses are conducted on the cost model to determine the important parameters in the model.

5. WTM Cost Model

The WTM process has been extensively well-documented by research papers published in the past. This made the task of developing the WTM cost model much easier. The WTM cost model broke the process down into five steps: 1) pretreatment, 2) gasification, 3) gas cleaning, 4) syngas processing, and 5) methanol synthesis.

5.1 Material Costs

The material cost estimated by the WTM cost model was the cost of the biomass that is used as a feedstock to produce methanol. When tracking the flow of materials, the pretreatment, gasification, and gas cleaning steps were collected together into a single step titled “gasification.” Table 2 is a data specification sheet detailing the composition of the product gas produced by the IGT gasifier when wood is used as a feedstock. This data was taken from research done by Hamelinck and Faaij [6].

Table 2. Table of the product gas composition of the IGT gasifier using wood as a feedstock.

	IGT Gasifier
Gas yield (kmol/dry tonne bioimass)	82
Wet gas output composition: mol fraction	
H ₂ O	0.318
H ₂	0.208
CO	0.15
CO ₂	0.239
CH ₄	0.0819
C ₂ H ₄	0.0031
Total	1

Three different activities affect the flow of materials during the syngas processing step: reforming, water-gas shifting, and carbon dioxide scrubbing. Table 3 describes the chemical reactions that take place during reforming and water-gas shifting. The amount of carbon dioxide removed during carbon dioxide scrubbing can be controlled as desired. Only a small amount of carbon dioxide (2-10%) is wanted in the feed at the end of the

syngas processing step. The WTM model assumed a carbon dioxide content of 5% in the feed. Another constraint was presented by the ratio of the molar amounts of carbon monoxide, carbon dioxide, and hydrogen present in the feed before methanol synthesis.

The quantity

$$R = \frac{H_2 - CO_2}{CO + CO_2}$$

should have a minimal value of 2.03 to ensure the stoichiometry of the chemical reactions that take place during methanol synthesis are satisfied.

Table 3. The chemical reactions that take place during reforming and the water-gas shift.

Process	Chemical Reactions
Reforming	$CH_4 + H_2O \rightarrow CO + 3H_2$
	$C_2H_4 + 2H_2O \rightarrow 2CO + 4H_2$
Water-gas Shift	$CO + H_2O \rightarrow CO_2 + H_2$

The following two reactions take place during methanol synthesis:

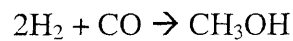

The WTM cost model also included a methanol refining step during methanol synthesis. It is assumed that 5% of the produced methanol is lost during refining. By combining all of the data, chemical reactions, constraints, and assumptions, a table tracking the flow of materials during each processing step was created given a certain methanol production volume. Table 4 is an example of a materials flow table showing the amounts of materials in each process step in kmol for a methanol production volume of 1000 tonnes. The required molar output from the IGT gasifier could then be calculated. This value was then converted into the required amount of dry biomass using the gas yield value of

82 kmol/dry tonne biomass presented in Table 2. The cost of the dry biomass required could then be calculated to determine the material costs.

Table 4. An example of a material flows table for a production volume of 1000 tonnes of methanol. Material amounts are given in kmol.

Step	H ₂ O	H ₂	CO	CO ₂	CH ₄	C ₂ H ₄	O ₂	MeOH
Gasification (In)	-	-	-	-	-	-	2222	-
Gasification (Out)	6180	4042	2915	4645	1592	60	0	0
Reforming (In)	6180	4042	2915	4645	1592	60	0	0
Reforming (Out)	4468	9058	4627	4645	0	0	0	0
Water Gas Shift (In)	4468	9058	4627	4645	0	0	0	0
Water Gas Shift (Out)	6941	11372	2314	6958	0	0	0	0
Scrubbing (In)	6941	11372	2314	6958	0	0	0	0
Scrubbing (Out)	6941	11372	2314	972	0	0	0	0
Synthesis (In)	6941	11372	2314	972	0	0	0	0
Synthesis (Out)	7913	3830	0	0	0	0	0	3285
Refining (In)	7913	3830	0	0	0	0	0	3285
Refining (Out)	0	0	0	0	0	0	0	0

5.2 Equipment Costs

Table 5 describes the component costs of the equipment used in the WTM process [7]. The equipment was planned to run for 8395 hours a year. It was assumed that the equipment would run 365 days a year and 23 hours a day. Each piece of equipment also had a certain amount of unplanned down time which needed to be deducted to determine the actual available time a year. The capacity of each component required for a given production volume of methanol was determined by observing the amount of material being passed through each step, which could be tracked with a materials flow table similar to the one in Table 4, and then dividing that amount by the actual available time for that particular piece of equipment. The cost of each component for a given capacity could then be calculated with the following equation:

$$\frac{Cost_a}{Cost_b} = \left(\frac{Size_a}{Size_b} \right)^R$$

where $Cost_a$ is the component base investment cost, $Size_a$ is the component base scale, $Cost_b$ is the investment cost for the component with the required capacity, $Size_b$ is the required capacity, and R is the scale factor. $Cost_b$ was then scaled by the overall installation factor to calculate the final component cost. If the required capacity for a component exceeded the maximum size, the appropriate number of lines was added and the corresponding costs for the additional lines were calculated. If a maximum size was not listed, the base scale was taken as the maximum size. Investments in equipment were to be paid over an equipment lifetime of 25 years at a discount rate of 15%.

Table 5. The component costs of the equipment used in the WTM process in MUS\$.

Step	Base investment cost (fob)	Scale factor	Base scale	Overall installation factor	Maximum size
Pretreatment					
Overall	8.15	0.79	33.5 wet tonne/h	1.86	110
Gasification					
IGT	38.1	0.7	68.8 dry tonne/h	1.69	75
Oxygen plant	44.2	0.85	41.7 tonne O ₂ /h	1	-
Gas cleaning					
Cyclones	2.6	0.7	34.2 m ³ gas/s	1.86	180
HT heat exchanger	6.99	0.6	39.2 kg steam/s	1.84	-
Baghouse filter	1.6	0.65	12.1 m ³ gas/s	1.86	64
Condensing scrubber	2.6	0.7	12.1 m ³ gas/s	1.86	64
Syngas processing					
Steam reformer	9.4	0.6	1390 kmol total/h	2.3	-
Shift reactor	36.9	0.85	15.6 Mmol CO+H ₂ /h	1	-
Selexol CO ₂ remover	54.1	0.7	9909 kmol CO ₂ /h	1	-
Steam plant	6.99	0.6	39.2 kg steam/s	1.84	-
Methanol production					
Liquid phase methanol	3.5	0.72	87.5 tonne MeOH/h	2.1	-
Refining	15.1	0.7	87.5 tonne MeOH/h	2.1	-

5.3 Labor Costs

Workers were paid a wage of \$20 an hour with a paid time of 7665 hours a year.

Table 6 displays the number of workers required for a particular piece of equipment. These values were used to estimate the number of workers required for the pieces of equipment used in the WTM process. Fractions of workers result from the fact that a worker does not necessarily have to be dedicated to a single piece of equipment.

Table 6. Number of workers required for particular pieces of equipment.

Equipment	Operators per Shift
Air plants	1
Boilers	1
Cooling towers	1
Water demineralizers	0.5
Portable generation plants	3
Incinerators	2
Mechanical refrigeration units	0.5
Waste water treatment plants	2
Evaporators	0.3
Vaporizers	0.05
Furnaces	0.5
Fans	0.05
Blowers and compressors	0.15
Heat exchangers	0.1
Towers	0.35
Reactors	0.5

5.4 Energy Costs

Electricity used to run the equipment was the energy input accounted for by the WTM cost model. The electricity requirements for the equipment used in the WTM process were estimated from data gathered by Hamelinck, Faaij, and Boding [6,8]. The price of electricity was set at \$0.05 per kilowatt hour. The rate of electricity consumption for each processing step is shown in Table 7. No electricity is needed for the gas cleaning step.

Table 7. Electricity requirements for the WTM process.

Step	Electricity Requirement
Pretreatment	44.8 kWh/wet tonne biomass
Gasification	77.2 kWh/dry tonne biomass
Syngas processing	30.4 kWh/dry tonne biomass
Methanol production	119.3 kWh/dry tonne biomass

5.5 Building Space Cost

The building space cost was calculated with the following equation:

$$Cost = 423 \times (tpd)^{1.147}$$

where tpd is the dry feed capacity of the IGT gasifier in tonnes per day [9]. Investments in building space were to be paid over a building space lifetime of 40 years with a discount rate of 12%.

5.6 Maintenance Costs

Maintenance costs for equipment and building space maintenance were calculated as 15% of the annual fixed costs for equipment and building space.

5.7 Overhead Costs

Overhead costs for equipment, building space, and maintenance were calculated as 15% of the annual fixed costs for equipment, building space, and maintenance.

6. MTO Cost Model

There is less information available on the MTO process. Much of the data used to construct the MTO cost model was referenced from research done by UOP [11]. The MTO cost model broke the process down into two sections: 1) the reactor section and 2) the product recovery section.

6.1 Material Costs

Approximately three tonnes of methanol are needed to produce one ton of olefins. Table 7 is a material balance of an 800,000 MTA MTO plant constructed by UOP. The ratio of propylene produced to ethylene produced was set at one. This ratio can be adjusted between 0.8 and 1.3. The ratio between the amount of methanol processed and the amount of olefins produced was used to calculate the amount of methanol needed to produce a given volume of olefins. The cost of the required methanol could then be calculated to determine the material costs. The catalyst used in the MTO process was considered a significant expense and was labeled as a processing material cost. The processing material cost was calculated as approximately 21% of the methanol feedstock cost.

Table 8. Material balance of UOP's 800,000 MTA MTO plant [11].

Material	Feed MTD	Products MTD
Methanol	7080	
Ethylene		1200
Propylene		1200
Butenes		370
C5+		137
Fuel Gas		120
Others (mostly water)		4053
Totals	7080	7080

6.2 Equipment Costs

Table 9 lists the pieces of equipment required for the MTO process. The total investment for equipment for UOP's 800,000 MTA MTO plant was \$230 million [11]. The costs for certain pieces of equipment used in the MTO process that had similar functions as the equipment in the WTM process were estimated by using the figures from Table 5. These estimated equipment costs were deducted from the \$230 million total and the remaining cost was divided proportionally among the unaccounted for pieces of equipment according to their capacities.

Table 9. Equipment list for UOP's MTO process.

Equipment	Estimated by
Fluidized-bed reactor	Liquid phase methanol reactor
Fluidized-bed regenerator	-
Separator	HT heat exchanger
Caustic scrubber	Selexol CO ₂ remover
Dryer	HT heat exchanger
Demethanizer	-
Deethanizer	-
C ₂ splitter	-
C ₃ splitter	-
Depropanizer	-

6.3 Labor Costs

Workers were paid a wage of \$20 an hour with a paid time of 7665 hours a year. A similar approach was taken to estimate the labor costs for the MTO process by using the data from Table 6 to determine the number of workers needed for each piece of equipment.

6.4 Energy Costs

Electricity used to run the equipment was the energy input accounted for by the MTO cost model. The price of electricity was set at \$0.05 per kilowatt hour. The overall

rate of consumption for the MTO process was estimated to be 65 kilowatt hours per tonne of olefins produced [15].

6.5 Building Space Costs

The building space was estimated to cost \$4.08 per tonne of methanol processed [9]. Investments in building space were to be paid over a building space lifetime of 40 years with a discount rate of 12%.

6.6 Maintenance Costs

Maintenance costs for equipment and building space maintenance were calculated as 15% of the annual fixed costs for equipment and building space.

6.7 Overhead Costs

Overhead costs for equipment, building space, and maintenance were calculated as 15% of the annual fixed costs for equipment, building space, and maintenance.

7. WTM Cost Model Analysis

The following sensitivity analyses were done on the WTM cost model: 1) product cost versus production volume, 2) product cost versus investments in equipment, 3) product cost versus biomass feedstock price, and 4) product cost versus production volume and biomass feedstock price. The general purpose of the analyses was to determine under what operating conditions the WTM technology would be competitive. This was done by comparing the product cost to the 2003 methanol price of \$85 per tonne [11].

7.1 Product Cost Versus Production Volume

The biomass feedstock price was set at \$31.76 per tonne for this analysis [7]. It can be seen from Figure 5 that the WTM technology is far from being competitive when compared to the price of methanol of \$85 per tonne. Even at higher production volumes the production costs levels off around \$250 per tonne of methanol produced.

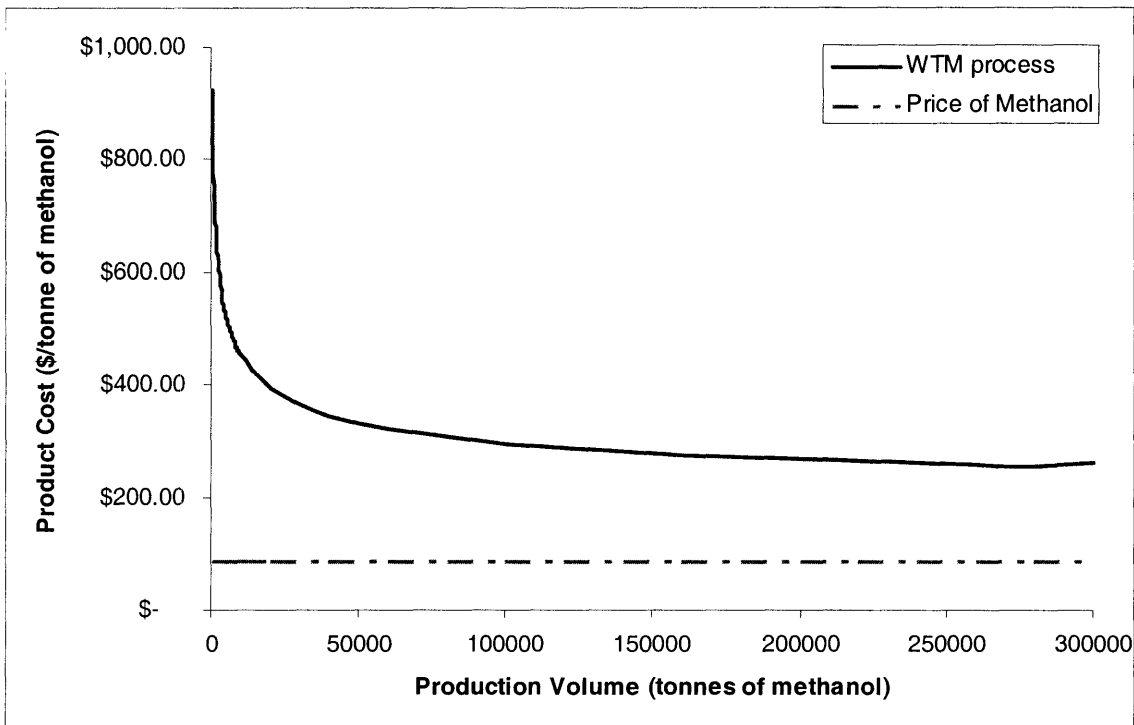

Figure 5. Product cost versus production volume for the WTM cost model.

7.2 Product Cost Versus Investments in Equipment

A factor varying from 0 to 2.0 was used to scale the aggregate equipment costs. A factor value of 1.0 indicates the baseline equipment costs. Figure 6 displays the product cost plotted against the investments in equipment costs for methanol production volumes of 10,000 tonnes and 250,000 tonnes. It can be seen that even if there were no equipment costs, the WTM technology still is not competitive with the price of methanol.

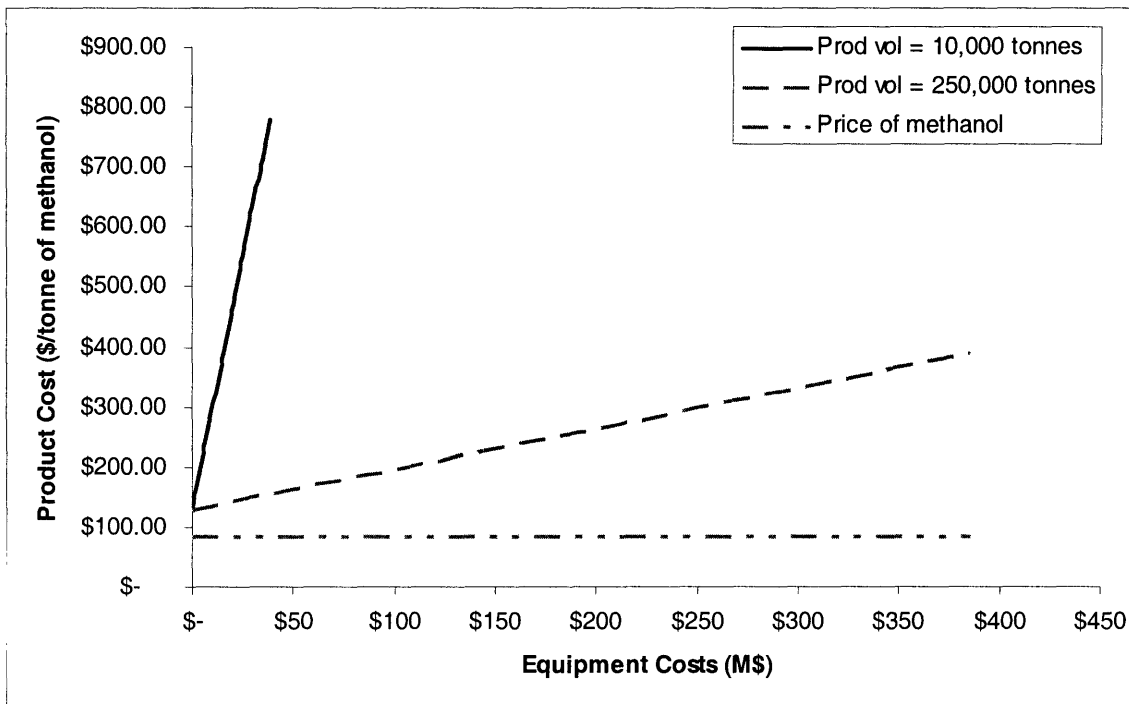

Figure 6. Product cost versus equipment costs for methanol production volumes of 10,000 and 250,000 tonnes.

7.3 Product Cost Versus Biomass Feedstock Price

The biomass feedstock price was varied from \$32 per tonne of biomass to \$(100) per tonne of biomass. The negative feedstock price represents a fee for collecting biomass waste. Figure 7 displays the product cost versus biomass feedstock price for methanol production volumes of 10,000 and 250,000 tonnes.

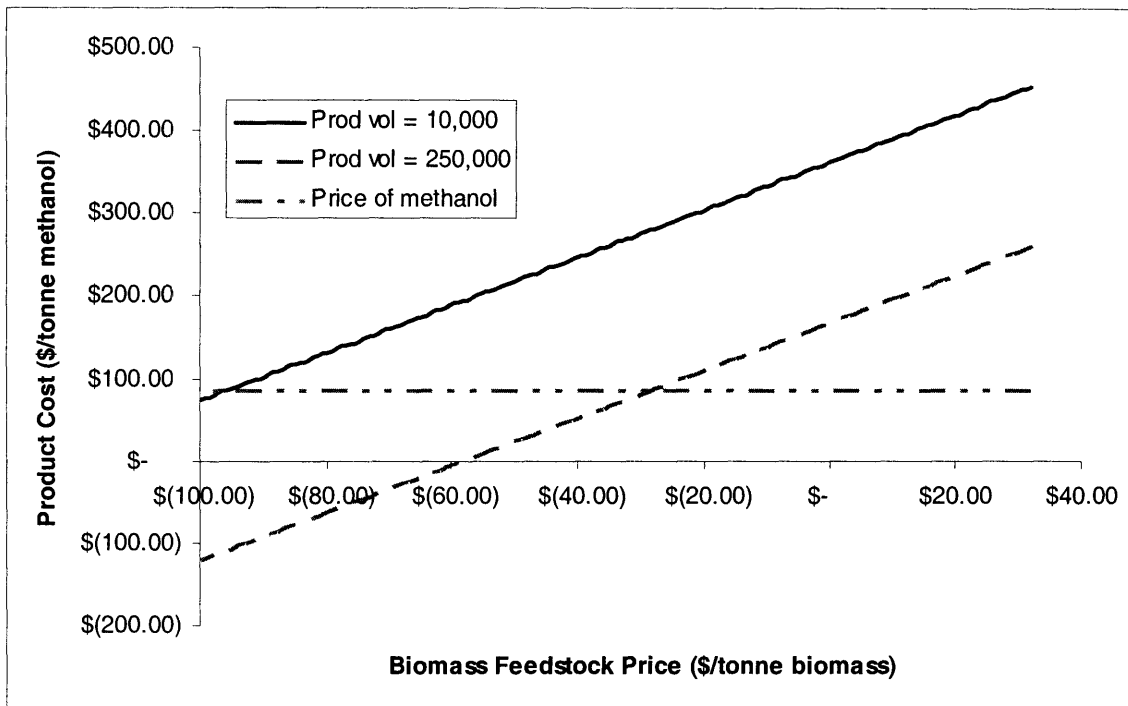

Figure 7. Product cost versus biomass feedstock price for methanol production volumes of 10,000 and 250,000 tonnes.

7.4 Product Cost Versus Production Volume and Biomass Feedstock Price

Methanol production volumes were varied from 0 to 1,000,000 tonnes. The biomass feedstock price was varied from \$30 per tonne of biomass to \$(100) per tonne of biomass. Figure 8 displays the product cost versus production volume and biomass feedstock price. Region I represents the combination of production volumes and biomass feedstock prices that result in product costs of \$85 per tonne of methanol produced or less. Region II represents the combination of production volumes and biomass feedstock prices that result in products costs of greater than \$85 per tonne of methanol produced.

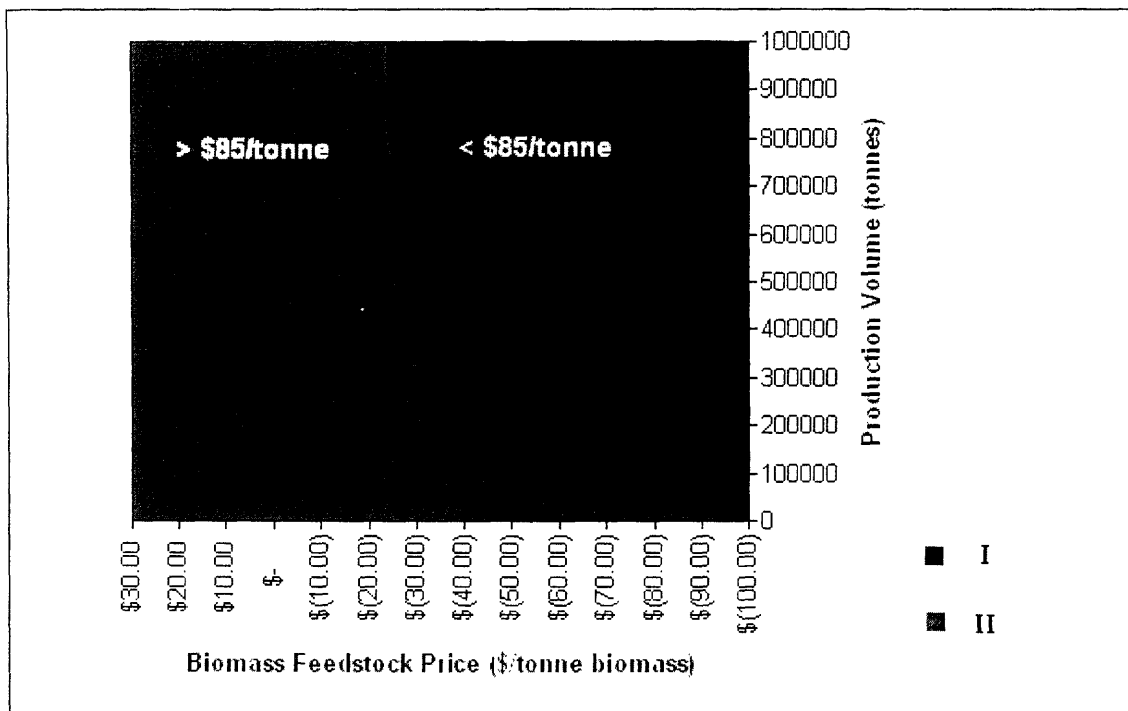

Figure 8. Product cost versus production volume and biomass feedstock price.

8. MTO Cost Model Analysis

The following analyses were done on the MTO cost model: 1) product cost versus production volume, 2) product cost versus varied investments in equipment, 3) product cost versus methanol feedstock price, and 4) product cost versus production volume and methanol feedstock price. The general purpose of the analyses was to determine under what operating conditions the MTO technology would be competitive. This was done by comparing the product cost to the 2004 average olefin price of \$723 per tonne [16].

8.1 Product Cost Versus Production Volume

The methanol feedstock price was set at \$85 per tonne for this analysis. It can be seen from Figure 9 that the MTO process is competitive with olefin prices when production volumes are greater than 7,000 tonnes of olefins.

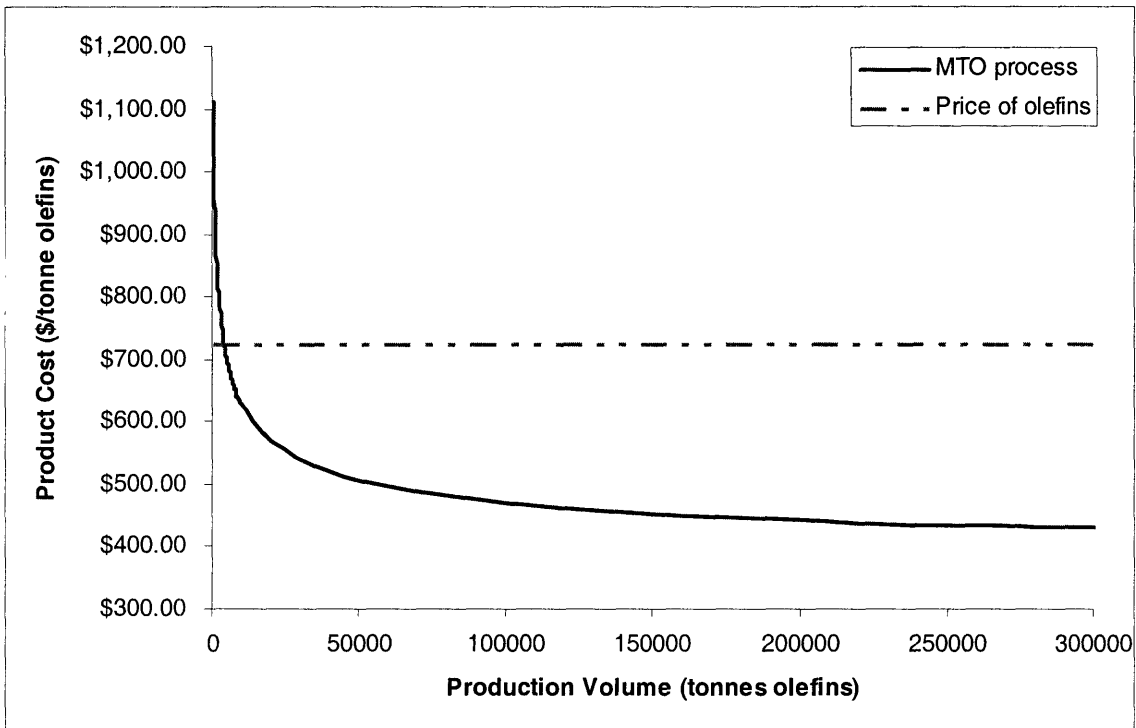

Figure 9. Product cost versus production volume for the MTO process.

With even higher production volumes, the product cost levels off to around \$400 per tonne of olefins produced.

8.2 Product Cost Versus Investments in Equipment

A factor varying from 0 to 2.0 was used to scale the aggregate equipment costs. A factor value of 1.0 indicates the baseline equipment costs. Figure 10 displays the product cost plotted against the varied investments in equipment costs for methanol production volumes of 10,000 tonnes and 250,000 tonnes. It can be seen that the MTO technology is always competitive with the price of olefins for an olefins production of 250,000 tonnes. In the case when the production volume is 10,000 tonnes of olefins, the product cost exceeds the price of olefins when the equipment costs are scaled by a factor of approximately 1.35 or greater.

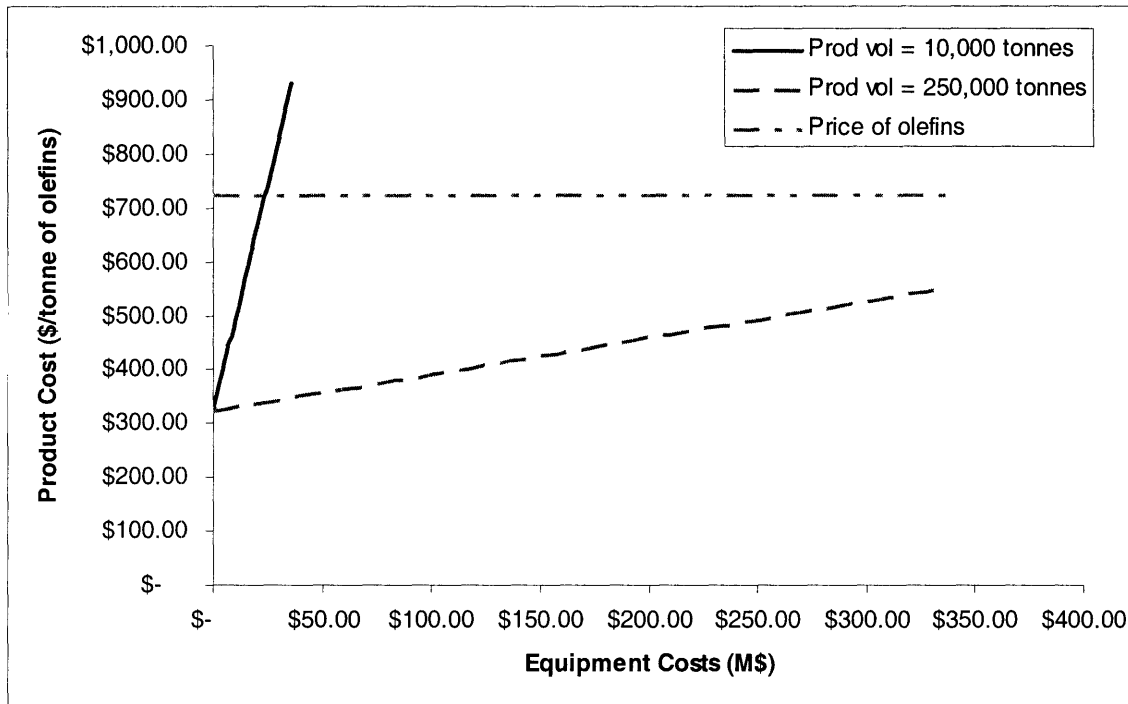

Figure 10. Product cost versus varied investments in equipment for olefin production volumes of 10,000 and 250,000 tonnes.

8.3 Product Cost Versus Methanol Feedstock Price

The methanol feedstock price was varied from \$85 per tonne of methanol to \$0 per tonne of methanol. At a production volume of 10,000 tonnes, the MTO technology loses its competitiveness at a methanol price of approximately \$117 per tonne or greater. At a production volume of 250,000 tonnes, the MTO technology loses its competitiveness at a methanol price of approximately \$182 per tonne or greater.

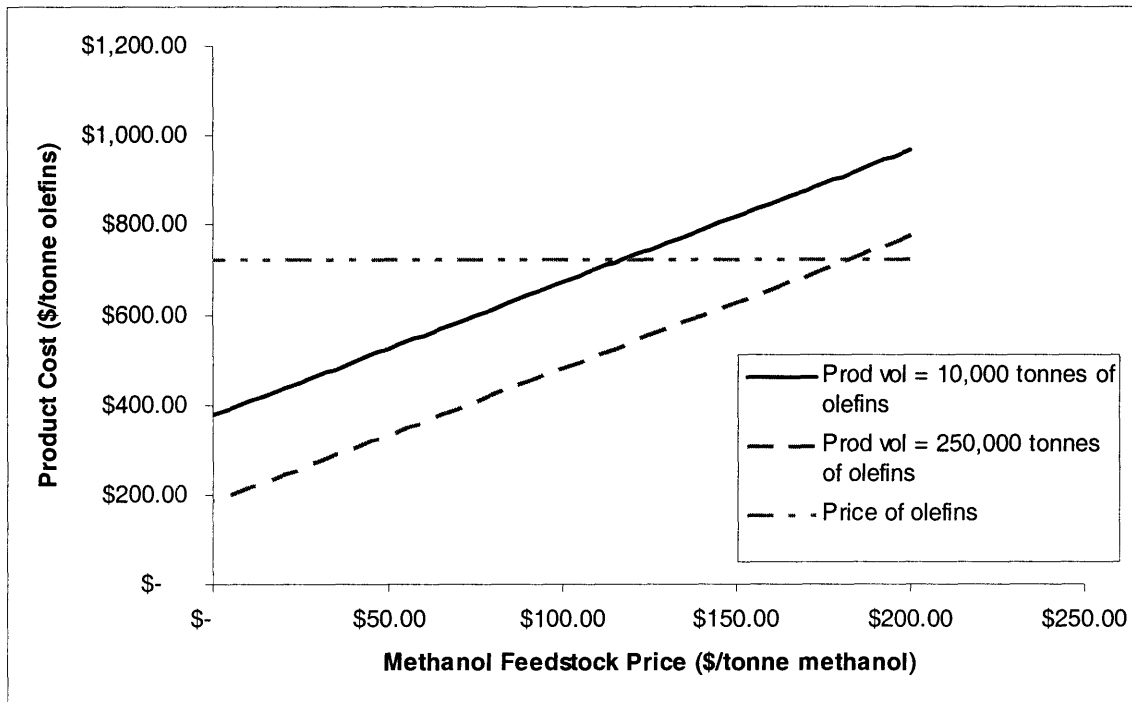

Figure 11. Product cost versus methanol feedstock price for olefin production volumes of 10,000 and 250,000 tonnes.

8.4 Product Cost Versus Production Volume and Methanol Feedstock Price

Olefin production volumes were varied from 0 to 1,000,000 tonnes. The methanol feedstock price was varied from \$200 per tonne to \$0 per tonne. Figure 12 displays the product cost versus production volume and biomass feedstock price. Region I represents the combination of production volumes and biomass feedstock prices that result in product costs of \$723 per tonne of olefins produced or less. Region II represents

the combination of production volumes and biomass feedstock prices that result in products costs of greater than \$723 per tonne of olefins produced.

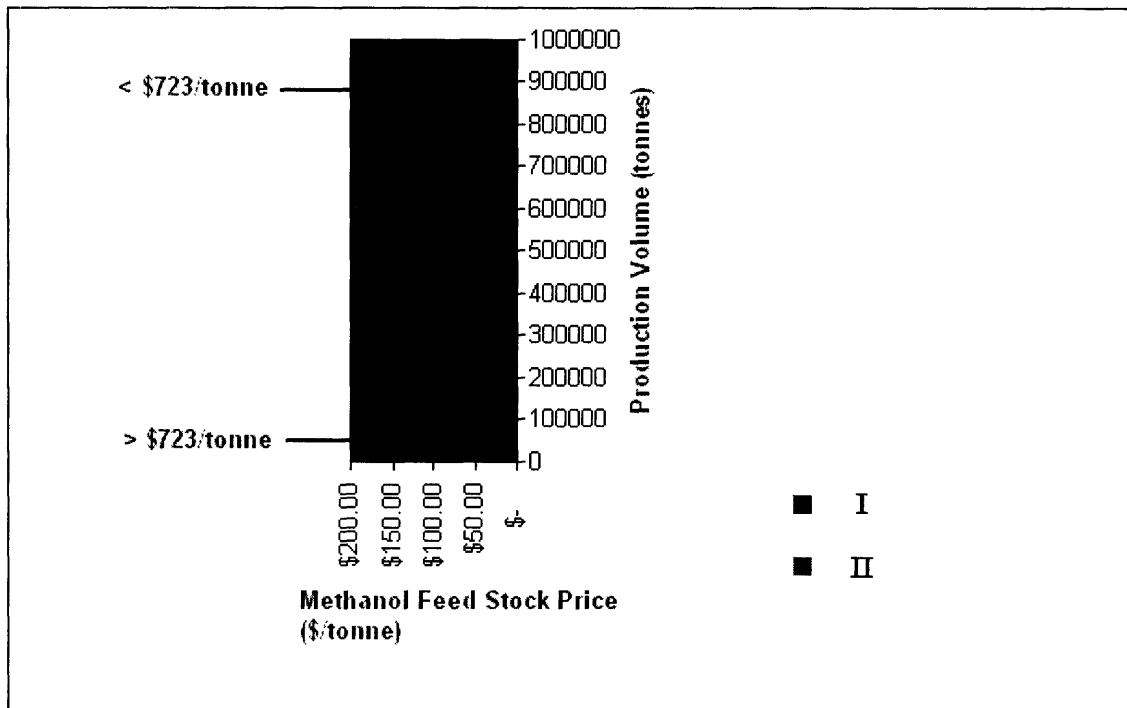

Figure 12. Product cost versus production volume and methanol feedstock price.

9. Analysis of WTM and MTO Cost Models Combined

The WTM and MTO cost models were combined and the following analyses were done: 1) olefin product cost versus olefin production volume, 2) olefin product cost versus biomass feedstock price, and 3) olefin product cost versus olefin production volume and biomass feedstock price. The general purpose of the analyses was to determine under what operating conditions the waste to olefins technology would be competitive. This was done by comparing the olefin product cost to the average olefin price of \$723 per tonne. The methanol production volume of the WTM process was set by the methanol required to produce a given volume of olefins with the MTO process. The methanol feedstock price was set by the methanol product cost of the WTM process.

9.1 Olefin Product Cost Versus Olefin Production Volume

The biomass feedstock price was set at \$31.76 per tonne for this analysis [7]. It can be seen from Figure 5 that the waste to olefins technology is far from being

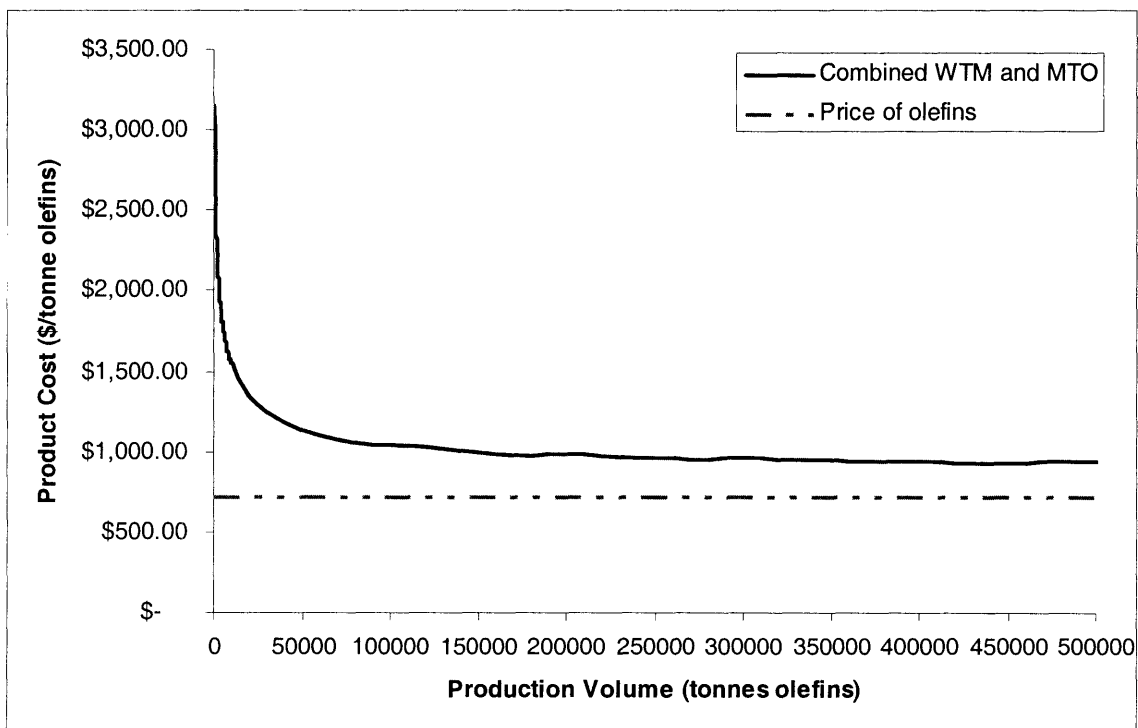

Figure 13. Olefin product cost versus olefin production volume for the waste to olefins process.

competitive when compared to the average price of olefins of \$723 per tonne. Even at higher production volumes the olefin production costs levels off around \$930 per tonne of methanol produced.

9.2 Olefin Product Cost Versus Biomass Feedstock Price

The biomass feedstock price for the WTM process was varied from \$32 per tonne of biomass to \$(100) per tonne of biomass. The negative feedstock price represents a fee for collecting biomass waste. Figure 14 displays the olefin product cost versus biomass feedstock price for olefin production volumes of 20,000 and 450,000 tonnes. For an olefin production volume of 20,000 tonnes, the WTO process becomes competitive when the biomass feedstock price is \$(33) per tonne or less. For an olefin production volume of 450,000 tonnes, the WTO process becomes competitive when the biomass feedstock price is \$14 per tonne or less.

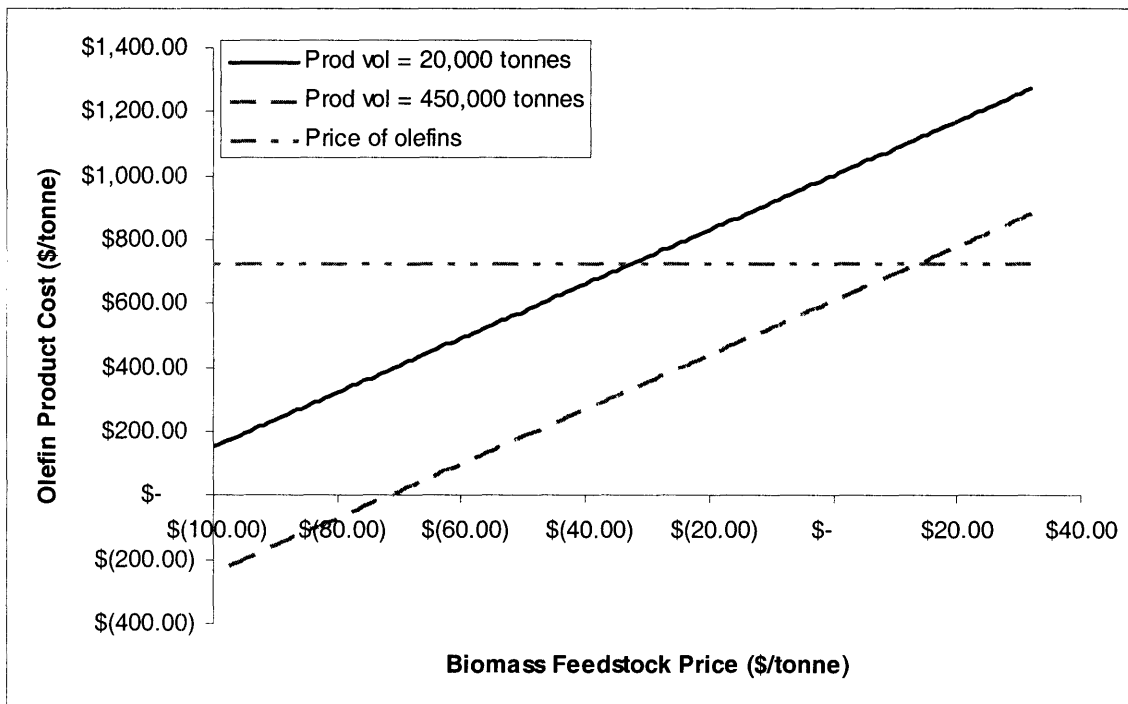

Figure 14. Olefin product cost versus biomass feedstock price for olefin production volumes of 20,000 and 450,000 tonnes.

9.3 Olefin Product Cost Versus Olefin Production Volume and Biomass Feedstock Price

Olefin production volumes were varied from 0 to 1,000,000 tonnes. The biomass feedstock price was varied from \$30 per tonne of biomass to \$(100) per tonne of biomass. Figure 15 displays the olefin product cost versus olefin production volume and biomass feedstock price for the WTO process. Region I represents the combination of production volumes and biomass feedstock prices that result in olefin product costs of \$723 per tonne of olefins produced or less. Region II represents the combination of production volumes and biomass feedstock prices that result in olefin products costs of greater than \$723 per tonne of olefins produced.

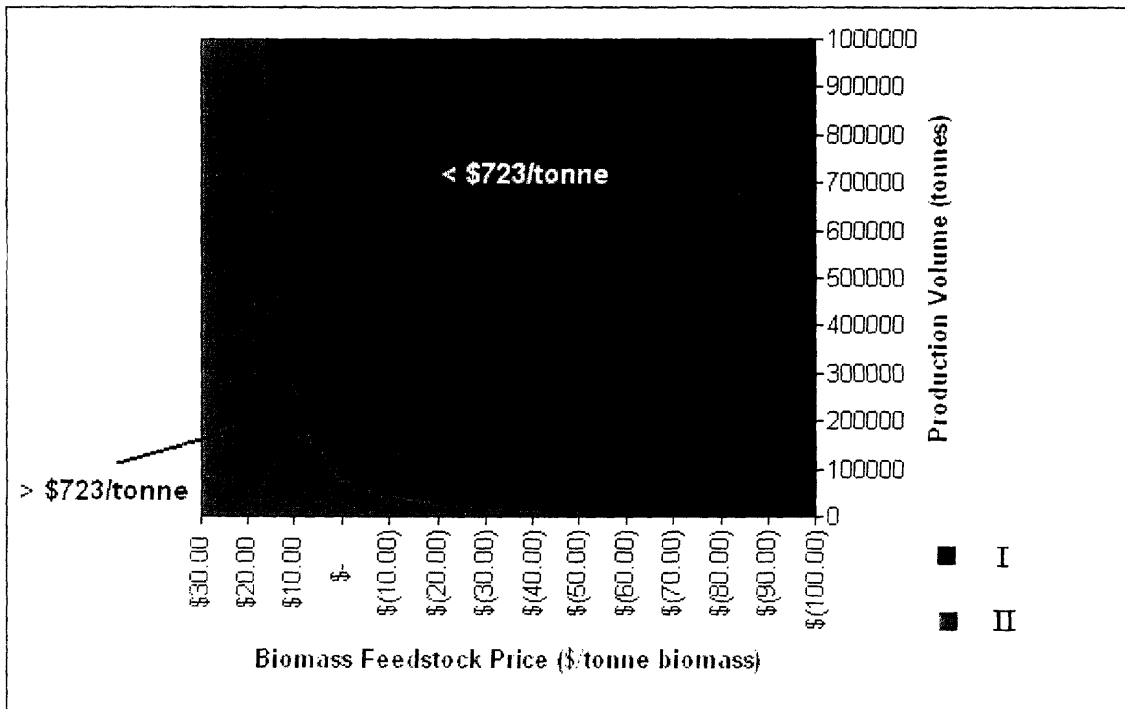

Figure 15. Olefin product cost versus olefin production volume and biomass feedstock price for the WTO process.

10. Conclusion

The WTM technology is only competitive if the biomass feedstock can be obtained at a negative price. A fee of approximately \$28 per tonne of biomass waste would need to be collected to make the WTM technology competitive. With a set methanol feedstock price of \$85 per tonne, the MTO technology is competitive over a wide range of production volumes. Only at olefin production volumes at approximately 7,000 tonnes or less does it fail to be competitive. When combining the WTM and MTO cost models to analyze the WTO technology, the WTM process is the economically limiting factor. Despite this fact, for relatively significant olefin production volumes, the WTO remains competitive with a slight decrease in biomass feedstock price.

More detailed information on the MTO process is needed to construct a more accurate cost model. In particular, more information is needed to provide better estimates for the costs of the catalyst and equipment used for the MTO process. The accuracies of both the WTM and MTO cost models should also be explored further.

Further research on the environmental advantages of WTO technology should be conducted. It would also be interesting to explore the use of other materials besides wood as a possible source of biomass waste feedstock.

11. References

1. [www.nationmaster.com](http://www.nationmaster.com/graph-T/ene_oil_con). (n.d.). Retrieved August 9, 2005, from, http://www.nationmaster.com/graph-T/ene_oil_con
2. U.S. Department of Energy, Energy Efficiency and Renewable Energy. (November 19, 2005). Retrieved August 9, 2005, from, http://www.eere.energy.gov/vehiclesandfuels/facts/favorites/fcvt_fotw191.shtml
3. Walsh, Tom and Kuhlke Bill. World Plastics Market Review. (n.d.). Retrieved August 9, 2005, from <http://www.polymerplace.com/articles/World%20Plastics%20Review.pdf>
4. Ener1, Press Release section. (March 21,2005). Retrieved August 9, 2005, from <http://www.ener1.com/pr.html>
5. Keil, Frerich J. "Methanol-to-hydrocarbons: process technology." *Microporous and Mesoporous Materials* 29 (1999) 49-66.
6. Hamelinck, C.N. and A.P.C. Faaij (2001). "Future Prospects for Production of Methanol and Hydrogen from Biomass." Utrecht, The Netherlands, Copernicus Institute.
7. Hamelinck, C.N. and A.P.C. Faaij (2002). "Future Prospects for Production of Methanol and Hydrogen from Biomass." *Journal of Power Sources*. 111(1): 1-22.
8. Boding, H., P. Ahlvik, et al. (2003). *BioMeeT II: Stakeholders for Biomass-based Methanol/DME/Power/Heat Energy Combine*. Stockholm, Sweden, Ecotraffic R&D AB.
9. Williams, R.H., E.D. Larson, et al. (1995). "Methanol and Hydrogen from Biomass for Transportation, with Comparisons to Methanol and Hydrogen from Natural Gas and Coal." Center for Energy and Environmental Studies, Princeton University.
10. U.S. Department of Energy, Office of Fossil Energy. (n.d.). Retrieved August 3, 2005, from, http://www.fossil.energy.gov/programs/powersystems/cleancoal/tl_liqphase_schematic.html
11. Andersen, J., S. Bakas, et al. (2003). "MTO: Meeting the Needs for Ethylene and Propylene Production." ERTC Petrochemical Conference, Paris, France.
12. Kirchain, Randolph and Field III, Frank R. "Process-based Cost Modeling: Understanding the Economics of Technical Decisions." Materials Systems Laboratory, Massachusetts Institute of Technology.

13. Johnson, Michael D. (2004). "A Methodology for Determining Engineering Costs and Their Effects on the Development of Product Families." Department of Mechanical Engineering, Massachusetts Institute of Technology.
14. Kirchain, Randolph. "Fundamentals of Process-based Cost Modeling: 3.57 lecture notes." Materials Systems Laboratory, Massachusetts Institute of Technology.
15. Joosten, L.A.J. (1998). "Process Data Descriptions for the Production of Synthetic Organic Materials: Input Data for the MATTER Study." Utrecht, The Netherlands, Utrecht University.
16. Lyondell Chemical Co. annual report. (March 16, 2005). Retrieved August 4, 2005, from, <http://biz.yahoo.com/e/050316/lyo10-k.html>