

**OBSERVATION AND ANALYSIS OF  
DEPARTURE OPERATIONS AT  
BOSTON LOGAN INTERNATIONAL AIRPORT**

Husni R. Idris and R. John Hansman

Report No. ICAT-2000-7  
November 2000

***MIT International Center for Air Transportation  
Department of Aeronautics & Astronautics  
Massachusetts Institute of Technology  
Cambridge, MA 02139 USA***



# **OBSERVATION AND ANALYSIS OF DEPARTURE OPERATIONS AT BOSTON LOGAN INTERNATIONAL AIRPORT**

**HUSNI R. IDRIS AND R. JOHN HANSMAN, JR.**

## **Abstract**

The Departure Planner (DP) is a concept for a decision-aiding tool that is aimed at improving the departure operations performance at major congested airports. In order to support the development of the DP tool, the flow constraints and their causalities in the departure process - primarily responsible for generating inefficiencies and delays- need to be identified. This thesis is an effort to identify such flow constraints and gain a deep understanding of the underlying dynamics of the departure process based on field observations and data analysis at Boston Logan International Airport. It was observed that the departure process is a complex interactive queuing system, where aircraft queues form as a manifestation of the flow constraints. While departure delays were observed in all airport components (runways, taxiways, ramps and gates), it was concluded that the flow constraints manifest mainly at the runway system, which exhibits the largest delays and queues. Major delays and inefficiencies were also observed due to downstream flow constraints, which propagate back and block the departure flow from the airport. It was also observed that the airport system is a highly controlled system as the air traffic controllers manage the flow constraints. The air traffic controllers were, therefore, identified as another flow constraint due to their workload and their main strategies in managing the flow constraints were observed. Based on the observations, a core departure process was identified consisting of two main elements: a queuing element generated by the flow constraints and a control element representing the air traffic controller actions. This core process was abstracted using a controlled queuing framework, where the air traffic controller actions are represented by blocking the flow of aircraft in order to maintain safe operation of the airport resources according to the ATC rules and procedures and regulate the outbound flow to constrained downstream resources. The controlled queuing framework was used to analyze the departure process highlighting the queuing dynamics and the control behavior for different flow constraint examples. In conclusion, a number of implications for the Departure Planner and other improved methods for departure operations are inferred from the observations and analysis.

*This document is based on the thesis of Husni R. Idris submitted to the Department of Mechanical Engineering at the Massachusetts Institute of Technology in partial fulfillment of the requirements for the degree of Doctor of Philosophy in Human Factors and Automation.*



## **Acknowledgements**

This work was supported by the National Aeronautics and Space Administration Ames Research Center under grant NAG 2-1128. The authors would also like to acknowledge the Boston Control Tower and TRACON for their cooperation and courtesy in providing access for field observations and to various logs and data sources. Special thanks to the Control Tower chief Mr. Joe Davies, to the Control Tower managers Mr. Ronald Crossman and Mr. Donald Crossman, to the Control Tower supervisor Mr. Michael Hilliard, to the Traffic Management Coordinator Mr. Michael Lahey, and to all the Control Tower supervisors and controllers for their invaluable time, knowledge, courtesy and support.



# Table Of Content

<b>CHAPTER 1 INTRODUCTION .....</b>	<b>11</b>
1.1 MOTIVATION.....	11
1.1.1 <i>The Departure Planner</i> .....	12
1.1.2 <i>The task of the thesis</i> .....	14
1.2 THE DEPARTURE PROCESS SYSTEM.....	15
1.2.1 <i>The airport system in the NAS</i> .....	15
1.2.2 <i>The airport system components</i> .....	16
1.2.3 <i>The departure process</i> .....	17
1.3 THE PROBLEM STATEMENT.....	19
1.4 BACKGROUND AND PRIOR RESEARCH.....	21
1.5 APPROACH.....	23
1.6 THESIS OUTLINE.....	24
<b>CHAPTER 2 METHODOLOGY OF OBSERVATIONS .....</b>	<b>25</b>
2.1 PRELIMINARY GENERAL OBSERVATIONS.....	26
2.1.1 <i>Logan Airport general description</i> .....	26
2.1.2 <i>Overview of the Control Tower</i> .....	29
2.2 AVAILABLE AND COLLECTED DATA.....	34
2.2.1 <i>Aircraft movement data</i> .....	34
2.2.2 <i>Airport conditions data</i> .....	41
2.2.3 <i>Manuals</i> .....	43
2.3 SYSTEM IDENTIFICATION THROUGH FOCUSED OBSERVATIONS.....	43
2.3.1 <i>Identification of the queuing networks and flow constraints</i> .....	44
2.3.2 <i>Elicitation of air traffic controllers' strategies</i> .....	44
<b>CHAPTER 3 OBSERVATION AND FLOW CONSTRAINT ANALYSIS OF THE DEPARTURE PROCESS AT LOGAN AIRPORT.....</b>	<b>47</b>
3.1 OVERVIEW OF THE AIRPORT SYSTEM FLOW CONSTRAINTS.....	48
3.2 STRATEGIC RUNWAY CONFIGURATION SELECTION PROCESS.....	50
3.2.1 <i>Runway configuration flow patterns and operating rules</i> .....	50
3.2.2 <i>Runway configuration capacity envelopes</i> .....	52
3.2.3 <i>Arrival/departure tradeoff and operating modes</i> .....	55
3.2.4 <i>Runway configuration selection factors</i> .....	57
3.3 FLOW CONSTRAINTS AND THEIR MANAGEMENT IN THE AIRCRAFT MOVEMENT PROCESS.....	62
3.3.1 <i>An interactive queuing system (27/22L-22R/22L example)</i> .....	62
3.3.2 <i>A controlled queuing system</i> .....	66
3.3.3 <i>Operation of a single airport resource</i> .....	69
3.3.4 <i>Blocking and flow regulation between interacting resources</i> .....	74
3.4 FLOW CONSTRAINTS AND THEIR CAUSAL FACTORS.....	78
3.4.1 <i>Flow constraints manifest mainly at the runway</i> .....	79
3.4.2 <i>Downstream flow constraints</i> .....	99

3.4.3	<i>Flow constraint manifestation at the gates</i> .....	124
3.4.4	<i>Flow Constraint manifestation in the taxiway and ramp</i> .....	135
<b>CHAPTER 4</b>	<b>CONTROLLED QUEUING: MODELING AND ANALYSIS</b> .....	<b>139</b>
4.1	OVERVIEW OF THE CONTROLLED QUEUING MODEL.....	140
4.2	ANALYTICAL FRAMEWORK .....	142
4.2.1	<i>The departure process system</i> .....	142
4.2.2	<i>Lumped element representation of the departure process</i> .....	143
4.2.3	<i>Analysis of the time in the system</i> .....	144
4.3	QUEUING DYNAMICS OF THE OVERALL DEPARTURE PROCESS.....	152
4.3.1	<i>FCFS queuing dynamics</i> .....	153
4.3.2	<i>Passing dynamics</i> .....	156
4.3.3	<i>Overall queuing dynamics</i> .....	159
4.4	QUEUING DYNAMICS OF THE COMMUNICATION-BASED DEPARTURE SUB-PROCESSES .....	162
4.4.1	<i>Time versus queue size dynamics</i> .....	166
4.4.2	<i>Control points and opportunities</i> .....	168
4.5	QUEUING DYNAMICS UNDER DOWNSTREAM FLOW CONSTRAINTS.....	169
4.5.1	<i>Takeoff time window control</i> .....	171
4.5.2	<i>The “Splitter” sequencing problem</i> .....	174
<b>CHAPTER 5</b>	<b>CONCLUSIONS AND IMPLICATIONS</b> .....	<b>175</b>
5.1	SUMMARY OF OBSERVATIONS AND RESULTS .....	175
5.1.1	<i>Interactive queuing system</i> .....	175
5.1.2	<i>Queuing system with controlled blocking</i> .....	176
5.1.3	<i>Identification of major departure flow constraints</i> .....	177
5.1.4	<i>Identification of controller strategies</i> .....	179
5.1.5	<i>Lack of observability and high uncertainty</i> .....	180
5.2	IMPLICATIONS FOR DEPARTURE PLANNING.....	181
5.2.1	<i>Demand matching at the strategic level</i> .....	181
5.2.2	<i>Environmental impact through reduced taxi out time</i> .....	181
5.2.3	<i>Improved runway operation efficiency</i> .....	182
5.2.4	<i>Improved downstream restriction management</i> .....	183
5.2.5	<i>Improved gate operation management</i> .....	184
5.2.6	<i>Improved efficiency through better information</i> .....	185
5.2.7	<i>Improved controller workload</i> .....	186
5.2.8	<i>Integrated system of automation tools</i> .....	186
<b>APPENDIX A</b> .....		<b>188</b>
<b>APPENDIX B</b> .....		<b>190</b>
<b>REFERENCES</b> .....		<b>192</b>



# List of Figures

Figure 1.1: Traffic growth at Logan International Airport (from Delcaire) .....	12
Figure 1.2: The Departure Planner .....	13
Figure 1.3: The airport system in the NAS .....	15
Figure 1.4: The airport system (including the terminal airspace).....	16
Figure 1.5: The departure process system and subsystems.....	18
Figure 1.6: The departure process control.....	19
Figure 2.1: Logan International Airport (aerial view, from Delcaire).....	27
Figure 2.2: Logan Airport diagram (from US Terminal Procedures, Jan 1999).....	28
Figure 2.3: Control Tower at Logan Airport.....	30
Figure 2.4: The Control Tower structure .....	30
Figure 2.5: A flight progress strip example (from FAA, BOS TWR 7110.11H).....	33
Figure 2.6: ACARS delay categories for one major airline .....	35
Figure 2.7: The departure process based on the ASQP events.....	37
Figure 2.8: Departure communication-based sub-processes.....	39
Figure 2.9: Excerpt from a TMC log .....	42
Figure 2.10: Excerpt from a restriction log .....	43
Figure 3.1: The airport system main components .....	48
Figure 3.2: Runway assignment and flow patterns under different runway configurations .....	51
Figure 3.3: Capacity envelopes under different runway configurations.....	53
Figure 3.4: Operating modes for short-term demand matching (ADP).....	56
Figure 3.5: The strategic runway configuration selection process .....	58
Figure 3.6: Weather effects on the runway configuration selection process .....	59
Figure 3.7: Demand and noise effects on the runway configuration selection .....	60
Figure 3.8: Observed queuing network under the 27/22L-22R/22L runway configuration .....	63
Figure 3.9: Aircraft movement process as a controlled, interactive queuing system .....	68
Figure 3.10: Single airport resource operation .....	70
Figure 3.11: The clearance/holding mechanism.....	71
Figure 3.12: Sequencing, suspending and routing.....	73
Figure 3.13: Blocking in an open loop queuing system.....	75
Figure 3.14: Blocking through feedback and the ATC control mechanism .....	77
Figure 3.15: Takeoff queue for runway 22R.....	79
Figure 3.16: Communication analysis .....	81
Figure 3.17: Throughput saturation of the runway system .....	82
Figure 3.18: ACARS pilot delay reports during taxi out .....	83
Figure 3.19: Runway and wake vortex separation requirements for same runway departures (FAAH 7110.65L).....	85
Figure 3.20: Effect of the wake vortex separation requirement on the time between takeoff clearances.....	86
Figure 3.21: Arrival runway crossing queues for runway 22R .....	89
Figure 3.22: Effect of runway crossing on the time between takeoff clearances.....	90
Figure 3.23: Delay of runway 22L takeoffs due to higher priority landings on the same runway.....	91
Figure 3.24: Sequencing departures in the runway 22R takeoff queue .....	93

Figure 3.25: Effect of the number of runway crossings on the time between takeoff clearances.	94
Figure 3.26: The parallel aircraft and flight progress strip queuing processes .....	95
Figure 3.27: Local controller communication taskload .....	96
Figure 3.28: Runway configuration change .....	98
Figure 3.29: The flow management process under downstream flow constraints .....	100
Figure 3.30: The traffic flow management system (from FAA, Course 50115).....	101
Figure 3.31: Destination restrictions' effect on departure delays.....	107
Figure 3.32: Destination restrictions' effect on departure throughput.....	108
Figure 3.33: Destination restrictions' effect on departure congestion.....	110
Figure 3.34: Local weather restrictions' effect on departure throughput .....	112
Figure 3.35: Exit fixes from Logan Airport .....	113
Figure 3.36: Local weather restrictions' effect on departure delays .....	114
Figure 3.37: Local weather restrictions' effect on departure congestion.....	115
Figure 3.38: Arrival and departure rate reduction under local weather restrictions.....	116
Figure 3.39: Mean value analysis of downstream restrictions' effect on departure throughput .	118
Figure 3.40: Local GS effect on departure throughput.....	119
Figure 3.41: Mean value analysis of downstream restrictions' effect on departure delays .....	120
Figure 3.42: Downstream restrictions' effect as a function of number of restricted aircraft.....	123
Figure 3.43: ACARS pilot delay reports during taxi in.....	125
Figure 3.44: The gate layout at Logan Airport (from Delcaire).....	126
Figure 3.45: Departure on-gate operations and lack of ATC observability.....	127
Figure 3.46: Uncertainty in the departure schedule.....	128
Figure 3.47: Gate utilization and overflow gates .....	130
Figure 3.48: Suspended aircraft.....	131
Figure 3.49: The "horse shoe" gate alley (limited capacity for pushback).....	132
Figure 3.50: Taxiway blocking by pushback .....	133
Figure 3.51: Ground controller communication load .....	134
Figure 3.52: Conflict due to a blocked alley .....	136
Figure 3.53: Taxi queue due to a blocked alley.....	136
Figure 4.1: The basic elements of the departure process .....	141
Figure 4.2: Departure process system.....	143
Figure 4.3: Lumped element representation of the departure process system .....	144
Figure 4.4: FCFS and passing queue components.....	149
Figure 4.5: Analysis and control of the time in the system.....	151
Figure 4.6: Overall departure process system based on the ACARS measurements .....	152
Figure 4.7: FCFS queuing dynamics .....	153
Figure 4.8: Effective service time distribution.....	155
Figure 4.9: FCFS and passing components of overall queuing dynamics .....	157
Figure 4.10: Passing effect on taxi out time.....	159
Figure 4.11: Overall queuing dynamics.....	160
Figure 4.12: Queuing dynamics of the communication-based sub-processes .....	164
Figure 4.13: Time in the system of the communication-based sub-processes .....	165
Figure 4.14: Queuing dynamics under downstream restrictions .....	170
Figure 4.15: Aircraft sequencing under downstream restrictions.....	171
Figure 4.16: Closed-loop time window control.....	172

# CHAPTER 1

## INTRODUCTION

While the air travel demand has increased dramatically, and is expected to keep increasing at a high rate<sup>1</sup>, the American National Airspace System (NAS) is reaching capacity limitations. This is particularly true at major airports; for example at Boston Logan International Airport, the traffic has increased substantially over the past 20 years as shown in Figure 1.1<sup>2</sup>. As a result, major airports and airspace sectors are experiencing high congestion and costly delays. The Federal Aviation Administration (FAA) estimated the total delay costs in 1994 at about 9.5 billion dollars (Delcaire). Most importantly, as the number of aircraft in a given airspace region increases, the workload of the air traffic controllers increases, and maintaining safety – which is the main task of the Air Traffic Control system – becomes a critical concern.

### 1.1 Motivation

In order to reduce the congestion and delays in the NAS a number of approaches can be pursued. On the capacity side, plans to increase the capacity of the NAS by adding new airports and new runways are usually expensive, long term projects and often face considerable political opposition from the communities that are affected by environmental impacts such as noise. On the demand side, attempts can be made to alter the airlines scheduling behavior through peak pricing policies (Barrett). Some efforts have focused on improving the efficiency of the system and reducing the delays through technological advances. One such type of effort is the introduction of decision support systems that may assist the air traffic controllers in managing

---

<sup>1</sup> "The world's air travelers are projected to double in number over the next 20 years, to more than 2 billion." From the Washington Post, December 12, 1997 reported in Delcaire [1998].

<sup>2</sup> The increase in traffic was at an average rate of about 3.5 percent a year between 1981 and 1997

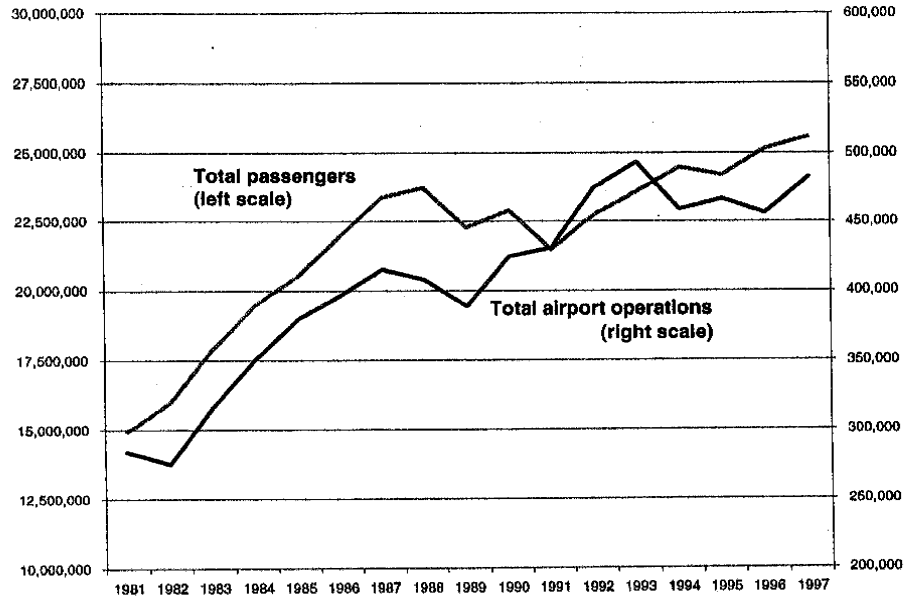

Source: Massport traffic summaries.

Figure 1.1: Traffic growth at Logan International Airport (from Delcaire)

the traffic. The work in this thesis is motivated by attempts to improve the performance of the airport system, and specifically the departure operations, through the introduction of such decision aiding systems.

### 1.1.1 The Departure Planner

Because of the higher cost and more critical safety concerns associated with airborne delays, most of the reported delays in the NAS are incurred on the ground of the airports by departure aircraft prior to their takeoff. Therefore, in order to improve the efficiency of the departure process and reduce delays, the Departure Planner is a concept for a decision aiding system that is aimed at assisting the air traffic controllers in managing the departure traffic at major congested airports. Using a generic control representation, the Departure Planner is represented in Figure

1.2 as a control system, where the departure process is the controlled system (the plant) and the Departure Planner is a controller. The Departure Planner would observe certain inputs and outputs of the departure process and would provide control inputs to it based on some internal methods and logic.

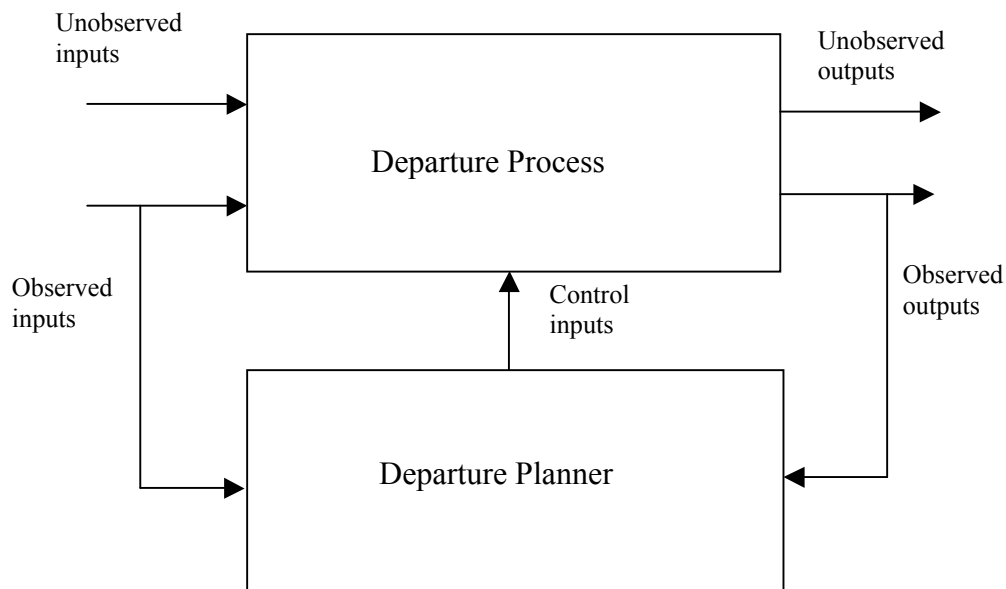

Figure 1.2: The Departure Planner

A number of possible Departure Planner methods could be envisioned. For example, the Departure Planner may consist of:

- An information provision system that enhances the state of knowledge and observability in the existing Air Traffic Control (ATC) system.
- A procedural rule-based system that would be incorporated in the existing procedures of the ATC system.
- A real-time decision aiding system that provides advice or control inputs to the air traffic controllers based on optimization techniques aimed at achieving some desired performance criteria.

## 1.1.2 The task of the thesis

In order to be able to propose improved methods such as the Departure Planner, a clear understanding of the underlying dynamics of the airport system is required. In particular, the dynamics of the departure process, which is represented as the controlled plant in the generic control representation in Figure 1.2, should be identified and analyzed. The insight gained through such analysis would support the design of the structure of the Departure Planner, its internal methods and logic and its interaction with the departure process in particular and with the airport system in general. The work in this thesis is a step towards achieving such insight about the departure process dynamics, by accomplishing the following tasks:

- *A diagnosis of the departure process, in terms of identifying the inefficiencies in the process and their causalities.* Since the motivation is to propose more efficient departure operations, the analysis of the departure process should be targeted at identifying the inefficiencies in the process and their causes so that the Departure Planner methods can be targeted at eliminating or mitigating them.
- *An in-depth understanding of the interactions between the departure process and the other processes inside and outside the airport system.* The inefficiencies in the departure process may be caused by factors internal or external to the process. For example, it is essential to identify how arrival operations, operations at other airports, weather and other exogenous inputs affect the departure process.
- *An in-depth understanding of the departure process operation under the current ATC environment.* In order to be able to incorporate new methods in the departure process it is essential to understand how the current system is operated and how flexible it is to adopt new proposed methods. For example, it is important to determine the strategies of the air traffic controllers and managers in managing the inefficiencies in the departure process and how current ATC rules and procedures restrict the current operations and hence new proposed ones. It is also important to identify the interactions between the air traffic controllers and

their workload levels. Such understanding is essential in order to determine what methods would be beneficial and, at the same time, acceptable to the air traffic controllers.

## 1.2 The departure process system

In this section, the system of a generic departure process, its environment and its main components are defined. First, the airport system is defined as a node in the National Airspace System (NAS). Then the airport system is broken down into its main components, which include the departure process. And finally, the departure process component of the airport system is defined.

### 1.2.1 The airport system in the NAS

The airport system is depicted in Figure 1.3 as a node in the National Airspace System (NAS) network. In this representation, The NAS network sees the airport as a sink, receiving inbound traffic (arrivals) from the network at the Airport Acceptance Rate (AAR) and as a source

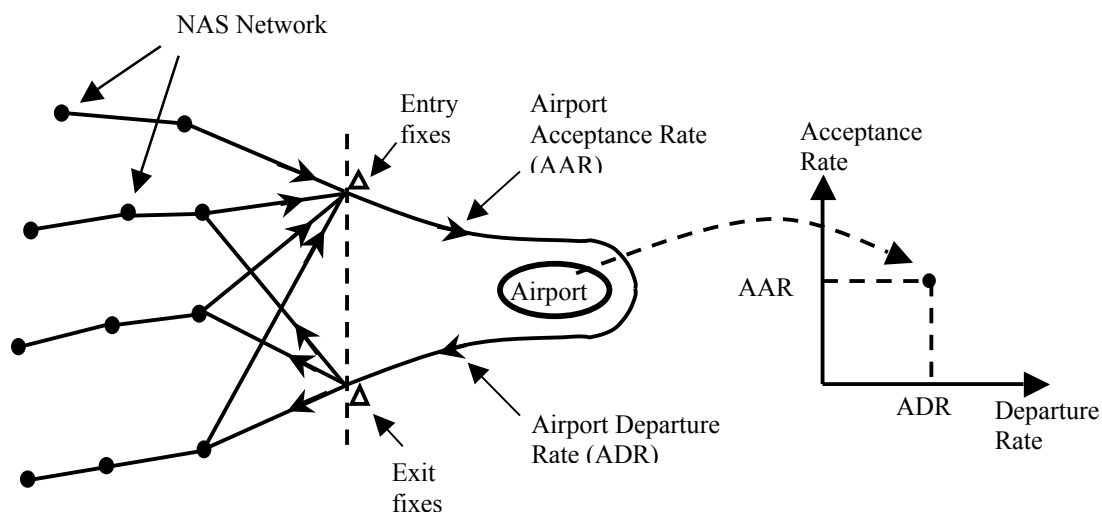

Figure 1.3: The airport system in the NAS

supplying outbound traffic (departures) to the network at the Airport Departure Rate (ADR). The Airport Acceptance Rate and Airport Departure Rate define the rate capacity of the airport and are usually estimated to reflect current conditions at the airport as will be described later in the thesis.

## 1.2.2 The airport system components

The airport system is abstracted at a higher level of detail in Figure 1.4, where the airport system is broken down into its main components. In general the main components of an airport system are the gates, a ramp area that surrounds the gates, a taxiway system that connects the gates/ramp area with the runways, and a runway system consisting of one or more runways. The terminal airspace surrounding the airport is shown in Figure 1.4 as a set of, possibly interacting, arrival and departure paths extending to a set of entry and exit fixes.

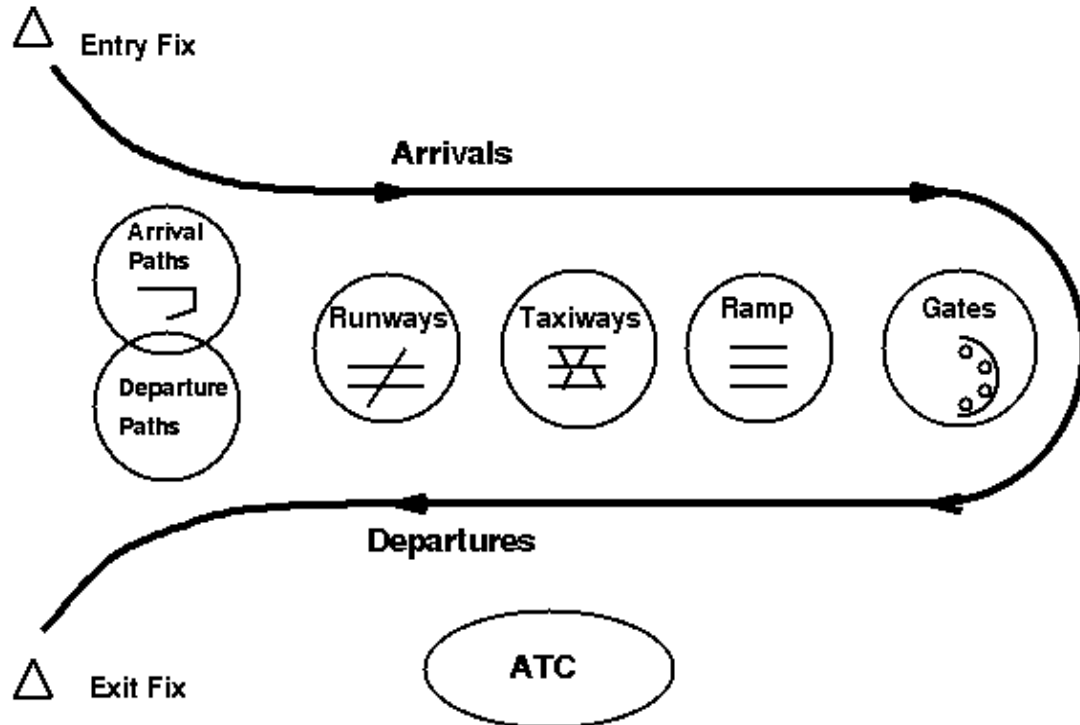

Figure 1.4: The airport system (including the terminal airspace)



As shown in Figure 1.4, the airport system receives arrival aircraft from the NAS through the entry fixes. Arrival aircraft use the approach paths in the terminal airspace to approach the airport and land on the runway system. Once landed, the arrival aircraft proceed through the taxiway system and then the ramp area to get to their designated gates. After turnaround<sup>3</sup>, arrival aircraft become departure aircraft. When ready to depart, the departure aircraft use the ramp and taxiways to get to the assigned runway for takeoff. Finally after takeoff, using departure paths in the terminal airspace, departure aircraft exit into the NAS through exit fixes.

Throughout this process the traffic, both arrival and departure, is under the control of ATC, namely the Control Tower which controls the aircraft movement on the airport surface, and the TRACON (Terminal Radar Control) which controls the flow in the terminal airspace. Therefore, as depicted in Figure 1.4, ATC constitutes another main component of the airport system.

### **1.2.3 The departure process**

The departure process is the component of the airport system that concerns the departure flow. Namely, the departure process consists of the operations in the bottom part of the aircraft flow in the airport system depicted in Figure 1.4. In order to define the departure process as a formal system, the collection of operations that constitute the departure process are confined to specific, well-defined events<sup>4</sup> that signal the start and the end of the process. Therefore, in the context of the airport system depicted in Figure 1.4, the overall departure process is defined as the collection of operations that a departure aircraft performs between the start of its preparation on the gate to its exit from the terminal airspace (as shown in Figure 1.5).

---

<sup>3</sup> Expression used for turning an arrival aircraft into a departure aircraft, through a number of turnaround operations performed at the gate, including disembarking arrival passengers and embarking departure passengers.

<sup>4</sup>An event is commonly associated with an instantaneous occurrence that leads to a transition in the state of the system (Cassandras).

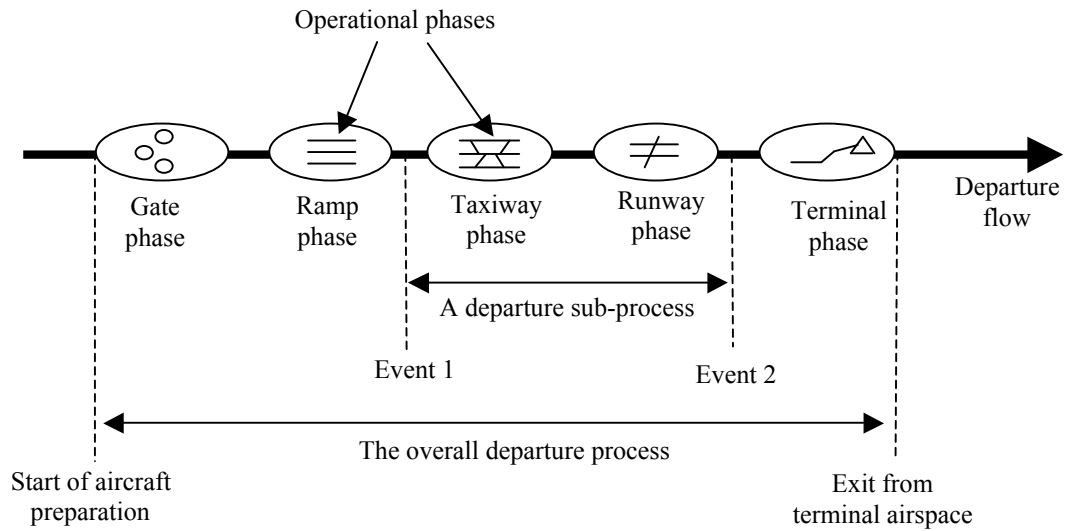

Figure 1.5: The departure process system and subsystems

In this thesis, sub-processes of the overall departure process were often analyzed. Therefore, a departure sub-process is defined as the collection of operations that are performed by departure aircraft between any two specific events (as shown in Figure 1.5). For example, the starting event of a departure sub-process may be the start of the pushback operation and the ending event may be the wheels-off event on the runway. “Operational phases” (are shown in Figure 1.5) are defined as the departure sub-processes associated with the start and end of the operations performed in the different components of the airport system such as the gates, ramp, taxiways and runways. Using such definitions, one may describe the departure process or sub-processes as well as a departure aircraft in the process with different states. For example, a state of the departure process or sub-process may be the number of aircraft performing operations between the two defining events, and a state of a departure aircraft may be the time that the aircraft spends in the departure process or sub-process between the two defining events.

As shown in Figure 1.4, Air Traffic Control is an integral part of the system. Therefore, the departure process consists of the departure aircraft flow as well as the control and communication processes used to control the aircraft flow as shown in Figure 1.6. In general,

each operational phase is associated with an air traffic control position. The Control Tower controls the traffic on the airport surface and the TRACON (Terminal Radar Control) is in charge of the terminal airspace. In many airports, the gates and ramp phases are under the control of airlines. An airline in these cases has a gate station and a ramp tower, in the airport, in order to manage the gates and ramp areas under its control. The aircraft control is handed off to the Control Tower once the aircraft is ready to transition to the movement area under the Control Tower. In Figure 1.6, the communications between the air traffic controllers and the pilots are depicted with arrows.

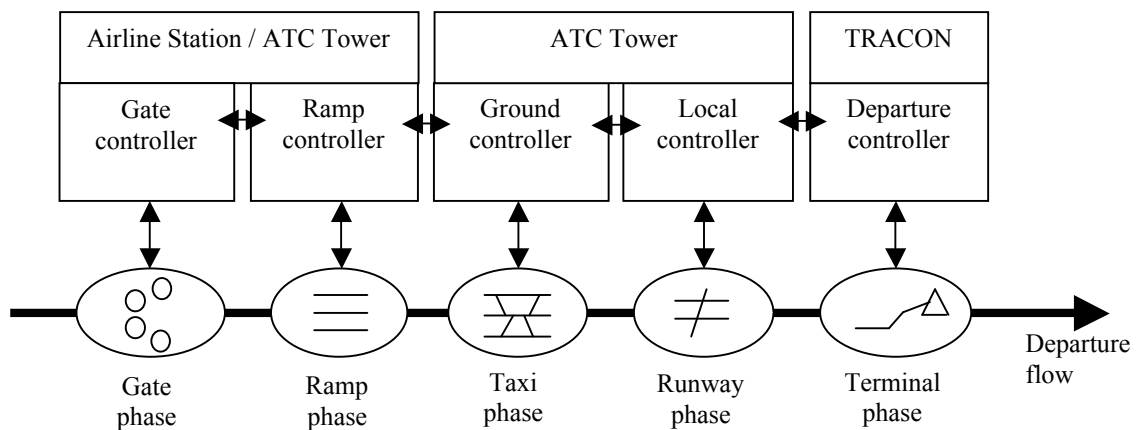

Figure 1.6: The departure process control

### 1.3 The problem statement

As described in Section 1.1, the main mission of the thesis is to gain an in-depth understanding of the dynamics of the departure process to support the development of decision aid systems such as the Departure Planner. In order to gain such an understanding, one needs to diagnose the departure process by identifying the inefficiencies in the system and their causalities, identifying the operation of the system under the current ATC environment and identifying the interactions between the system and its outside environment. The diagnosis problem is now stated in the

context of the departure process, its main components and its environment as defined in Section 1.2.

**Flow constraint** Inefficiency at any airport resource results when the resource<sup>5</sup> is operating below its maximum rate, which occurs in two situations: when the resource is not available while the aircraft demand is, and when the resource is available but the aircraft demand is not. When aircraft demand is available to use a resource but the resource is not available, the flow of aircraft is constrained, delays result and efficiency is lost. In this case the resource is defined as a **flow constraint**. On the other hand, when a resource is available but the aircraft demand is not, the resource stays **idle** due to demand **starvation**, efficiency is lost but no delays are incurred. Therefore, inefficiency results from a flow constraint or a lack of demand (starvation).

Therefore, in the context of the departure process, a flow constraint is an airport resource that impedes the flow of a departure aircraft during the departure process, because the resource is not available while departure aircraft demand exists. An airport resource may be a flow constraint because it is out of service or operated inefficiently relative to the demand rate. Any airport resource is a potential flow constraint, where the flow constraint manifests in reduced efficiency of the resource and/or delay to the aircraft demanding operation.

The two notions of flow constraint and starvation interact in a system with multiple resources. For example, the flow into a resource is generated from resources upstream of it and the flow out of a resource contributes to the flow into resources downstream of it. Therefore, a flow constraint at an upstream resource may result in starvation at a resource downstream, as well as may propagate back and cause flow constraint at a resource upstream. This is true of interactions between resources within the departure process and of interactions between the departure process and its outside environment (systems upstream and downstream of the departure process). Therefore, the problem of identifying the inefficiencies in the departure process and their causes becomes the analysis of the flow constraints at single resources and their interaction and propagation between multiple resources. Such analysis entails:

---

<sup>5</sup> An airport resource is any entity of the airport system that is used by an aircraft to perform an operation.

- Identification of the departure flow constraints (which airport resources constrain the flow and to what degree)
- Identification of the causalities of the departure flow constraints.
- Identification of the interaction between flow constraints and the propagation of their effects in the system.
- Identification of the strategies of the air traffic controllers and managers in managing the flow constraints.

## **1.4 Background and prior research**

There is a wide literature in the form of documentation, such as the Air Traffic Control manual (FAAH 7110.65L), Traffic Flow Management documentation (e.g. FAA 7210.3P) and airport Standard Operating Procedures (e.g. FAA, BOS TWR 7110.11H), which describe airport operations in detail. This documentation literature focuses mainly on the Air Traffic Control procedures that should be followed in order to maintain safe operations. Although it describes the ATC system structure and procedures in detail, this documentation does not provide an analysis of the system dynamics, performance or constraints.

There have been a number of approaches to the modeling and analysis of the departure process (and the airport system in general). One such approach models the airport system as a node in the NAS (as was described in Figure 1.4) with a set of arrival and departure rates, and tries to estimate the arrival and departure rate capacity of an airport system and the relation between them (e.g. Gilbo). Recently, these approaches have been extended to suggest the use of the developed capacity models in a Collaborative Decision-Making (CDM) environment to allocate the airport capacity efficiently between airlines (e.g. Gilbo [2000] and Hall [1999]).

Other approaches used classical queuing models to represent and analyze the airport departure process. Using simple queuing system representations, these approaches built predictive models of departure rate capacity and taxi out delays, and used the models to analyze the system or to

test estimation and control concepts (e.g. Andretta, Herbert, Shumsky, Pujet, Delcaire, Andersson, Carr). Andersson et al extended their predictive models of the departure process to arrivals and gate operations.

There is also significant research in the development of automation tools that are aimed at improving the departure process performance. Some tools are operational such as the Preferential Runway Assignment System (PRAS) at Logan Airport, the Departure Sequencing Program (DSP) at Newark Airport and the Airport Surface Management System (ASMS) at Detroit. Some other tools are under research: such as (among others) the Surface Management System (SMS) (e.g. Lawson), the Expedited Departure Planner (EDP) (e.g. Johnson), both at NASA Ames; and the Taxi And Ramp Management And Control (TARMAC) at DLR<sup>6</sup> (e.g. Böhme, Dippe and Völckers). Mostly, these programs assume a functional and operational understanding of the departure operations and often on developing and testing different automation concepts and optimization algorithms (often using dedicated simulations).

Some literature about airport operations is also available is studies that attempted to evaluate the economic benefits of enhancement plans for airports. For example, Polak used a TAAM<sup>7</sup> (Total Airspace and Airport Modeler) simulation to determine the bottlenecks in an airport system (Schiphol Airport) and evaluate solution strategies. Also, Allen et al conducted a system constraint analysis to identify the main technical and procedural constraints that limit the capacity of the Air Traffic Management system (including the airport system and its components) and developed a model to evaluate different enhancement plans based on the removal of the constraints.

---

<sup>6</sup> DLR is the German Aerospace Research Establishment = **D**eutsche **F**orschungsanslalt für **L**uft- und **R**aumfahrt

<sup>7</sup> TAAM is “a large scale fast-time simulation model, designed to simulate very realistically all possible aspects of the air traffic, on the ground as well as in the air.” (Polak).

## 1.5 Approach

***Observational, physical modeling approach*** There are two approaches to identifying the dynamics of a system (such as the airport system or the departure process in particular): an input output approach, which considers the system as a “black box” and attempts to gain insight about its dynamics by analyzing the relationship between the observable inputs and outputs; and a physical modeling approach, which attempts to gain insight about the internal structure and physical behavior of the system. In this thesis, it was desired to identify the departure flow constraints, their causalities and interactions, and the strategies of the air traffic controllers in managing them. Therefore, the approach followed was to gain, as much as possible, a clear understanding about the internal structure and physical behavior of the departure process, and the airport system in general. This was accomplished mainly through field observations at a site airport, which was chosen to be Boston Logan International Airport. Then based on the field observations, the identified behavior of the system was abstracted in a conceptual model and the model was used to develop an analytical framework in order to analyze certain metrics and states of the system, such as rate capacity and delays. The physical understanding gained through field observations was critical to support the development of improved analytical models, which reflected the flow constraints as well as the control behavior of the air traffic controllers.

***Queuing approach*** Aircraft form a queue when their flow through an airport resource is impeded, and therefore, the queue formation is a manifestation the flow constraints. In order to identify the departure flow constraints, a queuing approach was adopted, where the flow constraints, their causalities and interactions were identified by analyzing the queue formations and the causal factors that lead to their formation.

In order to analyze the causalities of the flow constraints a microscopic approach was undertaken at the level of an aircraft, in addition to the macroscopic approach at the level of a queue. In other words, the analysis tracks an aircraft as it progresses through the system and attempts to determine the factors that impede its progress. Control notions were added to the queuing representation in order to represent the control actions of the air traffic controllers and analyze their effect on the queuing dynamics. (It should be pointed out that queuing is used as a

representation of the observed physical behavior of the system. No attempt is made in this thesis to generate a classical, statistical queuing model of the system).

## **1.6 Thesis outline**

Chapter 2 describes the methodology of the field observations at Boston Logan International Airport. Chapter 3 describes the observations and analysis of the departure process at Logan Airport, in terms of the identification of the departure flow constraints, their causalities and interactions, as well as the strategies of the air traffic controllers and managers in managing them. Based on the field observations, the main identified elements of the departure process are abstracted using a queuing system with controlled blocking: Queues are used to represent the manifestation of the flow constraints, and control mechanisms are used to represent the controllers' actions. In Chapter 4 an analytical framework is posed based on the physical abstraction, and is used to analyze the departure process dynamics, including both the queuing and control behavior. Finally, in Chapter 5, a list of conclusions and implications for improved departure operation methods (such as the Departure Planner) are discussed.



## **CHAPTER 2**

# **METHODOLOGY OF OBSERVATIONS**

In order to be able to propose improved methods for the departure operations, such as the Departure Planner introduced in Chapter 1, a clear understanding of the underlying dynamics of the departure process is needed. In order to establish such an in-depth understanding, it was decided to concentrate the research effort on a single major airport and to perform detailed observations and diagnosis of the departure process. Logan Airport was chosen as a site for observation because it is the nearest major airport such that a rich set of observations can be obtained<sup>8</sup>. Therefore, field observations were conducted at Logan Airport in order to identify the departure flow constraints, their causalities and interactions, and the underlying dynamics including the role of the air traffic controllers in managing the flow constraints. The observations at Logan Airport spread over a two-year period (1998-1999), during which more than 200 hours of observations were conducted. The methodology for observation was to start from preliminary general observations and to transition into more focused and detailed observations as the knowledge about the airport system increased. In Section 2.1, Logan International Airport and its Control Tower are described in general as the observation site. In Section 2.2, data that were collected during field observations and obtained from sources outside the airport are described. Finally in Section 2.3, the more focused observations, made in order to identify the flow constraints and queuing processes and elicit of the air traffic controllers' strategies, are described.

---

<sup>8</sup> Although certain airport behavior could not be observed at Logan, for example Logan Airport is not a hub airport and therefore hub operations could not be observed, obtaining a rich set of detailed observations was essential to the in-depth analysis conducted in this thesis.

## **2.1 Preliminary general observations**

Starting with limited knowledge about Logan Airport, a preliminary observation stage was conducted in order to identify high-level airport system structure and dynamics. The main activities in this preliminary stage were to establish contact with the Control Tower personnel and to conduct tour-like visits to the Control Tower. The Control Tower supervisor often assigned off-duty personnel to introduce the airport system and to answer preliminary and generic questions. The initial visits were conducted mainly in low traffic hours to avoid interference with the working environment of the Control Tower. Because the focus was on departure operations, the observations were concentrated on the airport surface and the Control Tower and their interaction with the other components and facilities of the airport system and with the airport environment.

### **2.1.1 Logan Airport general description**

In addition to its proximity, one essential factor in selecting Logan Airport as an observation site was that it is a major airport, with high levels of traffic and congestion, such that major flow constraints manifest. Logan International Airport (Figures 2.1 and 2.2) is the nation's seventeenth busiest airport and the world's twenty-sixth busiest airport based on passenger volume. In 1999 the airport served 494,816 flight operations and over 27 million passengers. Although not a hub airport, Logan serves a major city in the northeast with a heavy dependence on aviation, both commercial and general. This resulted in a traffic mix that includes propeller-driven aircraft and jet aircraft, serving short haul, long haul, as well as international destinations. Propeller-driven aircraft and general aviation constitute 42 percent of the yearly operations at Logan Airport.



Figure 2.1: Logan International Airport (aerial view, from Delcaire)

Logan Airport is commonly known as one of the more complex airports due to a number of factors that constrain its operations. One major constraining factor is the lack of real estate available to the airport. Logan Airport has a complex runway structure, which consists of 5 runways built on a relatively small area of land, and involves close parallel runways and intersecting runways (see Figures 2.1 and 2.2). A constrained network of taxiways, consisting of two main taxiways (Alpha and Kilo) connects directly to the gates and gate alleys, due to the lack of a ramp area surrounding the gates (see also Figure 2.1 and 2.2). This constrained geometry of the airport resulted in particular relations between the Control Tower and the airlines that are different than at more modern airports. For example, due to the lack of ramp areas around the gates under airline control, airlines delegated some of the responsibilities in the gate and gate alley operations to the Control Tower in order to resolve conflicts between non-interacting airlines. In addition to the lack of a ramp area, Logan Airport lacks delay-absorbing

areas (parking areas and penalty boxes) where aircraft are usually staged to absorb lengthy delays.

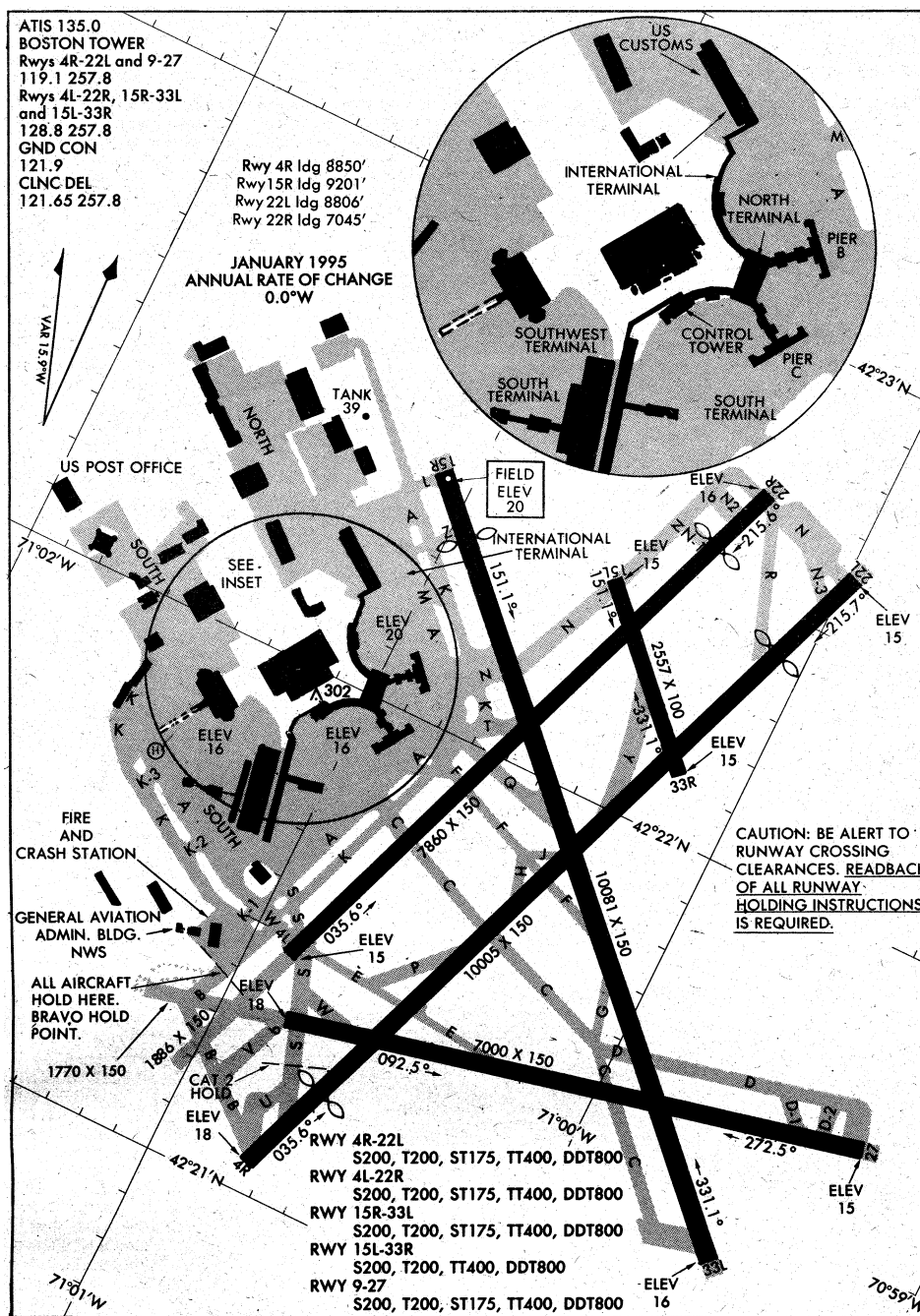

Figure 2.2: Logan Airport diagram (from US Terminal Procedures, Jan 1999)

Other constraining factors at Logan Airport include a complex weather pattern with shifting wind directions, ocean sea breeze effects, and extreme seasonal storms; environmental constraints, especially noise constraints, due to the proximity of the airport to residential areas; and, last but not least, the location of Logan Airport in the northeast where the northeast corridor between Boston and DC, passing through the New York airspace, is one of the most delay-prone areas of the NAS.

Logan Airport, therefore, provides a rich site for field observations and a good case for diagnosis where many factors that constrain the flow of traffic manifest. Since Logan is a major airport, these constraints, although observed at Logan Airport and in some cases particular to Logan, are most of the time generic and representative of the operations at other major airports. However, there are certain types of operations that do not manifest at Logan Airport. For example, Logan Airport is not a hub airport, and therefore, hub operations cannot be observed. Also Logan Airport has a single runway system while most other modern airports consist of two runway systems on opposite sides of the terminal buildings.

## **2.1.2 Overview of the Control Tower**

The Control Tower is responsible for departure aircraft from their pushback or taxi until they are handed off to the TRACON at the edge of the Tower delegated airspace<sup>9</sup>. The Control Tower also controls arrival aircraft from their handoff from the TRACON about 5 miles out, until their arrival to the gate or gate ally where control is handed off to the airline. Based on the Standard Operating Procedures (SOP) (FAA, BOS TWR 7110.11H) and the field observations at Logan Airport, the main Control Tower positions and their responsibilities are described as follows (see Figures 2.3 and 2.4).

---

<sup>9</sup> According to the Standard Operating Procedures (SOP) of Logan Airport (FAA, BOS TWR 7110.11H), the Control Tower delegated airspace includes “2000 ft MSL and below from the Boston VORTAC to the edge of the Boston Class B Airspace (8 DME), except 1,000 ft MSL and below, underlying Final Vector airspace from the 5 NM Range Mark to the edge of the Class B Airspace.” The Final Vector is the control position in the TRACON in charge of the final approach and descent up to the 5 NM Range Mark where the aircraft are handed off to the Control Tower. “The use of 2,500 ft MSL and above in the Boston Class B Airspace is delegated to Boston TRACON (A90).” The TRACON delegated airspace extends laterally from the edge of the Tower Airspace to about 25 NM and vertically to 14,000 ft MSL.



Figure 2.3: Control Tower at Logan Airport

From left to right against the windows: Flight Data, Clearance-Delivery/Gate, Ground, Local West, Local East (2 controllers), Local Helicopter (2 controllers), Lower left in front of a computer is the TMC.

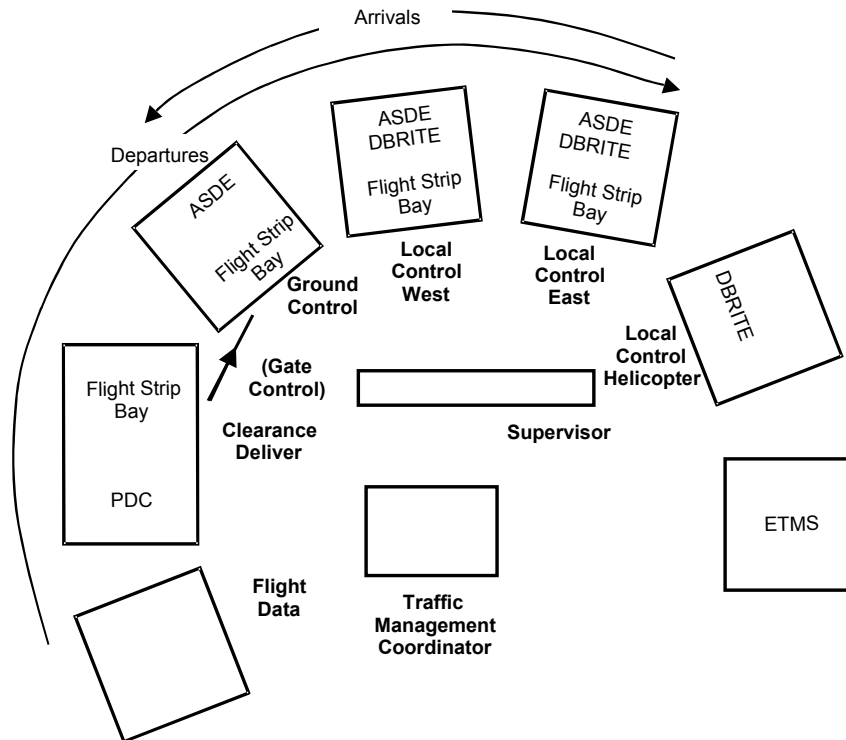

Figure 2.4: The Control Tower structure

**Local Controller (LC)** “is responsible for the arrival and departure of aircraft on assigned runways and aircraft/helicopter operating within assigned airspace.” Two Local Control positions are usually active at Logan, Local Control East (LCE) and Local Control West (LCW), each in charge of one or two (usually intersecting) runways. An additional Local Helicopter (LH) position is added in heavy traffic hours, to be responsible for the arrival and departure of helicopters to/from the Boston Helipad and for aircraft/helicopters operating within the assigned airspace.

**Ground Controller (GC)** “is responsible for taxiing aircraft and vehicular traffic on movement areas that do not require the crossing of active runways.” (Crossing an active runway is the responsibility of the Local Controller in charge of the runway). At Logan Airport the Ground Controller issues the clearance for pushback<sup>10</sup>, the taxi clearance, assigns a taxi route to the assigned runway and finally hands off the aircraft control/communication to one of the Local Controllers.

**Boston Gate (BG)** “Boston Gate is responsible for the efficient metering of outbound aircraft.” Boston Gate receives a call from the pilot indicating that the aircraft is ready for pushback (if jet) or for taxi (if non-jet) and marks the time of the call on the flight progress strip (described below in Figure 2.5). BG issues an expected pushback or taxi time if a delay or hold is required and marks the time on the flight progress strip as well. Finally BG releases the aircraft to the Ground Controller according to first come first serve, unless there are special circumstances such as Lifeguard or a time restriction on the takeoff time, which require a different sequence.

**Clearance Delivery (CD)** “is responsible for the issuing of departure clearances.” Clearance Delivery reviews all flight plans for completeness and accuracy and verbally issues the appropriate initial altitude even though the initial altitude may be contained in the Standard Initial Departure (SID) that has been issued. At Logan Airport, Clearance Delivery is usually consolidated with Boston Gate.

---

<sup>10</sup> Except from particular gates in alliees away from movement areas, with agreement with the airlines not to conflict with movement areas and when there is no conflict with other airlines.

**Flight Data (FD)** “is responsible for the dissemination of information”. Flight Data reviews all NAS flight plans for completeness and integrity prior to forwarding the flight progress strip to the Clearance Delivery.

**Traffic Management Coordinator (TMC)** “forwards, to the Tower Supervisor (ASC), all Traffic Management restrictions for facility dissemination, and the receipt of all hazardous weather information.” The TMC maintains the Control Tower logs for restrictions, weather, runway activity and all relevant events. In coordination with the Supervisor ASC and area manager, the TMC determines the arrival and departure rates of the runways under the current conditions.

**Tower Supervisor (ASC)** The supervisor of the Tower Cab is responsible for all supervision responsibilities, higher level strategic decisions and assignment of controller personnel to the different control positions.

Figure 2.4 shows the main tools that are used by the air traffic controllers in order to establish their control over the aircraft in their delegated movement areas. These tools include:

**Out the window monitoring** where the air traffic controllers monitor the state of the traffic on the airport surface from the Tower windows in good visibility conditions.

**Airport Surface Display Equipment (ASDE)** which displays the ground-radar track position of aircraft (and other vehicles) on the airport surface. The ASDE does not display the identification of the aircraft on the airport surface<sup>11</sup> and therefore, they are less effective than out the window monitoring and used mainly in bad visibility conditions when the out the window monitoring is not effective.

**DBRITE** radar display for airborne aircraft, mainly for the Local Control positions. The ASDE and DBRITE can be displayed on one video screen.

---

<sup>11</sup> Currently there are engineering difficulties under research that prevent the display of the aircraft identification on the ASDE.



**Radio communication** between the air traffic controllers and the pilots. Through radio communication the pilots convey information about the state of the aircraft and the air traffic controllers deliver their control instructions to the pilots.

**Flight progress strips** used by the air traffic controllers in order to keep track of the aircraft progress. Each departure aircraft has a flight progress strip (Figure 2.5), which is printed automatically (or hand written) in the Control Tower about thirty minutes prior to its scheduled departure time.

UAL1037	2113	BOS	BOS GLYDE BAF J77 SAX J6			1601
T/B73S/R	P1550	330	LRP V143 ROBRT AML IAD		F	
233	310				10	

Figure 2.5: A flight progress strip example (from FAA, BOS TWR 7110.11H)

The flight progress strip is used as a source of information on the departure aircraft, including the aircraft identification and type, the proposed departure schedule according to the airlines CRS (Computerized Reservation System), the departure flight plan and any restrictions imposed on the departure along its way to its destination. The flight progress strip is also used as a communication tool between the air traffic controllers where it is handed off between successive controllers to transition the aircraft control. The air traffic controllers indicate (hand write) on the flight progress strips additional information such as the runway assignment, any amendments to the flight plans and certain critical time points (such as the first time the pilot calls ready and the takeoff time). Appendix A describes the flight progress strip and the information it contains in detail.

## **2.2 Available and collected data**

In order to analyze the departure process flow constraints and underlying dynamics, possible measurement and data sources were identified during field observations. Two types of data were investigated in terms of the information they provide: aircraft movement data and airport conditions data. Movement data measure the state of the departure aircraft as they progress through the airport system and were used to identify the flow constraints in different airport resources and departure phases and analyze the underlying queuing dynamics. In order to analyze the causalities of the flow constraints, these movement data were consolidated with airport conditions data, which provided information about the conditions that prevailed at the time and might have caused the flow constraints.

### **2.2.1 Aircraft movement data**

Two main sources were used to obtain aircraft movement data: historical data available through the airlines and the FAA and data collected during the field observations at Logan Airport.

#### **2.2.1.1 Aircraft movement available data**

Historical aircraft movement data were available through the Airline Carrier Automated Reporting System (ACARS), which provides a number of airline carriers with an automated mean to maintain records of performance and quality of service. Two sets of data generated through ACARS were used: pilot delay reports and the Airline System for Quality and Performance (ASQP) data, described below. Historical aircraft movement data were also available through the Consolidated Operations and Delay Analysis System (CODAS) database, which is maintained by the FAA. CODAS is a consolidation of a number of data sets including the ASQP data and the Enhanced Traffic Management System (ETMS) traffic counts data (also described below), among other data sets (see also Delcaire).

**ACARS pilot delay reports**

Whenever delays are incurred during a flight, pilots of the airline carriers with ACARS are encouraged to enter into the automated reporting system the duration of the delay and a code that identifies the cause of the delay. ACARS pilot reports were obtained from one major airline for the first ten months of 1997, and for four major airports including Logan in order to compare the delays at different airports. Figure 2.6 shows an example of the different delay causes available in the ACARS of one major airline, for two phases of a flight on the airport surface: the Out to Off phase between the pushback and takeoff and the On to In phase between touchdown and parking at the gate (the Out, Off, On and In events will be described in the next Section).

<b>A. Out to Off Delays</b>
Airplane de-icing
Airplane systems operational check, cabin check, MEL confirmation, etc.
ATC hold for departure control
Awaiting ATC en route clearance
Awaiting radio closeout information
Awaiting takeoff weather minimums
During pushback due to tug malfunction, equipment problems, or traffic congestion in ramp area
During taxi due to traffic congestion in ramp area
Field traffic vehicular or airplane
Loading additional bags
Other flights landing or departing
Recalculation of takeoff performance data
Runway change
<b>B. On to In Delays</b>
Awaiting gate assignment
Awaiting gate when assigned gate is occupied
Awaiting guideman to park at assigned gate or ground equipment interference
Awaiting Jet Bridge or Passenger Service Personnel.
During tow-in, due to tug malfunction, equipment problems or traffic congestion in ramp area.
Field traffic vehicular or airplane
Mechanical malfunction, airplane towed from runway, etc.
Ramp congestion either airplane or ground equipment
Reduced visibility, snow, ice

Figure 2.6: ACARS delay categories for one major airline

The ACARS pilot delay reports provide an excellent source of information about the flow constraints and their causes since the causality categories indicate where in the system the delays were incurred and why. They are also available for many airports and therefore provide a basis for comparison to the behavior observed at Logan Airport. However, they suffer from a number of limitations: They are subjective because they are reported by human pilots and are subject to their interpretation of the delay cause categories, which may be vague and may overlap. They

may lack accuracy since they are estimated by human pilots. They are also incomplete because they are voluntary (not all pilots report and pilots may not report all incurred delays).

### ***Airline System for Quality and Performance (ASQP) data***

The ASQP data are reported from the ten major domestic airline carriers<sup>12</sup> to the Department of Transportation (DOT) in order to calculate on-time performance statistics. The FAA maintains the ASQP data in the CODAS database. ASQP includes four time data points that are recorded automatically by means of activated switches on the airplane, and reported through ACARS. These four time data points are the following:

**On Time** is the wheels-on time activated by the aircraft touchdown on a runway.

**In Time** is the time the aircraft parks at the gate activated by the brakes' engagement.

**Out Time** is the time the aircraft leaves the gate activated by "door closed" and "brakes released".

**Off Time** is the wheels-off time activated by the aircraft lift off the runway.

The ASQP data are reliable and accurate since the On, In, Out and Off times are recorded automatically using switches which are activated by defined events. However, since only ten major airlines report the ASQP data, the degree of coverage over the traffic at an airport depends on the percentage that these airlines constitute of the total airport traffic. At Logan Airport for example, these ten major airline carriers constitute only about 50 percent of the traffic (see Delcaire or Pujet). As far as the departure process is concerned only two time data points, the Out and Off times, are recorded. Therefore, the ASQP data define a single-phase departure process between the Out and Off time events as shown in Figure 2.7. The time between the scheduled pushback time (known from the OAG schedule) and the recorded pushback (Out) time can also be considered as a pre-pushback phase.

---

<sup>12</sup> The ten major airlines are: Alaska, American, America West, Continental, Delta, Northwest, Southwest, TWA, United and US Airways.

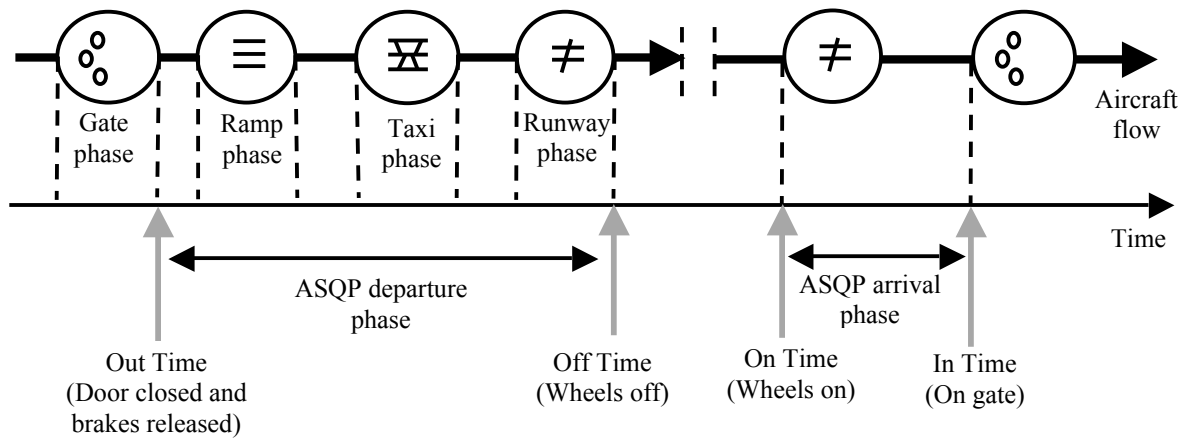

Figure 2.7: The departure process based on the ASQP events

### ***Enhanced Traffic Management System (ETMS) traffic count data***

ETMS traffic count data measure the number of arrivals that landed at an airport and the number of departures that departed from an airport in a period of time. ETMS traffic counts in one-hour and fifteen-minute periods are available in the CODAS database. The ETMS traffic count data are based on the radar tracking of IFR airborne aircraft, where arrival times are identified when aircraft drop out of the radar system of an airport, and departure times are identified when aircraft are captured by the radar system. These rate measurements can be obtained from the ASQP data; however, ETMS data provide a full count of the aircraft, which landed and departed, including both ACARS and non-ACARS aircraft. Therefore, ETMS data have been used for estimation of airport arrival and departure rate capacities under different conditions, as seen in Gilbo. ETMS data are not as accurate as the ASQP data however, since there is a delay between the actual takeoff time and the start of the radar tracking and ETMS reporting of departure aircraft. Similarly there is a delay between the last ETMS message of an arrival aircraft and its actual touchdown.

### 2.2.1.2 Aircraft movement collected data

In order to demonstrate the insights gained from the qualitative observations made at Logan Airport and to supplement the available historic records of movement data, more detailed measurements of aircraft movement were collected during the field observations. These movement data were obtained from the communications between the air traffic controllers and the pilots and from the flight progress strips.

#### *Communication data*

The ASQP data provided limited observability of the departure process where the dynamics between the pushback and takeoff events are aggregated into one phase as shown in Figure 2.7. In order to identify the departure process dynamics in between these two events, it was desired to obtain more detailed measurements of the aircraft movement. The field observations in the Control Tower indicated that it is possible to track the aircraft movement through the airport by tracking the communications between the air traffic controllers and the pilots.

The tracked communication events included mainly control instructions delivered from the air traffic controllers to the pilots; in particular, the clearances and the frequency change requests for the handoff between controllers. While there are many other types of controller/pilot communications, it was observed that the control instructions (particularly the clearances and frequency change requests) are the most consistent since they are required for every aircraft and are often reiterated by the pilots to insure mutual understanding. Therefore, it was possible to track the movement of all aircraft in the departure process, quite accurately, through the clearance and handoff instructions of the air traffic controllers. In addition to the main control instructions, the time that the pilot calls the Gate Controller to indicate that the aircraft is ready for pushback (if jet) or for taxi (if prop) is written by the Gate Controller on the aircraft's flight progress strip (as was described in Section 2.1). Therefore, the first "call ready" event was also consistently available for all aircraft from the flight progress strips.

Figure 2.8 shows the departure sub-processes that are defined between five recorded communication events: the pilot's call "ready for pushback" and four control instructions ("clear

for pushback”, “clear for taxi” and “monitor tower”<sup>13</sup> delivered from the Ground Controller, and “clear for takeoff” delivered from the Local Controller).

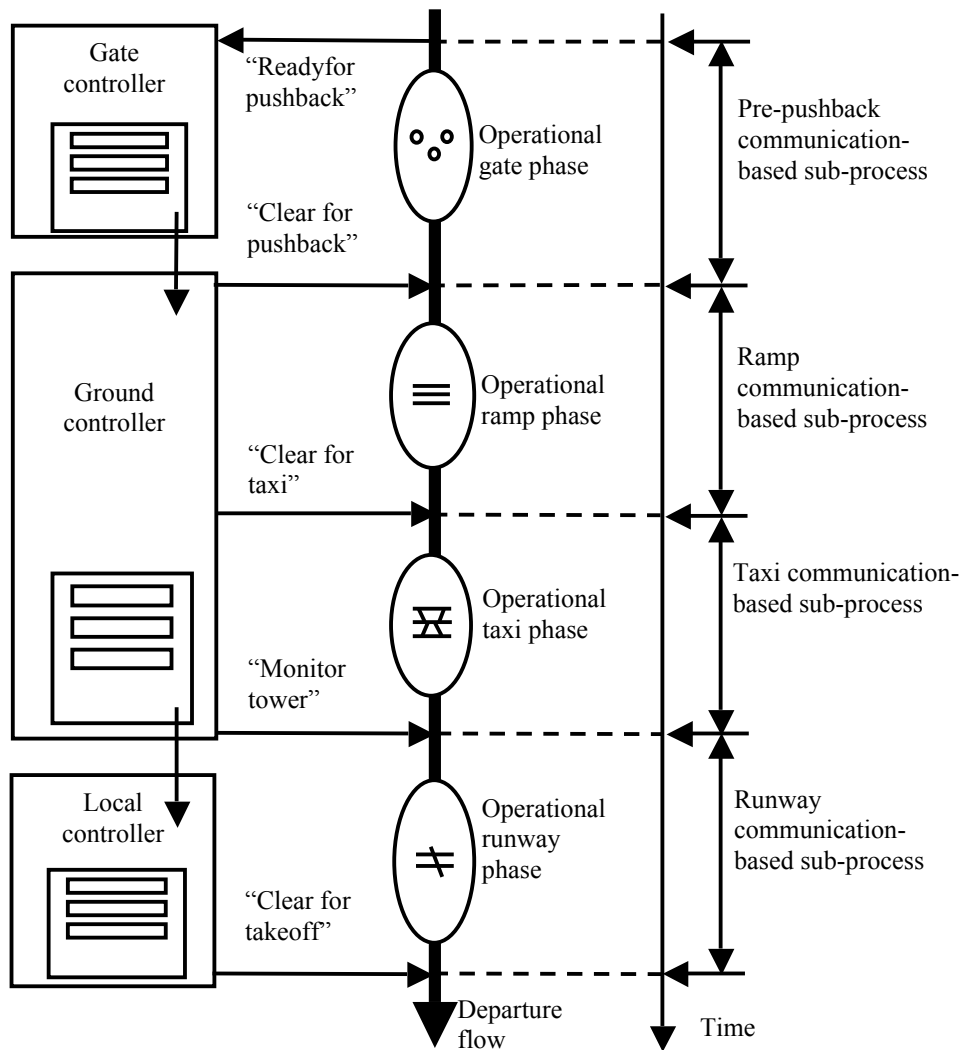

Figure 2.8: Departure communication-based sub-processes

<sup>13</sup> The “monitor tower” instruction is a frequency change request to handoff the aircraft from the Ground Controller to the Local Controller.

As shown in Figure 2.8, the five communication events signal the transition of aircraft between four major operational phases of the departure process (namely the gate, ramp, taxi and runway phases). Therefore, the communication-based sub-processes are used as surrogates for the main operational phases in the departure process, where the flow constraints and queuing dynamics of the different operational phases are inferred by analyzing the dynamics of the communication-based sub-processes.

The communication events were recorded manually while monitoring the controller/pilot communication channels. Manual recording of the communications was the fastest and least expensive method in order to attain a quick demonstration of the observed behavior<sup>14</sup>. The learning and experience gained through extensive field observations and monitoring of the communications facilitated the manual recording process. For each instruction, the time, the type of instruction and the aircraft callsign were recorded. The phraseology used by the controllers is common as set in the ATC manuals, but varied to a certain extent between controllers. When more than one air traffic controller was monitored at the same time, one person recorded from each communication channel. When the communication traffic on a channel became heavy and the communications were repeated, the last communication was used to indicate the event time.

It was observed that the airport system behavior is repetitive to a large extent, especially in normal and typical days of operations when no extraordinary conditions such as inclement weather prevailed. Therefore, data were collected on typical days of operations in order to demonstrate the nominal observed behavior. About forty hours of data collection sessions were conducted. The data collection sessions were concentrated in rush hours to insure high demand and congestion such that the queuing behavior manifested.

---

<sup>14</sup> Through automated recording, it is possible to obtain longer hours of recording. However, to be useful it needs to be processed with automated voice recognition, which is difficult due to the variations in the phraseology and voices of the different air traffic controllers.



### ***Flight progress strip data***

While most communication events were recorded manually while monitoring the communication channels, certain time events were available from the aircraft flight progress strips. Namely, the Gate and Local Controllers write the times of the “call ready” and the takeoff clearance events, respectively, on the flight progress strip of each departure aircraft (to within one minute). Therefore, these two time data points were obtained mostly from the flight progress strips, simplifying the process of monitoring and manual recording from the communication channels<sup>15</sup>.

To complement the communication data, additional information was also obtained from the flight progress strips of the departure aircraft for which the controller/pilot communications were recorded. (The details of the information contained on a flight progress strip are described in Appendix A). This information included the aircraft callsign, the type of aircraft, the runway assignment and (if marked) the gate assignment, the proposed pushback time according to the schedule (and in some cases the Gate controller's suggested pushback time), the destination and exit fix of the departure, and any restrictions indicated on the flight progress strip (such as a requested time window for takeoff).

## **2.2.2 Airport conditions data**

In addition to the aircraft movement data, data sources for prevailing airport conditions were used in order to identify the causalities of the flow constraints in the departure process. Among the records that the Control Tower maintains, the following logs of airport operations and conditions were found useful in the departure process analysis.

---

<sup>15</sup> Obtaining these time data points from the flight progress strips simplifies the communication monitoring process since only the Ground Controller needs to be monitored in order to obtain the “clear for pushback”, “clear for taxi” and “monitor tower” events (see Figure 2.8).

### 2.2.2.1 Traffic Management Coordinator (TMC) log

The Traffic Manager Coordinator log contains information about the current weather, current runway assignments, imposed ATC restrictions (especially by the Control Tower), equipment failures and general information on any occurrences that warrant recording in the log. As shown in Figure 2.9 each entry in the TMC log includes the starting and ending time of the condition as well as impacting conditions (IC), which indicate the cause of the event when applicable and known (relevant acronyms will be explained later in the thesis during the analysis).

Start	Stop	Remarks	Addl Remarks	IC or Restrictions
10:00	10:00	CURRENT WX: 24004KT 9SM FEW110 BKN180 BKN200 18/18 A3002	WIND 24004KT	
10:00	10:25	LAND 22L DEPT 15R, AAR 34		
10:00	13:20	SPEED RESTRICTIONS: NONE		
10:25	13:20	LAND 27+22L DEPT 22R, AAR 68/38		
13:00	13:00	FYI: RWY 4L/22R WILL BE CLOSING AT 14Z. WE WENT TO THIS CONFIGURATION EARLY BECAUSE OF A LULL IN THE ARR. AND DEPT. DEMAND. AFTER WEIGHING ALL OPTIONS(4R/9 OR 15R+L/9) THIS WAS DEEMED THE BEST CONFIG.		
13:20	13:40	LAND 15R/L+ 9 DEPT 9, AAR 60/34	WIND 14005	
13:20	18:10	SPEED RESTRICTIONS: 250 KTS ALL FIXES		
13:46	17:59	LAND 15R DEPT 9, AAR 38		IC: CLSD RWY
13:46	16:45	BOS REQ: 15 MIT ALL FIXES		IC: CLSD RWY
13:46	13:46	FYI: RWY 15L ARR'S HAVING DIFFICULTY PICKING UP TRAFFIC ON 15R DUE TO LOWERING CEILINGS		
16:45	18:10	ZBW ARRIVAL RESTRICTION: METERING 38 RATE		IC: CLSD RWY
18:00	18:10	LAND 4R DEPT 9, AAR 38. ANTICIPATING THE RETURN OF 4L ANY TIME.	WIND 10812KTS	IC: CLSD RWY
18:00	18:00	CURRENT WX: 09013KT 10SM FEW030 BKN130 BKN200 21/17 A2997		
18:10	1:59	LAND 4R/L DEPT 9, AAR 68/38. ZBW TO PROVIDE MIT FOR ACFT IN HOLDING STACKS, UNTIL NORMAL FLOW IS RESUMED.		IC: NONE
18:15	1:59	PVD 250 KTS - SPEED RESTRICTION.		
18:28	1:59	GDM 250 KTS - SPEED RESTRICTION.		

Figure 2.9: Excerpt from a TMC log

### 2.2.2.2 Restriction log

The restriction log is also maintained by the TMC, and contains the ATC restrictions imposed on departures. As shown in Figure 2.10, the restriction log entries include the type of the restriction, its origin (in terms of the downstream location where the restriction originated), its time (start and end), and its reason (impacting condition, IC) (relevant acronyms will be explained later in the thesis during the analysis).

Start	End	Destination /Route	Restriction	Reason for Restriction (IC)
11:00	12:30	ORD	20 MIT	VOL
11:45	12:45	EWR	MIT 15 JETS 20 PROPS	VOL
12:15	12:45	CLT	15 MIT	WX
14:00	21:08	SFO	EDCT	WX
15:15	17:00	PHL	15 MIT	VOL
16:50	21:08	MHT	20 MIT- ARTS OTS	EQUIP
20:00	22:00	ORD	DSP	WX
20:28	21:00	ATL	TMS GS	WX
21:09	21:24	PHL	DSP	WX
21:24	0:00	PHL	INTRAIL 20 MIT LIKE TYPES	WX
21:49	22:46	IAD	TMS GS	WX
23:00	0:49	J75	REROUTE	ENR WX
0:49	2:00	SFO	EDCT	WX

Figure 2.10: Excerpt from a restriction log

### 2.2.3 Manuals

Another important source of information that provided mainly background on the ATC policies and programs was the ATC manuals, both general and particular to Logan Airport. These manuals included mainly: the ATC manual (FAAH 7110.65L), the Standard Operating Procedures (SOP) of Logan Airport (FAA, BOS TWR 7110.11H), the Air Traffic Management coordinator course notes (FAA, Course 50115) and the Preferential Runway Assignment System (PRAS) documentation (FAA, BOS TWR 7040.1F).

## 2.3 System identification through focused observations

In order to identify the departure flow constraints, their causalities and the role of the air traffic controllers in managing them, focused field observations were conducted. The focused observations were implemented by identifying, in detail, the queuing network of the departure process where the queues are a manifestation of the flow constraints and eliciting the controllers' strategies in controlling the traffic through the network. The queuing and control behavior

identified through the observations provided the physical basis for modeling the departure process and analyzing its dynamics using the different data sources described in Section 2.2.

### **2.3.1 Identification of the queuing networks and flow constraints**

In order to identify the departure flow constraints, the observations were focused on the queue formations, which are a manifestation of the flow constraints. Detailed queuing networks were identified by identifying the main airport resources, the different types of queues that form at the resources and the interactions between the queues. Each type of queue or queue interaction identifies a possible type of flow constraint. For example, a takeoff queue or a runway-crossing queue indicates a flow constraint at the runway. Departure aircraft held in delay absorbing areas or on their gates due to downstream restrictions indicate the effect of downstream flow constraints. Piling of flight progress strips on a strip bay in front of an air traffic controller in the Control Tower indicates flow constraints due to (among other things) the air traffic controller's workload. Repeated or lost communications indicate a flow constraint due to the limited communication channel capacity.

The queue formations were observed during heavy operations in order to insure high demand and congestion. The queue observations were accomplished mainly by monitoring the traffic out the window of the Control Tower, monitoring the communications between the controllers and the pilots and the flight progress strip accumulation in the strip bays in front of the controllers. As mentioned in Section 2.2.1, some aircraft movement data, such as controller/pilot communications, were collected during the field observations in order to demonstrate the observed behavior quantitatively.

### **2.3.2 Elicitation of air traffic controllers' strategies**

An essential element of the dynamics of the departure process is the strategies and decision processes of the air traffic controllers, who control the traffic and manage the flow constraints. The controllers' strategies were identified through elicitation, which was accomplished through

monitoring the behavior of the air traffic controllers during operation and through interviews with Control Tower supervisors and air traffic managers.

### **2.3.2.1 Elicitation through monitoring**

After considerable hours<sup>16</sup> of monitoring different air traffic controllers in different positions and the interaction between the air traffic controllers, it was possible to identify common patterns in the control behavior. Particularly, certain tactical control strategies that were used by the air traffic controllers to control the aircraft movement on the airport surface were observed and identified through monitoring the controller/pilot communications and the interactions between the air traffic controllers. For example, through the observations, common strategies in sequencing aircraft for takeoff, common taxi route assignment, and common control points where aircraft are held for critical sequencing decisions, were identified. It was observed, for example, how the air traffic controllers use a First Come First Serve (FCFS) sequencing strategy and how they deviate from FCFS in order to implement certain ATC procedural rules, or imposed restrictions, or to accommodate other special circumstances. Also it was observed how the air traffic controllers interact and cooperate to regulate the flow of aircraft in order to reduce delays and maintain acceptable levels of workload.

Since the control behavior is subjective and dependent on the air traffic controller working at the time, it was essential to insure exposure to a wide range of controllers in each control position. It was also important to conduct the observations when different runways were used and under different weather conditions, since different airport conditions present different situations and challenges to the air traffic controllers.

---

<sup>16</sup> As mentioned at the beginning of this Chapter, over 200 hours of field observations were conducted in the Control Tower during 1998 and 1999. Many of these hours involved data collection while monitoring the communication channels.

### **2.3.2.2 Elicitation through interviews**

While monitoring helped in gaining insight and forming a general understanding of the common controllers' behavior and strategies, focused interviews were often conducted to gain insight into detailed behavior that is not apparent from direct monitoring. For example, through interviews with Control Tower Supervisors and Traffic Management Coordinators, the higher level decisions that concern airport runway selection and the implementation of different ATC procedures and restrictions for flow management purposes were identified (see Section 2.1.2 for Supervisor and TMC responsibilities). Through focused interviews it was possible to identify the underlying causalities and objectives of the observed behavior. For example, it was also possible to identify, qualitatively, the factors that the controllers consider in making certain decisions or in adopting certain sequencing strategies. Also focused interviews often provided explanations of certain behaviors that were observed in the analysis of the collected data.

# **CHAPTER 3**

## **OBSERVATION AND FLOW CONSTRAINT ANALYSIS OF THE DEPARTURE PROCESS AT LOGAN AIRPORT**

In order to identify the flow constraints that impede the departure operations in an airport system and understand the underlying dynamics of the departure process, field observations were conducted at Boston Logan International Airport. These observations and the associated analyses are discussed in this chapter.

### 3.1 Overview of the airport system flow constraints

Figure 3.1 displays the flow of aircraft through the main components of an airport system (the runways, taxiways, ramp, and gates) and the surrounding terminal airspace (depicted as a set of entry and exit fixes and arrival and departure paths). ATC is also depicted as a resource of the airport system, where the aircraft flow by the air traffic controllers in the form of the flight progress strips (as was described in Chapter 2).

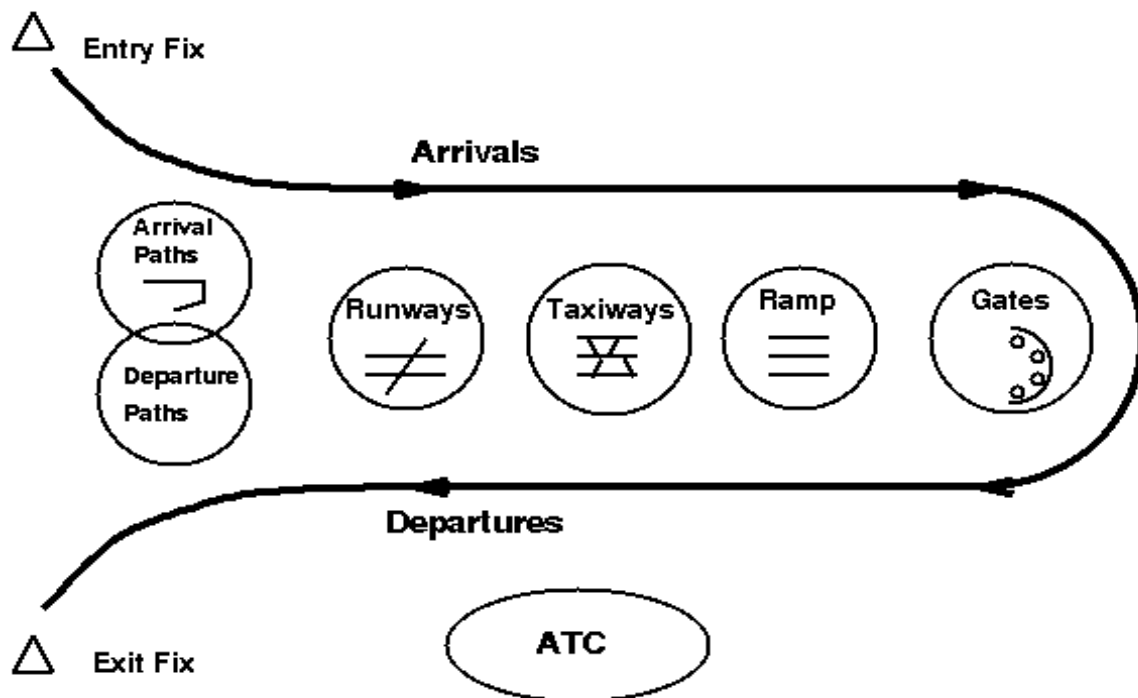

Figure 3.1: The airport system main components

Each of the airport system components in Figure 3.1 constitutes a resource for which the aircraft compete. Therefore, each of the airport resources becomes a potential constraint to the aircraft flow, where aircraft queue and wait to use the resources whenever the demand is high relative to capacity. The



queue formation is therefore a manifestation of the flow constraints, and in order to identify the flow constraints in the departure process the underlying queuing dynamics are observed and analyzed.

Based on the field observations at Logan Airport, It was observed that the airport system dynamics depend at a high level on the aircraft flow pattern on the airport surface and in the terminal airspace. The flow pattern, in turn, is determined primarily by the **runway configuration**, which is the combination of runways that can be used by arrivals and/or departures at any one time. Therefore, the aircraft queuing dynamics are determined at a high level by the strategic runway configuration selection process described first in Section 3.2.

Then given the selected runway configuration and the associated aircraft flow pattern, the flow constraints are caused at the tactical aircraft movement level by the capacities of the airport resources relative to the demand. Given any selected set of runways, it was observed that the departure process forms a complex interactive queuing system, where the queues are a manifestation of the flow constraints. It was also observed that the departure process is a highly controlled process, where the air traffic controllers dictate the aircraft movement in the areas under their control in order to maintain safe operations and to regulate the flow to downstream locations. Therefore, based on these main observations, the departure process was abstracted at the tactical level using a queuing system with controlled blocking described in Section 3.3. Given this abstraction, in Section 3.4 the flow constraints that manifest in the main airport system components (the runways, gates, taxiways and ramps) as well as the downstream flow constraints, are analyzed in terms of their causalities, interactions, and their management by the air traffic controllers.

## **3.2 Strategic runway configuration selection process**

The key observations about the strategic runway configuration selection process are described including: the effect of the runway configuration on the flow pattern and the operating rules of the aircraft movement; the effect of the runway configuration on setting the airport system arrival and departure rate capacities and the main factors that are taken into account in the runway configuration selection process.

### **3.2.1 Runway configuration flow patterns and operating rules**

As mentioned in Section 3.1, the **runway configuration** is the combination of runways that can be used by arrivals and/or departures at any one time. Therefore, each runway configuration employs a particular set of runways and has a corresponding aircraft flow pattern. Also each runway configuration has different operating rules associated with different restrictions on runway use and different interdependence relations between its runways. For example, two common runway configurations at Logan Airport, the 27/22L-22R/22L<sup>17</sup> and the 4R/4L-9/4L/4R runway configurations (depicted in Figure 3.2) are compared below.

---

<sup>17</sup> The runway configuration symbol starts with the list of arrival runways separated by slashes, then a dash, and then the list of departure runways separated by slashes.

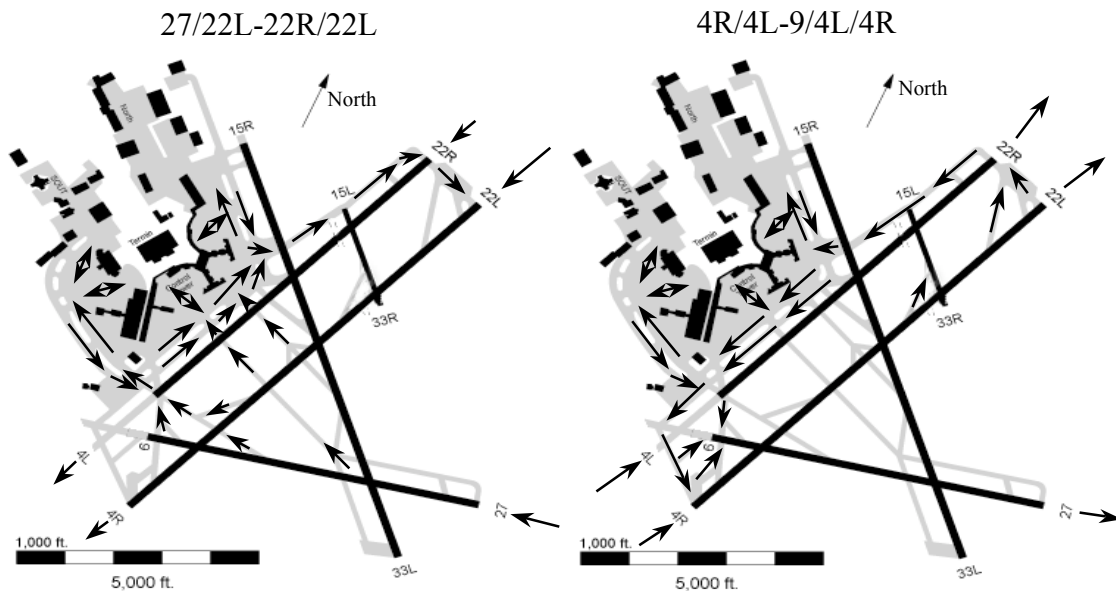

Figure 3.2: Runway assignment and flow patterns under different runway configurations

In the runway configuration 27/22L-22R/22L shown in Figure 3.2, runways 27 and 22L are the primary arrival runways and only specific types of very small aircraft are allowed to land on runway 22R due to noise abatement restrictions. Runways 22R and 22L are used for departure where runway 22R is the primary departure runway while the longer runway 22L is usually requested by heavy departures that need a longer roll before takeoff. Because of the intersection between runways 27 and 22L one local controller, Local Control East (LCE) (see Section 2.2 for a description of the Control Tower positions) is in charge of those two runways while the Local Controller West (LCW) is in charge of runway 22R. However, runways 22R and 22L are dependent parallel runways (less than 2500 ft apart), and therefore LCE is required to coordinate with LCW for releases of all runway 22L departures. A Land and Hold Short Operation (LAHSO) is applied to runways 27 and 22L, which allows simultaneous landings on the two intersecting runways if one of the landings (usually the landing on runway 27) holds short of the intersection; or simultaneous landing on runway 27 and takeoff on runway 22L if the landing on runway 27 holds short of the intersection. Under heavy departure demand runway 22L can be assigned completely to departures and all landings to runway 27 (which is known as the

Accelerated Departure Procedure, ADP) to help increase the departure rate relative to the arrival rate.

In comparison, in the runway configuration 4R/4L-9/4R/4L, also shown in Figure 3.2, runways 4R and 4L are used for arrivals while the three runways 9, 4L and 4R are used for departures with runway 9 being the primary departure runway. Jet approaches are not allowed on runway 4L due to noise abatement; therefore, jet arrivals are allocated to runway 4R and prop arrivals (mainly with departure headings of 225 through 070) are allocated to runway 4L (however, during final descent jets may visually switch from runway 4R to runway 4L). Also runway 4L is not equipped for instrument approach; therefore, in low visibility conditions, aircraft perform instrument approach to runway 15R and once visibility is established they perform visual approach to runway 4L (This variation of the configuration is called 4LVA15R-9). Similarly to the runway configuration 27/22L-22R/22L, LCE is in charge of the intersecting runways 9 and 4R and LCW is in charge of runway 4L. Runways 4R and 4L are also dependent although they are staggered as opposed to runways 22R and 22L. Finally, runway 4R is longer than the other two runways and may be requested by heavy departures.

### **3.2.2 Runway configuration capacity envelopes**

Due to the difference between runway configurations in the number of active runways, in the interdependence between runways and in the associated operating rules, runway configurations possess different capacities for arrival and departure rates. Table 3.1 shows a list of the four main runway configurations at Logan Airport and their reported capacities (under normal conditions). In comparison to the reported capacities in Table 3.1, Figure 3.3 shows the actual arrival and departure rates of Logan Airport under three main runway configurations and runway configurations that employ a single runway. The arrival and departure rates were obtained from the CODAS/ETMS traffic counts per fifteen minute<sup>18</sup> (multiplied by 4 to reflect hourly rates) and

---

<sup>18</sup> For the three main runway configurations, the rates were obtained from the CODAS/ETMS traffic counts in the month of July 1998, which is a high demand season. However, the single runway configuration rates were obtained from the Tower traffic-count records in January 1999 because in July 1998 there was no occurrence of single runway configurations.

the runway configurations were obtained from the Control Tower daily logs (see Chapter 2). The extreme points (maximum arrival and departure rates achieved) are connected to show the capacity envelope for each runway configuration.

Runway configuration	Hourly rate capacity (arr-dep)
4R/4L-9/4L/4R	68 - 50
27/22L-22R/22L	60 - 50
33L/33R-27/33L	44 - 44
15R/15L-9	44 - 44

Table 3.1: Reported capacities of four main runway configurations at Logan Airport

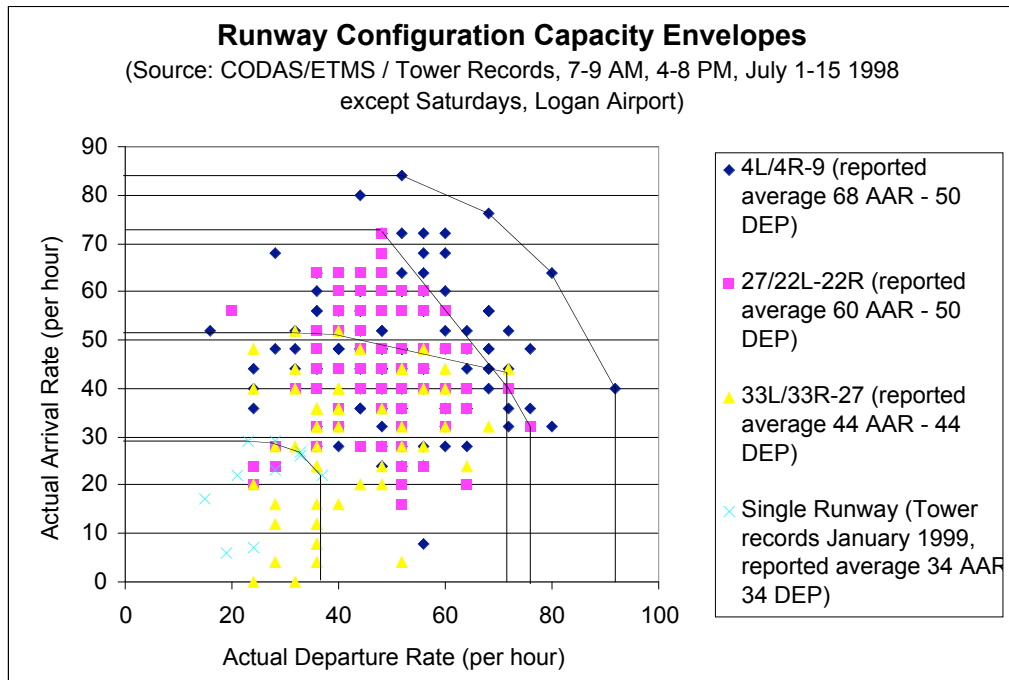

Figure 3.3: Capacity envelopes under different runway configurations

Figure 3.3 shows the difference between the main runway configurations in terms of their maximum rate capacities, where the 4R/4L-9/4R/4L runway configuration has the highest capacity (as reported) followed by the 27/22L-22R/22L and the 33L/33R-27 runway configurations. Runway configurations that employ a single runway have the lowest capacity as shown in Figure 3.3. The capacity envelopes in Figure 3.3 indicate also a tradeoff between the arrival and departure rates as the maximum rate capacity of the runway configurations is approached. In other words, when operating near the capacity envelopes, a reduction or increase in the departure rate is associated with an increase or reduction (respectively) in the arrival rate. This tradeoff reflects a heavy interaction between the arrivals and departures, caused by the runway sharing and runway interdependence associated with the runway configuration flow patterns, as described in Section 3.2.1.

#### ***Discrepancy between reported and actual rate capacities***

While the single runway configuration reported capacity of 34 arrivals and departures an hour approximately matches the actual rates observed, there is a clear discrepancy between the reported capacities and the maximum actual rates achieved of the three main runway configurations displayed in Figure 3.3. One source of the discrepancy is that the capacity envelopes of the actual data reflect the highest rates observed (during busy periods of the day) while the reported capacities reflect the Control Tower's estimation of the feasible average capacity based on experience. (It should also be noted that the actual hourly rates observed were computed from ETMS traffic counts in 15-minute periods, which may contain occurrences of high throughputs that are hardly maintained over one hour). Another source of discrepancy is that the reported capacities are based on simple engineering standards, which may not be accurate and are outdated as noted by ATC personnel in the Control Tower. (For example, the 68-arrival rate for the 4R/4L-9/4R/4L runway configuration, which has two, more or less independent, arrival runways is simply set as twice the 34 rate for a single runway). It is clear from the capacity envelopes in Figure 3.3 that under favorable conditions the airport is capable of achieving higher rates than the reported capacities, particularly for departures. The reported

rates, therefore, may hinder the actual operations if they are used for flow management purposes<sup>19</sup>.

### **3.2.3 Arrival/departure tradeoff and operating modes**

A runway configuration is usually sustained for relatively long periods of time (longer than one hour) except in rapidly changing circumstances, which require a sudden and temporary closure of an active runway. For example, weather conditions or scheduled maintenance might force closing a runway temporarily. During the operation of a specific runway configuration, the Control Tower employs the tradeoff between arrival and departure rates (which is depicted in the capacity envelopes in Figure 3.3) dynamically in order to match short-term fluctuations in demand. Given the relative arrival/departure demand, the Control Tower may decide to shift the airport operation within the capacity envelope of the runway configuration towards more arrivals or departures. Therefore, at any given time the airport system may be operating in a specific region within the capacity envelope, called here an **operating mode**.

Depending on the runway configuration, there are a number of procedures that are used to switch the airport operation between operating modes. A common example at Logan Airport is the Accelerated Departure Procedure (ADP) in the 27/22L-22R/22L runway configuration, where runway 22L is switched from serving primarily arrivals to serving departures only, for a period of time. ADP is used when faced with long departure queues for the main departure runway 22R, where switching the runway 22L from arrivals to departures helps deplete the long queues, if the arrival demand can be accommodated by runway 27 solely. The effect of this procedure is shown in Figure 3.4, where the arrival and departure rates in the 15 minute periods when ADP was employed are superimposed on the capacity envelope of the 27/22L-22R/22L runway configuration. The ADP periods show a clear shift of the airport throughput towards more

---

<sup>19</sup> The Control Tower managers and personnel are aware of the discrepancies between the actual and reported capacities and use the reported capacities as indicators rather than hard limits. The reported capacities are also adjusted depending on weather, airport surface conditions, and equipment and staffing, based on experience.

departures relative to arrivals, as desired. When ADP is in use the reported airport departure rate capacity is raised from 50 departures an hour to be 60 departures an hour.

Accelerated Departure Procedure (ADP) under the runway configuration 27/22L-22R/22L

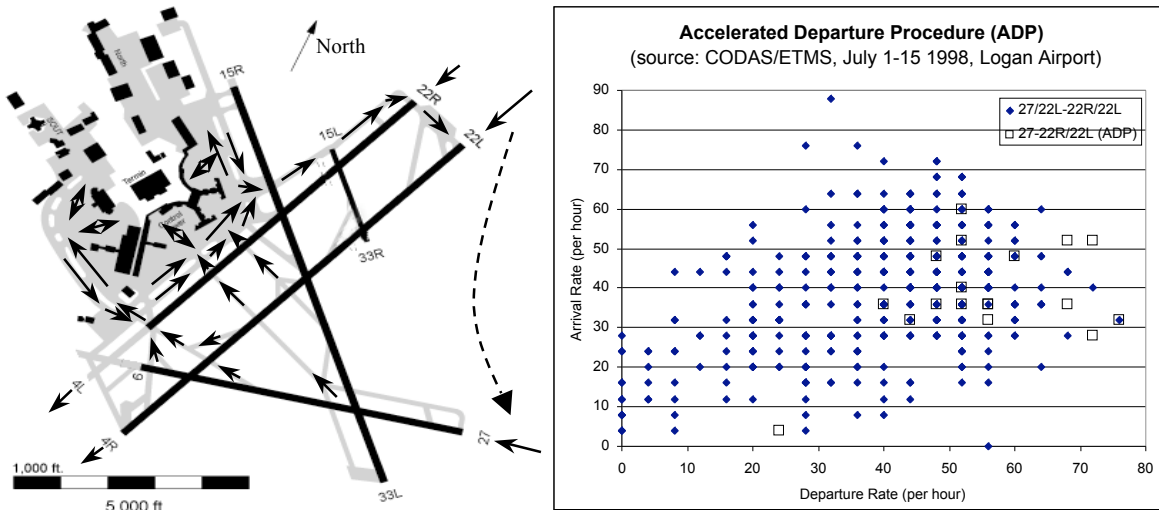

Figure 3.4: Operating modes for short-term demand matching (ADP)

Other observed procedures for trading off arrival and departure rates include requesting approach controllers to provide a gap in the arrival stream to insert one or more takeoffs, and requesting in-trail spacing on the arrival stream in order to establish a more regular flow with slightly larger landing gaps. In extreme situations, the Control Tower resorts to reducing the arrival rate by setting a maximum rate (metering) or stopping all arrivals.

The priority of arrivals over departures in using the runways affects the Control Tower strategies in balancing the arrival and departure rates, favoring arrivals in general. For example, as pointed out by the Control Tower personnel, restrictions are imposed on the arrival rate (relative to the departure rate) only after delays are incurred by departures. Commonly, restrictions on the



arrival flow are imposed after 15-minute departure delays are reported<sup>20</sup>, and such that the arrival delays are also maintained below 15 minutes. Then further restrictions on the arrival flow are imposed after the departure reported delays reach 30 minutes and so on.

### **3.2.4 Runway configuration selection factors**

Figure 3.5 depicts the inputs and outputs of the runway configuration selection process. The selected runway configuration determines a capacity envelope of the airport system, within which the airport may operate at an Airport Acceptance Rate (AAR) and an Airport Departure Rate (ADR) (as was described in Sections 3.2.2 and 3.2.3). As shown in Figure 3.5, the runway configuration selection is made considering the following criteria (in order of decreasing priority according to the SOP and to conversations with Tower Supervisors):

- Runway availability (for example, closures due to scheduled MPA/FAA<sup>21</sup> maintenance activity).
- Current and forecasted weather.
- Required arrival and departure rates for projected traffic volume (arrival and departure demand).
- Noise mitigation.

---

<sup>20</sup> Delays are reported in the ATC system in increments of 15 minutes. Departure delays of 15 minutes are reported once the first departure incurs a delay of 15 minutes. Then 30-minute departure delays are reported once the first departure incurs a delay of 30 minutes and so on. A delay is computed as the time between the larger of the proposed pushback time and the time the aircraft calls ready and the wheels-off time, after accounting for an average taxi out time. The delay reporting method in the ATC system may be misleading in some cases. For example, a delay of 14 minutes is not reported because it is below the 15-minute threshold, and aircraft may be experiencing a 29-minute delay while 15 minutes are reported because of the 15-minute increments.

<sup>21</sup> MPA is Mass Port Authority in charge of the airport and FAA is the Federal Aviation Administration in charge of the Air Traffic Control system

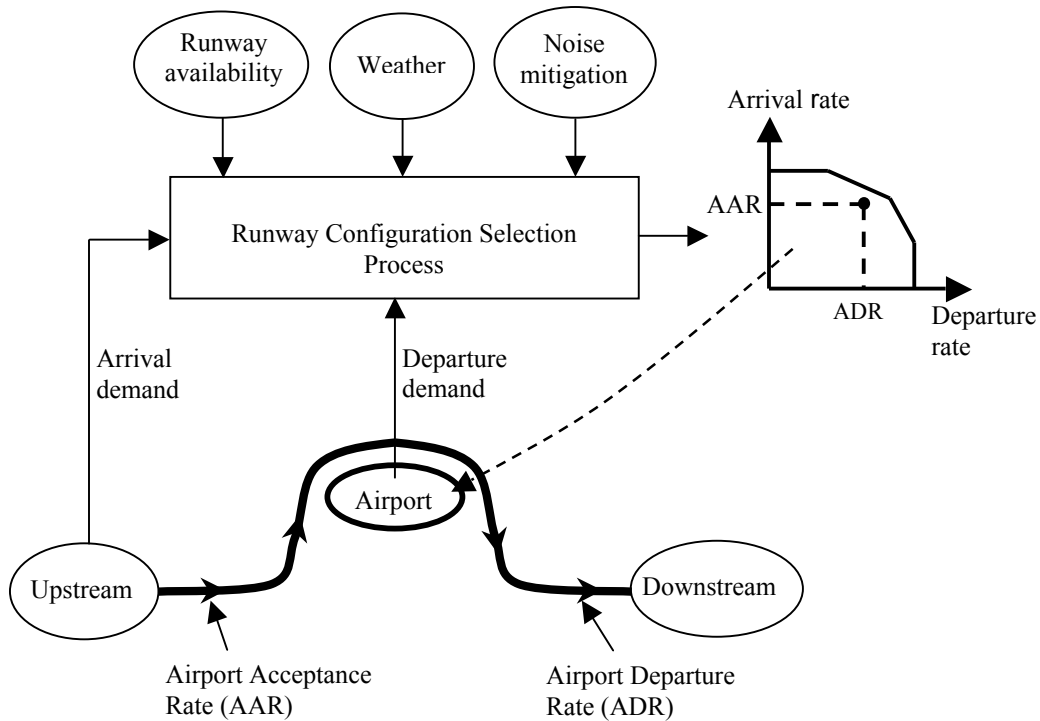

Figure 3.5: The strategic runway configuration selection process

### 3.2.4.1 Weather

The weather conditions constitute hard constraints on the runway configuration selection process in order to maintain safe runway operation. According to (FAA, BOS TWR 7040.1F) a runway can be operated with a maximum allowable tail wind of 5 knots and a maximum allowable cross wind of 15 knots. Also due to limitations in the runway equipage, certain runways cannot be operated in adverse weather conditions in terms of ceiling and visibility. For example, runways 4L-22R, runway 9, and runway 33R-15L are not equipped for instrument landing and can only be used for visual approaches.

Figure 3.6 shows an example of the effect of weather on the runway configuration decision process at Logan Airport in the winter month of January 1999. According to the TMC logs, about one quarter of the 200 runway configuration changes that occurred in the month of January was attributed to adverse and changing weather conditions such as ceiling, visibility, rain and snow. About 10 and 5 percent of the runway configuration changes could be attributed to tail and cross wind, respectively. Therefore, overall weather accounted for less than half of the runway configuration changes. The other changes are due to the factors of demand accommodation and noise mitigation, as will be described next.

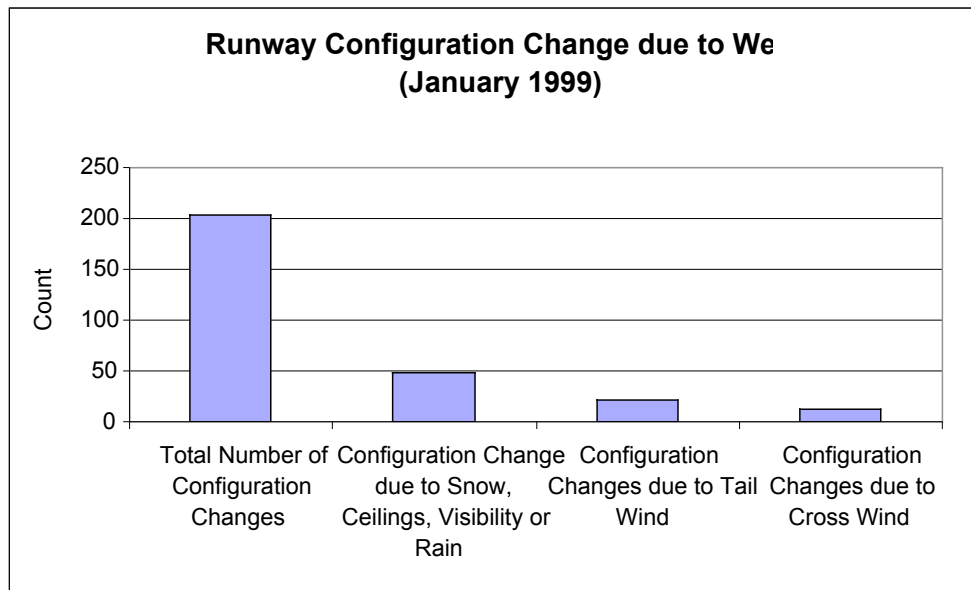

Figure 3.6: Weather effects on the runway configuration selection process

### 3.2.4.2 Demand matching

Having satisfied the weather restrictions, the runway configuration is selected in order to match the demand with the configuration capacity. Figure 3.7 displays the relative utilization of the different runway configurations at Logan Airport in the month of January 1999 (according to the Control Tower TMC logs). As shown in Figure 3.7, during the evening rush hours (between

hours 15 to 21) when the demand is high, the highest capacity runway configurations 4R/4L-9 and 27/22L-22R (see Table 3.1) were used more extensively than the other runway configurations. While the lower capacity runway configuration 33L-27 was used mostly during the more moderate-demand hours of the day (between 8 and 13), along with the 27/22L-22R configuration. During the night hours (0 to 5) low capacity runway configurations that consisted mainly of a single runway were used because the demand is low and the configurations are preferred by noise mitigation measures as described next.

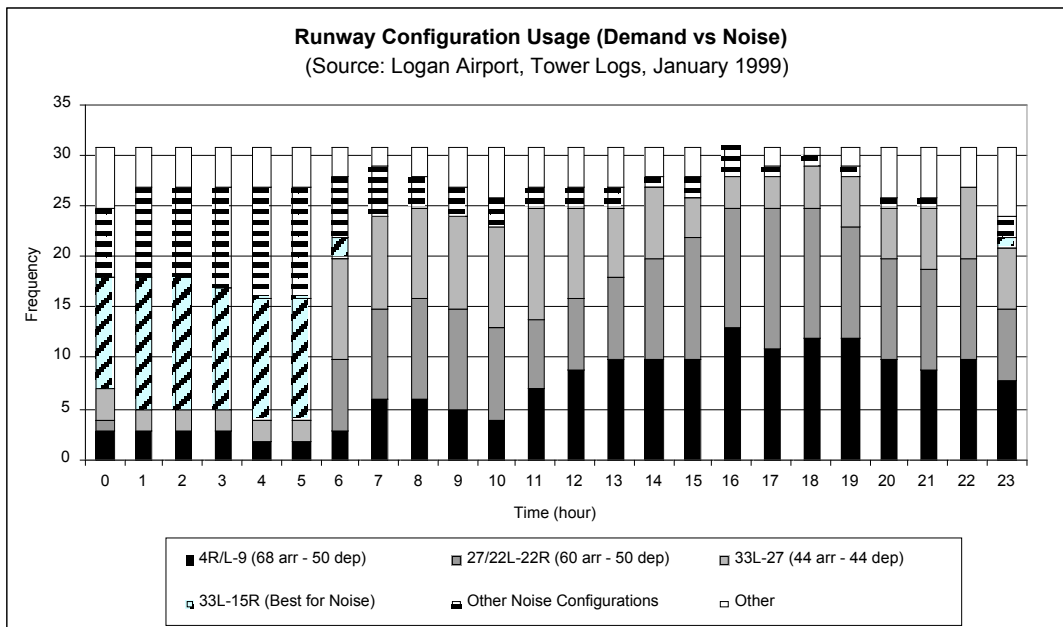

Figure 3.7: Demand and noise effects on the runway configuration selection

### 3.2.4.3 Noise mitigation

Noise abatement policies (FAA, BOS TWR 7040.1F) which ensure the mitigation of the noise effect on the residential areas surrounding the airport, are the last factor for the runway configuration decision process. The noise abatement policies consist mainly of preferred runway assignment, special routes that avoid flying at low altitude over populated areas, restrictions on

certain runway jet operations and night curfews. For example, jet approaches and takeoffs are prohibited on runway 4L-22R due to noise abatement, which affects the performance of the runway configurations that employ these runways. Night curfews restrict the airport operations in the noise sensitive hours between midnight and 6AM, to those that are most favorable by noise mitigation measures. For example, the most preferred runways in terms of noise mitigation are runway 33L for arrivals and runway 15R for departures, since the arrival approaches to 33L and departures from 15R are performed over the ocean. Therefore, as shown in Figure 3.7, the runway configuration 33L-15R (and other noise-preferred configurations) is used heavily over the night hours (0 to 5), as recommended by the noise abatement policies.

In order to help comply with the noise abatement policies, the Preferential Runway Advisory System (PRAS) is a decision aiding tool that provides recommendations for runway configuration selection to the Control Tower. PRAS attempts to meet long-term goals for each runway's yearly utilization (agreed on by the surrounding communities). Given these goals, PRAS considers the year-to-date noise exposure and the recent 24-hour and 72-hour noise exposures, in addition to the wind, weather and demand, and develops hourly recommendations for preferred runway usage (according to the PRAS document that was provided by the Control Tower).

A tradeoff exists between attempting to reach the runway utilization goals set by the noise abatement policies and attempting to match the demand. For example, Figure 3.7 shows that while the use of the highest capacity runway configurations (4-9 and 27-22) is concentrated in the evening high demand period, the use of the somewhat lower-capacity runway configuration 33-27 (see Table 3.1) is more concentrated in the midday hours where the demand is lower. According to conversations with the Control Tower Supervisor at Logan Airport, the 33-27 runway configuration is used as often as possible during the moderate demand hours in order to reach the high utilization goal of the noise-preferred runway 33L. This also allows the use of the higher capacity runway configurations during higher demand periods.

### **3.3 Flow constraints and their management in the aircraft movement process**

As mentioned in Section 3.1, given the selected runway configuration and the associated aircraft flow pattern, the flow constraints are caused at the tactical aircraft movement level by the limited capacities of the airport resources relative to the demand. Given any selected runway configuration, it was observed that the departure process forms a complex interactive queuing system, where the queues are a manifestation of the flow constraints. It was also observed that the departure process is a highly controlled process, where the air traffic controllers dictate the aircraft movement in the areas under their control in order to maintain safe operations and to regulate the flow to downstream locations. Therefore, based on these main observations, the departure process was abstracted at the tactical level using a queuing system with controlled blocking as described in this section.

#### **3.3.1 An interactive queuing system (27/22L-22R/22L example)**

As described in Section 3.2.1 the aircraft movement on the airport surface is highly dependent on the flow pattern and the operating rules of the current runway configuration. The aircraft movement process was, therefore, observed under different runway configurations at Logan Airport, and it was concluded that, despite the differences, the underlying dynamics are common in terms of the key types of queues and the key interactions between them. Therefore, the queuing behavior is described in detail under one of the main runway configurations at Logan Airport, the 27/22L-22R/22L runway configuration (Figure 3.8), (while another example is provided in Appendix B).

As shown in Figure 3.8, based on the field observations at Logan Airport, the aircraft movement process forms a network of queues, where aircraft wait to operate on the airport resources such as gates, ramp, taxiways and runways and to use the routes and fixes in the terminal airspace. Figure 3.8 depicts, in detail, the observed queue formations under the runway configuration

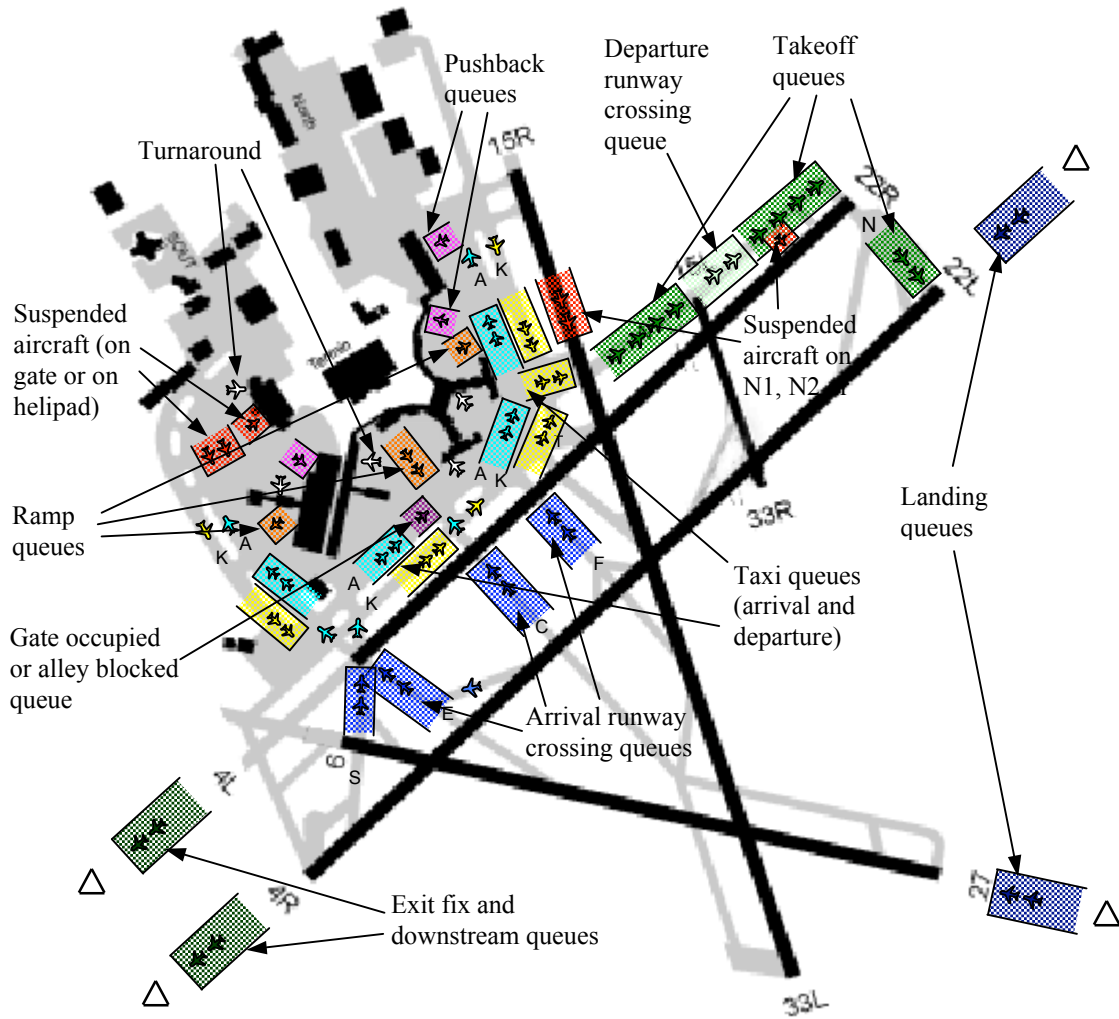

Figure 3.8: Observed queuing network under the 27/22L-22R/22L runway configuration

27/22L-22R/22L on an airport surface diagram, where color codes are used to differentiate between the different types of aircraft queues.

**Arrival flow and queues**

Arrival aircraft form **landing queues**, shown in Figure 3.8 with dark blue, waiting for the arrival runways 27 and 22L. After receiving the landing clearance from the Local East controller they

perform the landing and exit the runway through one of the runway exits. Once clear of the runway, the arrival aircraft may then join **runway crossing queues** (indicated in blue in Figure 3.8) to cross the departure runway 22R. At that point they are handed off to the Local West controller who is in charge of runway 22R and coordinates the runway crossings and departure takeoffs. Once cleared to cross the runway, arrival aircraft taxi across the runway and are handed off to the Ground controller. (Most of the time the clearance to cross the runway and the handoff instruction are delivered simultaneously). Once handed off to the Ground controller, arrival aircraft enter the taxiway system and may join a series of **arrival taxi queues** (indicated with light blue in Figure 3.8). In the arrival taxi queues, aircraft wait for the clearance to taxi to the ramp and a taxi route assignment from the Ground controller, then they mix with the other aircraft traffic on the taxiways. If the assigned gate is occupied by another aircraft or the gate alley leading to the gate is blocked, the arrival aircraft have to wait and form a **gate-occupied queue** or a **blocked alley queue** (indicated with violet in Figure 3.8). These aircraft may be held on a taxiway segment, especially the inner taxiway, Alpha (indicated with letter A in Figure 3.8) and would then block taxiing aircraft until access to the gate is given.

On the gate or in a parking area, the aircraft undergo **turnaround** operations, which turn an arrival aircraft into a departure (aircraft in the turnaround state are indicated with white in Figure 3.8). There may be an idle period between the end of arrival operations and the start of departure preparations depending on the airline's schedule and in some cases a change in the gate assignment, which may require towing the aircraft to a different gate for the departure process.

### ***Departure flow and queues***

The departure process at Logan Airport starts somewhat differently between jet aircraft and propeller-driven aircraft (props). The main difference is that jet aircraft mostly require a pushback operation off the gate and then start their engines, while props do not require a pushback; rather they simply taxi in and out of their parking spaces on an apron near a shared gate. A jet aircraft, after the turnaround operations, is ready for pushback and the pilot calls the pre-clearance delivery controller (usually the Gate controller at Logan Airport), declaring that the aircraft is ready. At that point the jet aircraft enters a **pushback queue** (indicated with pink



in Figure 3.8) and waits for a pushback clearance. The pre-clearance or Gate controller instructs the pilot to contact the Ground controller while handing off the corresponding flight progress strip to the Ground controller. The Ground controller delivers the pushback clearance to the jet aircraft according to a First Come First Serve (FCFS) sequence, unless there are conflicts or departure restrictions that require holding the aircraft on the gate. Once the pushback clearance is delivered, the aircraft enters a **ramp queue** (indicated with orange in Figure 3.8) and the pushback operation can commence. Then the aircraft is pushed back in a gate alley (or on a taxiway segment depending on the gate location) and the pilot starts at least one engine, preparing the aircraft for taxi. Once ready for taxi, the pilot calls the Ground controller to indicate that the aircraft is ready for taxi and waits for the taxi clearance. For props, after the turnaround operations, the aircraft is ready for taxi since no pushback is required. The prop aircraft joins the ramp queue once the pilot calls the pre-clearance (or Gate) controller, indicating that the aircraft is ready. Then the aircraft is handed off to the Ground controller, and waits for the taxi clearance to be delivered by the Ground controller.

The Ground controller delivers the clearance to taxi for jets and props waiting in ramp queues, unless there are any circumstances that require holding the aircraft, and assigns each aircraft a taxi route assignment to the assigned runway, or to an intermediate holding point. The aircraft then join the taxiway system near the terminal buildings, forming **departure taxi queues** (indicated with yellow in Figure 3.8) and may mix with taxiing arrival aircraft. As observed, the Ground controller attempts to assign departure aircraft to the outer taxiway Kilo and arrival aircraft to the inner taxiway Alpha (indicated in Figure 3.8 with letter K and A, respectively) to reduce conflicts as much as possible. The Ground controller may sequence aircraft at merging points and intersections, and hold aircraft if there are any restrictions or events that require holding.

In this example, all departure aircraft then head in the same direction towards the runways 22R and 22L on taxiway November (indicated with letter N in Figure 3.8) where they form the takeoff queues. Around the entry point to the November taxiway, the Ground controller hands off the aircraft control to the Local West controller in charge of runway 22R by delivering the instruction to the pilot to "Monitor the Tower" (and usually to join the November taxiway in an

assigned sequence). At this time, aircraft taking off on runway 22R enter a **takeoff queue** (indicated with green in Figure 3.8) and wait for a takeoff clearance. Aircraft taking off on runway 22L form a **runway crossing queue** (indicated with light green in Figure 3.8) and wait for a clearance to cross runway 22R to runway 22L. Once cleared to cross the runway 22R by the Local West controller, these aircraft enter a takeoff queue waiting for a takeoff clearance from the Local East controller in charge of runways 22L and 27. After takeoff, all departure aircraft are handed off to the Initial Departure controller in the TRACON. From that point, they enter a series of **exit fix queues** (indicated with dark green in Figure 3.8) to exit the terminal area and **downstream queues** at air routes and fixes further out along their flight path.

If there are events or restrictions that require holding the departure aircraft for a long time (such as a mechanical problem with the airplane or a long ground delay restriction), the departure may be **suspended** in designated delay absorbing areas to avoid blocking the aircraft flow stream. Suspended aircraft are shown with red in Figure 3.8. Suspended aircraft may be held on gates, which are not needed by other aircraft, or in the helipad. In this runway configuration it is possible to hold departure aircraft that are already in the takeoff queue but are not able to take off, on the short taxi segments (N1, N2 and N3) leading away from the November taxiway, or on the inactive runway 15R as indicated in Figure 3.8.

### **3.3.2 A controlled queuing system**

Based on the observed airport operation described in Section 3.3.1, it is evident that the aircraft flow in the departure process is highly controlled, since the air traffic controllers dictate the aircraft movement entirely in their delegated areas of responsibility<sup>22</sup>. This high level of control is accomplished mainly through the communication between the air traffic controllers and the pilots.

---

<sup>22</sup> On areas delegated to airline control such as gates and certain gate alleys, aircraft movement and operation are coordinated by the airline's station.

As described in Section 3.3.1, in general, after the aircraft completes one phase of the departure process and is ready for the next, the pilot calls the air traffic controller in charge, stating that the aircraft is ready for the next phase. The air traffic controller then gives the approval, as appropriate, by delivering a control instruction<sup>23</sup>. The main control instruction is the **ATC clearance**, which is the instruction issued by the air traffic controller to an aircraft to perform an operation using an airport resource that is under his or her control. Opposite the clearance instruction is the instruction to **hold**, where the hold instruction is assumed unless the clearance is delivered explicitly. The control instruction may include a **route** (such as a taxi route assignment to the designated runway) or a **sequence** (such as sequencing at merging points from the alleys into the taxiway or sequencing the takeoff queue at the entry into the November taxiway). These instructions may be combined; for example, a controller may instruct aircraft A: “Give way to aircraft B, then clear for taxi to runway 22R, via Alpha, Kilo and November.” Such an instruction includes a taxi route, a runway assignment, and a sequence behind aircraft B, as well as the clearance to use the taxiway resources. In cases of aircraft-specific circumstances that require absorbing delays, aircraft may be **suspended** either on the gate or in delay absorbing areas. If the next operation is under the control of another air traffic controller, a **handoff** is required. The air traffic controller in this case hands off the flight progress strip to the next controller and instructs the aircraft to change the communication channel frequency. The next air traffic controller then delivers the control instruction.

Therefore, the aircraft movement process is an interactive queuing network where aircraft queue waiting to use the airport resources and a highly controlled process where the air traffic controllers dictate the aircraft movement through the airport resources. This is depicted at an abstract level in Figure 3.9, where the main observed queues are superimposed on the aircraft flow in the generic airport system representation of Figure 3.1. The queues are associated with the main airport system resources, the gates, ramp, taxiways, runways and exit fixes (matching Figure 3.8). Controlled transition bars are added between the queues with dashed arrows

---

<sup>23</sup> In many instances, an air traffic controller who is monitoring the progress of the aircraft under his or her control may realize that the aircraft is ready for the next phase. The controller then may proceed to deliver the control instruction without any prompting from the aircraft.

emanating from an airport resource and from an air traffic controller to each transition. The dashed arrows leading to the transitions represent abstractly that both controlled resources and air traffic controller instructions are required for the aircraft to operate on the resources and flow through the airport system.

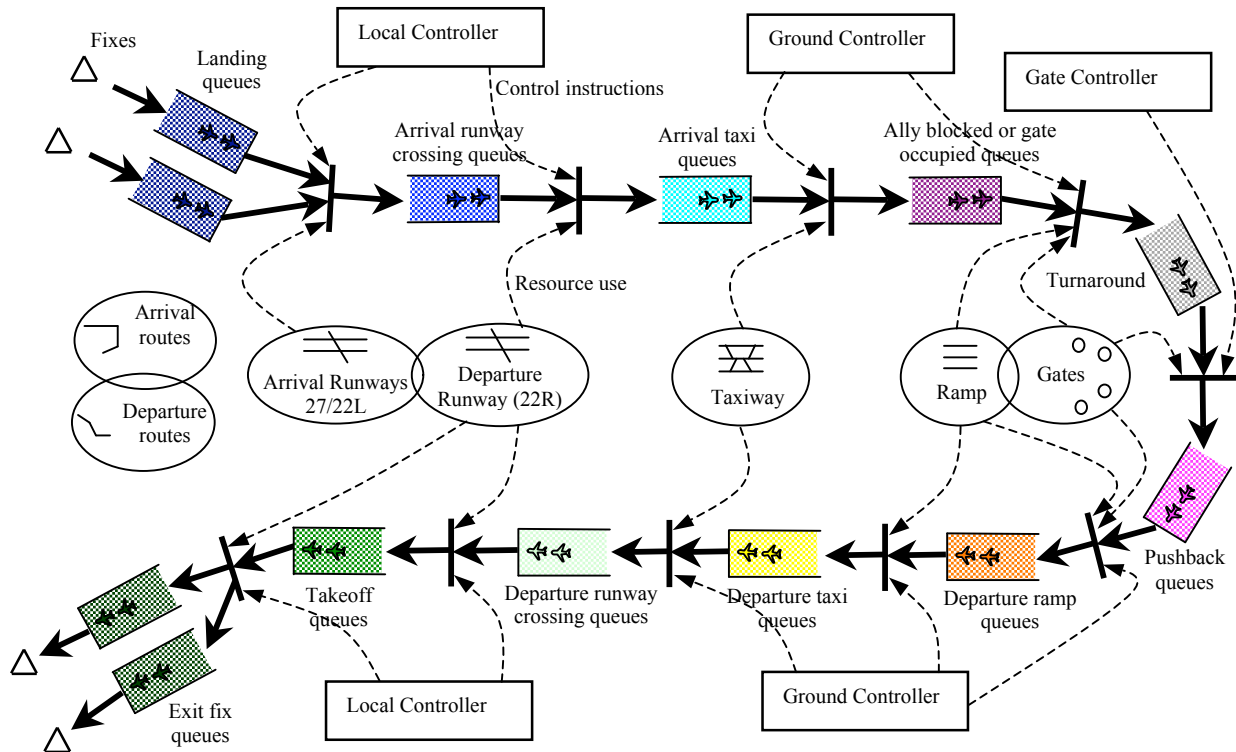

Figure 3.9: Aircraft movement process as a controlled, interactive queuing system

Based on the observation that the aircraft movement process is a controlled interactive queuing system, in the next two subsections, the basic observed operation of the airport resources under ATC control is abstracted using a queuing representation with controlled blocking. First it is focused on the operation of a single airport resource and then on the interaction between multiple resources.

### **3.3.3 Operation of a single airport resource**

Focusing first on a single airport resource, the observed operation described in Section 3.3.2 is abstracted using a controlled queuing representation. A queuing element is used to represent the delay incurred by an aircraft whenever it waits to use the airport resource. At the same time control elements are used to represent the main control instructions exercised by the air traffic controllers in charge of the resource.

#### **3.3.3.1 Queuing representation of the operation of an airport resource**

Based on the observed behavior of the airport system, in order to perform an operation, an aircraft uses three types of airport system resources: 1) An **airport controlled resource** such as a gate, a ramp, a taxiway or a runway, which are under the control of air traffic controllers; 2) an **air traffic controller** in charge of the controlled airport resource, who monitors the aircraft and delivers to it the instructions to operate on the resource; and 3) a **communication channel** that provides the communication means between the pilot and the air traffic controller. Since these resources are scarce, delays are incurred whenever the demand is higher than the available capacity, causing associated queues to form. This is depicted in Figure 3.10, which represents the operation of a generic airport resource as a queuing system that includes the three main types of airport system resources.

In Figure 3.10, an aircraft queue represents the delays incurred by the aircraft demanding operation on a controlled airport resource. The aircraft corresponding flight progress strips form a queue (in flight strip bays in the Control Tower) representing the delays caused by waiting for the air traffic controller in charge of the resource. And finally, communication queues represent the delays caused by the communication channel, where multiple aircraft may simultaneously attempt to communicate with one controller through one communication channel. Based on the observed operation, three main types of communications are needed to allow an aircraft to operate on a resource as shown in Figure 3.10. They include: 1) aircraft state information delivered from the pilot to the air traffic controller (declaring mainly that the aircraft is ready to

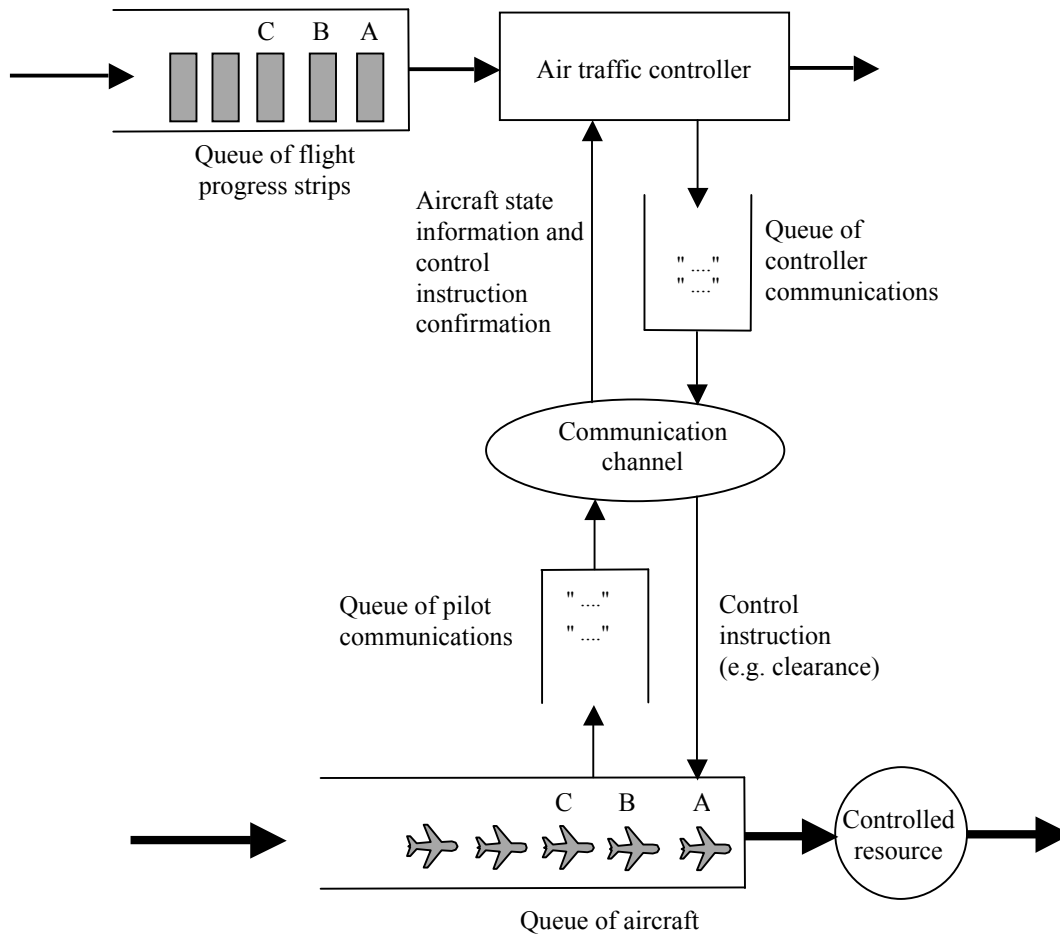

Figure 3.10: Single airport resource operation

perform an operation); 2) control instructions from the air traffic controller to the pilot, including mainly the clearance to use the resource and complementary instructions such as a route and/or a sequence; and 3) repetition of control instructions by the pilot to the air traffic controller in order to confirm the proper reception of the instructions. Therefore, the time that an aircraft spends in the queue in Figure 3.10 is caused by waiting for the controlled resource, as well as by waiting for the air traffic controller and for the communication channel.

### 3.3.3.2 The clearance/hold control mechanism

Based on the above description of the airport resource operation (in Section 3.3.3.1) an aircraft cannot operate on a controlled airport resource until a “clearance” instruction from the controller in charge of the resource is obtained. If a clearance was not obtained, the aircraft waits, either due to receiving an explicit “hold” instruction from the controller or due to the controller’s denial of the clearance. Therefore, the “clearance/hold” instruction constitutes the most basic control mechanism exercised by the air traffic controllers in order to control every airport resource.

The basic operation of a controlled airport resource through the clearance/hold control mechanism is abstracted in Figure 3.11 for a generic, single resource system. Aircraft enter the system when they demand operation on the resource (for example, by informing the controller that the aircraft is ready to operate on the resource) and form a queue in front of the resource. The clearance/hold control mechanism is represented with a switch between the controlled resource and the aircraft queue, controlled by an air traffic controller. The control action of the air traffic controller, which is the clearance or hold instruction, is represented with an arrow extending from the controller to the switch. The default instruction of the air traffic controller is to “hold” the aircraft or simply deny the clearance from the aircraft. Correspondingly, the switch is in a default “open” state and the default state of an aircraft in the queue is to hold.

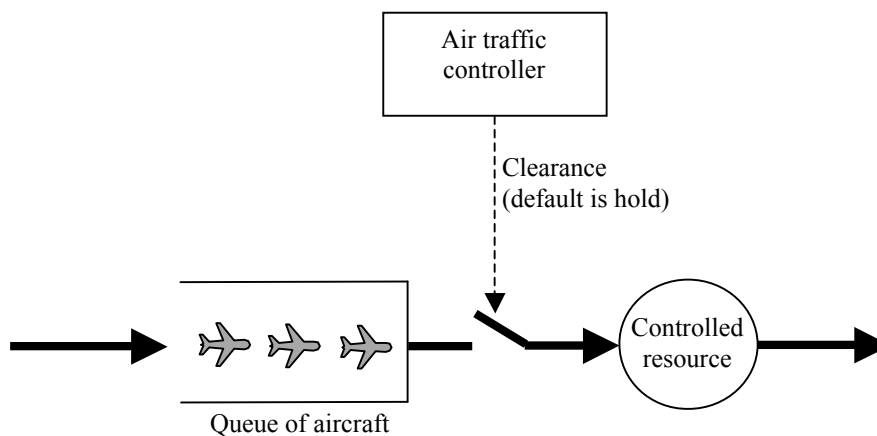

Figure 3.11: The clearance/holding mechanism

In this controlled queuing representation, the first aircraft in the queue in Figure 3.11 can proceed to operate and occupy the resource only after the clearance instruction is delivered to it. Then, the second aircraft remains held by the default open state of the switch, until cleared by the air traffic controller. The controller may clear the second aircraft while the first occupies the resource if more than one aircraft can operate on the resource simultaneously. For example, multiple aircraft can cross a runway simultaneously and multiple aircraft can taxi on a taxiway segment. Otherwise, the controller clears the second aircraft after the first exits from the resource (ends its operation on the resource) and after any restrictions or circumstances that may require additional holding of the aircraft as described in Section 3.3.1.

### **3.3.3.3 Sequencing, suspending and routing**

While the clearance/hold instruction is the most basic control mechanism that applies to every controlled airport resource, complementary control instructions such as sequencing, routing and suspending may apply under specific conditions, as was described in Section 3.3.2. Namely, these complementary control instructions are applicable when the queuing system consists of multiple interconnected resources and queues, such that the air traffic controller has the opportunity to instruct a sequence, or a route, or suspend the aircraft operation in inactive areas of the airport. Figure 3.12 shows an abstract representation of the control mechanisms associated with these instructions, applied to the queuing system of a single controlled airport resource, with multiple interconnected upstream and downstream queues.

**Sequencing** may be exercised between aircraft demanding operation on a resource from multiple queues, such as aircraft A and B in Figure 3.12. For example, the air traffic controllers may sequence aircraft pushing back on the same ramp or gate ally, at merging and intersection points on the taxiways and from multiple takeoff queues at a runway end (See the queuing network in Figure 3.8). Based on the observed behavior, sequencing is normally First Come First Serve (FCFS), although it may be dictated by certain strategies (such as alternating aircraft types or exit fixes) or by certain restrictions that may require a separation between aircraft, as will be described in the Section 3.4.



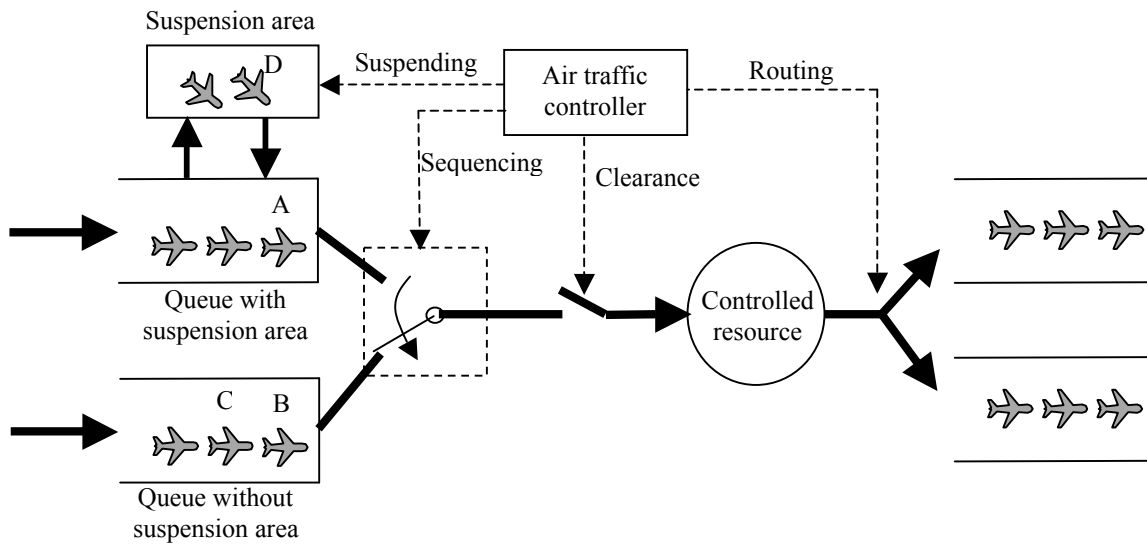

Figure 3.12: Sequencing, suspending and routing

**Suspending** (as described in Section 3.3.2) is delaying a particular aircraft due to aircraft-specific conditions (such as mechanical problems or ATC restrictions). In order to avoid impeding the flow of other aircraft, suspending is implemented in suspension areas (delay absorbing areas such as parking areas or penalty boxes) if available as shown in Figure 3.12 where a suspension area is associated with one of the queues. (Otherwise, suspending can only be implemented through holding the clearance, resulting in blocking the other aircraft in the queue). When a suspension area is available, aircraft (such as aircraft D in Figure 3.12) can be pulled out of the queue and returned back to the queue under the control of the air traffic controller. As described in Figure 3.8, any inactive area of the airport surface, such as an inactive runway, a taxiway segment, a helipad, a ramp or a gate, can be used as a suspension area as long as it does not constrain the flow of aircraft. For example, departure aircraft may be suspended on the short taxiway segments N1, N2 and N3 off the November taxiway in Figure 3.8 in order to absorb delays in their takeoff due to circumstances such as late weight and balance numbers, mechanical problems or ATC restrictions. (At some airports there are designated penalty boxes at the runway ends).

**Routing** is represented by the assignment of an aircraft from one upstream resource to one of multiple parallel downstream queues or resources as shown in Figure 3.12. For example, the air traffic controllers may assign different taxi routes leading to the same or to different assigned runways (see Figure 3.8). The air traffic controllers may use routing tactically to manage the flow on the airport surface in order to avoid gridlock<sup>24</sup>, absorb delays and help implement desired sequences.

### **3.3.4 Blocking and flow regulation between interacting resources**

Through the clearance/hold, sequencing, suspending and routing control mechanisms, the air traffic controllers maintain the safe operation of every airport resource. Safety is maintained, at the runway for example, by clearing aircraft takeoffs such that the separation between them required by the ATC rules and procedures is ensured. In addition to the safe operation of each single airport resource, the air traffic controllers use their control instructions to maintain the integrity of the aircraft flow between interacting resources. As described in Sections 3.3.1, the aircraft movement process forms a network of queues, that interact within the airport system and interact with the downstream environment as queues form at downstream locations such as exit fixes. The main observed form of interaction between the resources (within the airport system and resources downstream of the airport system) is the blocking of the aircraft flow from any upstream resource when the finite buffer space capacity of downstream resources becomes full. With the appropriate feedback, the air traffic controllers control this blocking by regulating the flow outbound from the resources under their control in order to maintain the traffic at downstream resources at acceptable levels below capacity. In order to model these observed interactions the notion of blocking is used, first in an open loop system without feedback, and then in a closed loop system under ATC flow regulation.

---

<sup>24</sup> Gridlock occurs when the aircraft movement becomes interdependent. For example when aircraft A is waiting for aircraft B and vice versa, possibly through a chain of other aircraft.

### 3.3.4.1 Blocking in an open loop system

Figure 3.13 shows two resources with finite buffer-space capacities, connected in tandem, without any flow regulation (an open loop system). In such a queuing system with blocking (see e.g. Perros), the flow from the upstream resource to the downstream resource is blocked once the finite buffer space of the downstream resource becomes full. In the absence of flow regulation, this blocking effect may propagate backward to resources further upstream when the blocked resource has a finite buffer space capacity as well and its buffer space becomes filled.

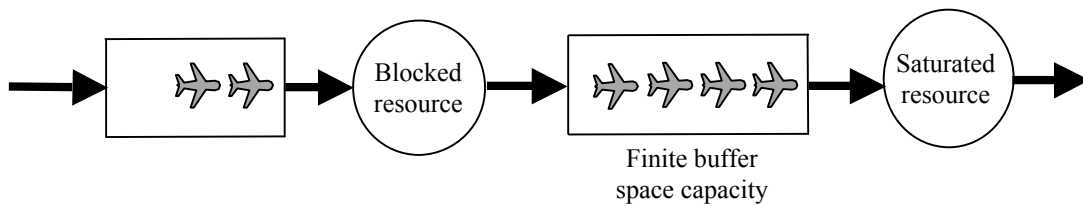

Figure 3.13: Blocking in an open loop queuing system

Referring to Figure 3.8, the airport system resources such as the runways, taxiways, ramps and gates have finite buffer space capacities including any parking areas or penalty boxes that may hold delayed aircraft. The airport system queuing network may be represented, therefore, as a queuing system with blocking, where the blocking effect may propagate between the interconnected resources. During field observations, the blocking effect propagation manifested in the observed overflow between the queues of the different airport resources. For example, when the runway queuing system becomes saturated, aircraft overflow to the taxiway system, and as the taxiway system becomes full, aircraft are held on their gates or in parking areas and penalty boxes.

If the departure throughput is low relative to demand (due to inclement weather for example), and if appropriate flow regulation measures are not taken in time, the congestion level on the airport surface increases rapidly due to the blocking effect and its propagation. Aircraft are

staged in penalty boxes or parking areas, or held on their gates. Gridlock occurs when the movement of aircraft becomes interdependent and the flow circulation through the airport is constrained. The air traffic controllers have to resort to extreme measures to alleviate the situation by reducing the inbound flow, closing runways and holding arrival aircraft in the air, which is costly in terms of safety and delays.

#### **3.3.4.2 Blocking through feedback and the ATC control mechanism**

In order to avoid jeopardizing safety and incurring excessive delays, the air traffic controllers intervene and regulate the flow from upstream resources prior to reaching downstream critical levels of traffic. This is abstracted in Figure 3.14, where through the appropriate feedback and the basic control mechanism (presented in Section 3.3.3.2), the air traffic controllers are able to block the flow from the resources under their control to maintain the state of the downstream resources (usually the number of aircraft) below a critical threshold. Since safety requires that the level of traffic does not exceed an acceptable operational workload level, the threshold is usually set below the maximum capacity, and varies depending on the current conditions. For example, the Airport Acceptance Rate (AAR) -the number of aircraft that an airport can accept in an hour- is set based on the current conditions, including the runway configuration (as described in Section 3.2), the weather, equipment and staffing. Similarly, the Operationally Acceptable Level of Traffic (OALT), which is the number of aircraft that an airspace sector can handle in an hour, is also set to reflect similar current conditions including weather and workload. In order to maintain safety and the integrity of the aircraft flow, the controllers regulate the flow from the resources under their control such that the level of traffic at downstream resources is maintained at or below these acceptable levels below capacity.

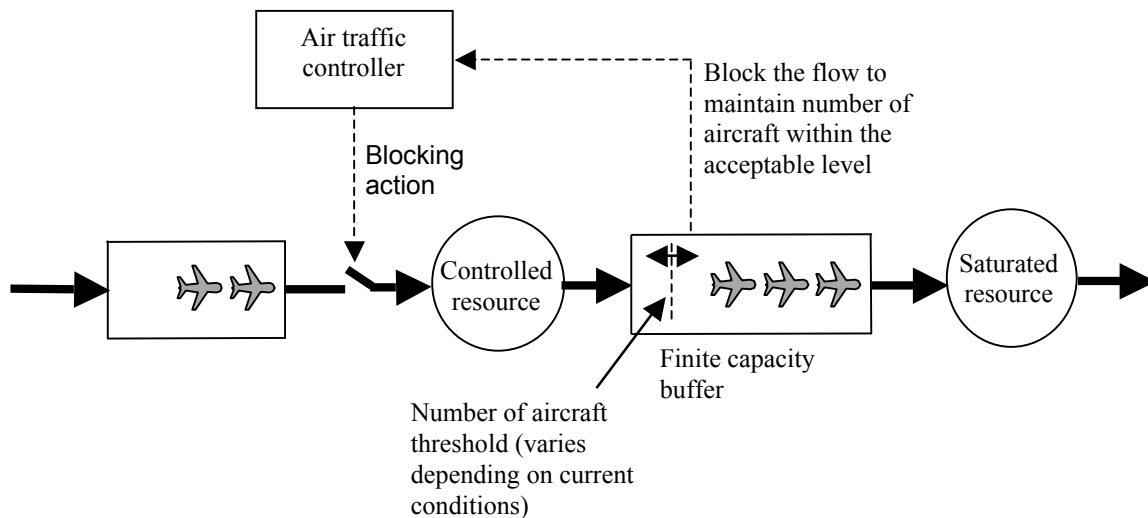

Figure 3.14: Blocking through feedback and the ATC control mechanism

This flow regulation is observed by the air traffic controllers within the NAS (such as regulating the flow from an airport to downstream airports and airspace sectors) and within each airport system (such as regulating the flow from the gates based on the congestion at the runway). For example the main task of the Traffic Management Coordinator (TMC) in the Control Tower is to coordinate with other Air Traffic Control facilities in order to maintain an even flow of aircraft through the NAS. The TMC informs the other ATC facilities of the Airport Acceptance Rate and requests restrictions on the arrival flow if the AAR is low. At the same time the TMC ensures that the outbound flow rate from the airport complies with any restrictions that are imposed due to low acceptance rates at downstream airports and airspace sectors. Within the airport system, one of the main tasks of the Gate controller is to meter the departure flow from the gates based on the downstream congestion level on the airport surface. It was observed during heavy traffic that the Ground controller might explicitly request the Gate controller to hold aircraft on their gates. Through such flow regulation mechanisms, queue saturation and overflow, gridlock and excessive delays are precluded, and acceptable air traffic controller workload and safer operations are ensured.

### **3.4 Flow constraints and their causal factors**

In this Section, an in-depth analysis of the flow constraints that manifest at the different airport resources and their causalities is conducted based on the field observations at Logan Airport. As described in Section 3.3, the aircraft queues are a manifestation of the flow constraints, where aircraft incur delays at each airport resource due to its limited service rate capacity relative to demand. These delays are often imposed through the control actions of the air traffic controllers who manage the flow constraints at single airport resources and between interacting resources as abstracted in Figures 3.11, 3.12 and 3.14. Therefore, causal factors that limit the capacity of the airport resources and, whenever applicable, the strategies of the air traffic controllers in managing the resources are identified. The flow constraint analysis is presented for the main airport resources starting (based on their importance) with the runway system, then the downstream flow constraints, then the gates, and finally the ramp and taxiways.

### **3.4.1 Flow constraints manifest mainly at the runway**

Throughout the extensive observations at Logan Airport, it was observed that while delays occurred at all resources of the airport (gates, ramp, taxiways and runways), the most delays in the departure process were consistently incurred at the runway system. Departure aircraft repeatedly compressed against the runways, in all runway configurations, and formed long queues that propagated back through the taxiway system. Figure 3.15 shows an example of the takeoff queue for the departure runway 22R in the 27/22L-22R/22L runway configuration (see Figure 3.8). The takeoff queue fills the November taxiway and overflows on the taxiways.



Figure 3.15: Takeoff queue for runway 22R

#### ***Communication analysis***

In order to provide supporting examples of the observed behavior, controller/pilot communication data were collected during field observations at Logan Airport as described in Chapter 2. In this section a sample of the communication data is analyzed in order to compare the time that departure aircraft spent in four departure sub-processes defined between five controller/pilot communication events. The five controller/pilot communications events recorded

are the pilot's call "ready for pushback" and four controller clearances: "clear for pushback," "clear for taxi," "monitor tower" and "clear for takeoff." The four departure sub-processes defined between these communication events are used as surrogates for four main operational phases in the departure process, the pre-pushback, ramp, taxi and runway phases as described in Chapter 2 and shown in Figure 3.16.

Figure 3.16 compares the frequency distributions of the time that aircraft spent in the four departure phases, measured by the time between the recorded communication events, for eight rush hours in the runway configuration 27/22L-22R/22L. Figure 3.16 supports the observation that the runway system incurs most delays in the departure process by showing that aircraft spent a much larger time on average in the runway phase than in any of the preceding phases. While some aircraft experienced excessively large delays in all phases (such as the 48 and 84 minute pushback delays in the pre-pushback phase and the 24 minute ramp delay in the ramp phase), the runway phase consumed considerably larger time than the preceding phases on average. Overall for the entire sample, the average time in the runway phase was 9:40 minutes, more than twice the average time in the taxi phase, which was 4:28 minutes and compared to only 3:48 minutes in the ramp phase and 2:38 minutes in the pre-pushback phase.



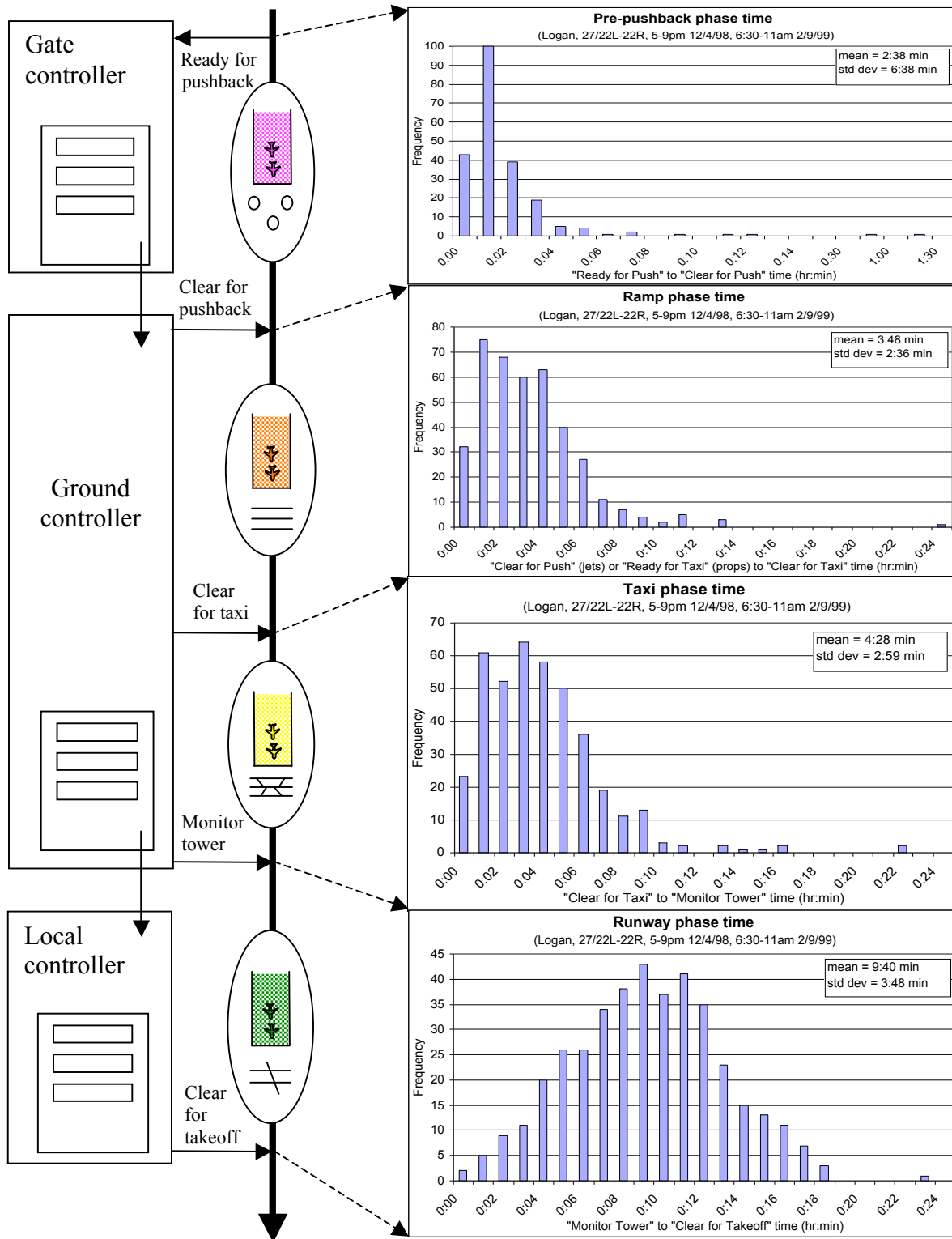

Figure 3.16: Communication analysis

The larger average delays that the aircraft incur in the runway phase is an indication of the saturation of the runway system rate capacity relative to the preceding phases. This is indicated in Figure 3.17 where the throughput of each phase is plotted as a function of the number of aircraft in the phase<sup>25</sup>. Figure 3.17 indicates that the runway system reached its saturation level at about 0.8 to 0.9 aircraft per minute after there were about 6 aircraft in the phase. The other phases, on the other hand, exhibited higher throughput than the runway system and did not seem to be under enough demand pressure to reach saturation levels<sup>26</sup>. The maximum throughput increased further to about 1.3 aircraft per minute after the number of aircraft in the runway phase reached 12 aircraft. This reflects the effect of the Accelerated Departure Procedure, ADP (in this runway configuration) where in order to avoid excessive queues, the Control Tower switches the utilization of runway 22L from arrival to departure, which increases the departure rate capacity relative to the arrival rate (see Section 3.2.3).

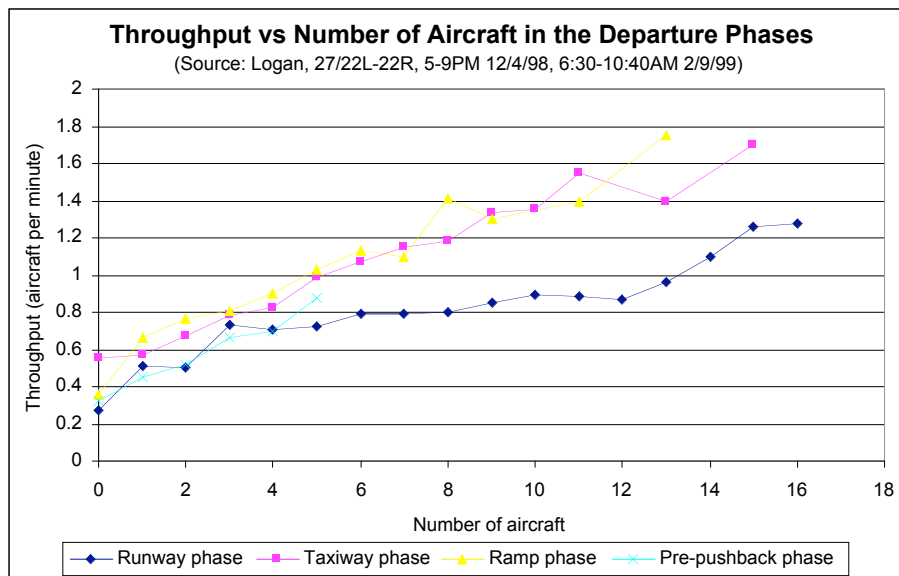

Figure 3.17: Throughput saturation of the runway system

<sup>25</sup> The number of aircraft in a phase at any time (t) is the number of aircraft that received the entry event to the phase but have not received the exit event from the phase at the time (t). The throughput of a phase is computed as the number of exit clearances delivered over a 10-minute period succeeding the time of the number of aircraft measurement.

<sup>26</sup> The pre-pushback phase applies only to jet aircraft and, therefore, includes only about half the total traffic in the other phases.

**ACARS pilot delay report analysis**

In order to compare the observed delays at Logan Airport to the delays at other airports, ACARS pilot delay reports (see Chapter 2, Section 2.2) were analyzed at four major airports: Dallas Fort Worth (DFW), Chicago O’Hare (ORD), Atlanta Hartsfield (ATL) and Boston Logan (BOS). Figure 3.18 shows the distribution of the ACARS pilot delay reports during the taxi out departure phase between pushback (Out time) and wheels off (Off time) at each of the four major airports, for one major airline and for a 10-month period.

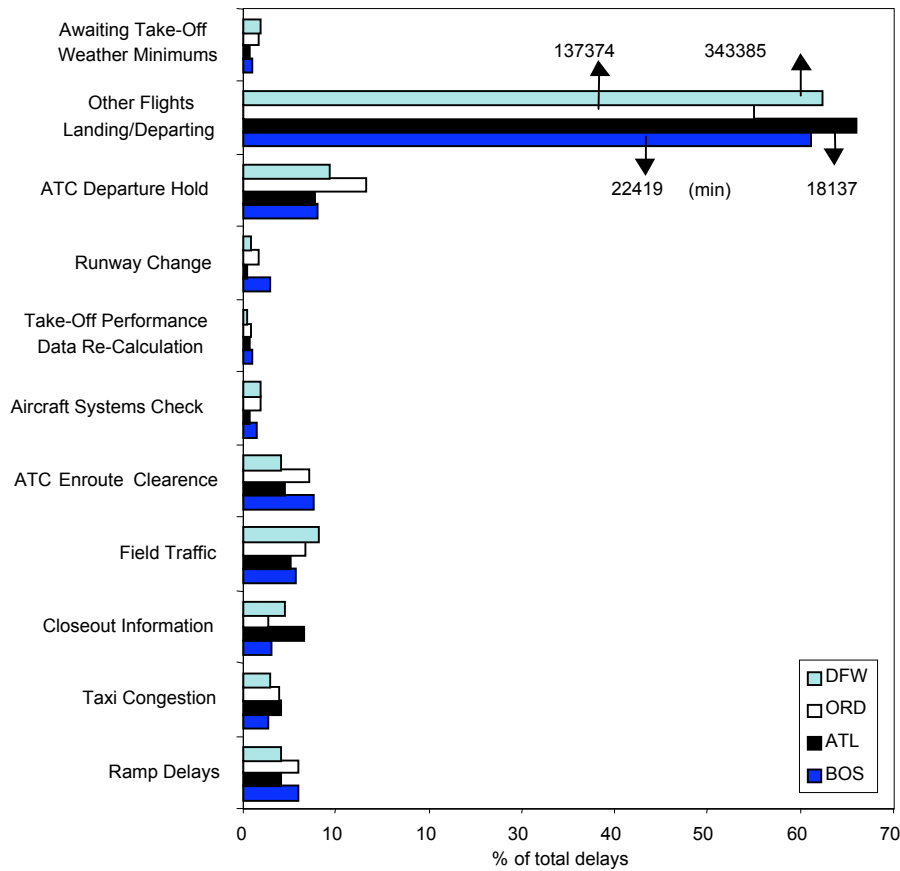

Figure 3.18: ACARS pilot delay reports during taxi out (One airline, January to October 1997)

Figure 3.18 shows that for all four airports the delays incurred in the runway takeoff queue, represented by the category “other flights landing and departing”, accounted for 55 to 65 percent of the total delays between pushback and takeoff. For DFW these delays amounted to over

340,000 minutes. Each of the other categories accounted for less than 10 percent, including taxi congestion and ramp delays. The similarity in the delay causalities reported in all four major airports indicates that other airports likely share the same behavior. The ACARS delay reports suffer from a number of limitations as described in Chapter 2: They are subjective human reports, subject to human interpretations of the delay causing categories, which may be vague and may overlap; and subject to human errors in estimating the delay times. They are also incomplete since they are voluntary reports by pilots. Despite these limitations, the vast difference between the delays attributed to waiting for other aircraft landing and departing at the runway and the other categories testifies to the fact that the runway phase incurs the greatest portion of the delay in the departure process.

There are many causal factors that contribute to making the runway phase incur most delays in the departure process. Some of these causal factors limit the capacity of the runway system, (as was abstracted in the basic control mechanism of a single airport resource in Figure 3.11). And some causal factors originate at resources downstream of the runway system and block its operation due to the downstream capacity limitations (as was abstracted in the controlled blocking due to interactions between interconnected resources in Figure 3.14). Some of the causal factors that limit the capacity of the runway system are discussed below, while downstream flow constraints are discussed next in subsection 3.4.2 because their effect, although it manifests mainly at the runway, is more global and may propagate to other resources of the airport system.

#### **3.4.1.1 Runway separation requirements and wake vortex effects**

The main task of the local controllers is to maintain the safe operation of the runways by ensuring the required runway and wake vortex separations between successive operations. For example, the runway and wake vortex separation requirements, for VFR and IFR departures on the same runway, are shown in Figure 3.19 (according to the ATC Manual 7110.56L). These separation requirements are more complicated and more restrictive when the runway is used for landings as well as takeoffs or when the runway configuration has dependent parallel or intersecting runways.

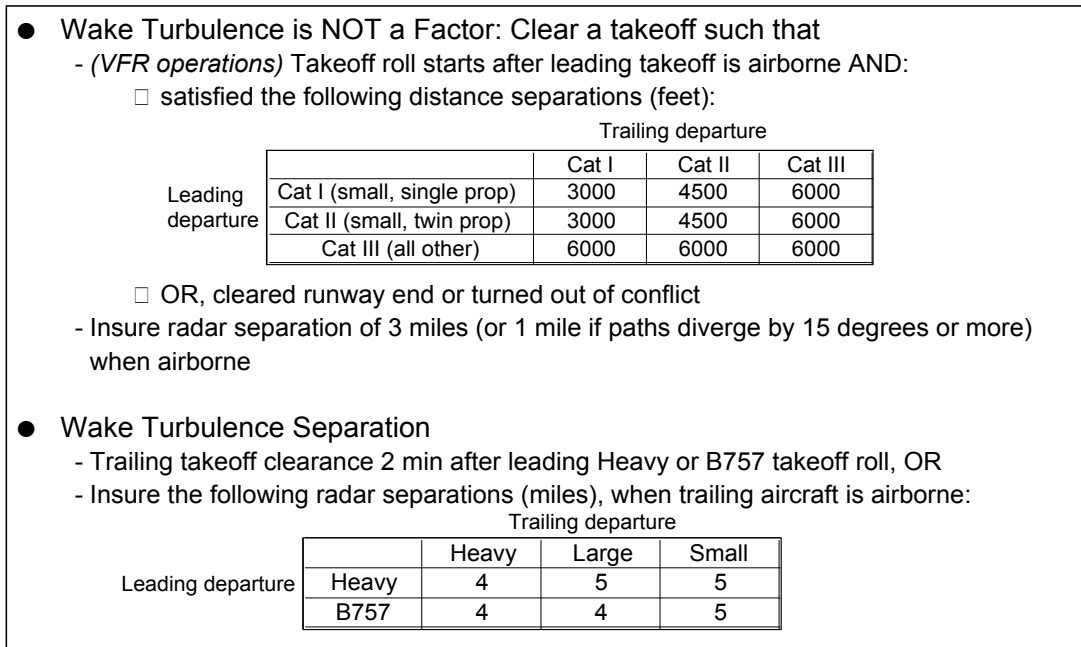

Figure 3.19: Runway and wake vortex separation requirements for same runway departures (FAAH 7110.65L)

Therefore, when aircraft land or take off, they occupy the runway not only for the time that they are physically on the runway, but also for the duration it takes for the runway and wake vortex separation to be satisfied. The time the next aircraft has to wait in the takeoff queue behind another aircraft that had just landed or taken off depends on the size of the two aircraft as shown in Figure 3.19. The largest takeoff separation requirements are the wake vortex separations behind heavy jet aircraft and B757. In non-radar equipped airports, takeoffs behind a heavy jet or B757 have to be separated by 2 minutes. At Logan Airport, radar separations are often used instead, which may result in separations below 2 minutes. These runway and wake vortex separation requirements limit the capacity of the runway system especially in bad weather conditions when the wake vortex separation requirement cannot be waived.

Figure 3.20 shows the effect of the runway and wake vortex separation requirements on the time between takeoff clearances, for a sample of runway 22R takeoffs (for which the takeoff clearances were recorded manually during field observations). The sample was divided into two parts: the aircraft that took off behind a heavy jet or B757 to demonstrate the effect of the wake vortex separation requirements and those that took off behind other types of aircraft to

demonstrate the effect of the runway separation requirements in the absence of the wake vortex factor. In order to eliminate some of the other factors that may have affected the inter-takeoff clearance time, successive takeoffs on runway 22R that were separated by runway crossings or landings on runway 22R or by takeoffs on the dependent runway 22L were eliminated from the second sample part that did not involve a wake vortex separation requirement. Therefore, as shown in Figure 3.20, when the wake vortex was not a factor in the separation requirement and no other operations separated the takeoffs, the average time between takeoff clearances was only 45 seconds. On the other hand, when a wake vortex was a factor in the separation requirement, the average time between takeoff clearances was 2 minutes and 16 seconds. However, the wake vortex separations behind a heavy jet or B757 in the first part of the sample, due to their large magnitude, always coincided with other types of operations on the runway (mainly runway crossing) between the takeoffs. Therefore, the effect of the wake vortex separation on the inter-takeoff time, shown in Figure 3.20, is coupled with the effect of other runway operations separating the takeoffs.

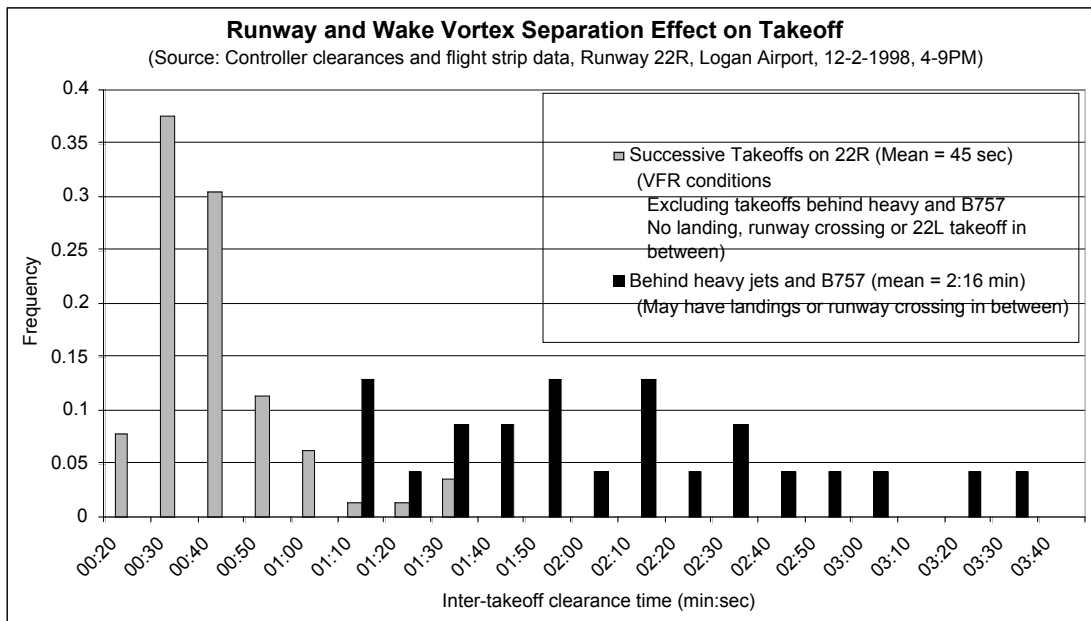

Figure 3.20: Effect of the wake vortex separation requirement on the time between takeoff clearances

It should be noted that the sample was collected in VFR conditions. Therefore, as confirmed in an interview with Control Tower personnel, the 45-second observed average separation between takeoff clearances (in the absence of wake vortex separation requirements and any other operations between the takeoffs) reflected mainly the VFR distance separation requirements (see Figure 3.19). As observed during field observations at Logan Airport and confirmed by Control Tower personnel, the runway separation requirements, particularly the VFR requirements and the 1-mile radar separation requirement when the paths diverge by 15 degrees or more (see Figure 3.19), are often satisfied before the wheels-off time of the leading aircraft<sup>27</sup>. In such cases the clearance is delivered to the trailing aircraft once the leading aircraft is airborne. Based on the field observations, the runway occupancy time, between the takeoff clearance and the wheels-off event, also had an average of 45 seconds.

The inter-takeoff clearance time behind heavy jet aircraft and B757 was most significant (2 minutes and 16 seconds as opposed to 45 seconds behind the other aircraft types). Some of the wake vortex separations were below 2 minutes due to the application of the radar separation in lieu of the 2-minute requirement. Also some of the separations when the wake vortex was a factor were larger than 2 minutes, due possibly to factors other than the wake vortex separation requirement, such as the use of the runway by landings and runway crossings between the takeoffs, or simply the lack of demand. (The effect of low demand was reduced by collecting the data during a busy period of the day). The overall impact of the wake vortex separation requirement depends on the frequency of occurrence of the larger separations, which depends in turn on the percentage of the heavy jet and B757 aircraft in the aircraft type mix at the airport.

---

<sup>27</sup>Assuming an acceleration of 0.25g on average, aircraft consume a distance of 3600 ft in 30 sec and 8100 ft in 45 sec. Therefore, for visual (VFR) operations, the distance separation requirements are mostly satisfied before the leading aircraft are airborne, which takes on average 45 seconds (the time between the takeoff clearance and wheels-off was on average 45 seconds based on the field observations). The 1-mile radar separation requirement (if paths diverge by 15 degrees) should be satisfied when both the leading and trailing aircraft are airborne. Assuming the same acceleration, it can be shown that the leading aircraft would be about 2.5 NMiles out after 60 sec. If the trailing aircraft takeoff clearance was delivered only 30 seconds later than the leading aircraft clearance and the trailing aircraft was airborne after another 30 seconds at a distance of one mile out, the one mile separation would still be satisfied. Based on communications with the Control Tower personnel, special attention is usually given to fast aircraft taking off behind slow aircraft.

Based on communication with the Control Tower personnel, currently jet aircraft constitute 52 percent of the fleet mix at Logan and heavies and B757 are about 20 percent of the jets.

### ***Noise effect on takeoff separation requirements***

Noise is a major constraining factor on the runway system capacity at Logan Airport. One noise factor, which was described in Section 3.2, was the effect on the runway configuration selection process such that the noise impact is mitigated by selecting noise preferred runways particularly during night hours. Another noise constraining factor is its effect on the takeoff separation requirement implementation. As pointed out in interviews with Control Tower personnel, because all jet aircraft are constrained to follow the same initial departure routes, which are designed for noise mitigation purposes, it is not possible to diverge the paths of successive jet takeoffs by 15 degrees or more. This limitation robs the Controllers of the ability to use the 1-mile radar separation requirement in lieu of the 3-mile requirement (see Figure 3.19). This limitation, however, does not affect the prop takeoffs (whose initial departure paths are usually diverged) or the wake vortex application for which the path divergence does not change the separation requirement.

#### **3.4.1.2 Runway crossing**

Departure runways are often shared by taxiing aircraft that have to cross the active departure runway. For example, in the 27/22L-22R/22L runway configuration (described in Figure 3.8), arrivals on runways 27 and 22L have to cross the departure runway 22R in order to get to the ramp. These arrivals queue on the taxiway segments between runways 22R and 22L (Figure 3.21), and when these short taxiway segments become full, the arrivals on runways 22L and 27 are impeded. The air traffic controllers in this case would have to interrupt the departures on runway 22R in order to let the waiting arrivals cross so that the flow of landings can continue.





Figure 3.21: Arrival runway crossing queues for runway 22R

As an example of the effect of runway crossings on the departure flow, Figure 3.22 compares the time between the takeoff clearances of successive departures on runway 22R, with and without runway crossings in between, in the sample of takeoffs that was used in Figure 3.20. Again the sample was divided into two parts: The inter-takeoff times which included no runway crossings between the two takeoffs (and also no landings, no takeoffs on the dependent runway 22L and no wake vortex separation requirement), and the inter-takeoff times which included one or more arrival runway crossings. The mean inter-takeoff clearance time was 45 seconds for successive takeoffs without runway crossings in between (as in Figure 3.20), while it was almost 2 minutes for the takeoffs that had arrival runway crossings in between. The variability in the inter-takeoff clearance time depends on the number of runway crossings that took place in each interval, which in turn depends on the air traffic controllers' strategies in sequencing takeoffs and runway crossings on runway 22R as will be described in Section 3.4.1.4.

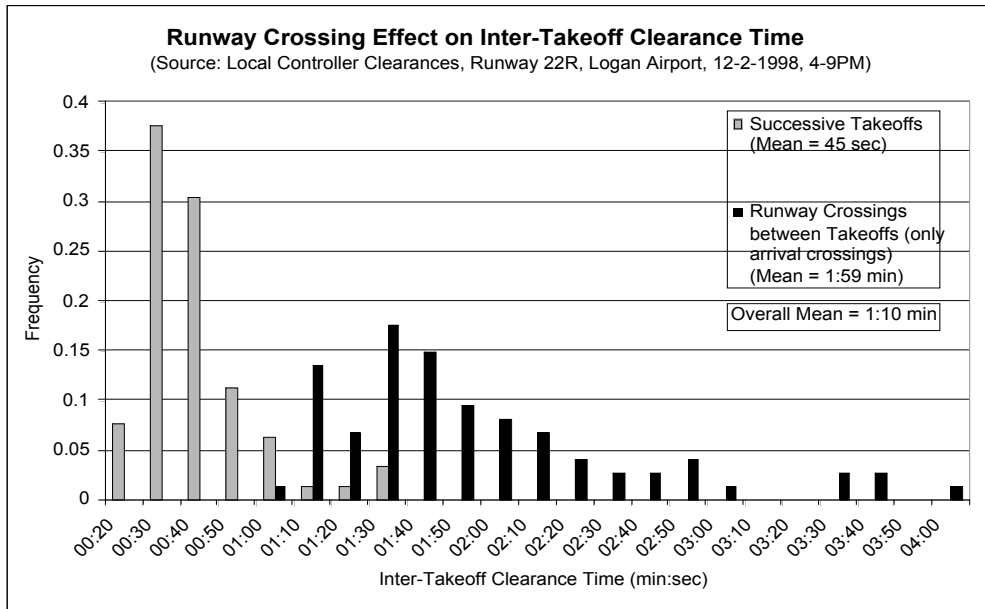

Figure 3.22: Effect of runway crossing on the time between takeoff clearances

### 3.4.1.3 Capacity limitations due to landing aircraft

The departure runway is often shared by arrivals landing on the same runway or on dependent runways. For example, in the 27/22L-22R/22L runway configuration described in Figure 3.8, takeoffs that are assigned to the arrival runway 22L are held in favor of the higher priority landings on runway 22L, and the landings on runway 27, which do not hold short of the intersection between the two runways. As a result the departure aircraft that are assigned to or request runway 22L (because it is a longer runway) incur additional delays compared to the departure aircraft that take off on the main departure runway 22R. This is shown in Figure 3.23, which displays the distribution of the runway phase time (between the “Monitor Tower” handoff instruction and the “Clear for Takeoff” instruction) for two groups of aircraft that departed on runways 22L and 22R (using the same sample of aircraft in Figure 3.16). The mean time for the aircraft that departed on runway 22L was about 45 percent higher (13:17 minutes compared to 9:26 minutes).

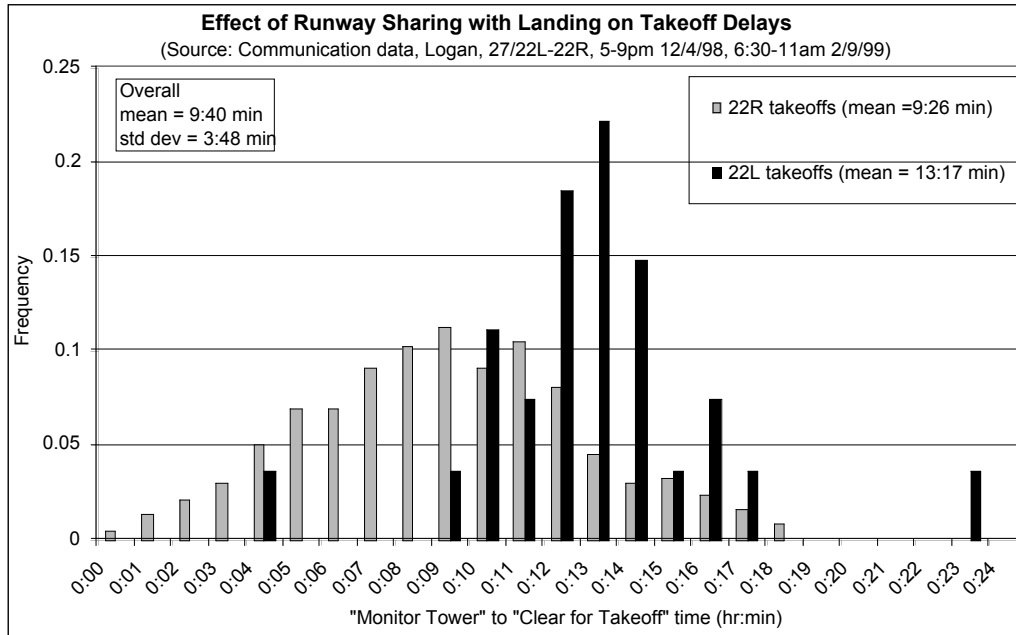

Figure 3.23: Delay of runway 22L takeoffs due to higher priority landings on the same runway

### 3.4.1.4 Controller sequencing strategies

The main task of the Local controllers is to insure the safe operation of the runway system by implementing the appropriate ATC procedures, particularly maintaining the runway and wake vortex separation requirements, between successive takeoffs as well as between takeoffs, landings and runway crossings. The clearance is the main control mechanism where the aircraft are held in the takeoff queues for the required duration of time (as abstracted in Figure 3.11). In addition to the basic ATC procedure implementation, the air traffic controllers may exercise certain strategies, particularly when they have control opportunities through routing, sequencing and suspending aircraft (as was abstracted in Figure 3.14). For example, at some airports where there are multiple runway systems, such strategies may include balancing the aircraft load on the different runway systems. At Logan Airport, with a single runway system, the main strategies

consist of sequencing departure operations, often at a single departure runway, and sequencing takeoffs with landings and runway crossings when the operations are mixed or interdependent.

Due mainly to the different spacing between successive takeoffs dictated by the runway and wake vortex separation requirements, the sequence of takeoffs is a major factor in determining the efficiency of the runway system. As described in Section 3.4.4.1 (Figure 3.19) the separation of aircraft B behind aircraft A may be different from the separation of aircraft A behind aircraft B, if the two aircraft are of different types. For example, grouping of heavy aircraft, and hence reducing the occurrence of the larger separation of a smaller aircraft behind a heavy may increase efficiency. Based on the observation at Logan Airport some controllers adopt such a strategy. However, most controllers were observed to adopt a strategy of alternating jet and prop takeoffs in order to alternate exit fixes and assist downstream departure controllers. The alternating sequencing strategy is motivated by reducing the workload of the downstream controllers since jets and props follow different routes and alternating them results in a fanning effect and a larger spacing between aircraft heading towards the same exit fix. Figure 3.24 shows an example of the sequencing behavior (performed by the Ground controller at Logan Airport), where a large jet is inserted between two props (or small aircraft) as departures are sequenced in the runway 22R-takeoff queue, at the entry to the November taxiway.

Whenever possible landings and takeoffs are assigned to separate runways. However, when landings and takeoffs share the same runway, landings have a priority over takeoffs due to safety reasons. As a result the takeoffs usually incur large delays (as was show in Figure 3.23) waiting to be inserted in the landing stream. It was observed at Logan Airport that when the takeoff delays become excessive, the Local controller might request a gap to be generated between the landings (by the final approach controllers in the TRACON) such that the delayed takeoffs can be inserted.

At Logan Airport, runway crossings are a major factor in limiting the runway efficiency especially in the 27/22L-22R runway configuration (Figure 3.22). Therefore, the Local controllers attempt to reduce the effect of the runway crossings on the departure flow by minimizing the time spent by aircraft crossing the runway. Based on observations at Logan



Figure 3.24: Sequencing departures in the runway 22R takeoff queue

Airport, the air traffic controllers adopt a number of strategies to accomplish this in the 27/22L-22R/22L runway configuration:

- Crossing aircraft simultaneously at multiple crossing points, and simultaneous crossing of arrival aircraft and departure aircraft taking off on runway 22L.
- Grouping the runway crossings whenever possible, since the largest crossing time is incurred by the first aircraft (if it has fully stopped) and the marginal time for each additional runway crossing is much smaller. Based on elicitation, the controllers allow for 40 seconds for the first aircraft to cross and 10 seconds for each additional crossing). Figure 3.25 shows this behavior, where inserting one runway crossing between two successive takeoffs increased the time between the two takeoff clearances by an average of 55 seconds (from 45 seconds to about 1 minute and 40 seconds). Additional crossings between successive takeoffs increased the inter-takeoff clearance time marginally by about 10 seconds per crossing. (The sample of runway 22R takeoffs in Figure 3.25 is the same as the one in Figure 3.22).

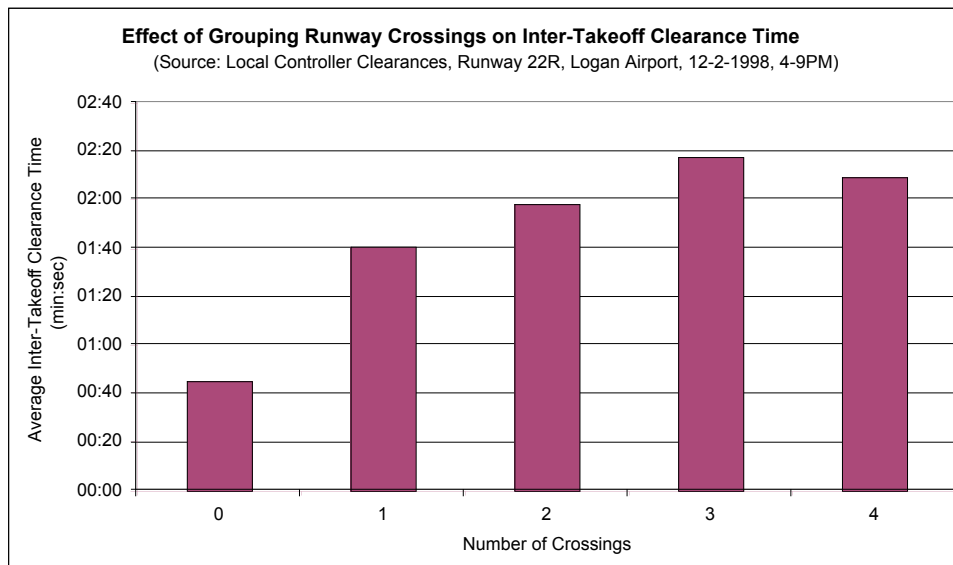

Figure 3.25: Effect of the number of runway crossings on the time between takeoff clearances

- Keeping the crossing aircraft rolling, since again the crossing time of an aircraft that has come to a full stop is much larger than the crossing time for an aircraft that is taxiing.

### 3.4.1.5 ATC workload constraints

As was depicted in the airport system in Figure 3.1 and in more details in Figure 3.9, the air traffic controllers are another resource of the airport system where the aircraft flow by the controllers in the form of flight progress strips, and require their control instructions in order to use the airport controlled resources. When an air traffic controller is under heavy workload, the instructions required to use an airport controlled resource, such as the runway, may be delayed. As a result the aircraft may incur additional delays in the takeoff queue and the efficiency of the runway may be reduced. In the Control Tower delays due to the controllers' workload manifest in the flight progress strip queues that form in front of the air traffic controllers, corresponding to the aircraft queues that form on the airport surface<sup>28</sup>.

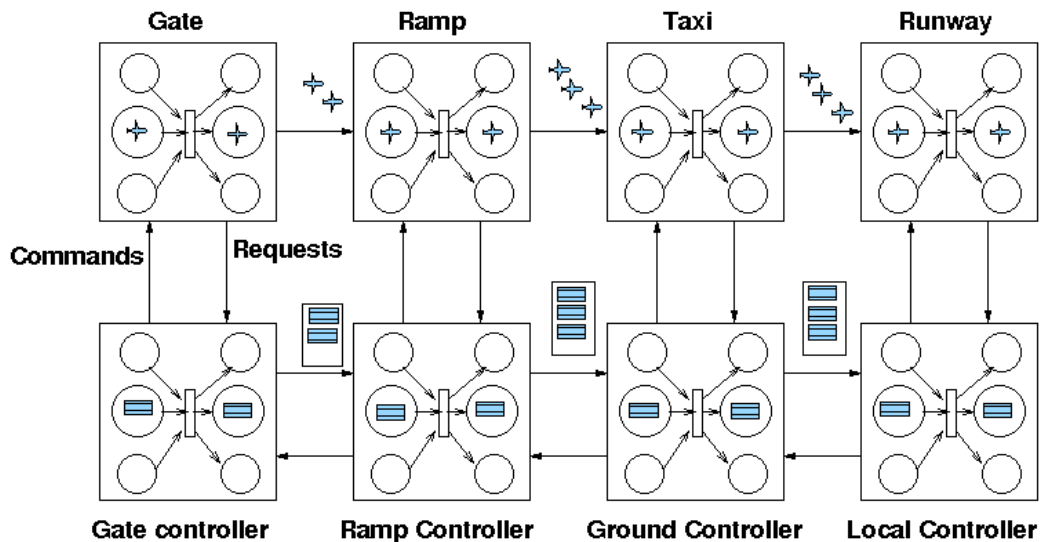

Figure 3.26: The parallel aircraft and flight progress strip queuing processes

<sup>28</sup> Both the aircraft and the flight progress strips are shown to progress through a number of states in each location. Using a Petri Net representation, states are represented with circles and transitions between states are represented with bars. This Petri Net representation is used later in the gate operation analysis in Section 3.4.2, Figure 3.30. The Gate and ramp controllers are generic representations of the control in these two phases, although such positions exist at the airline's gate station and ramp tower rather than at the FAA Control Tower in most airports.



Figure 3.27 shows an example of the heavy communication load that the Local controller experiences during heavy traffic hours. The example is from the 33L-27 runway configuration in which only one Local controller controls all of the arrival and departure traffic on the two intersecting runway. (A second Local controller assists in the planning the runway crossings). In addition to a large number of communications the Local controller is assigned the most safety critical task of maintaining the runway and wake vortex separation requirements, which entails a high degree of responsibility and stress. In this particular runway configuration, because only one Local controller is in charge of all the traffic, the controller’s shift duration is reduced.

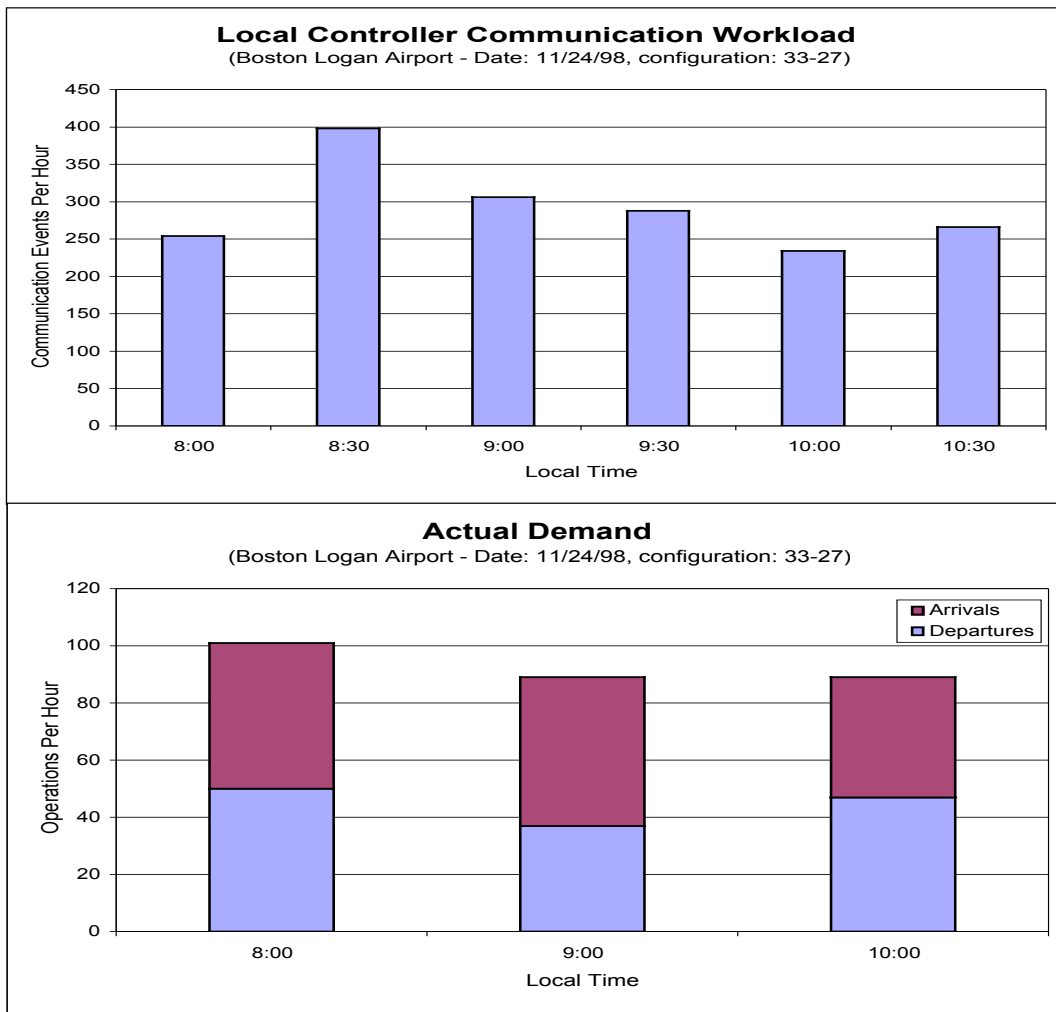

Figure 3.27: Local controller communication taskload



The air traffic controllers coordinate and adopt strategies in order to maintain the workload at acceptable safe levels. For example, the sequencing strategy of alternating jet and prop takeoffs (or exit fixes) is one such strategy to assist the downstream departure controllers. Within the airport system, as described in Section 3.3.4, the Gate controller was observed to regulate the departure flow based on the workload level of the downstream Ground controller. One information feedback mechanism that the air traffic controllers use to monitor downstream congestion levels and the workload level of adjacent controllers is observing the flight progress strips. For example, the Gate controller often holds departures on the gate when observing the Ground controller overwhelmed by an excessive pile of flight strips. The Ground controller was also observed to instruct the Gate controller to hold aircraft on their gates when under high traffic load.

#### **3.4.1.6 Runway change**

Another factor that was observed to result in loss of runway efficiency at Logan Airport is the runway configuration change. Often, and depending on the difference in the flow patterns between the two runway configurations (see Section 3.2), the departure flow is interrupted for a period of time between the last operation on an old runway and the first operation on a new runway. Figure 3.28 shows an example of a change from the 4R/4L-9/4L/4R runway configuration to the 27/22L-22R/22L runway configuration. Figure 3.28 shows the queue of departures that are waiting to join the November taxiway leading to the new takeoff runway 22R, while the November taxiway is still busy with the last arrivals that landed on runways 4R/L and are heading towards the ramp. (During this time, the Control Tower was observed to perform a number of departure takeoffs on runway 15R in transition between the two runway configurations, to reduce the loss of runway efficiency).



Figure 3.28: Runway configuration change

#### **3.4.1.7 Delays due to aircraft preparation**

Each aircraft performs a number of checks and preparations before takeoff. These include final weight and balance calculations, systems and cabin checks, and deicing in bad weather. An aircraft may be delayed by these processes and hold the rest of the takeoff queue.

## **3.4.2 Downstream flow constraints**

As was described in the queuing representation of the departure process in Section 3.3, flow constraints may result from the capacity limitation of each single airport resource relative to demand, as well as from the blocking of an airport resource caused by the limited capacity of downstream resources. Namely, when a downstream resource is saturated under high demand and its finite buffer space becomes full, its inbound flow from upstream resources is blocked (see Figure 3.13). Through this blocking mechanism, downstream flow constraints, which originate due to capacity limitations at NAS locations downstream of the runway system, become one of the major flow constraints in the departure process. These downstream flow constraints propagate back and cause blocking of the departure flow outbound from the airport because the downstream locations are saturated. As a result, the departure throughput of the runway system is set to an effective rate that reflects the acceptance rate of the downstream resources and may be lower than the average runway system capacity under non-restricted conditions. Hence the downstream flow constraints manifest mainly at the runway system in terms of reduced throughput and cause delays that may be absorbed anywhere on the airport surface. In this section the effects of the downstream flow constraints on the departure process are analyzed in terms of throughput and delays.

### **3.4.2.1 The traffic flow management process**

The outbound flow from an airport system to downstream locations in the NAS is regulated through a flow management process as shown in Figure 3.29. Given feedback about the capacity limitations of the downstream locations, such as exit fixes, en route sector airspace and destination airports, the flow management process imposes restrictions on the outbound flow from the airport such that the level of traffic at the downstream locations is maintained below certain thresholds. The flow management process in Figure 3.29 is therefore an example of the abstraction of the departure process as a queuing system with controlled blocking that was depicted in Figure 3.14.

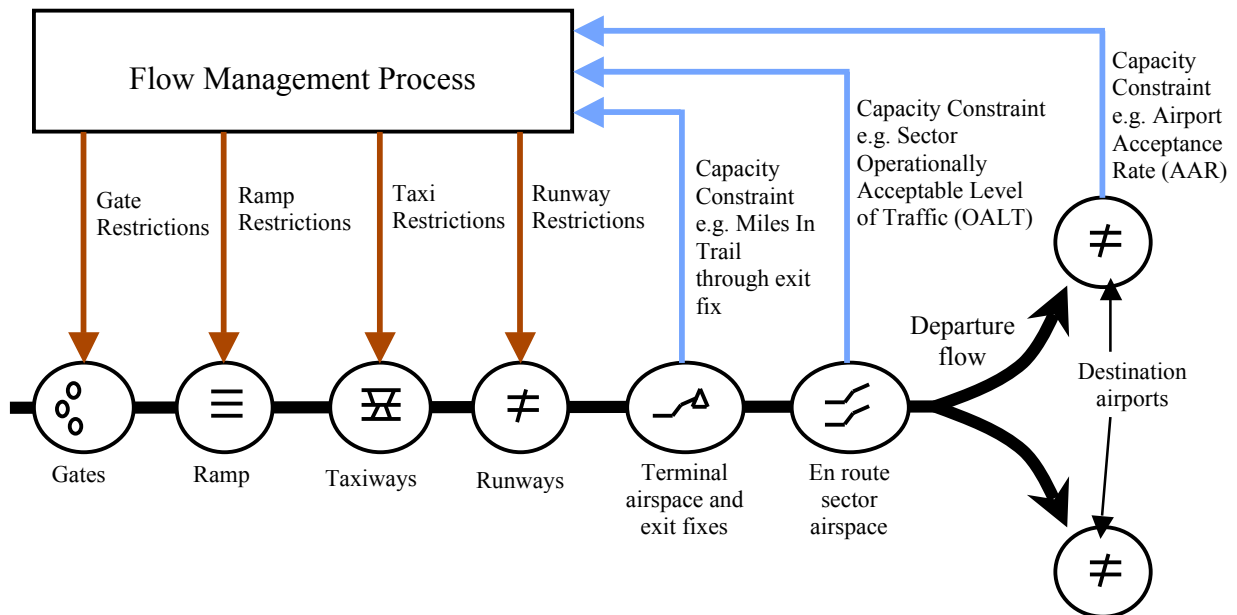

Figure 3.29: The flow management process under downstream flow constraints

As shown in Figure 3.29, the restrictions may be applied at any resources on the airport surface (the gates, ramp, taxiways or runways) and result in restricting the outbound flow from the runway system. The feedback varies depending on the downstream location. For example, for an airport the feedback may be the Airport Acceptance Rate (AAR) (the number of aircraft that the airport can accept in an hour). For a sector airspace, the feedback may be the Operationally Acceptable Level of Traffic (OALT), which is the number of aircraft that the sector can handle in an hour. Closer to the airport, the Miles In Trail (MIT) through exit fixes, which is a required spacing between the aircraft passing through the fix, may be one indication of the capacity limitation at the fix.

When conditions such as inclement weather affect a destination airport, a sector airspace or an exit fix, these acceptance or flow rates are set lower than the normal values to reflect the current conditions. Based on the Control Tower logs at Logan Airport, the main reported impacting conditions that resulted in imposing downstream restrictions on the outbound flow included inclement weather, high volume demand, equipment outages and runway non-availability. These rates also take into account the air traffic controllers' workload.

### **3.4.2.2 Downstream restrictions through traffic flow management programs**

The flow management process is achieved through a complex system of Traffic Management Units (TMU) in the key Air Traffic Control facilities. As shown in Figure 3.30 (from FAA, Course 50115) the key ATC facilities include the Control Tower in airports (ATCT), the TRACON in the terminal areas and the Air Route Traffic Control Center (ARTCC) in sectors. The TMU units in these facilities coordinate under the Air Traffic Control System Command Center (ATCSCC) in order to accomplish the flow management process. Namely, the traffic management units coordinate under the Command Center in order to ensure that the demand and capacity in their areas of responsibility are balanced. As was depicted in Figure 3.29, the traffic flow management system forms a number of flow management loops through which capacity limitations at downstream airports, airspace sectors and exit fixes propagate to upstream airports in the form of flow restrictions.

Figure 3.30: The traffic flow management system (from FAA, Course 50115)

The flow restrictions are imposed through a number of flow management programs, which are employed by the traffic flow management system in order to regulate the demand and maintain it below the estimated capacities. Through these programs, capacity limitations at downstream

airports, sectors and exit fixes are transformed into a set of specific restrictions at upstream airports as shown in Table 3.2. The effects of the downstream restrictions (indicated in Table 3.2) on the departure aircraft can be grouped into three main types: a takeoff time window, a spacing between two departures and a time delay, as described below.

Program	Effect	Time	Penalty	Origin	Time Scale	MIT/MINIT	(Miles /Minutes) intr

Table 3.2: Flow management programs and their restrictions on departures

**Takeoff time window**

Two flow management programs impose a restriction on a departure aircraft in the form of a requested takeoff time within a specific time window, the Expected Departure Clearance Time (EDCT) and the Departure Sequencing Program (DSP). EDCT is a Ground Delay Program (GDP) called a “Select Delay” program, in which the ATCSCC selects certain flights (heading to a capacity limited destination airport) and assigns an Expected Departure Clearance Time (EDCT) to each flight individually, with a 15-minute time window. Since GDP is a long-term effect program, the EDCT is usually generated in advance and printed on the flight progress strip of the aircraft. The Departure Sequencing Program (DSP) is “a program designed to assist in

achieving a specified interval over a common point for departures” (FAA, Course 50115). In order to meet a specific time slot over the common point (such as a fix) a wheels-off time with a 3-minute window is assigned by the ARTCC to the affected aircraft. The Traffic Management Coordinator (TMC) in the Control Tower calls the ARTCC once the DSP-restricted aircraft is on a movement area, stating the expected wheels-off time of the aircraft and asking for approval or for a different wheels-off time assignment. If the time window is missed, the Tower has to call the ATCSCC (in the case of an EDCT) or the ARTCC (in the case of a DSP) for another time assignment.

### ***Takeoff spacing***

The Miles in Trail and Minutes in Trail restrictions are imposed in terms of spacing between departure aircraft. Miles-In-Trail (MIT) is “a specified distance between aircraft, normally, in the same stratum associated with the same destination or route of flight” (FAA, Course 50115). Minutes-In-Trail (MINIT) is “a specified interval between aircraft expressed in time” (FAA, Course 50115). MIT and MINIT can often be implemented in the air after takeoff, with the proper coordination with the downstream departure controllers.

### ***Time delay***

Time delay is imposed on departure aircraft either for a specific duration (through the Ground Delay Program, GDP) or until further notice (through a Ground Stop, GS). Through a “General” GDP program the ARTSCC may impose delay factors (time delay) on aircraft heading to constrained destination airports in 15-minute time blocks (for example, departures to ORD, 12:00 to 12:59, 15-minute delay). While the GDP is used for long term demand regulation, for short-term effects the ATCSCC uses the Ground Stop (GS), which is “a process whereby an immediate constraint can be placed on system demand, whenever an area, center, sector or airport experiences a significant reduction in capacity” (FAA, Course 50115).

### ***Other restrictions***

Another type of restriction is **rerouting**, through which the ATC system attempts to reduce the effect of downstream constraints by allowing aircraft to use alternate routes. **Speed restrictions** are often imposed through constrained fixes. Also at the local level, adjacent facilities such as the Control Tower (ATCT) and the TRACON coordinate to balance the local flow of arrivals and departures. For example, a **hold** (similarly to a GS) is sometimes imposed on aircraft temporarily during a runway configuration change or a passing thunderstorm, which blocks one of the exit fixes<sup>29</sup>.

#### **3.4.2.3 Destination versus local downstream restrictions**

The effects of the downstream restrictions on the departure process at Logan Airport were analyzed for the month of July 1998. Restriction logs from the Control Tower provided information about the imposed restrictions (their type, location and duration)<sup>30</sup>. In order to analyze the effect of the downstream restrictions on the departure rate, ETMS traffic counts every 15 minutes (obtained from the CODAS database) were used to measure the departure throughput of the airport. In order to analyze the effect of the restrictions on delays and congestion, the ASQP data (namely the ACARS Out and Off times and the OAG scheduled time, reported by the 10 major airlines) were used. “Taxi out” delays were computed as the time between actual pushback (Out) and wheels-off (Off), while the “schedule to pushback” time between the OAG schedule and the Out time was used to measure the deviation from schedule including any pushback delays. The number of aircraft taxiing out (pushed back but not taken off) and the number of aircraft scheduled but not pushed back were used to measure the level of congestion.

---

<sup>29</sup> In the case of Ground Stop, GS: even when a GS is originated or suggested by a local facility, it has to be approved by the Command Center, ATCSCC.

<sup>30</sup> See Chapter 2 for data source descriptions.



One of the main observations from the analysis was that the effect of “destination airport restrictions,” which are imposed on departures heading to constrained destination airports, on the airport performance was not as pronounced as the effect of “local restrictions,” which are imposed on departures heading through exit fixes from the airport. This observation is demonstrated by comparing the performance of Logan Airport on two days: July 21, when numerous restrictions to destination airports were imposed, and July 23, when local restrictions were imposed due to thunderstorms near the airport.

### ***Destination airport restrictions***

Figures 3.31 through 3.33 show an analysis of the departure process performance on July 21, 1998 at Logan Airport, in terms of delays, throughput and congestion, respectively. On July 21, 1998 a number of downstream restrictions were imposed on the departure traffic heading from Logan Airport to multiple destination airports. Figure 3.31 combines a chronological display of the downstream restrictions that were imposed throughout the day (restriction type, duration and location, based on the Control Tower restriction logs), with the effect on the “schedule to pushback” and “taxi out” times. The “schedule to pushback” time (OAG schedule to Out time) is averaged over the aircraft that were scheduled to pushback in 15-minute periods. The “taxi out” time (Out to Off time) is also averaged over the aircraft that pushed back in 15-minute periods.

As shown in Figure 3.31, the downstream restrictions’ effect on departure delays appears as spikes in the average “taxi out” and “schedule to pushback” times in some 15-minute periods, while most other periods maintained average “schedule to pushback” time (around zero) and average “taxi out” time (around 20 minutes)<sup>31</sup>. Average “taxi out” times as high as 125 minutes and average “schedule to pushback” times between 30 and 115 minutes, were observed in some 15-minute periods. As indicated in Figure 3.32, most of the high delay spikes included flights heading to restricted destinations (indicated by the fact that the “schedule to pushback” and/or

---

<sup>31</sup> The average “schedule to pushback” time was near zero, and the average “taxi out” time was 20.3 minutes in the month of July 1998 at Logan Airport, computed from all the departure aircraft reported in the ASQP data during the month.

the “taxi out” times of the delayed flights overlapped with the duration of the restriction to the destination).

Figure 3.32 combines the downstream restrictions’ chart with the effect on the departure throughput on July 21, 1998. The departure throughput in every 15-minute period of the day is compared with daily average (over the month of July 1998) for the same 15-minute period. Figure 3.32 shows that despite the large number of downstream restrictions to destination airports, there was no apparent effect on the airport performance in terms of departure throughput. The throughput was maintained comparable to the daily average level for the month of July throughout the day, except for a peak late in the evening (between the hours 20:00 and 21:00). This departure throughput peak may be caused by the isolated delayed flights that were pushed to later hours of the day due to the restrictions.

Chapter 3: Observation and Flow Constraint Analysis of the Departure Process at Logan Airport

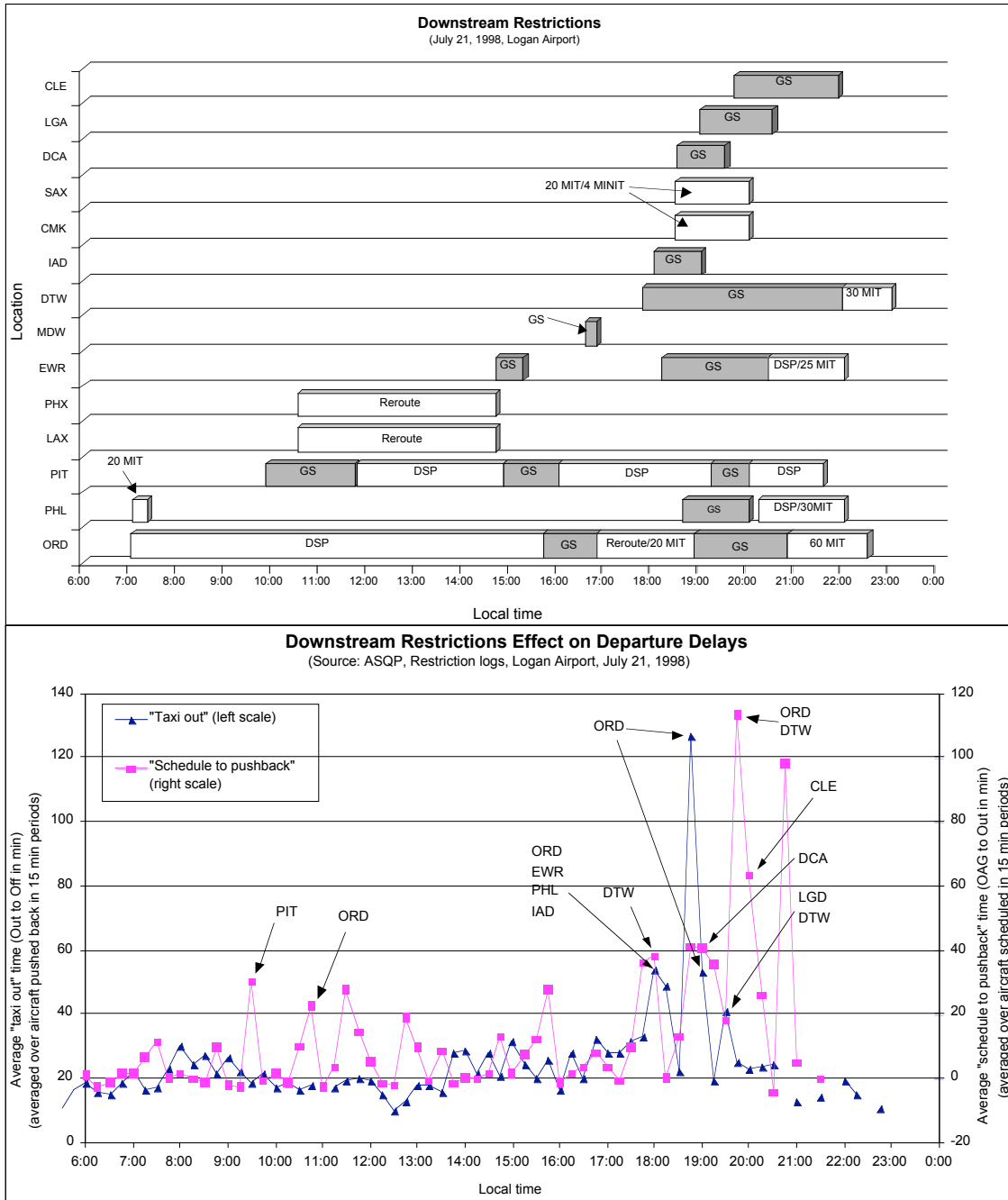

Figure 3.31: Destination restrictions' effect on departure delays

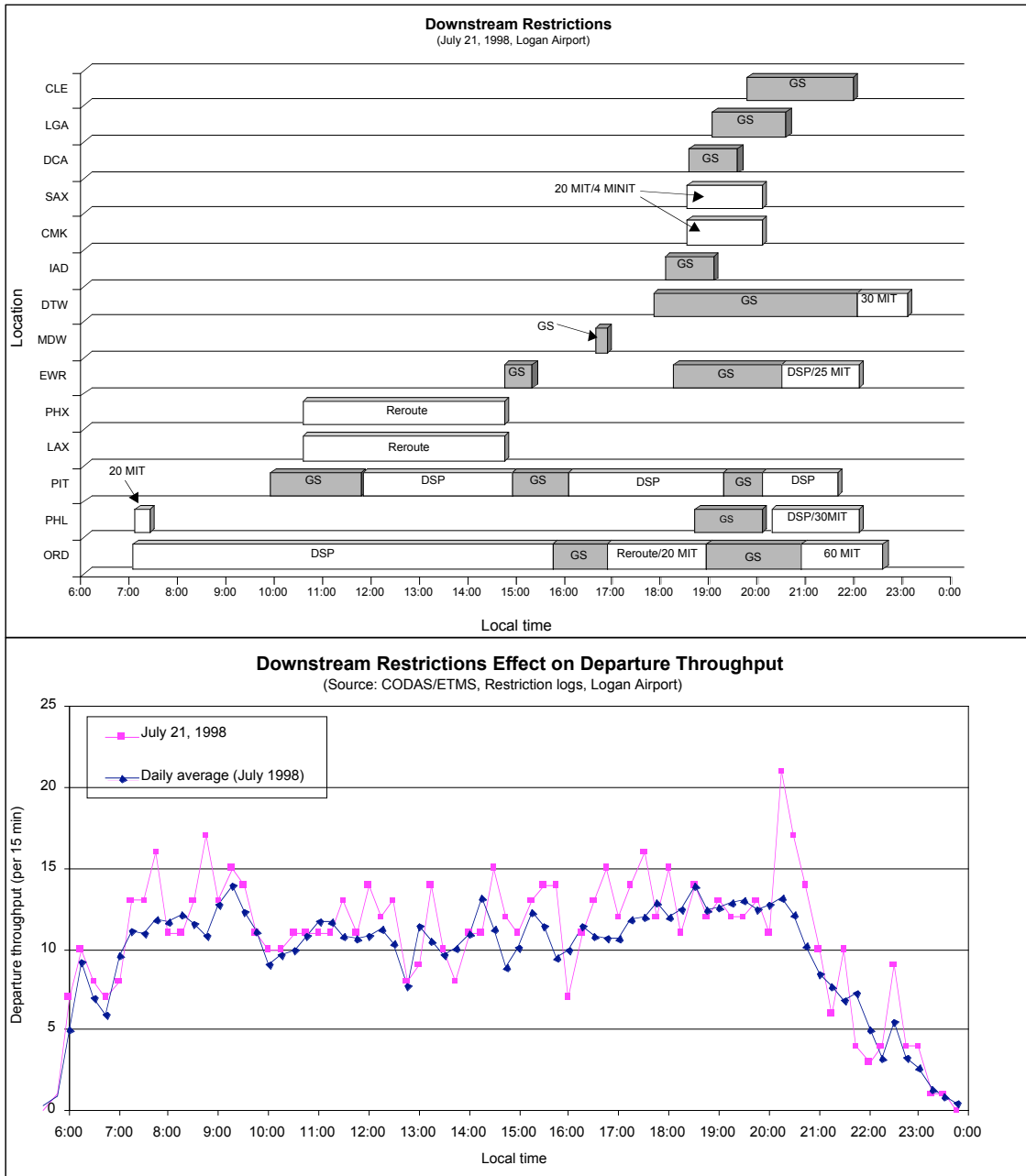

Figure 3.32: Destination restrictions' effect on departure throughput

Figure 3.33 shows the downstream restrictions' effect on the number of aircraft taxiing out (pushed back but not taken off) and the number of aircraft scheduled but not pushed back, on July 21, 1998. The average number of aircraft (taxiing out and scheduled but not pushed back) in 15-minute periods is compared with the daily average over the month of July 1998. As shown in Figure 3.33, the delays due to the restrictions caused larger taxi out queues than average in the evening hours (20:00 to 21:00), which corresponds to the increase in the departure throughput in the same period (Figure 3.32). Also, Figure 3.33 shows that the disruptions in the pushback schedule (mainly the schedule of the restricted aircraft, as was seen in Figure 3.31) remained in effect until the end of the day, as more aircraft than average were scheduled but have not pushed back yet until the hour 23:00.

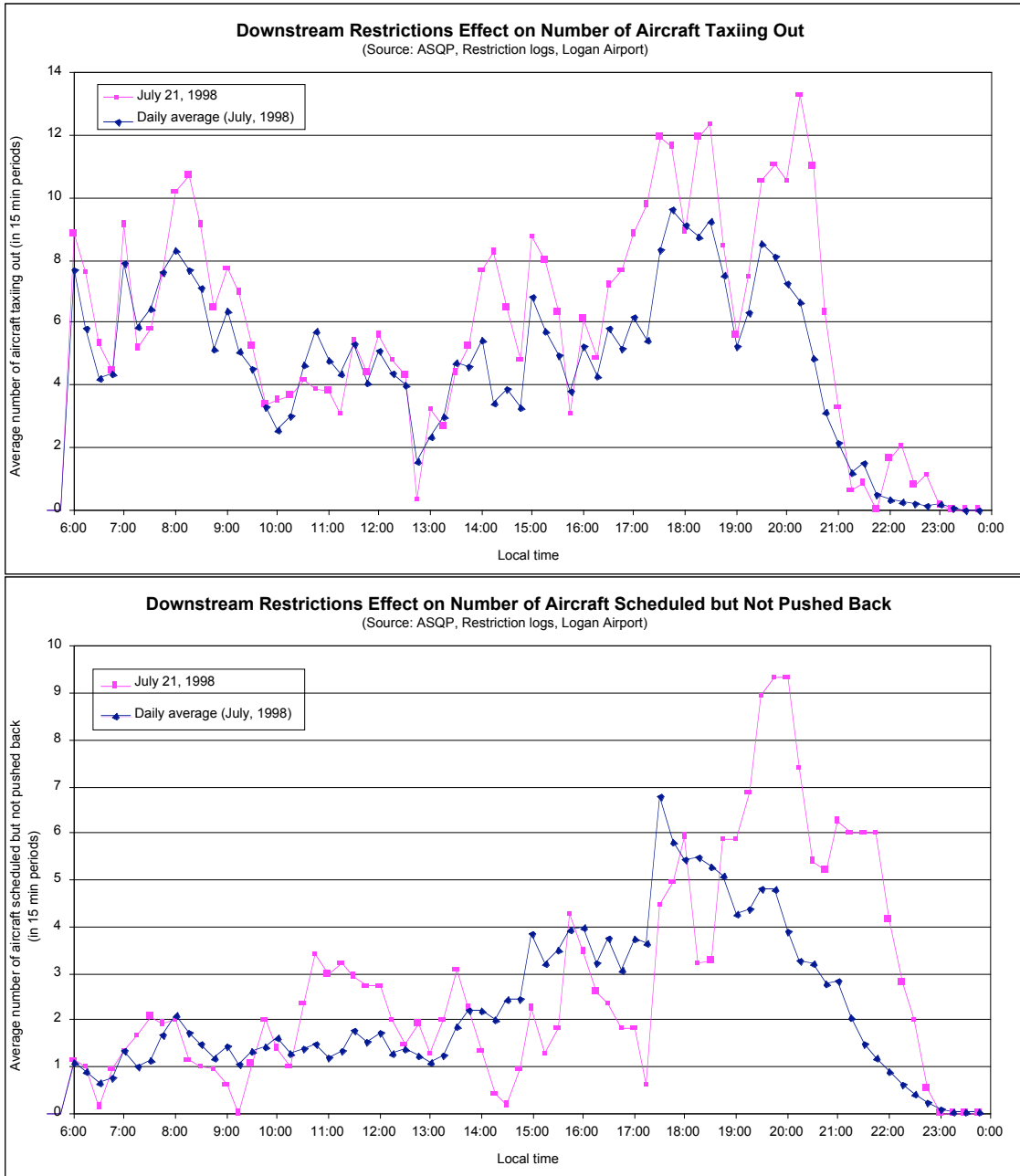

Figure 3.33: Destination restrictions' effect on departure congestion

### ***Local weather restrictions***

In comparison to the destination airport restrictions, which characterized the downstream restrictions imposed on the departure traffic from Logan Airport on July 21, 1998, the departure process at Logan was analyzed on July 23, 1998 when inclement local weather affected the airspace and exit fixes surrounding the airport. Again, Figures 3.34 through 3.37 show the effect of the local weather restrictions on the departure process performance in terms of throughput, delays and congestion. Figure 3.34 shows the restrictions that were imposed on the departure traffic outbound from Logan Airport on July 23, 1998 along with the effect on the departure rate. In the morning hours, Miles-In-Trail, DSP and reroute restrictions were imposed on the traffic heading to a number of jet routes and destination airports. Then between the hours 11:00 and 12:00 Ground Stop restrictions to Newark (EWR) and LaGuardia (LGA) airports came into effect as the inclement weather front seemed to be approaching the northeast and Logan Airport. Around the hour 13:00, thunderstorms started affecting the airspace surrounding Logan Airport, and a number of local restrictions were imposed through the TRACON (A90) airspace and the exit fixes from Logan. Westbound and northern traffic through BOSOX, MHT, PSM, ROCKPORT and BDL (see Figure 3.35) were affected by Minutes-In-Trail and Ground Stop restrictions through the hour 15:00. Then for the rest of the day GS, reroute, MIT and DSP restrictions remained in effect to a number of jet routes and destination airports.

As shown in Figure 3.34, in the morning hours until about 11:30, despite the few destination airport and jet route restrictions, the performance of the airport in terms of departure throughput was high as normal (similarly to July 21, 1998). After 11:30 the departure throughput of the airport started to decrease gradually as thunderstorms started to affect the airports and the airspace surrounding Logan and the local Ground Stop restrictions started to come into effect. In the time period between 14:00 and 15:00, the numerous GS restrictions that were imposed on the flow through exit fixes affected by the thunderstorms almost closed the airport, reducing the departure throughput to zero at 14:45.

Chapter 3: Observation and Flow Constraint Analysis of the Departure Process at Logan Airport

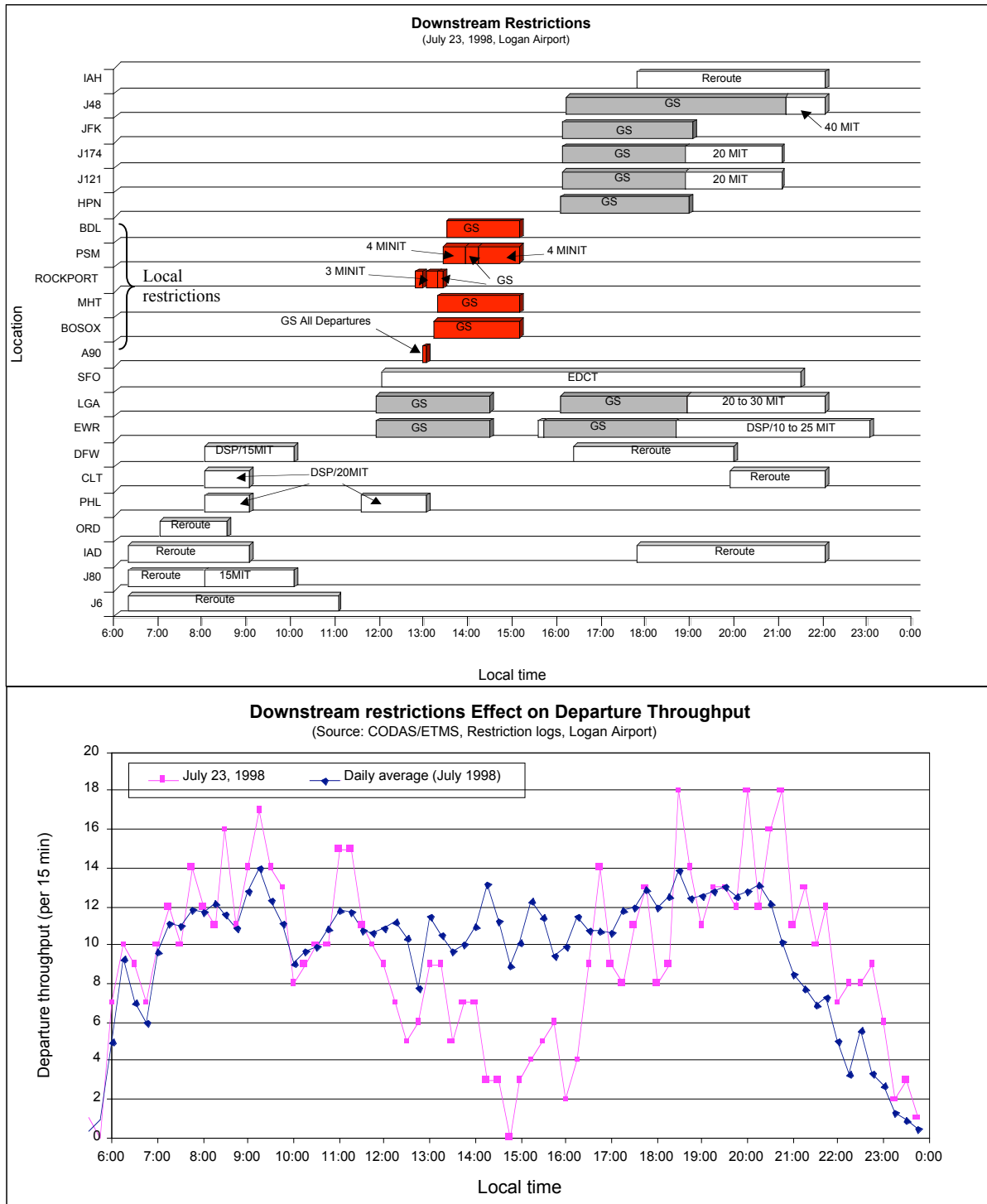

Figure 3.34: Local weather restrictions' effect on departure throughput



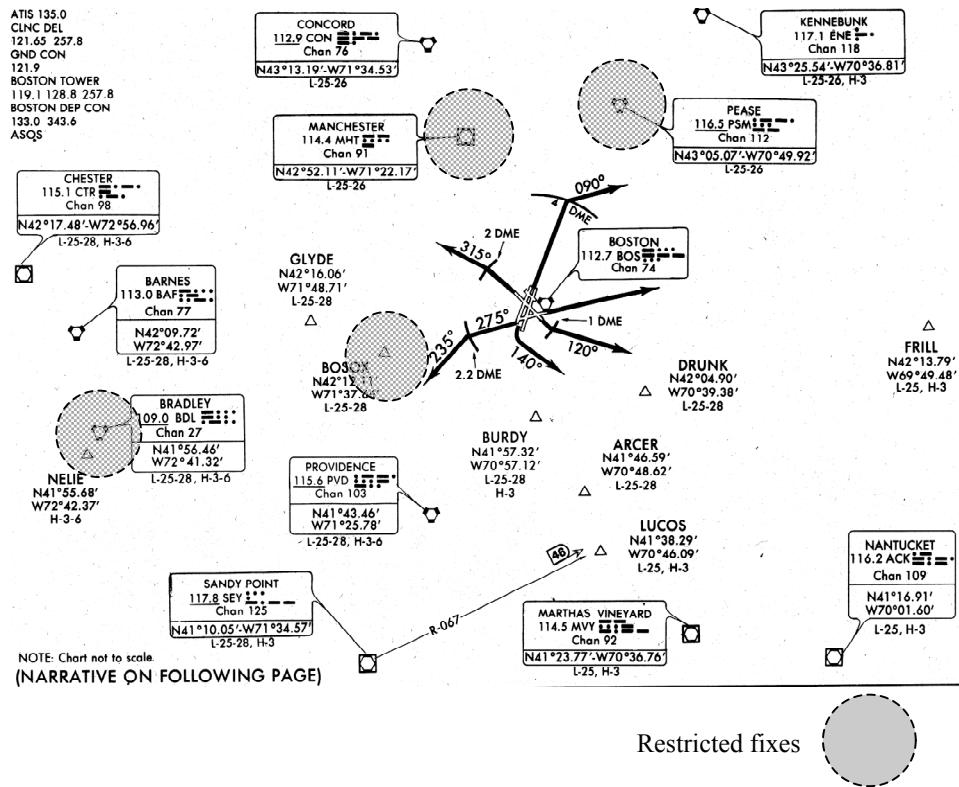

Figure 3.35: Exit fixes from Logan Airport

Figure 3.36 shows that the “taxi out” (Out to Off) time and especially the “schedule to pushback” time became excessive and erratic under the effect of the local GS restrictions. The average taxi out time reached almost 170 minutes for the aircraft that pushed back in the 15-minute period at 13:15, as aircraft were apparently stranded on the taxiway system. The schedule was also severely disrupted in terms of delays between the scheduled times and the pushback times, starting at around 11:30 and continuing throughout the day. Almost no aircraft were pushed back in the time period between 14:00 and 15:00, during which the airport was almost closed (as the departure throughput decreased to zero in Figure 3.34). As a result, the average number of aircraft scheduled but not pushed back increased to about 27 aircraft around the same time, as shown in Figure 3.37. Compared to the daily averages over the month of July and compared to the delays on July 21, 1998 (shown in Figure 3.33), the average number of aircraft scheduled but not pushed back were much higher and remained high throughout the rest of the day.

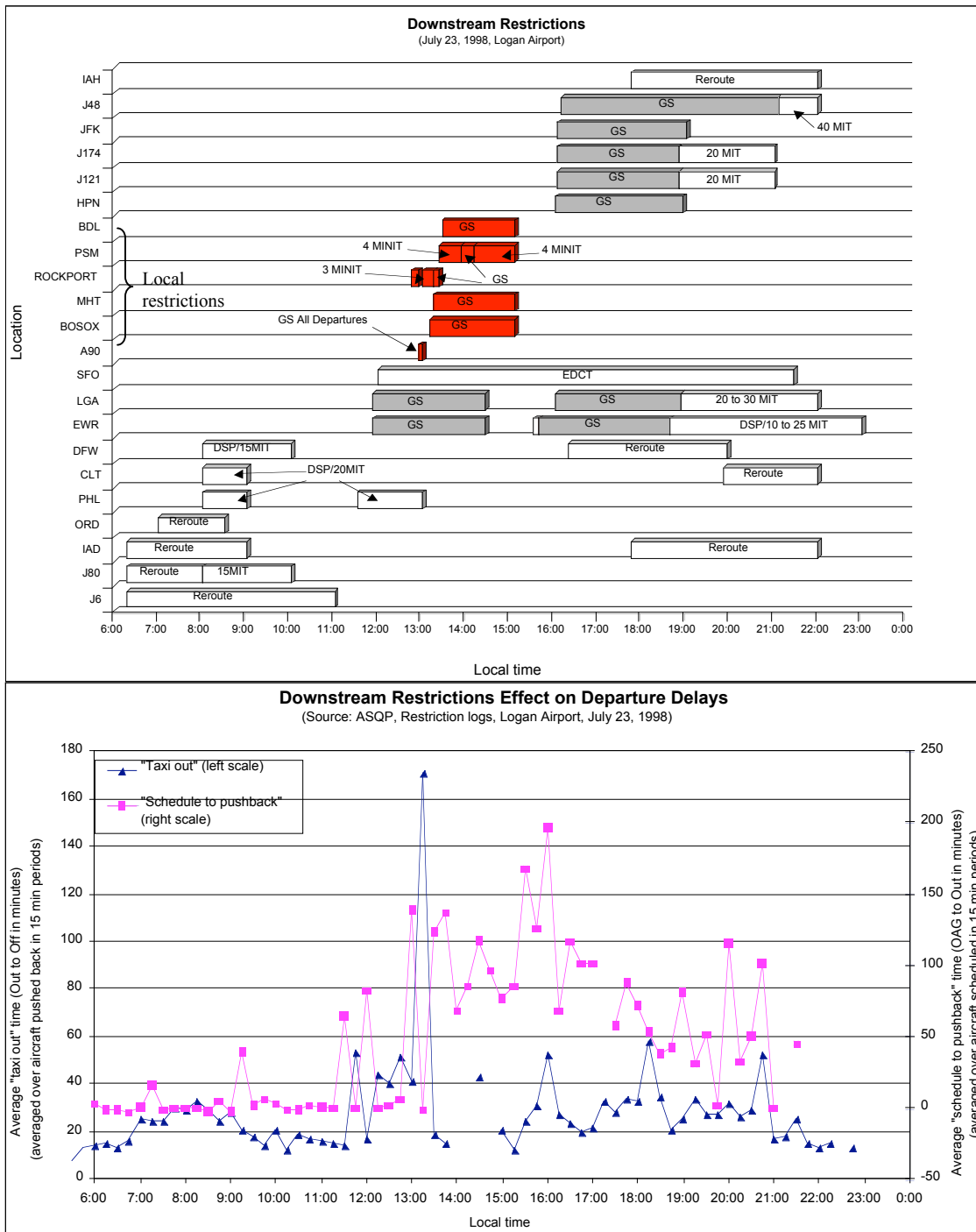

Figure 3.36: Local weather restrictions' effect on departure delays

Chapter 3: Observation and Flow Constraint Analysis of the Departure Process at Logan Airport

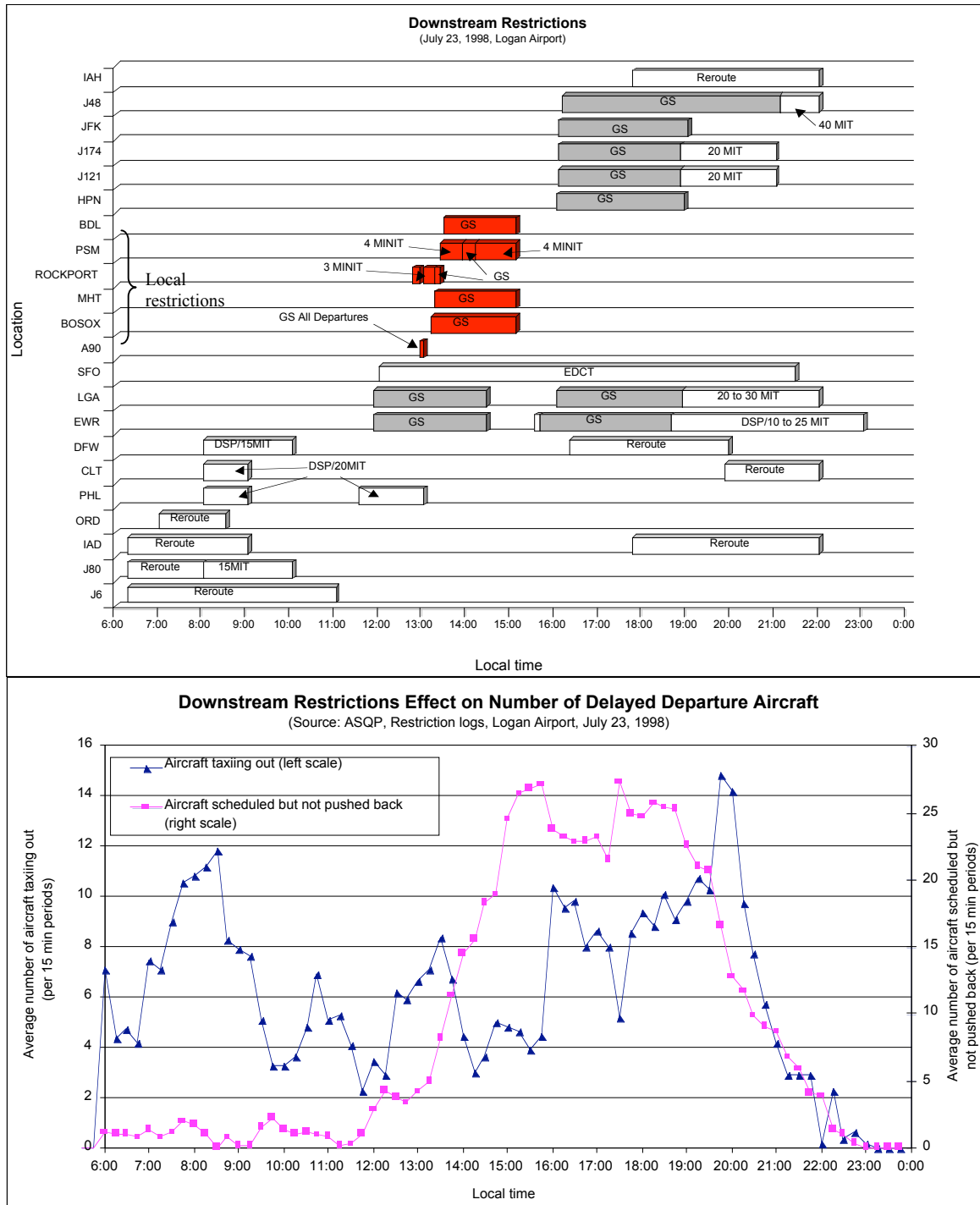

Figure 3.37: Local weather restrictions' effect on departure congestion

The number of aircraft taxiing out was also high as shown in Figure 3.37 (an average of 15 aircraft taxiing out at 20:00 compared to a daily average below 10 aircraft from Figure 3.33). However, the effect on the number of aircraft whose pushback was delayed was more pronounced (an average of 25 delayed aircraft between the hours 15:00 and 19:00 compared to a daily average of less than 6 delayed aircraft from Figure 3.33). This indicates that delays were absorbed when possible on the gates prior to pushback, in addition to the disruption of the schedule caused by the arrival delays. It should be noted that while some of the departure aircraft whose pushback was delayed may have been held on their gates, some may have been held in the air due to landing delays caused by the local thunderstorms that affected the airspace surrounding the airport. As shown in Figure 3.38, both the arrival and departure rates were affected by the local thunderstorms, which reduced both the arrival and departure throughput to zero around the hour 15:00.

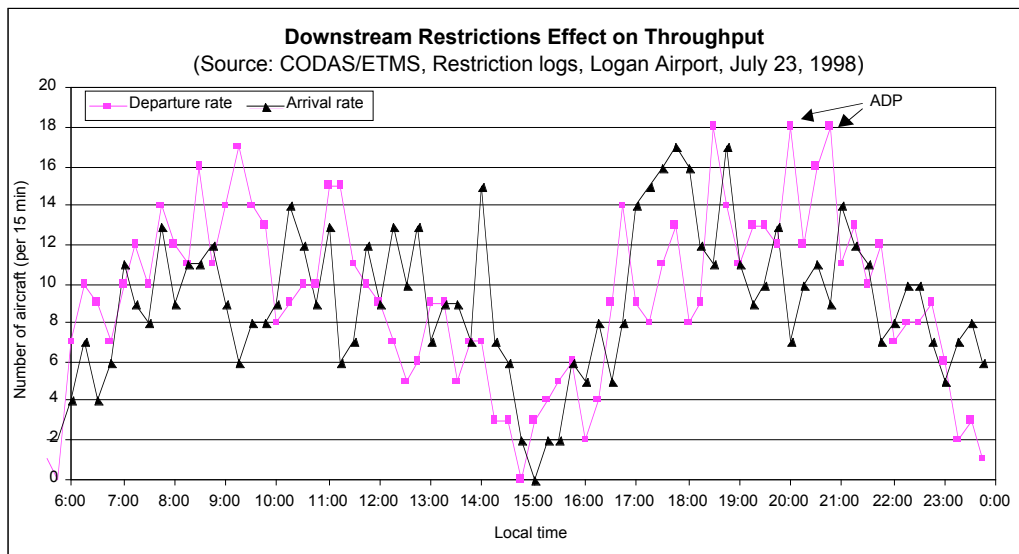

Figure 3.38: Arrival and departure rate reduction under local weather restrictions

**Note:** As shown in Figure 3.38 between the hours 20:00 and 21:00 the departure rate was maintained high relative to the arrival rate. According to the Tower logs the Accelerated Departure Procedure (ADP), which switches the use of runway 22L from arrivals to departures

(see Section 3.2.3.4) was used in the periods 19:55 to 20:16 and 20:43 to 20:58 in order to deplete the long departure queues.

#### **3.4.2.4 Effect of downstream restrictions on throughput**

The two examples of the downstream restrictions' effect on the departure process on July 21, and July 23, 1998 (described in Section 3.4.2.3) demonstrated that destination airport restrictions caused isolated delays to restricted aircraft but did not have a clear effect on the airport throughput performance. On the other hand, the departure throughput of the airport was reduced when local restrictions, particularly local GS restrictions, blocked a large portion of the outbound traffic through a number of exit fixes. This observation is demonstrated at an aggregate level by conducting a mean value analysis of the departure throughput under different types of downstream restrictions for the whole month of July 1998 (using the CODAS, ETMS 15-minute traffic counts)<sup>32</sup>. The results are displayed in Figure 3.39 and Table 3.3.

In Figure 3.39 the average departure throughput is compared between the 15-minute periods that experienced a local GS restriction (in addition to any other type of restriction) and the 15-minute periods that experienced no restrictions, restrictions at destination airports only and any (destination or local) restriction excluding a local GS. In addition to these groups, Table 3.3 shows the average departure throughput in 15-minute periods that experienced specific types of restrictions: EDCT, DSP, In-Trail at destination airports, local In-Trail through exit fixes, and GS at destination airports.

---

<sup>32</sup> The analysis was performed for the time periods between 7AM and 9PM in order to ensure high demand such that the effect of idleness on the throughput of the system is reduced.

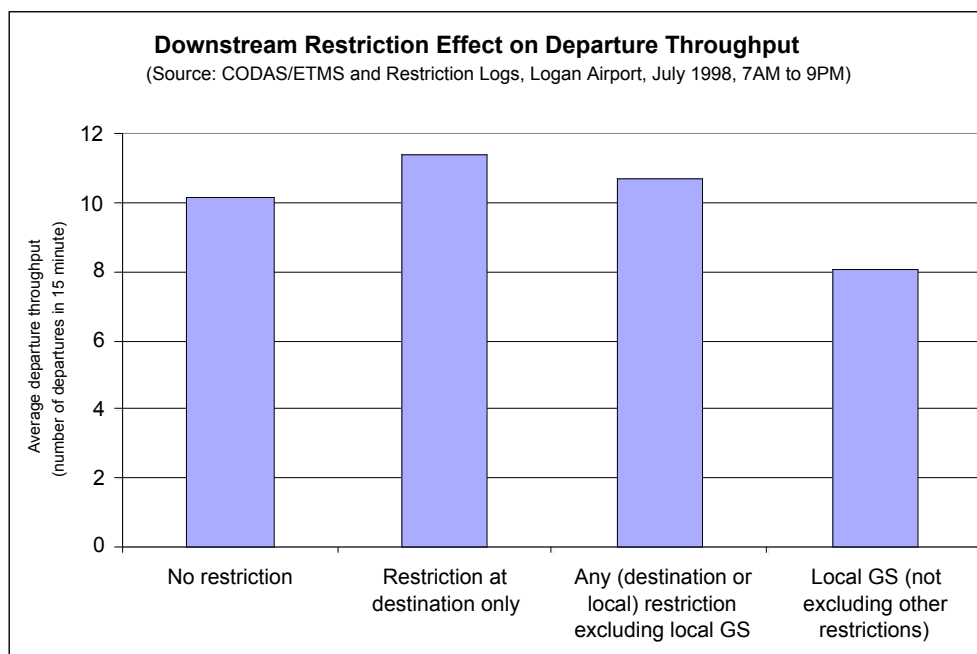

Figure 3.39: Mean value analysis of downstream restrictions' effect on departure throughput

Restriction type	Mean throughput (in 15 min)	Standard deviation (in 15 min)	Observations
No restriction	10.2	3.5	469
Restriction at destination only	11.4	3.2	1261
Any (destination or local) restriction excluding local GS	10.7	3.6	130
Local GS (not excluding other restrictions)	8.1	4.0	39
EDCT	10.7	3.0	109
DSP	10.5	3.4	211
In-Trail (at destination)	11.1	2.7	78
Local In-Trail (not excluding destination restrictions)	11.9	2.8	86
GS (at destination not excluding other destination restrictions)	12.2	3.1	232

Table 3.3: Mean value analysis of downstream restrictions' effect on departure throughput (July 1998)

In agreement with the July 21<sup>st</sup> and 23<sup>rd</sup> examples, the only significant effect on reducing the departure throughput (throughout the month of July) was under local Ground Stop restrictions. The departure throughput was reduced from an average of 10.2 departures in 15 minutes under no restrictions to an average of 8.1 departures in 15 minutes under local GS restrictions (with p-value of 0.002). All other types of restrictions, both destination and local, showed an increase

rather than a decrease in the average departure throughput. The departure throughput standard deviation also increased only in the case of the local GS restriction while it decreased slightly under the other restriction types.

Furthermore, Figure 3.40 shows that the effect of the local GS restriction was only significant when there were numerous restrictions through the exit fixes. When only one or two GS restrictions affected the traffic through exit fixes, the departure throughput of the airport remained at a normal average comparable to the average departure throughput under no restriction. Therefore, unless the number of GS restrictions through exit fixes is large enough, the departure runways may still operate at normal capacity delivering outbound traffic to the unrestricted exit fixes. When the number of local GS restrictions increased, however, a clear reduction in the departure throughput resulted, indicating a blocking effect on the runway system. Similarly, a much larger number of GS restrictions to destination airports would be needed in order to result in blocking of the runway system.

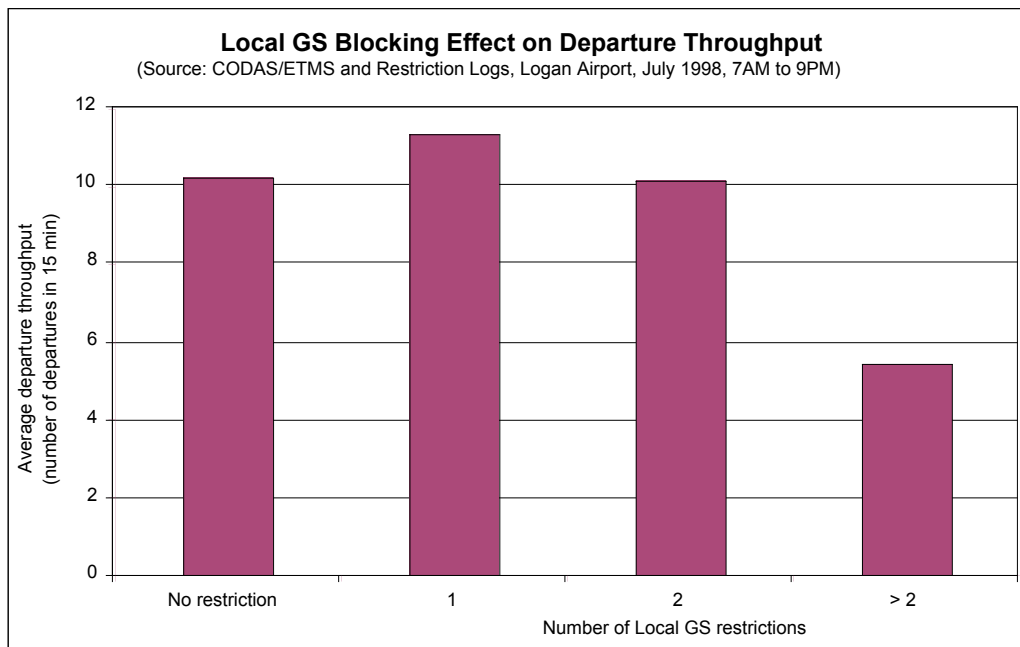

Figure 3.40: Local GS effect on departure throughput

### 3.4.2.5 Effect of downstream restrictions on delays

While, except for the local GS restrictions, most downstream restriction types did not demonstrate any significant effect on the departure throughput, the example of July 21, 1998 (Figure 3.31) showed that delays (although isolated) were incurred due to other types of restrictions as well. In order to demonstrate the aggregate effect of different types of downstream restrictions on the departure delays, the “taxi out” time (Out to Off) and “schedule to pushback” time were analyzed for samples of aircraft that suffered from different types of restrictions in the month of July 1998. The mean and standard deviation of the “taxi out” time and the “schedule to pushback” time are displayed in Figure 3.41 for the aircraft that suffered no-restriction and the aircraft that suffered one of six different types of restrictions. For taxi restrictions, a departure aircraft was considered restricted if there was an overlap between its taxi out time and the duration of the restriction. Similarly, for the gate restrictions a departure aircraft was considered restricted if there was an overlap between the duration between its scheduled and actual pushback times and the duration of a restriction. All samples included aircraft affected by a single type of restriction. The difference between each sample’s mean and the no-restriction sample mean is tested and the results are summarized in Table 3.4.

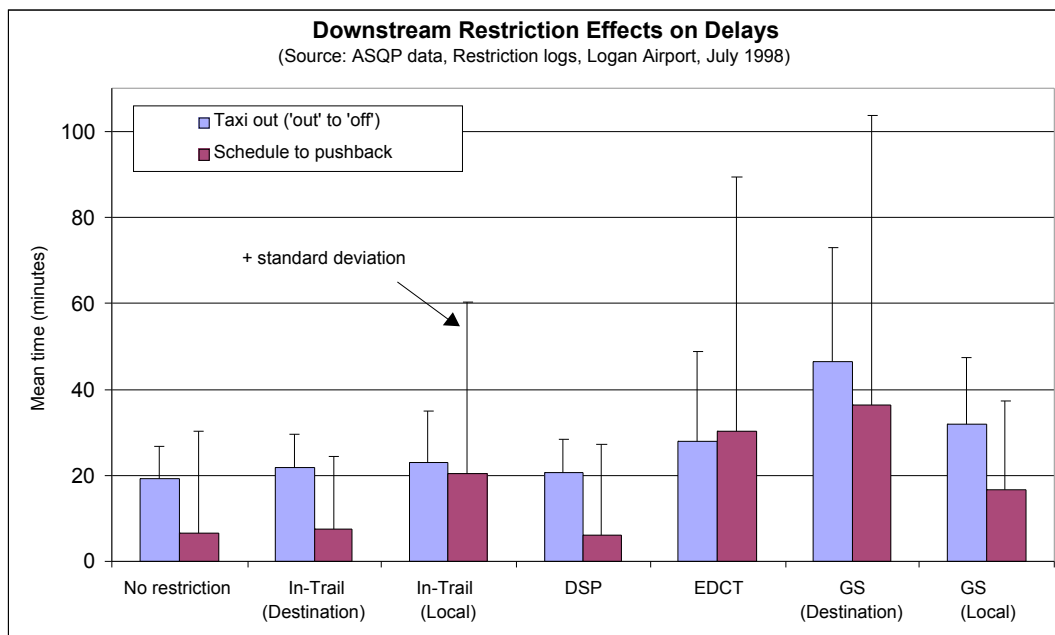

Figure 3.41: Mean value analysis of downstream restrictions’ effect on departure delays



Restriction type	Mean "taxi out" (min)	Standard deviation (min)	p-value (mean difference with No restriction)	Observations
No restriction	19.3	7.3		6896
In-Trail (Destination)	21.6	7.9	0.006	78
In-Trail (Local)	22.9	11.9	1.90E-08	342
DSP	20.6	7.9	0.002	329
EDCT	27.9	21	0.007	39
GS (Destination)	46.4	26.5	7.40E-06	27
GS (Local)	31.7	15.7	1.50E-07	55

Restriction type	Mean "schedule to pushback" (min)	Standard deviation (min)	p-value (mean difference with No restriction)	Observations
No restriction	6.4	23.7		6983
In-Trail (Destination)	7.3	17.2	0.34	60
In-Trail (Local)	20.3	40	6.60E-10	325
DSP	6.2	20.7	0.45	298
EDCT	30.1	59.2	0.008	39
GS (Destination)	36.3	67.2	0.007	34
GS (Local)	16.5	20.7	0.001	41

Table 3.4: Mean value analysis of downstream restrictions

The results of the aggregate mean value analysis (displayed in Figure 3.41 and Table 3.4) show that the most pronounced delay effects were caused by the Ground Stop restrictions both to destination airports and to local exit fixes<sup>33</sup>. The EDCT Ground Delay restriction also showed a significant delay effect particularly on the “schedule to pushback” time, which is expected since the Ground Delay restrictions are long-term restrictions that are usually absorbed by delaying the departure preparation (holding the aircraft on their gates or in parking areas). By comparison, it was not possible to conclude that DSP (which is a short-term sector program) had any effect on the “schedule to pushback” delay, although both EDCT and DSP are time-window type restrictions. This is due to the fact that, while the EDCT time window is issued far in advance, the DSP takeoff time window is requested from the sector (ARTCC) after the aircraft is on a movement area, and therefore, it is not possible to absorb the DSP delay on the gate. The effect of the DSP restriction is only evident on the taxi out time, although also small in magnitude.

Also it was not possible to conclude that the In-Trail restriction (Miles or Minutes in Trail) to destination airports had any significant effect on the “schedule to pushback” time and had a very small effect on the taxi out time. On the other hand, the local In-Trail restriction through exit

---

<sup>33</sup> Since no data were available on the actual exit fix used by the ACARS/ASQP aircraft, local restrictions were assumed to affect all ASQP aircraft whose “taxi out” or “schedule to pushback” time overlapped with the restriction duration. This has an attenuating effect on the local restrictions; however, despite the attenuation, the effects were evident.

fixes had a significant effect particularly on the “schedule to pushback” time. This may be explained, similarly to the local GS restriction, by the effect of the local weather, which disrupts both the arrival and departure traffic flow and causes significant schedule disruptions (as was described in the local weather restriction example on July 23, 1998 in Section 3.4.2.3).

Figure 3.41 indicates also that there was a significant effect of the downstream restrictions on the variability in the taxi out time and particularly in the “schedule to pushback” time. This effect is expected since, as was observed from the examples of July 21<sup>st</sup> and 23<sup>rd</sup> (presented in Section 3.4.2.3), some isolated restricted aircraft suffered excessive amounts of delay, especially due to the destination airport restrictions.

#### **3.4.2.6 Number of restricted aircraft**

It is evident based on the analysis of the effects of different downstream restriction types on the departure throughput and delays that the effect of the downstream restrictions is more severe when a larger number of aircraft is blocked due to the restrictions. This effect is shown in Figure 4.42 where the average taxi out and “schedule to pushback” times are compared between the 31 days of July 1998, as a function of the number of restricted aircraft. A departure aircraft is considered restricted if there was an overlap between the time duration between its scheduled pushback time and its takeoff time and the duration of a restriction (either to its destination or to one of the exit fixes). As expected, the delays increased with the number of restricted aircraft, and the two examples of July 21<sup>st</sup> and July 23<sup>rd</sup> (described in Section 3.4.2.3) stand out with large delays, particularly the 23<sup>rd</sup> of July in terms of pushback delays from the schedule.

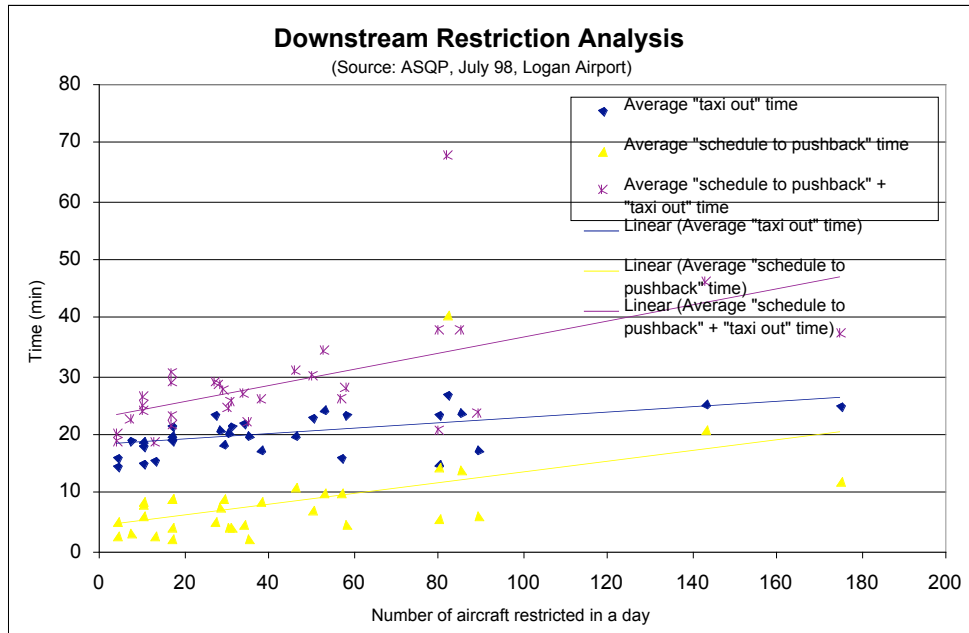

Figure 3.42: Downstream restrictions' effect as a function of number of restricted aircraft

### **3.4.3 Flow constraint manifestation at the gates**

Based on the observations and analysis of the runway and downstream flow constraints (discussed in Sections 3.4.1 and 3.4.2), the departure flow constraints manifest mainly at the runway system in terms of limiting the departure throughput, due to both the capacity limitations of runway system and the capacity limitations of resources downstream of the runway system, which propagate back and block the outbound flow. While the gates are not commonly the limiting factor of the departure throughput of the airport system, flow constraints often manifest at the gates by causing delays both to the arrival and departure aircraft demanding to occupy the gates and perform gate operations. A number of causal factors of flow constraint manifestation at the gates were observed during field observations at Logan Airport, in the Control Tower and in one airline's ramp/gate control station, as discussed in this section.

#### **3.4.3.1 Gate sharing by arrivals and departures**

As was observed in the queuing network at Logan Airport (Figure 3.8) the gates manifest as a flow constraint particularly in the gate-occupied queues formed by the arrival aircraft that find their gate still occupied by departure aircraft. Figure 3.43 shows the distribution of the ACARS pilots delay reports during the "taxi in" arrival phase between landing (On time) and parking at the gate (In time)<sup>34</sup>. The distribution shows that there is a dominance of the delays due to "gate occupied" over the other delay categories, such as ramp and field congestion. This is especially true for Boston Logan Airport as well as Chicago O'Hare and Dallas-Fort Worth airports, where over 50 percent of the "taxi in" delays were attributed to the gate occupied problem. While a "gate-occupied" delay may occur because an arrival aircraft is early, however, it is often caused by departure delays from leaving the gate on schedule, due to gate operations or due to other constraints such as absorbing Ground Delays as was described in Section 3.4.2.

---

<sup>34</sup> These data are for the same airline, 10-month period, and four airports that were used in the out to off delay reports in Figure 3.18.

010203040506070MechanicalMalfunctionReduced Visibility,Snow, IceField TrafficRampCongestionWait

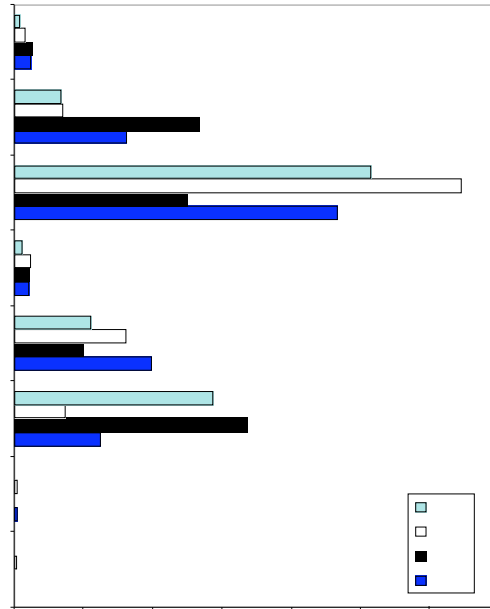

Figure 3.43: ACARS pilot delay reports during taxi in (One airline, January to October 1997)

### 3.4.3.2 Limited gate capacity

As shown in Figure 3.44, there are a limited number of gates available for airlines, which makes the gates a scarce resource with a finite capacity. Observations at Logan Airport showed that despite the limited gate capacity, some airlines overschedule their gates and consequently have simultaneously more aircraft on the ground than the number of available gates. In such cases, the airlines use hangar positions to store aircraft that do not have a gate readily available. The limited gate capacity problem is made worse by the inflexibility of the airlines in exchanging the use of gates between each other. Based on communication with Control Tower personnel, the Mass-Port Authority (MPA), which maintains Logan Airport, can force such an exchange when

an airline is underutilizing a gate, especially for International flights which have a limited number of gates in Terminal E.

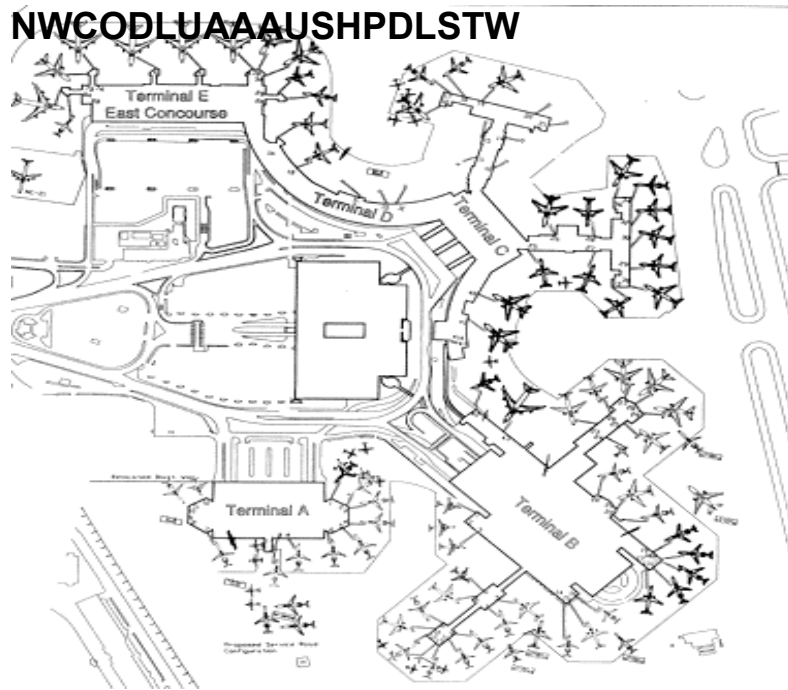

Figure 3.44: The gate layout at Logan Airport (from Delcaire)

### 3.4.3.3 High uncertainty and lack of observability in gate operations

While on the gate, an aircraft undergoes a complex set of operations to turn it around from an arrival to a departure. Based on observations and interviews with pilots, gate station managers and air traffic controllers, these operations are depicted in Figure 3.45 in the form of a Petri Net analysis, showing the processes that are required to get the aircraft to the state of “ready for pushback”. The circles represent conditions or states of the aircraft and of other elements of the airport system, and the bars represent transitions of state, which may be time-consuming processes. Arcs leading from circles to bars indicate that all the states represented by the circles must be satisfied before the transition occurs. Once the transition occurs the states represented by circles with arrows coming from the transition are satisfied. A "token" in a state circle

indicates that the state is satisfied. Each of the processes in the turnaround process contributes to the uncertainties and possible delays that may take place while the aircraft is on the gate.

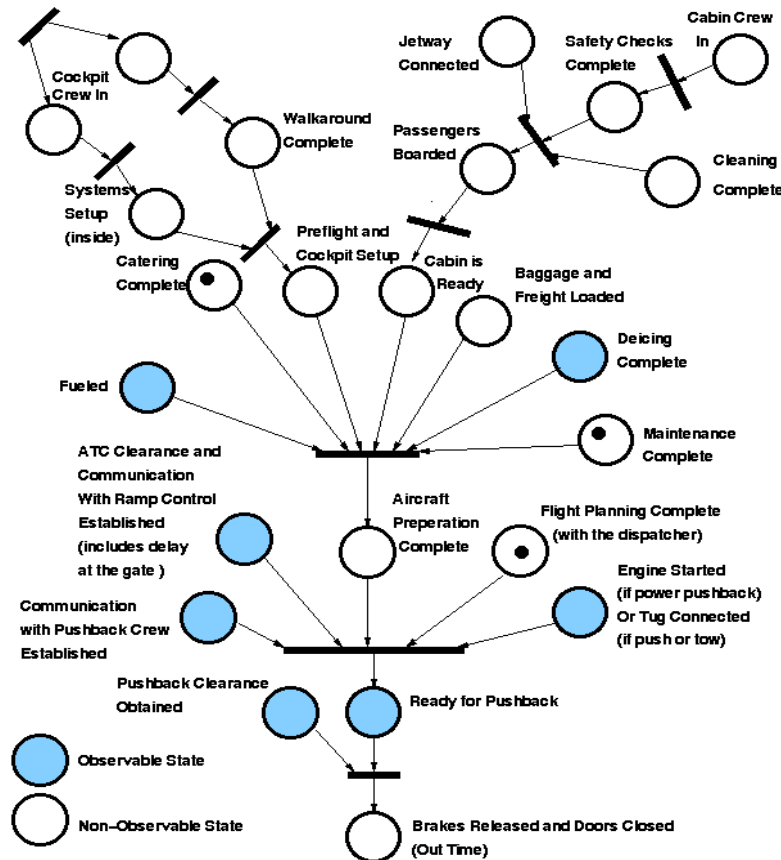

Figure 3.45: Departure on-gate operations and lack of ATC observability

The turnaround operations are managed by the airline's station at the airport. The air traffic controller (the Gate controller in the case of Logan Airport) receives a call from the pilot only after all the turnaround operations are completed to indicate that the aircraft is either “ready for pushback” (if jet) or “ready for taxi” (if prop). Then, the Ground controller (in the case of Logan Airport) delivers the pushback clearance to the pilot, the aircraft transitions to the state of “brakes released and doors closed,” and the pushback can commence. As shown in Figure 3.45, prior to the call for pushback, the air traffic controller has limited observability on many aircraft states (except possibly for deicing or fueling where the air traffic controller may be able to

observe the process from out the window). This prevents the controller from accurately predicting the time of “ready for pushback,” which is the first time that the aircraft is introduced into the ATC system.

Therefore, the only information that the controllers have about the departure demand becomes the schedule. According to the observations at Logan Airport there is a lot of uncertainty in this information. Figure 3.46 shows a 17 minute standard deviation in the difference between the departure schedule (proposed time from the flight progress strip, which is based on the airlines Computerized Reservation System) and the time of the aircraft “call ready.” The uncertainty is particularly high for the commuter and general aviation flights, which contribute to most of the deviation from the schedule, based on communication with Control Tower personnel. This lack of information is worsened further by the lack of communication between the Control Tower and the airlines gate stations. Often, the Control Tower keeps the flight progress strip of a cancelled flight unaware of the cancellation and expecting the aircraft to call ready.

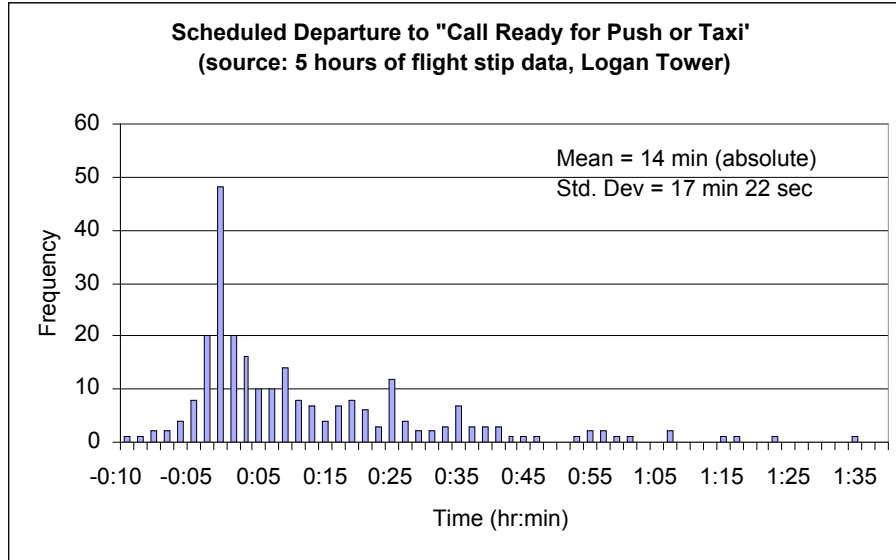

Figure 3.46: Uncertainty in the departure schedule



Looking at the complexity of the turnaround processes (Figure 3.45) and the uncertainty in the departure demand (Figure 3.46), it is evident how difficult it is for the controllers to predict exactly how many aircraft will call ready for pushback or taxi in the next few minutes and which flights are delayed or even cancelled<sup>35</sup>. This has a detrimental effect on the controllers' ability to perform better departure planning, both for the strategic runway configuration and operating mode selection processes in order to match the expected demand, as well as for the tactical aircraft movement control in order to comply with restrictions and reduce delays.

#### **3.4.3.4 Management of gate operations**

The gate operations and pushback coordination become complicated tasks, particularly at airports like Boston Logan where the terminal geometry is constrained (Figure 3.44) and the complexity and uncertainty in the gate operations are high (Figures 3.45 and 3.46). Airlines attempt to build robustness in their gate schedules and pushback operations by often increasing the buffer times between successive gate occupants and utilizing overflow gates. Figure 3.47 shows an example of the daily gate utilization by one major airline at Logan Airport. Some gates were highly utilized (by about 9 departure operations in the day) while other gates stayed relatively idle. According to communication with the airline's station manager, the airline keeps certain gates for overflow in order to accommodate disruptions in the schedule due to early arrivals, late departures or cancellations. The ability of the airline to improve robustness, however, is hindered by the lack of flexibility in gate assignment and transfer of gate usage between different airlines. Limitations in gate/aircraft type compatibility and staffing and equipment of gates are also major constraints.

---

<sup>35</sup> This is different from the arrival process, where the air traffic controllers are able to monitor the flow of arrival aircraft towards the airport on the radar screen as well as on the Aircraft Situation Display (ASD), which shows the current position of all IFR airborne aircraft in the NAS at any time. The controllers are therefore, able to predict the arrival demand much more accurately, particularly given the much lower uncertainty associated with the aircraft movement and progress once airborne.

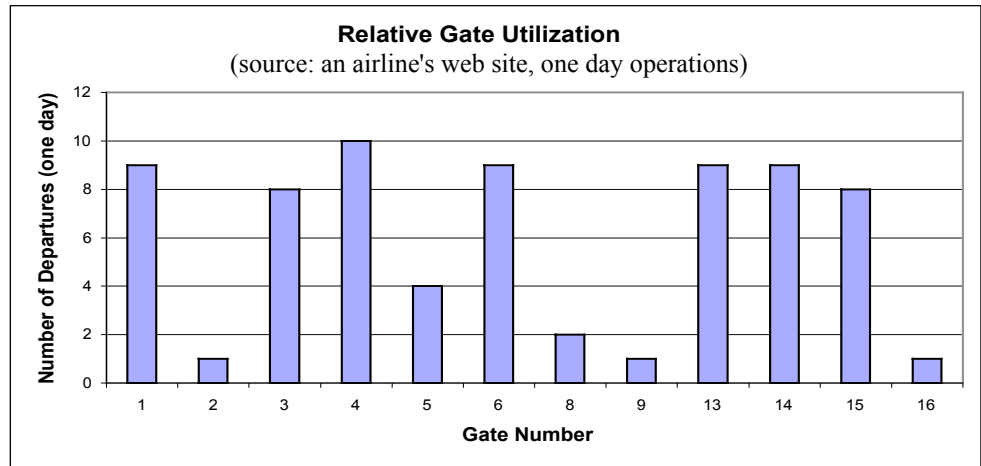

Figure 3.47: Gate utilization and overflow gates

### 3.4.3.5 Gate hold

In order to reduce the possibility of more expensive and more safety-critical delays in the air, aircraft are often delayed on the ground, and whenever possible, the ground delay is absorbed before pushback. This was demonstrated in Section 3.4.3.2, where under downstream restrictions (especially under Ground Stop and Ground Delay programs such as EDCT) delays were absorbed significantly before pushback causing delays from the schedule (Figure 3.41 for example). Departures are also held on the gate by air traffic controllers to meter the flow to the taxiway and runway systems within the airport. For example, in Figure 3.16, the time between the pilot’s call “ready for pushback” and the pushback clearance (the pre-pushback phase) included (in addition to the time needed for the handoff from the Gate controller to the Ground controller) any such holding of the aircraft on the gate. In this time distribution (which had an average of 2:38 minutes and a standard deviation of 6:38 minutes) two aircraft remained on their gate for 48 and 84 minutes after they called ready and before the pushback clearance. Such excessive times on the gate indicate gate holds (either due to Ground Delay, metering of the flow or possibly mechanical problems).

Absorbing delays on the gates, however, creates additional problems due to the scarcity of the gate resources and their sharing with arrival aircraft. When gates are not available to absorb delays (because they are needed for an arrival or another departure), the Control Tower, in coordination with the airline, may suspend delayed aircraft in dedicated delay absorbing areas on the airport surface. Compared to other airports, however, Logan Airport has very limited locations that can be used as delay absorbing areas. Therefore, the helipad and inactive runways are often used to hold delayed aircraft as shown in Figure 3.48. However, as a result delayed aircraft are often kept on their gates (while arrival aircraft that find their assigned gate occupied wait on the taxiways) or are held on a taxiway segment blocking another scarce resource.



Figure 3.48: Suspended aircraft  
(in the helipad in the center of the top picture and on the inactive runway 15R in the left side of the bottom picture)

### **3.4.3.6 Interdependence between gates and between gates and ramp/taxiways**

Often, aircraft have to wait for each other when they pushback into the same alley or taxiway or when a large aircraft occupies two closely spaced adjacent gates. Figure 3.49 shows an example of a gate alley at Logan Airport (called the “horse shoe”) where a maximum of two aircraft can pushback at the same time. It is also clear in the picture that larger jet aircraft are parked at gates around the corners in order to avoid blocking other gates.



Figure 3.49: The “horse shoe” gate alley (limited capacity for pushback)

In order to resolve the conflicts between pushback requests in the same gate alley, at Logan Airport the pushback clearance is delegated to the Control Tower, particularly when the alley is shared by multiple airlines as shown in Figure 3.49. The Control Tower clears aircraft for pushback in a strict FCFS order. Also as shown in Figures 3.49, some of the gates at Logan Airport are extremely close to the taxiway system. Aircraft from these gates pushback directly onto the taxiway system, and often they have to wait for the taxiing traffic that are using the taxiway and also block the taxiway for the duration of the pushback operation and engine start (see the picture in Figure 3.50 for an example). This coupling introduces more constraints on the gate operations, and led to the pushback from such gates on movement areas to be under the control of the Control Tower as well.



Figure 3.50: Taxiway blocking by pushback  
(A pushback on a taxiway blocks the taxiway while another taxiing aircraft is routed around it.)

#### **3.4.3.7 Ground controller workload associated with gate operations**

While at most other major airports, the gate and ramp operations are managed entirely by airline stations, at Logan Airport additional workload is incurred by the air traffic controller due to the added task of clearing and managing the pushback and the need for coordination with the airline stations. Figure 3.51 shows an example from the field observations, where the Ground controller was disrupted due to a gate-occupied/taxiway blocking problem. The Ground controller was under heavy task demand, which was manifested as shown in Figure 3.51 in a high number of communication events during heavy traffic hours. A gate occupied problem arose and caused a blocking of a taxiway segment while a queue of arrival aircraft formed. As a result the Ground controller was occupied for about 13 minutes in conversations with the gate station, the Tower Supervisor and the pilots in order to resolve the conflict. It was observed that during this time the adjacent controllers helped the Ground controller; the Local controller was clearing arrival aircraft to the ramp and the Gate controller was delivering pushback clearances. The added controller workload often causes additional delays and further constrains the departure process.

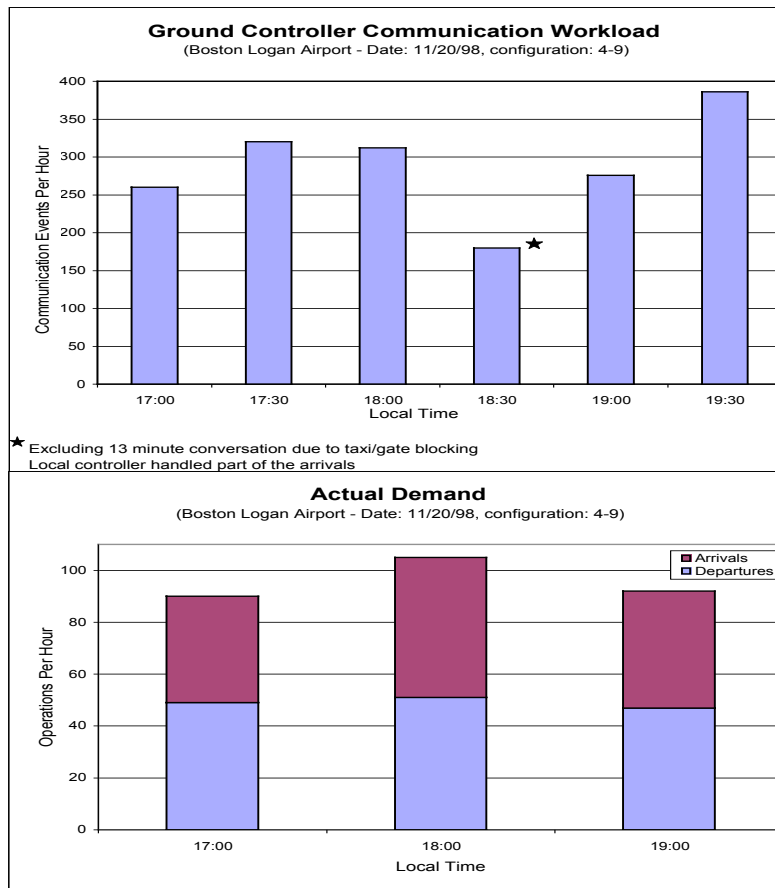

Figure 3.51: Ground controller communication load  
(Controller task disruption due to a gate-occupied problem)

### **3.4.4 Flow Constraint manifestation in the taxiway and ramp**

The ramp and taxiways provide a network of routes, which connect the aircraft, arrivals and departures, between the runways and the gates. While aircraft interact with each other and with other vehicular traffic at intersections, most of the time spent on the ramp and taxiways is waiting for a runway or for a gate. The ACARS pilot reported delays (Figure 3.18 for taxi out delays and 3.43 for taxi in delays) attributed to taxi and ramp congestion (at the four major airports) were small compared to the delays incurred due to the runway system in taxi out and due to the gates in taxi in. However, the observations at Logan Airport (for example, the queuing network at Logan Airport in Figure 3.8) showed interacting taxi queues for arrivals and departures and ramp queues of aircraft operating and waiting in the gate alleys. A number of causal factors that cause ramp and taxi delays were identified.

#### **3.4.4.1 Limited ramp and taxiway capacity**

As mentioned in Section 3.4.3, compared to other airports where airlines control a vast ramp area around their gates, Logan Airport does not possess any ramp area under airline control. In order to pushback and start their engines, aircraft use the gate alleys or taxiway segments, which often can serve one aircraft at a time (Figure 3.49), and are controlled by the Control Tower in order to resolve any conflicts. Therefore, departure and arrival aircraft often incur delays on their gates, and on the taxiways, waiting to use blocked alleys or taxiway segments next to the gates (see the pictures from Logan in Figures 3.52 and 3.53).





Figure 3.52: Conflict due to a blocked alley



Figure 3.53: Taxi queue due to a blocked alley

The lack of penalty boxes and parking areas further reduces the capacity of the ramp and taxiways, where aircraft often have to absorb delays on a taxiway segment causing blocking of a scarce resource. In order to increase the taxiway capacity, inactive runways are often used as additional taxiways as well as delay absorbing areas (Figure 3.48). Towing of aircraft between gates and between gates and hangar positions is another major constraint on the taxiway and ramp capacity at Logan Airport. Towing has to also be coordinated by the Control Tower, because it is conducted on the same taxiways used by taxiing aircraft under ATC control.



### **3.4.4.2 Routing and sequencing strategies**

The air traffic controllers usually attempt to maintain a FCFS sequence based on the time that the aircraft call ready. However, they also have certain sequencing strategies that are aimed at achieving more efficient operations or in order to implement certain imposed restrictions such as an assigned takeoff time or spacing between takeoffs. For example at Logan Airport, as was described in Section 3.4.1.4, controllers often attempt to either group jet and prop takeoffs to increase throughput or alternate jet and prop takeoffs in order to reduce departure controllers' workload since jets and props follow different initial departure routes. Some aircraft may need particular sequencing attention, for example, if they are restricted to a particular takeoff time or if they are an emergency and need to be expedited. Therefore, aircraft may be delayed on the taxiway system in favor of other aircraft that are sequenced ahead. The air traffic controllers start establishing the takeoff sequence from the introduction of the aircraft into the taxi stream from the gate alleys. There are also many intersection and merging points along the taxiways at which the Ground controller attempts to establish the takeoff sequence. In the 27/22L-22R/22L runway configuration described in Figure 3.8 the Ground controller determines the final takeoff sequence at the November taxiway entrance, since there is essentially only one takeoff queue beyond this point (see Figure 3.24). In other runway configuration such as the 4R/4L-9/4L/4R configuration, multiple takeoff queues are staged on the two sides of the departure runway 9 (see Appendix B). The Ground controller attempts in this case to stage the jets on one side and the props on the other side to allow the Local controller more sequencing opportunities such as alternating the types or grouping them.

Also, although it does not manifest at Logan Airport (which has one runway system and often one departure runway), when there are multiple runways for takeoffs, the takeoff runway assignment becomes another issue that the controllers have to manage. At airports with multiple runway systems, the controllers attempt to balance the runway loads on the different departure runways, and assign different taxi routes to aircraft accordingly.

### **3.4.4.3 Ground controller workload**

The Ground controller, who controls the taxiways as well as the pushback and taxiing in the alleys at Logan Airport, is one of the busiest control positions in the Control Tower. At Logan Airport, the Gate controller is assigned the task of metering the flow to the Ground controller based on the traffic level. During field observations, the Ground controller often instructed the Gate controller to suspend the delivery of aircraft if under high traffic load. At Newark Airport an additional Control Tower position (called "flow control") is added in heavy traffic hours in order to assist the Ground controller. The high number of communications that the Ground controller has to perform during hours of heavy traffic (for example, Figure 3.48) is one example of the high workload of the Ground controller. A minimal set of control instructions includes a pushback clearance, a taxi clearance, a taxi route assignment, a sequence assignment and a handoff to the Local controller for each departure aircraft, in addition to a taxi clearance and a taxi route assignment for each arrival aircraft. In addition, these instructions are often amended at different points along the taxiways.

# **CHAPTER 4**

## **CONTROLLED QUEUING: MODELING AND ANALYSIS**

Based on the observation and analysis of the departure process presented in Chapter 3, an analytical framework is posed in this chapter and used to analyze the departure process queuing dynamics. In Chapter 3, the departure process was abstracted as a controlled interactive queuing system, where queues represented the delays incurred due to the flow constraints and control notions (mainly the controlled blocking mechanism) represented the controllers' actions in managing the flow constraints. In this chapter, this controlled queuing model is used as a lumped element representation of the departure process or any sub-process of it--defined between specific events as described in Chapter 1. An analytical framework corresponding to the lumped element representation is posed, with an explicit representation of the queuing elements and the control elements. Then this framework is used to analyze the queuing dynamics and the control behavior under different scenarios, including the overall departure process between pushback and takeoff, the communication-based departure sub-processes and under downstream restrictions.

## **4.1 Overview of the controlled queuing model**

Figure 4.1 summarizes the basic elements of the departure process operation under the control of the air traffic controllers, based on the observation and analysis described in Chapter 3. In Figure 4.1, the physical abstraction of the departure process in Figures 3.11 through 3.14, is extended in order to represent the queuing system and control of an airport resource (which may represent abstractly a runway, a taxiway or a gate) and its interaction with the other resources within the departure process and in the overall NAS. An airport resource is controlled by an air traffic controller through the basic control mechanism--the clearance--and complementary control mechanisms such a sequencing, suspending and routing when possible. Aircraft form queues in front of the airport resource due to the resource capacity limitations, which might be caused as described in Chapter 3, by the implementation of ATC procedures through the different control mechanisms. For example, the air traffic controller has to insure the safe operation of a runway by maintaining the runway and wake vortex separation requirements between takeoffs, landings and runway crossings. Aircraft may also wait in queues in front of the airport resource due to capacity limitations at downstream resources. The air traffic controller may block the outbound flow from a resource under his or her control in order to maintain the level of traffic at downstream resources within safe and acceptable levels below capacity.

Figure 4.1 shows different feedback possibilities based on the observed airport operation described in Chapter 3. Feedback may be through a single air traffic controller in charge of multiple resources and queuing systems. For example, a Local controller might be in charge of multiple runways and a Ground controller is usually in charge of multiple taxiways (in the case of Logan Airport the Ground controller is also in charge of the pushback from the gates). Feedback may also be through cooperation between adjacent air traffic controllers. For example, the Gate controller has to regulate the flow of departure aircraft given the state of the traffic on the airport surface on the taxiways and runways (in some cases at the request of the adjacent

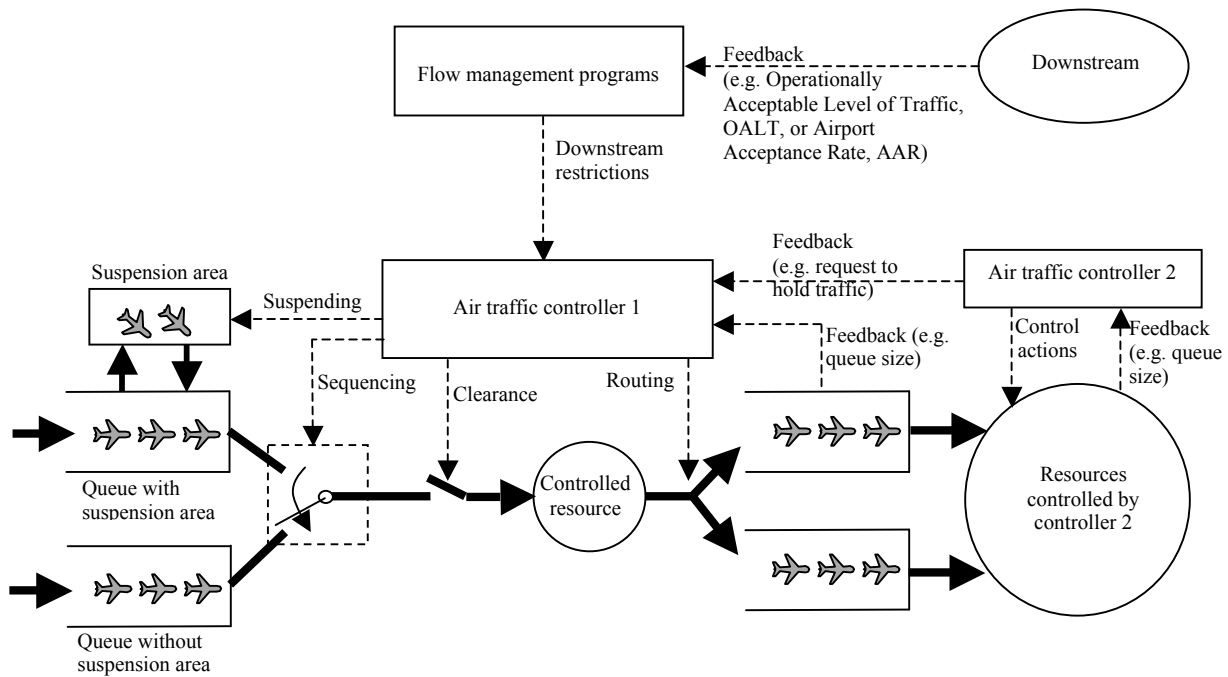

Figure 4.1: The basic elements of the departure process

Ground controller)<sup>36</sup>. Finally, when the downstream resources are far (such as exit fixes, airspace sectors and destination airports), feedback is established through the flow management process as described in Chapter 3. For example, as indicated in Figure 4.1, an Airport Acceptance Rate (AAR) and a sector’s Operationally Acceptable Level of Traffic (OALT) may be used as indications of the downstream capacity limitations, such that appropriate flow restrictions are imposed on the outbound flow to these locations. As described in Chapter 3 (Section 3.4.2.2), such restrictions may be imposed in the form of a takeoff time window, a spacing between takeoffs or a time delay.

<sup>36</sup> Feedback between controllers may be direct if they are adjacent or through the Supervisor and TMC of the Tower. Some control facilities such as Newark also employ a Tower Coordinator position to enhance the interaction.

## 4.2 Analytical framework

Using the controlled queuing model in Figure 4.1 as a physical representation of the departure process, a corresponding analytical framework is posed in this section based on common queuing notions. In this analytical framework, the role of the control elements in the physical model is represented explicitly, in order to allow the analysis of the queuing dynamics as well as the control behavior. This is essential both for gaining more insight about the airport departure process and for identifying possible improvement of the process through enhanced control.

### 4.2.1 The departure process system

In order to be able to define certain states and performance metrics of the departure process, and of aircraft in the departure process, a departure process system was defined in Chapter 1 as the set of aircraft operations performed between specific well-defined events. For example, a departure process system may represent the overall departure process between the pushback and takeoff events, as measured by the ACARS Out and Off time events, or it may represent departure sub-processes such as the ones defined between certain controller/pilot communication events (see Chapter 2).

Figure 4.2 depicts a generic departure process or sub-process as a black box system between an entry event and an exit event. A departure aircraft “*i*” enters the system by way of the entry event at time  $t_{\text{entry},i}$  and leaves the system by way of the exit event at time  $t_{\text{exit},i}$ . Using this representation, certain states of the departure process system and of the departure aircraft “*i*”, can be defined at any time  $t$ . For example, one state variable of the departure aircraft “*i*” is its time in the system  $D_i = t_{\text{exit},i} - t_{\text{entry},i}$ , which is the time that the departure aircraft spends in the system between entry and exit. At any current time  $t$  between the entry and exit,  $D_i$  may represent the elapsed time in the system for the aircraft between its entry time and the current time,  $D_i(t) = t - t_{\text{entry},i}$ . State variables of the departure process include, for example, the number of aircraft  $N(t)$  in the system at any time  $t$  (departure aircraft that had entered but did not exit yet at time  $t$ ), and the average rates of the entry and exit events (over some time period  $\Delta t$ ).

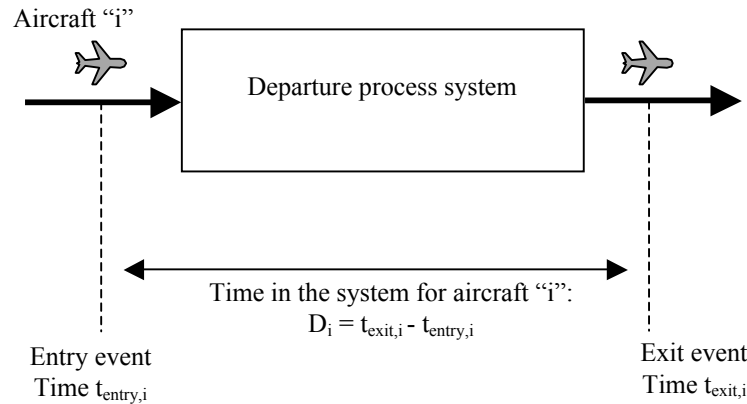

Figure 4.2: Departure process system

## 4.2.2 Lumped element representation of the departure process

Depending on the choice of the entry and exit events, the departure process system in Figure 4.2 may consist of a single or multiple airport resources. In order to pose a generic framework, the physical model presented in Figure 4.1 is used as a lumped element representation of the departure process system, where all the resources in the system are lumped into a resource element and all the queues in the system are lumped into a queuing element. This representation is depicted in Figure 4.3, where the essential elements of the controlled queuing model of Figure 4.1 are inserted as a lumped-element representation, inside the departure process system of Figure 4.2. In order to identify the control behavior explicitly in the queuing dynamics, the control elements are kept explicit as in the lumped element representation of Figure 4.3 (namely, the clearance/hold switch and the multiple queues for sequencing and suspending). The ATC control actions are also lumped into a single control input to the system.

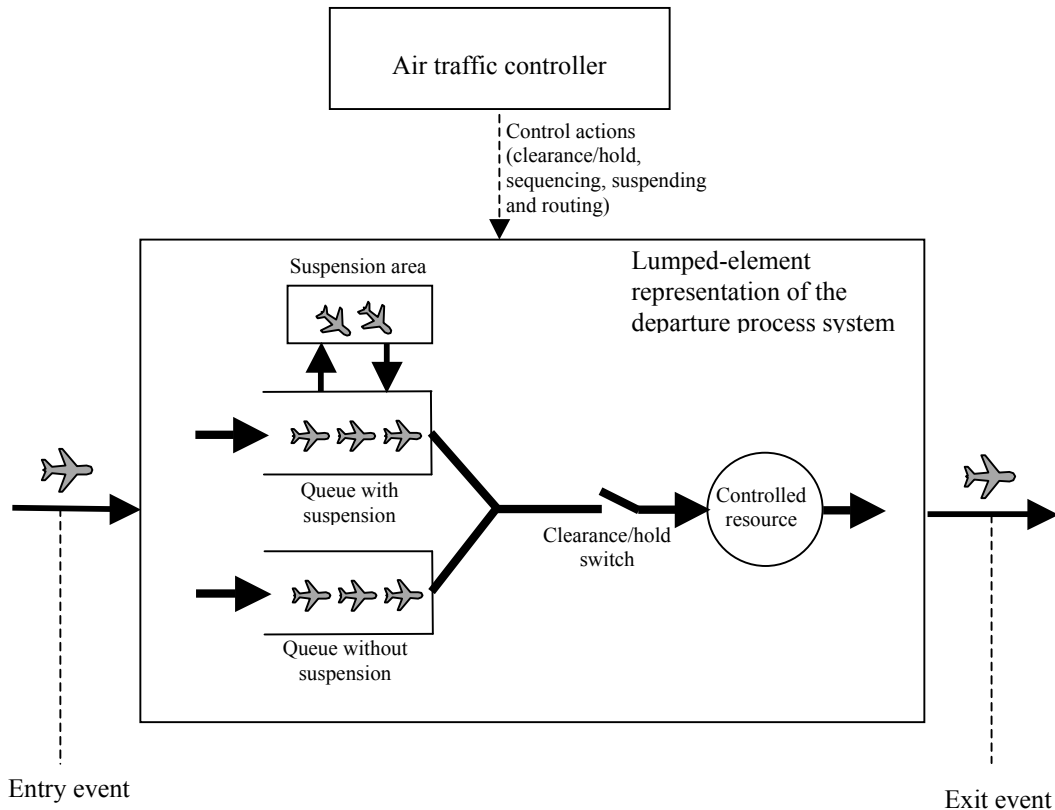

Figure 4.3: Lumped element representation of the departure process system

### 4.2.3 Analysis of the time in the system

In order to identify the queuing dynamics of the departure process, the time in the system  $D_i$  that a departure aircraft “ $i$ ” spends in the system is analyzed. In accordance with the lumped element representation of the departure process in Figure 4.3, components of the time  $D_i$  are associated with the queuing and control elements of the system. The control elements allow the isolation of the time components that are controllable by the air traffic controllers such that the control behavior can be identified.



### 4.2.3.1 Effective service and waiting components of the time in the system

Based on conventional queuing notions, the time that an aircraft spends in a queuing system is divided into two parts, a service time associated with the resource part of the system and a waiting time associated with the queuing part. According to the lumped-element representation of the departure process in Figure 4.3, the time  $D_i$  that a departure aircraft spends in the system is divided into an “effective” service time and an “effective” waiting time (defined below) that represent the resource and queue components, respectively, including the effects of the control elements (hence the term “effective”). The effects of the control elements are then isolated in the next section to identify the control behavior. (The following definitions are with respect to a particular aircraft  $i$ ; however for convenience, the subscript “ $i$ ” is omitted):

The **effective service time ES** is defined as the time that it would take a departure aircraft to travel in the system between the entry and exit events if the aircraft is unimpeded by any other departure aircraft. Although an aircraft may travel between the entry and exit events unimpeded even if other departure aircraft exist in the system, unobserved interactions due, for example, to waiting for communication channels and for air traffic controllers, may cause delays (see Section 3.3). Therefore, in order to avoid any interactions, a more conservative definition of the effective service time is the time that it would take a departure aircraft to travel in the system between the entry and exit events if the system is empty of any other departure aircraft.

The **effective waiting time EW** is defined as the time that a departure aircraft spends in the system between the entry and exit events due to being impeded by other departure aircraft in the system. The effective waiting time is the total time that a departure aircraft spends queuing behind other departure aircraft in the system, whether physically on the surface or due to any interactions. For example, EW also includes waiting in communication and flight progress strip queues behind other departure aircraft in the system.

Therefore, the effective service time ES is the “free-flow”<sup>37</sup> part of the total time  $D$  in the system, which is not impeded by other departure aircraft and the effective waiting time EW is the

---

<sup>37</sup> “Free-Flow” is a term used for the unimpeded travel time in a system, for example, (Hall [1991]).

part of the total time  $D$  in the system, which is due to impedance by other departure aircraft in the system. The two components add up to the total time in the system:  $D = ES + EW$ .

#### 4.2.3.2 Controllable components of the effective service and waiting times

Using the control elements, which are explicit in the lumped element representation of the departure process in Figure 4.3, controllable components are isolated in the effective service and waiting times defined in the previous section 4.2.3.1. These time components, which are associated with the control elements, are termed “procedural” time components to reflect that they are controllable by the air traffic controllers.

##### *Actual versus procedural service time*

Referring to the lumped element representation in Figure 4.3, given that the system is empty of any other departure aircraft, the effective service time  $ES$  that a departure aircraft spends in the system consists of two components: An **actual service time  $S$**  which is defined as the total time that the aircraft spends operating on the resources of the system after the clearances are delivered<sup>38</sup>, and a **procedural service time  $S_p$**  which is defined as the total time that the aircraft spends not operating on the resources of the system, prior to the delivery of the clearances. Both time components  $S$  and  $S_p$  are parts of the effective service time because they are incurred during free flow while the system is empty of any other departure aircraft.  $S$  is spent operating on the resources of the system, while  $S_p$  is spent being interrupted from operating. The two components add up to form the total effective service time of a departure aircraft,  $ES = S + S_p$ .

The actual service time  $S$  (which starts after the clearance is delivered) is determined by factors that are related to the aircraft operation on the resource, including aircraft performance, pilot behavior and resource conditions. While air traffic controllers were observed to encourage aircraft to speed up in some circumstances, the controller has hardly any control over the actual

---

<sup>38</sup> It was observed that one clearance instruction may include multiple clearances and clear an aircraft to proceed to use a series of subsequent resources, as in clearing aircraft through a number of taxiway intersections and segments up to a holding point and instructing aircraft to follow each other. In these cases when an aircraft arrives at the resource the clearance is already obtained.

service time  $S$  after the clearance is delivered. On the other hand, since the procedural service time  $S_p$  precedes the delivery of the clearances, it is controllable by the air traffic controllers who can block the service<sup>39</sup>. Control over  $S_p$  may be implemented either by holding a clearance from an aircraft or by suspending the aircraft in a suspension area. (Since no other departure aircraft exist in the system, the effect of  $S_p$  is identical whether the mechanism is holding the clearance or suspending in a suspension area).

Many of the flow constraints that were described in Chapter 3 limit the capacity of the airport resources (such as a departure runway) by introducing a procedural service time  $S_p$ . For example, Figure 3.21 (in Chapter 3) showed that, for a single departure runway at Logan Airport, an average observed time between successive takeoff clearances was 45 seconds when no landings, runway crossings or wake vortex separations intervened between the takeoffs. This average may be considered an approximation of the actual service time  $S$  for departures on the runway, since it represents mainly the runway occupancy time between the takeoff clearance and the wheels-off events. (The departure process system here is defined between the event of the departure aircraft arrival to the runway end, being the first or the only one in the takeoff queue, and the event of the wheels-off). After delivering the takeoff clearance, the air traffic controller has no control over the time that an aircraft will occupy the runway. Before delivering the takeoff clearance, however, the Local controller may hold the departure aircraft (which is the first or the only one in the takeoff queue and therefore, is unimpeded by other departure aircraft) for a procedural service time  $S_p$  in order to apply certain procedures for runway operations. For example, if the Local controller decided to insert one or more runway crossings before the takeoff, the departure aircraft would be held for a procedural time  $S_p$  prior to the takeoff clearance and its total effective service time would increase. Figure 3.21 (in Chapter 3) showed that the average time between the takeoff clearances increased to 2 minutes when runway crossings were inserted between takeoffs. The additional 1 minute and 15 seconds may be considered an approximation of the average procedural service time  $S_p$  of the departures on the

---

<sup>39</sup> The time  $S_p$  may be caused by uncontrollable interruptions that may be related to the aircraft (mechanical problems or internal delays) or related to the airport surface conditions.

runway caused by runway crossings. Since the air traffic controller controls the runway crossing, better sequencing strategies (as was described in Section 3.4.1.5) may improve the overall effective service time of departures on the runway system by reducing the procedural part that is due to runway crossing. Similarly, other factors that cause increased runway effective service time for departures, such as landing aircraft, wake vortex separations, and controller workload, can be attributed to procedural service time components. Then improved system performance may be achieved through better control that reduces the departure interruption due to these procedural service time components.

***FCFS versus procedural waiting time (Passing as indication of control)***

As defined in the previous section 4.2.3.1, the effective waiting time is the time that a departure aircraft spends in the system due to queuing behind other departure aircraft in the system. Based on the lumped element representation of the departure process (Figure 4.3), the air traffic controllers may influence the effective waiting time of a departure aircraft by changing the queue size that it experiences, through sequencing. Although the air traffic controllers attempt to maintain a First Come First Serve (FCFS) sequence, they may allow a particular departure aircraft to pass some of the existing aircraft in the system and allow other departure aircraft that enter the system later to pass it. Passing may be allowed, for example, if an aircraft is an emergency that has to be expedited, or has an assigned takeoff time, or if some of the existing aircraft are suspended absorbing long delays. Passing may also be allowed due to the different distances between the gates and the runways or due to the sequencing strategies of the controllers which may deviate from the nominal FCFS sequence in order to improve efficiency or workload as was described in Chapter 3. Therefore, the effect of the control behavior on the effective waiting time of a departure aircraft is isolated by using passing as an indication of the sequencing behavior that deviates from a nominal FCFS sequence.

Each departure aircraft experiences a queue size  $N$ , which is the number of departure aircraft that exit from the system during the time  $D$  that the departure aircraft spends in the system. In order to separate the effect of passing, the queue size  $N$  experienced by a departure aircraft is divided into two components: a FCFS component  $N_{FCFS}$  and a passing component  $N_p$ , where the FCFS

queue component reflects adherence to the FCFS sequence and the passing queue component reflects deviation from it. Figure 4.4 shows the queue experienced by a reference departure aircraft and the two, FCFS and passing, components of the queue. The FCFS queue component (of size  $N_{FCFS}$ ) consists of the departure aircraft that entered the system before the entry time of the reference aircraft and exited from the system during the time  $D$  that the reference aircraft spent in the system. The passing queue component (of size  $N_P$ ) consists of the departure aircraft that entered the system after the entry time of the reference aircraft but exited from the system during the time  $D$  that the reference aircraft spent in the system. The two components of the queue add up to form the total queue size experienced by the reference aircraft,  $N = N_{FCFS} + N_P$ .

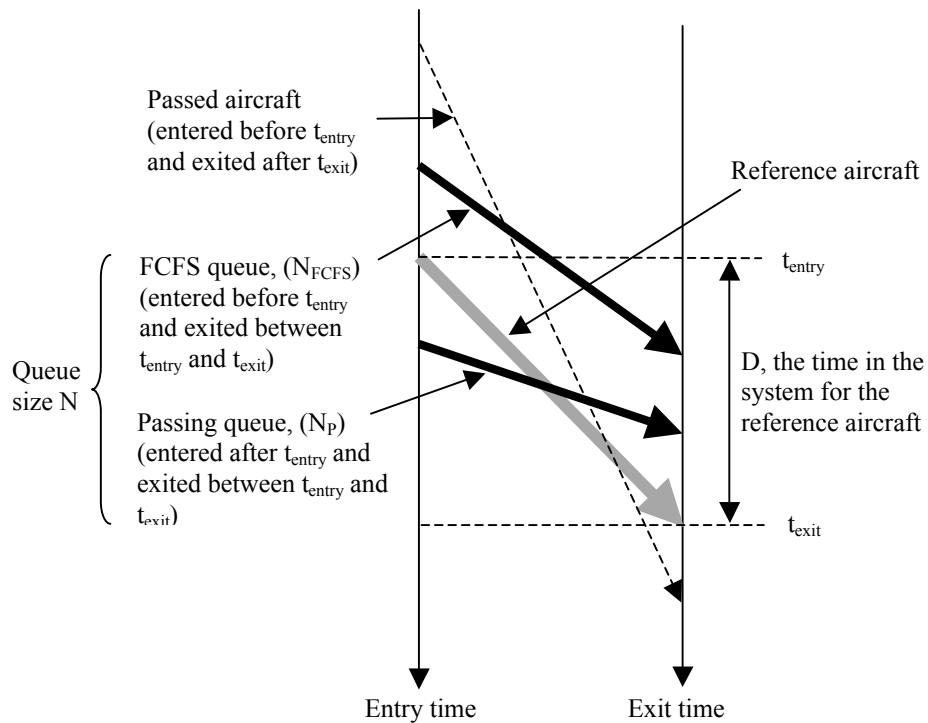

Figure 4.4: FCFS and passing queue components

Figure 4.4 also shows a number of departure aircraft that entered the system before the entry time of the reference aircraft but exited from the system after the reference aircraft. These aircraft could have been part of the FCFS queue component of the reference aircraft if they had

exited from the system before it. However, they were passed by the reference aircraft and therefore, they did not contribute to its queue size and did not affect its waiting time. The FCFS queue component ( $N_{FCFS}$ ) is the only portion of the aircraft that entered the system before the reference aircraft that remained in the queue ahead of it according to the FCFS sequence.

The effective waiting time  $EW$  of a departure aircraft is caused by the queue size  $N$  that the aircraft experienced:  $EW(N)$ . Corresponding to the two components of the queue, the effective waiting time is also divided into two components: the **FCFS waiting time**  $W_{FCFS}$  which is caused by waiting behind the FCFS component of the queue  $W_{FCFS}(N_{FCFS})$ , and the **procedural waiting time**  $W_P$ , which is caused by waiting behind the passing component of the queue  $W_P(N_P)$ . Therefore, the effective waiting time for a departure aircraft  $EW$ , is the sum of the FCFS waiting time and the procedural waiting time,  $EW(N) = W_{FCFS}(N_{FCFS}) + W_P(N_P)$ .

The passing queue component, therefore, indicates the effect of the non-FCFS sequencing behavior on the effective waiting time of reference aircraft, in terms of causing a procedural waiting time  $W_P$  in excess of the FCFS waiting time  $W_{FCFS}$ <sup>40</sup>. Control of  $W_{FCFS}$  is possible only to the extent that the air traffic controller can control the size of the FCFS component of the queue  $N_{FCFS}$  (most of which may be already at the runway end, beyond any possible resequencing). On the other hand, the procedural waiting time  $W_P$ , like  $S_P$ , is controlled mainly by the control actions of the air traffic controllers (namely, through sequencing, suspending and routing).

This control behavior is depicted in Figure 4.5 where the system queuing dynamics are represented in terms of the time in the system and its components as function of the queue size. The control actions of the controllers are shown to affect mainly,  $S_P$ ,  $W_P$  and the queue size

---

<sup>40</sup> By dividing the effective waiting time  $EW$  of a reference departure aircraft into two components,  $W_{FCFS}$  and  $W_P$ , it may appear that passing always causes an increase in the reference aircraft's effective waiting time through the procedural component  $W_P$  (which is caused by allowing other departure aircraft to pass the reference aircraft). However, passing also saves the reference aircraft waiting time by allowing it to pass some of the aircraft that existed in the system at its entry time. These passed aircraft may have caused additional FCFS waiting time, since the assumed nominal FCFS sequencing behavior would have sequenced the reference aircraft behind all the existing ones at entry time. Therefore, passing has two effects on the waiting time of each aircraft: one that increases the waiting time due to allowing other aircraft to pass it and one that reduces the waiting time by allowing the aircraft to pass other aircraft. The two effects nullify each other when averaged over all aircraft since for each aircraft that passes another aircraft, there is an aircraft that is passed.

including the passing aircraft  $N_P$  and to a lesser effect,  $N_{FCFS}$ . Hence, loss of system performance in terms of incurring delays can be attributable to any of the four system time components,  $S$ ,  $S_P$ ,  $W_{FCFS}$  and  $W_P$ . For example, the main factors that cause flow constraints (described in Chapter 3) cause delays to an aircraft through one or more of the time in the system components. However, the losses due to the procedural time components,  $S_P$  and  $W_P$ , are the ones that are potentially controllable, and could be improved upon through better control.

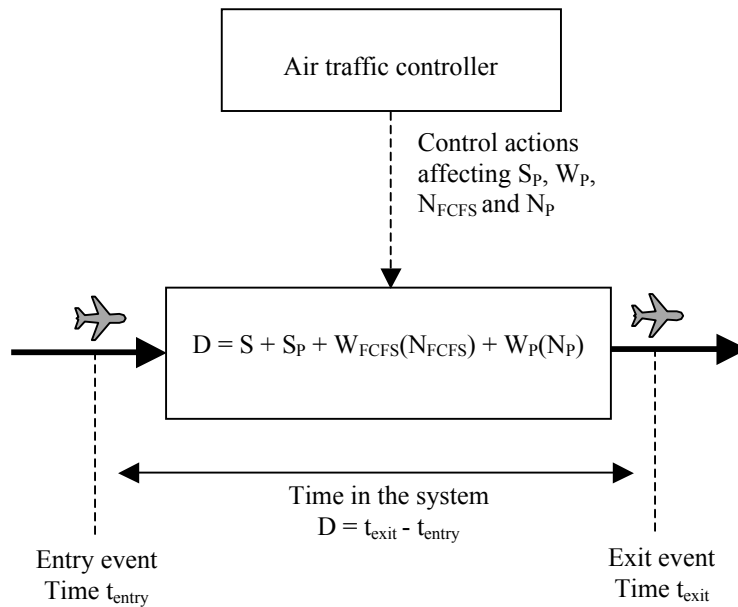

Figure 4.5: Analysis and control of the time in the system

Using the analytical framework posed in this section, the departure process queuing dynamics are analyzed in the next three sections of this chapter under different scenarios. In Section 4.3 the overall departure process between pushback and takeoff is analyzed and passing is used as an indication of the non-FCFS sequencing in the queuing dynamics. The overall relationship between the time in the system and the queue size is demonstrated including its two components attributed to FCFS sequencing and to passing. In Section 4.4 the four departure sub-processes, defined by the controller/pilot communication events, are analyzed using the same queuing framework, using passing again as indication of the control behavior. It is shown that the control

impact decreases in the runway phase, which exhibits mainly FCFS queuing dynamics. Finally, in Section 4.5 the queuing dynamics are analyzed for aircraft that are affected by downstream restrictions, indicating the difference in the queuing and control behavior under different types of restrictions.

### 4.3 Queuing dynamics of the overall departure process

In this Section the overall departure process, defined between the pushback and wheels-off events (see Figure 4.6) are analyzed based on the framework posed in Section 4.2. In addition to identifying the overall queuing and control behavior, the analysis of the overall departure process provides a basis for comparison with the dynamics of departure sub-processes and the dynamics under the effect of downstream restrictions, which are analyzed in the next two sections.

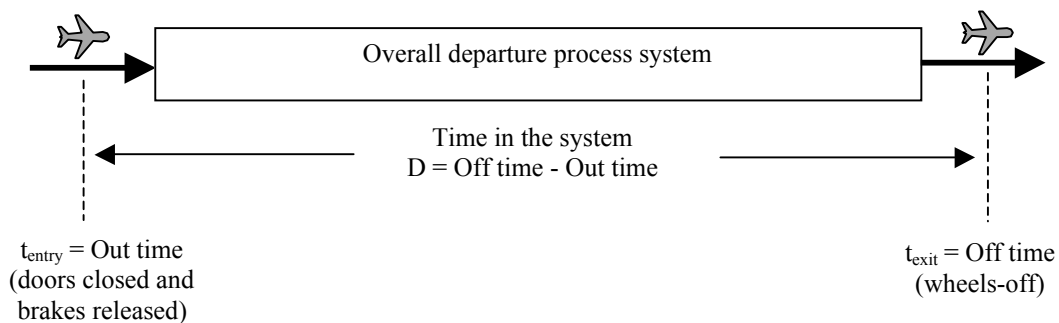

Figure 4.6: Overall departure process system based on the ACARS measurements

As shown in Figure 4.6, each departure aircraft enters into the overall departure process system at its Out time as measured by the ACARS “doors closed and brakes released” event and exits from the system at its Off time as measured by the ACARS “wheels-off” event. The time  $D$  that the aircraft spends in the system ( $D = \text{Off time} - \text{Out time}$ ) is referred to as the taxi out time.

The queuing dynamics were analyzed in terms of the relationship between the taxi out time and the queue size  $N$  (experienced by each departure aircraft) for a sample of one month of ASQP



data (July 1998)<sup>41</sup>. Based on the framework posed in Section 4.2, passing was used as an indication of the control behavior in terms of deviating from the nominal FCFS sequence. In order to isolate the passing behavior, the sample was divided into two sub-samples: departure aircraft that were not passed ( $N = N_{FCFS}$  and  $N_P = 0$ ), from which the waiting time due to FCFS queuing ( $W_{FCFS}$ ) was identified, and departure aircraft that were passed ( $N = N_{FCFS} + N_P$  and  $N_P > 0$ ), from which the waiting time due to passing ( $W_P$ ) was identified.

### 4.3.1 FCFS queuing dynamics

In order to identify the FCFS queuing dynamics, the relationship between the taxi out time and the queue size was determined for the sample of aircraft that were not passed ( $N = N_{FCFS}$  and  $N_P = 0$ ). Since the aircraft in this sample experienced only a FCFS queue, their effective waiting time also consisted entirely of the FCFS waiting time ( $W_{FCFS}$ ) with no passing effect in terms of a procedural waiting time ( $W_P = 0$ ). The average taxi out time (computed over the aircraft that experienced the same queue size,  $N_{FCFS}$ ) is plotted as a function of the queue size ( $N_{FCFS}$ ) in Figure 4.7. The different time components are identified on the plot including the average effective service time and the average effective waiting time as discussed below. Figure 4.7 also shows the range of taxi out times at each queue size and the queue size frequency distribution.

#### *The effective service time*

The zero intercept of the average taxi out versus queue size curve in Figure 4.7 (11:41 minutes) is the average taxi out time for the aircraft that experienced no queuing (zero queue size). Therefore, the zero intercept represents the average effective service time (ES), which is (as defined in Section 4.2) the average travel time that an aircraft would spend in the system between the Out and Off times if unimpeded by any other departure aircraft. Although they are difficult to separate, the average effective service time includes the two components (as shown in

---

<sup>41</sup> The analysis was performed without distinction between the runway configurations that were used in July 1998. Also there was no accounting for the dynamics of the airlines other than the 10 included in the ASQP data (about 50% of the total traffic at Logan Airport).

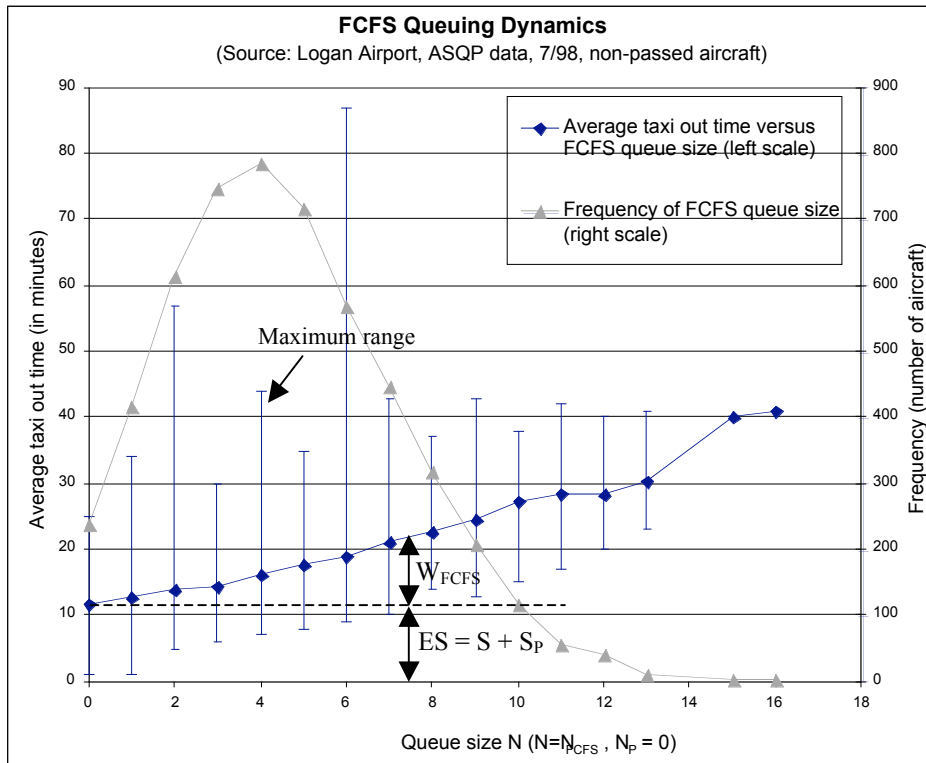

Figure 4.7: FCFS queuing dynamics

Figure 4.7): the actual service time ( $S$ ) when the aircraft were operating on the airport resources and the procedural time ( $S_p$ ) when the aircraft were not operating because they were held by not obtaining the clearances from the air traffic controllers or by being suspended.

Figure 4.8 shows the frequency distribution of the effective service time ( $ES$ ), with an average of 11:41 minutes and a standard deviation of 3:13 minutes. The variability in the effective service time is caused by factors such as the speed of the aircraft, the distance between the gate and the runway, the pilot's behavior, the airport surface conditions as well as any occurrences or restrictions that may have interrupted any of the aircraft operations. The variability is also caused by factors such as the traffic of the airlines not included in the ASQP data and the different runway configurations (which are not accounted for in this analysis). (These factors are also present in the taxi out time distributions at each value of the queue size in Figure 4.7).

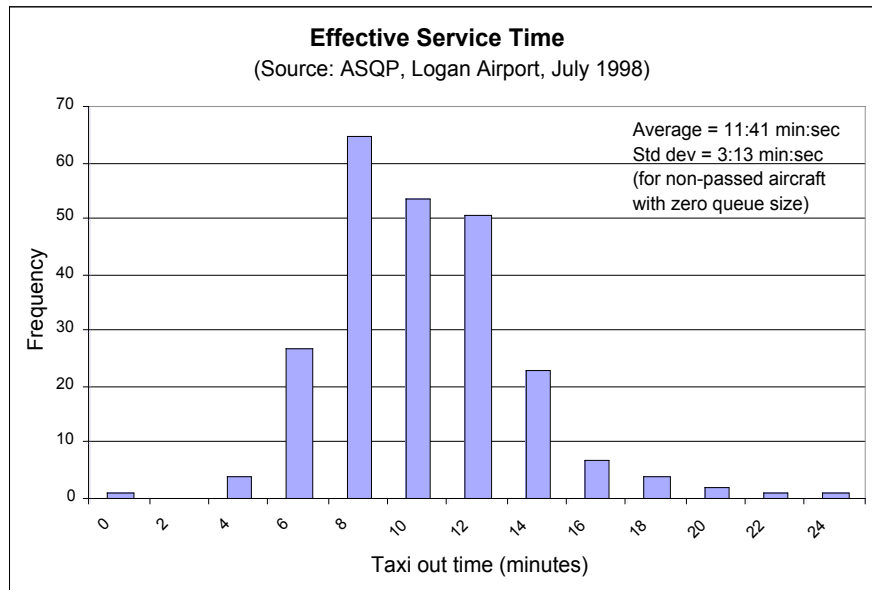

Figure 4.8: Effective service time distribution

### *The marginal system time*

For the aircraft that faced a queue size larger than zero in Figure 4.7, the zero intercept (average effective service time) represents the average taxi out time that these aircraft would have spent if they had experienced no queuing. Therefore, the vertical offset from the zero intercept to the average taxi out value on the curve represents the average FCFS waiting time ( $W_{FCFS}$ ) that was incurred by these aircraft because of the FCFS queue (of size  $N_{FCFS}$ ) that they experienced. The average taxi out time increases with the queue size in Figure 4.7 as expected, where the slope of the curve represents the average marginal waiting time that a departure aircraft spends in the system due to each additional aircraft in its queue.

**Note:** In a complex queuing network such as the overall departure process, the queue that is experienced by a reference departure aircraft (during its taxi out) may consist of aircraft in multiple interacting queues (See for example Figure 3.8 in Chapter 3). If the queue size is small (for example 1 or 2 aircraft), queuing may not occur since these aircraft may take off without any interaction with the reference aircraft in any of the individual queues of the queuing network

(including waiting for controllers or for communication channels). As the queue size (number of aircraft in the entire queuing network) increases, the probability of interacting with the other aircraft, and hence incurring additional waiting time due to queuing, increases. As this probability of interaction and queuing increases, the average marginal waiting time due to each additional aircraft in the queue also increases. Therefore, the slope of the average taxi out versus queue size curve in Figure 4.7 increases with the queue size. However, the slope should reach a maximum value, which reflects the saturation of the system's throughput at a maximum value as the queue size increases<sup>42</sup> (see for example, Cassandras, Figure 6.17).

### 4.3.2 Passing dynamics

The effect of passing on the queuing dynamics of the overall departure process was analyzed for the sample of aircraft that were passed ( $N_P > 0$  and  $N = N_{FCFS} + N_P$ ). As described in Section 4.2.3.2, the aircraft that are passed incur a procedural waiting time ( $W_P$ ) caused by the passing queue component ( $N_P$ ) in addition to the FCFS waiting time ( $W_{FCFS}$ ), which is caused by the FCFS queue component ( $N_{FCFS}$ ). In order to demonstrate the additional procedural waiting time caused by passing, the average taxi out time for the aircraft that were passed is divided into its main components as shown in Figure 4.9.

---

<sup>42</sup> As  $N_{FCFS}$  grows, more pressure is exerted on the system's resources and the throughput of the system approaches a maximum rate capacity (see for example Shumsky for Logan Airport). Consequently, the average marginal waiting time (which is the slope of the curve in Figure 4.7) approaches the minimum time possible between successive departures from the system, which is one over the system's maximum throughput (see for example, Cassandras for a closed queuing system with increasing population, Figure 6.17).

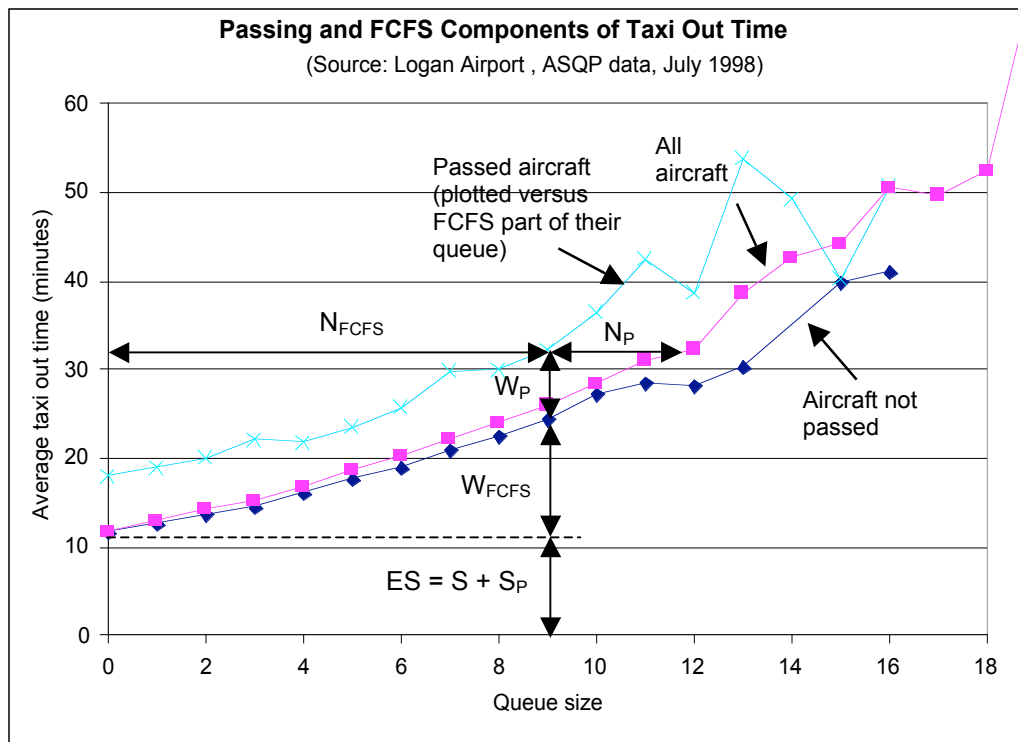

Figure 4.9: FCFS and passing components of overall queuing dynamics

In Figure 4.9 the average taxi out time of the passed aircraft ( $N_P > 0$  and  $N = N_{FCFS} + N_P$ ) is plotted versus the size of the FCFS component ( $N_{FCFS}$ ) of the queue that they experienced. For comparison, the FCFS queuing curve (from Figure 4.7) is added to Figure 4.9, showing the average taxi out time versus the FCFS queue size for the aircraft that were not passed ( $N_P = 0$  and  $N = N_{FCFS}$ ). Therefore, given the size of the FCFS queue component, the FCFS curve (for the aircraft that were not passed) approximates the average taxi out time that the passed aircraft would have incurred had they not been passed. As was shown in Figure 4.7, this time average includes the average effective service time ( $S + S_P$ ) that the aircraft would have incurred with zero queue size and the average FCFS waiting time ( $W_{FCFS}$ ) due to the FCFS queue component. Therefore, as shown in Figure 4.9, the vertical distance between the two curves is an approximation of the average procedural waiting time ( $W_P$ ), which is caused by the passing queue component ( $N_P$ ) of the queue. Superimposed in the same figure is the overall dynamics curve, which plots the average taxi out time versus the total queue size ( $N$ ), where ( $N =$

$N_{FCFS+N_p}$ ) (for all aircraft). The horizontal offset between the passed aircraft curve and the overall dynamics curve represents the average number of passing aircraft ( $N_p$ ), as shown in Figure 4.9.

Therefore, the passed aircraft spent an average procedural waiting time ( $W_p$ ) in taxi out, either due to being passed or which resulted in being passed by the ( $N_p$ ) passing aircraft, in addition to the FCFS component of the queue ( $N_{FCFS}$ ). This additional time is indicated in an aggregate way in Figure 4.10, which displays the frequency distribution of the taxi out time for the full sample of aircraft, divided into the two sub-samples: the departure aircraft that were passed and the departure aircraft that were not passed. The average taxi out time of the non-passed aircraft was 17:19 minutes (with a standard deviation of 5:55 minutes), while the average taxi out time of the passed aircraft was 25:50 minutes (with a standard deviation was 13:48 minutes). The two sub-samples combine resulting in an overall average taxi out time of 20:21 minutes with a standard deviation of 10:21 minutes.

The excess taxi out time spent by the passed aircraft was due to the larger queue size experienced by these aircraft. The average queue size experienced by the non-passed aircraft (which consisted only of a FCFS component) was 4.5 aircraft with a maximum of 16 aircraft as was shown in Figure 4.7. On the other hand, the average queue size experienced by the passed aircraft was 7.4 aircraft, 5.3 of which was the average size of the FCFS component and 2.1 the average number of the passing aircraft. It should be noted that these averages are in the month of July 1998, for the ten major airlines represented in the ASQP data and over all runway configurations.

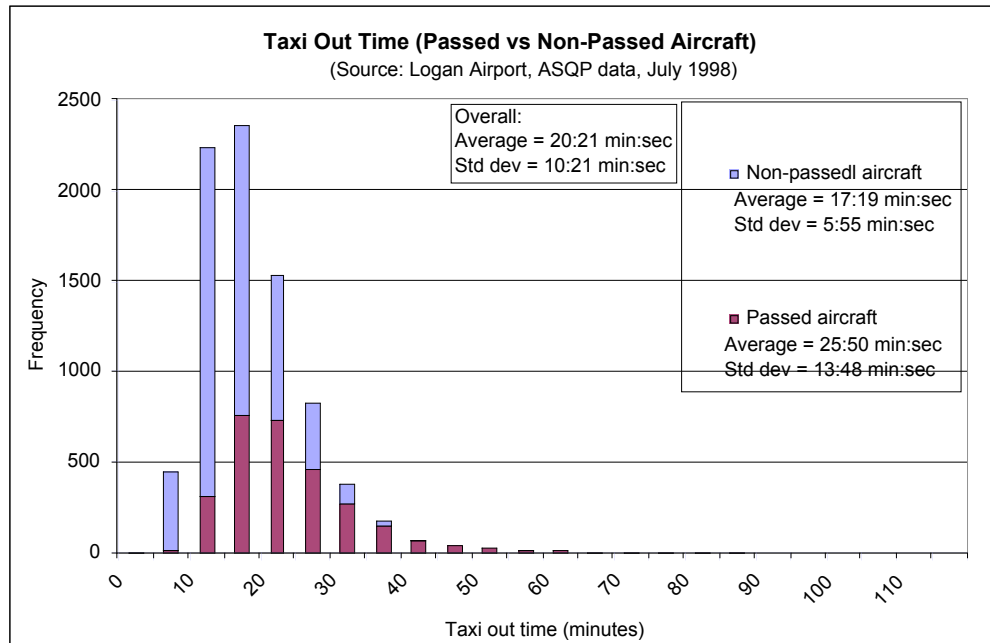

Figure 4.10: Passing effect on taxi out time

### 4.3.3 Overall queuing dynamics

A departure aircraft incurs a marginal taxi out time due to each departure aircraft in its queue, whether it is a FCFS sequenced aircraft or a passing aircraft. Therefore, the overall queuing dynamics are analyzed by relating the average taxi out time to the total queue size ( $N$ ) which consists of the two, FCFS and passing, components ( $N = N_{\text{FCFS}} + N_{\text{P}}$ ). Three curves are displayed in Figure 4.11, the average and the standard deviation of the taxi out time as a function of the queue size ( $N$ ), and the frequency of ( $N$ ).

#### 4.3.3.1 The overall passing and control behavior

The overall queuing dynamics curve in Figure 4.11 combines the FCFS dynamics and the passing dynamics. Since the FCFS queue size was limited to 16 aircraft (Figure 4.7), the larger queue sizes (which had a peak value of 45 aircraft) and the corresponding large taxi out times

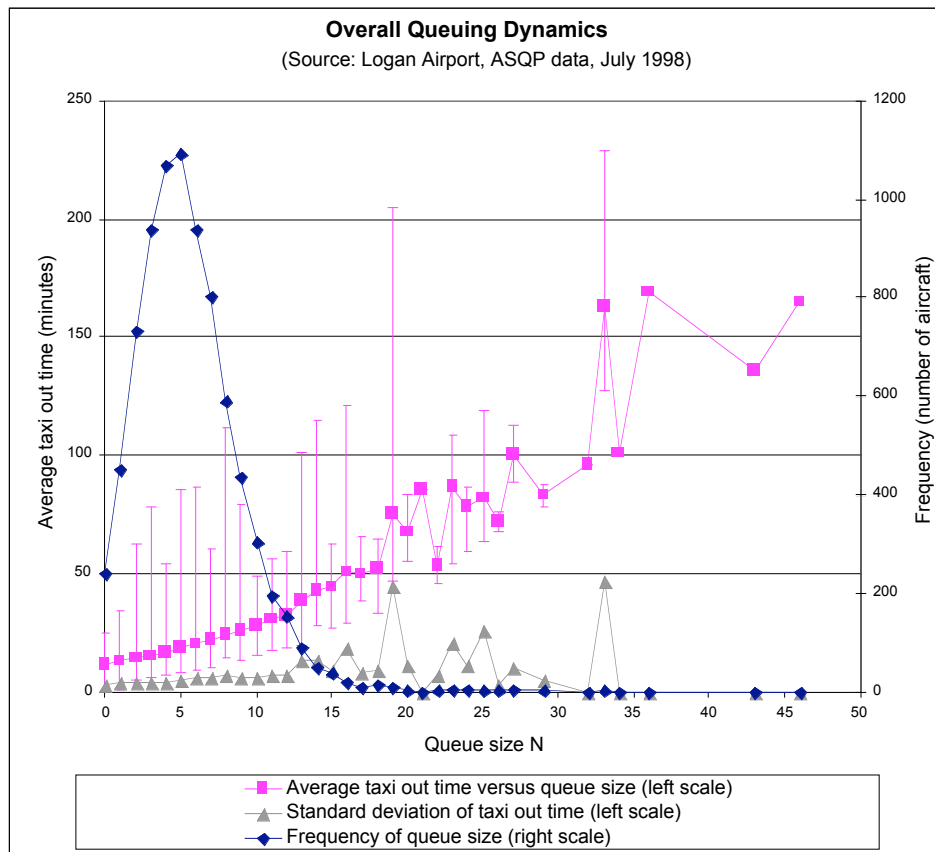

Figure 4.11: Overall queuing dynamics

(which had a peak value of 229 minutes) in Figure 4.11, are attributed to passing. These aircraft were probably suspended for a long delay while being passed by other departure aircraft. The frequency distribution of the queue size in Figure 4.11 shows that, on average, a departure aircraft experienced a queue size of 5.6 departure aircraft. This total queue size included a FCFS component, which had an average of 4.8 aircraft, and a passing component, which accounted for the remaining 0.8 aircraft of the queue<sup>43</sup>. While the cases of extreme passing and queue sizes may indicate suspension of taxiing under special circumstances, the average passing of 0.8 aircraft is indicative of a moderate level of control behavior through sequencing. Such common

<sup>43</sup> It was also shown that while a departure aircraft was passed on average by 0.8 other departure aircraft, it also passed on average 0.8 other departure aircraft. Therefore, while passing causes a procedural waiting time due to the passing aircraft, it also saves the aircraft a FCFS waiting time due to the passed aircraft. The two effects are identical in absolute value since for every passing aircraft there is a passed aircraft.



sequencing behavior is caused mainly by the variant distances between the gates and the runways as well as the common sequencing strategies of the air traffic controllers which may sometimes deviate from FCFS as was described in Chapter 3.

#### 4.3.3.2 The variance in the taxi out time

The standard deviation curve in Figure 4.11 shows the variability in the taxi out time as a function of the queue size. The standard deviation increases with the queue size as additional aircraft in the queue seem to add more uncertainty in the taxi out time. However, referring to the taxi out frequency distribution in Figure 4.10, the overall standard deviation in the taxi out time without any information about the queue size was 10:21 minutes. Knowledge about the queue size reduces the uncertainty as shown in Figure 4.11, where the standard deviation ranged between 3:13 minutes for  $N = 0$ , to 5:55 minutes for  $N = 10$  aircraft to 11:40 minutes for  $N = 20$  aircraft. This level of uncertainty is more indicative of what the air traffic controllers face in their estimation or prediction of the taxi out time since they monitor as well as can affect the queue size experienced by a particular departure aircraft.

**Note:** The uncertainty in the system time was improved with the knowledge of the queue size facing a particular aircraft. However, the uncertainty presented in Figure 4.11 is also attributed to non-modeled dynamics and factors. For example, the uncertainty may be improved by analyzing the dynamics under specific runway configurations, under specific weather conditions and possibly under particular air traffic controllers. The ASQP data also ignores about 50 percent of the traffic at the airport since only 10 major airlines report the ASQP data. Such factors should be considered in building accurate models for the purpose of estimation of the taxi out time, including the free flow taxi out time and the marginal taxi out time (zero intercept and slope of the taxi out versus queue size curve).

## 4.4 Queuing dynamics of the communication-based departure sub-processes

In this section the controller/pilot communication data, which was collected during field observations at Logan Airport, is analyzed in order to compare the queuing dynamics and control behavior in four departure sub-processes, according to the queuing framework described in Section 4.2. As was described in Chapter 2, five main communication events (the pilot's call "ready for pushback" (if jet) or "ready for taxi" (if prop) and four controller instructions: "clear for pushback," "clear for taxi," "monitor tower" and "clear for takeoff") were recorded manually, and the four departure sub-processes defined between them were used as surrogates for four main operational phases in the departure process (the gate, ramp, taxi and runway phases). In Chapter 3, a sample of eight hours of these controller/pilot communications (in the runway configuration 27/22L-22R/22L) was analyzed by comparing the time and throughput of the four sub-processes (Figures 3.16 and 3.17). It was demonstrated that while flow constraints manifested in each of the departure phases (generating delays locally), they manifested mainly in the runway phase, which incurred the largest delays and suffered throughput saturation.

In this section, each communication-based sub-process is represented with a lumped element representation consisting of a resource (representing the resources in the sub-process such as gates, ramp, taxiways or runways) and a queue (representing the queues in the sub-process) as shown in Figures 4.12 and 4.13. The queuing dynamics of each sub-process were analyzed in terms of the relationship between the time and the queue size experienced by each aircraft in each sub-process as shown in Figure 4.12. The time in each sub-process is the duration between the starting and ending communication events, and the queue size experienced by a reference aircraft in a sub-process is the number of aircraft whose exit event from the sub-process lies between the entry and exit events of the reference aircraft (see Figure 4.4). Two plots are displayed in Figure 4.12 for each communication-based sub-process: the average time as a function of the queue size and the frequency distribution of the queue size. Figure 4.13 shows

the distribution of the time in each of the communication-based sub-processes<sup>44</sup>. In order to gain insight about the control behavior in the different departure phases (which are represented by the communication-based sub-processes), the sample was divided into the passed and non-passed aircraft (similarly to the analysis in Section 4.3) where passing is used as an indication of the deviation from the nominal FCFS sequencing behavior. Therefore, in Figure 4.13 the time distribution is shown for the two sub-samples, comparing the time incurred by the aircraft that were passed with the time incurred by the aircraft that were not passed. Some of the insights about the queuing and control behavior gained from the analysis in Figures 4.12 and 4.13 are discussed in the next two subsections.

---

<sup>44</sup> Figure 4.13 is the same as Figure 3.16 in Chapter 3, with the sample divided into two components: the passed and non-passed aircraft.

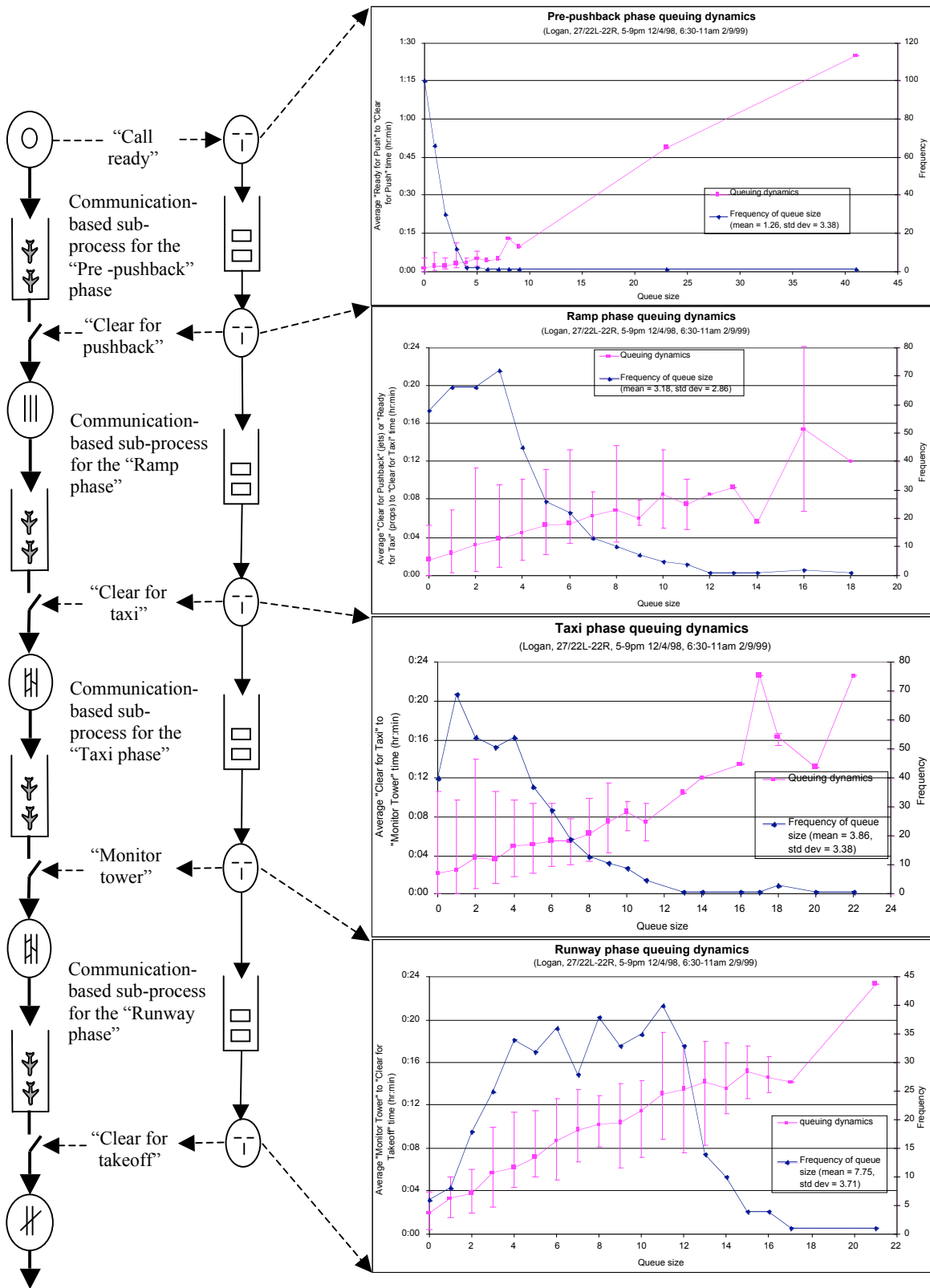

Figure 4.12: Queuing dynamics of the communication-based sub-processes

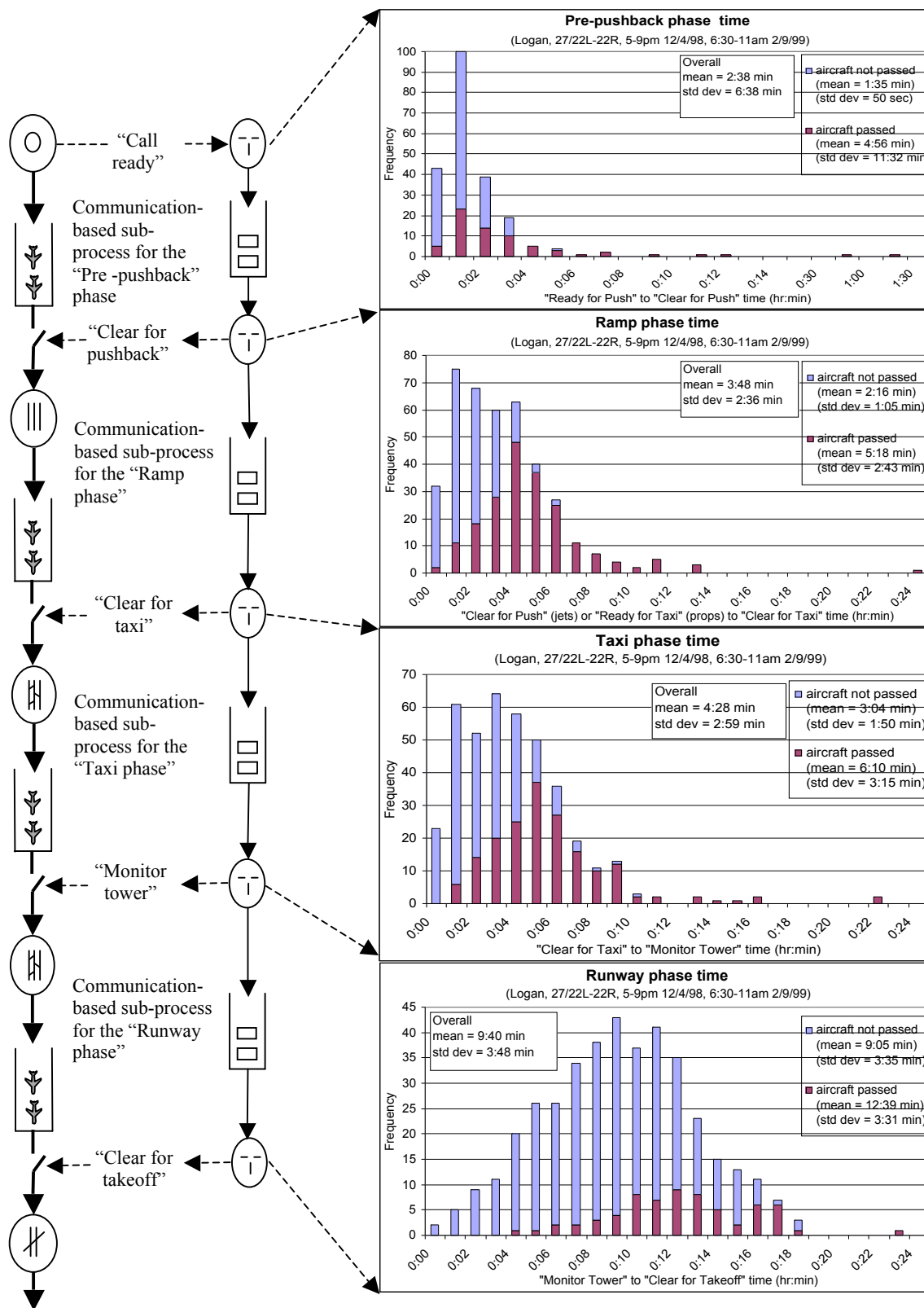

Figure 4.13: Time in the system of the communication-based sub-processes

### 4.4.1 Time versus queue size dynamics

The average time versus queue size curves in Figure 4.12 demonstrate the effective service time and the effective waiting time that each aircraft spent in each of the communication-based departure sub-processes (or corresponding departure phases). As described in Section 4.2, the average effective service time, which is the zero intercept of each curve in Figure 4.12, is the average time that an aircraft spent in each phase when unimpeded by other departure aircraft. The effective service time in each phase consists of an actual service time representing time operating on the resources of the phase and a procedural service time representing any interruption of service time by the air traffic controllers. The average effective waiting time (which is the vertical offset between the zero intercept and the curve) increases with the queue size as shown in Figure 4.12. According to the queuing framework in Section 4.2, the effective waiting time consists of a FCFS waiting time due to the FCFS component of the queue experienced by each aircraft, and a procedural waiting time (in excess of the FCFS waiting time) which results from waiting behind passing aircraft.

For example, the effective service time in the pre-pushback phase (which includes jet aircraft only), consists mainly of a procedural service time representing the duration of the handoff process from the Gate controller who receives the “ready for pushback” call to the Ground controller who delivers the pushback clearance. During this time the aircraft does not perform any actual operation; rather it simply incurs a procedural delay caused by the air traffic controllers delay in the handoff process and any holding of the aircraft on the gate due, for example, to imposed restrictions. The pushback clearances (as described in Chapter 3) are delivered based on a strictly FCFS sequence at Logan Airport. However, when restrictions or other circumstances require holding aircraft on the gate for a long delay, passing by other aircraft must be allowed. For example, while the average time in this phase was only 2 minutes and 38 seconds (from Figure 4.13), two aircraft spent 48 and 84 minutes between the first time that the pilot called “ready for pushback” and the pushback clearance. During this long delay, 23 and 45 other aircraft received their pushback clearance prior to these two aircraft (respectively), most of which were clearly passing aircraft (aircraft that called ready later) (see Figure 4.13). Although

it is not known what the particular causes were for the long delays, the observations described in Chapter 3 indicate that some of the causes might have been a Ground Delay or other type of downstream restrictions or a mechanical problem.

Similarly, the queuing dynamics of the ramp, taxi and runway phases include effective service times as well as effective waiting times. In the ramp phase, the effective service time includes actual operating time such as the pushback operation and the engine start for jets, while for props it consists mainly of a procedural service time representing the duration of the handoff process from the Gate controller who receives the “ready for taxi” call to the Ground controller who delivers the taxi clearance. The actual service time in the taxi and runway phases consists mainly of the duration of taxiing from the “Clear for Taxi” event to the “Monitor Tower” event (in the taxi phase) and from the “Monitor Tower” event until the “Clear for Takeoff” event (in the runway phase). Any ATC procedural interruptions of these operations (such as interruptions in pushing back or taxiing) contribute to the procedural service times in the ramp, taxi and runway phases.

Figures 4.12 and 4.13 reiterate the observation made in Chapter 3 (Figures 3.16 and 3.17) that the flow constraints manifest mainly in the runway phase which incurs the largest delays. The queue size frequency distributions in Figure 4.12 show that, on average, an aircraft queued behind 7.75 other aircraft in the runway phase, while in the taxi and ramp phases the mean queue size was below 4 aircraft, and only 1.26 aircraft in the pre-pushback phase. Corresponding to the largest queue size, aircraft incurred the largest average time in the runway phase as shown in Figure 4.13. The average time in the runway phase was 9:40 minutes, more than twice the average time in the taxi phase, which was 4:28 minutes and compared to only 3:48 minutes in the ramp phase and 2:38 minutes in the pre-pushback phase. From Figure 4.12, the average effective service time (the zero intercepts) for the four phases were comparable to each other (1:53 minutes in the runway phase, 2:08 minutes in the taxi phase, 1:35 minutes in the ramp phase and 1:29 minutes in the pre-pushback phase). Therefore, the average effective waiting time (which is the average total time minus the average effective service time) was also largest in the runway phase (8:47 minutes, compared to 2:20 minutes, 2:13 minutes, and 1:09 minutes in the taxi, ramp and pre-pushback phases respectively). This indicates that the larger delays incurred in the

runway phase were caused mainly by the longer queuing rather than longer service time for operations.

#### **4.4.2 Control points and opportunities**

Figure 4.13 indicates a dominance of the FCFS queuing behavior in the runway phase relative to the preceding phases, which manifested in the smaller percentage of aircraft that were passed in the runway phase. The dominance of the FCFS behavior over passing in the runway phase indicates that as aircraft entered the runway phase system the opportunity for control of the aircraft sequence by the air traffic controllers decreased. This is particularly true in the 27/22L-22R/22L runway configuration where the runway system consists mainly of a single takeoff queue that forms on the November taxiway (see Figure 3.8). In fact, most aircraft that were passed in the runway phase were aircraft that requested or were assigned to runway 22L, which is the landing runway, and had to wait for a longer time while aircraft that entered the runway phase later continued to take off on runway 22R. Also, in some cases the taxiway segments N1, N2 and N3 are used as penalty boxes to hold delayed or restricted aircraft. However, the gate, ramp and taxiway phases offer much more opportunity to sequence, route and suspend aircraft prior to their entry into the runway takeoff queue.



## 4.5 Queuing dynamics under downstream flow constraints

Downstream restrictions were identified in Chapter 3 as one of the major factors that cause departure flow constraints and drive the strategies of the air traffic controllers in managing the aircraft movement through sequencing and suspending. In this section the queuing dynamics of the departure process under downstream restrictions are analyzed using the queuing framework posed in Section 4.2. In Figure 4.14, the average taxi out time (Out to Off as measured by the ACARS/ASQP data) versus queue size relationship is shown for samples of aircraft under no restriction and under four different types of restrictions: Departure Sequencing Program (DSP, a 3-minute takeoff time window), Expected Departure Clearance Time (EDCT, a 15-minute takeoff time window), Miles or Minutes In Trail (In-Trail spacing between takeoffs) and Ground Stop (GS, a time delay) (see Section 3.4.2.2). A departure aircraft was considered restricted if there was an overlap between its taxi out time and the duration of a restriction. The analysis was conducted for the sample of ASQP data in the month of July 1998. The average taxi out time versus queue size curve (from Figure 4.11) is included in Figure 4.14 for comparison, representing the queuing dynamics of the overall departure process (for the full sample in the same period).

As evident from Figure 4.14, the average taxi out time versus queue size curves of the aircraft that suffered no restriction as well as of the aircraft that suffered DSP, EDCT and IN-Trail type restrictions almost coincided with the overall curve of all aircraft. On the other hand, the aircraft that suffered GS restrictions deviated from the all-aircraft curve and accounted for most of the suspended aircraft that experienced excessive queue sizes and taxi out times (except for one case of an EDCT restriction). Therefore, Figure 4.14 demonstrates a main difference between the time window (DSP and EDCT) or time spacing (IN-TRAIL) type restrictions and between the time delay type restriction (GS). In general, the effect of the latter is clearly larger in terms of causing excessive taxi out time and longer queues. But also, the fact that the DSP, EDCT and IN-TRAIL curves almost coincided with the all-aircraft queuing curve suggests that the two types of restrictions (time window and time spacing) are implemented mainly through

sequencing (inserting the appropriate number of aircraft ahead or in between). The GS curve, on the other hand, deviated substantially from the all-aircraft queuing curve, suggesting that

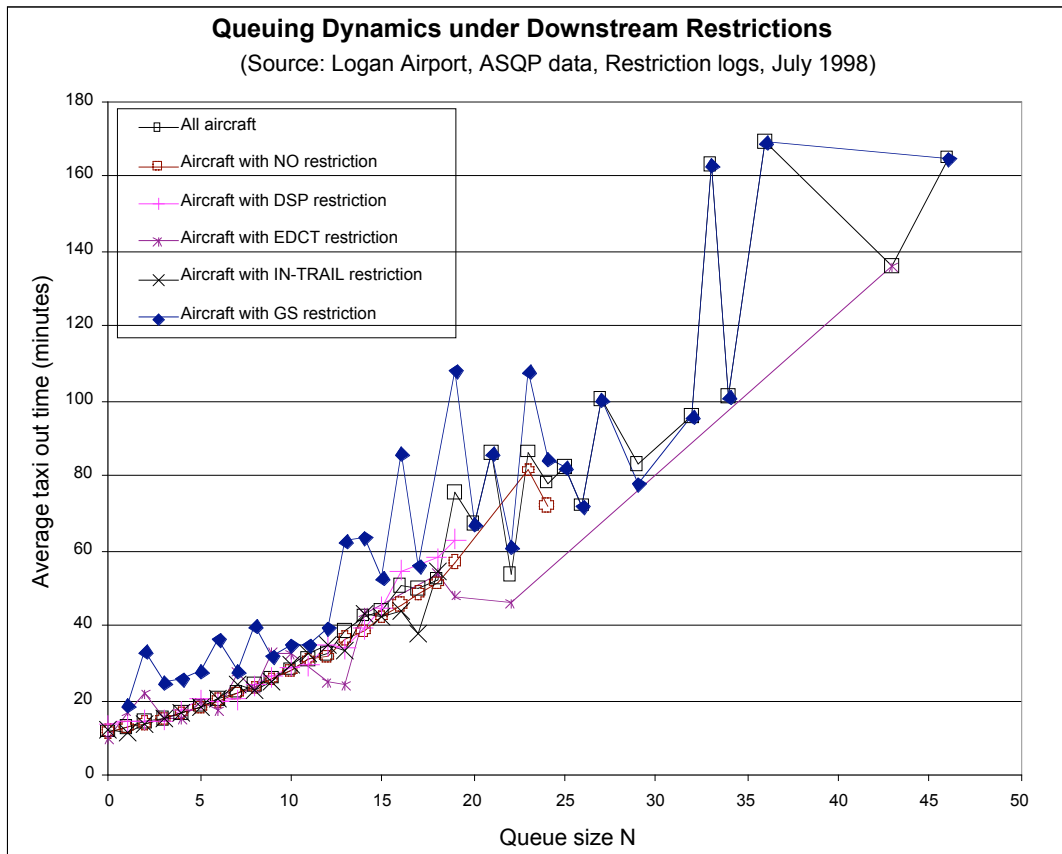

Figure 4.14: Queuing dynamics under downstream restrictions

additional holding time was often required in order to absorb delays that could not always be mitigated by proper sequencing. The average taxi out time of the aircraft that suffered GS restrictions was higher even at low queue size values, suggesting that GS restrictions (particularly Local GS as was seen in Chapter 3) affected larger numbers of aircraft that were stranded on the ground and there was not enough demand to pass these aircraft and maintain a takeoff queue at the runway.

Figure 4.15 shows graphically how it is possible to meet certain downstream restrictions (particularly non-GS type restrictions) often by a simple reallocation of departure aircraft in the takeoff sequence. If there is enough demand, it is possible to insert the appropriate number of aircraft in between and ahead of the restricted aircraft, resulting in no effect on the overall schedule, queuing behavior or throughput of the system. In order to achieve this the air traffic controller have to control the aircraft movement accurately, through sequencing and controlling the time in the system of the restricted aircraft. The control behavior under two observed downstream restriction situations, the takeoff time-window control and “splitter” sequencing, are described briefly in the context of the controlled queuing model posed in Section 4.2.

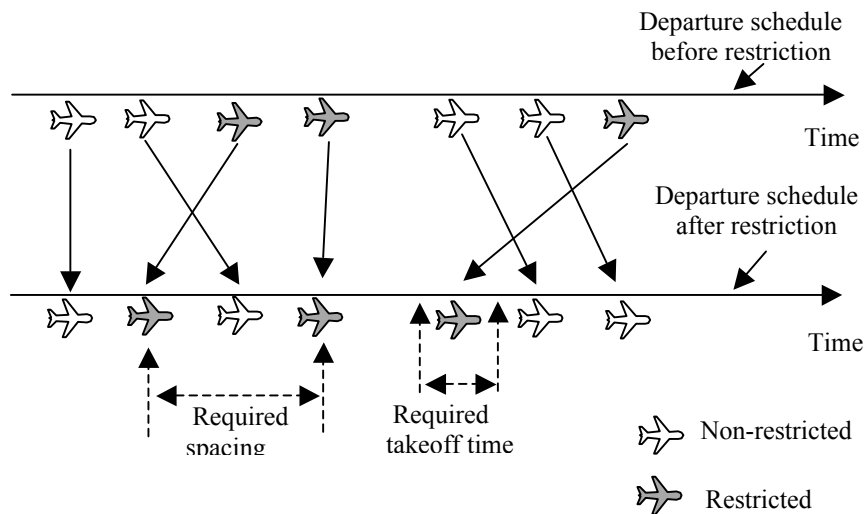

Figure 4.15: Aircraft sequencing under downstream restrictions

### 4.5.1 Takeoff time window control

The air traffic controllers are often faced with attempting to control the movement of a restricted departure aircraft such that it takes off within an assigned time window (for example DSP and EDCT). In terms of the controlled queuing model posed in this chapter, this translates into a

desired time  $D_r$  in the system for the restricted aircraft, between the current time and the assigned takeoff time. Based on the model, the air traffic controllers need to allocate the desired time in the system between effective service time  $ES = S + S_p$  and effective waiting time  $EW = W_p + W_{FCFS}$ , which they could affect through their control actions as shown in the closed loop control representation in Figure 4.16.

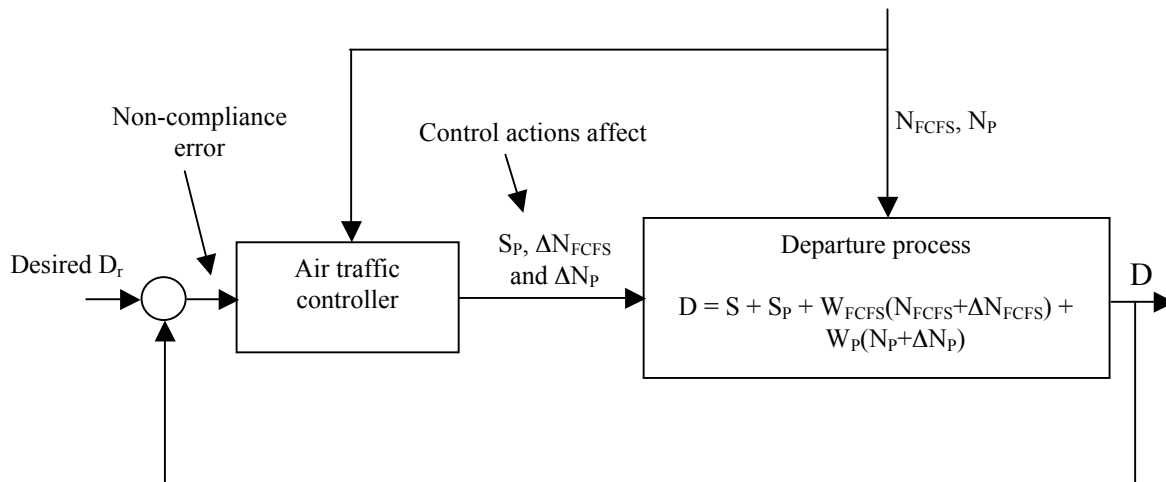

Figure 4.16: Closed-loop time window control

As mentioned in Section 4.2.3.2, the air traffic controllers can affect the effective service time ( $S + S_p$ ) of the restricted aircraft, mainly by holding the clearances for the procedural time ( $S_p$ ). (They may possibly be able to affect  $S$  by asking the aircraft to slow down or speed up, although this is less effective). The time window may then be achieved through proper sequencing (as suggested in Figure 4.15) which may affect the two waiting time components  $W_{FCFS}$  and  $W_p$ . Control of the FCFS waiting time ( $W_{FCFS}$ ) is limited as it may entail holding other aircraft already ahead in the system ( $N_{FCFS}$ ) and allowing the restricted aircraft to pass them. However, to meet the desired time, more aircraft may be allowed to pass the restricted aircraft ( $N_p$ ) and be sequenced ahead, with care that the accumulated marginal waiting time caused by each does not lead to a violation of the requested time window.

### *Effect of uncertainty*

Attempting to meet a required takeoff time, especially with a small time window of three minutes as in the case of a DSP restriction, is probably the hardest control problem that the air traffic controllers face in terms of required accuracy. There is large uncertainty associated with the time that a departure aircraft spends in the system. For example, the standard deviation in the taxi out time between pushback and takeoff (as estimated by the ASQP data) is 10:21 minutes (Figure 4.10). Delcair and Pujet (Delcaire) showed that it is possible to reduce the error in estimating the taxi out time to about 5 minutes if estimated for a specific runway configuration and specific airline (general gate location). Figure 4.11 showed that the standard deviation was about 3 minutes with zero queue size and increased as a function of the queue size. It was also shown in Figure 4.13 that the standard deviation in the runway phase time, between handoff to the Local controller and the takeoff clearance, was 3:48 minutes<sup>45</sup>. Therefore, even if the air traffic controller waited until the aircraft was about to enter the runway queue, there is still high uncertainty in predicting its takeoff time. This high uncertainty results in a large chance to miss the assigned time window<sup>46</sup>, resulting in non-compliance or forcing a call back for another time assignment (see Section 3.4.2).

Before the aircraft is on a movement area, it is even more difficult for the controllers to predict the takeoff time due to the lack of observability of the aircraft state on the gate and the high uncertainty associated with the gate operations. Figure 3.46 (in Chapter 3) showed a large variability (14 minute standard deviation) in the time between the proposed pushback time and the time the aircraft calls ready for pushback (or ready for taxi if non-jet). It would be extremely

---

<sup>45</sup> The state of information of the air traffic controller is better than what the analysis of either the ASQP or the communication data predict. For example, estimating the system time depends on the runway configuration, the gate location, the weather and airport surface conditions, which the controllers know. It also depends on the state of progress of the aircraft and any problems they encounter, which the controllers may also be able to observe and be informed about through the controller/pilot communication. Therefore, the controllers are probably able to do better predictions and control, especially after the aircraft is on a movement area under their control.

<sup>46</sup>For example, the air traffic controllers may clear a DSP restricted aircraft to enter the runway queue (monitor the tower) such that the DSP time window (of 3 minutes) is in the center of the runway phase time distribution in Figure 4.13, in order to maximize the chance of compliance. Assuming a triangular distribution, with the standard deviation of the runway phase time distribution in Figure 4.13, it can be shown that the probability to miss the time window is about 0.7.

difficult for an air traffic controller to predict the pushback time accurately based on the proposed schedule time. This explains waiting until the aircraft is on a movement area before the Traffic Management Coordinator (TMC) predicts the takeoff time and calls the Boston Center (ATRCC) asking for a DSP time assignment. Holding on the gate, which might be beneficial for airlines and for the airport congestion and environment, is precluded in such cases. On the other hand, the 15-minute time window for EDCT gives a larger margin for error.

In addition, in the absence of dedicated penalty boxes at the runway end, the entry into the takeoff queue is the last control point that dictates the sequence of the aircraft in the takeoff queue. After this point the aircraft is in a single queue, single runway system (as was observed in Figure 3.13). Any holding of the aircraft then causes blocking of the runway and loss of efficiency. Therefore, dedicated penalty boxes next to the runway ends (such as the taxiway segments  $N_1$ ,  $N_2$  and  $N_3$  near the end of runway 22R, see Figure 3.8) ensure better compliance and higher efficiency.

#### **4.5.2 The “Splitter” sequencing problem**

As shown in Figure 4.15, the spacing type restriction (Miles or Minutes in Trail) may be achieved by inserting a number of departure aircraft in between in the takeoff sequence such that the accumulated marginal time due to each makes up the required time spacing. The inserted aircraft is commonly known as a “splitter.” Knowledge of the marginal taxi out time (the slope of the taxi out versus queue size curve) due to each aircraft sequenced ahead in the queue is, therefore, critical for ensuring the required time spacing.

The uncertainties described in the time window implementation in the previous section also hinder the ability to implement the in-trail requirement. However, usually the in-trail spacing is required between the aircraft as they pass over a downstream fix. Therefore, as observed at Logan Airport, the spacing requirement is less critical than the time window requirement since it can be established in the air after takeoff. In order to achieve higher efficiency by avoiding holding aircraft in the takeoff queue, the Control Tower may coordinate with the TRACON to ensure that the required in-trail spacing is achieved after takeoff.

# CHAPTER 5

## CONCLUSIONS AND IMPLICATIONS

The main insights about the departure process, gained through the observations and analysis at Boston Logan International Airport, are summarized in this chapter. Then some implications are drawn regarding possible improvement to the departure process performance, both in general and through Departure Planner methods in particular.

### **5.1 Summary of observations and results**

Based on the field observations at Boston Logan International Airport and the associated analysis, the main observations about the departure process dynamics and the departure flow constraints are summarized below.

#### **5.1.1 Interactive queuing system**

The airport departure process was identified as an interactive queuing system consisting of a complex network of aircraft queues. The queuing network was identified at high level of detail, associating aircraft queues with the main resources of the airport system and the main operational phases of the departure process (see Figure 3.8). While the queuing network depends on the runway configuration, an underlying structure that consists of a number of key queue types and queue interactions that are common under different runway configurations, was identified (see Figure 3.9). Namely, under most runway configurations, departure aircraft form a series of queues, starting with pre-pushback queues on the gates, then ramp queues, taxi queues and runway queues (for runway crossing if needed and then for takeoff).

Unlike the aircraft flow in the airspace where the arrival and departure paths are separated procedurally, arrival and departure aircraft share and compete for the same resources on the

airport surface. Therefore, heavy interactions between the arrival and departure flows were also identified in the aircraft queuing networks, where the main arrival queues are landing queues, runway crossing queues, taxi queues and notably, ramp queues waiting for occupied gates.

### **5.1.2 Queuing system with controlled blocking**

resources are under the control of different It was also observed that the departure process is a highly controlled queuing system. First at the strategic level, the Control Tower attempts to match the capacity of the airport system to the demand through a runway configuration selection process, given weather constraints and (particularly important at Logan Airport) noise abatement constraints. Then at the tactical level, the air traffic controllers control the aircraft movement in order to ensure the implementation of the ATC procedural requirements and to regulate the flow between the interconnected queues and resources of the airport system.

Because the airport queues have finite buffer space capacity, the departure process was abstracted as a queuing system with blocking, where when a downstream resource is saturated and its buffer space becomes full, the flow outbound of an upstream resource is blocked (see Figure 3.14). The air traffic controllers, who dictate the aircraft movement on the airport surface, control the blocking mechanism given the proper feedback about the level of traffic at downstream resources. Therefore, the core departure process was identified as a queuing system with controlled blocking. Namely, in general, the air traffic controllers regulate the flow of aircraft outbound from the resources under their control in order to satisfy procedural requirements such as runway and wake vortex separations, assure acceptable levels of traffic at downstream locations and avoid overloading downstream controllers. The controlled blocking is achieved mainly through the ATC clearance, which is identified as the basic control mechanism, required by every aircraft to use every airport resource under ATC control. Complementary control actions such as sequencing, routing and suspension of aircraft were also observed and are used by the controllers as needed and when possible. Feedback may be achieved directly between adjacent controllers or between different flow management units when the interacting air traffic control facilities.



### **5.1.3 Identification of major departure flow constraints**

The main flow constraints in the departure process were identified with the main queue formations, since the aircraft queues are a manifestation of the flow constraints.

#### **5.1.3.1 Flow constraints manifest mainly at the runway**

It was observed that the flow constraints in the departure process manifest mainly at the runway system where aircraft repeatedly formed the longest queues and incurred the largest delays at the departure runways, (as observed during field observations at Logan Airport). An analysis of eight hours of controller/pilot communications, demonstrated that aircraft spent an average time in the runway phase (between the handoff to the Local controller and the takeoff clearance) that is more than twice as large as the average time spent in any of the preceding departure phases (the pre-pushback, ramp and taxi phases, between the pilot call ready for pushback, the pushback clearance, the taxi clearance and the handoff to the Local controller, respectively). Pilot ACARS delay reports, of one major airline at four major airports, also showed that aircraft incurred 60 to 70 percent of their delays in the takeoff queues, waiting for other flights landing and departing.

A number of causal factors that limit the departure rate capacity of the runway system were identified and demonstrated through analysis of controller/pilot communications collected during field observations at Logan Airport. The main causes were attributed to procedural constraints such as ensuring runway and wake vortex separations, runway sharing by arrival aircraft (landing on the same or dependent runways), crossing of the departure runways by taxiing aircraft, and controller sequencing strategies and workload limitations. At Logan Airport noise is also a major cause of limiting the runway departure rate capacity, imposing restrictions on the utilization of certain runways and forcing aircraft (particularly jet aircraft) to follow the same departure paths rather than allowing path divergence (in which case the separation requirements are smaller).

### **5.1.3.2 Downstream restrictions**

Downstream flow constraints, such as flow restrictions at exit fixes, in en route air space and at destination airports, were identified as one of the main causes of the delays incurred on the airport surface. The departure process was analyzed under downstream restrictions in the month of July 1998 at Logan Airport. It was shown that downstream restrictions at destination airports caused delays to isolated aircraft heading to the restricted destinations, however, without a significant effect on the departure runway throughput. On the other hand, local Ground Stop restrictions (which restrict the outbound flow through exit fixes from the airport due to local weather) caused a significant reduction in the departure runway throughput, as well as caused significant delays. Excessive taxi out times were observed due to downstream restrictions, especially Ground Stops, which caused an average 45 minute taxi out time in July 1998 (Figure ?) compared to an average of 20 minute taxi out time under normal conditions. In addition to delays incurred during taxi out, substantial delays were absorbed prior to pushback, especially under Ground Delay programs such as EDCT and under Ground Stop restrictions.

In addition to the downstream constraints imposed through the flow management restriction programs, downstream constraints include the workload of downstream controllers. For example, certain takeoff sequencing strategies (such as alternating jets and props) were adopted in order to assist the departure controllers where such strategies may not be optimal from an efficiency point of view.

### **5.1.3.3 Flow constraint manifestation at the gates, ramp and taxiways**

Although not as substantial as at the runway system, flow constraints also manifest at the gate, ramp and taxiway resources of the airport system. According to the ACARS pilot delay reports (of one airline at four major airports including Logan) gate capacity limitations manifest mainly in the delays incurred by arrival aircraft when they find their assigned gate occupied, which is often caused by delayed departures. While most of the queuing on the ramp and taxiways is caused by waiting to cross active runways and waiting for occupied gates or access to the gates, the ramp and taxiways also cause delays due to their limited capacity. Particularly at Logan

Airport, where there is no separate ramp area and there are limited delay absorbing areas, aircraft often push back and absorb delays on segments of the taxiway system blocking these taxiway segments. The taxiway capacity is also limited at Logan Airport since the same taxiways are used by arrival and departure aircraft, as well as towed aircraft.

#### **5.1.3.4 Air traffic controllers workload**

Another major flow constraint in the departure process is the air traffic controller workload. Based on the observations in the Control Tower at Logan Airport, the controllers' workload flow constraint manifested in the formation of flight progress strip queues in the bays in front of the controllers. Two coupled parallel queuing processes were, therefore, identified: the aircraft queuing process on the airport surface and the control and communication queuing process in the control tower. While the aircraft queuing process manifested in aircraft queue formation on the airport surface, the control and communication queuing process manifested in the formation of flight progress strip queues in front of the air traffic controllers. The controllers cooperate to regulate the flow in between such that the workload level is maintained at acceptable levels.

#### **5.1.4 Identification of controller strategies**

A number of air traffic control strategies were identified both at the strategic runway configuration level and at the tactical aircraft movement control level. At the strategic level the runway configuration is selected dynamically to match the arrival and departure demand within the constraints of weather and noise abatement. A certain pattern was identified in the runway configuration selection process where high capacity configurations were used during high demand hours, while more moderate and low capacity configurations -that utilize noise preferred runways- were used during moderate and low demand hours, especially at night hours which are most sensitive to noise. Within a given runway configuration certain operating modes were identified where the air traffic controllers operate in modes that favor arrivals or departures depending on the demand fluctuations in the short term.

At the tactical level sequencing is normally FCFS, however, resequencing is sometimes done to meet downstream restrictions or achieve higher efficiency. The sequencing behavior was analyzed in Chapter 4 using passing as an indication of the deviation from the nominal FCFS sequence. It was observed that at Logan Airport there is a lack of sequencing behavior, in general, where an aircraft passes (and is passed by) only an average of 0.8 other aircraft. It was also observed that the sequencing ability decreases after entry into the takeoff queue. And finally, it was observed that sequencing is often used in order to mitigate the effect of certain downstream restrictions. For example, in order to achieve a required takeoff time or a required in-trail spacing between takeoffs, an appropriate number of takeoffs can be inserted ahead of or in between the restricted departures. (Care must be taken in such cases so that the accumulated marginal waiting time due to each aircraft inserted ahead or in between does not lead to non-compliance with the restriction. Sequencing strategies were also identified in mixing takeoffs with other runway operations, particularly runway crossings, in order to reduce their occupation of the departure runway.

### **5.1.5 Lack of observability and high uncertainty**

One of the main observed characteristics of the departure process is the lack of ATC observability, especially in gate operations. This lack of observability hinders the ability of the Control Tower to predict the actual departure demand, which has to be based on the, often unrealistic, proposed schedule (which had a standard deviation of 17 minutes from the time that the aircraft calls ready for pushback or taxi). The lack of observability and high uncertainty also hinders the ability of the air traffic controllers to plan the sequencing of aircraft in advance. For example, when an aircraft has a DSP restriction, which imposes a takeoff time window of 3 minutes, the Control Tower waits until the aircraft is on a movement area before estimating its takeoff time and calling the Boston Center (ARTCC) to request an approval or a different takeoff time assignment. The high uncertainty makes the task of sequencing takeoffs under restrictions such as DSP a difficult task to accomplish.

## **5.2 Implications for departure planning**

Based on the insights gained from the observations and analysis, a number of opportunities and recommendations to improve the departure operations through improved methods such as the Departure Planner, are outlined.

### **5.2.1 Demand matching at the strategic level**

At the strategic level, it is possible to improve the runway configuration management in order to match the demand. The Preferential Runway Assignment System (PRAS) is one such existing tool that suggests runway configuration changes to the Control Tower at Logan Airport based on demand, weather and noise. It was observed, however, that the Control Tower employs certain procedures to trade off arrivals and departures within a runway configuration (such as the Accelerated Departure Procedure, ADP, in the runway configuration 27/22L-22R/22L, described in Section 3.2). Using such procedures, the Control Tower selects different operating modes within a runway configuration capacity envelope in order to match short-term fluctuations in the demand. Such procedures are exercised currently in a reactive manner in order to reduce congestion and delays after their occurrence. A more proactive approach could be accomplished through predictive and assisting tools.

### **5.2.2 Environmental impact through reduced taxi out time**

Excessive taxi out times were observed both under normal conditions and under downstream restrictions. Such long taxi out times have a detrimental environmental impact in terms of noise and emissions when the aircraft engines are running. In addition long queues of departure aircraft often formed on the airport surface. It was observed (for example Shumsky) that the runway system reaches a maximum departure throughput at a queue size that is much smaller than the actual number of aircraft that queues at the runway and taxis out. Therefore, it should be possible to regulate the departure flow in order to minimize the taxi out time and reduce the

takeoff queue size without an effect on the departure throughput. For example, Pujet analyzed such a method (an N-control policy), which suggests to control the number of aircraft taxiing out (N) to a level that achieves a maximum runway throughput. Such an N control strategy for departure operations is simple to implement and would achieve substantial environmental benefits. The implementation of such a strategy requires that gate capacity exists at the airport such that it does not create congestion at the gates (which are already a significant source of delay to arrival aircraft that find their gates occupied). It should also be possible to achieve environmental benefits by controlling the engine start time, which is not currently controlled actively by the air traffic controllers.

### **5.2.3 Improved runway operation efficiency**

Through experience, the air traffic controllers become very skillful at achieving efficient runway operations within the safety constraints imposed by the runway and wake vortex separations and their workload. Therefore, it is unlikely to significantly increase the runway capacity except through adding new runways (or extending existing ones) or through technological advances that may reduce the separation requirements. However, the observations and analysis in this thesis pointed to a number of issues that may provide an opportunity to improve the runway efficiency or at least should be taken into consideration in improved methods for runway operations:

- Runway crossing by taxiing aircraft was observed as a major constraining factor to the runway operations, particularly crossing a departure runway by arrival aircraft that have priority. Some of the strategies that the air traffic controllers adopted to reduce the effect of runway crossings should be taken into consideration in improved runway operation methods.
- Certain sequencing strategies that the air traffic controllers adopt are limited by workload, and therefore, may not be optimal from an efficiency point of view (for example, alternating exit fixes or departure routes to assist the departure controllers). Therefore, improved methods, such as automation tools, may reduce the controllers' workload and allow them to use more efficient sequencing strategies, or assist them in suggesting more optimal sequences when feasible (such as minimizing the occurrence of larger separations).

- It was observed that the ability to sequence departure aircraft for takeoff decreases, as the aircraft become closer to the departure runway. (This is particularly true at constrained airports such as Logan, where there is often a single departure runway with a single takeoff queue and with no penalty boxes at its end). Therefore, the air traffic controllers prior to the Local controller (the Gate and Ground controllers) influence the takeoff sequence, while they may not be aware of the takeoff queue condition and optimal requirements. They often use FCFS or common sequencing strategies, which may not be optimal. Therefore, assisting tools may provide more timely and optimal sequencing cues, starting from the pushback, based on a more global view of the system real-time conditions and future requirements, and improving the link between the different air traffic controllers.
- Managing the runway operations under the effect of downstream restrictions should be given attention in order to avoid loss of efficiency as described next.

#### **5.2.4 Improved downstream restriction management**

One of the main drivers of the air traffic controllers' strategies is the downstream restrictions. Based on the observations at Logan Airport, there are opportunities in situations of downstream restrictions to manage the departure flow in order to improve compliance with the restrictions and avoid loss of efficiency.

- For example, under takeoff spacing restrictions (Miles in Trail or Minutes in Trail) or takeoff time restrictions (EDCT or DSP), the restricted aircraft need to be inserted in the appropriate order in the takeoff queue in order to meet the restriction. Based on the queuing models developed in Chapter 4, one determinant of the appropriate sequence position in the takeoff queue is the average accumulated waiting time due to each takeoff sequenced ahead of or in between the restricted takeoffs. Therefore, Departure Planning tools may incorporate decision aiding to the air traffic controllers about the appropriate takeoff order of restricted aircraft based on queuing models that predict of wheels off times accurately. Such tools should avoid early insertion in the takeoff queue, which may result in runway blocking and loss of efficiency, and avoid late insertion in the takeoff queue, which may result in non compliance

with the restriction or a call back for another takeoff time assignment causing unnecessary delays.

- Certain downstream restrictions, such as the takeoff time restrictions (EDCT and DSP) require that restricted aircraft be at the runway within a specific time window. In such situations, time control of the restricted aircraft is required in addition to the sequence. Departure planning tools may need to incorporate such tactically accurate time control mechanisms, at least for the restricted aircraft. The time control of aircraft is highly tactical and may be achieved through the timely delivery of the ATC clearances in addition to proper sequencing. (Such time control approaches may also assist in coordinating the takeoffs with landings and runway crossings, where aircraft may be required to be at the runway at specific times in order to meet a precious takeoff time slot in the landing stream, for example).
- Improved departure methods may also focus attention on alleviating the impact of the local Ground Stop restrictions, which were observed to have a significant impact of the departure throughput. More proactive procedures to reroute the departure traffic around weather impacted jet routes or local departure fixes would have significant benefits.

### **5.2.5 Improved gate operation management**

While gains in system efficiency may be achieved through better management of runway operations and downstream restrictions, the gate resources are an integral part of the airport system and may become a major flow constraint. Reducing the queue size and delays at the runway and on the taxiways would simply transfer the delays to the gates. If gate capacity is not available or if the gate operation management is not versatile to accommodate additional delays, the delays would easily be transferred to arrival aircraft that find the gates occupied or unavailable (which is already a major delay cause). Therefore, in order for improved methods of the departure operations to be beneficial, it should take into account the gate capacity and operations. Based on the observations in this thesis, gate operations should be more flexible in exchanging gates between flights and between airlines and more robust in accommodating disruptions in the schedule (due for example to weather and downstream restrictions). Also



better communication between the airline gate stations and the Control Tower is needed to better predict, anticipate and plan for any disruptions.

## **5.2.6 Improved efficiency through better information**

One of the main obstacles in the departure process management is the lack of ATC observability, especially in gate operations. Therefore, Departure Planning tools may improve the departure process performance through improved information sharing between the airlines and the ATC system, and between the different ATC facilities. (Extensive research is being conducted in the Collaborative Decision Making (CDM) approach (for example, Hall), which attempts to coordinate between the airlines and the ATC system).

Information sharing with the airlines would improve:

- The ability of the Control Tower to estimate the departure demand. For example, knowledge about cancellations and delays in gate operations improves the estimation of the number of departure aircraft, which will be ready for pushback in the next time period (which is now based on the inaccurate proposed schedule). This helps the Control Tower in planning runway configurations and operating modes in order to match the airport capacity to the demand.
- The ability of the air traffic controllers to plan the aircraft movement and sequencing in advance in order to comply with downstream restrictions and improve efficiency. For example, currently when an aircraft is under a DSP restriction, the air traffic controllers wait until the aircraft is on a movement area before estimating its takeoff time (because of the high uncertainty beforehand) and then they request an approval or a different time assignment from the Boston Center. Knowledge about the aircraft state progress on the gate allows the Control Tower to predict its wheels-off time prior to pushback, call for its restricted takeoff time and plan its sequence well in advance, improving compliance with the restriction.

Also better information sharing and cooperation between the different ATC facilities would achieve (among other things):

- Timely application and removal of the restrictions such that system safety and efficiency are optimized.
- Proactive use of alternative measures, such as rerouting of aircraft to avoid weather impacted airspace, in a way that preserves efficiency as much as possible.
- Coordinating the implementation of certain restrictions, such as in-trail spacing, between adjacent facilities in a way that preserves efficiency as much as possible.

### **5.2.7 Improved controller workload**

One of the main goals of automation and assisting systems such as the Departure Planner should be to improve the workload level of the air traffic controllers. The high controller workload was observed as one major constraint to the flow as well as to the safety of the traffic, particularly in the highly stressful Control Tower environment. There are currently plans at Boston Logan Control Tower to add a second Ground Control position to reduce the workload level, so there are certainly opportunities for assisting automation tools such as the Departure Planner in this regard. Even if such tools automated some of the routine communications between the air traffic controllers and the pilots, for example, it would be a great benefit. By relieving some of the workload, these tools would allow the air traffic controllers to better use their experience in the tactical control of the traffic, maintaining safety and improving efficiency probably in ways that are difficult to match by automation system.

### **5.2.8 Integrated system of automation tools**

One of the main insights gained in this thesis is the interactive nature of the departure process and the Air Traffic Control system in general. One cannot separate the runway operation management under wake vortex separations, from the effect of the downstream restrictions, from the complex and unobservable gate operations. Similarly, the Departure Planner should not consist of standalone tools that deal with each aspect separately without interaction, which is one

of the main obstacles in today's automation tools. Rather, automation and assisting tools should be integrated, whether in a central or a distributed fashion, in order to be beneficial. Tools that deal with the departure process should also be integrated with tools that deal with the other elements of the airport system and the National Airspace System.

Finally, it should also be noted that the insights gained in this thesis were based on observations at Boston Logan International Airport. Although Logan is a major constrained airport, efforts should be extended to other airports in order to capture other essential elements and issues that did not manifest at Logan Airport, such as hub operations and multi-runway systems.

## Appendix A

The flight progress strip is a paper printout (Figure A.1), which contains the following information about the aircraft (FAA, BOS TWR 7110.11H):

1. USS6121	4. 5211	7. 4L	8. BOS GLYDE BAF V292 V213 SAX EWR		12	9
2. T/B727/A	5. P2100				14	10
3. 231	6. 120			13	11	

Figure A.1: The flight progress strip

1. Aircraft callsign
2. Aircraft type and class
3. Aircraft identification number
4. Beacon code
5. Aircraft scheduled or proposed push time (OAG)
6. Aircraft assigned altitude (100's of feet)
7. Aircraft runway assignment / initial heading assignment (written by controller)
8. Aircraft flight plan
9. Aircraft call ready time (written by controller when pilot calls ready)
10. Aircraft expected pushback time (written by controller)
11. Aircraft takeoff time (written by controller)
12. Aircraft EDCT (Expected Departure Clearance Time) time (if any)
13. Aircraft DSP (Departure Sequencing Program) wheels off time
14. ATIS code

The controllers use the flight progress strip to keep track of the aircraft progress and to indicate any changes in the flight plan of the aircraft using hand written signs. Examples of these are (according to the SOP and observations)

- Underlining any restricted part of the flight plan by a red pencil

- Wake vortex separation waiving (for a small behind large from intersection only) with a W in a red circle
- New altitude assignment and new route assignments
- A bar to indicate that the aircraft was cleared into position and held
- The word LAST to indicate that the aircraft is the last to takeoff on a runway (in a runway configuration change)
- Check marks to indicate the accomplishment of certain tasks

## Appendix B

### *Aircraft queues under the 4R/4L-9/4R/4L runway configuration*

Figure B.1 shows the queuing network under the runway configuration 4R/4L-9/4R/4L. The same color codes are used for the identified queues as in Figure 3.8 for the 27/22L-22R runway configuration. Aircraft land on runways 4R and 4L under the control of the Local East and the Local West controllers respectively, (primarily, jets land on runway 4R and props land on runway 4L due to noise abatement rules). Aircraft landing on runway 4R form runway crossing queues to cross runway 4L. Once crossed all arrivals taxi to the ramp under the control of the Ground controller in a similar fashion to the 27/22L-22R runway configuration. Departures start and taxi also in a similar fashion to the 27/22L-22R runway configuration under the control of the Ground controller. Then they form multiple takeoff queues on runways 9, 4R and 4L depending on their runway assignment. Most aircraft are assigned to the primary departure runway 9 and these departures form runway-crossing queues to cross runway 4L. Some departures request the long runway 4R. Both departures on runways 9 and 4R are under the control of the Local East controller who has to coordinate landings and takeoffs. Some props (heading north and west) are assigned to runway 4L and takeoff under the control of the Local West controller who is in charge of runway 4L only.

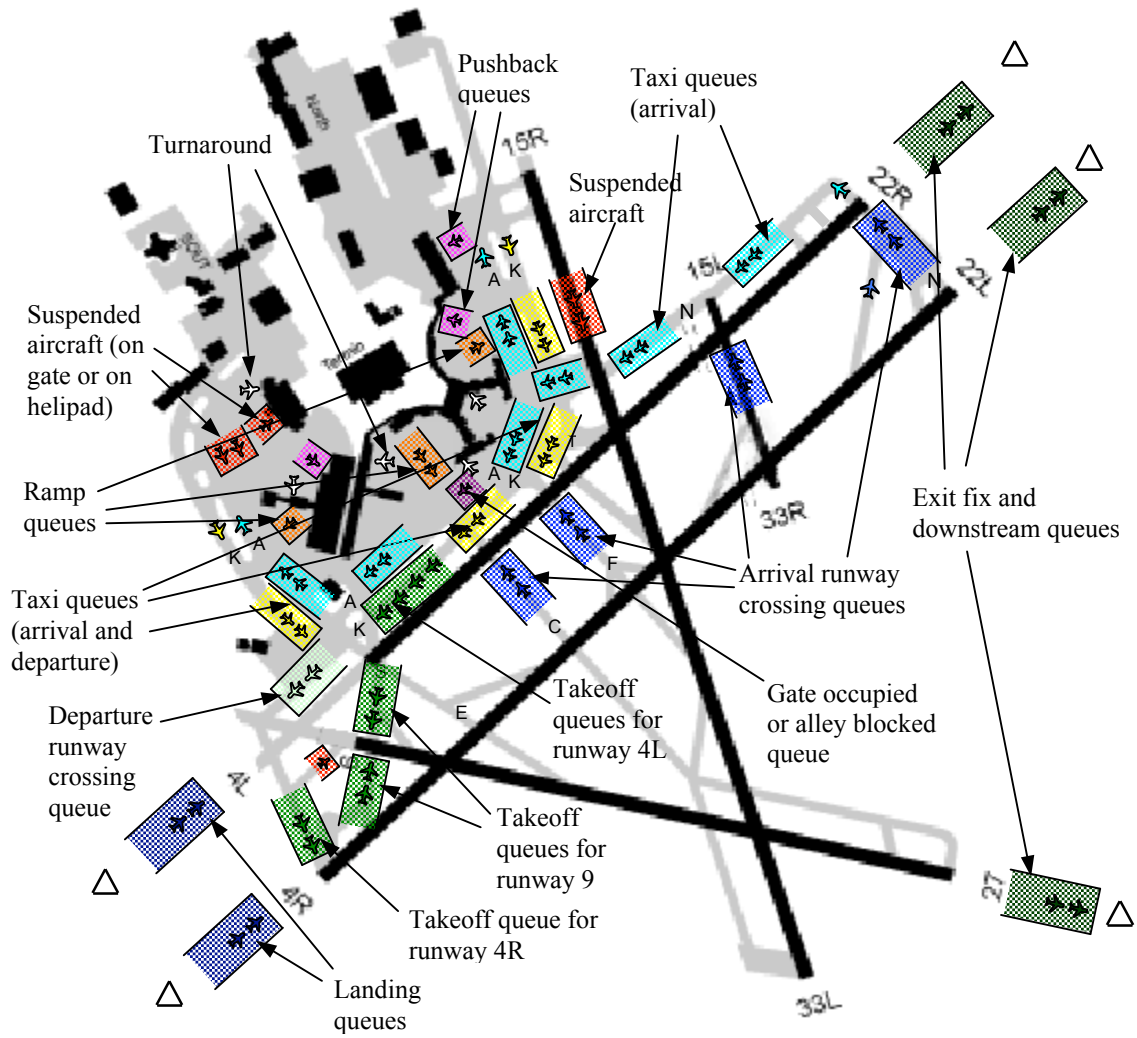

Figure B.1: Aircraft queues under the 4L/4R-9/4R/4L runway configuration

## References

- Allen, D.L., Haraldsdottir, A., Lawler, R.W., Pirotte, K. and Schwab, R.W., The Economic Evaluation of CNS/ATM Transition, CNS/ATM Projects, Boeing Commercial Airplane Group.
- Anagnostakis, I., Idris, H.R., Clarke, J-P., Feron E., Hansman R.J., Odoni, A., Hall, W.D., [2000] A Conceptual Design of a Departure Planner Decision Aid, presented at the 3<sup>rd</sup> USA/Europe air traffic management R&D seminar, Naples, Italy, 13<sup>rd</sup> - 16<sup>th</sup> June 2000.
- Andersson, K. [2000] Potential Benefits of Information Sharing During the Arrival Process at Hub Airports, SM. Thesis Operations Research Center, MIT, Cambridge, MA.
- Andersson, K., Carr, F., Feron, E. and Hall, W.D. [2000] Analysis and Modeling of Ground Operations at Hub Airports, presented at the 3<sup>rd</sup> USA/Europe air traffic management R&D seminar, Naples, Italy, 13<sup>rd</sup> - 16<sup>th</sup> June 2000.
- Andretta, G., Brunetta, L., Odoni, A.R., Righi, L., Stamatopoulos, M.A. and Zografos, G. [2000] A Set of Approximate and Compatible Models for Airport Strategic Planning on Airside and on Landside, presented at the 2<sup>nd</sup> USA/Europe air traffic management R&D seminar, Orlando, 1<sup>st</sup> - 4<sup>th</sup> December 1998.
- Barrett, C., Murphy, J., Lewis, S. Drazen, M., Pearson, L., Odoni, A.R. and Hoffman, W. Peak Pricing as it Might Apply to Boston Logan International Airport, in Transportation Research Record 1461, 15-23.
- Böhme, D., Airport Capacity Enhancement by Planning of Optimal Runway Occupancies. Proceeding of the 39. Internationales Wissenschaftliches Kolloquium der TU Ilmenau. Volume 3, pp. 250-256, ISSN 0943-7207
- Böhme, D. [1994] Improved Airport Surface Traffic Management by Planning, Problems, Concepts and a Solution – TARMAC. H. Winter (Ed.): Advanced Technologies for Air Traffic Flow Management. DLR – Seminar Series, Bonn, Germany, April 1994, in Lecture Notes in Control and Information Sciences, Springer Verlag, ISBN 3540198954
- Carr, F. [2000] Stochastic Modeling and Control of Airport Surface Traffic, SM. Thesis Electrical Engineering and Computer Science, MIT, Cambridge, MA.
- Cassandras, C.G. [1993] *Discrete event systems: modeling and performance analysis*, Irwin and Aksen, Boston, MA.
- Cooper, R.B. [1981] *Introduction to queuing theory*, Elsevier North Holland, New York.
- DeArmon, J.S. [1993] Do Air Traffic Flow Problems Interact? A Preliminary Analysis, in IEEE Transactions on Control Systems Technology, Vol. 1(3), September 1993.



- Delcaire, B. and Feron, E. (1998), *Dealing with Airport Congestion: Development of Tactical Tools for the Departure Flows from a Large Airport*, SM Thesis, Technology and Policy Program, M. I. T., Cambridge, MA.
- Dippe, D. A [1995] *The DLR Activities for Development, Test and Evaluation of a Ground Movement and Control System*, AIAA-95-3369, in proceedings of the AIAA Guidance, Navigation and Control conference, Baltimore, MD, August 1995.
- El-Taha, M. and Stidham, S.Jr. [1999] *Sample-path analysis of queuing systems*, Kluwer, Boston, MA.
- Erzberger, H. (1990), *Integrated Automation Tools for the Center and TRACON*, the Journal of ATC, Oct.-Dec. 1990, vol. 32, no.4, pp. 90-91.
- Erzberger, H., Davis T.J., Green S.M. (1993), *Design of Center -TRACON Automation System*, AGARD meeting on Machine Intelligence in Air Traffic Management, Berlin, Germany, May 11-14.
- FAA, BOS TWR 7040.1F, [1998] *Noise abatement*, U.S. DOT, FAA, Boston Control Tower.
- FAA, BOS TWR 7110.11H, *Standard Operating Procedures*, U.S. DOT, FAA, Boston Control Tower.
- FAA, Course 50115 [1995] *Traffic management coordinator specialized training student manual*, National Air Traffic Training Program, U.S. DOT.
- FAAH 7110.65L, *Air Traffic Control manual*, U.S. DOT.
- FAA 7210.3P [1998] Part 5. Traffic Management System, Chapter 17: Traffic Management National, Center and Terminal.
- Feron, E., Hansman, R.J., Odoni, A., Cots, R.B., Delcaire, B., Feng, X., Hall, W.D., Idris, H., Muharremoglou, A., Pujet, N. [1997] *The Departure Planner: A Conceptual Discussion*, Massachusetts Institute of Technology, December 1997.
- Gelenbe, E., Pujolle, G. and Nelson, J.C.C. [1987] *Introduction to queuing networks*, Wiley, New York.
- Gilbo, E.P. [1991], *Airport Capacity Estimates for Various Weather Conditions*, ATMS/ETMS Project Memorandum, Unisys Corporation and Volpe National Transportation Systems Center, Cambridge, MA.
- Gilbo, E.P. [1993], *Airport Capacity: Representation, Estimation, Optimization*, IEEE Transactions on Control Systems Technology, Vol. 1(3), pp. 144-154.

- Gilbo, E.P. [1997] Optimizing Airport Capacity Utilization in Air Traffic Flow Management Subject to Constraints at Arrival and Departure Fixes, IEEE Transactions on Control Systems Technology, Vol. 5(5), September 1997.
- Gilbo, E.P. and Howard, K.W. [2000] Collaborative Optimization of Airport Arrival and Departure Traffic Flow Management Strategies for CDM, presented at the 3<sup>rd</sup> USA/Europe air traffic management R&D seminar, Naples, Italy, 13<sup>rd</sup> - 16<sup>th</sup> June 2000.
- Gross, D. and Harris, C.M. [1998] *Fundamentals of queuing theory*, 3<sup>rd</sup> ed., Wiley, New York.
- Hall, W.D. [1999] Efficient Capacity Allocation in a Collaborative Air Transportation System, Ph.D. Thesis, Operations Research Center, MIT, Cambridge, MA.
- Hall, R.W. [1991] *Queuing methods for services and manufacturing*, Prentice Hall, New Jersey.
- Herbert, E.J. and Dietz, D.C. [1997] Modeling and Analysis of an Airport Departure Process, Journal of Aircraft, Vol. 34(1) January-February 1997.
- Hesselink, H. and Basjes, N. [1998] Mantea Departure Sequencer: Increasing Airport Capacity by Planning Optimal Sequences, 2<sup>nd</sup> USA/Europe air traffic management R&D seminar, Orlando, 1<sup>st</sup> - 4<sup>th</sup> December 1998.
- Idris, H., Anagnostakis, I., Delcaire, B., Hansman, R.J., Clarke, J-P., Feron, E., Odoni, A. [1999] Observations of Departure Processes at Logan Airport to Support the Development of Departure Planning Tools, Air Traffic Control Quarterly Journal (revised from the conference version), Special Issue in Air Traffic Management, Vol. 7, No 4, 1999.
- Idris, H., Delcaire, B., Anagnostakis, I., Hall, W.D., Hansman, R.J., Feron, E., Odoni, A. [1998] Observations of Departure Processes at Logan Airport to Support the Development of Departure Planning Tools, 2<sup>nd</sup> USA/Europe air traffic management R&D seminar, Orlando, 1<sup>st</sup> - 4<sup>th</sup> December 1998.
- Idris, H., Delcaire, B., Anagnostakis, I., Hall, W.D., Pujet, N., Feron, E., Hansman, R.J., Clarke, J-P. AND Odoni, A. [1998] Identification of Flow Constraint and Control Points in Departure Operations at Airport Systems, AIAA 98-4291, pp.947-956 in proceedings of the AIAA Guidance, Navigation and Control conference, Boston, MA, August 1998.
- Johnson C.W., Isaacson, D.R. and Lee, K.K. [1999] Expedite Departure Path (EDP) Operational Concept, NASA/A-3, August 1999.
- Kleinrock, L. [1976] *Queuing Systems*, John Wiley, New York.
- Lawson, D. [1998], *Surface Movement Advisor*, Journal of ATC, January-March, pp. 25-27.
- Onvural, R.O. and Akyildiz, I.F. [1993] *Queuing networks with finite capacity*, Elsevier science publishers, Amsterdam, The Netherlands.

- Perros, H.G. [1994] *Queuing networks with blocking*, Oxford University Press, New York.
- Perros, H.G. and Altiok, T. [1989] *Queuing networks with blocking*, Elsevier, Amsterdam, The Netherlands.
- Polak, F.R. [1996] Airport Modeling: Capacity Analysis of Schiphol Airport in 2015, 1<sup>st</sup> USA/Europe air traffic management R&D seminar, 1996.
- PRAS, Documentation about the Preferential Runway Advisory System provided by the Boston Control Tower.
- Pujet, N. [1999] Modeling and Control of the Departure Process of Congested Airports, Ph.D. Thesis, Aeronautics and Astronautics, MIT, Cambridge, MA.
- Pujet, N., Delcaire, B. and Feron, E. [1999], *Input-Output Modeling and Control of the Departure Process of Busy Airports*, MIT International Center for Air Transportation #ICAT-99-4
- Shumsky, R.A. [1995] Dynamic statistical models for the prediction of aircraft take-off times, Ph.D. Thesis Operations Research Center, MIT, Cambridge, MA.
- Shumsky, R.A. [1997] Real-Time Forecasts of Aircraft Departure Queues, Air Traffic Control Quarterly, Vol. 5(4):281–308, 1997.
- Simpson, R.W. [1994] *Air Traffic Control*, lecture notes, MIT, Cambridge, MA.
- Stamatopoulos, M. A., Zografos, K. G. and Odoni, A.R (1997), *An Analytical Model for Runway System Capacity Analysis*, in proceedings of IFAC International Transportation Symposium, Chanea, Greece.
- Shubert, M. [1996] Terminal Arrival and Departure Management within the Area, AIAA 96-3720, in proceedings of the AIAA Guidance, Navigation and Control Conference, San Diego, CA, July 29-31, 1996.
- Venkatakrishnan, C. S., Barnett, A. and Odoni, A.R. [1993], *Landing Time Intervals and Aircraft Sequencing in a Major Terminal Area*, Transportation Science, 27, pp. 211-227
- Völckers, U., Böhme, D. [1997] Dynamic Control of Ground Movements: State-of-the-Art Review and Perspectives, AGARD-R-825, 1997.
- Völckers, U., Brokof, U., Dippe, D. and Schubert, M. [1993] Contributions of DLR to Air Traffic Capacity Enhancement within a Terminal Area, AGARD meeting on ‘Machine Intelligence in Air Traffic Management’, May 1993.
- Vranas, P. [1992] *The Multi-Airport Ground Holding Problem in Air Traffic Control*, Ph.D. Thesis, Operations Research Center, M. I. T., Cambridge, MA.

*References*

Wambsganss, M. [1997] Collaborative Decision Making Through Dynamic Information Transfer, *Air Traffic Control Quarterly*, vol. 4(2) 109–125.