

The Chandelier: An Exploration in Robotic Musical Instrument Design

MICHAEL A FABIO

Bachelor of Science, Massachusetts Institute of Technology, 2004

Submitted to the program in Media Arts and Science, School of Architecture and Planning,
in partial fulfillment of the requirements for the degree of Master of Science
at the Massachusetts Institute of Technology,
June 2007

©2007 Massachusetts Institute of Technology. All Rights Reserved.

AUTHOR

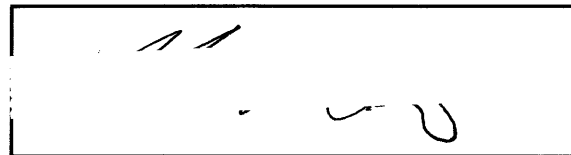

MAY 11, 2007

CERTIFIED BY

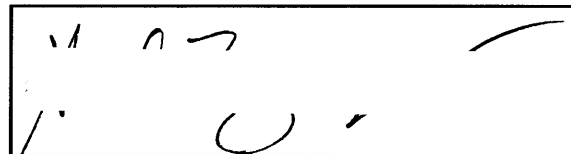

TOD MACHOVER
Professor of Music and Media
MIT Media Lab
Thesis Supervisor

ACCEPTED BY

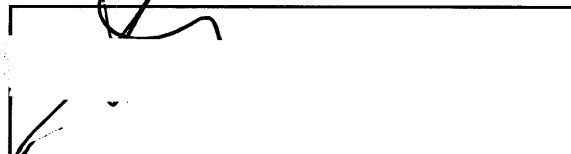

ANDREW B LIPPMAN
Chairperson, Departmental Committee on
Graduate Studies
MIT Media Lab

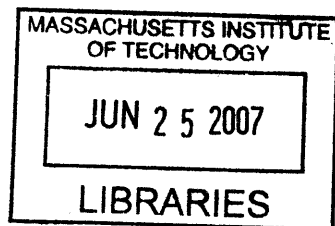

ROTCH

The Chandelier: An Exploration in Robotic Musical Instrument Design

BY
MICHAEL A FABIO

Submitted to the program in Media Arts and Science, School of Architecture and Planning
on May 11, 2007, in partial fulfillment of the requirements for the degree of Master of Science

Abstract

This thesis presents several works involving robotic musical instruments. Robots have long been used in industry for performing repetitive tasks, or jobs requiring superhuman strength. However, more recently robots have found a niche as musical instruments. The works presented here attempt to address the musicality of these instruments, their use in various settings, and the relationship of a robotic instrument to its human player in terms of mapping and translating gesture to sound. The primary project, *The Chandelier*, addresses both hardware and software issues, and builds directly from experience with two other works, *The Marshall Field's Flower Show* and *Jeux Deux*.

The Marshall Field's Flower Show is an installation for several novel musical instruments and controllers. Presented here is a controller and mapping system for a Yamaha Disklavier player piano that allows for real-time manipulation of musical variations on famous compositions. The work is presented in the context of the exhibit, but also discussed in terms of its underlying software and technology.

Jeux Deux is a concerto for hyperpiano, orchestra, and live computer graphics. The software and mapping schema for this piece are presented in this thesis as a novel method for live interaction, in which a human player duets with a computer controlled player piano. Results are presented in the context of live performance.



The Chandelier is the culmination of these past works, and presents a full-scale prototype of a new robotic instrument. This instrument explores design methodology, interaction, and the relationship—and disconnect—of a human player controlling a robotic instrument. The design of hardware and software, and some mapping schema are discussed and analyzed in terms of playability, musicality, and use in public installation and individual performance.

Finally, a proof-of-concept laser harp is presented as a low-cost alternative musical controller. This controller is easily constructed from off-the-shelf parts. It is analyzed in terms of its sensing abilities and playability.

Thesis Supervisor: Tod Machover
Title: Professor of Music and Media

The Chandelier: An Exploration in Robotic Musical Instrument Design

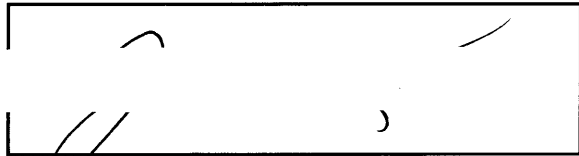
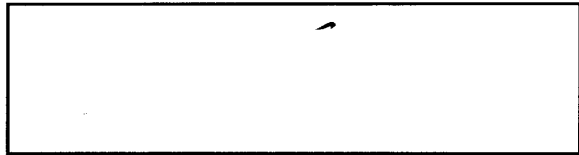
Thesis Committee

THESIS SUPERVISOR		TOD MACHOVER Professor of Music and Media MIT Media Lab
THESIS READER		JOSEPH A. PARADISO Associate Professor of Media Arts and Science MIT Media Lab
THESIS READER		CYNTHIA BREAZEAL Associate Professor of Media Arts and Science MIT Media Lab
THESIS READER		ALEX MCDOWELL Visiting Artist MIT Media Lab

Acknowledgments

THANK YOU,

to Tod, my mentor, my friend. You have inspired me, challenged me, supported me... but most importantly you have given me opportunity, and the acumen to take advantage of it.

to my readers, Joe Paradiso, Cynthia Breazeal, and Alex McDowell, who have guided me through this.

to Brian Demers and Lucas Hernandez-Mena, without whom *The Chandelier* would never exist.

to my extended Media Lab family, my colleagues and cohorts: Rob Aimi, Adam Boulanger, Marc Downie, Mary Farbood, Graham Grindlay, Tristan Jehan, Jihyon Kim, Nick Knouf, Craig Lewiston, Anita Lillie, Egon Pasztor, Steve Pliam, David Sachs, Hugo Solís, Gili Weinberg, Diana Young.

to the Toy Symphony crew, for showing me what life could be: Laird Nolan, Ariane Martins, Peter Colao.

to Ed Hammond, for bringing me along one day.

to Claire, for supporting me, despite me.

to my parents, for never giving up. I owe it all to you.

Table of Contents

Introduction.....9

1 — A History of Robots in Music..... 13

PLEASE DON'T SHOOT THE PIANIST HE IS DOING HIS BEST..... 16

Punched cards and player piano mechanics, 16; Mass production and the player as a delivery medium, 19; The phonograph and the death-knell of the player piano, 21

George Antheil..... 23

Antheil's early life, 23; The *Ballet mécanique*, 25; Performing *Ballet mécanique* again, for the first time, 30; In the wake of groundbreak, 32

Conlon Nancarrow..... 33

Early career, 33; Nancarrow's pianos, 36; The studies for player piano, 37

Trimpin..... 39

First impressions on meeting Trimpin, 40; The work of a genius, 44

The New Pioneers.....48

League of Electronic Musical Urban Robots, 49; Ensemble Robot, 50; Gil Weinberg's *Haile*, 50; Toyota's trumpet playing robots and marching band, 51; Other robots, 52

2 — The Marshall Field's Flower Show.. 53

Project Overview.....53

Variations on a Theme: Designing Interactive Disklavier Applications for Public Installation.....57

The Disklavier, 57; The Mercurial STC-1000 Touchpad, 60; Creating a display for the installation, 61; Getting from here to there: The interactive software, 62; A first attempt, 65; A second attempt, 67; A third attempt, 70; The final version, 71; A look at the software, 73

The Big Show: Observations and Thoughts.....74

The museum quandary, 74; Dealing with musical literacy, 75; A disclaimer, 77

3 — *Jeux Deux*.....78

Playing with Machines/Machines that Play: How a Computer Understands and Generates Music.....	79
Audio analysis, 79; MIDI and the Disklavier, 81; Keeping score, 81; Turning music into music, 82	
Tea for Two, Part Two: The Design of <i>Jeux Deux</i>	83
The compositional process, 83; The hardware, 84; The software, 86	
Modalities and Processes.....	89
MIDI sequence triggering, 89; “The Wall” transposition, 89; Texture blob 1 - Gaussian improvisation, 91; Sequence triggering, again, 93; Texture blob 2 - drop in a bucket, 94; Playthrough, 94; Texture blob 3 - swirling polyrhythms, 96; The knob-blob, 96	
Designing for Limitations.....	97
The polyphony problem, 97; The hammer-fall problem, 99	
Live in Concert: Performing <i>Jeux Deux</i>	100
World Premiere: Symphony Hall in Boston, 100; McGovern Institute for Brain Research, 101; Boston Music Awards at the Avalon, Boston, 101; Casa da Musica, Porto, Portugal, 102	

4 — *The Chandelier*..... 103

<i>Death and the Powers</i> : A Robotic Opera.....	103
Designing the Physical Structure of <i>The Chandelier</i>	106
From the Ground Up: The Electromonochord.....	112
A quick aside: A trip to the piano shop, 112; Building the electromonochord, 112; Testing strings, 114; Actuator tests: vibrational systems, 116; Actuator tests: Electromagnets, 118; Actuator tests: Rosin wheels, 120; Actuator tests: Weedwackers, 121; Actuator tests: Hammers, 122; Actuator tests: Pluckers, 123; What to make of the results, 124	
<i>The Chandelier</i> : A Full-Scale Prototype.....	125
Designing and building the instrument body, 125; The tuning board, 128; The pickup bar, 129; Stringing the instrument, 129; The actuator mounting boards, 129; Actuators: Electromagnets, 130; Actuators: Rosin wheels, 131; Actuators: Weedwackers, 132; Actuators: Hammers, 133; Unfinished actuators: Rapid pluckers, 133; Control electronics, 134; Controlling <i>The Chandelier</i> : A simple keyboard mapping, 137	
Playing <i>The Chandelier</i> in Installation and the Laboratory....	138
Library Music: An Installation, 139; The question of pitch, 142; Up close and personal: Individual testing, 143	
Future Work and Other Thoughts.....	144
Rebuilding the electronics, 144; New actuators, 146; Dampers, 146; The final design, 147	

5 — Laser Harp..... 148

Designing and Building the Laser Harp..... 149

Playing the Laser Harp.....154

Some synthesizer mappings, 154; Playing *The Chandelier*,
156

Future Work.....157

Laser visibility, 157; Distance sensing, 158; More strings,
160

Conclusion.....161

The future of robotic musical instruments, 161; Onward
ho, 162

List of Figures..... 165

Reader Bios.....168

Bibliography..... 169

And there, in 1902, the tangible essence of the programmed republic 2,289 years and all the civilized West in the making, lay waiting execution in the century ahead. Analysis, measurement, prediction and control, the elimination of failure through programmed organization, the player emerged as a distillation of the goals that had surrounded its gestation in an orgy of fragmented talents seeking after the useful, Rockefeller organizing this world as Darwin the last one and Mrs. Eddy the next, Pullman organizing people and Spies labor, Eastman and McCormick patents and parts, Woolworth cash and Morgan credit, Frick power with his own property and Insull with other people's, Gibbs physics, Comstock vice, and Hollerith the census, while Spencer programmed ethics and Freud the psyche, Taylor work, Dewey facts, James things, Mendel, Correns, Tschermak and De Vries and De Vries, Tschermak and Correns heredity, a frenzied search for just those patterns in communication and control that were even then not only transporting Frank Woolworth's damaged musical faculty "hatless, dishevelled and gay" in Ride of Walküres to the mighty Hall of old Walhalla, but carrying all the people rather than the patrician classes toward the utopian equilibrium of John Stuart Mills's stationary state, where the stream of human industry will "finally spread itself out into an apparently stagnant sea."

— William Gaddis, "Agapē Agape: The Secret History of the Player Piano"

Introduction

Robots, long used in industry for performing repetitive tasks requiring superhuman strength, are now being used as a tool for musical expression. The whimsical tinkling of a music box or the cacophonous oom-pah-pah of a circus carousel organ are only a small sample of the familiar sounds of musical automata, but a new breed of musical robots, utilizing sophisticated electromechanical actuation and computerized signaling and control, are poised to begin a new era in robotic music making. Unlike music boxes or carousel organs, these new instruments are intended to be *played*.

This thesis describes several projects for robotic instruments, spanning over three years of work. Two of these works involve an off-the-shelf robotic instrument—a Yamaha Disklavier player piano—and one an entirely novel instrument called *The Chandelier*, which has been the focus of my research for the past year and a half. Along the way I will attempt to define exactly what a robotic instrument is, and I will discuss the major



Fig. 0.1: Interactive touchpads controlling Disklaviers in the Marshall Fields Flower Show

Photo by Mike Fabio

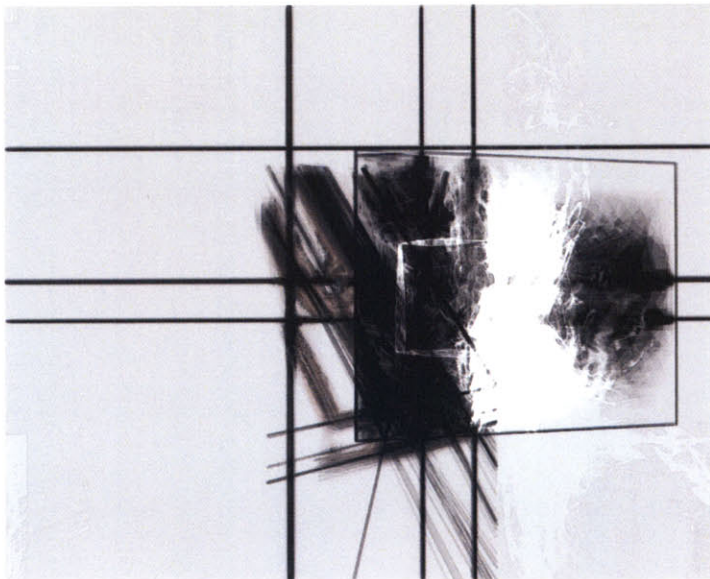

Fig. 0.2: mirror from *Imagery for Jeux Deux*, courtesy of Marc Downie

paradigms of robotic music making including sound sculpture, installation, and, briefly, robotic musicianship.

The earliest work described here is a set of touchpad interfaces designed to control player pianos as part of a public sound installation at the Marshall Fields Flower Show in March 2005. This show, installed in a flower garden built at the top floor of the Marshall Field's department store in Minneapolis, engulfed its participants in a dense fog of sound. These sounds include the aforementioned Disklaviers playing famous pieces by Stravinsky, Debussy, and Satie, a set of robotically actuated windchimes that respond to wind blowing through a pinwheel, six squeezable "shapers" that control and distort sound effects as they are squeezed, and a massively multi-channel surround sound mix with speakers placed throughout the hall. This project was a "toe dipping" experience for me, but foreshadowed my later work in mapping techniques and eventually in full blown instrument design.

Jeux Deux is a concerto for hyperpiano, orchestra, and live computer graphics by Tod Machover, with graphics by Marc Downie. The hyperpiano described in this thesis is an augmentation of a Yamaha Disklavier player piano through software. The software receives MIDI data from the piano while simultaneously sending MIDI back to the piano. This technique not only allows the player to play things that are impossible (a C in every octave of the keyboard, for example), but also allows the player to play a duet... with himself. The innovative mappings of *Jeux Deux* pose questions about human ability and the power of robotic instruments to supplement and improve those abilities.

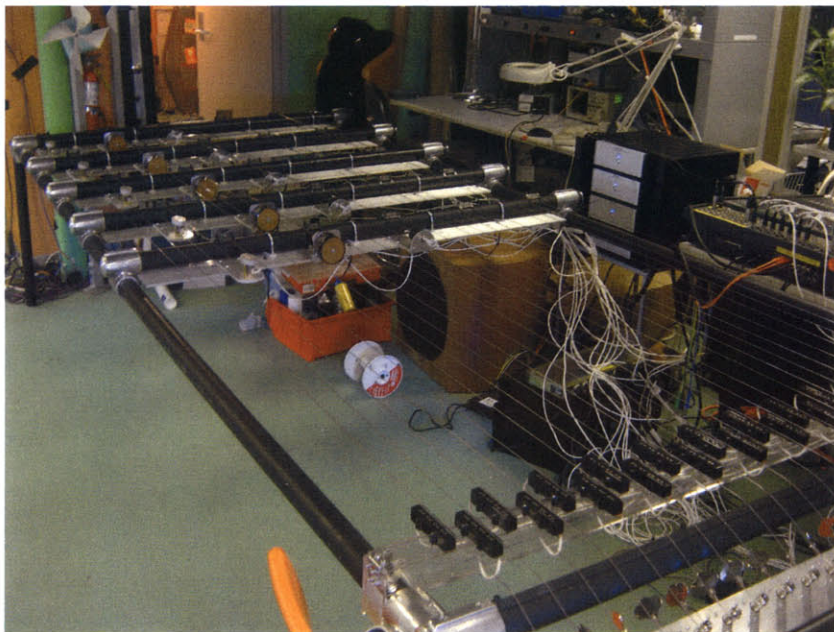

Fig. 0.3: *The Chandelier* prototype
Photo by Mike Fabio

Finally I will discuss the design of a completely new robotic instrument, *The Chandelier*. Developed for the new opera *Death and the Powers*, by Tod Machover, *The Chandelier* represents a bold step forward in robotic instruments: an instrument that, at nearly 30 feet tall, is literally larger than life. Though the instrument is now nearing the final stages of design and fabrication, the discussion here will focus on a full-scale prototype of a single piece of the instrument, a musical “wing” measuring nearly 12 feet long strung up with heavy gauge steel strings that come to life through a set of novel actuators. In addition to thorough description of the actuation methods, I will discuss the motivations behind this instrument, its place in the canon of musical robots, and I will assess its playability and musicality. This assessment will largely focus on user studies, as well as observations made while the instrument was installed at the MIT Music Library for the public to play.

11

In addition to discussion of *The Chandelier* as an instrument, I will describe a brief experiment in designing an interface based on the classic laser harp controller. This new laser harp, inspired by Leila Hasan’s *Terminova*, demonstrates a low-cost and easy to build interface that can be used for any type of electronic sound production. I will discuss some mappings designed specifically for *The Chandelier*, as well as some mappings that can be used to control synthesizers.

The first chapter of this thesis will discuss the history of robotic instruments, from the earliest records of automated organs in ancient Alexandria to innovative robots of today like Gil Weinberg’s *Haile*. In this chapter I will also expound upon several composers and inventors that are crucial in the history of these instruments, notably George Antheil, Con-

lon Nancarrow, and Trimpin. The first two of these are well established histories, both with volumes written about their work and lives. However the third, Trimpin, is a much lesser known—though, in my opinion, more important—figure who I had the pleasure to meet in January 2007. I will share my experience chatting with him as well as describe in detail several of his works.

Though the field of robotic instrument design is, by most measures, in its infancy, the field is experiencing rapid growth. Mavericks like Eric Singer and his League of Electronic Musical Urban Robots are paving the way for non-academic research, while companies like Yamaha and Toyota are seeking to bring robotic players to the market. And at universities around the world the race is on to bring robots to life, to give them music, and to allow us, as humans, to utilize their unique talents.

| 12

Robotic musical instruments have fragmented the dichotomy of player and instrument. The new paradigm raises questions of control, interaction, and the musical connection of a human and a machine. Whereas musical instruments have typically functioned as a direct extension of a musician's body, a robotic instrument is a mediated extension, controlled *through* an interface or computing device. This thesis explores the relationship—and the disconnect—present in robotic musical instruments in terms of mapping, sound production, and musicality. The barriers between performer and instrument, human and machine, are broken down and reconstructed into an entirely novel musical experience.

The field of robotic musical instruments is not new; indeed the first musical automata appeared as early as ancient Alexandria. This section explores the vast history of robotic instruments, with an in-depth discussion of three key figures: George Antheil, Conlon Nancarrow, and Trimpin.

Chapter 1 — A History of Robots in Music

McKinnon, James W. 2007. *Hydraulis*. In *Grove Music Online*, ed. L. Macy. Accessed April 9, 2007 <<http://www.grovemusic.com>>.

Hero of Alexandria. 1851. *The Pneumatics of Hero of Alexandria*. Trans. Bennett Woodcroft. Accessed April 9, 2007 <<http://www.history.rochester.edu/steam/hero/index.html>>.

In the third century BC, the inventor Ctesibius of Alexandria invented a pipe organ called the *hydraulis*. The *hydraulis* consisted of a series of pipes, much like the organ pipes of today, that are partially submerged in a vat of flowing water. The flowing water induces a drop in pressure inside the pipe, and when the pipe valve is opened using a keyboard, air flows through the pipe creating sound. The *hydraulis* is a remarkable work of engineering. It is, in fact, the first keyboard instrument. Its rudimentary set of keys represent a scale much like the keys of today's pianos. But perhaps more importantly, the *hydraulis* represents a completely new approach to musical instrument design, an instrument that *plays itself*. The limitation of the *hydraulis* was, of course, that it required a human player to input the notes. But in the first century AD, Hero of Alexandria wrote of his experiments with pneumatically powered bird whistles, modeled after the mechanism of the *hydraulis*, that could play out a presequenced piece of music. This invention set in motion over twenty centuries worth of innovation in musical automata. | 13

Discussion of early surviving barrel organs appears in
Ord-Hume, Arthur W.J.G. 1984. *Pianola: the history of the self-playing piano*.
London: George Allen & Unwin. 9.

These statistics come from the timeline that appears at the end of
Gaddis, William. 2002. *The Rush for Second Place: Essays and Occasional Writings*.
New York: Penguin Books.

The logical step after Ctesibius' *hydraulis* and Hero's singing birds is the barrel organ, a pipe organ capable of reproducing sequences of notes using a rotating barrel punched full of holes. As the barrel rotates, air is released to specific organ pipes corresponding to the holes in the barrel. Several songs were often recorded on different portions of the same barrel. Barrel organs appeared as early as the eighth century AD, with the oldest surviving barrel organ having been built around 1502 in Salzburg.

It comes as no surprise, then, that the piano, another keyboard instrument invented some 200 years later, would eventually be transformed into a self-playing automatic instrument. The earliest record of player pianos goes back as early as the eighteenth century AD, only shortly after the piano was invented. With the advent of Jacquard's loom in 1804, though, the player piano began its life as the most popular robotic instrument ever created. By 1919, player piano production outnumbered straight piano production, with some 341,652 players produced that year. To put that number in context, consider that the total number of radios sold in 1920 was only 5000 (though that number would rise to an inconceivable 2.5 million in just four years).

Several sources exist detailing the vast history of musical automata, including:

Bowers, Q. David. 1972. *Encyclopedia of Automatic Musical Instruments*. Vestal, NY: Vestal Press.

Hawley, Michael. 1993. *Structure out of Sound*. Master of Science Thesis, Massachusetts Institute of Technology.

Hocker, Jürgen. 2002. *My Soul Is In The Machine — Conlon Nancarrow — Composer For Player Piano — Precursor of Computer Music*. In *Music and Technology in the Twentieth Century*, ed. Hans-Joachim Braun, 84-96. Baltimore: The Johns Hopkins University Press.

Kapur, Ajay. 2005. *A History of Robotic Musical Instruments*. In *Proceedings of the International Computer Music Conference 2005 (ICMC 2005)*.

Ord-Hume, Arthur W.J.G. 1984. *Pianola: the history of the self-playing piano*. London: George Allen & Unwin.

Roehl, Harvey N. 1968. *Player pianos and music boxes: keys to a musical past*. Vestal, NY: Vestal Press.

There are, of course, many other sources. The sources listed above are directly referenced here.

But the *hydraulis*, barrel organ, and player piano are only a small sampling of the robotic instruments that have appeared throughout history. The Mûsà brothers developed a flute-playing robot in Baghdad in the ninth century. Leonardo da Vinci designed several self-playing drums in the fifteenth century, along with self-playing trumpets, bells, and organs. Musical clocks and music boxes have been around for hundreds of years, and master music box craftsmen from Switzerland are still recognized the world over (though most music box production today occurs in China).

In the last twenty years, as the cost of producing robots has gone down, the technology for building these new instruments has become available to hobbyists and amateur roboticists. Groups like LEMUR and Ensemble Robot have formed not only to develop these instruments, but to raise awareness among the public and performers. Despite having over 2000 years of history, robotic musical instrument development is still in its infancy. This chapter will first examine the most ubiquitous of robotic instruments, the player piano, and its impact on the music industry and society as a whole. Then I will take a closer look at three influential composers who have shaped the field of robotic instruments. The first, Conlon Nancarrow, had no intentions of changing the robotic instrument world, but his lifetime dedication to the player piano has produced a body of experimental work that is paramount to nearly all other works in the player piano canon. The second, George Antheil, a self-proclaimed “Bad Boy of Music,” had every intention of shaking up the world when he wrote his *Ballet mécanique*. And finally I will discuss Trimpin, the criminally unrecognized godfather of modern robotic instrument design and installation. I then take a look at some of the more recent developments

in robotic instrument design, and the chapter closes with some ruminations on the definition of robotic instruments, where these instruments fall into the vast spectrum of musical tools, and what this means for the average music lover.

1. _____ PLEASE DON'T SHOOT THE PIANIST HE IS DOING HIS BEST

More than any other instrument, the player piano has shaped and transformed the field of robotic musical instruments. Its monumental rise in popularity during the early twentieth century can be attributed to several key factors, including the advent of punched paper rolls as a scoring mechanism and rapid output as a result of mass production. Eventually, though, the demise of the player piano came with the invention of radio and the phonograph.

16

Punched cards and player piano mechanics

The importance of Jacquard's loom and punched card data storage can not be stressed enough, particularly with respect to computing and information theory. Indeed, the first programmable computer, designed (but never built) by Charles Babbage before his death in 1871, utilized punched cards as a method of inputting the program to be run.

By 1940, punched card data entry and storage on electronic computers had been fleshed out, as outlined in the seminal work by Wallace Eckert, *Punched Card Methods in Scientific Computation*. The most famous of the early electronic computers—the UNIVAC and the ENIAC—both used punched cards for data storage and input.

A thorough discussion of the punched card in computer research can be found in Ceruzzi, Paul E. 1998. *A History of Modern Computing*. Cambridge: MIT Press. 15-18.

In 1801, Joseph-Marie Jacquard introduced a loom that used punched paper cards to denote the order and sequence of a given weave. This technology allowed for the production of textiles with intricate patterns not feasible with older equipment. And while the invention of the Jacquard loom was a boon to the textile industry, its impact went much further: the punched card, for the first time, represented a method of storing data in a pure binary format to control a sequence of operations.

For the player piano, the invention of punched paper meant the ability to cheaply and easily store musical data in a form that a mechanical system could read. Early player pianos utilized switching barrels similar to those

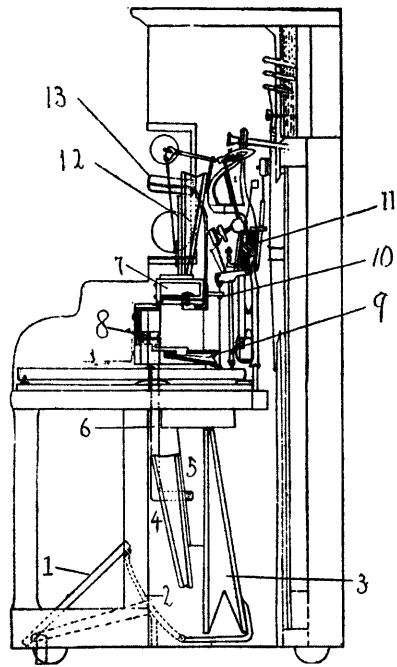

Fig. 1.1: Diagram of the pneumatic playing mechanism of a player piano

1. Pedal.
2. Pedal connection.
3. Exhauster (one only shown).
4. Reservoir; high tension (low-tension reservoir not shown.)
5. Exhaust trunk.
6. Exhaust tube to motor.
7. Air space above primary valves.
8. Secondary valves.
9. Striking pneumatic.
10. Connection from pneumatic to action of piano.
11. Piano action.
12. Pneumatic motor.
13. Trackerboard (music roll passes over trackerboard).

White, William Braid. 1909.

Public domain image accessed at Wikipedia

<http://en.wikipedia.org/wiki/Image:Pneumatic_piano.png>

Hocker, Jürgen. 2002. *My Soul Is In The Machine — Conlon Nancarrow — Composer For Player Piano — Precursor of Computer Music*. In *Music and Technology in the Twentieth Century*, ed. Hans-Joachim Braun, 84-96. Baltimore: The Johns Hopkins University Press.

found in music boxes, with tines raised out of the barrel to indicate notes and sustain. But these systems were prone to breakage, and the barrels were difficult and expensive to create. Punched cards, on the other hand, are incredibly simple to make. They can be punched by hand, or by special machines intended to record a live performance. As a live player hit a note, a mark would be made on the roll indicating the pitch and duration of the note. The paper would then be manually punched, and dynamics added to a separate portion of the roll. And although the paper rolls were prone to breakage, they were cheap enough that they could be easily replaced.

The player pianos of the early twentieth century were mostly pneumatically driven instruments. Most models were powered by bellows that were pumped using foot pedals. The paper roll passed over a *tracker tube*, a metal bar with holes corresponding to different notes. A vacuum is created in the tube, and when a hole on the roll passed over a hole on the tube, air would move through triggering a pneumatic mechanism to depress the corresponding piano key.

The simplicity of the pneumatic player mechanism unfortunately shadows its effectiveness. In his article about Conlon Nancarrow, Jürgen Hocker offers several compelling arguments advocating the abilities of early player pianos:

A player piano can play many more notes per second than a human pianist. Some pianos, like the ones produced by Ampico in the early 1900s were capable of playing up to 200 notes per second.

A player piano can play more notes at a time than a human player. Early players could reproduced over 40 notes at a time.

The abilities of the player piano to play inhuman musical structures opens a new palette of “sound clouds” to the composer. New forms and techniques are possible. Similarly, it is possible to have multiple tempos, and even multiple tempo changes at different rates.

Player pianos are capable of playing several different meters simultaneously, facilitating extremely complex rhythmic structures.

Today many of these features are amplified by the prevalence of electronic control and drive mechanisms. There are several brands of player pianos in production today, including the Yamaha Disklavier, the Bösendorfer CEUS, and the QRS/Story & Clark Pianomation system. These pianos use solenoids or servos to depress the keys and pedals. They are all compatible with standard MIDI, as well as various proprietary data formats. Some, like the Disklavier, also have speakers mounted under the piano to reproduced non-piano sounds using an onboard synthesizer.

Some inventors have taken a different approach to the player piano. In the 1890s, the first piano playing devices appeared. These large contraptions sat on the floor with mechanical fingers above the piano keyboard and mechanical feet above the pedals. Though cumbersome, these devices were practical since they could be attached to nearly any piano. More recently, some inventors have created electronic piano players. The most notable of these is Trimpin’s *Vorsetzer*, a large device with 88 solenoids and felt-covered metal fingers. The solenoids fire from directly above the key, and are capable of reproducing a wide dynamic range on the instrument. In addition, the *Vorsetzer* is the only player piano device capable of depressing all 88 keys at once (sadly, the Disklavier is limited to a mere 16 notes of polyphony).

Information on commercially available player pianos can be found at their company websites:

Yamaha Disklavier
<<http://www.yamaha.com>>

Bösendorfer CEUS
<<http://www.boesendorfer.com>>

QRS/Story & Clark Pianomation
<<http://www.qrsmusic.com>>

Other similar experiments with piano players include
Winfried Ritsch’s *auto-piano player*
<<http://ablinger.mur.at/docu11.html>>

and
Godfried-Willem Raes’ *Player Piano II*, based on Trimpin’s *Vorsetzer*
<http://logosfoundation.org/instrum_gwr/playerpiano.html>

Mass production and the player as a delivery medium.

Ord-Hume, Arthur W.J.G. 1984. *Pianola: the history of the self-playing piano*. London: George Allen & Unwin. 26.

The proper capitalized noun “Pianola” refers to the Aeolian brand name. The term “pianola,” however, has become a generic term for any player piano.

For a good overview of trends in piano sales, see Howard, Roy E. 2002. Marketing History of the Piano. Accessed April 11, 2007 <<http://www.cantos.org/Piano/History/marketing.html>>

Bill Edwards gives an excellent historical overview of the growth of sheet music publishing in the nineteenth century in his two articles:

Edwards, William G. 2004. Ragtime and the Economy. Accessed April 11, 2007 <<http://www.perfessorbill.com/ragtime7.shtml>>

Edwards, William G. 2004. Sheet Music Cover Art History. Accessed April 11, 2007 <<http://www.perfessorbill.com/ragtime9.shtml>>

In 1895, Edward Votey invented a piano player he called the Pianola. The Pianola went into production in 1898 by the Aeolian Company. Just a few years later, in 1903, Henry Ford founded the Ford Motor Company and popularized the practice of mass production, the rapid and precise manufacturing of large numbers of identical items on production lines. This combination—the Pianola and mass production—would make Aeolian a household name and drive player piano production to new heights.

Until 1923, piano production would rise at astounding rates; it would more than double from 1900 until its peak just before the Great Depression. Several companies, including Aeolian, Welte-Mignon, Duo Art, and Ampico (the piano of choice for Conlon Nancarrow), would turn the player piano into a multimillion dollar industry worldwide. But this growth cannot be entirely attributed to advances in mass production. The popularity of the player piano is a direct result of its use as a musical recording and delivery medium.

Before the player piano, there existed only two ways for the average person to enjoy music: on a stage by professional musicians, or in the home by amateur musicians. In the 1800s the sale of sheet music skyrocketed as the piano became a household fixture. It was suddenly possible to bypass the cost and inconvenience of going to a concert by simply playing music at home. But this, of course, required that someone in the home be trained in music. Moreover, it could never completely replicate the experience of hearing a professional musician.

The increasing vogue of the piano player is causing widespread comment, not only in musical circles but in the private homes of American citizens who possess no musical education. This vogue is now regarded—and rightly regarded—as one of the most significant phases in the life and advancement of this mechanical age. It is heralded by the enthusiastic as a portent of the dawning of a new epoch, when machinery will still be the motive power of civilisation, but will be applied to uses hitherto deemed sacred from its invading banners. In other words, these persons—dreamers, perhaps, the conservative may call them—regard as now near at hand the day when mechanical inventiveness will invade the precincts of art and will fix its ensign in the very altar of that domain. If this vision is to be realised, the piano player will certainly be the most prominent factor in its accomplishment. The public in general will be pleased, and the piano trade will certainly not lag behind the rest of the world in similar feelings; for it is plain that, when the day of the player arrives, the field of piano enterprise will be greatly enlarged.

The public in general are fonder of music to-day than they were twenty-five years ago. Musical comedy is now the most popular form of stage attraction, and the musical comedy of the day is far in advance of the childish affairs that passed for such in an earlier period. But how to reach, if possible, the causes of the vogue of the piano player as distinguished from the causes of the vogue of music in general?

First, we must recognise the popularity of the piano as an instrument for the home. It has always been great, but never greater than at present; and in view of certain qualities possessed by the piano, which we need not discuss here, it is not likely at any time within the next hundred years to recede from its position. From the piano to the piano player is but a step; a public pleased with one will be pleased with the other.

Another cause of the rise of the player proceeds from our American habits of economising time. Our citizen loves music, but he has no time to spend in studying a complex technique. His daughter, perhaps, who would be the proper person to fill this want in his household, is busy working in a store or factory, or goes to high school and must study her Caesar or geometry when she gets home. And then there are many people who have no daughter, or none of the proper age. These matters seem trivial, but they nevertheless have a potent influence.

The third fact is this: With a piano player in your house you can give a friend musical entertainment and discourse with him at the same time. Or if you have nothing to talk about—and this is a contingency that happens with remarkable frequency at social gatherings, especially small ones—you may set your piano at work.

Still another cause lies in the admiration of the public for anything which acts, talks or plays automatically. They wonder at the thing. A wonder is a good thing to subdue and make your own. It pleases you; it will please others. Perhaps it will make them envy you; and what so sweet as envy to the envied? Again, the piano player is a novelty. In all ages novelties have been eagerly sought for, but never has there existed such a craving for them as now. Finally, we must not forget the preparative influences of certain other automatic pleasure making devices that found their way into American households before the general introduction of the piano player. These are principally the music box and the phonograph.

But doubtless, while the present writer has been setting down these reasons, its readers have evolved as many more; and it is remarkable how manifold are the reasons that bring an invention like the piano player into the forefront of public approval.

From the *Chicago Indicator*, 1903

Quoted in Ord-Hume, Arthur W.J.G. 1984. *Pianola: the history of the self-playing piano*. London: George Allen & Unwin.

The player piano, or more specifically the punched paper rolls they played, opened a vast new market for music publishers. Performances by artists like Franz Liszt, Ignacy Paderewski, and even George Gershwin were captured to piano rolls, although those artists never made phonographic recordings. Many home users reveled in the ability to hear their favorite pieces by Mozart played right in their music parlor. And it was increasingly common for popular music—especially ragtime and showtunes—to be played in the home and sung along with.

The player piano also presented a unique opportunity to composers. Igor Stravinsky spent some 15 years in close contact with a player piano, and even signed an exclusive contract with the Pleyel Company to write new pieces for the instrument. Two of the more prominent composers of player piano music, Conlon Nancarrow and George Antheil, are discussed at length later in this chapter.

| 21

Although the short burst of popularity at the turn of the twentieth century now seems like a miniscule blip on the history of music publishing, its importance cannot be understated. With today's music publishing business abuzz about rampant unlawful transfer of digital music, one cannot help but notice the irony of the situation: the first digital recordings were made well over 100 years ago.

The phonograph and the death-knell of the player piano

Just as the player piano replaced sheet music as the delivery medium of choice in the early 1900s, the phonograph and the radio brought the slow

fade of the player piano from the limelight. Arthur Ord-Hume, in his encyclopedic history of the pianola, writes,

Ord-Hume, Arthur W.J.G. 1984. *Pianola: the history of the self-playing piano*. London: George Allen & Unwin. 120.

As the 1930s advanced, sales of players began to diminish in the face of wireless, which was gaining market penetration, and the gramophone which with the improvements of electric recording could bring an orchestra into the home, albeit in stages of four or five minute between turning the disc. Also at this time... the depression had killed sales and the trade had lost faith in the instrument.

Indeed the Great Depression may have been the single biggest factor in the move to wireless communication. For one, it was infinitely less expensive to listen to the radio than to buy a new piano roll every week. And the radio was not just a medium for music, but for news and other information as well.

The phonograph and radio offered another important advantage over player pianos: reproduction of any sound, not just that of a piano. Music lovers could hear voices, violins, and various virtuosic performances. The radio touted the ability to bring an *entire orchestra* into the living room.

| 22

Ord-Hume, Arthur W.J.G. 1984. *Pianola: the history of the self-playing piano*. London: George Allen & Unwin. 122-3.

In 1927, in an attempt to rejuvenate interest in the dying player piano market, the Aeolian Company, at that time the biggest player manufacturer in the world, released a new type of piano roll that included detailed markings such that a talented operator could create virtuosic performances. They launched an expensive marketing campaign, but in the end came up penniless. In 1929, the Aeolian Company put itself up for auction. The last of the great pneumatic player piano companies was sold to the British department store Harrod's.

2. _____ George Antheil

Hocker, Jürgen. 2002. My Soul Is In The Machine — Conlon Nancarrow — Composer For Player Piano — Precursor of Computer Music. In *Music and Technology in the Twentieth Century*, ed. Hans-Joachim Braun, 84-96. Baltimore: The Johns Hopkins University Press. 84.

The invention of robotic musical instruments excited many composers. The *panharmonicon*, invented by Johann Nepomuk Mälzel, boasted the ability to emulate an entire orchestra with its strings, bells, whistles, and horns. Beethoven, upon discovering this instrument, wrote his first version of Op. 91 *Wellingtons Sieg oder die Schlacht bei Vittoria* (*Wellington's Victory or the Battle with Victoria*) for this instrument (though he would eventually rearrange it for orchestra).

By the twentieth century, composers would discover new ways to push the limits of these instruments. Not content with echoing the sound of traditional instruments and ensembles, these composers experimented with the sonic palette, playing with new timbres, new rhythms, and new textures. In some cases, they even wrote music that robotic instruments could not even play, music that went beyond the technical limitations of these already advanced inventions. One such composer was George Antheil.

| 23

Antheil's early life

Whitesitt, Linda. 1983. *The Life and Music of George Antheil: 1900-1959*. Ann Arbor: UMI Research Press. 3-4.

George Antheil was born in Trenton, New Jersey in 1900. His father owned a shoestore in the largely industrial neighborhood he grew up in. By most accounts, he had an uneventful childhood, attending Trenton Central High School (though never graduating) and learning to compose music.

At a very young age, Antheil showed a propensity for music.

Transcribed from
Lehrman, Paul D. 2006. *Bad Boy Made Good*. Directed by Ron Frank.
Produced and written by Paul Lehrman. DVD.

This is one of the few recordings that exist of George Antheil speaking.

Much of the following historical information comes from
Whitesitt, Linda. 1983. *The Life and Music of George Antheil: 1900-1959*. Ann
Arbor: UMI Research Press.

and from Antheil's autobiography,
Antheil, George. 1945. *Bad Boy of Music*. Garden City, NY: Doubleday, Doran &
Company, Inc.



Fig. 1.2: Antheil in Paris, 1927

Photo courtesy of The George
Antheil Estate; Charles
Amirkhanian, Executor.

<[http://antheil.org/photos_hires/
Antheil1927.TIFF](http://antheil.org/photos_hires/Antheil1927.TIFF)>

When I was about three years old I wanted to become a musician. More than anything else in the world I wanted a piano. At Christmas-time I stipulated that it was not to be one of those toy pianos one bought in the toy stores, I wanted a real one. I made this very clear, and at Christmastime I came downstairs and I saw that my parents bought me a toy piano. So I didn't say a word. I took it down in the cellar, and I got a hatchet and I chopped it up.

Antheil would eventually get his wish, beginning piano lessons at age six. At age sixteen he began studying with Constantin von Sternberg, a student of Franz Liszt. Antheil would write fondly of Sternberg, calling him his “musical godfather,” despite his “severe yet kindly training.” Later Antheil would study with Ernest Bloch in New York City. Bloch would regularly criticize Antheil's work, and eventually Antheil would be forced to end his lessons due to lack of money.

In 1921, Antheil met Mary Louise Curtis Bok, who would, in 1924, found the Curtis Institute, one of America's premiere music conservatories. Bok quickly warmed to Antheil and would come to fund his work for the next nineteen years, despite her conservative tastes in music.

But Antheil was growing weary of the attitude toward music—and the arts in general—in the United States. He dreamed of becoming a concert pianist in addition to a composer, but his work and his playing were never well received in the U.S. Believing the artistic atmosphere in Europe to be less inhibited, Antheil set sail for London in 1922, where he would work for just a few months before heading to Berlin. In Berlin, Antheil would meet Igor Stravinsky—a musical meeting that would come to shape the rest of Antheil's career. “Stravinsky's music, hard, cold, unsentimental, enormously brilliant and virtuos [sic], was now the favor-



Fig. 1.3: The handwritten pianos-only score for *Ballet mécanique*

Photo courtesy of Paul Lehrman and The Ballet Mécanique Page
<http://antheil.org/photos_hires/BalletMecScore300.TIFF>

ite of my postadolescence,” Antheil wrote in his autobiography. Antheil would finally settle in Paris in 1923, in order to be closer to Stravinsky, and he would remain there for ten years. During this time Antheil would move to the forefront of the Parisian arts scene, mingling with such notable figures as Ezra Pound, James Joyce, Ernest Hemingway, Man Ray, Picasso, and others. It was in Paris that Antheil would find his musical voice and pen his most infamous piece, *Ballet mécanique*.

The Ballet mécanique

Antheil completed the first draft of *Ballet mécanique* in 1924, and the complete score in 1925. The score calls for 3 xylophones, electric bells, 3 airplane propellers, a tamtam, 4 bass drums, a siren, 2 pianos (played by live pianists), and 16 synchronized pianolas (four parts played by four pianos each).

At the time, Antheil had been working closely with the Pleyel company, a manufacturer of player pianos. In 1923 Pleyel filed a patent for synchronizing the rolls on multiple player pianos. It is believed that this invention is what inspired Antheil to write for such an outrageous number of instruments. But Pleyel was never able to build such a system. In his lifetime, Antheil would never hear the *Ballet mécanique* as he had written it.

My *Ballet mécanique* is the new FOURTH DIMENSION of music.

My *Ballet mécanique* is the first piece of music that has been composed OUT OF and FOR machines, ON EARTH...

My *Ballet mécanique* is the first music ON EARTH that has its very germ of life in the new fourth-dimensional phenomena wherein TIME FUNCTIONING IN MUSIC DIFFERS FROM ORDINARY TIME and the series of deductive and also purely physical phenomena that follow it.

My *Ballet mécanique* is the first TIME-FORM on earth.

My *Ballet mécanique* is neither tonal, nor atonal. In fact it is of no kind of tonality at all. It has nothing to do with tonality. It is made of time and sound... The two materials, FUNDAMENTAL materials, that music is made of...

My *Ballet mécanique* comes out of the first and principle stuff of music...TIME-SPACE...

My *Ballet mécanique* has a closer connection to life than any of the tonal music that preceded it. But it is a musical and not a literary connection.

In my *Ballet mécanique*, I offer you, for the first time, music hard and beautiful as a diamond...

The *Ballet mécanique* is the first piece IN THE WORLD to be conceived in one piece without interruption, like a solid shaft of steel...

From "My Ballet mécanique." In *De Stijl*, vol. 6, no. 12. 1925.

Whitesitt, Linda. 1983. *The Life and Music of George Antheil: 1900-1959*. Ann Arbor: UMI Research Press. contains a detailed history of the *Ballet mécanique* and its early performances. Much of this section derives from that source on pages 21-41.

Whitesitt, 25.

The public premiere of *Ballet mécanique* occurred at the Champs Elysées Theatre in Paris with Vladimir Golschmann conducting. As expected, the performance utilized a reduced score, with all four pianola parts condensed to a single piano roll. Antheil invited many of his friends in the Paris avant-garde, and attendance was high, given Antheil's intense publicity. Much like his idol Stravinsky had done just a few years prior with the premiere of *Le Sacre du Printemps*, the *Ballet mécanique* incited a riot. Antheil's friend Bravig Imbs wrote about the premiere in his memoir,

Within a few minutes, the concert became sheer bedlam. Above the mighty noise of the pianos and drums arose cat-calls and booing, shrieking and whistling, shouts of "thief" mixed with "bravo." People began to call each other names and to forget that there was any music going on at all. I suffered with George, wishing that people would have at least the courtesy to stay quiet, but Golschmann was so furious he would not give up his baton, and continued to conduct imperturbably as though he were the dead centre of a whirlpool.

27

In the end, the *Ballet mécanique* would get a standing ovation, and was truly a great success. Antheil was not upset by the rioting; rioting was exactly what he was hoping for. He wanted nothing more than to make his debut a noisy, clamorous event, a publicity stunt in and of itself. He was the new *enfant terrible* of the Paris music scene.

Musically, the *Ballet mécanique* owes a huge debt to Stravinsky. It begins just as propulsively as it ends, all sixteen pianolas pounding away on a single chord in changing meters. The piece is brashly non-tonal; though it often resolves to central chords, the progressions do not follow any typical movement. The xylophones play jagged melodic lines throughout, with rhythm being a more important feature than melody. In the first six measures, there are five different time signatures. All of these features are

Cowell, Henry. 1954. Current Chronicle. In *The Musical Quarterly*, XL:2, April. 242-43.

A review of *Volpone* appears in
Cowell, Henry. 2002. George Antheil. In *Essential Cowell: Selected Writings on Music by Henry Cowell, 1921-1964*, ed. Dick Higgins, 150-154. Kingston, NY: McPherson & Company.

Cowell, Henry. 2002. John Cage. In *Essential Cowell: Selected Writings on Music by Henry Cowell, 1921-1964*, ed. Dick Higgins, 132-143. Kingston, NY: McPherson & Company.

lifted carefully from *Le Sacre du Printemps*. Henry Cowell wrote of the piece:

The relationship of this work to the *Sacre* is fairly obvious, although the brash attempt to out-Stravinsky Stravinsky is equally evident. To the extent that the *Ballet Mécanique* is louder, more energetic and irregular rhythmically, more dissonant and more chromatic, the attempt succeeds. Many of the piano chords are similar in character, although there are new chords too, and dissonances are more heavily piled up. The use of the four pianos is not unlike that in [Stravinsky's] *Les Noces*; then there is the familiar device of development by reiteration of short simple motifs, with chromatic ornamentation. The xylophone and glockenspiel multiply contrapuntal decorations of incredible speed, and the players display really unheard-of virtuosity on these instruments.

Cowell was a frequent detractor of Antheil's music, but nevertheless sought to give it a fair analysis. He would, on occasion, laud Antheil's work, as in the case of the 1953 opera *Volpone*. But Cowell's most interesting writing about Antheil comes in a single paragraph aside in an essay about John Cage.

As this article was being written, George Antheil called my attention to the score of his *Ballet mécanique*, which has a section in which silent measures of 8/8 appear periodically. This was written in 1924, and its generative ideas derived from long sessions spent with George Herzog in Berlin, listening to recordings of the music of India, China, and more primitive cultures. Around this time Antheil developed an interest in the time-space concept and music in absolute time; Ezra Pound's book on Antheil gives an account of these theories.

Antheil, George. 1959. *Ballet mécanique*. G. Schirmer, Inc.
Distributed by Hal Leonard Corporation, Milwaukee, WI.
Edition copyright © 2003.

Pound, Ezra. 1968. *Antheil and the Treatise on Harmony*. New York: Da Capo
Press. First published 1927. 10.

Indeed the final movement of *Ballet mécanique* contains several passages where entire measures have rests written for every beat. Antheil treated these rests just the same as any note on a page. John Cage would shock the music world with his seminal work 4'33", a piece that brings silence to the forefront, and treating it as a musical entity unto itself. But 4'33" would not be written until 1952, some 27 years after *Ballet mécanique*.

The poet Ezra Pound, a good friend of Antheil's, published a book rhapsodizing Antheil and his use of silence. More specifically, Pound wrote of the importance of time in music, and the ways that time can affect harmony. "A sound of any pitch," Pound wrote, "or any combination of such sounds, may be followed by a sound of any other pitch, or any combination of such sounds, providing the time interval between them is properly gauged; and this is true for any series of sounds, chords or arpeggios."

Pound also espoused the power of musical machines in the twentieth century:

Pound, 51.

Machines are not literary or poetic, an attempt to poetise machines is rubbish. There has been a great deal of literary fuss over them. The Kiplonians get as sentimental over machines as a Dickensian does over a starved and homeless orphan on a bleak cold winter's night.

Machines are musical. I doubt if they are even very pictorial or sculptural, they have form, but their distinction is not in form, it is in their movement and energy; reduced to sculptural stasis they lose *raison d'être*, as if their essence.

The use of silence as a musical figure is very much a function of the mechanization of the twentieth century; it stems from the source of the player piano's music, the binary data of punched paper rolls. Just as every note must be punched into a roll in order for it to sound, each rest must

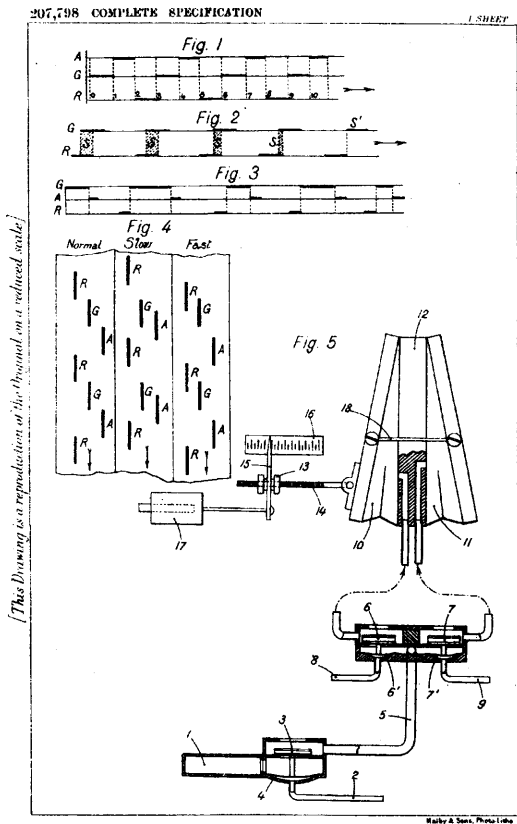

[This Drawing is a reproduction of the original on a reduced scale.]

Fig. 1.4: The 1924 Pleyel patent for synchronizing multiple player pianos.

Image from the United Kingdom Patent Office, patent no. 207798

<<http://v3.espacenet.com/textdraw?>

be *not* punched into the roll. In this context, a rest becomes a tool for the composer, not just an absence of notes but a vital and quantifiable measurement that is every bit as important as a note.

Performing Ballet mécanique again, for the first time

Ballet mécanique represented a quantum leap in the world of music technology. Here, for the first time, was a piece conceived entirely in the imagination of the composer that would never be played in his lifetime due to the technical limitations of the instruments he had written for.

The major obstacle to performing *Ballet mécanique* was the inability to sync multiple player pianos. Though Pleyel, the company that Antheil worked closely with to develop the piece, had filed a patent for a piano synchronization system in 1924, they never implemented the system. Antheil was forced to perform simplified versions of the piece, using single piano rolls containing all four parts, or sometimes performing using 8 pianos and allowing them to become “in a strange synchronization,” as Antheil wrote of the second performance of the piece. This obstacle would finally be overcome by the advent of electronically controlled player pianos.

The technique of placing an electromagnet near a metal string is one that appears occasionally. The earliest example is Richard Eisenmann's Electorphonisches Klavier in 1886, referenced in

McElhone, Kevin. 1999. *Mechanical Music*. Buckinghamshire, UK: Shire Books.

Later examples include

Backer, Steven, Edgar Berdahl and Julius O. Smith III. 2005. If I Had a Hammer: Design and Theory of an Electromagnetically-Prepared Piano. In *Proceedings of the International Computer Music Conference 2005 (ICMC 2005)*,

and

Lucier, Alvin. 1992. *Music on a Long Thin Wire*. Lovely Music. CD.

Lehrman, Paul D. 2003. The *Ballet mécanique* Project: Technology Catches up with Antheil. In the notes to *Ballet mécanique*, score by George Antheil. G. Schirmer Inc. xii-xv.

The first electronically controlled pianos utilized an electromagnet placed under the string to induce vibration. Unfortunately this system did not produce the familiar hammered sound of a piano. This led to electromechanical systems, using solenoids and servo motors to move the keys on the piano. This new breed of piano could be controlled via MIDI or other proprietary protocols, allowing for several pianos to be connected to a central computer and controlled simultaneously.

In 1998, G. Schirmer, the company that had purchased the publishing rights to Antheil's scores, approached Paul Lehrman about revising *Ballet mécanique* for modern player pianos. At the time Lehrman was serving on the music faculty at the University of Massachusetts, Lowell. Recent advancements in Yamaha's Disklavier line of pianos gave Lehrman confidence that the piece could in fact be revived completely, the first performance as the composer intended it to be performed since the piece was composed.

Lehrman took on the task of inputting by hand all 1240 measures of the *Ballet mécanique* into a MIDI sequencer. Earlier attempts at recreating the piece had used the original piano rolls created by Pleyel, optically scanning them to create electronic sequences. But these versions were prone to error. Lehrman, along with musicologist Rex Lawson, carefully compared the new MIDI sequence, the engraved score, and the original piano rolls to ensure that this version would be precisely the one Antheil had originally intended.

On November 18, 1999, the *Ballet mécanique* was premiered in its original form, as the composer intended it, almost 75 years after it was origi-

nally composed. The performance was conducted by Jeffrey Fischer with the UMass Lowell Percussion Ensemble. The stage was filled with Disklaviers (16 of them, of course), percussion instruments, bells and sirens. The airplane propellers were recreated using sampled audio.

In the wake of groundbreak

Despite the acclaim and notoriety Antheil experienced after the Paris premiere of *Ballet mécanique*, he would not be welcomed elsewhere. In 1933 he returned to the United States, where the piece would receive its premiere at Carnegie Hall in New York City. The performance was a disaster. The audience laughed and jeered. And then,

The *Ballet* finally drew to a close. At this point every instrument on the stage was playing, and the noise was terrific. And now came the moment for the fire siren to sound. Goossens gave the cue, and the mechanical-effects man turned the crank wildly, while the audience, unable to contain itself any longer, burst once more into uncontrolled laughter. But there was no sound from the siren. He turned the crank more and more wildly, and still there was no sound. The moment for the siren was by now long past, and Goossens was turning to the last page of the score. Disgustedly the effects man stopped turning the crank, as the last bars of the *Ballet* crashed out. And then in the silence that followed there came the unmistakable sounds of a fire siren gathering speed. Louder and louder it came as the last notes of the *Ballet* died away, and as Goossens turned to bow to the audience and Antheil rose from the piano, it reached its full force. We had all of us completely forgotten the simple fact that a fire siren does not start making any sound until it has been energetically cranked for almost a full minute. And also we had forgotten that it does not stop shrieking simply because you stop cranking. We remembered both of these things now as the wail from the infernal red thing on the stage kept dinning in our ears, drowning out the applause of the audience, covering the sound of the people picking up their coats and hats and leaving the auditorium.

Excerpt from a letter, Donald Friede to Mary Louise Curtis Bok, June 30, 1927, quoted in Whitesitt, Linda. 1983. *The Life and Music of George Antheil: 1900-1959*. Ann Arbor: UMI Research Press. 36.

Antheil would never fully recover from this. In 1936 he left New York, artistically and financially bankrupt, for Los Angeles. He quickly picked up work as a film composer, penning the scores for such films as *The Plainsman* (1958) with Gary Cooper. He would continue to work in film for the rest of his life, with over 30 scores to his name.

3. _____ Conlon Nancarrow

At the forefront of player piano composition in the mid 20th century was the composer Conlon Nancarrow. Though he would remain almost completely unknown until late in his life, his compositions pushed the boundaries of the player piano, opening the floodgates for new innovations in robotic music.

Early career

Nancarrow, Conlon. 2000. *Lost Works, Last Works*. San Francisco: Other Minds. Compact Disc. Track 18, "Favorite Jazz Artists," in conversation with Charles Amirkhanian.

Hocker, Jürgen. 2002. My Soul Is In The Machine — Conlon Nancarrow — Composer For Player Piano — Precursor of Computer Music. In *Music and Technology in the Twentieth Century*, ed. Hans-Joachim Braun, 84-96. Baltimore: The Johns Hopkins University Press. 86.

This text by Hocker is referenced extensively in this section. Hocker has also written a monograph on Nancarrow, but it is only available in German. This is, to my knowledge, the only English translation of Hocker's writings on Nancarrow.

Conlon Nancarrow was born in Texarkana, Arkansas in 1912. As a young man, he began taking piano lessons, but quickly left the piano for the trumpet. He acquired a taste for early jazz musicians like Earl "Father" Hines, Louis Armstrong, and Bessie Smith, an influence that would remain with him throughout his career. After high school he attended Vanderbilt University in Nashville, studying engineering. But he tired quickly of this, and left after only a few weeks to study music at the Cincinnati Conservatory. He began studying theory, composition, and trumpet, but soon left there as well, commenting that "I was looking for something a little less academic." So he moved to Boston, where he studied with Nicolas Slonimsky, Walter Piston, and Roger Sessions.

Gagne, Cole and Tracy Caras. 1982. Conlon Nancarrow. In *Soundpieces: Interviews with American Composers*. Metuchen, NJ: Scarecrow Press.

Rockwell, John. 1981. Conlon Nancarrow — Poet of the Player Piano. *New York Times*, June 28, Section 2, Page 17, Arts and Leisure Desk, Late City Final Edition. Accessed March 27, 2007 via lexis-nexis.com.

Anecdote about Lenin memorial concert in

Duckworth, William. 1995. Conlon Nancarrow. In *Talking Music: Conversations with John Cage, Philip Glass, Laurie Anderson, and Five Generations of American Experimental Composers*, 29-51. New York: Schirmer Books. 37.

Like George Antheil, Nancarrow would be heavily influenced by composers of the day, including Stravinsky and Bartók. He spoke of Stravinsky in an interview: “Well, it was a total revelation. At that time I’d heard practically no contemporary music, and suddenly *The Rite of Spring* was thrown at me, and it just bowled me over. This was when I was in Cincinnati. I heard it at a concert there, and it just opened up a new world to me.”

Nancarrow joined the Abraham Lincoln Brigade in 1937 to fight in the Spanish Civil War. Upon his return to the United States in 1940, he came under the scrutiny of the United States government. For a year he struggled to obtain a new American passport, but as a registered Communist (who had once organized a memorial concert for V.I. Lenin at Symphony Hall in Boston), his request was not granted. So he moved to Mexico City, where he would live and work for the rest of his life.

Nancarrow left the United States with few personal possessions; among the most important was a text by Henry Cowell. He became intrigued by “Cowell’s suggestion that complex rhythms, such as five against seven, could be performed easily on player piano.” Nancarrow had experienced the limitations of human players firsthand: his *Sonatina* (1945) was completely unplayable. And he was growing increasingly fed up with the reliability of the musicians he was working with, who would show up late to rehearsals and never fully learn the pieces.

In fact, the septet was played once in New York after I came back from Spain—I think in 1941. In any case, that was one that was played! Actually it wasn’t very complicated. It had a conductor. The League of Composers had very good musicians. They got them from studios there, from the radio. There were two rehearsals. For one rehearsal, four came. The second rehearsal, three, and one of the original four. So there wasn’t one session with the whole group. And when they played it, a couple of instruments lost their place right at the beginning. All through the piece, they were playing in some other place. Everything was lost, it was a real disaster.

These feelings eventually led Nancarrow to adopt the player piano as his primary medium. In 1947 he travelled to the United States to procure a player piano and a roll punching machine. As expected, he was given trouble by the government and was forced back to Mexico when his visa expired. Fortunately he had managed to find a player piano and punching machine, which were shipped to him in Mexico City. From that point Nancarrow would devote his entire career to composing for the player piano.

Duckworth, 30.

Duckworth, 42.

Reynolds, Roger. 1984. Conlon Nancarrow: Interviews in Mexico City and San Francisco. In *American Music*, Summer, 2:2.

Hocker, Jürgen. 2002. My Soul Is In The Machine — Conlon Nancarrow — Composer For Player Piano — Precursor of Computer Music. In *Music and Technology in the Twentieth Century*, ed. Hans-Joachim Braun, 84-96. Baltimore: The Johns Hopkins University Press. 87.

Nancarrow's pianos

Early on Nancarrow discovered the endless possibilities of the player piano: inhuman speed, polyphony, and rhythmic variation. But he was not quite content with the sound:

Duckworth, William. 1995. Conlon Nancarrow. In *Talking Music: Conversations with John Cage, Philip Glass, Laurie Anderson, and Five Generations of American Experimental Composers*, 29-51. New York: Schirmer Books. 45-6.

Before I settled on what I have now, I made several experiments. There used to be a thing that they had in player pianos called the mandolin attachment. First I tried that. It was very nice sound that I liked. The only trouble was these little leather strips kept getting tangled among the strings. It was just impractical, so I dropped that. Then I tried soaking the hammers in shellac. Well, that didn't work... [I finally settled on] two. One has the regular hammer on the piano covered with a leather strip that has a little metallic thing at the striking point. It's not a thumbtack exactly. It still has the cushion of the regular hammer plus the metallic thing. It's not a harpsichord, but it's vaguely in that area... it sharpens it. The other one is very, very aggressive and hard. It has wooden hammers, pure wood, covered with a steel strip. That's the one that's much harder.

These modifications gave Nancarrow his trademark sound, a cross somewhere between a honky-tonk piano and a harpsichord.

Hocker, Jürgen. 2002. My Soul Is In The Machine — Conlon Nancarrow — Composer For Player Piano — Precursor of Computer Music. In *Music and Technology in the Twentieth Century*, ed. Hans-Joachim Braun, 84-96. Baltimore: The Johns Hopkins University Press. 88.

The first player that Nancarrow acquired was an Ampico reproducing piano. This brand uses rolls with 98 tracks: 83 control tracks for the keyboard, one track for each of the right and left pedals, 6 tracks to control the dynamics of the bass half of the keyboard, and 6 tracks for dynamics on the treble half. There is also a single track to control the re-winding action of the piano.

The studies for player piano

Gann, Kyle. 1995. *The Music of Conlon Nancarrow*. Cambridge: Cambridge University Press.

Extensive analysis of *Study No. 8*, along with several others appears in Carlsen, Philip. 1988. *The Player-Piano Music of Conlon Nancarrow: An Analysis of Selected Studies*. *I.S.A.M. Monographs*, no. 26.

Kyle Gann, who is perhaps the leading scholar on the music of Conlon Nancarrow, wrote in the opening to his book on the subject, “His music, almost all written for player piano, is the most rhythmically complex ever written, couched in intricate contrapuntal systems using up to twelve different tempos at the same time.” It may be hyperbole, but it is not understatement. Few composers have even attempted the hair-raising feats of rhythmic gymnastics that Nancarrow so nonchalantly wrote.

If we take, for example, his *Study No. 8*, we find a few interesting characteristics. First we notice the “omnipresent rhythmic theme of... acceleration and deceleration.” These tempo changes were manually punched into the rolls, and not controlled by the piano’s speed control; Nancarrow retained complete control over the duration, onset, and spacing of each note. We also find that the piece has four independent and distinguishable voices. Although each of these voices has clearly defined melodic material, it is often difficult to parse these themes as the tempo changes constantly (and fluidly). To help alleviate some ambiguity, Nancarrow imitates each motive *ad nauseam*. His later pieces would extensively use canon techniques in a similar manner. Like Lutosławski, Nancarrow grew increasingly interested in music without barlines and without vertically aligned rhythms. This feature lends itself well to the player piano, as notes can be placed anywhere in time.

Reynolds, Roger. 1984. Conlon Nancarrow: Interviews in Mexico City and San Francisco. In *American Music*, Summer, 2:2.

Letter dated June 28, 1980, quoted in
Hocker, Jürgen. 2002. My Soul Is In The Machine — Conlon Nancarrow
— Composer For Player Piano — Precursor of Computer Music. In *Music
and Technology in the Twentieth Century*, ed. Hans-Joachim Braun, 84-96.
Baltimore: The Johns Hopkins University Press. 94.

Another piece to utilize this acceleration/deceleration motif is the *Study No. 27*. Nancarrow writes,

With *No. 27* I thought of the whole piece as an ostinato, that I was going to have the exact proportions of sections worked out, before composing it. There would be a certain amount of this and a certain amount of that, but through the whole was going to be an ostinato—that against a constantly shifting acceleration and retarding. In fact, I like to think of the ostinato in that piece as the ticking of an ontological clock. The rest of it—the other lines—wandering around... There are four different percentages of acceleration and ritard that react against the ostinato: 5%, 6%, 8% and 11% ritards and accelerations. Incidentally, that's the only piece I ever did over again.

To say that Nancarrow's music is difficult is perhaps an oversimplification of the matter; its beauty is undeniable, but requires a truly devout admiration to appreciate casually. Among Nancarrow's most avid supporters was the Hungarian composer Györgi Ligeti. In a letter to the conductor Mario di Bonaventura, Ligeti wrote

After the few player piano studies of Nancarrow I listened to, I affirm with all my serious judgement that Conlon Nancarrow is the absolutely greatest living composer. If J.S. Bach had grown up with blues, boogie-woogie and Latin-American music instead of the protestant choral, he would have composed like Nancarrow, i.e. Nancarrow is the synthesis of American tradition, polyphony of Bach and elegance of Stravinsky, but even much more: he is the best composer of the second half of this century.

Sadly, though, Nancarrow would remain largely unknown in his lifetime. In the late 1970s, Charles Amirkhania, the executor of the George Antheil estate, would record and release Nancarrow's music on his Arch label. A buzz quickly grew around the music, and Nancarrow was invited to return to the United States in 1982, when he was honored at the Cabrillo Festival in Aptos, California. That same year he received the first MacArthur Genius Grant. His newfound fame (which was somewhat

unwelcome to the hermitic composer) would be short-lived, though: Nancarrow passed away in 1997 in his Mexico City home.

4. _____ Trimpin

Late in Nancarrow's life he befriended a young German composer who had moved to the United States named Trimpin (he goes only by his last name). Trimpin's interest in mechanical music had led him to develop a player piano roll reader that could translate punched rolls into MIDI. Their friendship eventually led to the complete digitization of Nancarrow's music, as well as several other projects. Trimpin also invented a device he calls a *Vorsetzer* (see p. 18) to play these pieces, since no commercially available MIDI controlled pianos are capable of reproducing such a large quantity of notes.

In addition to his work with Nancarrow, Trimpin has produced an enormous repertoire of musical robots, and has inspired the work of nearly all musical roboticists of the past 30 years.

I had the opportunity to speak with Trimpin at his studio in 2007. Parts of this section come from my interaction with him, though much of the historical information comes from other sources.

Perkis, Tim. 1999. Taming the Elements with MIDI. In *Electronic Musician*, Dec. 1. Accessed April 14, 2007 <http://emusician.com/mag/emusic_taming_elements_midi/>

First impressions on meeting Trimpin

Trimpin was born in the Black Forest in Germany in 1951. He recalls his early years as a musical experimenter:

Working with music and mechanics was a fascination of mine as a kid, because I grew up in the Black Forest with all the barrel organs, band organs, and automatic clocks. When I was a kid, I made my own kind of music machines. When I was around ten years old, I collected 12 or so old-fashioned tube radios, took the wooden cases off, and stacked them up. Then I connected the dials for changing the stations with one pulley, so when you turned one dial it would change all the stations on all the radios. I would work for days on this pulley system, so that they would all be moving at the same time, on completely different stations. This was almost like rap music.

Perkis, Tim. 1999. Taming the Elements with MIDI. In *Electronic Musician*, Dec. 1. Accessed April 14, 2007 <http://emusician.com/mag/emusic_taming_elements_midi/>

Ask, Einar. 2007. The Trimpin Cover Story. In *The NWCA Newsletter*. Accessed April 14, 2007 <<http://www.einar.com/trimpin.html>>



Fig. 1.5: Trimpin in his studio.

Photo © 2006 Mike Fabio.

After receiving his master's degree in Sozial Pädagogik/Music and Art in Berlin, he moved to the United States in 1979. He settled in Seattle, home of aeronautical giant Boeing. When I asked him why he moved to the United States, he unequivocally answered, "For the junk." At the time, Boeing was mass producing huge amounts of airplanes and all the spare parts were trickling down to surplus outlets. Berlin, in contrast, had few sources where a tinkerer like Trimpin could get his hands on spare motors, scrap metal, and other electronic odds and ends.

On visiting his studio, everything seems crystal clear: the three story building is filled from top to bottom with bins full of spare parts, junk that must have seemed useless to someone, but in the hands of Trimpin can turn into sublime art. The building is filled with his creations as well. Overhead hangs an enormous metal track—his first prototype for a piece called *SHHH*—in which an aluminum ball, slightly larger than a basketball, is rolling gently back and forth, producing a subtle drone. On a shelf

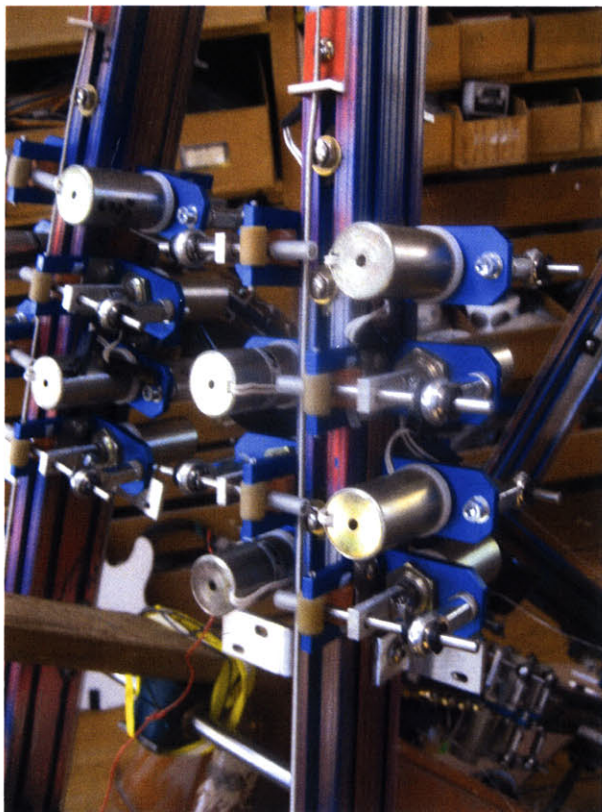

Fig. 1.6: A closeup of the fingering mechanism on one of Trimpin's guitar robots. Each piece is hand machined by Trimpin himself.

Photo © 2006 Mike Fabio

are a cluster of toy pianos, a splendid collection of antiques. On another shelf sits one of his oldest pieces, *Dadadata*. The collection of early tape data backup devices looks somehow not antiquated at all, a piece of techjunk turned into a living, breathing work of art.

Upstairs he shows me a new piece he is working on for the Kronos Quartet. It is based on some earlier work he had done with self-playing guitars that appears in the Experience Music Project in Seattle. This contraption resembles a metal arachnid with legs shaped slightly like guitars. Each leg has a string along with a series of mechanical fingers and frets and a motorized picking device. He flips on a small guitar amplifier nearby. The familiar sixty-cycle hum sets the tone for the most bizarre version of Pink Floyd's "The Machine" I have ever encountered (played, of course, by a machine).

41

On speaking with Trimpin about his work, it becomes painfully obvious that this man is as much a part of his machines as they are a part of him. He designs and builds these works almost completely by himself. Only if a piece is too large or unwieldy does he bring in outside help. And looking around his studio, I get the sense that he works long hours; the obsessive collection of junk surrounding me could only be the result of painstaking work, searching and cataloguing, a sort of curating.

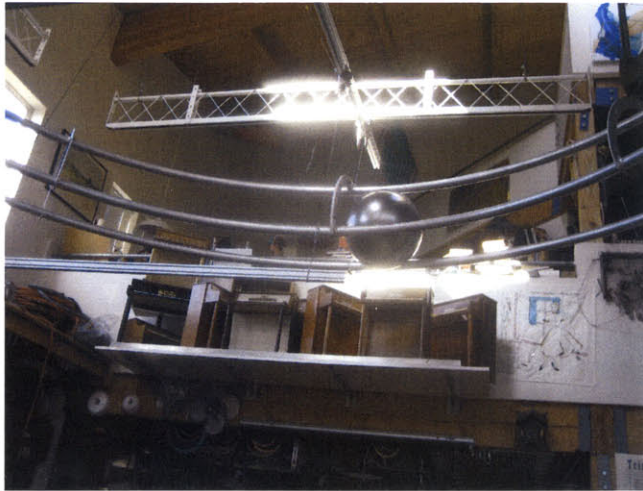

Fig. 1.7: A collection of toy pianos and the prototype for SHHH.

Photo by Mike Fabio

Fig. 1.9: Klompen.

Photo courtesy of Troy Tietjen <<http://www.flickr.com/photos/54495388@N00/401051226/in/set-72157594541722517/>>

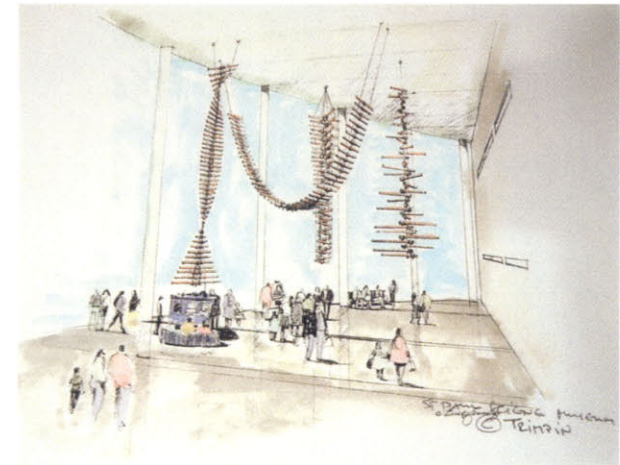

Fig. 1.8: Trimpin at his Vorsetzer.

Photo by Mike Fabio

Fig. 1.10: Original watercolor sketch for Magnitude in C#

Photo courtesy of John Brew <<http://www.flickr.com/photos/brewbooks/241312689/>>



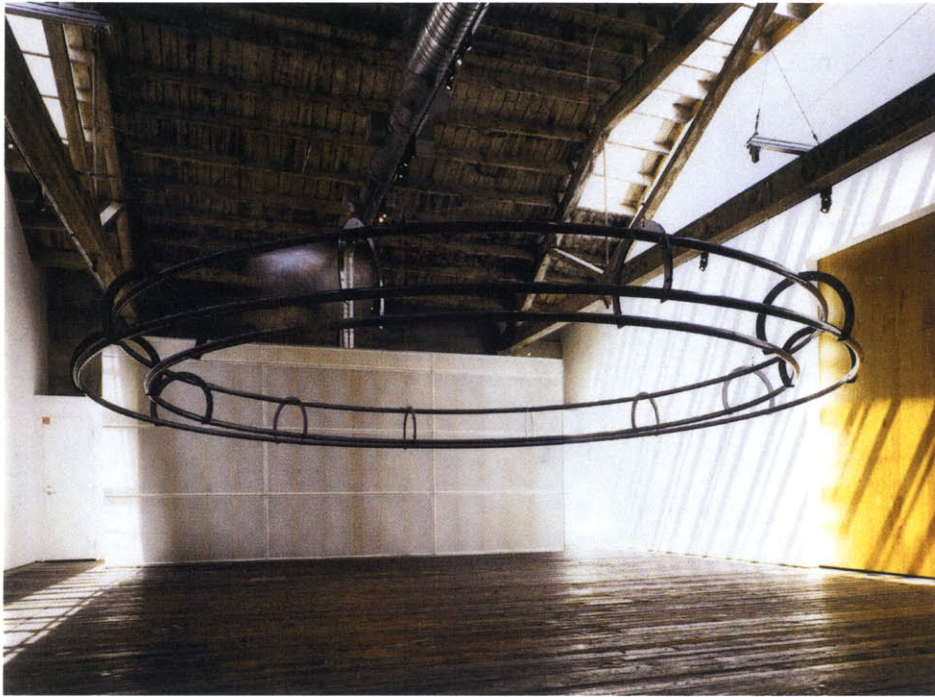
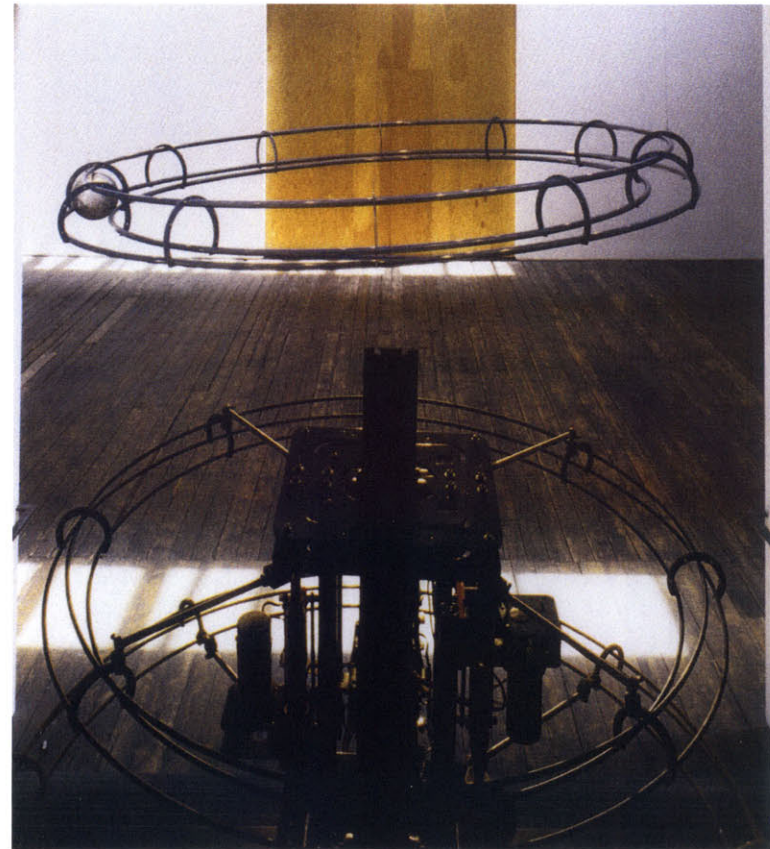

Fig. 1.11: *SHHH* at Suyama Space, Seattle, WA

Photos courtesy of Trimpin, scanned from

Trimpin. 2006. *SHHH: An Installation by Trimpin*. Seattle: Suyama Space. Edition of 500.



We sit for a while and discuss the state of musical robots. I tell him of my work building *The Chandelier* and he is instantly intrigued. Perhaps my description was a bit incredulous: there aren't a lot of string instruments that big. He asks for details, too. What kind of motors are you using, where did you buy them, what materials, what connectors, what strings, did you build the electronic control, does it use MIDI, can it be played by a person? His enthusiasm is endless. I explain to him that I've had a hard time finding certain types of motors, and his eyes light up: he knows just the place, somewhere in San Francisco, that happens to have a surplus of this stuff. I can't help but wonder whether this man sleeps.

Glancing through his bookshelf I see countless books on the works of Nancarrow, of the history of the player piano, of physics and electronics, of music. He is erudite but not disarming. His knowledge of the field is encyclopedic, and he knows personally many of the people doing this work. And then I notice a strange record, sitting unboxed, emblazoned with the likeness of Liberace. Beneath it is a huge stack of other Liberace records. Why, I ask? He explains they are for a piece for robotically controlled turntables, a sort of primitive sampler. One can only wonder why he chose Liberace.

| 44

The work of a genius

In 1997 Trimpin followed in the footsteps of his friend Nancarrow, receiving a MacArthur Genius Fellowship. As it turns out, this is not his only honor. His resume turns up a list of over 30 such awards. I can say without hesitation that few artists are as deserving of an award moniker like that as Trimpin.

Vroom, Steven Michael. 2005. Looking Ahead with Trimpin. In *Vroom Journal*, April 23, vol iii. Accessed April 14, 2007 <<http://www.vroomjournal.com/articles/trimpin.php>>

His works vary greatly in their mechanism, but a constant thread runs through them: they are at once childlike and mature. Trimpin's robots attempt to capture the look and feel of antique orchestrions and automated circus bands, but the sounds he creates are unlike anything I've heard.

His most famous work is *Conloninpurple*, created in memoriam of Nancarrow just after his death. It consists of a roomful of what appear to be hanging xylophones, arranged in sets to produce different registers from various parts of the room. Each bar is actuated by a solenoid-driven mallet. The actuation gives the instrument just enough kinetic energy to start each part spinning. As the sound intensifies, so does the movement, until the audience is engulfed in a whirlwind of spinning instruments.

Ibidem

Klompen is a work made entirely of wooden dancing clogs. Each clog is hung from the ceiling by a wire at varying lengths, creating a cloud of wooden shoes, each varnished with a slightly different color. Inside the clogs are solenoid-driven beaters that hit the shoe, producing the familiar clicking sound. The whole system is driven by a MIDI sequence to play complex rhythmic compositions. The viewer may walk freely through the cloud of shoes. Another version of this piece was also made where each shoe was set afloat in a small pond, a sea of "klomping" shoes.

More recently Trimpin created *IF VI WAS IX: Roots and Branches* at the Experience Music Project in Seattle. This three story tall vortex of guitars and other instruments stands as the centerpiece of the museum. Among the 650 guitars that make up this tower are several custom made single-string guitars. "These guitars have mechanical fingers, triggered by solenoids, along the frets... At the bottom of each string is a metal cylinder with two plucking devices on it: a rubber one that makes the string sound as if plucked by a finger and a plastic one that sounds like a pick." The audience listens to these guitars at headphone stations where they can choose original compositions in several styles of American music, including a rather fun rendition of Jimi Hendrix.

Gann, Kyle. 2000. Hendrix from Heaven. *The Village Voice*, June 7-13. Accessed April 14, 2007 <<http://www.villagevoice.com/music/0023,gann,15442,22.html>>

There are many other accounts of Trimpin's work, almost all in newspapers or magazines, including:

- Ask, Einar. 2007. The Trimpin Cover Story. In *The NWCA Newsletter*. Accessed April 14, 2007 <<http://www.einar.com/trimpin.html>>
- Bunn, Austin. 1998. Mechanical Music. *The Village Voice*, January 7-13. Accessed April 14, 2007 <<http://www.villagevoice.com/news/9802,bunn,368,8.html>>
- Futuremusic contributors. 2006. Sound Artist Trimpin Triumphs with Der Ring. In *Futuremusic: Digihear?*, June. Accessed April 14, 2007 <<http://futuremusic.com/news/june2006/trimpin.html>>
- Gann, Kyle. 2000. Hendrix from Heaven. *The Village Voice*, June 7-13. Accessed April 14, 2007 <<http://www.villagevoice.com/music/0023,gann,15442,22.html>>
- Hopkin, Bart. 1996. *Gravikords, Whirlies & Pyrophones: Experimental Musical Instruments*. Forward by Tom Waits. Roslyn, NY: Ellipsis Arts...
- Keyes, Matt. 1997. The Sound of Genius. In *The Online Daily of the University of Washington*, August 13. Accessed April 14, 2007 <<http://archives.thedaily.washington.edu/1997/081397/trimpin.html>>
- Lozano-Hemmer, Rafael. 1996. Perverting Technological Correctness. *Leonardo* 29:1: 5-15.
- Perkis, Tim. 1999. Taming the Elements with MIDI. In *Electronic Musician*, Dec. 1. Accessed April 14, 2007 <http://emusician.com/mag/emusic_taming_elements_midi/>
- Rhees, David J. 2002. Physics in "Lake Wobegon": A Tour of Three Minnesota Museums of Science and Technology. *Physics in Perspective* 4:4: 230-40.
- Strouse, Jean. 2006. Perpetual Motion. *New Yorker*, May 8.
- Trimpin. 2000. *SoundSculptures: Five Examples*. Munich: MGM MediaGruppe München.
- Trimpin. 2006. *SHHH: An Installation by Trimpin*. Seattle: Suyama Space. Edition of 500.
- Vroom, Steven Michael. 2005. Looking Ahead with Trimpin. In *Vroom Journal*, April 23, vol iii. Accessed April 14, 2007 <<http://www.vroomjournal.com/articles/trimpin.php>>
- Vroom, Steven Michael. 2006. SHH Trimpin at Suyama Space. In *Vroom Journal*, May 5, vol iv. Accessed April 14, 2007 <<http://www.vroomjournal.com/articles/trimpinsu.php>>

The work of Trimpin is as accomplished technologically as it is artistically. The robotic guitars of *Roots and Branches* are among the most elegant robotic string instruments yet developed. And the subtle beauty—and utter simplicity—of a massive aluminum ball droning away in *SHHH* nearly overshadows the complex nature of the pulleys and motors that drive it.

Trimpin is a craftsman. He builds his instruments with the same care and precision as a watchmaker. But he approaches his projects with the aesthetic and perspective of a composer. Every motor, every solenoid, every gear must be chosen for efficiency and force—but if it does not add to the mechanical beauty of the work it is quickly discarded. The repetitive nature of the machine is thus circumvented, and an entirely new breed of robot is born with all the sensibility of a painting or a novel. Trimpin's craft is only trumped by his artistry.

| 47

In the world of robotic musical instruments, Trimpin is a jack-of-all-trades. Not content to create a single type of instrument, his work covers the full range of instrument types: membranophones, idiophones, piano players, plucked strings, aerophones, magnetic tape, etc. They are both analog and digital, acoustic and amplified. But they are all vaguely human, always attempting to draw us closer to the instrument, becoming both audience and performer.

5. _____ The New Pioneers

In the past 10 years the field of robotic musical instruments has seen unprecedented growth. It is easy to chalk this up to cheaper materials, open-source software, and readily available tools to design, build, and experiment with robotics. But that would completely ignore the incredible creativity of those blazing a new trail at the forefront of this field.

New Interfaces for Musical Expression, a conference held yearly since 2001, illustrates this growth well. The early proceedings contain almost no mention of robotic musical instruments. But since 2004, the number has increased steadily. In 2006 the proceedings listed at least 2 papers and one performance involving robotic instruments. And in 2007, the NIME Conference will feature robot design:

Harvestworks, NIME. 2007. *NIME 2007*. Accessed April 16, 2007 <<http://itp.nyu.edu/nime/2007/>>

NIME 2007 will include a special focus on Music & Robotics. Events related to this theme include a keynote speech by Trimpin, a workshop with several noted luminaries in the world of Music & Robotics, a series of LEMUR concerts (as part of the NY Electronic Arts Festival), and the solicitation of conference papers related to Music & Robotics.

48

To get a better overview of the current work in this field, I will examine a few important examples:

Eric Singer and the League of Electronic Musical Urban Robots (LEMUR)

Christine Southworth and Leila Hasan's Ensemble Robot

Gil Weinberg's humanoid robot *Haile*

Toyota's robotic trumpeter and marching band

League of Electronic Musical Urban Robots

Singer, Eric, et al. 2004. LEMUR's Musical Robots. In *Proceedings of the 2004 Conference on New Interfaces for Musical Expression (NIME 2004)*.

Singer, Eric, et al. 2006. *LEMUR: League of Electronic Musical Urban Robots*. Accessed December 12, 2006 <<http://www.lemurbots.org>>.

Eric Singer made a huge splash on the robotic instrument scene with the invention of his *GuitarBot*. Designed by the group League of Electronic Musical Urban Robots (LEMUR), this robot has four identical sections, each with a single string. The strings are plucked using a servo motor with four picks attached. Pitch is controlled by a sliding bridge using a servo and pulley system. The *GuitarBot* sounds much like a slide guitar. A solenoid damping system is used to stop the string from vibrating. The modularity of the system allows it to be used in different settings, either as a whole instrument or broken up into separate pieces.

LEMUR's other robots include the *TibetBot* (a set of three Tibetan bowls hammered with solenoids), *ForestBot* (a "forest" of long fiberglass rods with egg shakers at the ends, actuated by vibrating motors), and *lrBot* (a clamshell shaped instrument that opens to reveal a dense patch of Peruvian goathoof maracas). | 49

Lerhman, Paul D., and Eric Singer. 2006. A "Ballet mécanique" for the 21st Century: Performing George Antheil's Dadaist Masterpiece with Robots. In *Proceedings of New Interfaces for Musical Expression Conference 2006 (NIME 2006)*.

Lehrman, Paul D. 2006. Ballet mécanique at the National Gallery of Art. Accessed April 16, 2007 at the *Ballet mécanique page* <<http://antheil.org/NGA.html>>

More recently Eric Singer embarked on a project with Paul Lehrman (see section on George Antheil) to perform the *Ballet mécanique* entirely using robots. For this he designed several robotic bass drum beaters, xylophones with solenoid-driven mallets, and MIDI controlled sirens and propellers. The piece went on display at the National Gallery of Art in Washington, D.C. in 2006.

Ensemble Robot

Southworth, Christine. 2006. *Music and Robots: Designing Robotic Musical Instruments and Writing Music for Robots in Conjunction with Human Performers*. Master of Arts Thesis, Brown University.

Southworth, Christine. 2007. *ENSEMBLE ROBOT*. Accessed April 14, 2007 <<http://www.ensemblrobot.com>>

Southworth, Christine. 2007. Ensemble Robot: The Robots. *ENSEMBLE ROBOT*. Accessed April 14, 2007 <<http://www.ensemblrobot.com/robots.shtml>>

Another group at the forefront of robotic instrument design is Ensemble Robot, which was founded by Christine Southworth and Leila Hasan (both students at M.I.T. at the time). Along with several other robot designers, the group has built several musical bots and performed with them in such places as the Museum of Science in Boston (a performance that included the sound of the world's largest Van de Graaff generator, which belongs to the museum), the WIRED Magazine NextFest, and the Boston Cyberarts Festival.

Among their robots are:

Whirlybot, a tower of tuned "whirlies" that spin around its central axis. These tubes produce a sound "like a chorus of voices" that spans two octaves.

Heliphon, a vibraphone-like instrument that uses solenoids to hammer on metal keys.

Blobot, a tetrahedron-shaped set of pipes played by pumped air.

Beatbot, a woodblock played by a solenoid mallet.

Bot(i)Cello, a plucked string instrument with "three arms, each holding an electric guitar string on one end. The arms curl in and out like the petals of a flower, and as they move they change the pitch of the guitar string."

Gil Weinberg's Haile

Gil Weinberg and Scott Driscoll designed *Haile* at the Georgia Institute of Technology in 2005. This robot, a humanoid drummer with two solenoid-driven arms, doesn't quite fit into the category of "robotic musi-

Weinberg, Gil, and Scott Driscoll. 2006. Toward Robotic Musicianship. *Computer Music Journal* 30:4: 28-45.

Rowe, Robert. 2004. *Machine Musicianship*. Cambridge: MIT Press.

cal instrument,” since it is not designed to be played. Instead, it draws on several fields to create a sort of hybrid:

We have identified a number of research fields that relate to our attempt to achieve robotic musicianship. These fields are *musical robotics*, which focuses on the construction of automated mechanical sound generators; *machine musicianship*, which centers on computer models of music theory, perception, and interaction (Rowe 2004); and *rhythmic perceptual modeling*, which can be seen as a subset field of machine musicianship that bears particular relevance to our initial focus on percussion.

In this work lies one of the fundamental problems in musical robot design: at what point does the robotic instrument become a musical robot? Since nearly all modern robotic instruments are driven by computerized signals, what happens when the human player is taken out completely? Is a robotic instrument that is played by a computer still an instrument?

By Weinberg’s definition, a “musical robot” is simply an “automated mechanical sound generator.” This generalization is a good one: it allows for the distinction between the instrument and the means by which it is controlled (in *Haile’s* case, by a computer). In many cases, this allows for a robotic instrument to be controlled by any number of different controllers, and either by a computer or a human. This is an important concept to this thesis, and one that will be discussed at various points: how can we design new interfaces and mappings to allow for human musicians to interact with robotic instruments.

51

Toyota’s trumpet playing robots and marching band

Another great example of humanoid robots that play traditional instruments comes from Toyota. Their robotics research division has created a

trumpet playing robot, along with an entire marching band of similar design.

This robot is designed as a human companion robot, one that might one day live alongside people in their homes. There are currently two models, one with legs and one that moves using wheels.

Unfortunately the details of how these robots function is not publicly documented, since these robots are intended as possible commercial products. But several reports on them exist, from which we can glean the following information.

Kara, Dan. 2004. Industry Shorts - Personal: Toyota Gets in the Game. *Robotics Trends*. Accessed April 16, 2007 <<http://www.roboticstrends.com/displayarticle365.html>>

The robot uses a set of artificial lips that are filled with air. As air pressure rises, the pressure between the two lips increases. Air flowing through the lips functions much like air in a trumpeter's mouth, causing the lips to vibrate at various modes. The robot has three fingers that can press the keys of the trumpet to play notes.

| 52

Other robots

There are, of course, many other robots to consider, but they are too many to detail here. For an excellent overview of the field, see

Kapur, Ajay. 2005. A History of Robotic Musical Instruments. In *Proceedings of the International Computer Music Conference 2005 (ICMC 2005)*.

The Marshall Field's Flower Show represents my earliest work with robotic instruments, in this case the Yamaha Disklavier. The show, which took place in the downtown Minneapolis Marshall Field's department store, allowed the public to wander through the sounds of the south of France, with music coming from various installations of interactive instruments.

Chapter 2 — The Marshall Field's Flower Show

In March of 2005 I embarked on what would be my first experiment with robotic music. The Marshall Field's Flower Show, called *Music in the Garden*, which took place in the downtown Minneapolis Marshall Field's department store, was a public installation that included several interactive instruments along with prerecorded sounds, both ambient and showcased. Of these instruments and sounds, I was directly responsible for a set of interactive touchpads designed to control the music playing through a Yamaha Disklavier. In this chapter I will discuss my work at length, and also briefly describe the work of my colleagues, Diana Young and Roberto Aimi, on this project. | 53

1. ————— Project overview

Each year, as part of a yearly series of installations, the downtown Minneapolis Marshall Field's department store (now a Macy's) presents a spring flower show in conjunction with Bachman's (a Minneapolis-based



Fig. 2.1: A cello sculpture made of plants greets visitors at the entrance to *Music in the Garden*

Photo by Mike Fabio

chain of garden suppliers). In late 2004, the organizers at Marshall Field's approached my advisor, Tod Machover, about integrating a musical installation into the show.

Working directly with the landscape architect, Julie Moir Messervy (an M.I.T. alumna), we designed a large-scale, interactive musical experience based around the paintings of Picasso and Dufy of the southern coast of France. With this musical theme in mind, we began matching areas of the garden to different types of sounds.

As the audience entered the auditorium, they were forced to walk through a long hallway. This hallway often contained the queue to get into the theater. To keep the audience occupied while they waited, we created an ambient mix of sound to play through loudspeakers throughout the hallway. Much of thematic material inside the auditorium appeared in small glimmers of sound in the hallway, mixed with the sounds of ocean waves and birds.

Upon entering the auditorium, the audience first glanced a massive, abstract cello sculpture in the style of Picasso made of plant material. To accompany this, loudspeakers played droning cello sounds along with bird calls and other similar material.

MUSIC IN THE GARDEN

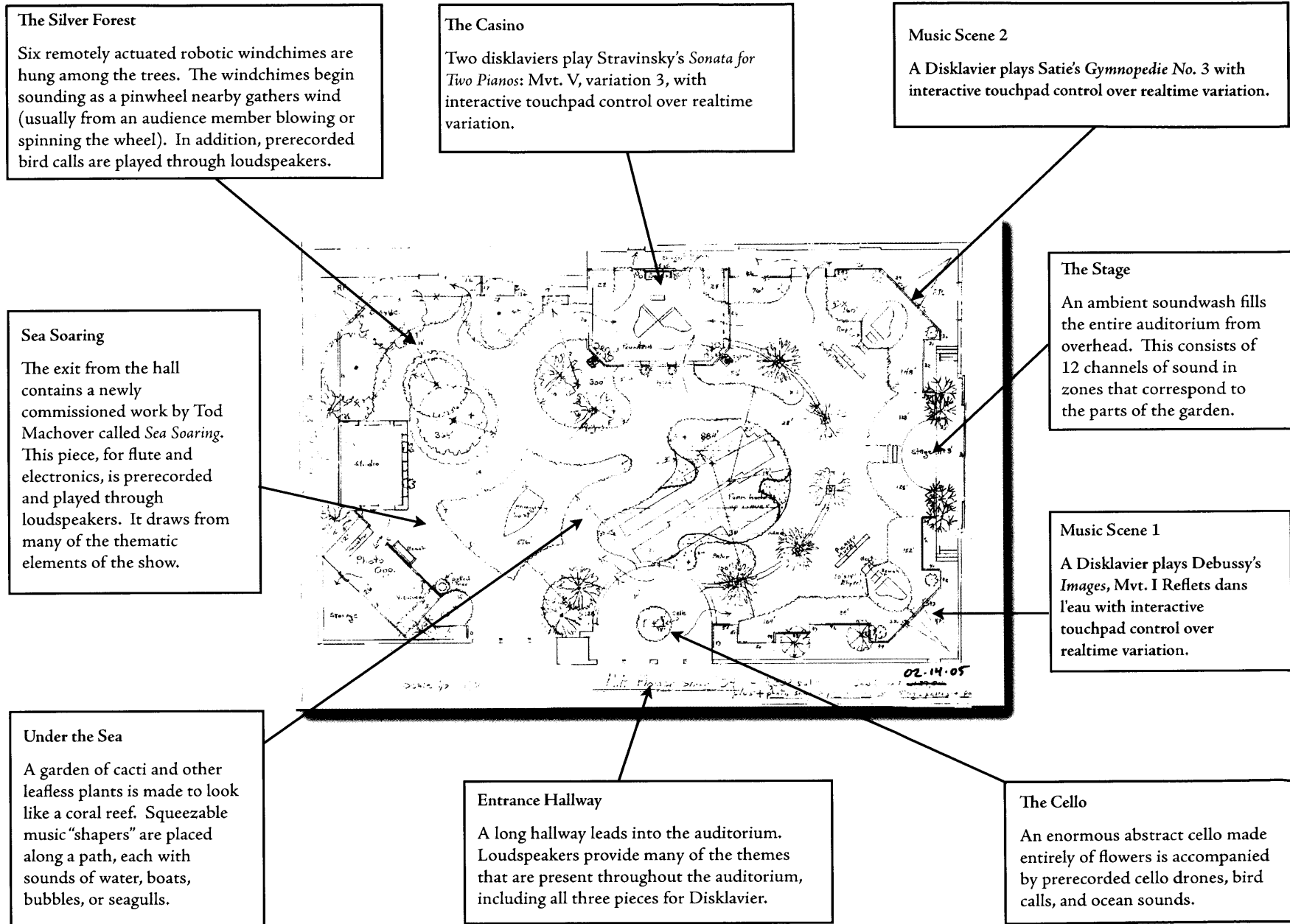

FIG. 2.2



Fig. 2.3: A child plays a musical “shaper” in the “Under the Sea” section

Photo by Mike Fabio



Fig. 2.4: A pinwheel controls a robotic windchime in the “Silver Forest” section

Photo by Mike Fabio

The visitors then encountered the first of four Yamaha Disklaviers with interactive touchpad controllers. The Disklaviers, engulfed by flowers and other plants, played famous pieces by Debussy, Satie, and Stravinsky. The audience could manipulate these pieces by pushing their finger against an electronic touchpad controller. Movements on the touchpad were translated into variations in the music, but when the finger was lifted the piano would “snap back” to the original piece. The final piece by Stravinsky incorporated this system with two synchronized Disklaviers, each playing one part of a duet. Two visitors at a time could play this system.

As the visitor continued through the space, they would encounter more sounds. Overhead, a massively multichannel speaker array played up to 12 different sounds. The speakers were zoned roughly so that the different areas of the garden would receive different sounds.

Further on, the audience entered the “Silver Forest,” made largely of trees, both evergreen and deciduous. Hidden among the trees were six robotic windchimes, designed by Diana Young. These windchimes would actuate when a nearby pinwheel began spinning. Audience members could blow into the pinwheel to activate the chime sounds, a sort of electronically transmitted wind. All around loudspeakers played sounds of birds, bouncing through the trees.

A garden near the center of the auditorium was called “Under the Sea.” This garden featured cacti and other leafless plants and rocks that resembled a coral reef. A path ran along this garden containing six musical “shapers,” a squeezable toy designed by Roberto Aimi. The audience was

encouraged to squeeze these toys, activating different sounds through a loudspeaker at its base. Sounds included underwater bubbling, creaking boats, ocean waves, filtered birds and seagulls, and other familiar water sounds.

Near the exit the audience heard a new piece, *Sea Soaring*, composed by Tod Machover. This piece, scored for flute and electronics, was pumped through loudspeakers as a culmination of all the preceding sounds.

In all, *Music in the Garden* was intended to bring an otherwise static garden to life, creating an interactive experience for the audience that would rival a prerecorded exhibit.

2. _____ Variations on a Theme: Designing Interactive Disklavier Applications for Public Installation

| 57

The Yamaha Disklavier player piano is a highly sophisticated robotic instrument; most people today have never even encountered one, let alone played it. It was with this in mind that I began my work in designing an interactive application for the Disklavier that would allow anyone, with no musical background whatsoever, to play this instrument using only a simple touchpad.

The Disklavier

The earliest models of the Yamaha Disklavier date to the early 1980s. The Mark I (as it was called) was a poorly designed instrument, capable of playing back many pieces of music but not designed for wear and tear



Fig. 2.5: A Yamaha Disklavier Mark IV. Barely visible under the left side of the keyboard is the control unit.

Photo by Mike Fabio.

or any more sophisticated uses. By the time Yamaha released the Mark II instruments, though, the Disklavier had finally found a niche with computer music creators; it represented a quantum leap ahead of all other MIDI controlled player pianos on the market.

For *Music in the Garden*, I used several newer models of the Disklavier, including the Mark III and Mark IV models. These instruments have certain differences that make them suitable for varying purposes.

The Disklavier Mark III is, in my opinion, the easiest to use of all the Disklavier models. Beneath its keyboard is a control box with a two-line display and numerous control buttons. Through this interface, many of the features of the Disklavier can be accessed.

The Mark IV instrument, on the other hand, uses a WiFi enabled portable device as its interface. The control box, which still resides under the keyboard, has no display and only a single power button.

58

There are several issues with the Mark III and IV instruments that are worth noting:

1. There is a feature on all Disklaviers that delays all MIDI input by 500ms in order that notes of varying velocities can be compensated for. For instance, a MIDI note with velocity 50 will send the hammer into motion much slower than a MIDI note with velocity 127. The slowest note (theoretically a note with velocity 1) takes quite a bit of time to hammer the string, and thus the delay of 500ms allows an incoming MIDI stream to be outputted accurately. Unfortunately, this delay makes realtime control of the MIDI stream difficult: a human can easily recognize a lag time of 500ms between an input gesture and the outputted sound. The Mark

III model allows this feature to be easily turned off, whereas the Mark IV does not (a representative from Yamaha told me that the feature had been implemented, but the interface could not yet turn it on or off). Therefore we decided to use the Mark IV pianos for the Stravinsky piece, where accurate timing was absolutely necessary in order to sync the two pianos, and to use the Mark III pianos for the Debussy and Satie pieces, where syncing was not an issue and faster control was desirable.

2. The hammering mechanism of the Mark IV uses servos instead of solenoids, providing a much smoother response. These pianos are capable of playing a much wider dynamic range than the previous models, allowing for the input of softer notes. It became necessary to compensate for this deficiency in the Mark III models, especially for Satie's *Gymnopedie No. 3*, which contains several pianissimo sections.
3. When operated for long periods of time, the Mark III models can overheat. When this occurs, the piano shuts itself down and must be rebooted. This unfortunate feature made it difficult to install in the music garden, since the pianos would be left running all day. I was able to make some changes to the software, however, to compensate for this problem. I did not experience this problem with the Mark IV.
4. Both models of Disklavier have a feature called a silence bar. When activated, the silence bar prevents the hammers from hitting the strings. When this happens, the keys continue moving, but no sound is heard. This became a problem as visitors would press the silence button, and the installation attendants would not understand what the problem was. In order to solve this problem, we simply moved the Disklaviers out of reach of the audience.

Despite all of these problems, the Disklavier is a viable and useful tool for public installation. It has a truly beautiful sound that is much brighter than a Steinway, for instance, and they are visually stunning instruments as well. The baby grand models that we used for *Music in the Garden* easily filled the entire auditorium with sound. And since the instrument responds to General MIDI, writing software to control it was quite easy.

The Mercurial STC-1000 Touchpad

The Mercurial STC-1000 touchpad is a pressure sensitive pad not unlike a laptop trackpad. It has MIDI input and output, and can be programmed to function in various ways. It is built to be used as a musical controller, and many of its functions are designed as such.

The pad area has 16 square divisions printed on its face. Each of these zones can be programmed to perform different tasks. For instance, it is possible that each zone can send a MIDI note, allowing the pad to be used as a 16-note drum controller. Or zones can be combined to function as faders for sending continuous control. All of these functions are programmed using external software, and sent via MIDI to the STC. Programs can be stored in its internal memory.

For our purposes, we were looking for an XYZ touchpad that could output the position of the user's finger as well as the amount of pressure he was using. Unfortunately, after investing in several of these pads, we found that they were not capable of outputting absolute position. Rather the device functioned much like a computer trackpad, where motion of the finger would change the value of the output. In the end, this worked

I am unsure whether the STC-1000 is still in production. There is some older information available at Mercurial Innovations' website

<http://www.thinkmig.com>

as well as a somewhat devoted community of users at

<http://www.stc1000.com>

This community site was invaluable during the design phase of this project.

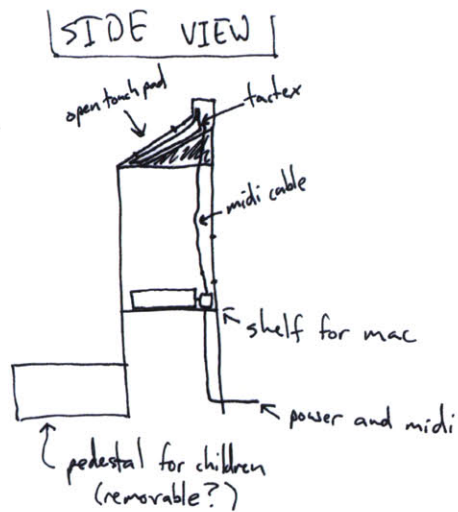

Fig. 2.6: Original sketch of pedestal design.



Fig. 2.7: The completed pedestal.

Photo by Mike Fabio

to our advantage: it actually shaped the way the mappings are programmed.

The pressure sensitivity of the device is useful, but slightly flawed. It seemed to register soft touches just fine, but in order to put out a MIDI controller value of 127 required quite a bit of force. This problem eventually remedied itself: in the end I didn't use the pressure sensing at all.

Creating a display for the installation

For this installation we designed a pedestal on which the touchpad controller could sit and be easily played by visitors. The final design of this pedestal allowed the STC-1000 to be safely mounted so that users could not fiddle with its knobs, but could only touch the pad. Inside the pedestal was a space for storing the control computer, the MIDI interface, and cables.

Getting from here to there: the interactive software

The goal of the project was simple: create an engaging interactive musical experience for any audience, regardless of musical skill or background. In order to accomplish this, the project needed to meet certain criteria

1. The audience must understand the relationship between input and output. Gestural input must therefore translate to obvious and meaningful musical data.
2. There must be no barriers to input. The system must allow input from any person with no special skills necessary.
3. The output must be aesthetically pleasing, regardless of the input.

The first two criteria are easier to accomplish than the third. But the key to the final requirement is in allowing complete control over specific parameters while simultaneously limiting the range of possible outputs. This fundamental problem, that of *mapping*, is one of constant debate in the computer music realm.

| 62

Winkler, Todd. 1998. *Composing Interactive Music*. Cambridge: MIT Press. 6.

The term mapping has long been a central focal point of creating computer music. Todd Winkler, in his seminal book, *Composing Interactive Music*, defines the term broadly as “having a computer interpret a performer’s actions in order to alter musical parameters.” Interpretation is, of course, the important term to consider, and in this term the definition breaks down.

Computers on their own tend to be interpretive devices, taking in data and turning it into other data. Musicians similarly expect that repeating an action will output the same results each time. It is therefore expected

of computers, when placed between a human musician and a musical output device, will do the same, producing a similar output each time a given input is repeated.

Sadly, though, this type of behavior ignores the possibilities of the computer to stand as its own artist. Marc Downie, in his fascinating thesis on using artificial intelligence techniques to give computers *creativity* in computer graphics and dance interaction, debunks the computer-as-translator definition:

Downie, Marc. 2005. *Choreographing the Extended Agent: performance graphics for dance theater*. PhD. Thesis, Massachusetts Institute of Technology. 34.

Marc also points to an interesting discussion on this matter in:
Chadabe, Joel. 2002. *The Limitations of Mapping as a Structural Descriptive in Electronic Music*. In *Proceedings of New Interfaces for Musical Expression Conference 2002 (NIME 2002)*

The term “mapping” is clearly outliving its usefulness and its predictive and explanatory power has long left us. If this “map-ism” is deployed as a metaphor, what does it metaphorically connect with? Are there interesting physical systems that are satisfactorily read in this way? Do any of the natural analogues that researchers are also interested in map anything? what part of a flute transforms concrete, quantized measured data? what part of the audience manipulate a stream of readings? If we are interested in *interaction*, why start with a formula that goes only one way? If it is only a metaphor, why then is it embodied directly in *data-flow* interfaces and underlying architectures of common digital art tools? The agent metaphor, developed in this thesis in a manner of particular use to art-making, stands directly opposed to mapping in this most banal sense; and I believe it to be of more use than the term in its more diffuse applications.

63

Still I contend that there are many cases in which the traditional definition of mapping is not only relevant but necessary, in particular the case of public installation art. As I will attempt to show, the first criteria I describe above, that of having demonstrable input/output relationships, is most easily achieved through the use of one-to-one mappings.

The real culprit for all this confusion is truly the word “interactivity.” It would seem that the term literally means the activity between two entities. And perhaps in this sense Downie is right: mapping implies a one-way street, and thus cannot truly create interactivity. But I would posit that interactivity can exist even with a one-way mapping, since a literal one-to-one translation still produces musical feedback to the player from which subsequent actions can be based. At first the system appears to have only one direction.

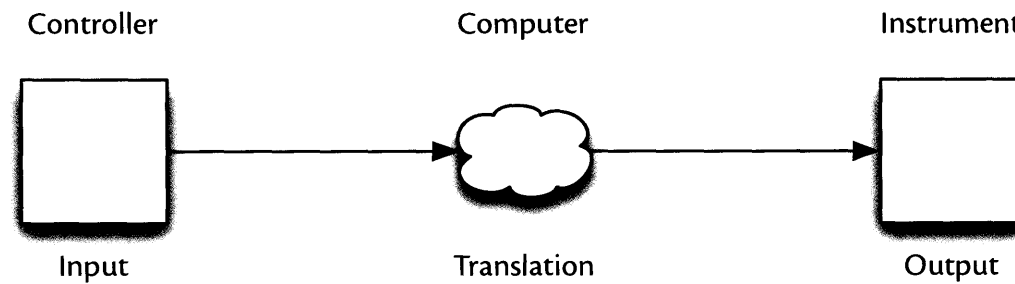

Fig. 2.8: Interaction flow, 1.

But on closer inspection we find that this is still an interactive system, since the outputted sound directly influences the player’s subsequent input. As Winkler writes, this is “somewhat analogous to the distinct activities that take place during a jazz improvisation or other musical dialogue: listening, interpreting, composing, and performing.” The updated model, then, is more accurately represented as:

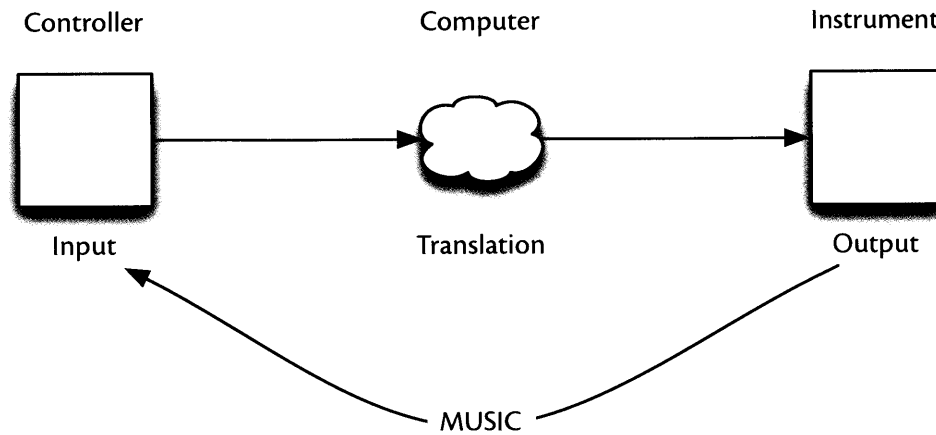

Fig. 2.9: Interaction flow, 2

With this model in mind, I began work on the software system to control the Disklaviers.

I decided early on that I would write the software using MAX/MSP (though I would not need the MSP extensions). I will not argue the merits of MAX/MSP, as that has been done at length elsewhere. I chose the language for two reasons. First, I was already well versed in writing MAX patches. And second, for handling MIDI data there are few systems as easy to use.

A first attempt

The first attempt at writing this software turned up a disaster, though the concept would eventually morph into the final version. I began with the

concept of a 2-dimensional field, much like the touchpad I would be using. Each corner of the square field would be mapped to a single piece of music. As the user moved his finger on this field, each piece of music would vary in volume based on the distance of the input point to that corner.

This relationship is explained by the basic geometric distance formula

$$d = \sqrt{(x_2 - x_1)^2 + (y_2 - y_1)^2}$$

Since MIDI deals largely with a resolution of 6 bits, it is easiest to imagine all our ranges within 0 to 127. Therefore, I assigned values to each of the corners as follows:

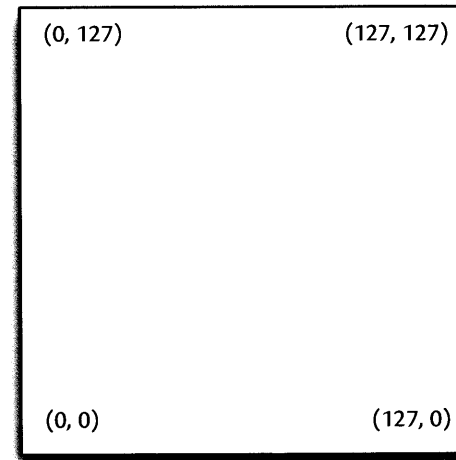

Fig. 2.10: Touchpad layout, 1

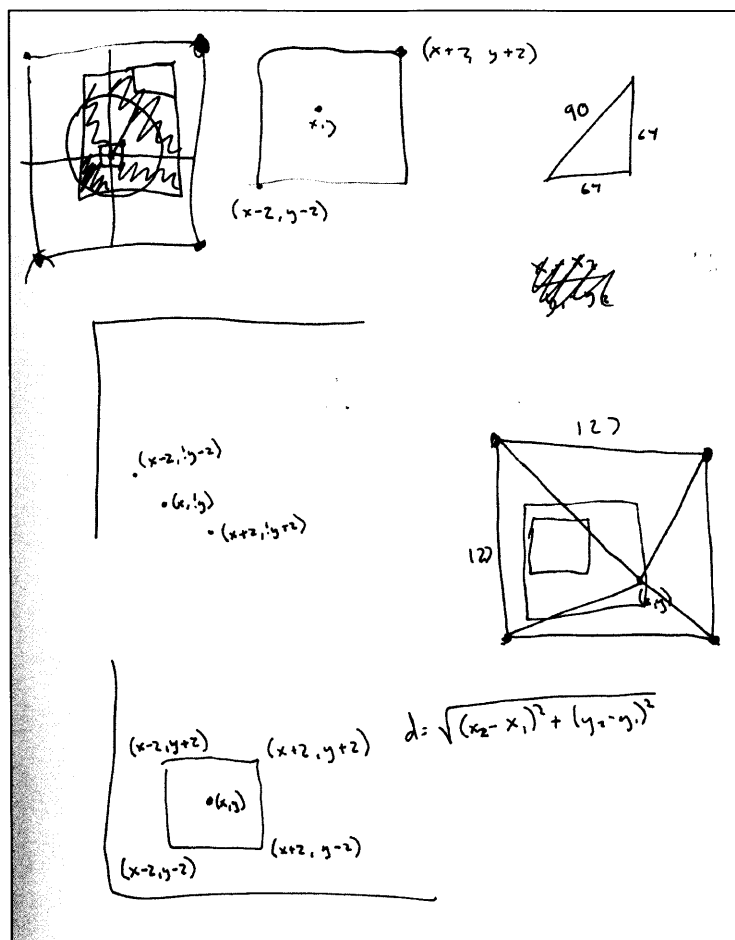

Fig. 2.11: Some early sketches for the interaction.

This arrangement corresponds to the outputs of the STC-1000 touchpad (or so I believed, as we shall see). The distance of the input point is then used to scale the volumes each of the four pieces of music, a sort of multi-point crossfader.

This model is inherently flawed in a number of ways. The first, and perhaps fatal, flaw is the use of different pieces of music at each corner. These pieces may be different in length, tempo, relative volume, tonality, tonal center, harmonic language, etc., and therefore do not mesh well without drastically altering them to fit together.

The second major flaw lay in the behavior of the STC-1000 trackpad. As I described earlier, the trackpad does not sense absolute position of a finger on the pad, but rather the relative position based on movement of the finger. Since there would be no visual representation of the current data point (i.e. no graphical display), it would be impossible to determine where the input point was at any given time. If the point was currently at one of the outer boundaries, for instance, a movement in that same direction would cause no change in the output. A new solution was needed.

A second attempt

It quickly became apparent that each piano should play only a single piece of music, with the controller adding variation to these pieces. We decided to use three pieces:

1. Claude Debussy's *Image, Premiere Livre*, mvt. 1 Reflets dans l'eau
2. Erik Satie's *Gymnopedie No. 3*
3. Igor Stravinsky's *Sonata for Two Pianos*, variation 3: Moderato

Tod Machover, my advisor, composed four variations on each of these pieces (or eight in the case of Stravinsky, four for each piano part). Each of these variations would be placed at the corners of the square. Variations might include such musical ideas as bass register transpositions, harmonic dissolution, high register “tinkling”, or rhythmic extraction.

This allowed for a workaround to the problems with the STC-1000 controller. I programmed the firmware on the device to “snap back” to the center of the square. This way, whenever the user lifted his finger from the pad, it would return to an output value of (63, 63), (the center of the pad). By placing an extra mapping point at the center, the mapping worked as follows:

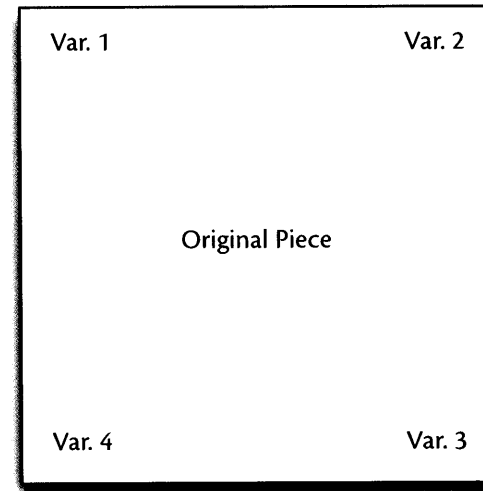

Fig. 2.12: Touchpad layout, 2

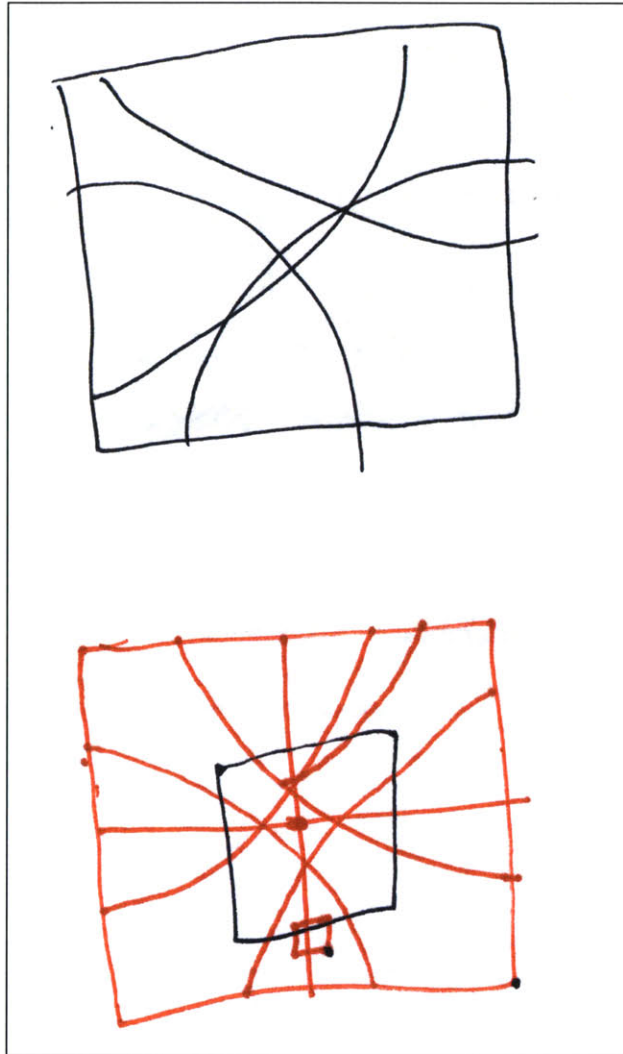

Fig. 2.13: More interaction sketches. Note that these sketches begin to resemble the five-zone system.

With no input on the pad, the original piece would play through until the end, at which point it would restart at the beginning. At the same time, each variation played in sync with the original. The user was instructed to place his finger at the center of the pad and push away toward the corners. As the finger neared any corner, that variation would become louder (MIDI note velocities increase) while the original would fade out (MIDI note velocities decrease). A user could also move from the center to a variation and then to another variation. In this way the pad is divided into zones as follows

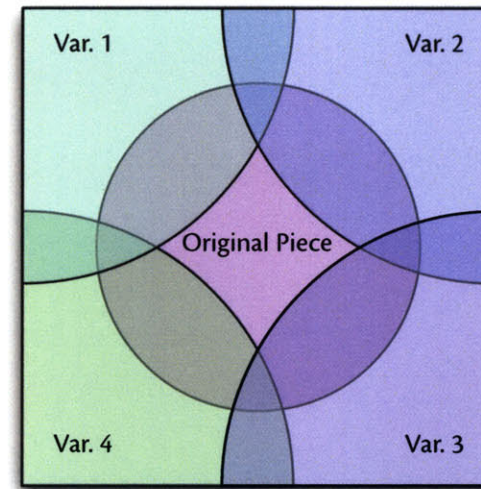

Fig. 2.14: Touchpad layout, 3

As the user moves beyond any of the thresholds, the velocities of that variation drop to 0 (this is equivalent to a MIDI note off, and thus the

Disklavier will not play anything). This arrangement allows for up to three different sequences to be played simultaneously.

A third attempt

In order to gain an extra level of control, I decided to implement a feature where increased pressure on the touchpad would correlate to an inclusion of more sequences. Graphically, this system would appear as

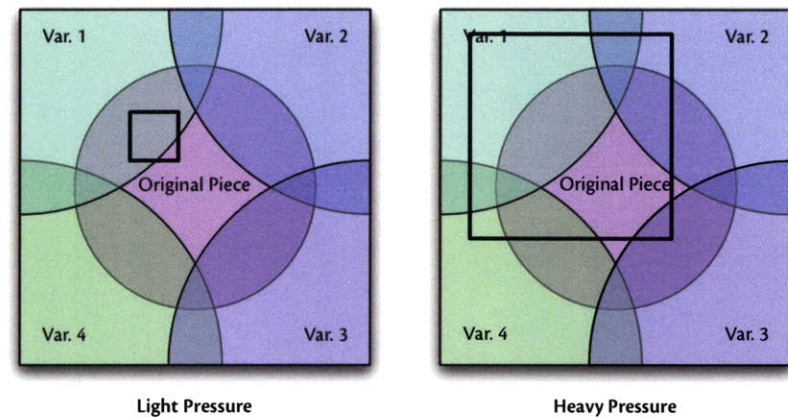

Zone velocities are interpolated based on the corresponding corners of the input box. For instance, Variation 3, which is in the lower right corner of the pad, is controlled by the value of the lower right corner of the input box.

The advantage to this system is, of course, that all five sequences can be played simultaneously, creating far more possible variations. Pressing

strongly at the center of the pad could even invoke all five sequences at their maximum velocities.

The final version

As I was developing this software, I did not yet have access to a Disklavier. Instead I outputted MIDI to a high quality software sampler of a piano. And while this gave me a good idea of how the software might function, it could not exactly emulate the real-world behavior of a Disklavier. As such, several modifications were made to each of the pieces. These changes were made just days before the exhibit opened: it was only then that I could test these patches with a real Disklavier.

In the end I abandoned the pressure sensitive mapping on all the pianos. This decision was largely due to the cacophonous sounds the Disklavier made when playing back five sequences simultaneously. The mappings became utterly unclear when played through a real piano. In addition, the Disklavier is only capable of 16 notes of polyphony. Playing five sequences simultaneously would overload this, and only some of the notes would be played (though it was unclear which notes would take precedence).

Each piece also called for specific changes. The Stravinsky piece, which is highly rhythmic in nature, called for changes to be as instantaneous as possible. As a user moves from one zone to the next, the change should be clear and obvious. To achieve this, I rezoned the square such that overlaps were as small as possible. I also adjusted the crossfade curve so

that moving between zones would cause the original sequence to fall off quickly and the new sequence to come in quickly.

For the Satie piece, which is languid and flowing, it was desirable to have several sequences overlap. I zoned the square with large overlaps, and adjusted the crossfade curve to move gently between zones. In addition, I implemented hysteresis in the system, such that it was possible to transition between multiple zones. If the user moved quickly between many zones, it was actually possible to make all five variations audible. In this software, the original piece remains unaltered regardless of input.

The Debussy piece was tricky in that it contains several distinct sections, each with a slightly different character. In order to achieve the “best of all worlds,” I stuck with the original concept, a gradually crossfading system, with medium overlap and no hysteresis.

A look at the software

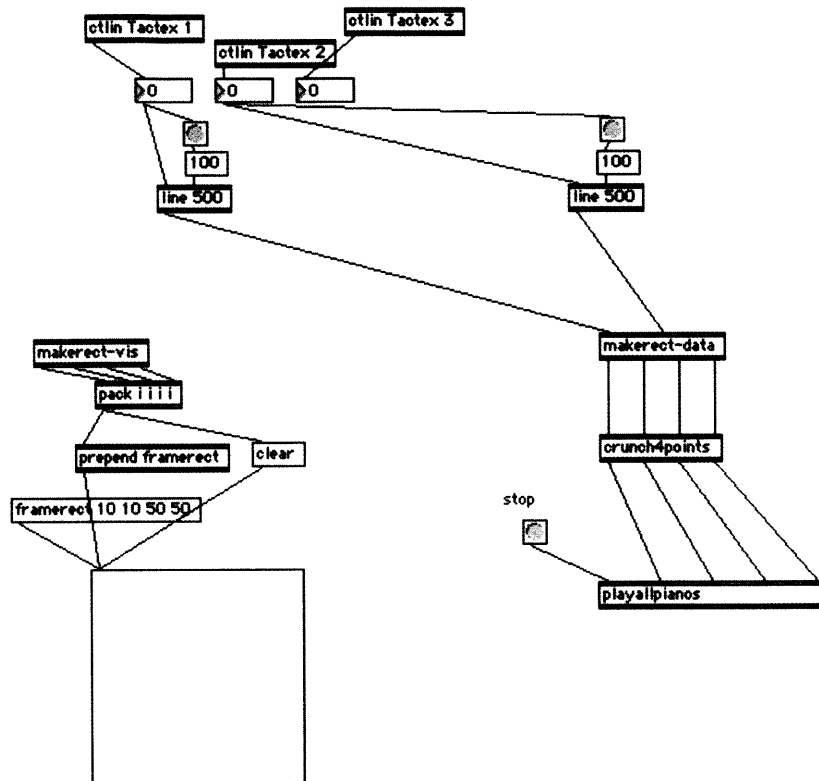

Fig. 2.16: Disklavier MAX patch

Figure 2.16 shows a screenshot of the software for the Satie piece, *Gymnopédie No. 3* (each piece is slightly different, but key functions are the same). So there is no confusion, here are a few pieces of MAX/MSP terminology:

1. Every box on the screen is an “object.” An object can be any of several things: a function, a hardware interface, or a user interface element. I will try to be clear about what each object is as I explain it.
2. MAX is a data-flow language. Data moves through “cables” that connect objects. In general data flows from top to bottom, and from right to left.
3. Data flows in to an object’s “inlets,” and out through an object’s “outlets.”

At the top of the screen is the hardware input from the STC-1000 touchpads. X, Y, and Z (pressure) values come into the computer as MIDI controller values using `ctlin` (the controller name, `Tactex`, is a holdover from the previous manufacturer of these pads). The third controller value (pressure) goes nowhere (as I stated earlier). The X and Y values run directly into a `line` object. This object smoothes spikes and gaps in the data input. Data is then fed into a custom object, `makerec-data`.

The `makerec-data` object was originally used to create the the box shaped input. Since this function was no longer necessary, I simply detached the pressure value from the far right inlet of the object. With pressure at a constant of 0, the four outputs of `makerec-data` are all the same value.

Data then passes into another custom object, `crunch4points`. This object determines the velocity scaler value for each of the four variations based on the distance of the input value from the corners.

Finally, the scaling values are passed into `playallpianos`. This object plays back all five MIDI sequences in sync, looping when the end of the piece is reached, and scales the velocities of every note based on its inputs.

At the lower left portion of the screen is a set of objects used for debugging hardware input. They are simply used as a visualization tool for the incoming data. None of this software is ever seen in the installation.

3. _____ The Big Show: Observations and Thoughts

Music in the Garden opened its doors to the public on March 12, 2005. The show ran for two weeks, during which I remained on call to handle technical problems, broken equipment, or anything else that might prevent a spectacular experience. Of course, I also used this opportunity to take notes and observations. | 74

The museum quandary

The most pronounced observation I made during the show was the varying levels of participation, in particular among different age groups. I like to call this *the museum quandary*: when experiencing interactive art, many audience members are unable to shed their inhibitions and actually *use* the artworks. Having been raised to “look but don’t touch” in museum settings, it is often difficult for many people to approach these works.



Fig. 2.17: Young children at the Debussy station

Photo by Mike Fabio

But even more startling than this observation was the apparent differences between visitors of various age groups. I immediately noticed that the visitors that were most likely to engage with the art, to spend some time with it and enjoy it, were the very young and very old. Children under 10 quickly took to the installations, and would often spend several minutes experimenting with them in an attempt to figure out how they worked. Similarly, patrons older than, say, 70 would also invest themselves in the exhibits. Sadly, it would seem that the vast majority of visitors were content to either stand aside and watch someone else play, or to “poke” at the installations, literally and figuratively; many visitors to the Disklavier stations would place their finger on the touchpad and do nothing, then leave the station believing it was not working. To counteract this behavior, we placed placards on each station encouraging the audience to move their fingers around the touchpads, but I did not notice a change in behavior.

75

I did find, however, that when I stood near a station and explained its behavior, many people would crowd around. I believe this is partly due to a general fear of technology. For many people, approaching technology is difficult because they simply cannot understand it. Rather than experiment with the technology and risk damaging it, it is easier to simply not touch it. But when there is a teacher nearby, someone to guide, this barrier is dropped.

Dealing with musical literacy

After convincing visitors to use the technology, I observed varying degrees to which the audience understood, from a musical perspective, the

exhibit. There are two explanations for this: first, it may be that the underlying technology is not effective enough at transforming simple gestural information into meaningful music; and second, it is possible that participants with little musical background are unable to discern *musically* what their gestures accomplish.

On the one hand, I must state that the relationships between the variations composed and the original pieces were sometimes difficult to discern, even to the trained ear. In some variations, the harmony and rhythm of the original were all but discarded. In other variations there may be extremely obtuse melodic motion, whereas the original piece contained much more melismatic and flowing movement. Therefore, as the pieces are combined through the system, the juxtaposition becomes increasingly complex and difficult to understand.

I attempted to address this problem by using the simple crossfading algorithm described earlier. Although I never attempted other interpolations, such as note-picking or harmonic adjustment, I believe this technique to be successful, especially in a public context. To account for untrained ears, it is necessary to not overcomplicate things. By simply layering the pieces, it is possible for even an untrained ear to hear the ties between the original piece and its variations. However, given another chance, I would certainly experiment with other methods of interpolation, and other methods of interaction as well.

But no interpolations or interactions can account for varying degrees of musical literacy. Literacy is perhaps the biggest roadblock to interactive art, especially as it deals with computer generated art. While it must be

said that I would prefer the music to stand on its own merits, to transcend simply understanding the technology or understanding the music and appreciate it on its own terms, musical literacy is still a factor.

In my observations, those users with some musical background were engaged for longer periods, and provided more feedback and creative criticism (though not always positive), than those with little musical training. Many musically trained users asked me specific questions about the algorithm in use, the interactive design, hardware and software. And many of them engaged me in thoughtful discussion of the music *and* its variations. I even had the opportunity to play with many of the audience members (at the Stravinsky piano duet station), and found many of them to be quite adept players: dare I say virtuosic?

A disclaimer

This installation in no way constitutes a controlled scientific experiment; that is not the nature of the thing. But nevertheless, many of the observations and experiences from this project came to play a big role in my ongoing work as well as my own personal philosophy on interactive music.

It is my firm belief that interactive electronic music is an enabling technology, that it can bring joy and entertainment to all people, regardless of their background, abilities, or impairments. Though much work needs to be done in this field still, I believe that we are on the right track.

Jeux Deux is a work for hyperpiano, orchestra, and live computer graphics, written by Tod Machover with computer graphics by Marc Downie. It was premiered June 1, 2005 by Keith Lockhart and the Boston Pops, with Michael Chertock, hyperpiano. The work explores the relationship between a live pianist and a computer pianist, each playing on the same Yamaha Disklavier. Literally translated: a game for two.

Chapter 3 — *Jeux Deux*

The nature of interaction, as we have seen, is awash with philosophical polemics. In a digital world, the term has taken on new meanings, yet there is still no clear definition of what is or is not *interactive*. My own experiences with public installations, for instance, differ greatly from, say, the sound sculptures of Trimpin, where the audience is not asked to directly alter the composition, but rather is invited to walk among the sound-making devices, becoming at once a spectator and a vital part of the sculpture itself.

78

In a performance setting, interaction takes on yet another meaning. The relationship between audience and performer is more clearly defined, and thus most interaction occurs from performer to performer, rather than performer to audience. Traditionally this interaction occurs between human players, but it is increasingly common for human players to be accompanied by computers.

There are obvious exceptions to this, especially in the growing study of audience participation. And indeed most performers, of any kind of music, will state the importance of a receptive audience in shaping their playing.

The concept of hyperinstruments, developed at the MIT Media Lab, is explained in Machover, Tod. 1992. *Hyperinstruments: A Progress Report 1987-1991*. MIT Media Laboratory. Accessed April 19, 2007 <http://www.media.mit.edu/hyperins/hyper_rprt.pdf>

This chapter outlines my work developing computer software for *Jeux Deux*, a composition by Tod Machover for hyperpiano, orchestra, and live computer graphics (by Marc Downie). In this work I experimented with various modalities for interacting with a MIDI controlled player piano, and giving the computer not only the ability to transform the music of the player, but also the ability to perform on its own.

1. _____ Playing with Machines/Machines that Play: How a Computer Understands and Generates Music

Rowe, Robert. 1993. *Interactive Music Systems*. Cambridge: MIT Press.

For a more thorough description of these types of interaction, I cannot highly enough recommend Rowe, Robert. 2004. *Machine Musicianship*. Cambridge: MIT Press.

Robert Rowe has been a leader in the field of musical interaction for quite some time. In his early work, *Interactive Music Systems*, he states that “The responsiveness of interactive systems requires them to make some interpretation of their input. Therefore, the question of what the machine can hear is a central one.” Without again entering into debate over the term interaction, let’s take a look at the second part of this statement. Rowe implies that a machine cannot in fact do any interacting at all if it cannot *understand* what is being played by any other player (interestingly, this other player could be another computer). Let us then take a look at some common techniques for allowing computers to understand, interpret, and create music.

79

Audio analysis

By far the most challenging aspect of machine listening is audio analysis. It is challenging not only because the mathematical and computational research are as yet incomplete, but because this research often fails to account for what the information means *musically*.

Jehan, Tristan. 2005. *Creating Music by Listening*. PhD. Thesis, Massachusetts Institute of Technology. 27-8.

Cheveigné, Alain de, and Hideki Kawahara. 2002. YIN, a fundamental frequency estimator for speech and music. In *Journal of the Acoustical Society of America*, 111:4 April.

Many musical features can be extracted from audio: pitch, timbre, periodicity, spectral makeup, rhythm (beat detection), tempo, etc. And recent advances in computing speed allow many of these features to be analyzed at near real-time, making them useful for interactive systems. By extracting certain features, computers can understand incoming audio at the musically symbolic level.

As an example, let us look at pitch analysis. In the time domain, it is possible to extract the periodicity of a waveform, which, inverted, gives the frequency of the sound. Primitive pitch detectors used zero-crossing detection to achieve this, but these systems tended to be inaccurate (although computationally simple). Newer systems, such as the YIN algorithm, use a statistical measurement called autocorrelation to effectively guess the pitch of a sound. Again though, these systems are inaccurate, and sometimes computationally intensive.

Today most computer pitch detection algorithms use frequency domain analysis. By converting incoming audio into its frequency domain equivalent, it is possible to statistically extract the fundamental pitch (as well as many other features). Common implementations of this system are Miller Puckette's *fiddle* and Tristan Jehan's *pitch* externals for MAX/MSP.

Audio analysis systems are flawed in many ways. First, they are notoriously inaccurate, making them unreliable for live performance. Second, they are computationally intensive, requiring modern machines to carry out the most complex algorithms. And finally, they are difficult for most musicians to understand, especially those with limited computer skill.

Therefore, I looked to other methods of interaction when designing *Jeux Deux*.

MIDI and the Disklavier

In the mid 1980s, the musical instrument digital interface, or MIDI, was invented as a way to transfer symbolic information about music to and from electronic music devices. MIDI has proved itself an invaluable tool in much of my work, and *Jeux Deux* is no exception.

The Yamaha Disklavier has two very distinct lives: it is both a player piano and a robust MIDI controller. That is to say that it can not only receive MIDI and playback notes, but it also sends MIDI when played by a human. These features are critical to the design of *Jeux Deux*, where it is necessary to both send and receive MIDI data from the Disklavier.

| 81

Keeping score

Vercoe, Barry and Miller Puckette. 1985. Synthetic Rehearsal: Training the Synthetic Performer. In *Proceedings of the International Computer Music Conference 1985 (ICMC 1985)*.

The most important musical interaction in *Jeux Deux* is score following. Score following is not a new concept, by any measure. One can cite any number of examples, such as the synthetic performer by Miller Puckette and Barry Vercoe or the early hyperstring work by Tod Machover. These implementations suffered from unnecessary complexity, using pitch detection, extra-musical input, or computer operator input to follow along with a piece of music.

There are many MIDI score following implementations available, including Miller Puckette's *detonate* and *explode*, and IRCAM's *Suivi*.

There are also a whole plethora of pitch detecting automatic accompaniment titles for students like PG Music's *Band in a Box*, Coda Music's *Vivace*, and MakeMusic Inc.'s *SmartMusic*.

By contrast, *Jeux Deux* leverages the simplicity of MIDI. Since MIDI is, at its core, a symbolic representation of music, it is in a way a score. Notes on paper signify to a performer the same pitch, duration, and intensity that a MIDI note communicates to a computer. It is therefore easy to implement a score follower that can look for specific notes, sequences, or other inputs from the MIDI controller (in this case the Disklavier) and find timing in a precomposed score. Upon finding its place in a score, the computer may trigger musical sequences, change modes, or send messages to other computers.

Turning music into music

Again we return to the concept of mapping: once a computer knows what another player is playing, it must then decide what to play itself. For this work I decided to give the computer varying degrees of flexibility, depending on the location in the musical score. In some sections the computer may be playing precomposed sequences exactly as written, while in other sections the computer is free to improvise based on what the human player is playing. In some sections the computer is programmed not to play at all.

| 82

Machover, Tod. 1994. *Bounce - Chansons d'Amour*. Bridge Records. CD.

Risset, Jean-Claude and Scott Van Duyne. Real-Time Performance Interaction with a Computer-Controlled Acoustic Piano. *Computer Music Journal* 20:1, Spring, 62-75.

These ideas stem directly from two critical works: *Bounce* (1993), by Tod Machover, and *Duet for One Pianist* (1989), by Jean-Claude Risset. Both of these works were created at the MIT Media Lab (Risset was composer in residence at the Experimental Music Studio in 1987), and both exhibit similar techniques in computer musicianship. Specific process details used in *Jeux Deux* are explained below.

2. ————— Tea for Two, Part Two: The Design of *Jeux Deux*

The compositional process



Fig. 3.1: Keith Lockhart conducting the premiere of *Jeux Deux* with the Boston Pops, Michael Chertock, hyperpiano.

Photo courtesy of Tod Machover

Jeux Deux is in many ways vastly different from any other projects I have worked on, if only because of the close collaboration that was required in designing it. While I was hard at work on the software, Tod Machover was busy writing music and Marc Downie hacked away at some beautiful computer graphics.

For the last 7 years I have had the wonderful opportunity to work closely with Tod Machover on a number of projects, but none so closely as *Jeux Deux*. This project was, in every sense of the word, collaborative—composer to programmer, artist to programmer, artist to computer, artist to composer, computer to computer. Every piece of the puzzle fits together seamlessly, and it would not have been such a success had it not been for a unique creative process.

Tod approached me with this concept shortly after the Marshall Field's Flower Show ran its course. The pitch was elegant: a groundbreaking electronic work, for *acoustic* instruments. Given my past involvement with Disklaviers, this work seemed a natural progression—and a big challenge. My past work with player pianos seemed dwarfed by this, a full fledged concerto for hyperpiano and orchestra.

Tod and I began without music, but with ideas. We sat and discussed the ways a player might interact with himself, ways that a computer could bend and twist and shape the music he was playing. After several intense meetings, we settled on a few novel ideas, and I went off to program.



Fig. 3.2: *Jeux Deux* at Symphony Hall, Boston,
with graphics by Marc Downie
Photo courtesy of Tod Machover

When programming was complete, I went back to Tod to show him the processes I had created, and the possibilities they presented. We toyed with some of them—and had an enormous amount of fun playing them—but still found numerous things to fix and build.

It was only after all of the building blocks had been completed that Tod began to write the music. With this new set of tools, the composition came naturally, and built directly on the ideas we had played with. This varies greatly from most of the other projects I have worked on, where the music and technology are built simultaneously, not serially.

The final step in the project was for Marc to build the computer graphics system, which happened after the music was composed. Marc and I then worked to get all the computer systems talking to each other. The only thing left to do was to play.

84

Jeux Deux was premiered June 1, 2005 at Symphony Hall in Boston by Keith Lockhart and the Boston Pops, with Michael Chertock on hyperpiano.

The hardware

The musical system for *Jeux Deux* consisted of only four key components:

Yamaha Disklavier Mark III — We decided to use the Mark III Disklavier after significant testing of the Mark IV system on the Marshall Field's project. The major problem with the Mark IV is that all MIDI commands sent into the control box are immediately sent back out. Since our plan was to have two way communication between the computer and the

Jeux Deux Performance Setup

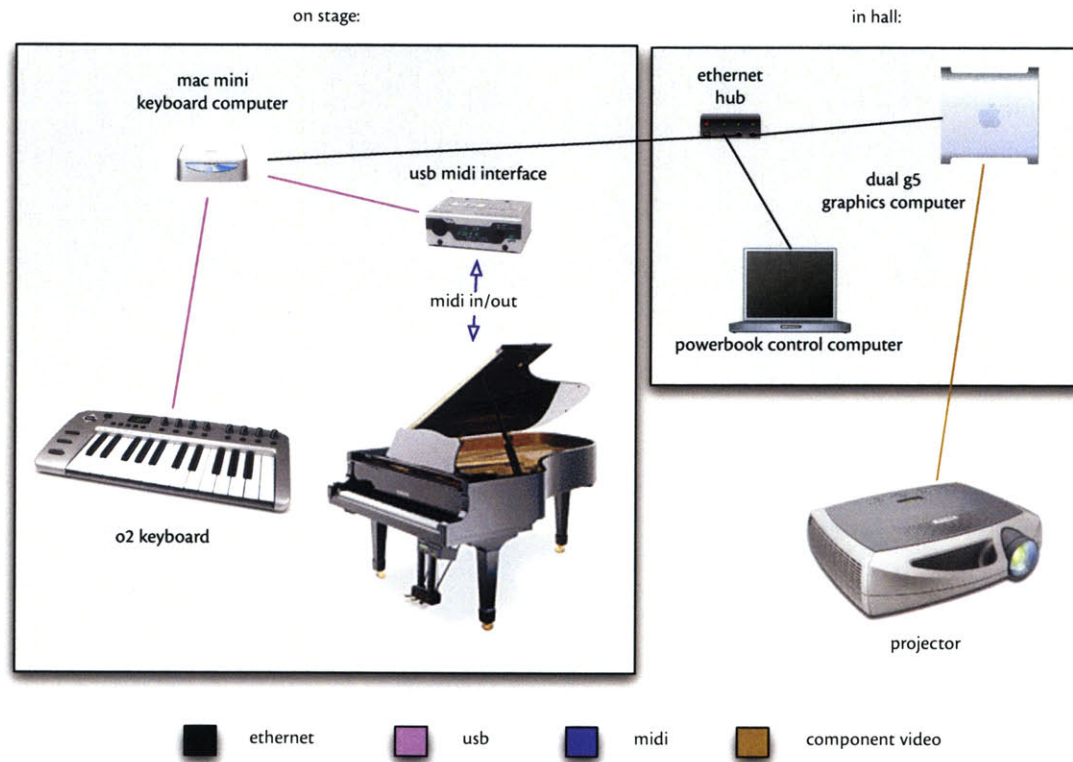

Fig. 3.3

piano, the “loopback” would either have to be filtered out or ignored, a serious programming challenge. At first I began searching for a way to filter the loopback. Jean-Claude Risset had successfully done this with his

earlier work, but that was nearly ten years earlier on a Mark II piano! I contacted a close friend of the Media Lab George Litterst, a consultant for Yamaha and a strong proponent of using Disklaviers in education. It turns out Yamaha had fixed this problem in the Mark III, but it reappeared in the Mark IV. So again I judged the Mark III as the more reliable instrument. Serendipitously, it turned out that, according to Mike Bates of Yamaha’s Institutional Services Department, the Mark IV system had not yet been built into a concert size instrument, but that the Mark III system had been put into pianos in up to 9 foot sizes.

Apple Mac mini G4 — In deciding on what computer to use, one feature was of the essence, and that is portability. The Mac mini computers we used in the Marshall Field’s show worked great for handling large amounts of MIDI data, and seemed the logical choice for this project as well. In fact, since MIDI processing is such a minimal drain on computer resources, it would probably be possible to do this piece using a small microcontroller. But given the simplicity of MAX/MSP programming and my familiarity with the Mac OS X operating system, the Mac mini seemed a better option. We outfitted the Mac mini

chine communicates with the graphics computer and control computer via ethernet.

M-Audio O2 USB MIDI Keyboard — This controller is used in *Jeux Deux* to control mode changes as well as a few other features. It is a 2-octave keyboard, providing more than enough keys for the mode changes in *Jeux Deux*. In addition it has 8 assignable knobs that send MIDI continuous control messages. These knobs proved essential in the “knob blob” section of the piece (described below).

Apple PowerBook G4 12” laptop computer — This computer is used to monitor and control the Mac mini from offstage. It is connected to the Mac mini (and also the graphics system) via ethernet. Control is handled using Apple Remote Desktop.

Downie, Marc. 2005. *Choreographing the Extended Agent: performance graphics for dance theater*. Ph.D. Thesis, Massachusetts Institute of Technology.

The hardware (as well as software and design) for the graphics system is beyond the scope of this thesis, but is well documented in Marc Downie’s Ph.D. Thesis.

| 86

The software

See p. 70 for description of
MAX/MSP

At the heart of *Jeux Deux* is the piano software. Written in MAX/MSP, this software controls all aspects of the musical performance, and includes a score follower, MIDI routing system, numerous musical processes, a MIDI playback function for debugging and testing, visual guides for in-performance monitoring, and an emergency kill-switch and MIDI panic button.

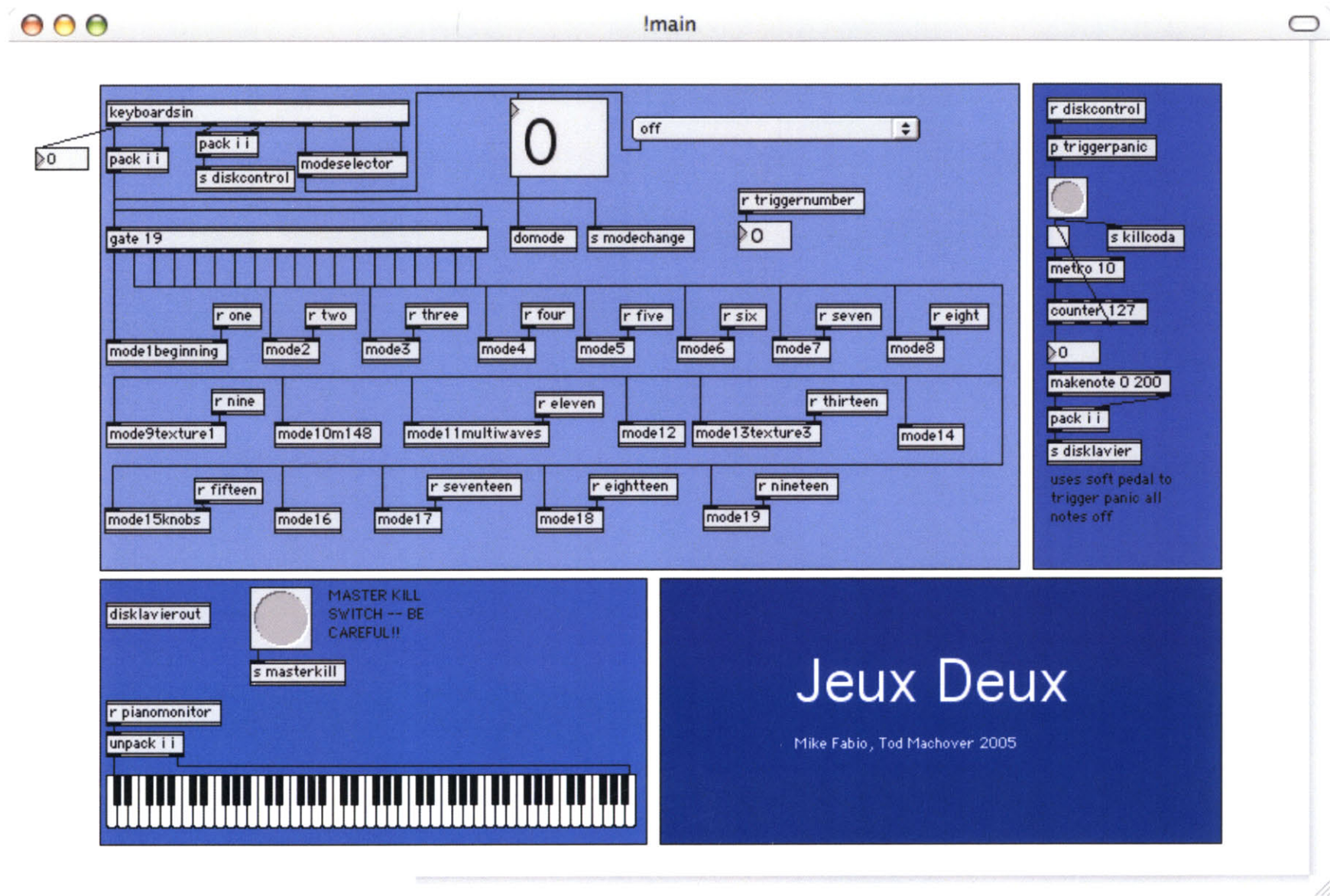

FIG. 3.4

At the top of the patch is the master control section. All MIDI from the Disklavier and O2 keyboard enters the software in the `keyboardsin` object. Messages from the O2 keyboard are routed to the `modeselector` object, which determines the mode of the piece based on input from this controller. The mode can also be manually selected using the dropdown box (this is useful in rehearsal). The mode number is routed to the `domode` object, which acts as a switcher to turn on or off each of the mode objects. This is separate from the large gate object, which determines the flow of MIDI from the Disklavier to the mode objects.

Each section of the *Jeux Deux* score has a corresponding mode, each of which is represented by a separate object within the main software. Every mode carries out specific functions and musical processes. These are described below.

OpenSoundControl documentation and
software can be found at
<<http://www.cnmat.berkeley.edu/OpenSoundControl/>>

All MIDI output from the computer is handled by the `disklavierout` object (seen near the bottom of the software screen). This object also sends messages to the graphics computer using the OpenSoundControl (OSC) protocol, and the freely available `otudp` object. The graphical keyboard at the bottom of the screen displays outgoing MIDI notes. This is extremely useful in debugging as well as in performance. There is also a master kill-switch that can halt all outgoing MIDI communications in case of an error. This switch can only be engaged manually with the control software and not from the piano, the only exception being that the final mode of the piece automatically kills the MIDI output when completed.

At the right side of screen is a small algorithm to perform a “MIDI panic.” This useful tool, which sends a MIDI note-off to every key sequentially is invaluable with the Disklavier: a stuck note, which sadly is a frequent occurrence, can cause system failure if left for too long, and also makes it impossible for the player to play the note while stuck. The player can trigger this panic button using the left pedal of the Disklavier. It may also be triggered manually from the control software.

3. _____ Modalities and Processes

Each mode in *Jeux Deux* performs a set of specific musical functions. In general, MIDI notes flow into each mode through the upper left inlet and mode on/off messages come in the right inlet of each patch/object.

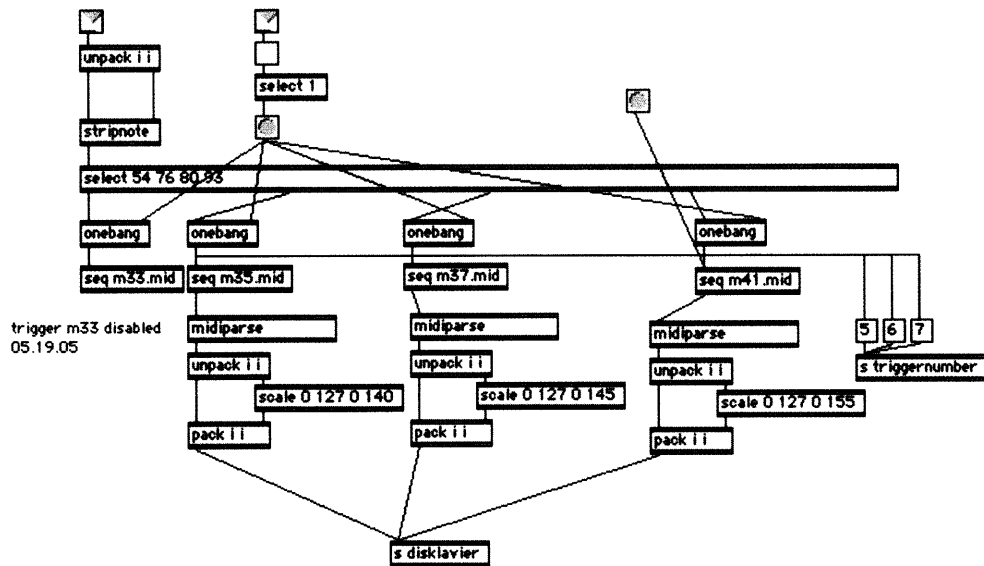

Fig. 3.5: MIDI sequence triggering patch

MIDI sequence triggering

One of the most common applications of simple score following is to have specific notes or events “trigger” MIDI sequences. Each time a trigger is seen, a pre-composed sequence of notes or events is then played back. This technique is used often in *Jeux Deux*, especially in the first eight modes.

Figure 3.5 shows an example of a triggering mode. The select object looks for specific MIDI note numbers, and when that note is received, sends a *bang* message to its corresponding seq object. MIDI coming out of seq is parsed into its components in order that velocity values

can be scaled without having to make changes to the original sequence files. This is useful in rehearsal for fine tuning the piece before performance. The onebang objects ensure that a trigger will not be accidentally played more than once. This can be reset in rehearsal by reentering the mode from the O2 keyboard. At the far right of this patch is an object to send the trigger number to the graphics computer.

“The Wall” transposition

This algorithm, which appears as a mini-cadenza near the beginning of the piece, is deceptively simple, yet incredibly powerful. Incoming MIDI is parsed by octave, so that each octave of the keyboard is routed to a separate portion of the patch. Each octave has a corresponding transposition, that is carried out through the entire range of the keyboard.

For instance, if the player plays a G in the lowest octave of the keyboard, it will be transposed in octaves such that every G on the keyboard is played. The second octave of the keyboard is transposed in major 7ths, so a G in the second octave would play back an F# in the third octave, an F in the fourth, and so on. Subsequent keyboard ranges have smaller and smaller transpositions, so that in the upper octave of the keyboard the transpositions are in minor 2nds, effectively playing each note in the octave.

When several notes in various octaves are played together,

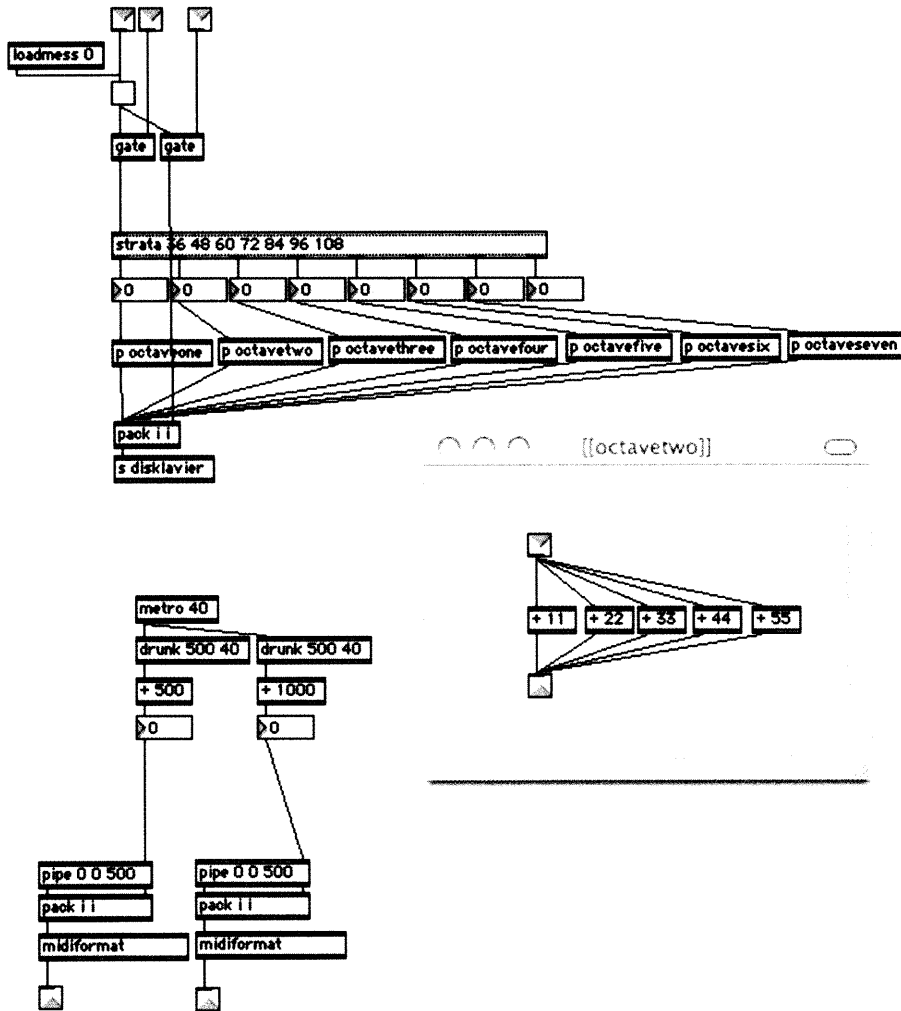

Fig. 3.6: “The Wall” transposition patch

The other values are determined by the input from the Disklavier:

The expected value, or mean, is determined by the “center of gravity” of the notes that are being played. This is a mean average of the pitch of the last 10 notes that have been played. For instance, if the player is only playing in a small range of the keyboard, say the single octave above middle-C, then the mean is likely to be the F# above middle-C (assuming the player is playing an even distribution of notes). Similarly, if the player is only playing one note very high on the keyboard and one note very low on the keyboard, the mean value will be a single note near the center of the keyboard.

The standard deviation, here called the variance, is determined by the frequency of notes being played, or notes per second. If the player is playing very few notes per second, the width of the output curve is small. And if the player is playing many notes per second, the width grows. It is possible, when playing many notes per second, to create an output span that reaches the entire range of the keyboard.

| 92

The tempo at which notes are played is also determined by the number of notes per second. A metronome whose tempo (in milliseconds) is determined by the note-on frequency outputs a *bang* to the distribution object, triggering a note.

The velocity of the output note is determined by the velocity of the last note played plus a random number between 0 and 10 (to add some variance). As the player plays louder, the piano output is also louder.

All of these variables return gradually to zero when there is no input from the keyboard.

The net effect of this algorithm is a sort of “note herding,” where the player can move clusters of notes around the keyboard and control their velocities and tempo. Because the pitch center is an average of the last ten notes played, the clusters tend to follow behind the player as he moves in a single direction up or down the keyboard. The player may choose to only play a single note: played loudly and rapidly, this can trigger pointillistic notes all over the keyboard. This pseudo-random improvisation creates lively textural sounds, and all under the complete control of the pianist from the keyboard.

Sequence triggering, again

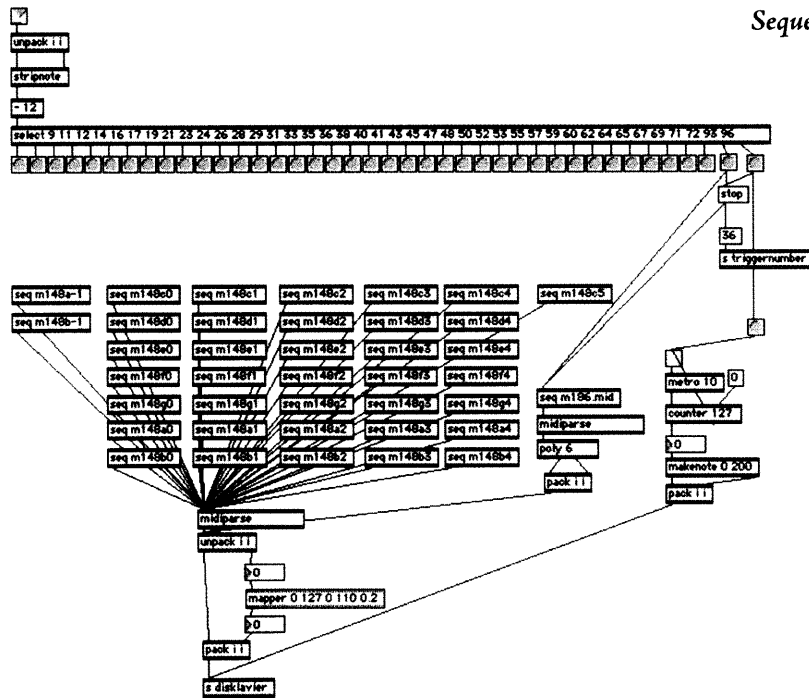

Fig. 3.7: Fast sequence triggers patch

There is a section near the middle of *Jeux Deux* in which the only sounds coming from the piano are from triggered sequences of extremely rapid notes. Every white key on the keyboard is mapped to a sequence of notes that are humanly impossible to play. The player triggers each one in series, stepping up the entire keyboard range.

This algorithm created numerous problems while testing on the Disklavier, and required quite a bit of modification during rehearsal. I will discuss these problems and the limitations of the Disklavier in the next section.

Texture blob 2 - drop in a bucket

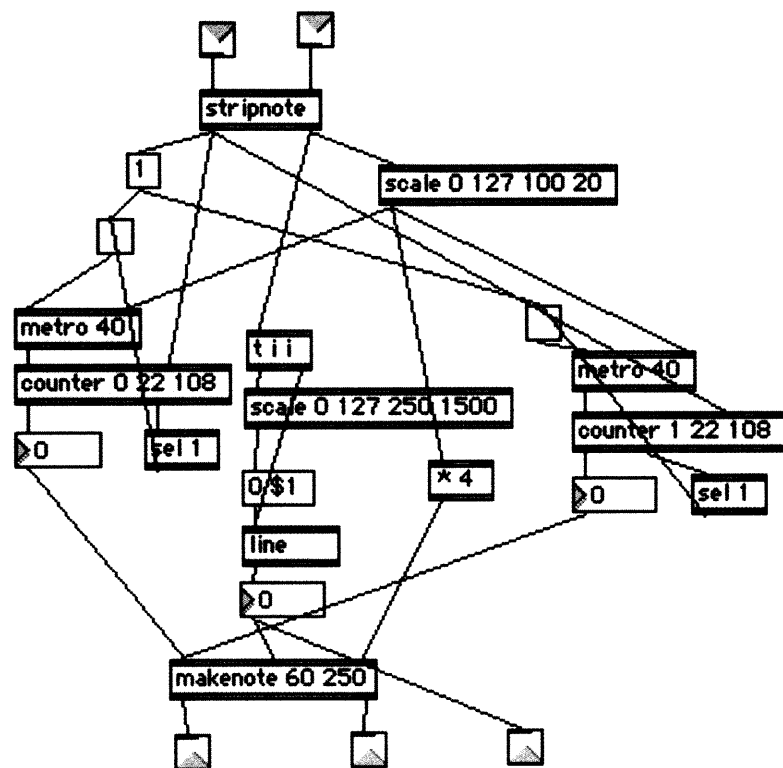

Fig. 3.8 Texture blob 2 - drop in a bucket patch

One often overlooked feature of the Disklavier is the visual impact of keys moving. To this end, I implemented an algorithm that is as appealing visually as it is musically.

The idea behind this algorithm is based on a drop of water hitting a pool and rippling outward. On a piano keyboard, this analogy becomes that of playing a note and having two streams of chromatic notes shooting outward from center, gradually fading as they move.

The algorithm is mathematically elementary; but in MAX it becomes nearly impossible to implement. The “spaghetti mess” in Figure 3.8 is the patch responsible for this interaction.

The pitch of an incoming note is used as the starting point for the wave. As soon as the pitch is received, two counters begin counting by +1 and -1 from the center. Each of these pitches is paired with a note velocity, which is determined from the input note velocity, then scaled gradually to fade with distance from the center.

Up to five of these “drops” can be played simultaneously, creating waves rippling across the entire keyboard.

Playthrough

It may seem silly, but there is one mode of interaction that is often overlooked: that of no interaction at all. There are several points in *Jeux Deux* where the pianist may freely play without the computer.

Texture blob 3 - swirling polyrhythms

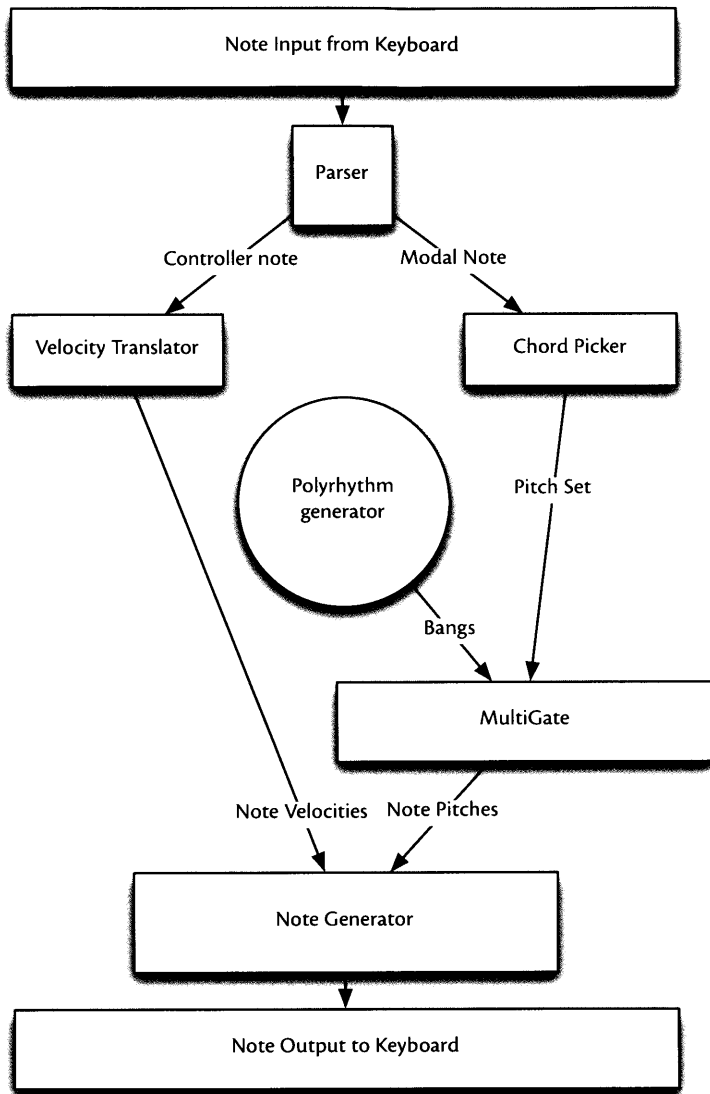

Fig. 3.9: Texture blob 3 - swirling polyrhythms, flow diagram

Figure 3.9 explains the algorithm of the third textural cadenza of *Jeux Deux*. This texture creates polyrhythmic beating patterns on predefined chordal sets. These patterns build slowly with the orchestra, creating a sort of swirling effect of notes and chords that don't fit into any understandable rhythm, an almost cloudlike noise.

The player is asked in the score to play two types of notes. The bottom note is a specific pitch, to be played in any type of rhythm at varying velocities. The top note is a single note, to be played as directed by the conductor. This note, which is any of a sequential set of pitches, is to be played only once when cued. Both types of notes are parsed and sent to specific subroutines.

The lower note (the "controller note") is meant to define the velocities of the computer playback. The player may increase or decrease the playback velocities by increasing or decreasing his input.

The upper note (the "modal note") is a sort of mode change that selects a set of pitches to be played back. The pitch sets are stored in a text file, and are precomposed to correspond with the notes played by the orchestra.

At the core of this patch is a polyrhythm generator. This subroutine is autonomous, receiving only an on/off command. It generates 12 randomized rhythms (the largest pitch set in this section is 12 notes) that are not synced in any way. These rhythms pass into a gating routine. This routine takes in the pitch set and outputs individual pitches as it

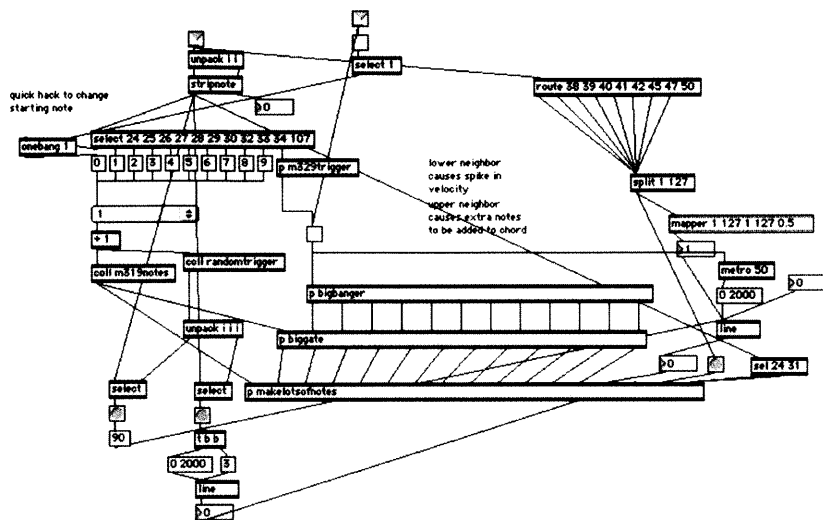

Fig. 3.9: Texture blob 3 - swirling polyrhythms patch

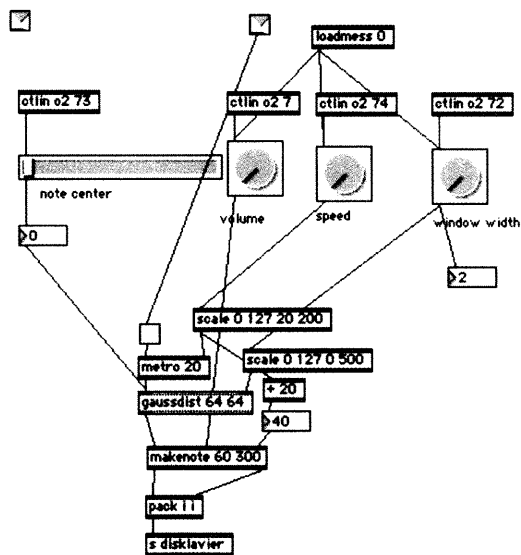

Fig. 3.10: Knob-blob patch

receives rhythmic pulses from the generator.

Each pitch output from the multigate is paired with a velocity as determined by the controller note input. This pair makes up a standard MIDI note and is output to the keyboard.

For completeness, the patch is shown in Figure 3.9, though the diagram above explains its functionality much more succinctly.

The knob-blob

This is perhaps the most dramatic of the piano behaviors. The player stands up from the piano and begins twiddling knobs on the O2 keyboard, sending crashing waves of notes to the Disklavier. This patch relies on simplicity: a scale or chord can be a powerful musical gesture if played at superhuman tempi or deafening volumes.

The patch, in Figure 3.10, takes input only from the O2 keyboard via continuous MIDI controller knobs. These four inputs control the pitch center, volume, tempo, and width of a “blob” of notes that is generated using the same Gaussian distribution method of Texture blob 2.

The resulting sound is a surprisingly varied palette of textures. With this patch it is possible to create a number of figurations: a high tinkling; a full-keyboard onslaught of crashing arpeggios; low drones and rumbling bass, an almost electronic-sounding randomized beating pattern; glissandi of all types; crashes, sweeps, and sustained cacophony. The versatility of this patch showcases the abilities of the Disklavier; but as we shall see, it also showcases the Disklavier’s shortcomings.

4. _____ Designing for Limitations

It is an unfortunate consequence of the technology that robotic instrument interaction—and many types of human computer interaction—must be designed around (and to) the limitations of systems. In an example like the Disklavier, the instrument may be able to play techniques unmanageable by even the most virtuosic players, but certain physical limitations of the instrument still force the interactions to be constrained. The objective then becomes to push the system as far as it can go.

The polyphony problem

Just as the polyphony limitations of the Disklavier shaped the software for the Marshall Field's project, it forced me to rethink many parts of the *Jeux Deux* software. | 97

The Disklavier is limited to 16 notes of polyphony. That is to say that at any given time, only 16 keys may be depressed on the keyboard (though the sustain pedal may still be used to allow the notes to ring). And while this permits figurations that a human cannot play (we still only have 10 fingers), it does severely limit the instrument.

If we take the “wall” transpositions as an example, a single note depressed in the lowest octave of the keyboard results in 7 extra notes played back to the Disklavier. Using only the left hand to play a triad in the lowest octave results in 21 notes returned to the Disklavier. The Disklavier responds to this by playing notes in the order they are received until the limit is reached. When any note is released, the Disklavier will allow an-



Fig. 3.11: Michael Chertock practicing at the Disklavier for a performance in Porto, Portugal, March 2006.

Photo by Mike Fabio

other note to be played through, though it does not store unplayed notes in a buffer.

As it turns out, this is not such a problem musically. Although the system can behave erratically if a huge number of notes are played into it, in general it is predictable in its actions. For the transpositions, most any type of playing still results in a strange cacophony of pseudo-harmonization. And since the transpositions only go into higher registers, notes played in the middle of the keyboard result in far fewer notes played back to the Disklavier, and more accurate response.

For other sections, the limitations of the Disklavier are more pronounced. In some of the sequenced sections, for example, it was necessary to limit the sequence output at the software level because some sequences were causing stuck notes and other strange behavior.

98

The knob-blob presented a more severe problem. The Disklavier seemed unable to handle the sheer number of notes being played back to it. Keys would often stick, and as this occurred fewer and fewer notes could then be played. If too many notes became stuck, the Disklavier would sometimes hang indefinitely and need to be rebooted. At first I attempted to solve this problem by sending frequent panic commands to reset all the keys, but this approach proved inefficient. In the end, I found a set of constraints on the output such that the number of notes would not overload the system, nor would the speed of the notes.

The hammer-fall problem

Werner Goebel and Roberto Bresin have devoted a fair amount of research to this topic as it relates to music performance research. See Goebel, Werner, and Roberto Bresin. 2001. Are computer-controlled pianos a reliable tool in music performance research? Recording and reproduction precision of a Yamaha Disklavier grand piano. In *MOSART workshop, 2001*. Accessed April 21, 2007 <<http://www.iaa.upf.es/mtg/mosart/papers/p35.pdf>>

and Goebel, Werner, Roberto Bresin and Alexander Galembo. 2003. The Piano Action as the Performer's Interface: Timing Properties, Dynamic Behaviour and the Performer's Possibilities. In *Proceedings of the Stockholm Music Acoustics Conference, August 6-9, 2003 (SMAC 2003)*.

As with any mechanical system, there is a range of motion inherent in the design of the Disklavier. As I described earlier, the actuation of the piano keys takes a variable amount of time depending on the velocity of the note. In order to ensure that notes would be played as immediately as possible, the 500ms delay of the Disklavier was disabled.

Even without the delay, though, there is still an inherent delay in the motion of the keys. This delay is most obvious in the transposition section. When a note is played very softly, the hammers take much longer to reach the strings, and the delay is easily noticeable between pressing a key and the transposed notes playing. When a note is played very loudly, the delay is less noticeable because the hammer takes less time to strike the string.

When playing back sequences, this problem is even more severe. If the Disklavier fires the hammer at the moment a MIDI note is received, it will sound at a later point in time, and moreover that time is variable. For example, imagine a single note played repeatedly at a constant interval, but varied in velocity over time from 127 (max) to 1 (min). The first note, with a velocity of 127, will sound only a short time after the note is received, but each subsequent note will sound slightly later than the note is received, so that despite the constant time interval between notes being sent, the sounded notes take on longer and longer time between them. When playing precomposed sequences of notes with many different velocities, the timing problems can cause the music to take on jarring rhythms that were not intended.

To compensate for this issue, sequences in *Jeux Deux* are often compressed in their dynamic range. Though this results in a slightly less expressive series of notes, the rhythm is more closely preserved.

There is another issue with the Disklavier that is directly related to the hammer-fall problem: MIDI notes with extremely small velocity values often do not sound. I found this to be a problem with most notes of MIDI velocities between approximately 1 and 20. Though few parts of *Jeux Deux* utilize notes in those ranges, it was usually necessary to “amplify” all outgoing notes to ensure that they would sound.

5. _____ Live in Concert: Performing *Jeux Deux*

A particularly good review of *Jeux Deux* appeared after its premiere in Schwartz, Lloyd. 2005. Music: Bloody Great. *The Boston Phoenix*, June 10-16. Accessed April 21, 2007 <http://bostonphoenix.com/boston/music/other_stories/documents/04743673.asp>

Jeux Deux was premiered in Boston in June 2005 to critical acclaim. Since then it has been featured at the opening of the McGovern Institute for Brain Research at MIT, at the Boston Music Awards at the Avalon in Boston, and at the Casa da Musica in Porto, Portugal. Each of these performances involved slightly different versions of the piece.

| 100

World Premiere: Symphony Hall in Boston

The world premiere of *Jeux Deux* took place at Symphony Hall in Boston with Michael Chertock on hyperpiano, and Keith Lockhart conducting the Boston Pops. This premiere featured a full length performance of the piece, including all the processes and algorithms described above.

The system performed as expected with no technical hangups. The software remained stable and responsive throughout the piece.

McGovern Institute for Brain Research

When the McGovern Institute for Brain Research at the Massachusetts Institute of Technology opened its doors on November 4, 2005, they enthusiastically featured *Jeux Deux* in the ceremonies. For this performance we did not have the space or resources to hire an orchestra. So Tod and I developed a set of electronic backing tracks to accompany the hyperpiano, to be triggered from a sampler.

Kontakt is commercially available software from Native Instruments
<http://www.native-instruments.com/index.php?id=kontakt_us>

The backing tracks, which Tod composed in his studio using a variety of sampled sounds and MIDI synthesizers, were recorded and placed into the sampling software Kontakt. Each sample was mapped to a key on another M-Audio O2 keyboard, and played on cue during the performance by Tod, sitting next to Michael Chertock on the hyperpiano.

Unfortunately this performance was marred by a technical glitch which caused one of the samples to play back simultaneously with a delayed copy of itself. Though this section was not long, it threw off the hyperpianist. In the end, though, the piece was well received by the audience.

| 101

Boston Music Awards at the Avalon, Boston.

In a strange turn of events, we were asked to perform *Jeux Deux* at the awards ceremony of the Boston Music Awards. The concert took place at the Avalon, a dance club that often features live popular music acts.

For this performance, we decided not to use the electronic backing tracks; the piece was performed by solo hyperpiano. The music was edited down to 5 minutes from its previous 15. And since the hall is quite large,



Fig. 3.12: The stage is set at the Casa da Musica
Photo by Mike Fabio

and most of the other groups playing that evening would be amplified, we chose to amplify the hyperpiano as well. Marc's graphics were similarly edited to fit the 5 minute form.

The performance took a turn for the worse when Michael began playing at an extremely fast tempo, nearly twice that of previous performances. Miraculously, the piano software was able to keep up, but since many of the precomposed sequences were at a different tempo than what he was playing, the results were mixed. Marc's graphics software seemed to lack some of the life it had at previous performances, probably because of the tempo issues. But although the music and performance were less than perfect, all of the technology performed exactly as expected, never missing a beat.

Casa da Musica, Porto, Portugal

The final performance of *Jeux Deux* was in March of 2006 at the Casa da Musica in Porto, Portugal, with Gil Rose conducting the Orquestra Nacional do Porto. This concert featured the original full version of *Jeux Deux*. The show went off without a hitch. The piano software and the graphic software performed perfectly, and the show was a huge success.

The Chandelier represents my most significant work in the field of robotic musical instruments. It is a shift from the software and mapping concepts of my previous works to the realm of hardware design and fabrication. This chapter describes the design and implementation of a first-run, full-scale prototype instrument.

Chapter 4 — *The Chandelier*

The work described in previous sections of this thesis largely involved writing software to control and interact with off-the-shelf robotic instruments. Here I will describe my most recent work in this field: the full-scale prototyping of a new robotic instrument, including hardware, acoustical, electronic, and interaction design. The instrument is called *The Chandelier*. | 103

1. _____ *Death and the Powers: A Robotic Opera*

To understand *The Chandelier* in context, we must look at the project for which it is designed. *Death and the Powers* is an opera by Tod Machover that incorporates new technologies in robotics, sound design, and scenic design to present a science fiction odyssey. And though the technologies are extraordinarily cutting edge, the plot is universal:

From *Death and the Powers: An Overview*, by Tod Machover

<<http://www.media.mit.edu/hyperins/projects/deathandthepowers/>>

Simon Powers was a great man, a legend who wanted to go beyond the bounds of humanity. He was a successful inventor, businessman, and showman. During his life, he accumulated unimaginable wealth and power. He is the founder of the System, a human organism material experiment which investigated the transduction of human existence into other forms. His work was heralded as revolutionary and genius, but his ideas and experiments also had implications that mainstream society found objectionable. He has received thousands of hate letters. To many, he is considered a pariah. Reaching the end of his life, Powers faces the question of his legacy: “When I die, what remains? What will I leave behind? What can I control? What can I perpetuate?” He is now conducting the last experiment of his life. He is in the process of passing from one form of existence to another in an effort to project himself into the future. Whether or not he is actually alive is a question. Simon Powers is himself now a System. Powers must rely on his family to complete the experiment. The strains on the family come to a head, as Evvy, his third wife, withdraws more and more from the real world in a desire to join Simon in the System. Miranda Powers, Simon’s young daughter by his first wife, is fearful of losing touch with the real world, and tries desperately to keep her father connected to the suffering of others in the world. The family also includes Nicholas, who is Simon’s protégé, the son he never had. Nicholas is the ultimate product of Simon’s manipulation. Nicholas holds the knowledge on how to project Simon to the future. Like a puppet and somehow incomplete himself, he is devoted to completing Simon’s final experiment. Simon’s transition into The System creates global havoc prompting a visit by representatives from The United Way, The United Nations, and The Administration, as well as a parade of the world’s miseries— the victims of famine, torture, crime, and disease. This story is framed by a quartet of “rolling, lurching, and gliding” robots who have been commanded in some future time to perform this pageant, and who – in a Prologue and Epilogue – attempt to understand the meaning of death. | 104

A story of life and death, immortality and the race to establish a life’s work *in perpetuum*, love and war and all the unascertained truths of human existence, *Death and the Powers* is a timeless manifesto on the role of technology in our lives (and in death).



Fig. 4.1: A computer rendering of *The Chandelier*, courtesy of Steve Pliam

The Chandelier represents only a portion of the System, the robotic and electronic crypt that holds Simon Powers in death. It is through *The Chandelier* that Simon is able to speak musically, creating sounds unlike that of a normal human voice, but rather an abstract and textural sound only feasible through the use of a robotic instrument. It is, in essence, a stringed instrument, but bears little sonic resemblance to a piano, a violin, a harpsichord, or any of its other predecessors. Instead its sounds are a combination of the guttural and the delicate, harsh squeals juxtaposed with melancholic drones. These sounds are created by a number of specially designed actuators that pluck, hammer, rub, and otherwise excite the strings into an amalgam of unusual sonic textures. In a literal sense, the System functions not only as an instrument but a character: Simon Powers leaves the stage immediately after his death, and is only seen again through the robots and stage set.

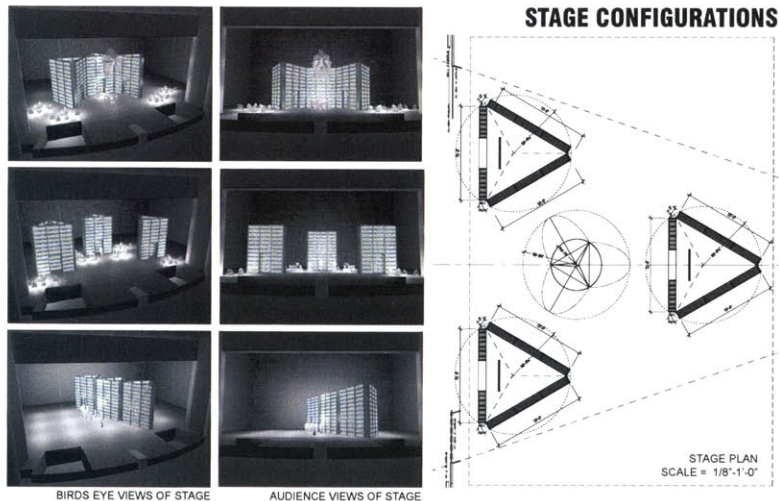

Fig. 4.2: An overview of the stage design, courtesy of Alex McDowell

Another major component of the System is the stage itself. A set of three triangular columns is able to move freely across the stage, reconfiguring into a variety of layouts to facilitate different scenes. Each side of the triangular columns resembles a bookshelf, with hundreds of robotically actuated books that can move in and out from the shelves. On the bindings of these books is a small high-resolution electronic display. In some configurations, the walls can function as an enormous display that spans the entire stage.

Also part of the System is a set of small non-anthropomorphic robots that swarm and glide across the stage, functioning as a sort of Greek chorus. The robots can react to human actors, and serve as a bit of comic relief as well as a medium for communication between Simon and the

humans he interacts with. The robots are capable of precision stage positioning, allowing many of them to function as a cohesive whole.

Death and the Powers is a hugely collaborative effort with a world-class roster, including libretto by former U.S. Poet Laureate Robert Pinsky, direction by Diane Paulus, production design by Hollywood designer Alex McDowell, and robotics by Cynthia Breazeal.

2. ————— Designing the Physical Structure of *The Chandelier*

The design responsibilities for the visual and formal aspects of *The Chandelier* have been executed by Steve Pliam, who is currently a fellow master's candidate at the MIT Media Lab. Though Steve and I have worked together on many aspects of this design, a complete discussion of the theory and design choices are beyond the scope of this thesis. Nevertheless, in the name of completeness I present several intermediate designs of *The Chandelier*. These help to illustrate the challenges and goals of building a prototype, and outline the path to which I have hopefully adhered.

106

The following images show the progression and evolution of the structure of *The Chandelier*. This work began in fall of 2005 and has continued to the present. The majority of the design work was carried out by Steve Pliam, with additional help by Alex McDowell and Arjuna Imel, and peripheral consulting by Laird Nolan, Brian Demers, and Lucas-Hernandez-Mena.

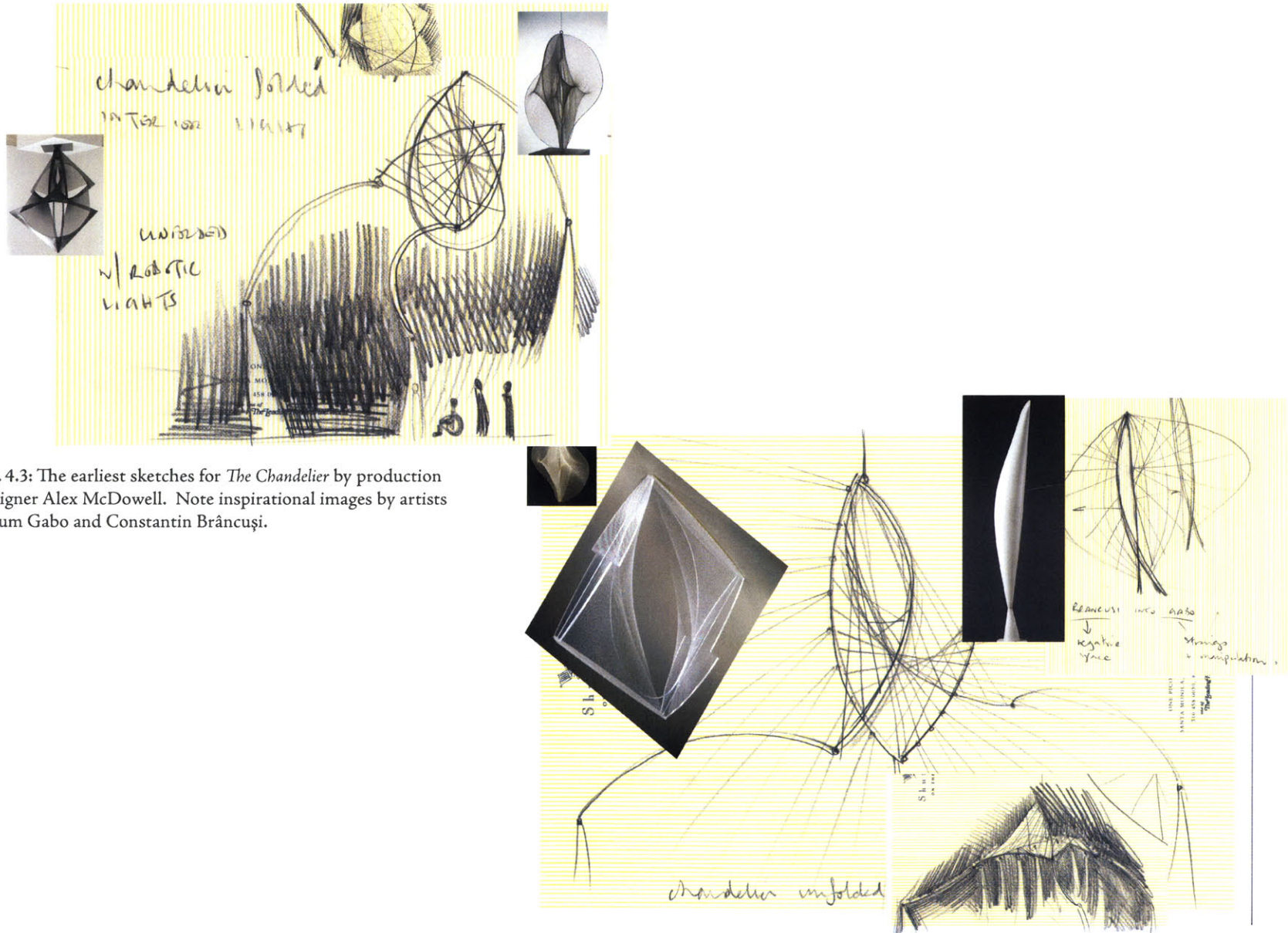

Fig. 4.3: The earliest sketches for *The Chandelier* by production designer Alex McDowell. Note inspirational images by artists Naum Gabo and Constantin Brâncuși.

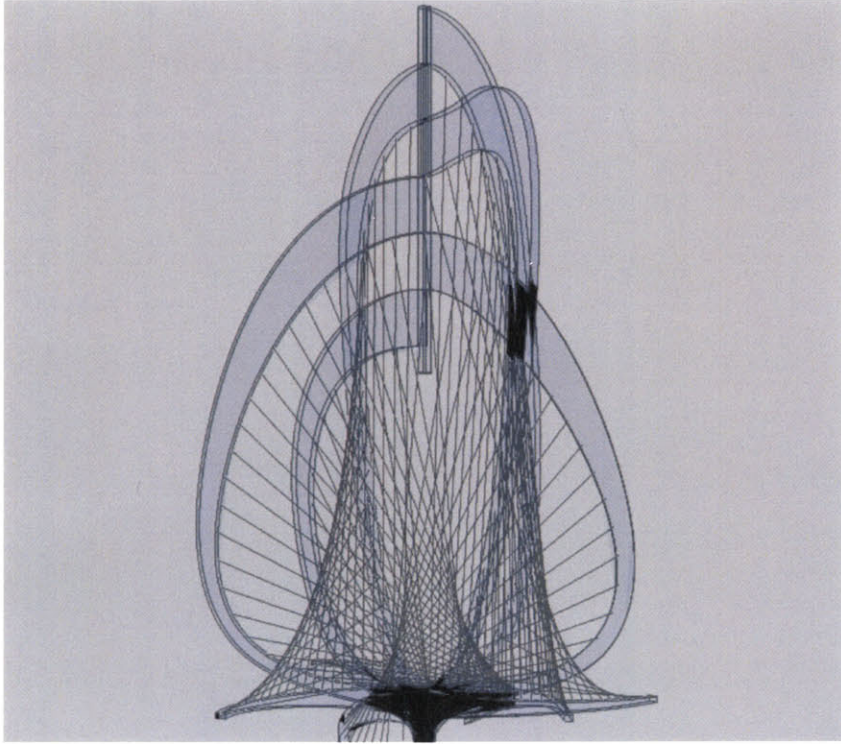
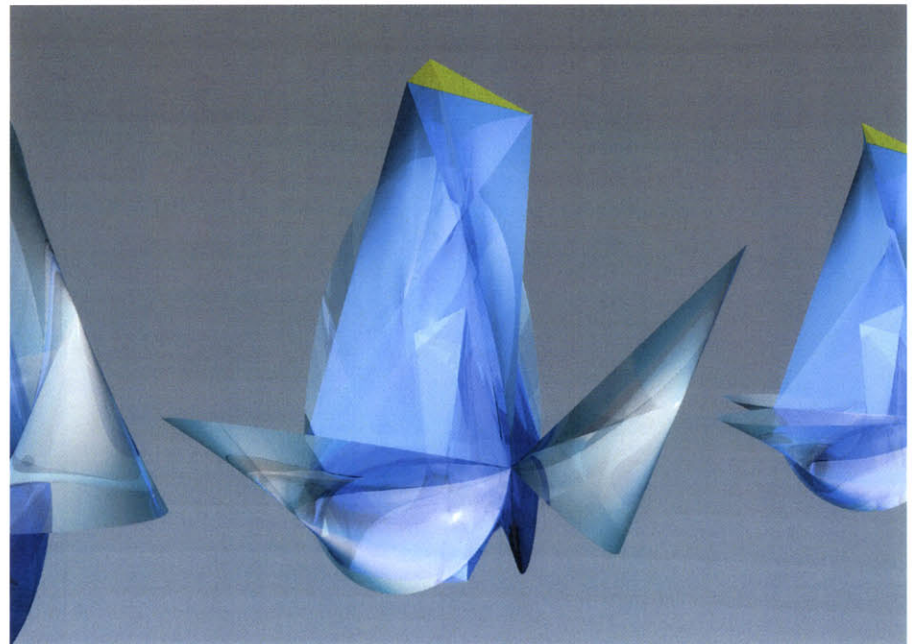

Fig. 4.4: The earliest computer rendering of *The Chandelier* by Steve Pliam. This is considered the first version. Note the harp-like figure of the frame and the thick interference patterns of the strings.

Fig. 4.5: An abstract rendering of the second version. This rendering lacks the “bird” shape found in some of the other versions.



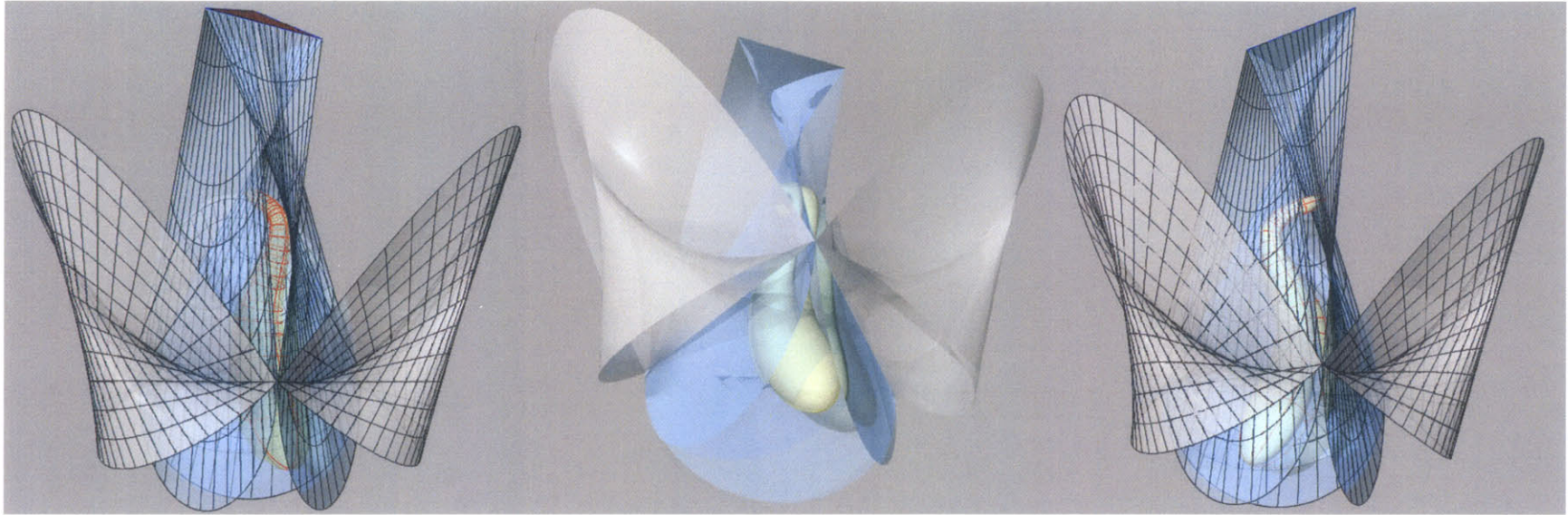

Fig. 4.6: Several more renderings of the second version. Note the Brâncușian “bird” shape in the interior.

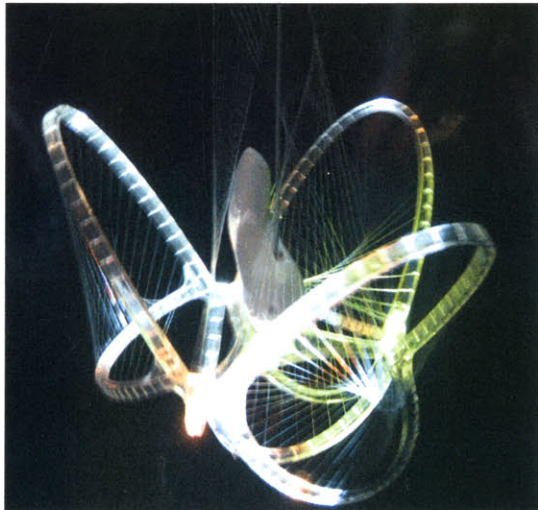

Fig. 4.7: Two images of a physical model, built by Mike Fabio and Brian Demers. This model is built from transparent acrylic and fishing line in order to refract light and experiment with different materials.

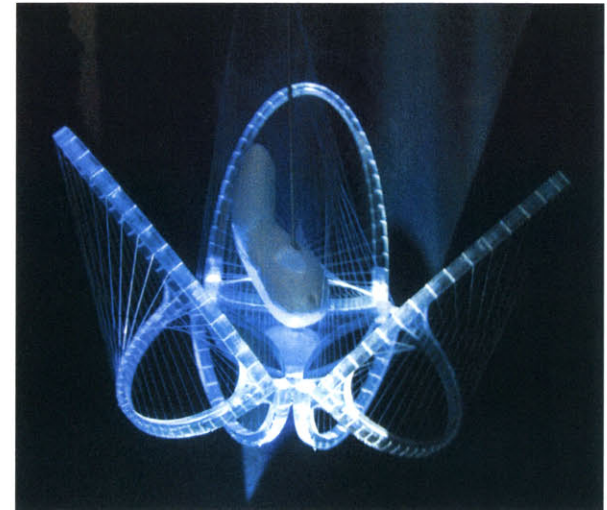



Fig. 4.8: Current design (version 3) as of April 23, 2007. Note that some of the thematic elements from the harp-like design of version 1 have reappeared.

Rendering by Steve Pliam

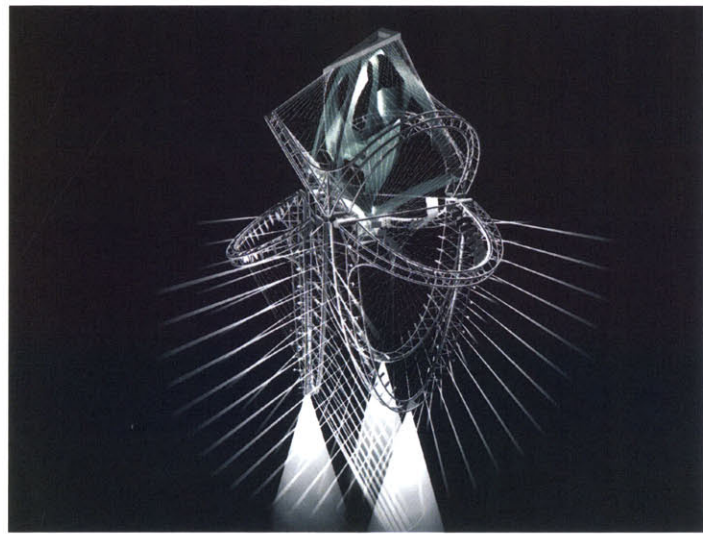
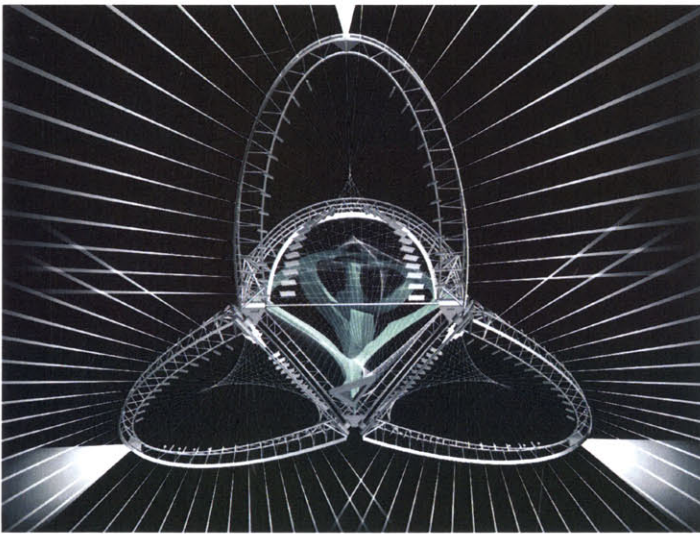
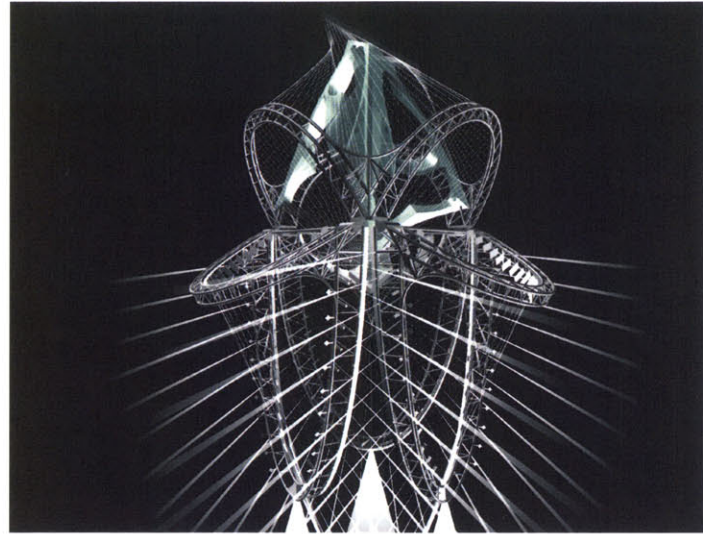
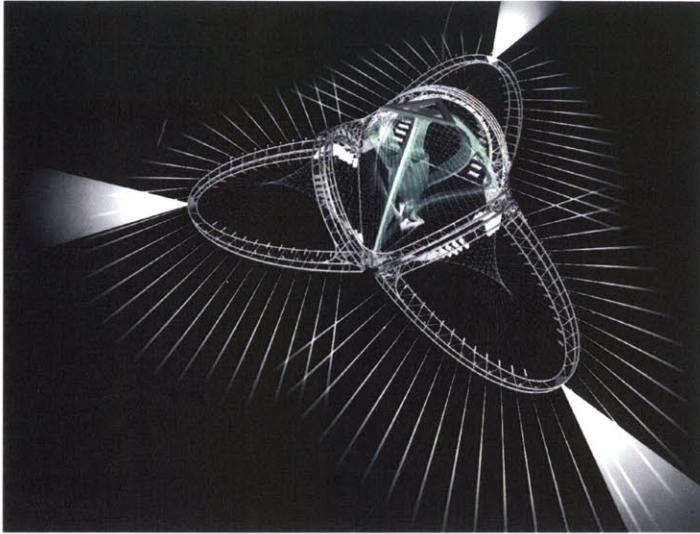

Fig. 4.9: Lighting studies by Arjuna Imel



Fig. 4.10: The electromonochord prototype.

Photo by Mike Fabio.

The earliest experiments in building *The Chandelier* occurred in summer of 2006 on an instrument we dubbed “the electromonochord.” Taking a cue from the historical *monochord*, a single-stringed instrument invented by Pythagoras to demonstrate the fundamental ratios of musical pitch, the electromonochord is a 10 foot length of two-by-four framing wood strung up with a single string on which any number of robotic actuators can be attached and tested. These preliminary experiments directly forged each of the actuators that appear in the most recent prototype.

A quick aside: A trip to the piano shop

Before we began construction on the electromonochord, we made a trip to a local piano shop owned by James Nicoloro, a good friend of the Media Lab and an expert piano repairman. It was there that we learned much of what it takes to build a string instrument. James shared the secrets of the intricate piano key mechanisms, the materials used to build a piano, some fascinating factoids (the total internal pressure from the strings of a tuned piano is nearly 22 tons), and a whole wealth of knowledge regarding instrument acoustics and construction. Without this trip to the piano shop, we may never have succeeded in building our prototype.

112

Building the electromonochord

In addition to the knowledge we took away from the piano shop, we also took back several spare piano parts with which to begin testing, including a whole set of Steinway wound bass strings, some hammers, and a block

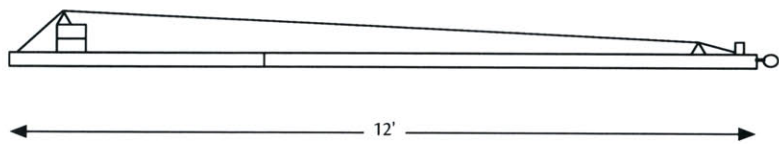

Note: Drawing not to scale

Fig. 4.11: Diagram of the electromonochord construction.

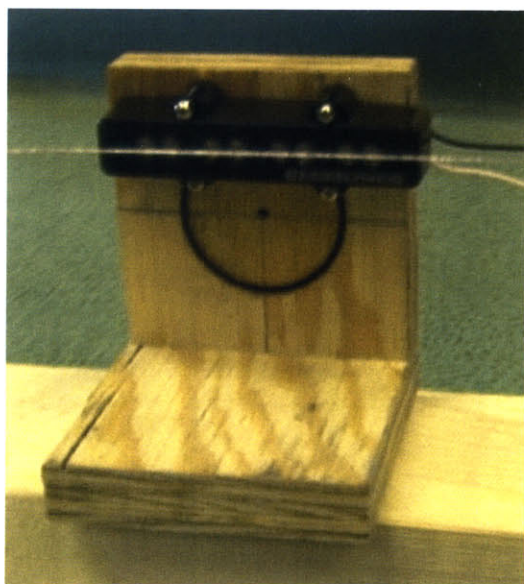

Fig. 4.12: The mounted pickup of the electromonochord.

Photo by Mike Fabio.

of pegboard (the laminate wood used to hold the pegs to which the piano strings are attached).

The electromonochord was assembled from two standard 2x4 planks of 8 feet each. One of these planks was cut in half to make a 4 foot plank, which was then attached to the 8 foot plank using a steel wood joiner and two steel screw-in type brackets. At one end of the assembled body two short pieces of 2x4 were attached to add height between the string and body. This height extension was added about 6 inches from the end in order that a bridge could be attached and the string could pass beyond the bridge to the body. The bridge was built from a short length of aluminum L-bracket, and attached to the height extension with screws.

Since the electromonochord does not have a resonating body, it makes little acoustic sound. To be heard it must be amplified. We attached a single bass guitar pickup (an off-the-shelf Seymour Duncan Basslines Vintage Jazz Bass Pickup) to a movable block and wired it to an amplified speaker. The movable block allowed us to experiment with different placements along the string. In our tests, the best place for the pickup was just over a foot from the bridge, which gave a clean signal across frequency ranges.

The earliest prototype used a set of brackets for tuning. These brackets were adjustable by tightening screws separating them. This system provided only fine tuning adjustments, though, and was quickly replaced by a tuning peg from a bass guitar (Fender Replacement Vintage Bass Nickel Tuners).

Testing strings

The first step in finding the right sound was to test various types of strings. These included several types, including galvanized steel wire, braided steel aircraft cable, guitar strings (both wound and unwound), cello strings, wound piano bass strings, and unwound piano wire. The testing process was largely a matter of trial and error, restringing the instrument frequently until we achieved the sound we were looking for.

The frequency of a string can be determined by the equation

$$f_1 = \frac{\sqrt{\frac{T}{D}}}{2L}$$

Where T=string tension, D=string density (or mass/length), and L=string length

A few examples of certain low frequencies:

16.35Hz - Lowest note on a Bösendorfer Imperial Grand piano

27.5Hz - Lowest note on a typical piano

41Hz - Lowest note on a bass guitar

58.27Hz - Lowest note on a bassoon

Typical notes on the electromonochord are between 15-40Hz.

The first trial used a simple galvanized steel wire, purchased at a hardware store. This wire was thin, probably smaller than 25 AWG, but worked quite well in many tests. It produced a clean sound through the pickup, but unfortunately was lacking in bass frequencies. Ultimately we decided against this wire because it was not strong enough. Through continued usage the wire would stretch and become lower in pitch. This would in turn force a retuning, and eventually the string would become too weak and break. | 114

The second test went to the other end of the spectrum, using a heavy-duty braided steel cable. These cables are extremely strong, and are often used in structural applications. This extra strength would also prove to be an issue, since it required quite a bit of tuning (and pressure) to raise the pitch to an appropriate level. At these high tensions the cables actually caused the body of the instrument to break, rather than the string. In addition, due to the large mass of these strings, they tended to produce dull low sounds, with few high harmonics, and they also required significant forces to actuate.

At one point we attempted to use guitar strings and cello strings. Both of these experiments proved unfruitful due to the short length of a typical string. Attempts at connecting multiple strings were immediately thrown out.

One of the more interesting tests involved using wound bass piano strings. These are the strings that commonly produce the lowest sounds on a piano. They are made of a solid steel core with a second steel wire wrapped around the circumference of the core in a spiral. This gives the string significant mass, thus requiring less tension to achieve lower notes. The main reason these types of strings were dismissed was the price and availability of extremely long lengths of this type of string. Lengths longer than 8 feet would have to be custom made, and were prohibitively expensive. Tests using shorter lengths were successful, but again required significant force to actuate the strings.

| 115

The final test proved successful, using unwound piano wire. This can be purchased in bulk from many piano manufacturers, and in various gauges. We used the heaviest gauge available, which measures roughly 1.5mm in diameter. Piano wire is made of tempered steel, and is incredibly strong, but also brittle. Its undesirable malleability properties made it difficult to wind around tuning pegs and attach to the instrument. This setback was solved using a special winding tool designed for piano stringing. The piano wire created a clear and defined sound through the pickup, despite being made of steel (most electric guitar strings, for example, are made of nickel-plated steel, since nickel conducts magnetic fields better than steel).

Actuator tests: Vibrational systems

As it relates to a robotic string instrument, the term “actuator” means anything that can induce vibration into a string. Some actuators give the string potential energy and release it (a pick, for example). But most actuators transfer kinetic energy into the string (such as a hammer). In two early tests, we attempted to couple the string directly to devices that have kinetic energy of their own.

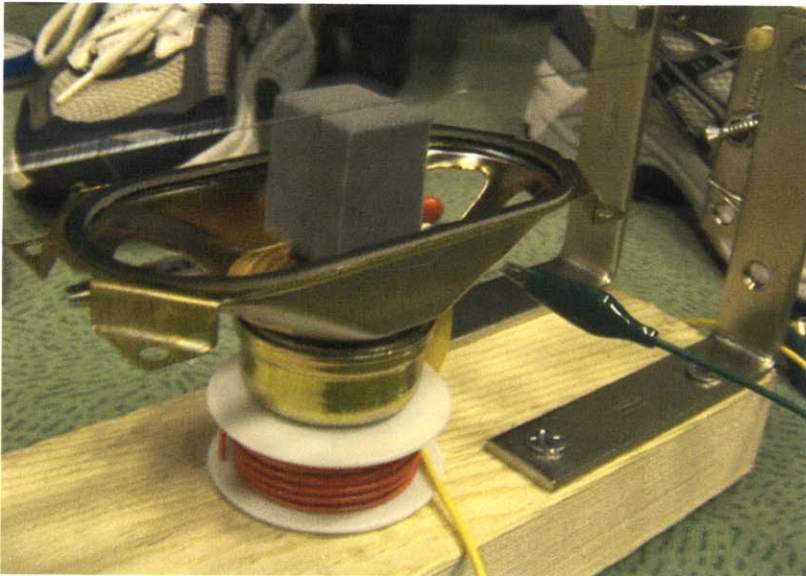

Fig. 4.13: The first testing apparatus using a speaker and sponge to vibrate the string.

Photo by Mike Fabio.

The first test involved coupling the string to a speaker element. For this test, we used an old computer speaker. These speakers are readily available, cheap, and have a decent frequency range and power response. Unfortunately many of the specs of this speaker could not be ascertained. The speaker cone was cut out and removed, and a small piece of sponge was glued directly to the speaker element. This contraption was placed directly underneath the string, with the sponge in direct contact. A signal generator was then sent into an audio amplifier which fed the speaker. As the signal plays through the speaker, the string vibrates at similar frequencies, depending on the tuning of the string.

116

Several types of action are possible here. For example, a single sinusoidal input will generally cause the string to vibrate at the frequency of the sinusoid, dependent on the tuning of the string and its partials. A sinusoid corresponding to any of the harmonics of the string will cause the string to vibrate violently. And a changing sinusoid can induce many unexpected frequencies, especially in the higher registers. In general, this actuation creates drone-like sounds.

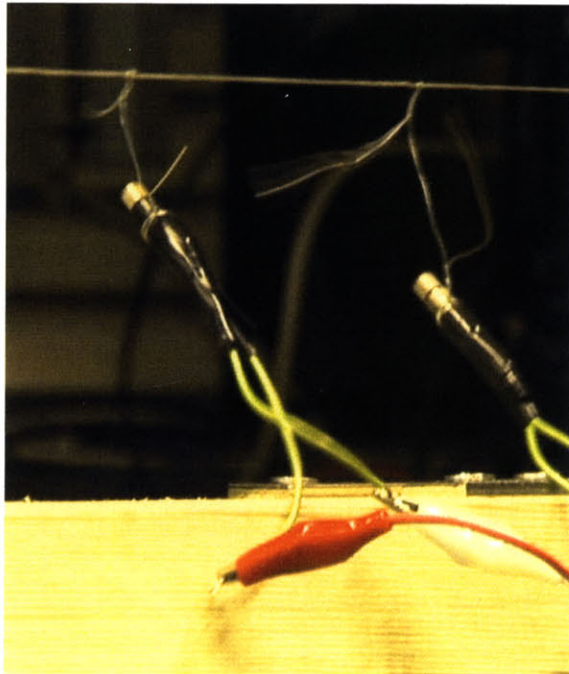

Fig. 4.14: An early test using vibrating pager motors.

Photo by Mike Fabio.

One particularly interesting use of this actuator is playback of complex sound material, such as recorded music. The string will sympathetically vibrate to the sound of the music, but given its mass and inertia it resists many of the frequencies of that sound. This creates a sort of lowpass filtering effect that continually rings, almost like a spring reverb.

Unfortunately this actuator is unreliable at best. Most speakers we tested required too much power to induce usable vibration in the string, thus causing most of them to overload and burn out. Also, due to many variables including the density of the sponge, the range of motion of the speaker, and the input signals, it was nearly impossible to predict the output sound exactly. Though many interesting sounds could be created, none of them were easily reproducible.

The second test using vibrational systems utilized pairs of vibrating motors like those found in pagers and cell phones. These tiny motors have low power requirements, and have a surprisingly wide range of speeds. The motors were attached directly to the string using wires or a metal bracket. By attaching two motors, each can be actuated at different speeds, creating interesting vibrational variation in the string. Though this system proved more robust than the speaker element and sponge, it was ultimately discarded because a suitable mounting scheme could not be designed. The vibration of the motors tended to shake them free from the string or loosen any wires or brackets that were attached.

Actuator tests: Electromagnets

On the other end of the spectrum from string-coupled devices are devices that can induce motion in the string without ever touching it. Early on, I became intrigued by the work of Alvin Lucier, and his experiments with *long string* instruments. In one of his most famous pieces, *Music on a Long Thin Wire*, he strung a single wire across hundreds of feet, often in a cathedral or atrium, and ran alternating current audio signal *through* the wire itself. On either side of the string were two opposite-poled permanent magnets. As the magnetic field created by the current in the string changes direction, the magnets pull and push the string to induce vibration. And so our first attempt at magnetic actuation involved a replication of this system.

But this proved exceedingly difficult. First, the permanent magnets we had access to were much too weak to cause any usable vibration. To compensate, we attempted boosting the signal, but this created so much heat in the wire that it melted right through. Clearly we needed a different solution. | 118

We turned our attention to the EBow, a magnetic actuator commonly used on electric guitars. The EBow essentially functions as a feedback loop. On one end of the device is a receiving coil, similar to a guitar pickup. As the string vibrates, it creates a signal which is fed into an amplifier. This in turn feeds another coil, which creates a magnetic field and moves the string, thus causing a feedback loop.

Early testing using an off-the-shelf EBow showed promise. Many interesting sounds were possible, but it was difficult to control on such a large

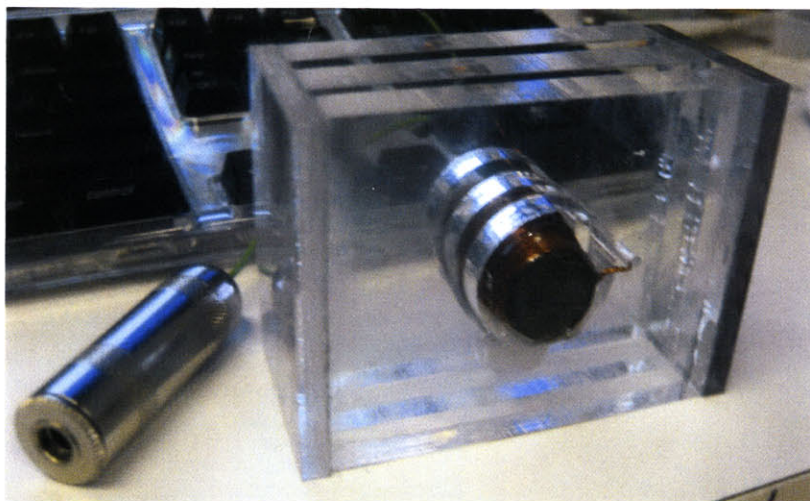

Fig. 4.15: The early handmade electromagnet actuator prototype.

Photo by Mike Fabio.

instrument. And the EBow is designed to work with the significantly thinner strings of a guitar.

This quickly led to the construction of a rudimentary electromagnet, which we built from a piece of cylindrical iron core and coated copper wire. The wire was wrapped (by hand!) around the core few times in order to keep its resistance low. We attached a 1/4" phone jack directly to the magnet so it could be fed from an off-the-shelf audio amplifier (Crown Audio XLS Series 300 Watt Amplifier).

This test proved instantly successful. Placing the magnet near the string produced sizable and controllable vibration. Different types of signals ranging from sinusoids to complex noise to a violin or a bass drum all created fascinating sounds in the string. This also allowed for an input from a microphone or a live instrument, creating a direct interface to the instrument.

119

The only drawback to the magnet we built was its relatively low duty-cycle rating. With constant use, it became hot, and it was necessary to either stop feeding audio into it or lower the signal. This problem was quickly solved in the final version of *The Chandelier*, as we will see.

Actuator tests: Rosin wheels

Background information on the hurdy gurdy can be found at
<http://en.wikipedia.org/wiki/Hurdy_gurdy>

A rosin wheel (sometimes called a rosined wheel) is a spinning disc with sticky rosin along its edge that rubs against a string, creating a bow-like sound. The most common instrument to use this type of actuator is the hurdy gurdy, a guitar-like instrument commonly used in French and Hungarian folk music. But the actuator has also been used to create “sustaining pianos” and other types of string instruments.

To build this actuator we found a scrapped gearmotor, which is just a DC motor with a gearbox attached to it to ramp down its speed and raise its torque. The gearmotor was attached to a block of wood, and at the end of its shaft we attached a wooden disc haphazardly cut from a piece of plywood. To the circumference of the disc, we attached strips of various materials to test their effects on the string. On each of these materials we applied a coat of Pops bass rosin, a sticky material commonly used on double bass bows. This was chosen for its stickiness and thick but runny consistency.

| 120

Faux-Leather - This test succeeded in creating vibration in the string, but the sound was generally dull and lifeless, and contained few high harmonics.

Rubber - Though we expected this material to work the best, it was in fact one of the worst. Huge amounts of rosin were necessary to get any decent sound from the rubber stripping. It is possible, however, that a different type of rubber could be used (the rubber used in our tests was simply scrap material we found laying around).

Sandpaper - Fine grit sandpaper made some interesting scratchy sounds, and thick grit sandpaper made harsh, loud sounds, but ultimately we turned away from sandpaper since it could damage the string.

Vinyl tape - This test was the most successful. A piece of vinyl tape (electrical tape) with a thick coat of rosin creates a rich sound full of harmonics. It is capable of being run for long periods with good sustain, but the rosin needs to be reapplied with wear.

Since none of these worked perfectly, we created a second disc from acrylic, which was finely machined on a laser cutter. Rosin was applied to the outside of the disc, and placed directly against the string. Unfortunately this required huge amounts of rosin to create any sound at all.

Actuator tests: Weedwackers

Of all the strange ideas we threw at the electromonochord, none was as successful as the weedwacker. It is so named because of its resemblance to a string trimmer mower commonly used to cut grass. Our version was built from a high-RPM DC motor and a plastic cable tie. The cable tie was wrapped tightly around the shaft of the motor and secured using glue. A small current causes the cable tie to swing quickly, striking the string many times per second, and creating a plethora of interesting sounds. | 121

The plastic cable tie creates a tight percussive click each time it hits the string. At high speeds, this becomes more of a buzzing sound. As the speed of the motor is adjusted, it creates yet another sound, containing certain clear frequencies and a number of unpredictable partials.

Eventually we moved away from the plastic material and built a sort of plectrum from machine cut silicone. The silicone material doesn't have the sharp attack of the plastic, which is both positive and negative: the

noise of the actuator hitting the string doesn't cover up the vibrations of the string, but at the same time it doesn't have the appeal of many of the other robotic actuators, which actually sound like *robots*.

Actuator tests: Hammers

The earliest tests of hammers involved using piano hammers attached to a rotary solenoid, which turns a partial rotation on application of electrical current. Though this provided interesting sounds, it was much too similar to that of a piano. And the solenoid did not provide exactly the right action; after all, the action of a piano key is the result of hundreds of years of engineering.

We built our own hammer using acrylic. Our hope was that the plastic would provide a much different sound than the felt of a piano hammer. This hammer was then also attached to the rotary solenoid. It did provide a much clearer attack than the piano hammers. We also attached other materials to the hammer, like rubber or metal, and these too created interesting sounds unlike a piano. But the acrylic hammer was evidently too heavy, and the action was too slow. A higher torque solenoid could be used, but we opted for another method.

We purchased several linear solenoids from SAIA Burgess. These are traditional push-type solenoids that only move in one direction when current is applied. At the end of the solenoid is a shaft, to which we attached a metal hammer. This proved successful: action was fast (only a few milliseconds from onset of electrical current), the sound was metallic and not quite piano-like, and it would be exceedingly simple to build con-

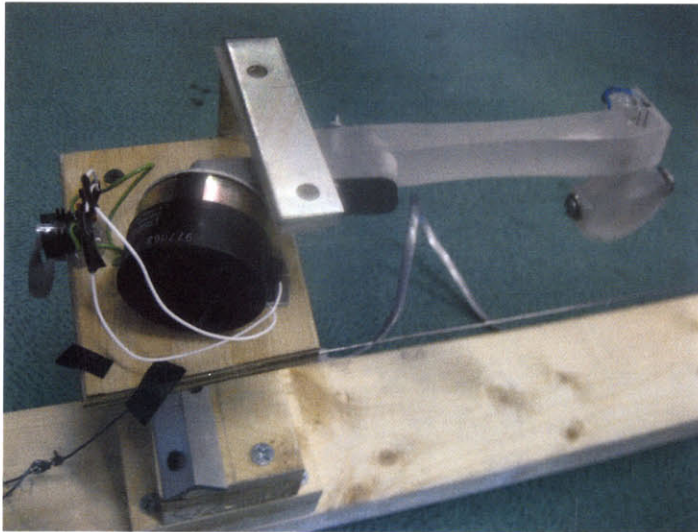

Fig. 4.16: The acrylic hammer actuator.

Photo by Mike Fabio.

trol electronics for it. The only drawback is that the instantaneous current draw of a solenoid is rather high. It would therefore be necessary to limit the current draw, limit the time of current flow, or apply a pulse width modulated current.

It should be noted that one of the more interesting uses of the acrylic hammers was as a light diffuser, allowing the actuator to function as a visual aid as well. The acrylic was coated with a frost paint that makes the surface translucent. A blue LED was placed near the base of the hammer, and this LED was attached to the control voltage so that it would light every time the hammer activated.

Actuator tests: Pluckers

Each of our tests of plucking devices were largely deemed failures. Due to the large size of the string, a strong plectrum (such as a guitar pick) was necessary in order to prevent breakage. But with such an inflexible material, a great deal of force was necessary to push the plucker past the string. | 123

The most successful test involved a lever arm with a pick at one end. The lever is pushed with a solenoid and the plectrum plucks the string. The lever then returns due to the force of gravity, and as the pick passes the string, a one-way lever allows it to pass without plucking. Though this test worked, the mechanism was too complex and difficult to construct for the final instrument.

What to make of the results

The results of the actuator tests allowed us to settle on at least four designs to implement on the next prototype of *The Chandelier*:

1. Electromagnets
2. Rosin wheels
3. Weedwackers
4. Hammers

Each of these actuators produced usable sounds, and with minimal alteration could be implemented directly from the original designs.

The most important consequence of these tests is that they codified the obstacles we faced in moving forward. There were clearly defined constraints on the types of actuators, the sounds they made, and their ability to quickly and effectively transfer action into sound. If this instrument was to be playable, the actuators needed to offer more than a single action or sound.

124

We also realized the difficulty in building a multi-stringed instrument. Indeed building a single-stringed instrument from a piece of wood proved difficult enough.

Moving forward, a great many unknowns remained. What kinds of forces would multiple strings induce? How can we control an instrument with so many actuators? And just what would this thing *sound* like?

4. *The Chandelier: A Full-Scale Prototype*

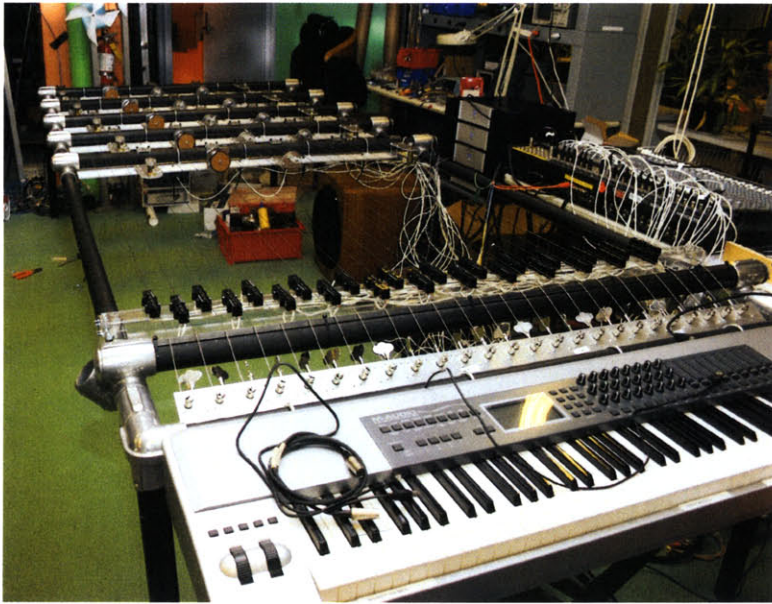

Fig. 4.17: *The Chandelier* prototype, with keyboard controller.

Photo courtesy of Brian Demers.

While the electromonochord represented a testbed for sonic experimentation with long-stringed instruments and robotic actuation, it hardly resembled a usable musical instrument. To this end, we proceeded to build a full-scale prototype of a single “wing” of *The Chandelier*. This prototype has served not only as a design platform and sonic example, but also as a usable instrument in itself, and has been successfully tested in public installation and with individual users.

The full-scale prototype is directly related to the electromonochord in its design. 25 strings, each with a single pickup and single actuator, are strung one after another onto a steel frame. But it is in fact much more: a platform for manufacturing design experimentation; a sonic sandbox for textural sound design; and a testbed for electronic control mechanisms. It is, after all, a prototype, as near a representation of the final design as could possibly be constructed.

125

Designing and building the instrument body

In order to prevent complications from the tension of the strings, we chose to build the body of the instrument from steel pipe. The electromonochord, built of wood, developed a significant bend over time, and the wood became warped and twisted under the uneven pressure. Steel would help us avoid this problem, and by using pipe the weight could be cut down slightly.

Hollaender Manufacturing makes Speed-Rail fittings for black iron pipe

<<http://www.hollaender.com>>

Black iron pipe was acquired from Metropolitan Pipe Company, Cambridge, MA

<<http://www.metpipe.com>>

We used 1.5" IPS black iron pipe, commonly found in theater applications for hanging lighting. Note that 1.5" IPS (Iron Pipe Size) is not 1.5" in diameter; the outside diameter of the pipe is 1.9". The frame is held together using several types of Speed-Rail connectors and elbows, made by Hollaender Manufacturing. These connectors allow for rapid assembly and are rated for many hundreds of pounds of pressure.

The outer frame of the instrument is a rectangle, approximately 12.5 feet long and 5 feet wide. At each corner is a three-way connector, which allows for legs to be attached. The legs are just under 3 feet long and elevate it high above the ground, allowing for easy access underneath the instrument.

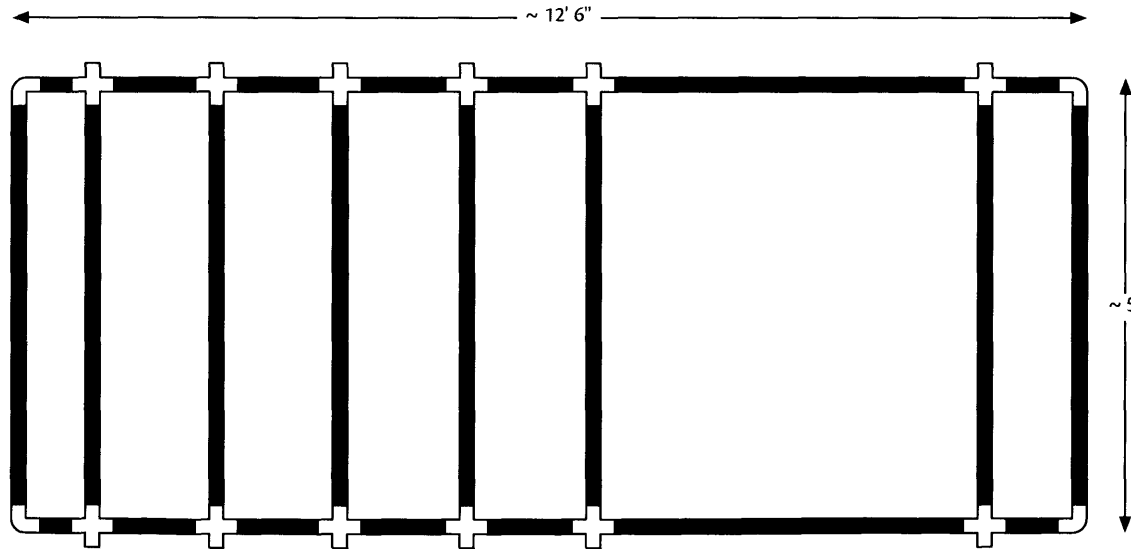

Note: Drawing not to scale

Fig. 4.18: Bird's-eye view of *The Chandelier* frame.



Fig. 4.19: The individual bridge assemblies are visible just next to each actuator.

Photo by Mike Fabio.

Mounted above the rectangle frame were 6 crossbars. One of these functioned as a bridge for all the strings, and sat about 6 inches from one end of the frame. The other 5 crossbars served as bridges of different lengths, allowing for 5 different lengths of string. These were evenly spaced at approximately 1.5 foot intervals from the end of the frame opposite the main bridge. At each open end of the pipes, a small cap was placed to prevent injury and clean up the appearance.

For the bridges we used 1" steel L-brackets. The main bridge is a solid length of just under 5 feet, and is attached to the main bridge pipe using plastic cable-ties (which, despite their appearance, are remarkably strong). On each of the five secondary bridges, five smaller bridges are attached, each 2" long. These are arranged in a cascade pattern, such that each set of five strings (counting from left to right) has one string of each of the five lengths. This pattern is repeated five times, for a total of 25 strings.

The tuning board

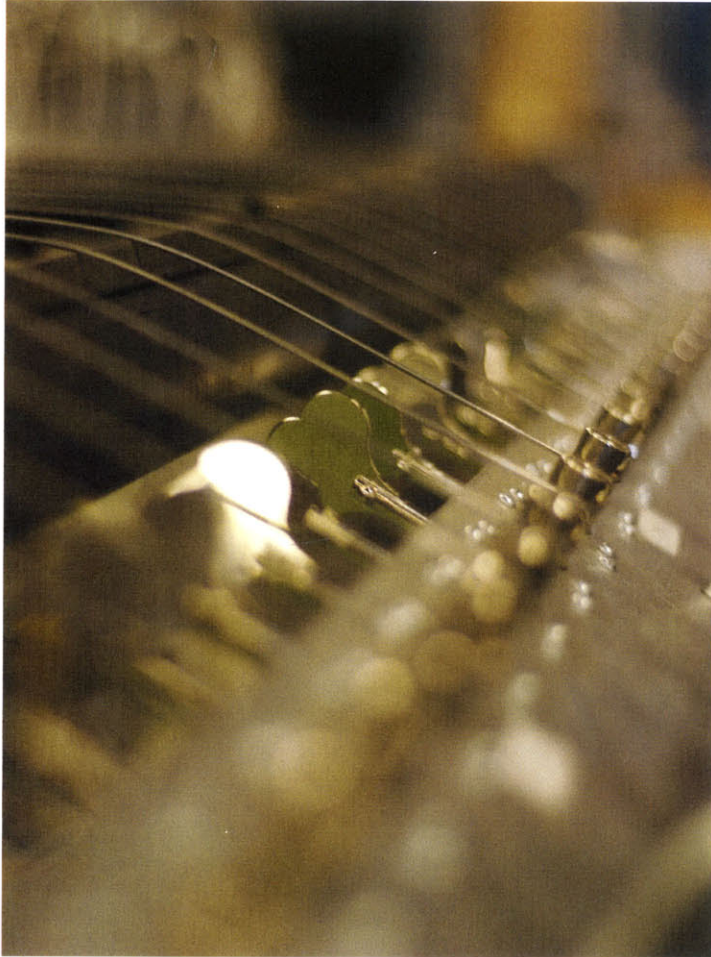

Fig. 4.20: The tuning board.
Photo courtesy of Brian Demers.

At the end of the frame nearest the main bridge, a 1'x5' length of 1/4" aluminum sheeting was bolted at an angle. This sheet was cut using a waterjet so that 25 bass guitar tuning pegs (Fender Replacement Vintage Bass Nickel Tuners) could be mounted 2" apart. These tuners provided just the right tuning action: the long length of the strings coupled with their low pitches allow for both coarse and fine tuning.

The tuning board was angled slightly so that net torque around the frame would be minimized. The tuners were angled in toward the instrument, and are obstructed by the strings that pass over them. This prevents accidental adjustments.

The pickup bar

Twenty five bass pickups (Seymour Duncan Basslines Vintage Jazz Bass Pickups) were used to amplify *The Chandelier*. We used a 5 foot length of 1.5"x1.5" polycarbonate square tubing to build a "pickup bar" that stretches the width of the instrument just underneath the strings. The pickups were screwed directly into hand-threaded holes in the tube, and were staggered so they could be spaced 2" apart. We soldered a length of two-conductor wire to each pickup, which entered the tube through a small hole and was threaded through to one side of the bar. At the other end of each wire, we soldered a 1/4" audio connector, and labeled them sequentially. Each pickup was then run into a large-format Mackie mixing console to combine their signals and provide equalization for independent channels.

Stringing the instrument

The strings on the chandelier were all cut at approximately the same length, just over 12 feet. The functional length of the string was determined by the distance from the main bridge to the secondary bridge.

At the far end of the frame nearest the secondary bridges, each string was wrapped tightly around the pipe and looped through itself. The string was then threaded underneath each crossbar except at the corresponding secondary bridge. The string then ran across the length of the instrument, over the main bridge, and into the tuning peg. By threading each string under the secondary bridges, we were able to minimize extra vibrations in the strings. Beneath each crossbar is a thin piece of foam, which also helps to quell vibration.

The actuator mounting boards

Beneath each crossbar we mounted a sheet of aluminum similar to the tuning board. This sheet lay parallel to the instrument. Each aluminum sheet was cut with an identical pattern, but shifted 2" for each. This allows for five different actuators to be placed on each board, with each actuator on every length of string.

We decided early on that the mounting holes should follow a universal pattern. This would allow for any mount to be placed at any string. The mounting holes are arranged in a square, with the holes slightly oblong. This shape allowed for fine adjustments in the positioning of each mount before tightening down the screws. Each mount was cut to have oblong holes in the perpendicular direction to allow lateral positioning.

Actuators: Electromagnets

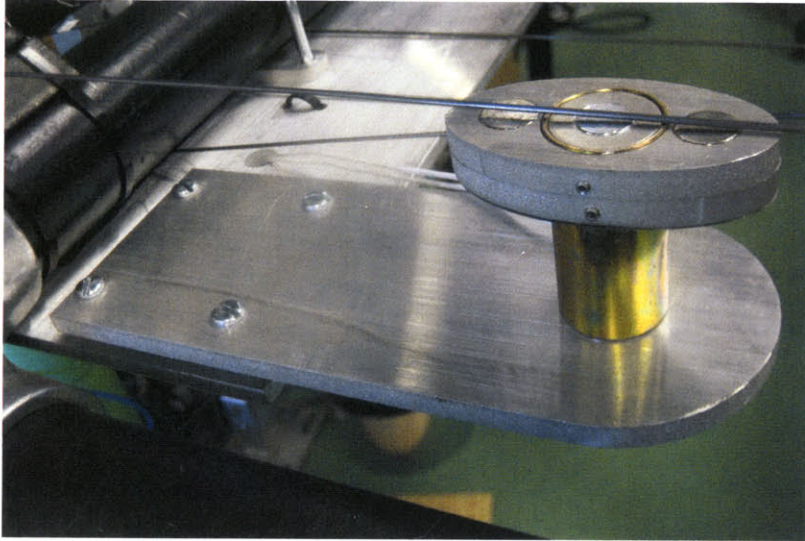

Fig. 4.21: The electromagnet actuator and mount.

Photo by Mike Fabio.

Backer, Steven, Edgar Berdahl and Julius O. Smith III. 2005. If I Had a Hammer: Design and Theory of an Electromagnetically-Prepared Piano. In *Proceedings of the International Computer Music Conference 2005 (ICMC 2005)*.

The electromagnets built for the electromonochord sported a fatal flaw: at high voltages, the magnet would heat up significantly, damaging the wire coil. In order to avoid this problem, it was necessary to spec exactly the right magnet for the job. We settled on a tubular electromagnet from electromechaniconline.com. This site makes custom magnets based on voltage/current and magnetic force requirements. The specific model of magnet we used was E-20-100-26. This magnet has an internal coil of 26 AWG, creating a resistance of approximately 7.1ohms. We chose this magnet because it closely matched the impedance of a standard audio amplifier, which is 8ohms. The magnet's low resistance translates to less current being transferred to heat, and thus solving the overheating problem.

The magnets are mounted to an aluminum "diving board," a small piece of aluminum sheeting with a rounded end. A single machine screw was used to attach the magnet to the diving board, and each diving board was attached to the mounting boards.

At the top of each electromagnet, we placed two sets of rare-earth permanent magnets with poles facing in opposite directions. These permanent magnets keep a constant magnetic field in the string so that smaller magnetic forces from the electromagnet have more effect. This technique borrows heavily from Steven Backer, Edgar Berdahl, and Julius Smith's "electromagnetically-prepared piano."

Actuators: Rosin wheels

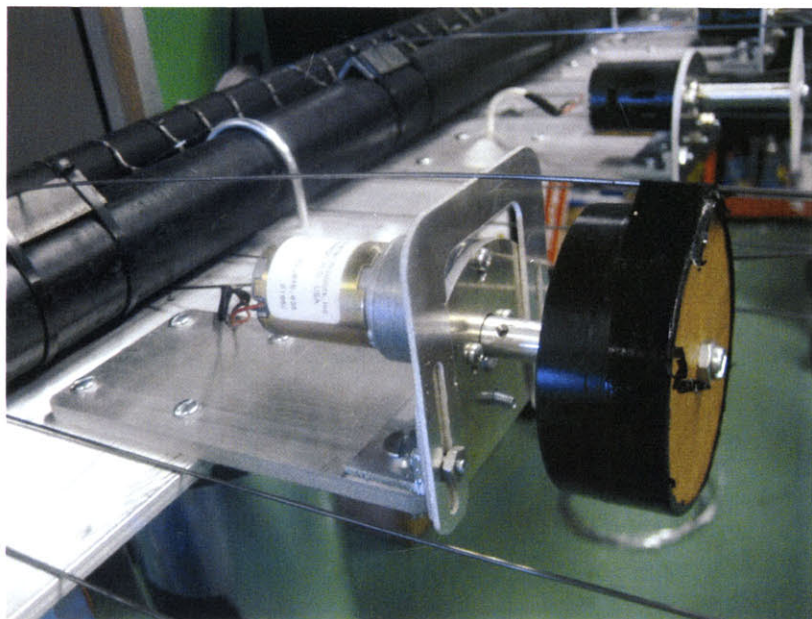

Fig. 4.22: The rosin wheel actuator and mount.

Photo by Mike Fabio.

The rosin wheels we implemented for the full-scale prototype take a different approach than those built for the electromonochord. Whereas the original rosin wheel butted against the string and rubbed it directly, the new version utilizes a loop of vinyl tape that drags across the top of the string and wraps around the wheel like a pulley.

The wheels were built from blocks of solid cherry wood, and hand-carved on a lathe. The circumference of the wheel is wrapped in a layer of vinyl tape. The wheel was then attached to a hand-lathed metal shaft, designed to elongate the shaft of the actuator motor.

The motors we used were 12V DC brushless gearmotors made by Buehler Motors (model 1.61.046.035). Because the motor has an internal gearbox, it is able to deliver high amounts of torque with low current; but this also means that it spins much slower than a typical DC motor. Fortunately for our application we *needed* a slow-spinning motor, so this option seemed ideal.

To mount the rosin wheels, we built a modified “diving board,” this time with an L-bracket at the end and a second plate perpendicular to the main mount. This allowed for face-mounting of the gearmotors. To this we also attached a second U-shaped bracket that could be vertically adjusted. This bracket has a single notch at its top and is pressed against the string, creating a secondary bridge. The purpose of this is to create a bridge as close to the rosin wheel as possible, allowing for the production of higher harmonics and scratchier sounds, a sort of *sul ponticello* effect.

Actuators: Weedwackers

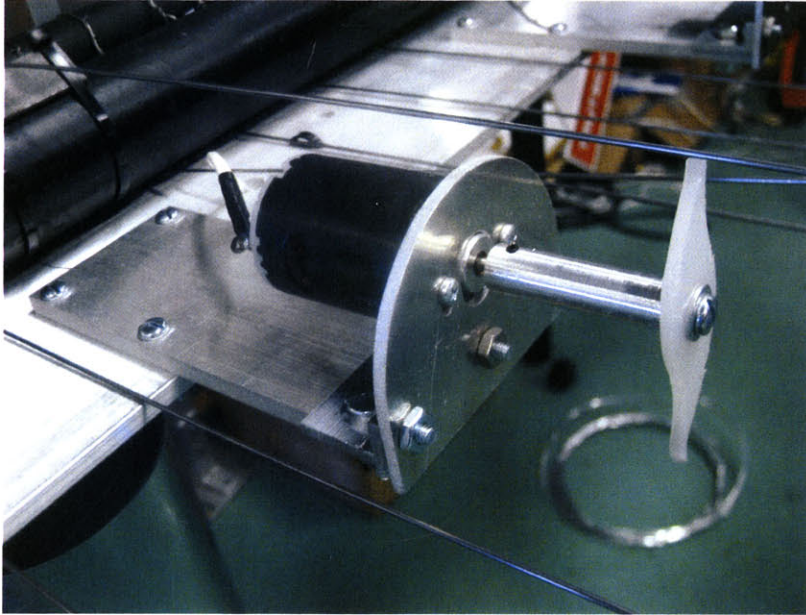

Fig. 4.23: The weedwacker actuator and mount.

Photo by Mike Fabio.

The design of the weedwackers was taken directly from our early experiments. It is a high-RPM DC motor (Fu Wang/Fully model FRS-540S) with a machine cut silicone plectrum attached to a metal shaft extension. The plectrum is screwed directly into this shaft extension.

We mounted the weedwackers using an identical mounting bracket as the rosin wheels, but without the extra “bridge” bracket. This mounting system allows for a slight range in vertical adjustment in order that the plectrum can be placed just at the string level.

Actuators: Hammers

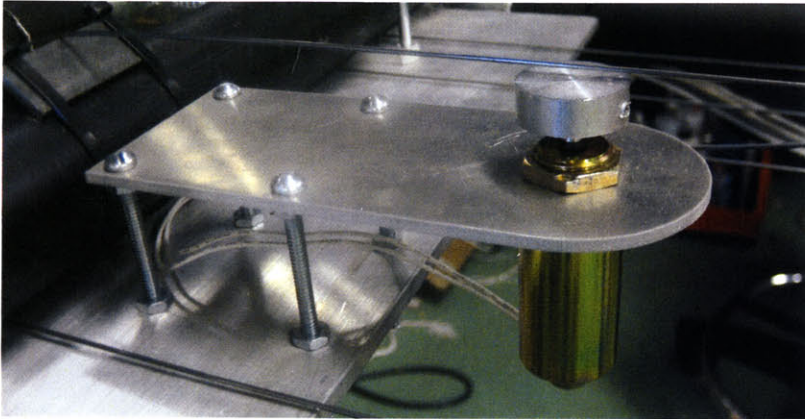

Fig. 4.24: The hammer actuator and mount.

Photo by Mike Fabio.

The Chandelier's hammers consist of a single solenoid with a metal striking plate. For this we used SAIA Burgess push-type solenoids (195207-228). The metal striking plate is a small piece of hand-lathed aluminum, and is attached directly to the protruding shaft of the solenoid. The striking plate serves a dual purpose: it not only hits the string, but it prevents the solenoid shaft from falling out of the solenoid due to gravity. After the solenoid is actuated, gravity pulls the shaft toward the ground, and a small rubber gasket prevents the clicking that would normally be heard when the striking plate returns to its steady state.

The hammer actuator is mounted on an elevated "diving board." The board is mounted on four threaded rods, which are adjustable by tightening several nuts at the base and near the board. This allows for the striking plate to be placed near the string to minimize the flight distance of the hammer.

133

Unfinished actuators: Rapid pluckers

The final set of actuators has, unfortunately, not been completed. This actuator is similar to the weedwacker, but uses a plastic plectrum to pluck the string many times per second. This is not dissimilar from the original design of the weedwacker using a plastic cable-tie.

Control electronics

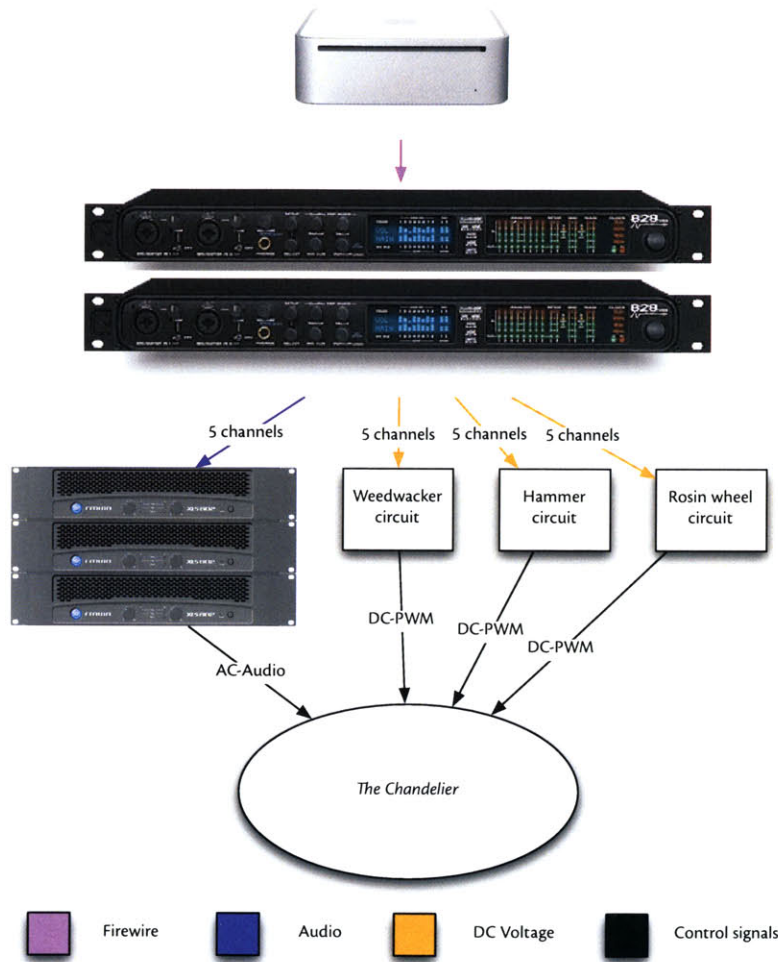

Fig. 4.25: Schematic of the control electronics

Controlling many actuators is a difficult endeavor. It requires careful regulation of power, signals, and switching. In this case, most of the control duties are handled by a computer running MAX/MSP. But in order to properly interface this computer with the motors and other actuators, it was necessary to build some simple circuits that are controlled by, strangely enough, audio signals.

It was never my intention to build the control system like this; given the chance to do it again (and quite a bit more time), I would have built a microcontroller circuit to handle control. But due to the various deadlines we faced during this project, it was prudent to build the system using the equipment and parts we had available and with the methods I was already familiar with.

At the heart of the control system is a pair of MOTU 828 audio interfaces. These interfaces are typically used for input and output of sound for computer recording. But it turns out the 828 is capable of much more: using MAX/MSP it is easily possible to output a DC voltage from any of its 10 outputs. Since we needed the ability to output both high-quality audio (for the electromagnets) and pulse width modulated DC voltages (for the other actuators), the 828 seemed a natural choice. In addition, the 828 quickly connects to the computer using a single firewire cable.

First I tested the output levels of the MOTU 828. MAX/MSP allows for any type of signal to be output, so I wrote a simple patch to output a sliding digital floating point signal between -1 and 1. These values corre-

spond to an output voltage of -4.7V and 4.7V , respectively, as tested with a multimeter attached to the output.

For the electromagnets, no circuit would be necessary; it required only a standard audio amplifier. We chose the Crown XLS Series amplifiers for their rugged construction and excellent audio quality. The audio outputs from the MOTU 828 are run directly to three of these amplifiers, and the output from the amps is routed to the corresponding electromagnet. This effectively takes an AC audio signal and amplifies it through a magnet, which provides a resistance similar to a speaker.

The other actuators, however, required custom electronics. Fortunately, the system allowed for each of the control circuits to be nearly identical. The circuit consists of 5 TIP31C transistors, which are rated to currents well above 1A. Since some of the actuators (like the weedwackers and hammers) require large amounts of current (though in spikes), this component provided ample handling of heat dissipation with accurate switching. | 135

The circuit then appears like this:

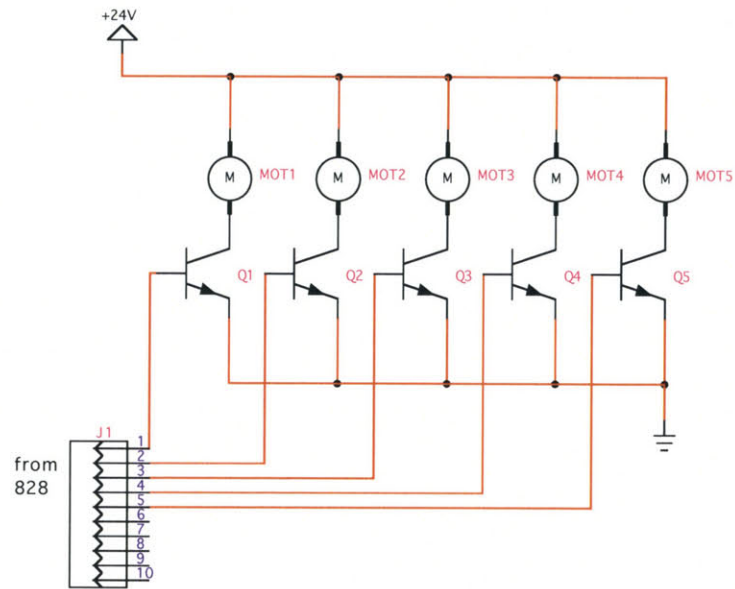

Fig. 4.26: Control electronics schematic

This circuit takes a supply voltage of 24V (this is for the rosin wheels; the other actuators require different supplies) and modulates it based on the output from the 828. A pulse width modulated signal is generated in MAX/MSP.

Pulse width modulation results in an easy to use speed control. By altering the duty cycle, the speed of a motor can easily be varied. Since a PWM signal is simply a square wave, its average value (the average voltage) can be easily calculated as

$$V_{ave} = D * V_{max}$$

Where D is the duty cycle and V_{max} is the supply voltage.

To this circuit we eventually added a capacitor between the supply and ground. This helped to filter some of the high frequency, high voltage signal. The DC motors, because they contain a magnetic coil inside, emit the high frequencies of their input signal, which travels through the string and is picked up by the instrument as electronic noise. This was audible as a buzzing corresponding to the rate of the PWM.

Controlling The Chandelier: A simple keyboard mapping

Because *The Chandelier* closely resembles a piano in physical appearance, it seemed natural to control it using a MIDI keyboard. This turned out to be an effective controller for several reasons: it provided just enough degrees of input sensing, it is easy to understand and play, and the relationship between the instrument and the keyboard is visually suggested by the strings-to-keys mapping.

| 137

For this, I wrote a rudimentary MAX patch that converts MIDI input to PWM (for the motors), an impulse (for the hammers), or audio (for the electromagnets). The mapping is a simple one-to-one, key-to-string relationship: as a key is depressed, a string begins vibrating. In the case of the rosin wheels and weedwackers, the velocity of the input note is translated to speed of the motor, such that the harder the key is pressed, the faster the motor spins. The hammers are sent a 10ms impulse, which fires the hammer quickly and releases it.

The electromagnets have a slightly different mapping, however. For each key there is a corresponding audio file that is being constantly looped. For this I used four audio samples, each of significant length:

1. *Lisbon* by Keith Fullerton Whitman, an electronic piece lasting nearly an hour with many complex sounds.
2. *Music on a Long Thin Wire* by Alvin Lucier, a piece conceived using a single long wire that creates lush droning sounds.
3. *Devices and Strategies* by Solvent, a piece with rich analog synthesizer textures and plenty of drums.
4. *Shine* by The Album Leaf, a melancholy piece at a slow tempo, contains many acoustic instruments including heavy drums.

As the key is depressed, the audio “cuts in” wherever the piece happens to be in its loop. Releasing the key releases the audio. This technique creates constant variation in the audio being played through the strings, and generally results in rich drones and softly undulating bass.

5. ————— **Playing *The Chandelier* in Installation and the Laboratory**

It is extraordinarily difficult to test the efficacy of a musical instrument, especially a new one. There is no rubric, no metric—or at least no *standardized* system of measurement. Therefore most musical instrument design is judged subjectively, based almost entirely on whether the instrument *sounds good*.

There are, of course, certain features of an instrument that can be measured. The audio can be analyzed for spectral qualities. Playability can be measured in terms of resistances and weights and notes-per-second. And an instrument can be objectively judged on whether it achieves a specific

goal or demonstrates some axiom, such as “this drum pad can not be distinguished in feel from a real drum in a blind test.”

All of these distinctions, all of these tests, don't just miss the point of instrument efficacy, they *deny* the point. I do not suggest any new method of testing an instrument; indeed my only real experiment with *The Chandelier* is to simply play the thing. And that, in so many words, is exactly why we strive to build new instruments. It is not our intention as builders, engineers, as musicians or artists, to supersede the instruments that have come before us. We can only hope to supplement the tools of music making that already exist. To judge our instruments against those that have existed for many hundreds of years may be an interesting measure, but it ignores the most important question: *does the instrument make good music?*

| 139

It is with this in mind that I proceeded toward several real-world tests of *The Chandelier*. If I stray into the realms of playability measurement or mapping studies, it is out of necessity (insofar as science requires it). But as a musician, an inventor, and a lover of music, my only mensuration is the beauty of my instrument's sound and the music it creates.

Library Music: An installation.

In January of 2007 I carried out my first real-world tests of *The Chandelier* by installing it in a public exhibition at the MIT Music Library. The exhibit, called *Library Music*, allowed the public to view several projects created at the MIT Media Lab and to actively participate in their use. Over the five days the exhibit ran, *The Chandelier* was played by well over

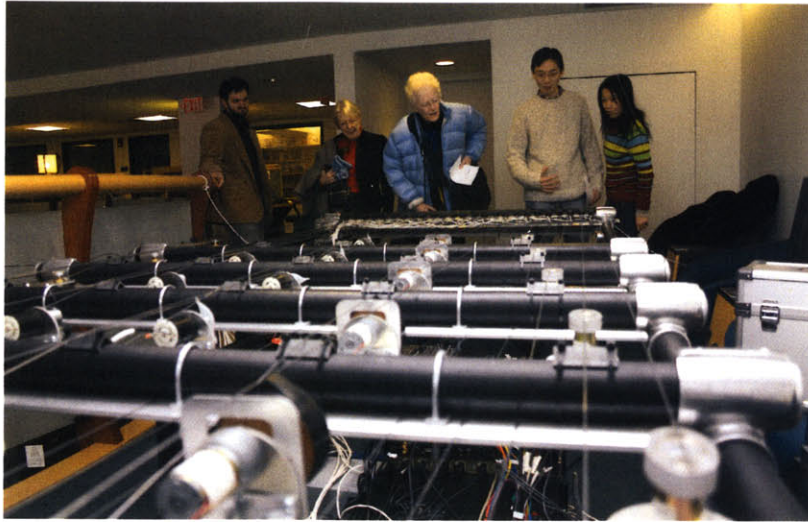

Fig. 4.27: Visitors play *The Chandelier* at the *Library Music* event.

Photo courtesy of Brian Demers.

one hundred people . Many of these interactions were videotaped, and I actively instructed many participants in the use of *The Chandelier*.

My findings were not surprising. In fact, most of my observations from this exhibition match those from *Music in the Garden* exactly. Age discrepancies between participants matched that of *Music in the Garden*, and again I found a strong link between simple, one-to-one mappings and audience understanding.

But what I didn't expect was the audience's *reaction* to this instrument. Being so closely involved with this machine on a daily basis has desensitized me to the threatening nature of the beast. Even at MIT, where we are surrounded by robots in our labs, offices, and homes, a robot of this size is intimidating. And its whirling rotors, grinding gears, and ominous rumble don't help to calm the nerves. With time one can learn to play *The Chandelier* just like any other instrument, but the robotic nature of the thing never disappears.

140

Not all robots are frightening, though. We have robots that vacuum our floors, and robots to make our coffee, and we never flinch when we ask these machines to carry out their drudgery. They are pawns in our game of life.

But when we are faced with complete control, and the ability to set into motion the mechanics of a machine much larger than ourselves, we are set aback. Just as the average person would not sit behind the controls of a backhoe, the average person hesitates at *The Chandelier*. Despite its harmless nature (it is only a musical instrument!), the dangers are present, if only in our minds.

Of those not afraid to approach *The Chandelier*, I found that many had some musical background already (though the general population of MIT is perhaps a poor sampling, and likely skewed toward extensive musical background). These participants quickly took to the instrument not because of its playability or its appearance, but because of its sound. *The Chandelier* can be a loud instrument, and at the very least it is attention grabbing. Its sounds are not like any traditional instrument. They are at once organic and electronic. And they can't help but be noticed. Indeed many of *The Chandelier's* sounds defy the size of the instrument itself: the high screams of the rosin wheels are clearly unusual for an instrument over 12 feet long.

Nearly all of the participants I questioned noted the resemblance of the sound to a motion picture soundtrack, particularly those in the horror genre. Though this was not my intention in designing *The Chandelier*, I cannot deny or denounce its usefulness as a sound design tool. Because it is not a synthesized instrument, it sounds somehow more present, more real, and therefore more frightening in terms of horror soundtracks.

I also found that many children were fascinated not by the sounds that *The Chandelier* makes, but by the visual impact of the actuators moving. In all of my video documentation of the event, every child that plays the instrument instantly moves away from the electromagnets, and toward the more visually exciting hammers and weedwackers. Because the keyboard used in the installation was a full 88 keys, it is difficult for small children to play more than a small range of notes at one time. In general, most children chose to play one or two notes, and play more with rhythm than timbre.

The question of pitch

In nearly every test I've conducted with *The Chandelier*, whether in an installation or in the laboratory, one question comes up more than any other: *can you tune it?*

The simple answer is yes, of course it can be tuned. It has tuning pegs for that very reason. And in fact, it would even be possible to tune the instrument to a standard scale. I could, for example, play *Mary Had a Little Lamb* on *The Chandelier*, albeit in a deep bass register.

Questioning the tonality of the instrument is futile, though, since it was never my intention of designing a tonal instrument. I never meant to build something capable of playing scales and melodies, only textures and noises and crashes and drones. From the onset, this instrument was designed for a specific purpose: to speak, in musical terms, for Simon Powers after his death. Simon Powers is a complex character, a distraught and hubristic man, trapped somewhere in the netherworld of powerful yet actionless people. To build an instrument that sounds like a violin would be a great accomplishment, but would not meet the particular goals of the project.

In addition, I never wanted *The Chandelier* to be compared to a traditional instrument. How could I ever compete with the elegance and beauty of a cello? No, *The Chandelier* is something else altogether, some grey area in between the realms of acoustic and synthesized, human and machine. And that is exactly what it was intended to be.

Up close and personal: Individual testing

Testing on the public is a great way to get an overall impression and to observe how different types of people approach an object in an open space. But there are several variables that can easily skew the results: inhibitions are high in a public setting; a casual wander through an exhibit doesn't afford the time to learn the instrument; and constant ambient and background noise can obscure the sound of the instrument.

Testing on individual players, however, gives a much better sense of how the instrument can be played, and how a trained musician approaches a new musical tool. To this end, I have conducted informal tests in the laboratory by myself, with my colleagues, and with my bandmates (who in their wildest dreams never thought of playing an instrument like this).

The most noticeable difference between tests with the public and tests with individuals is the amount of time they spend, on average, learning the device. They first approach the keyboard with hesitation, pressing one or two keys. As soon as they realize that their actions won't cause the robot to explode, their comfort level instantly rises. They begin to press more and more keys, finding which keys control which actuators. They try different dynamic levels, and different combinations of sounds. Often they will focus on a single actuator that has caught their ear. Some players prefer the delicate drones they can achieve by holding the electromagnet keys for extended periods, while others prefer the quick and raspy sound of the metallic hammers.

Perhaps the most important observation I've made from individual testing is the inadequacies of the keyboard as a controller. Although the

keyboard is instantly understandable on a graphical level (i.e. keys correspond to individual strings, and are sequential from left to right), it is clearly deficient in many ways. For one, a single key on a keyboard only has two degrees of freedom: on/off, and a velocity number. Although this is easily mapped to *The Chandelier*, it does not afford any degree of control beyond note triggering. I attempted to add other degrees of freedom, such as the use of the pitch bend wheel, and this was effective in implementing continuous control over motor speeds. But using a pitch wheel requires a second hand to control.

The next chapter of this thesis describes a prototype laser harp controller that attempts to solve many of these problems. It is still a work in progress, but it presents a proof of concept on a tight budget that even an amateur could build.

6. ————— Future Work and Other Thoughts

While *The Chandelier* represents over two years of work, it is still a work in progress. As such, there are several unfinished features that will someday make their way to this instrument, including completely redesigned electronics, several new types of actuators, a damping system, and, of course, a fully constructed final version of the robotic set piece for *Death and the Powers*.

Rebuilding the electronics

The least reliable piece in the entire *Chandelier* system is the electronics. When I designed the electronics originally, I was working with limited

knowledge, and even more limited time. Because of this, I needed a system that I could implement quickly, and with the parts I had available to me at the time.

I intend to build a new system that removes the clumsy computer/audio interface combination and replaces it with a more robust microcontroller setup. Given the dramatic decrease in cost of microcontrollers—along with the increase in memory and functionality—it seems an ideal solution. Some preliminary testing using Atmel chips on the Arduino platform confirm the efficacy of this solution.

In addition, I would love to build a “megabox” that contains all the control electronics in a single rack-mounted package. At the moment, the electronics are all constructed on makeshift breadboards and connected by tangles of wires. This can easily be avoided by careful integration of the control circuits, power supplies, and microcontrollers on a single printed circuit board in a portable case. This will also make the system more portable. | 145

Finally, I would like to move away from the MIDI protocol and toward a more robust solution like OSC. Whereas MIDI can only be transmitted over short distances, and it is a painfully slow protocol, OSC is exactly the opposite. Because OSC relies on ethernet networks, it is possible to transmit over distances up to 300 meters. OSC can also transmit any type of data, be it sound, control messages, etc. And since OSC is open source, it has been ported already to many microcontrollers, and frameworks exist for quickly and easily implementing this system into embedded devices.

New actuators

The Chandelier is capable of a wide range of sonic textures, but there is always room for more. I intend, at the very least, to finish the final set of actuators on the prototype instrument, the rapid pluckers. These actuators are described earlier in this chapter.

When fully constructed, *The Chandelier* may contain more than 100 strings. Therefore, 5 actuators may not provide nearly the amount of variety necessary. In early testing on the electromonochord (and some failed attempts on the later prototype), we brainstormed a large number of actuators that we have not yet implemented, such as rotational picking devices or harpsichord-like pluckers.

I also hope to improve upon the actuators already in place. The hammers, for instance, have no dynamic control. I hope to implement velocity sensitivity for the keyboard controller to fire the solenoids at different speeds.

| 146

The rosin wheels need a more robust loop over the string; vinyl tape is too weak, too thin, and too difficult to replace. It also does not hold rosin for extended periods of time. I hope to do some tests using loops of rubber or a thicker type of plastic than the vinyl tape. Ideally this loop would be a continuous piece of material, and would rarely need replacing.

Dampers

The great missing link in the whole *Chandelier* system is a damping mechanism that can stop the string from vibrating. At the moment, any

actuation leaves the strings vibrating indefinitely. Since some of the strings can vibrate for well over 4 minutes from a single hand pluck, *The Chandelier* tends to constantly make noise.

A damper can be either mechanically or electronically paired to an actuator. Pianos, for instance, use a mechanically paired damper that lifts from the string on a key press, and then returns to the string as the hammer moves away. It may, however, be more appropriate to build an electronically controlled damping system, that damps and releases depending on the electrical signals being sent to the actuators. This would allow for each string to have the same type of damper rather than a damper designed for each actuator.

The final design

Eventually *The Chandelier* will be built to look like the images at the beginning of this chapter. All the research, construction, testing, and retesting of the past two years has been leading toward that final goal. And though it is unclear when the final version will be built, I have faith that it will represent a leap forward in robotic instrument design, both from an artistic and engineering perspective.

The laser harp is a prototype controller for The Chandelier built from readily available off-the-shelf equipment. It is a proof of concept for a low-cost musical controller with multiple degrees of freedom.

Chapter 5 — Laser Harp

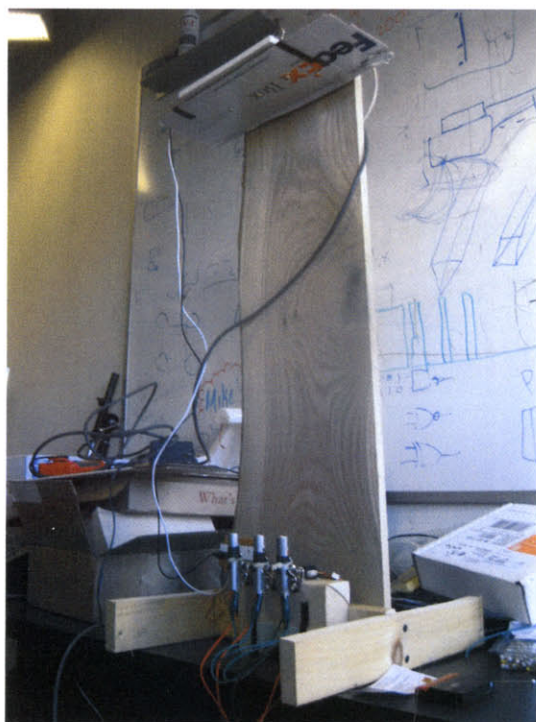

Fig. 5.1: The laser harp prototype.

Photo by Mike Fabio.

I built the laser harp as an afterthought: the keyboard interface to *The Chandelier* wasn't effective at controlling all available parameters, and I needed something a little more, well, fun. So as part of a class project, I decided to build upon the traditional laser harp interface, augmenting it with some new sensors. It was also my intention to build this controller cheaply, and using off-the-shelf equipment.

148

The laser harp is not a new idea. Jean Michel Jarre, a notable electronic musician, popularized the controller in the 1970s. The harp he played, which was designed by Bernard Szajner, had 7 "strings," all emanating from a single point and reflected by a rotating mirror system. The bright green color of the lasers, and their incredible brightness quickly led to rumors of their danger, which Jarre exploited by wearing "asbestos lined gloves" (as it turns out, the gloves were simply for show).

There is certainly an appeal to the danger and drama of the laser harp. Laser light is not a common thing to see, especially in a musical setting. And to some degree, light itself is seductive, especially when placed under the control of a person (witness the mirth of simply waving a laser

Hasan, Leila. 2001. Visual Frets for a Free-Gesture Musical Interface. Master of Science Thesis, Massachusetts Institute of Technology.

pointer in a foggy night sky). And it is exactly this feeling of power I intended to harness with the laser harp.

The original idea for this new harp implementation came from Leila Hasan's *Termenova*. Although the *Termenova* is not specifically a laser harp, it does feature several functions that could easily make it such, including height sensing and beam-break sensing. The *Termenova* was designed as a visual "fretting" interface for free gesture controllers like the theremin, in order that a player can more easily visualize the pitches in space. But in addition to this, the *Termenova* can sense when any of its laser beams are broken, and can also determine the distance of the hand from the controller.

On short time and even shorter budget, I attempted to replicate some of that functionality in my own laser harp. And although my harp is not nearly as developed as the *Termenova*, it is a promising first step in that direction. | 149

1. ————— Designing and Building the Laser Harp

As with many projects, the laser harp was built in a limited amount of time: just about one week. Given this constraint, it was necessary to design and build at the same time. Since it is nearly impossible to focus on both design and engineering simultaneously, both of these elements suffered. Regardless, the laser harp was built into a fully functional (and surprisingly good) proof of concept.

I began by testing the laser beam-break sensors. For this I decided to use a cheap laser pointer and a photoresistor. Red laser pointer prices have plummeted with new fabrication methods and the availability of materials. A typical pointer costs between 5 and 10 dollars, but can be purchased for less than a dollar each in bulk. Of course, this is only for low-power pointers of class IIIa, which must be less than 5mW. And other types of lasers, including green and blue lasers, are significantly more expensive, ranging from 15 dollars up into the thousands. For this purpose, though, a red laser pointer is more than ample.

Using a simple circuit, I was able to read a measurement directly off the photoresistor into the computer.

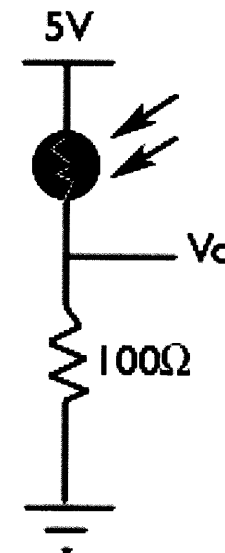

Fig. 5.2: Photoresistor beam-break sensor schematic

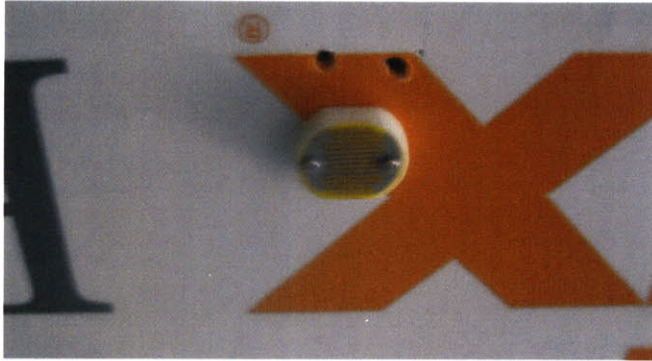

Fig. 5.3: A closeup of a photoresistor, mounted in a FedEx box.

Photo by Mike Fabio.

Thomas Ouellet Fredericks' Simple Message System can be found at
<<http://tof.danslchamp.org/>>

Here I used the Arduino microcontroller board as power supply and analog-to-digital converter: the 5V comes directly via USB power from the board, and V_0 runs into one of the analog input pins of the microcontroller.

As light hits the photoresistor from the laser, its resistance drops very low, creating a rise in the output signal. Conversely, breaking the laser beam with the hand causes the signal to drop. Because the laser is so bright, the difference between these two signals is quite significant, and it is therefore easy to sense discretely when the beam has been broken.

The data output from the Arduino is run into MAX/MSP via the Simple Message System. A continuous data stream is low pass filtered to remove any noise or spikes in the data. It is then normalized to an 8-bit range, and the system watches for threshold crossings. A data rate of around 100Hz can easily be read from this system, and a break in the laser beam is nearly sample-accurate.

The next step was to test the distance sensors. For this I decided to use infrared range finders from Sharp Electronics (model GP2D12). These sensors cost around 15 dollars each, and are available from many hobby electronics sources. They are commonly used in small robots for proximity sensing.

Sharp IR sensors use a triangulation method for calculating distance. On the top of the device there is an IR emitter and a sensor, spaced about an inch apart. Light leaves the emitter and returns to the sensor at an angle. This angle directly corresponds to the distance of the object which reflected the light.



Fig. 5.4: Height markings on the laser harp.

Photo by Mike Fabio.

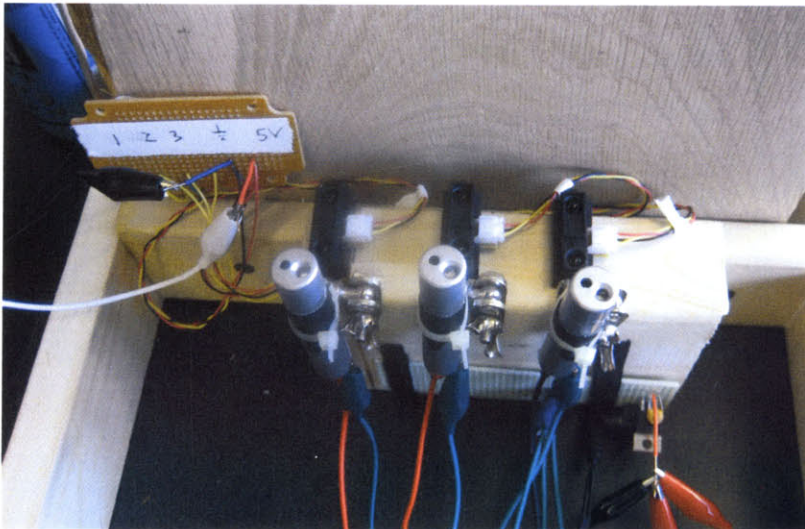

Fig. 5.5: Lasers, IR sensors, and power supply.

Photo by Mike Fabio.

The data sheets for the Sharp sensors claims they have a range of up to 31.5", with a minimum operating range of 4". In my own tests, however, I found this not to be the case.

I carried out testing using the fully constructed laser harp, which contains three IR sensors running simultaneously. Along the length of the harp, I marked distances from the sensors, to a maximum of 1'10". Because the lasers rise several inches above the IR sensors, the usable range of the harp is between 2" and 1'10".

In the tests, I placed one hand in the path of all three sensors and swept my hand steadily from 2" to 1'10" and then back down without stopping. I recorded the resulting data streams in MAX/MSP. These data are shown in Figure 5.6.

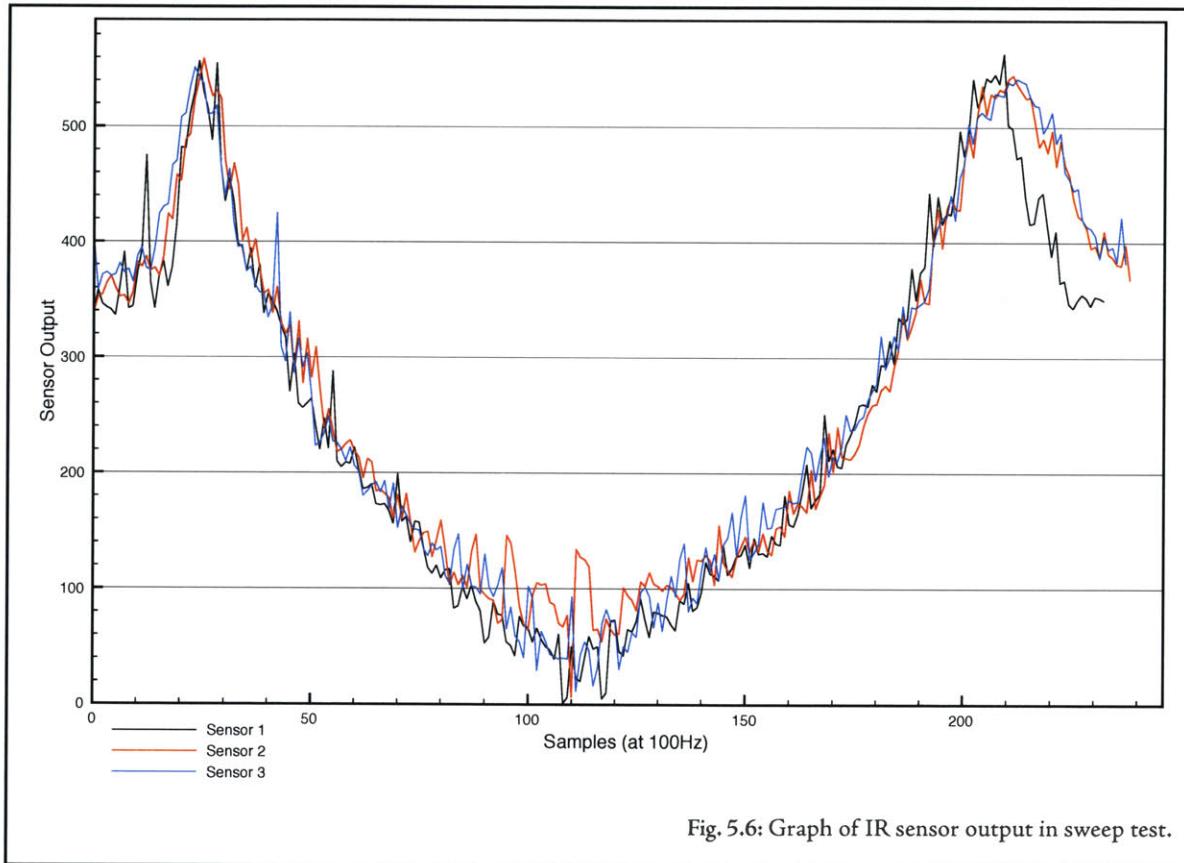

My testing confirms the claims on the manufacturer's datasheet insofar as the shape of the curve is concerned. There is a sharp drop in the output at close ranges of less than 4". This can be seen in the graph at the far left and right sides. Output peaks at 4" and drops logarithmically from there. The center of the graph corresponds to the highest point on the laser harp, at 1'10".

The problem with the sensor is that although it is able to sense an obstacle well beyond the 1'10" of my design, its resolution above this is not usable in a musical context. And although it was necessary to linearize the curve for use in musical applications, this does not change the resolution issues at long distances. I therefore settled for the distance I was able to sense

153

accurately. For this particular prototype it would be more than enough.

After I confirmed the accuracy of the sensors, it was time to build the laser harp. It is mostly constructed out of wood scraps that I had lying around. At the top is a board, cut from a FedEx box, which is clamped to the wooden frame. This board holds all the electronics of the system, including the Arduino and a breadboard of simple photoresistor circuits.

The lasers and IR sensors are mounted at the base of the device, and a simple power supply circuit was built to circumvent the lasers' batteries.

2. _____ Playing the Laser Harp

The laser harp is actually quite playable, despite its rickety design and cheap aesthetic. The sensors are accurate enough to give the user quite a bit of control. But most importantly, it is a great deal of fun.

Some synthesizer mappings

The first test I made with the laser harp was a one-to-one mapping with a synthesizer. Using the FM7 software from Native Instruments, I mapped each of the laser harp's three strings to one note of a major triad, and the IR distance sensor to the modulation wheel controller.

| 154

The test was remarkably playable. Latency was nearly unnoticeable, and I could even trigger notes rapidly by waggling my finger in the laser area. The IR sensors accurately tracked my hands in vertical space, and I could add vibrato by simply moving my hands downwards.

I then tried some other mappings:

1. Random notes — Every time a string is plucked, it is mapped to a completely random note. Fun, but not necessarily musical.
2. Chord picker — The leftmost string is used to pick a chord and the two right strings arpeggiate that chord. I also made a mapping where vertical position on the leftmost string mapped to different chords, which are played by the right strings.

3. Patch picker — The leftmost string is used to pick a synthesizer patch, either using a beam-break or the vertical positioning. Several different sounds can be effectively played this way.
4. Chord builder — Each string corresponds to a different chord. As the beam is broken near the top of the harp, the first note of the chord is played. As the hand is then moved downward, the remaining notes of the chord build on top of the first. This mapping works well with sustained sounds.
5. Many notes per string — Similar to the chord builder mapping, but plays individual notes depending on where the string is broken. This allows for each string to be mapped to several notes. It is even possible to play simple tunes in this way by plucking the strings in exactly the right positions.

Of course mappings can be as exciting as one can dream up. Since each string offers an on/off trigger and a continuous controller, even three strings can map to a huge variety of sounds. | 155

Playing *The Chandelier*

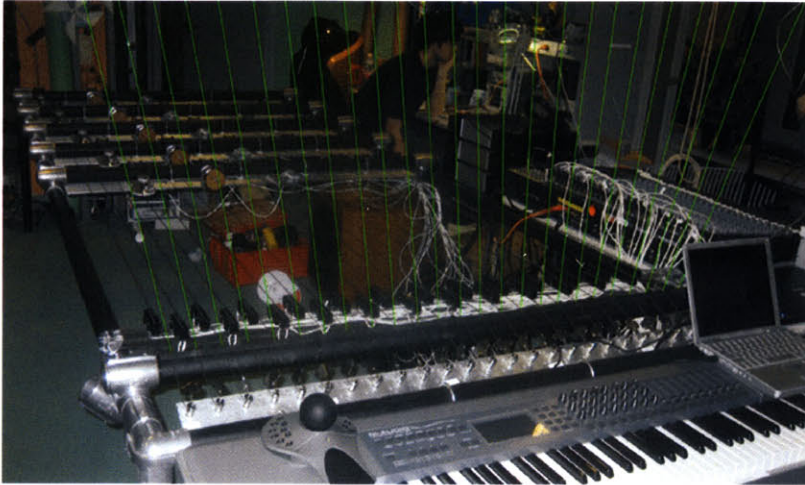

Fig. 5.7: The original concept design for the laser harp, extending the visual language of *The Chandelier's* strings into vertical space.

Photo and alteration by Mike Fabio.

While synthesizer mappings are entertaining and useful, the real purpose of building the laser harp was to control *The Chandelier*. It was always my intention to physically integrate the visual language of strings into both the instrument and controller, essentially extending the strings of *The Chandelier* into vertical space as lasers. And although I was never able to build a 25 string model, the three string model is remarkably good at controlling *The Chandelier*.

When I built the laser harp, *The Chandelier* only had three working actuators. So it seemed natural to map each string to a single type of actuator.

The leftmost string of the laser harp was used to control the electromagnets.

Each time the beam was broken, the computer would decide on a set of one or more audio files to play through the magnets. Later I added vertical distance control to the volume of the files, but this did not seem to make it more expressive.

The center string was mapped to the rosin wheels. Rather than control the speed of the motors using vertical distance (which would seem the natural choice), I mapped vertical distance to the number of rosin wheels activated. Plucking the string near the top of the harp would activate the first wheel. As the hand is moved downward, the rest of the rosin wheels begin playing, one at a time, until at the bottom of the harp all five rosin wheels are spinning.

The rightmost string was mapped to the weedwackers. Each time the beam was broken, the computer would choose a set of weedwackers to actuate. This could be anywhere from 1-5 at a time. Vertical distance was then

mapped to the speed of the motors, allowing continuous control over the timbre.

This mapping turned out to be remarkably effective. Although it did not afford specific control of individual strings on *The Chandelier* it was quite easy to play, and a nearly full range of sounds could be extracted from the instrument.

3. _____ Future Work

There are a few downsides to my laser harp design. For one, the strings are completely invisible, even in dark conditions. Second, the usable range of vertical sensing is quite small, just under 2 feet. And third, there are only three strings, which, although they can be mapped effectively to 25 strings, do not have quite the same effect as 25.

| 157

Laser visibility

The first problem is the simplest to solve. Lasers can be bought or built in many power ratings. However, the higher the power of the laser, the higher the cost, and high powered lasers are also more dangerous.

In the United States, a class IIIa laser, like those used in the laser harp and found in many types of laser pointers, are the most readily available and cheap type. They require little power, and many can be driven from small watch batteries for hundreds of hours. But at the same time, they are hardly visible under normal conditions.

One solution to this is to use green lasers, which are visible in dark conditions. These typically lase at 532nm, which is just about the peak of the human eye's response to the visible light spectrum. Therefore, a 5mW green laser will appear significantly brighter to the human eye than a 5mW red laser. Green lasers, however, are more expensive than red lasers due to the cost of manufacturing. Where a red laser generally sells for 5-10 dollars, most green lasers are sold for over 50 dollars (though it is possible to buy them for around 15 dollars). At high enough power, many green lasers are even visible in daylight (though at these powers the dangers to skin and eyes become a problem).

Another solution to this problem is to use fog or smoke to refract the light from the lasers. This is an attractive solution due to its low cost and powerful visual effect. However, too much fog can obscure the laser beams and cause sensor malfunction. It is also difficult to control the spread of fog, and there is always a danger of setting off smoke detectors.

158

Distance sensing

While the infrared range finders are suitable for a prototype, they do not provide high enough resolution or range for musical applications. The obvious solution to this is to use laser range finding. But as it turns out, this is much easier said than done.

When building the laser harp, I investigated off-the-shelf laser range finding solutions, and what I found was disturbing. For one, most commercially available range finders are prohibitively expensive, ranging from a few hundred dollars per sensor to several thousands dollars. Second,

the majority of these sensors are designed for specific purposes, such as manufacturing automation or precision fabrication. Unfortunately these types of sensors are unusable for the laser harp. And finally, most laser range finders do not use visible lasers, opting for infrared lasers instead. These are commonly found in range finding equipment for surveying, military use, and golfing distance measurement.

Low cost laser range finding is a common interest of many robotics hobbyists, and there are several well documented examples:

Todd Danko uses a common webcam to triangulate object distance in software.

Danko, Todd. Webcam Based DIY Laser Rangefinder. Accessed March 14, 2007 <http://www.pages.drexel.edu/~twd25/webcam_laser_ranger.html>.

Philippe Hurbain has built a triangulating rangefinder for Lego Mindstorms.

Hurbain, Philippe. 2005. Laser Target Finder Sensor. Accessed March 14, 2007 <<http://www.philohome.com/sensors/lasersensor.htm>>.

Mike Licitra built a green laser range finder for firefighting robots.

Licitra, Mike. 2003. Details of the Laser Range Finder. Accessed March 14, 2007 <<http://www.eng.buffalo.edu/ubr/ff03laser.php>>.

An excellent overview of many laser range finding techniques appears in:

Jain, Siddharth. 2003. A survey of Laser Range Finding. Unpublished paper. Accessed March 30, 2007 <<http://www.awargi.org/ee236a.pdf>>.

So I set out to build my own lower cost laser range finder. In my preliminary research I found several excellent examples of range finders built inexpensively and with readily available equipment. Most of these methods use the same triangulation principles of the Sharp IR sensors. But the missing link in the puzzle was optics. As it turns out, lenses are extremely expensive, and cheap lenses tend to give inaccurate measurements, especially with the thin beams of a laser.

It should be noted that there are other ways of measuring distance using a laser, and some of them are feasible. The easiest method is the same as that used in Leila Hasan's *Termenova*, which uses a photodiode to measure the intensity of the laser's reflection on an object. As the object gets closer to the sensor, the amount of light that returns to the sensor becomes more intense. This method is not as accurate as triangulation, but is inexpensive and easy to design and build, and can be implemented out with plastic lenses. Another method of laser range finding involves time-of-flight measurements, where the laser light is modulated by some function, and a timer measures the time it takes for the modulation pattern to be seen by the sensor. This method requires much more complicated electronics and signal processing than the other methods, but is extremely accurate. Again, though, it requires precision optics.

More strings

The Chandelier has 25 strings, but my prototype laser harp has only 3. This deficiency completely defeats the visual analogy suggested by having virtual laser strings. It is, however, an easily solved problem.

The prototype design is easily modifiable to accommodate 25 lasers, but there are still a few minor obstacles, including power requirements, electronics design, and sensor calibration. 25 lasers and 25 IR sensors would require significant amounts of power, but a suitable power supply could easily be found or built. Extending the number of sensors may require some clever multiplexing in order to feed the data to a single microcontroller, since most microcontrollers only have a small number of inputs. There are some, however, that have up to 64 inputs. Sensor calibration is also tricky with this many sensors. Each laser needs to be carefully aligned directly at the photosensor, which is just about a centimeter in diameter. | 160

It may also be possible to design a harp that uses only a single high powered laser and a series of mirrors and lenses to create 25 separate lasers. Or it may be desirable to use a rotating mirror design, much like that in Jean Michel Jarre's laser harp. A similar design also appears in Joe Paradiso and Josh Strickon's LaserWall, a 2-dimensional laser range finder.

I certainly had no feeling for harmony, and Schoenberg thought that that would make it impossible for me to write music. He said, 'You'll come to a wall you won't be able to get through.' So I said, 'I'll beat my head against that wall.'
—John Cage

Conclusion

The future of robotic musical instruments

It is difficult to understand the place of robotic musical instruments in the ever-expanding musical canon. While digital instruments and synthesizers have progressed at impressive rates, robotic instruments are still quite primitive. | 161

Perhaps the biggest setback to the field thus far has been the obscurity of the technology among musicians. Motor control and mechanical actuation are second nature to the roboticist, but the typical pianist barely understands the complex mechanism behind his *non*-robotic piano. Fortunately this is changing rapidly. The technological/musical sphere has expanded at such a rate that success is often characterized by the use and application of new technology rather than mastery of an instrument.

Robotic instruments present a provocative alternative to other technologies. Synthesizers are capable of recreating with incredible accuracy the sounds of traditional instruments, or of creating entirely new sound that

have never been heard. But there is a tendency for a computer to sound like a computer, and that can translate to a stagnant musical language. Robotic instruments, on the other hand, create sounds that find common ground among digital and acoustic instruments.

There is an appeal to robotic instruments that goes beyond their sound. They are in many ways an empowering technology, a way for human beings to be something larger than themselves. I attempted to harness this power in works like *Jeux Deux*, where a human pianist is given superhuman playing abilities, or with *The Chandelier*, where the sheer size of the instrument is superhuman. In this way it may be possible for robotic instruments to become an enabling technology, allowing those with physical or mental impairments to create music.

We are growing closer to a symbiosis with robots every day. Robots can now be found in every part of our lives: they vacuum our floors, they build our automobiles, they dig tunnels, and now they play music. Human beings are therefore forced to understand robots and to become comfortable with them. As we become increasingly comfortable, the robots become increasingly powerful. And this creates significant hope for the future of robotic instruments, a field frustrated and inhibited by the complex relationship between man and machine. | 162

Onward ho

If I have made a contribution with this work it is that I have created music. I have no other motive, no driving force, no intentions other than the will to make sound that moves people. Were it not for the inextricable

link between music and technology, I would not even venture into the realm of science.

But art is, at its core, a technological endeavor. Paintings would not exist without paint brushes, novels would not exist without the printing press, and photographs would not exist without the camera. Music, then, could not exist without musical instruments. And that is precisely why I design them.

Designing new instruments has historically been done for aesthetic or pragmatic purposes. The double bass, for instance, was developed as a lower-pitched version of the viola da gamba. As the need grew for an even lower pitched instrument, the double bass's three strings were extended to four and even five strings, and innovations like the C-extension were utilized to extend the length of the neck.

| 163

But the motivations for robotic instrument design go beyond this. Some instruments, like those of Eric Singer, are designed as glorified MIDI devices. They are simply another sound creation mechanism, playable like any MIDI synthesizer. Other artists, like Trimpin, began designing robotic instruments because he developed allergies to certain metals that prevented him from playing his trumpet. JBot, the leader of the group Captured by Robots, became discouraged by the improprieties of human musicians: "I couldn't play with humans anymore, humans have too many problems, like drugs, egos, girlfriends, jobs.... I figured I could make a band that I could play with until I die, and not worry about if anyone in the band was going to quit, and kill the band."

Kapur, Ajay. 2005. A History of Robotic Musical Instruments. In *Proceedings of the International Computer Music Conference 2005 (ICMC 2005)*.

My own motivations are more plain. I only wanted to create a new tool for making music. A machine that could create sounds I had only dreamed of. An extension of my own imagination, into the real world, in a metallic tangle of wires and strings.

My past works — and to a certain extent, *The Chandelier* as well—have served as a jumping off point for my music. I began playing bass when I was young, but here I am, some 15 years later, having created a body of work that I am not only proud of, but that I enjoy. I never intended to build robotic instruments, but the natural progression from the acoustic to the electronic has dropped me somewhere in between. I'm not a knob twiddler, but I'm not just a bass player either. I have found a medium in which I can make the music that I hear in my head.

After I graduated from college, I asked myself, in a bit of self-righteous introspection, whether I had made a difference in the world. I thoroughly questioned my motives, and my work. Why should we build musical instruments when so much beautiful music can be made by the instruments we already have? Can I truly reinvent the wheel? | 164

But there is no need to reinvent the wheel; there is only the need to invent another wheel. At the end of the day, I can only ask myself *does it sound good?* The only metric we have for our success—as technologists, as artists, as humans—is whether or not we have created something new.

List of Figures

Introduction

- Fig. 0.1: Interactive touchpads controlling Disklaviers in the Marshall Fields Flower Show 10
- Fig. 0.2: *mirror* from *Imagery for Jeux Deux*.....10
- Fig. 0.3: *The Chandelier* prototype..... 11

Chapter 1 — A History of Robots in Music

- Fig. 1.1: Diagram of the pneumatic playing mechanism of a player piano..... 17
- Fig. 1.2: Antheil in Paris, 1927..... 24
- Fig. 1.3: The handwritten pianos-only score for *Ballet mécanique* 25
- Fig. 1.4: The 1924 Pleyel patent for synchronizing multiple player pianos..... 30
- Fig. 1.5: Trimpin in his studio.....40
- Fig. 1.6: A closeup of the fingering mechanism on one of Trimpin’s guitar robots..... 41
- Fig. 1.7: A collection of toy pianos and the prototype for *SHHH* 42
- Fig. 1.8: Trimpin at his *Vorsetzer*..... 42
- Fig. 1.9: *Klompen*..... 42

- Fig. 1.10: Original watercolor sketch for *Magnitude in C#*..... 42
- Fig. 1.11: *SHHH* at Suyama Space, Seattle, WA..... 43

Chapter 2 — The Marshall Field’s Flower Show

- Fig. 2.1: A cello sculpture made of plants greets visitors at the entrance to *Music in the Garden*..... 54
- Fig. 2.2: *Music in the Garden*.....55
- Fig. 2.3: A child plays a musical “shaper” in the “Under the Sea” section..... 56
- Fig. 2.4: A pinwheel controls a robotic windchime in the “Silver Forest” section..... 56
- Fig. 2.5: A Yamaha Disklavier Mark IV..... 58
- Fig. 2.6: Original sketch of pedestal design..... 61
- Fig. 2.7: The completed pedestal..... 61
- Fig. 2.8: Interaction flow, 1..... 64
- Fig. 2.9: Interaction flow, 2..... 65
- Fig. 2.10: Touchpad layout, 1..... 66
- Fig. 2.11: Some early sketches for the interaction.....67
- Fig. 2.12: Touchpad layout, 2..... 68
- Fig. 2.13: More interaction sketches..... 69
- Fig. 2.14: Touchpad layout, 3..... 69

Fig. 2.15: Touchpad layout, 4.....	70
Fig. 2.16: Disklavier MAX patch.....	73
Fig. 2.17: Young children at the Debussy station.....	75

Chapter 3 — *Jeux Deux*

Fig. 3.1: Keith Lockhart conducting the premiere of <i>Jeux Deux</i> with the Boston Pops, Michael Chertock, hyperpiano.....	83
Fig. 3.2: <i>Jeux Deux</i> at Symphony Hall, Boston, with graphics by Marc Downie.....	84
Fig. 3.3: <i>Jeux Deux</i> Performance Setup.....	85
Fig. 3.4: The <i>Jeux Deux</i> Software.....	87
Fig. 3.5: MIDI sequence triggering patch.....	89
Fig. 3.6: “The Wall” transposition patch.....	90
Fig. 3.7: Fast sequence triggers patch.....	93
Fig. 3.8 Texture blob 2 - drop in a bucket patch.....	94
Fig. 3.9: Texture blob 3 - swirling polyrhythms patch.....	96
Fig. 3.10: Knob-blob patch.....	96
Fig. 3.11: Michael Chertock practicing at the Disklavier for a performance in Porto, Portugal, March 2006.....	98
Fig. 3.12: The stage is set at the Casa da Musica.....	102

Chapter 4 — *The Chandelier*

Fig. 4.1: A computer rendering of <i>The Chandelier</i>	105
Fig. 4.2: An overview of the stage design.....	105
Fig. 4.3: The earliest sketches for <i>The Chandelier</i> by production designer Alex McDowell.....	107
Fig. 4.4: The earliest computer rendering of <i>The Chandelier</i> ..	108
Fig. 4.5: An abstract rendering of the second version.....	108

Fig. 4.6: Several more renderings of the second version.....	109
Fig. 4.7: Two images of a physical model, built by Mike Fabio and Brian Demers.....	109
Fig. 4.8: Current design (version 3) as of April 23, 2007.....	110
Fig. 4.9: Lighting studies by Arjuna Imel.....	111
Fig. 4.10: The electromonochord prototype.....	112
Fig. 4.11: Diagram of the electromonochord construction....	113
Fig. 4.12: The mounted pickup of the electromonochord.....	113
Fig. 4.13: The first testing apparatus using a speaker and sponge to vibrate the string.....	116
Fig. 4.14: An early test using vibrating pager motors.....	117
Fig. 4.15: The early handmade electromagnet actuator prototype	119
Fig. 4.16: The acrylic hammer actuator.....	122
Fig. 4.17: <i>The Chandelier</i> prototype, with keyboard controller	125
Fig. 4.18: Bird’s-eye view of <i>The Chandelier</i> frame.....	126
Fig. 4.19: The individual bridge assemblies are visible just next to each actuator.....	127
Fig. 4.20: The tuning board.....	128
Fig. 4.21: The electromagnet actuator and mount.....	130
Fig. 4.22: The rosin wheel actuator and mount.....	131
Fig. 4.23: The weedwacker actuator and mount.....	132
Fig. 4.24: The hammer actuator and mount.....	133
Fig. 4.25: Schematic of the control electronics.....	134
Fig. 4.26: Control electronics schematic.....	136

Fig. 4.27: Visitors play *The Chandelier* at the *Library Music*
event..... 140

Chapter 5 — Laser Harp

Fig. 5.1: The laser harp prototype..... 148
Fig. 5.2: Photoresistor beam-break sensor schematic..... 150
Fig. 5.3: A closeup of a photoresistor, mounted in a FedEx box
..... 151
Fig. 5.4: Height markings on the laser harp..... 152
Fig. 5.5: Lasers, IR sensors, and power supply..... 152
Fig. 5.6: Graph of IR sensor output in sweep test..... 153
Fig. 5.7: The original concept design for the laser harp..... 156

Reader Bios

Alex McDowell

For 20 years a design leader in several pop culture fields (including record sleeve graphics and MTV videos), Alex McDowell is currently most fully employed as a production designer in feature films. Born and trained in London, he moved to Los Angeles in 1986, having designed over a hundred music videos, and began a new career as production designer for many of the most cutting-edge young directors in commercials. In 1991, McDowell was called upon to production design the virtual reality cult film *The Lawnmower Man*, followed by *The Crow*; *Fear and Loathing in Las Vegas* with director Terry Gilliam, *Fight Club* with director David Fincher, *Minority Report* and *The Terminal* with director Steven Spielberg, and *Charlie and the Chocolate Factory* and *The Corpse Bride* with Tim Burton. For *Minority Report*, McDowell established the first fully integrated digital design department in the film industry, enabling the strands of 2D and 3D design, set construction, camera, prop manufacturing and post-production VFX to be efficiently linked and managed by the Design Team. McDowell is the founder of the revolutionary design and engineering think tank known as 'matter'. *Death and the Powers* is his first opera project.

Bibliography

- Antheil, George.** 1959. *Ballet mécanique*. G. Schirmer, Inc. Distributed by Hal Leonard Corporation, Milwaukee, WI. Edition copyright © 2003.
- Antheil, George.** 1945. *Bad Boy of Music*. Garden City, NY: Doubleday, Doran & Company, Inc.
- Ask, Einar.** 2007. The Trimpin Cover Story. In *The NWCA Newsletter*. Accessed April 14, 2007 <<http://www.einar.com/trimpin.html>>
- Backer, Steven.** 2005. Electromagnetically-Prepared Piano. Accessed March 20, 2007 <<http://ccrma.stanford.edu/~sbacker/empp/>>
- Backer, Steven, Edgar Berdahl and Julius O. Smith III.** 2005. If I Had a Hammer: Design and Theory of an Electromagnetically-Prepared Piano. In *Proceedings of the International Computer Music Conference 2005 (ICMC 2005)*.
- Baginsky, Nicolas Anatol.** The Three Sirens - a robotic rock band. Accessed December 12, 2006 <<http://www.the-three-sirens.info/binfo.html>>
- Bowers, Q. David.** 1972. *Encyclopedia of Automatic Musical Instruments*. Vestal, NY: Vestal Press.
- Bunn, Austin.** 1998. Mechanical Music. *The Village Voice*, January 7-13. Accessed April 14, 2007 <<http://www.villagevoice.com/news/9802,bunn,368,8.html>>
- Carlsen, Philip.** 1988. *The Player-Piano Music of Conlon Nancarrow: An Analysis of Selected Studies*. I.S.A.M. Monographs, no. 26.
- Ceruzzi, Paul E.** 1998. *A History of Modern Computing*. Cambridge: MIT Press.
- Chadabe, Joel.** 2002. The Limitations of Mapping as a Structural Descriptive in Electronic Music. In *Proceedings of New Interfaces for Musical Expression Conference 2002 (NIME 2002)*.
- Cheveigné, Alain de, and Hideki Kawahara.** 2002. YIN, a fundamental frequency estimator for speech and music. In *Journal of the Acoustical Society of America*, 111:4 April.
- Cowell, Henry.** 1954. Current Chronicle. In *The Musical Quarterly*, XL: 2, April. 242-43.
- Cowell, Henry.** 2002. George Antheil. In *Essential Cowell: Selected Writings on Music by Henry Cowell, 1921-1964*, ed. Dick Higgins, 150-154. Kingston, NY: McPherson & Company.
- Cowell, Henry.** 2002. John Cage. In *Essential Cowell: Selected Writings on Music by Henry Cowell, 1921-1964*, ed. Dick Higgins, 132-143. Kingston, NY: McPherson & Company.
- Danko, Todd.** Webcam Based DIY Laser Rangefinder. Accessed March 14, 2007 <http://www.pages.drexel.edu/~twd25/webcam_laser_ranger.html>.

- Downie, Marc.** 2005. *Choreographing the Extended Agent: performance graphics for dance theater*. Ph.D. Thesis, Massachusetts Institute of Technology.
- Duckworth, William.** 1995. Conlon Nancarrow. In *Talking Music: Conversations with John Cage, Philip Glass, Laurie Anderson, and Five Generations of American Experimental Composers*, 29-51. New York: Schirmer Books.
- Edwards, William G.** 2004. Ragtime and the Economy. Accessed April 11, 2007 <<http://www.perfessorbill.com/ragtime7.shtml>>
- Edwards, William G.** 2004. Sheet Music Cover Art History. Accessed April 11, 2007 <<http://www.perfessorbill.com/ragtime9.shtml>>
- Futuremusic contributors.** 2006. Sound Artist Trimpin Triumphs with Der Ring. In *Futuremusic: Digibear?*, June. Accessed April 14, 2007 <<http://futuremusic.com/news/june2006/trimpin.html>>
- Gaddis, William.** 2002. *Agapē Agape*. New York: Viking.
- Gaddis, William.** 2002. *The Rush for Second Place: Essays and Occasional Writings*. New York: Penguin Books.
- Gagne, Cole and Tracy Caras.** 1982. Conlon Nancarrow. In *Soundpieces: Interviews with American Composers*. Metuchen, NJ: Scarecrow Press.
- Gann, Kyle.** 1995. *The Music of Conlon Nancarrow*. Cambridge: Cambridge University Press.
- Gann, Kyle.** 2000. Hendrix from Heaven. *The Village Voice*, June 7-13. Accessed April 14, 2007 <<http://www.villagevoice.com/music/0023,gann,15442,22.html>>
- Goebel, Werner, and Roberto Bresin.** 2001. Are computer-controlled pianos a reliable tool in music performance research? Recording and reproduction precision of a Yamaha Disklavier grand piano. In *MOSART workshop, 2001*. Accessed April 21, 2007 <<http://www.iaa.upf.es/mtg/mosart/papers/p35.pdf>>
- Goebel, Werner, Roberto Bresin and Alexander Galembo.** 2003. The Piano Action as the Performer's Interface: Timing Properties, Dynamic Behaviour and the Performer's Possibilities. In *Proceedings of the Stockholm Music Acoustics Conference, August 6-9, 2003 (SMAC 2003)*.
- Hasan, Leila.** 2001. Visual Frets for a Free-Gesture Musical Interface. Master of Science Thesis, Massachusetts Institute of Technology.
- Harvestworks, NIME.** 2007. NIME 2007. Accessed April 16, 2007 <<http://itp.nyu.edu/nime/2007/>>
- Hawley, Michael.** 1993. Structure out of Sound. Master of Science Thesis, Massachusetts Institute of Technology.
- Hero of Alexandria.** 1851. *The Pneumatics of Hero of Alexandria*. Trans. Bennett Woodcroft. Accessed April 9, 2007 <<http://www.history.rochester.edu/steam/hero/index.html>>
- Hocker, Jürgen.** 2002. My Soul Is In The Machine — Conlon Nancarrow — Composer For Player Piano — Precursor of Computer Music. In *Music and Technology in the Twentieth Century*, ed. Hans-Joachim Braun, 84-96. Baltimore: The Johns Hopkins University Press.
- Hopkin, Bart.** 1996. *Gravikords, Whirlies & Pyrophones: Experimental Musical Instruments*. Forward by Tom Waits. Roslyn, NY: Ellipsis Arts...
- Howard, Roy E.** 2002. Marketing History of the Piano. Accessed April 11, 2007 <<http://www.cantos.org/Piano/History/marketing.html>>

- Hurbain, Philippe.** 2005. Laser Target Finder Sensor. Accessed March 14, 2007 <<http://www.philohome.com/sensors/lasersensor.htm>>.
- Jain, Siddharth.** 2003. A survey of Laser Range Finding. Unpublished paper. Accessed March 30, 2007 <<http://www.awargi.org/ee236a.pdf>>.
- Jehan, Tristan.** 2005. Creating Music by Listening. PhD. Thesis, Massachusetts Institute of Technology.
- Kahn, Douglas.** 1999. *Noise Water Meat*. Cambridge: MIT Press.
- Kapur, Ajay.** 2005. A History of Robotic Musical Instruments. In *Proceedings of the International Computer Music Conference 2005 (ICMC 2005)*.
- Kara, Dan.** 2004. Industry Shorts - Personal: Toyota Gets in the Game. *Robotics Trends*. Accessed April 16, 2007 <<http://www.roboticstrends.com/displayarticle365.html>>
- Keys, Matt.** 1997. The Sound of Genius. In *The Online Daily of the University of Washington*, August 13. Accessed April 14, 2007 <<http://archives.thedaily.washington.edu/1997/081397/trimpin.html>>
- Lehrman, Paul D.** 2000. *Ballet mécanique and other works for player pianos, percussion, and electronics*. Compact Disc Liner Notes. Electronic Music Foundation.
- Lehrman, Paul D.** 2003. The Ballet mécanique Project: Technology Catches up with Antheil. In the notes to *Ballet mécanique*, score by George Antheil. G. Schirmer Inc. xii-xv.
- Lehrman, Paul D., and Eric Singer.** 2006. A "Ballet mécanique" for the 21st Century: Performing George Antheil's Dadaist Masterpiece with Robots. In *Proceedings of New Interfaces for Musical Expression Conference 2006 (NIME 2006)*.
- Lehrman, Paul D.** 2006. *Bad Boy Made Good*. Directed by Ron Frank. Produced and written by Paul Lehrman. DVD.
- Lehrman, Paul D.** 2006. Ballet mécanique at the National Gallery of Art. Accessed April 16, 2007 at the Ballet mécanique page <<http://antheil.org/NGA.html>>
- Licitra, Mike.** 2003. Details of the Laser Range Finder. Accessed March 14, 2007 <<http://www.eng.buffalo.edu/ubr/ff03laser.php>>.
- Lozano-Hemmer, Rafael.** 1996. Perverting Technological Correctness. *Leonardo* 29:1: 5-15.
- Lucier, Alvin.** 1992. *Music on a Long Thin Wire*. Lovely Music. CD.
- Machover, Tod.** 1992. Hyperinstruments: A Progress Report 1987-1991. MIT Media Laboratory. Accessed April 19, 2007 <http://www.media.mit.edu/hyperins/hyper_rprt.pdf>
- Machover, Tod.** 1994. *Bounce - Chansons d'Amour*. Bridge Records. CD.
- Machover, Tod.** 2005. *Jeux Deux*. Music score. New York: Boosey & Hawkes.
- Machover, Tod, and Michael Fabio.** 2006. *Death and the Powers*. Accessed May 5, 2007 <<http://www.media.mit.edu/hyperins/projects/deathandthepowers/>>
- Machover, Tod.** 2007. *Death and the Powers*. Music score, in progress. Hanoa Productions.
- McElhone, Kevin.** 1999. *Mechanical Music*. Buckinghamshire, UK: Shire Books.
- McKinnon, James W.** 2007. Hydraulis. In *Grove Music Online*, ed. L. Macy. Accessed April 9, 2007 <<http://www.grovemusic.com>>.
- MIT Radiation Protection Committee.** January, 2003. Massachusetts Institute of Technology Radiation Protection Program Laser

- Safety Program. Sixth Edition. <http://web.mit.edu/environment/pdf/Laser_Safety.pdf>
- Moy, Kimberly W.** 2006. Dancing to the beat of a robot drummer. *The Boston Globe*, January 23. Accessed March 30, 2007 <http://www.boston.com/news/science/articles/2006/01/23/dancing_to_the_beat_of_a_robot_drummer/>.
- Nancarrow, Conlon.** 2000. *Lost Works, Last Works*. San Francisco: Other Minds. Compact Disc.
- Ord-Hume, Arthur W.J.G.** 1984. *Pianola: the history of the self-playing piano*. London: George Allen & Unwin.
- Paradiso, Joseph A.** 2004. Electronic Controllers for Musical Performance and Interaction. Unpublished book chapter submitted for publication.
- Perkis, Tim.** 1999. Taming the Elements with MIDI. In *Electronic Musician*, Dec. 1. Accessed April 14, 2007 <http://emusician.com/mag/emusic_taming_elements_midi/>
- Pound, Ezra.** 1968. *Antheil and the Treatise on Harmony*. New York: Da Capo Press. First published 1927.
- Pressing, Jeff.** 1990. Cybernetic Issues in Interactive Performance Systems. *Computer Music Journal* 14:1: 12-25.
- Reynolds, Roger.** 1984. Conlon Nancarrow: Interviews in Mexico City and San Francisco. In *American Music*, Summer, 2:2.
- Rhees, David J.** 2002. Physics in "Lake Wobegon": A Tour of Three Minnesota Museums of Science and Technology. *Physics in Perspective* 4:4: 230-40.
- Risset, Jean-Claude and Scott Van Duyne.** Real-Time Performance Interaction with a Computer-Controlled Acoustic Piano. *Computer Music Journal* 20:1, Spring, 62-75.
- Rockwell, John.** 1981. Conlon Nancarrow — Poet of the Player Piano. *New York Times*, June 28, Section 2, Page 17, Arts and Leisure Desk, Late City Final Edition. Accessed March 27, 2007 via lexis-nexis.com.
- Roehl, Harvey N.** 1968. *Player pianos and music boxes: keys to a musical past*. Vestal, NY: Vestal Press.
- Rowe, Robert.** 1993. *Interactive Music Systems*. Cambridge: MIT Press.
- Rowe, Robert.** 2004. *Machine Musicianship*. Cambridge: MIT Press.
- Schwartz, Lloyd.** 2005. Music: Bloody Great. *The Boston Phoenix*, June 10-16. Accessed April 21, 2007 <http://bostonphoenix.com/boston/music/other_stories/documents/04743673.asp>
- Singer, Eric, et al.** 2004. LEMUR's Musical Robots. In *Proceedings of the 2004 Conference on New Interfaces for Musical Expression (NIME 2004)*.
- Singer, Eric, et al.** 2006. LEMUR: League of Electronic Musical Urban Robots. Accessed December 12, 2006 <<http://www.lemurbots.org>>.
- Southworth, Christine.** 2006. Music and Robots: Designing Robotic Musical Instruments and Writing Music for Robots in Conjunction with Human Performers. Master of Arts Thesis, Brown University.
- Southworth, Christine.** 2007. ENSEMBLE ROBOT. Accessed April 14, 2007 <<http://www.ensemblrobot.com>>
- Strickon, Joshua A.** 1999. Design and HCI Applications of a Low-Cost Scanning Laser Rangefinder. Master of Science thesis, Massachusetts Institute of Technology.
- Strouse, Jean.** 2006. Perpetual Motion. *New Yorker*, May 8.

- Trimpin.** 2000. *SoundSculptures: Five Examples*. Munich: MGM MediaGruppe München.
- Trimpin.** 2006. *SHHH: An Installation by Trimpin*. Seattle: Suyama Space. Edition of 500.
- Verbit, Marthanne.** 1997. Introduction to *The Piano Album*, by George Antheil. G. Schirmer, Inc. Distributed by Hal Leonard Corporation, Milwaukee, WI.
- Vercoe, Barry and Miller Puckette.** 1985. Synthetic Rehearsal: Training the Synthetic Performer. In *Proceedings of the International Computer Music Conference 1985 (ICMC 1985)*.
- Vroom, Steven Michael.** 2005. Looking Ahead with Trimpin. In *Vroom Journal*, April 23, vol iii. Accessed April 14, 2007 <<http://www.vroomjournal.com/articles/trimpin.php>>
- Vroom, Steven Michael.** 2006. SHH Trimpin at Suyama Space. In *Vroom Journal*, May 5, vol iv. Accessed April 14, 2007 <<http://www.vroomjournal.com/articles/trimpinsu.php>>
- Weinberg, Gil, Scott Driscoll, and Mitchell Parry.** 2005. Musical Interactions with a Perceptual Robotic Percussionist. In *Proceedings of the 14th IEEE International Workshop on Robot and Human Interactive Communication (RO-MAN 2005)*.
- Weinberg, Gil, and Scott Driscoll.** 2006. Toward Robotic Musicianship. *Computer Music Journal* 30:4: 28-45.
- Whitesitt, Linda.** 1983. *The Life and Music of George Antheil: 1900-1959*. Ann Arbor: UMI Research Press.
- Wikipedia contributors.** 2007. Trimpin. *Wikipedia, The Free Encyclopedia*. Accessed April 14, 2007 <<http://en.wikipedia.org/w/index.php?title=Trimpin&oldid=118843825>>
- Winkler, Todd.** 1998. *Composing Interactive Music*. Cambridge: MIT Press.
- Wright, Matt.** 2004. OpenSoundControl. Accessed April 20, 2007 <<http://www.cnmat.berkeley.edu/OpenSoundControl/>>

Colophon

The layout template for this thesis was designed by **Marc Downie**, with slight modifications by **Mike Fabio**. The thesis was written in **Apple Pages**. It is typeset using **Adobe Jensen Pro** and **Cronos Pro**. Many of the diagrams and flowcharts were created in The Omni Group's **Omnigraffle Pro**. Graphs were created using **Plot** by Michael Wesemann. Equations were created using **Apple Grapher**. Most images were modified using **Apple iPhoto** or **Adobe Photoshop**.