

File Copy

Book 000000

A MICROWAVE GAS DISCHARGE COUNTER FOR THE DETECTION OF IONIZING RADIATION

SANBORN C. BROWN and JOHN J. MCCARTHY

TECHNICAL REPORT NO. 75

JULY 29, 1948

RESEARCH LABORATORY OF ELECTRONICS
MASSACHUSETTS INSTITUTE OF TECHNOLOGY

The research reported in this document was made possible through support extended the Massachusetts Institute of Technology, Research Laboratory of Electronics, jointly by the Army Signal Corps, the Navy Department (Office of Naval Research), and the Air Force (Air Materiel Command), under the Signal Corps No. W-36-039 sc-32037.

MASSACHUSETTS INSTITUTE OF TECHNOLOGY

Research Laboratory of Electronics

Technical Report No. 75

July 29, 1948

A MICROWAVE GAS DISCHARGE COUNTER FOR THE DETECTION
OF IONIZING RADIATION

Sanborn G. Brown and John J. McCarthy

Abstract

Characteristics of a gamma-ray counter making use of a 3000-Mc gas discharge in a coaxial-mode cavity resonator are described. The breakdown of a discharge in gases at these frequencies does not depend upon secondary effects. Since the breakdown is not controlled by positive ions, shorter breakdown and resolving times than those of a Geiger-Müller counter are realized. In the high-frequency discharge, ambipolar diffusion is the controlling factor in loss of electrons. A d-c clearing field is superimposed on the a-c field to eliminate electrons rapidly. A quenching agent is present to suppress electron emission from positive-ion bombardment of the walls. The discharge is extinguished by reducing the magnetron power electronically. The plateau and sensitivity characteristics are similar to those of a Geiger-Müller counter.

A MICROWAVE GAS DISCHARGE COUNTER FOR THE DETECTION OF IONIZING RADIATION

1. Introduction

The discharge of electricity through gases at microwave frequencies behaves in a manner so different from the more common direct-current discharges that a study of its use as a detector of ionizing radiation is desirable. Breakdown of a gas by a high-frequency electric field of 3000 Mc does not depend upon secondary effects essential in a d-c breakdown. When the rate of production of electrons under the action of the electric field exceeds the rate of loss due to diffusion, attachment, or recombination, the gas breaks down.¹ After the breakdown occurs, the space-charge density is so large that the electrons diffuse ambipolarly; that is, the electron diffusion is retarded by the field of the positive ions. The electrons therefore diffuse to the walls much more slowly than in the absence of the space charge. The ambipolar diffusion clean-up time for the electrons after the discharge is extinguished may be a few hundredths of a second.

It is possible to design cavity resonators so that a d-c field can be added to the high-frequency field. The d-c field speeds up the removal of electrons from the ionizing region and short resolving times are therefore possible.

The electronic circuit used to operate the high-frequency gas discharge cavity as a counter is illustrated by the block diagram of Fig. 1.

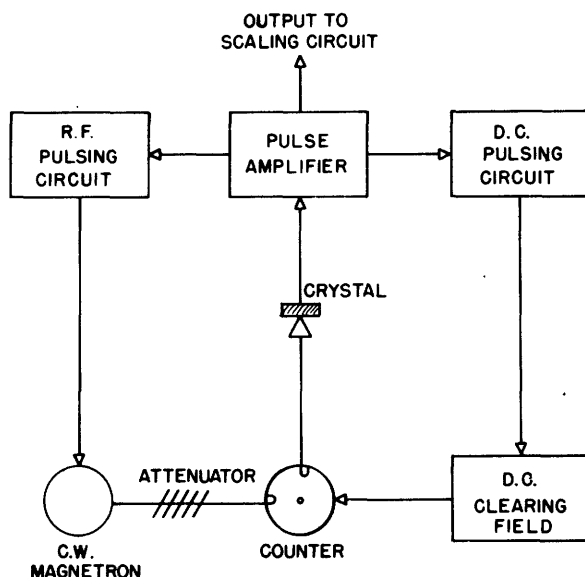

Fig. 1. Block diagram of the counter circuits.

A 3000-Mc c-w magnetron feeds power to the counter. When an ionizing particle enters the cavity, a discharge is initiated which mismatches the line termination, causing a sudden reduction in the transmitted signal. The pulse is fed

1. M. A. Herlin and S. C. Brown, RLE Technical Report No. 60; also published in Phys. Rev. 74, 291 (1948).

through a crystal rectifier to an amplifier and pulser circuit. This circuit serves three functions: it reduces the magnetron power, terminating the discharge in the counter; it increases the superimposed d-c field of the cavity to speed up the removal of the electrons produced by the discharge; and, finally, it actuates an external scaler and message register which records the number of ionizing events taking place inside the counter.

2. Geometrical Factors

A high-frequency discharge can take place in a resonant cavity of any shape, provided the intensity of the electric field is high enough to cause breakdown. The ability of a d-c field to sweep electrons from a discharge depends strongly upon the shape of the field. A non-uniform field (as in the case of a Geiger-Müller counter) has a great advantage in removing electrons rapidly. In cylindrical geometry, the highest field occurs at the surface of the axial electrode. If this electrode is a fine wire, the field is appreciable only in its vicinity and the discharge is concentrated there. Since the electrons have their maximum concentration near the axial wire, they may be swept out rapidly if this wire is given a positive potential with respect to the wall of the cavity.

A design of a coaxial-mode resonant cavity for use as an ionization counter is shown in Fig. 2. The fine wire at the center of the cavity

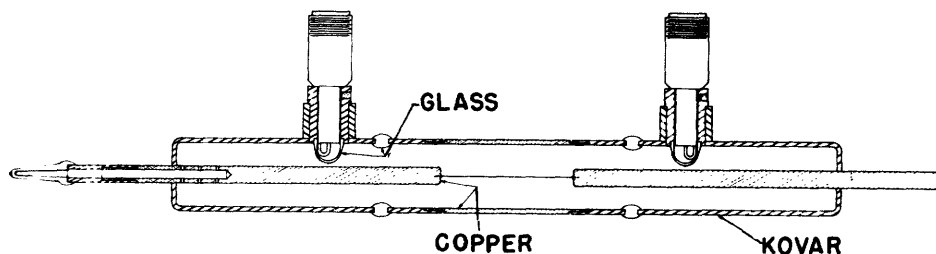

Fig. 2. Cross-sectional view of the microwave counter cavity resonator.

is a half wavelength long. The entire discharge takes place at the central section of the tube. The discontinuities in the axial conductor are designed to occur at nodal points of the electric field. The glass insulating rings which allow a d-c potential to be maintained between the electrodes at the center of the cavity are placed at current nodal planes. Loops to couple

high-frequency power in and out of the cavity are placed at maximum magnetic field points. The tube is evacuated and filled through a hollow section at the end of one of the larger coaxial members. Vacuum seals are maintained over the ports for the loops by sealing in glass bubbles which allow the loops to project into the cavity volume. A typical loaded Q of the cavity shown in Fig. 2 is 360. A directional coupler in the r-f line samples the input power. This power is measured by a thermistor bridge.

3. Breakdown Characteristics

The factors which control the necessary input a-c power to cause breakdown in a given cavity are the type of gas, the pressure, and the amount of d-c potential maintained across the electrodes.

Breakdown of a gas discharge by a high-frequency field occurs when the production of new electrons exceed the loss of electrons due to any cause such as diffusion, attachment, or recombination. Since a d-c field sweeps electrons from the discharge, the greater loss of electrons appears as an increase in the power necessary to produce breakdown. Figure 3 shows this effect. The figure also shows that the d-c field does not result in an indefinite increase of the a-c breakdown power. As the d-c field is increased, the a-c breakdown power reaches a maximum and thereafter the necessary a-c power is lowered. When the a-c breakdown field is reduced to zero by increasing the d-c voltage, the d-c field is the usual value for d-c breakdown.

When an ionizing particle enters the sensitive volume of the counter, cumulative ionization takes place due to the increase of energy of the electrons in the high-frequency field. Since a breakdown occurs when the rate of this ionization exceeds the rate of loss of electrons to the walls, without the operation of any secondary effects, very rapid breakdown is expected. The rate at which breakdown occurs was measured directly by using a micro-oscillograph.¹ Figure 4 shows a reproduction of an oscilloscope trace of the transmitted power, attenuated by the discharge after breakdown. The total length of sweep shown in the figure is 10^{-7} seconds. From oscillograms of this type, the decay of the transmitted power was measured as reducing to $1/e$ the of its initial value in 2×10^{-8} seconds.

A delay-line clipping method of measuring breakdown times was also used. This method consists of feeding the rectified output pulse from the counter to both a short-circuited section of coaxial line and another crystal feeding the floating grid of a vacuum tube. On breakdown, a pulse is fed to the grid of the vacuum tube and this pulse is terminated by the reflected

1. G. M. Lee, Proc. Inst. Radio Eng., 34, 121 W (1946).

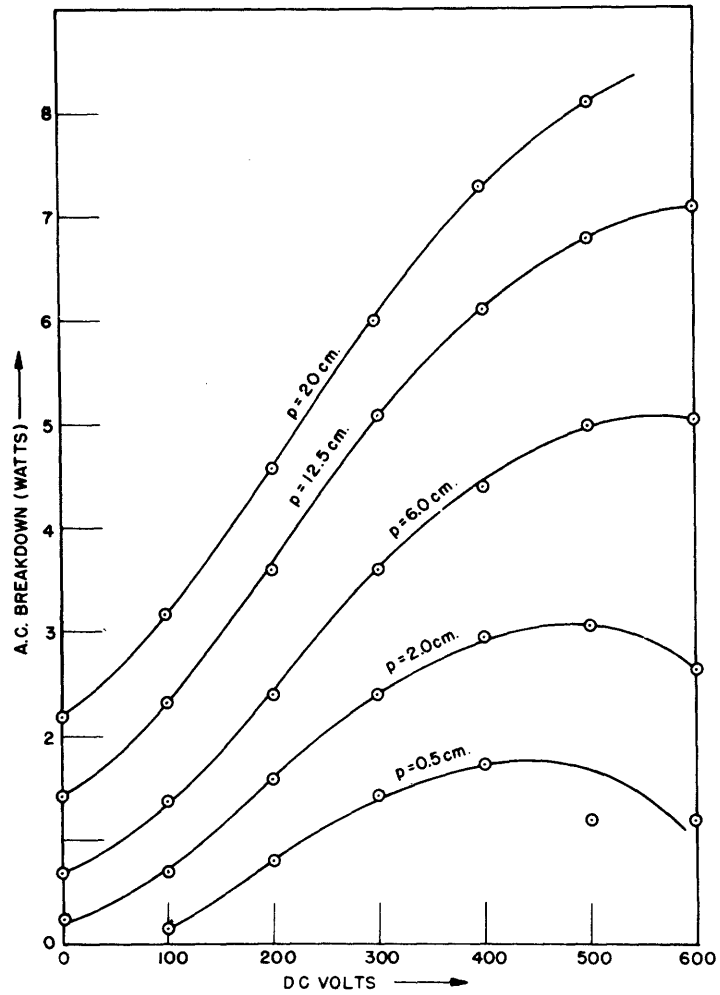

Fig. 3. The input power to the cavity to cause breakdown plotted against a superimposed d-c potential for various different pressures. The filling gas was 90 per cent helium and 10 per cent methyl alcohol.

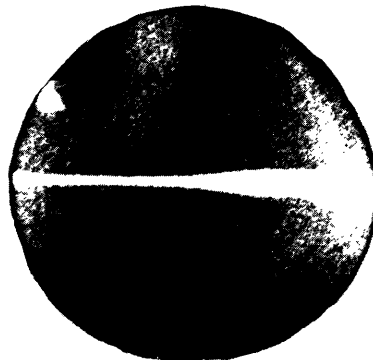

Fig. 4. A micro-oscillogram of the gas-discharge breakdown in the counter. Transmitted power is plotted against time increasing from left to right. The total sweep time is 10^{-7} seconds.

pulse from the short-circuited end of the coaxial line. The crystal in the grid circuit is arranged so that the time constant of this section is short compared with the rise time of the pulse for pulses going to the grid, but very much longer for the reverse direction. When the reflected pulse terminates the primary pulse before the latter has had time to build up to its full value, a smaller pulse is fed to the grid and hence to the oscilloscope. By measuring the height of the pulses on the oscilloscope screen as a function of the length of the short-circuited coaxial cable, and knowing the velocity of travel of the pulse in the cable, one can determine the speed of breakdown of the discharge. Data taken in this way are plotted in Fig. 5. The

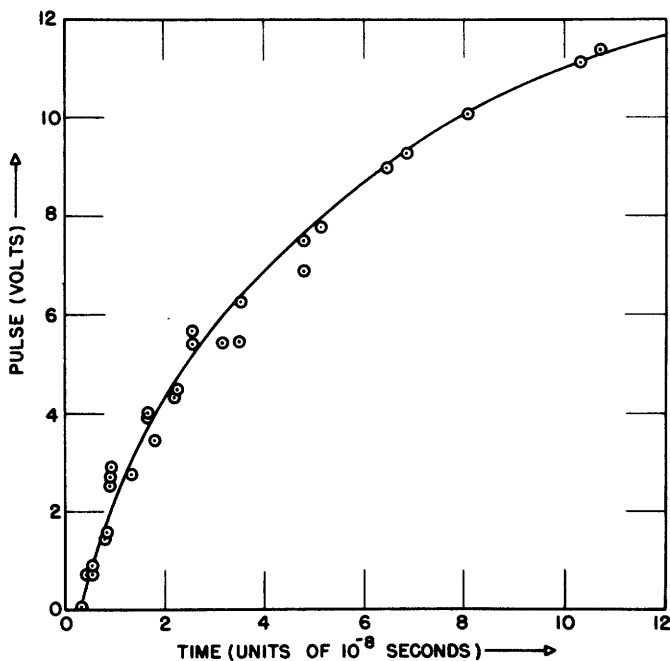

Fig. 5. Measured pulse heights as a function of time, obtained by using delay-line clipping method.

delay-line clipping method of measurement agrees with the direct oscilloscope picture by showing that in a transmitted signal a measurable pulse can be detected at the crystal output of the cavity 2×10^{-9} seconds after initiation. The pulse reaches 1/e th of its maximum value in approximately 2×10^{-8} seconds.

4. Discharge Build-up

Although the initial stages of the breakdown phenomena are very rapid because of the absence of secondary effects, the time for the steady-

state condition to be realized is fairly long. This effect is illustrated in Fig. 6. The resolving time of the counter is the length of time required to collect all the electrons formed in a discharge. The resolving time is therefore proportional to the number of ion pairs formed in the discharge, and a plot of the resolving time as a function of the length of time the discharge is on gives an indication of the time required to reach a steady state in the discharge. Figure 6 shows that a steady state is reached in 4×10^{-5} seconds

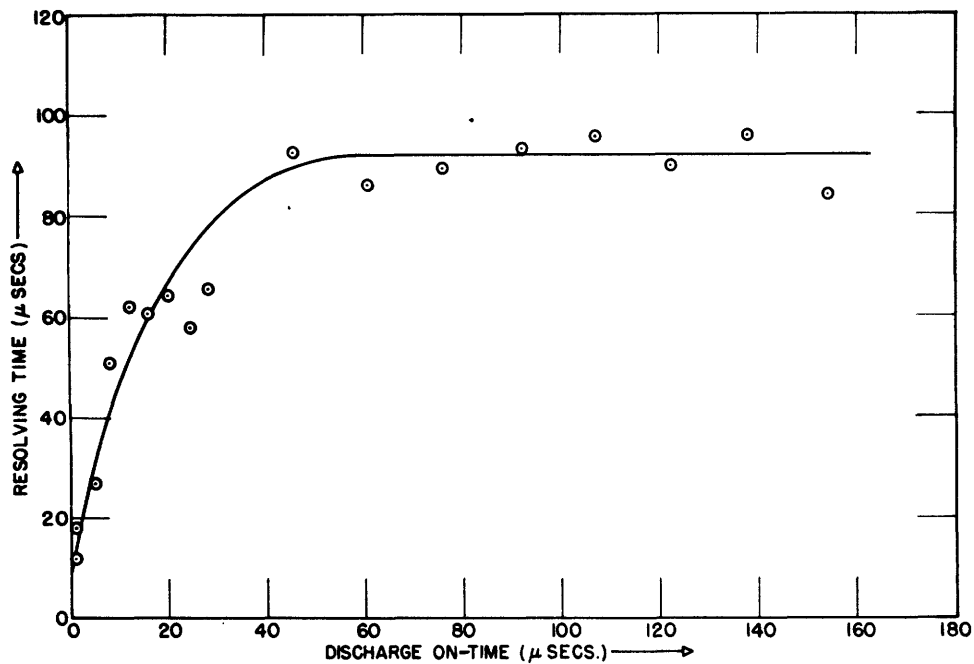

Fig. 6. The resolving time as a function of the on-time of the discharge, illustrating the length of time required for the discharge to reach a steady state.

after breakdown with the experimental conditions of 6-cm pressure of helium and alcohol and an input power of 2 watts. It also indicates that the sooner after breakdown the discharge can be turned off, the shorter will be the resolving time of the counter. The total delay time of the magnetron control circuit due to magnetron capacitance is about one or two microseconds and is a limiting factor in reducing the resolving time of the counter.

5. Steady-State Characteristics

The number of electrons involved at the beginning of the breakdown is so small that the electrons diffuse as free electrons, moving rapidly to the walls, and leaving positive ions behind. A positive-ion space charge

is thus built up which slows down the loss of electrons produced after breakdown, giving rise to the phenomenon of ambipolar diffusion. Since the loss of electrons is thereby retarded, the field necessary to maintain the discharge need not be so high as at breakdown. Figure 7 illustrates the effect. After breakdown occurs, the cavity field drops along the load line of the power generator to a constant, maintaining field.

The electric field in the resonant cavity can be increased above the point necessary to produce breakdown as indicated by the upper point on the ordinate of Fig. 7. When breakdown occurs under this condition, the

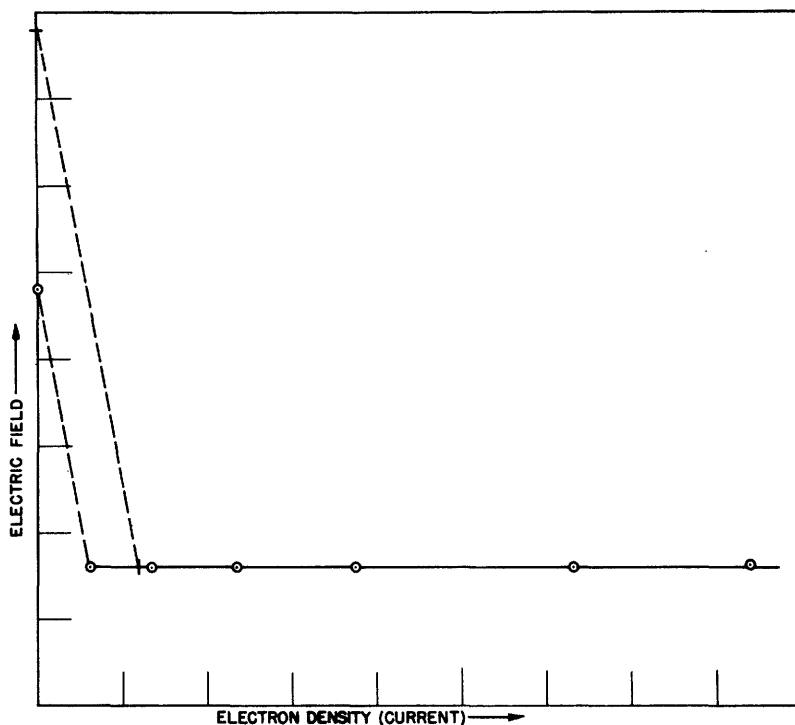

Fig. 7. The electric field in the cavity is high at breakdown and thereafter drops to a constant, maintaining field.

field drops along the generator load line, and in so doing it arrives at a steady operating current which is greater than that carried by the steady discharge just at breakdown.

If a d-c field is superimposed on the a-c field, the necessary a-c power for breakdown is increased, as illustrated in Fig. 3. As far as the steady discharge is concerned, this has the same effect as increasing the pure a-c field above breakdown. At threshold the current carried by

the discharge, and hence the number of electrons produced in the discharge, is greater when a d-c field is superimposed on the high-frequency than in a pure a-c discharge. Thus, although a steady field can be advantageous in sweeping electrons from the cavity after the a-c discharge is turned off, it increases the number of electrons formed in the discharge, and hence could increase the counter resolving time.

6. Electron Clearing

After the high-frequency discharge has been turned off, a d-c field must be applied to the resonant cavity to clear the electrons from the cavity as rapidly as possible. If the d-c field is superimposed on the high-frequency field continuously, the threshold power increases, with a resulting increase in the number of ion pairs formed in the discharge and a lengthening of the clearing time. To avoid this difficulty, a clearing pulse is applied at the same time that the high-frequency power to the cavity is shut off. Both the amplitude and width of the d-c pulse have been varied. As the pulse amplitude is increased, the necessary clearing time is decreased so that the d-c clearing pulse may be shortened. The shortest resolving times are achieved with the highest voltage pulses for which the total instantaneous impressed voltage does not of itself cause the discharge to increase.

The resolving time of the resonant cavity counter will depend on the length of time it takes to remove the last electron from the cavity. For this reason it is important to study this electron clearance in detail. Typical data of the change in clearing time with input power are shown in Fig. 8. It is seen that as the power to the cavity is increased, the resolving time increases. These data were taken with a constant build-up time for the discharge of two microseconds. In this length of time, the steady state for the diffusion of electrons in the space-charge field of the positive ion has not been reached, so that the higher the input power, the more electrons are formed in a given time. The resolving time is a function of the power alone. One obtains the same value for the same power whether the data are taken just at the threshold with a high d-c voltage superimposed on the high-frequency power, or far above threshold with no d-c superimposed at breakdown. The data which led to the plotted points in Fig. 8 show that a clearing time of 50 μ sec corresponds to an input power of 2.3 watts, whether the data were taken at threshold with a steady d-c voltage of 300 volts and a 500-volt d-c pulse, or far above threshold with zero steady voltage and an 800-volt d-c pulse.

The curve of Fig. 8 shows that the resolving time tends to level off at high powers. This levelling off occurs when the power supplied to the discharge is sufficient to produce a steady-state diffusion in the length of

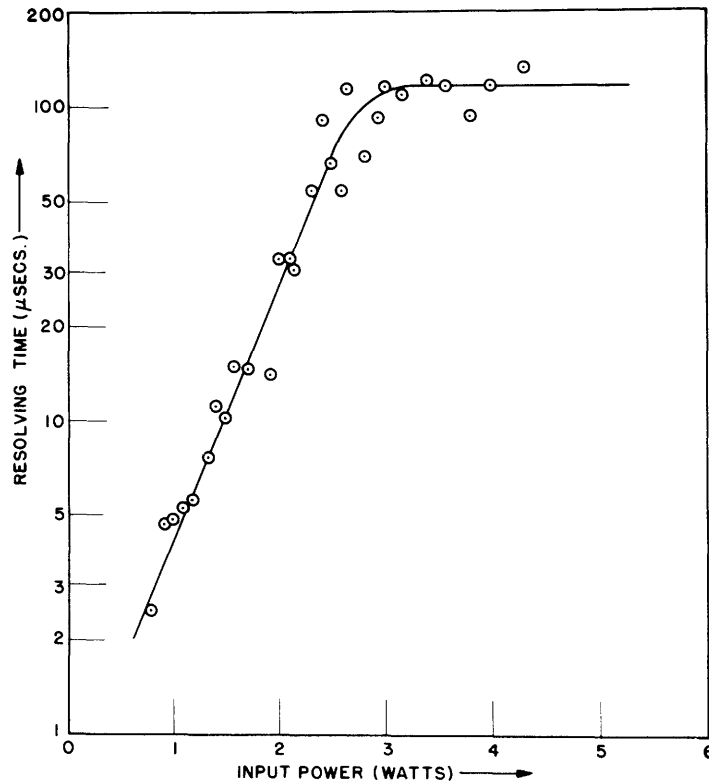

Fig. 8. The resolving time, which is the time to clean out the last electron, plotted against the input power to the counter.

time the discharge is on. Figure 9 gives a family of curves illustrating the effect of changes in pressure of the gas on the resolving time. It can be seen that the time necessary to produce the steady-state condition is shortest at the lower pressures.

The data on electron clearing indicate the following. A minimum resolving time of 2 microseconds can be obtained, the limitation being set by the time constants of the associated electronic circuits. This is realized only with a pure high-frequency discharge. As will be shown later, a pure a-c discharge in cylindrical geometry is inefficient as a radiation counter, and for that reason a steady d-c voltage must be applied to increase the sensitivity. The d-c field has the effect of increasing the necessary operating power and therefore increases the resolving time. Operation with a steady d-c voltage of 100 volts leads to a minimum resolving time of 10 microseconds and a maximum sensitivity.

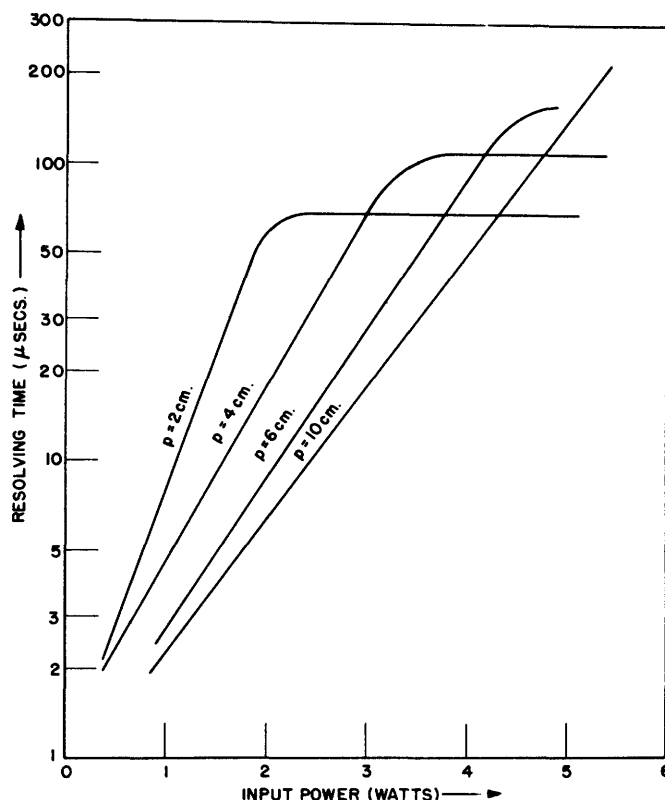

Fig. 9. The resolving time plotted as a function of the input power for several different pressures. The filling gas was 90 per cent helium and 10 per cent methyl alcohol.

7. Positive-Ion Effects

The high-frequency power is affected only by the electrons in the gas discharge, since the positive ions are too heavy to be measurably displaced by the field. The positive ions do affect the discharge in other ways, however. If a positive ion of a noble gas hits the outer wall of the resonator, it will produce a secondary electron as in the Geiger-Müller counter. One can use polyatomic gases as is done in the self-quenching type of Geiger-Müller counter to prevent secondary electron formation by positive-ion bombardment. Ten per cent methyl alcohol and 90 per cent helium constituted the gas mixture used in this investigation. For stable and low surface emission characteristics the outer walls were made of copper in the regions where the positive ions strike. This is shown in Fig. 2.

8. Counter Characteristics

The sensitivity of the resonant cavity for detecting ionizing radiation depends upon the ability of an electron to initiate the high-frequency

gas discharge. Every electron which passes through the ionizing region of the coaxial cavity, in the neighborhood of the axial wire, will initiate a discharge. If the counter is operated with only an a-c field within the cavity, electrons which pass through the cavity outside the region of ionizing field may not initiate a breakdown. For this reason, a pure a-c counter of cylindrical geometry will have a very low sensitivity to radiation compared with a Geiger-Müller counter of the same physical dimensions because the sensitive volume is so small.

If a d-c electric field is applied in the resonant cavity with the axial wire at a positive potential, electrons formed anywhere within the counter will be accelerated toward the high a-c field region and hence will initiate a discharge. This effect is shown in Fig. 10, where the counting

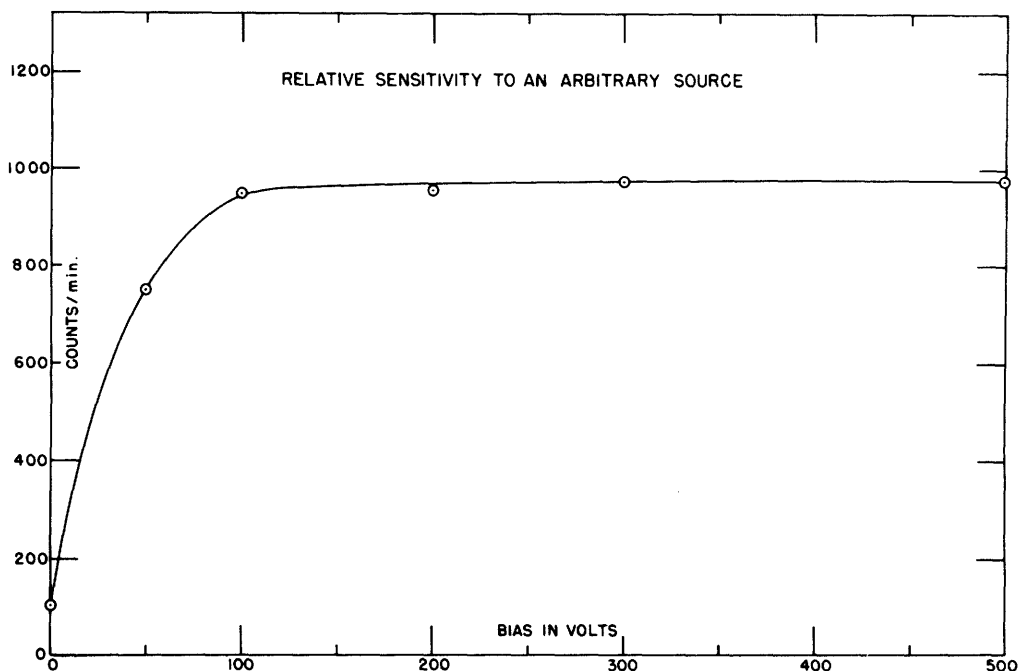

Fig. 10. The relative sensitivity of the counter to an arbitrary source plotted as a function of the steady d-c bias applied to the counter cavity.

rate from a fixed, arbitrary source is plotted against the magnitude of a steady d-c potential superimposed on the a-c counting field. It can be seen from this figure that a small steady potential is sufficient to insure a collection of all the electrons formed by the passage of the ionizing radia-

tion through the counter. The counting rate above 100 volts is the same as is obtained with a Geiger-Müller counter of the same geometry.

The speed with which an electron is pulled into the sensitive volume depends upon the d-c potential applied across the electrodes. Hence the time delay between the entrance of the ionizing particle and the initiation of the counter discharge would be expected to be the same as that determined for proportional counters operating at the d-c bias voltages shown in Fig. 10.

The operating characteristics are similar to those found with a Geiger-Müller counter. The tube starts to count at a definite threshold power; there is a region where the counting rate is relatively independent of input power, and above a certain power a continuous discharge takes place. These counting characteristics are shown in Fig. 11.

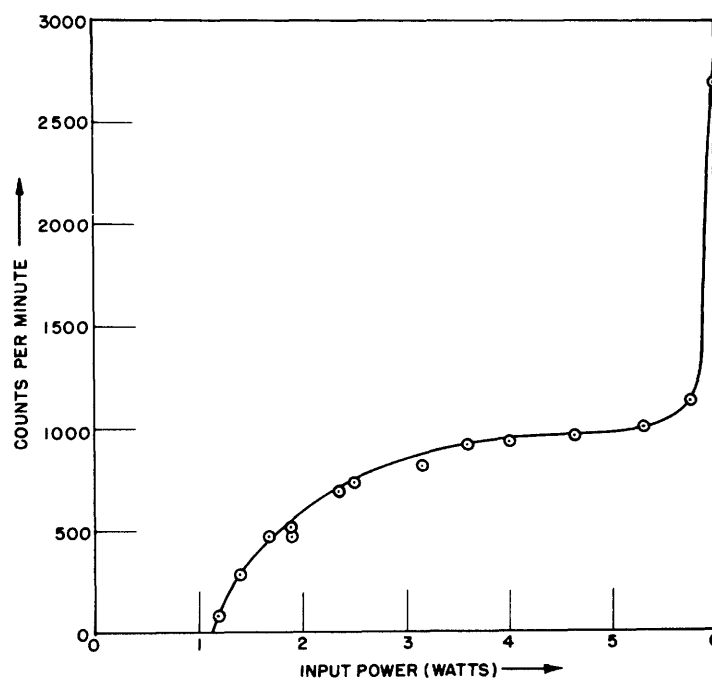

Fig. 11. The operating characteristic of the counter is illustrated by plotting the counting rate from an arbitrary source as a function of input power.

9. The Control Circuit

If all the factors which have been discussed are considered, optimum operation can be achieved in the following manner. Before the entrance of an ionizing ray the counter is operated as a resonant cavity in a coaxial-cylinder mode with a small steady potential of a few hundred volts applied across the electrodes and a high-frequency field sufficient to be above the threshold field for breakdown. An ionizing ray entering anywhere within the

cavity will cause a breakdown with a small discharge current. When the cavity breaks down, the r-f power is turned off and a d-c pulse of 500 or 600 volts is superimposed on the d-c sweeping field of the counter. The d-c pulse is kept on for a time sufficient to collect all the electrons, after which it is removed and the r-f field is returned to its original value. The counter is then ready to operate again.

The diagram of Fig. 12 shows the essential electronic circuit used to control the operation of the magnetron and the counter. The power supplies, power switches, relays and r-f plumbing are omitted for sake of simplicity. At the start of operation, R27 is adjusted so that T4 is conducting and T5 is just beyond cutoff; this puts a zero bias on the grid of T6, the current regulator for the magnetron T7. The magnetron current is controlled by the screen voltage of T6 which is set to give approximately 80 - 100 ma magnetron current. R46 is adjusted to make T9 conducting and to cut off T10. The d-c bias on the counter, which is adjusted from 0 to -200 volts, is then available at the plate of T10.

The r-f output of the magnetron, T7, is fed through a 6-db power attenuator to a power divider, not shown in the diagram, which controls the actual amount of r-f power into the counter. One thousandth of this incident r-f power is taken from a directional coupler in the transmission line, and is made available for power monitoring purposes. The r-f power transmitted through the counter is monitored by the crystal, XI, and the meter, M1. This power is controlled by adjusting the plane of the counter output coupling loop to give sufficient signal for proper operation of the electronic control circuit.

In the presence of radiation, the counter will break down when sufficient r-f power is being fed into the counter, giving rise to a sharp discontinuity in the transmitted signal. This discontinuity is differentiated by C1 and R4 and amplified by T1 and T2, issuing as a positive trigger pulse. T3 inverts this pulse, removes pulse overshoots, eliminates random crystal and vibration noise and provides a cathode-follower output to the multivibrator of T4 and T5. The negative pulse at the grid of T4 causes this circuit to trip, producing at the plate of T5 and grid of T6 a negative pulse whose duration is controlled by R21 and C12. The signal at the grid of T6 cuts off T6 and consequently reduces the magnetron current and power output to zero, permitting the discharge to extinguish. Simultaneously the sharp positive pulse from T2 produces the same effect in the circuits of T8, T9, and T10 with the exception that the negative pulse on the plate of T10 is much larger in amplitude. Its width is controlled in a similar manner by R40 and C19. This pulse appears at the counter to remove the electrons produced by the discharge. For most purposes the duration of the d-c pulse is the same as that of the

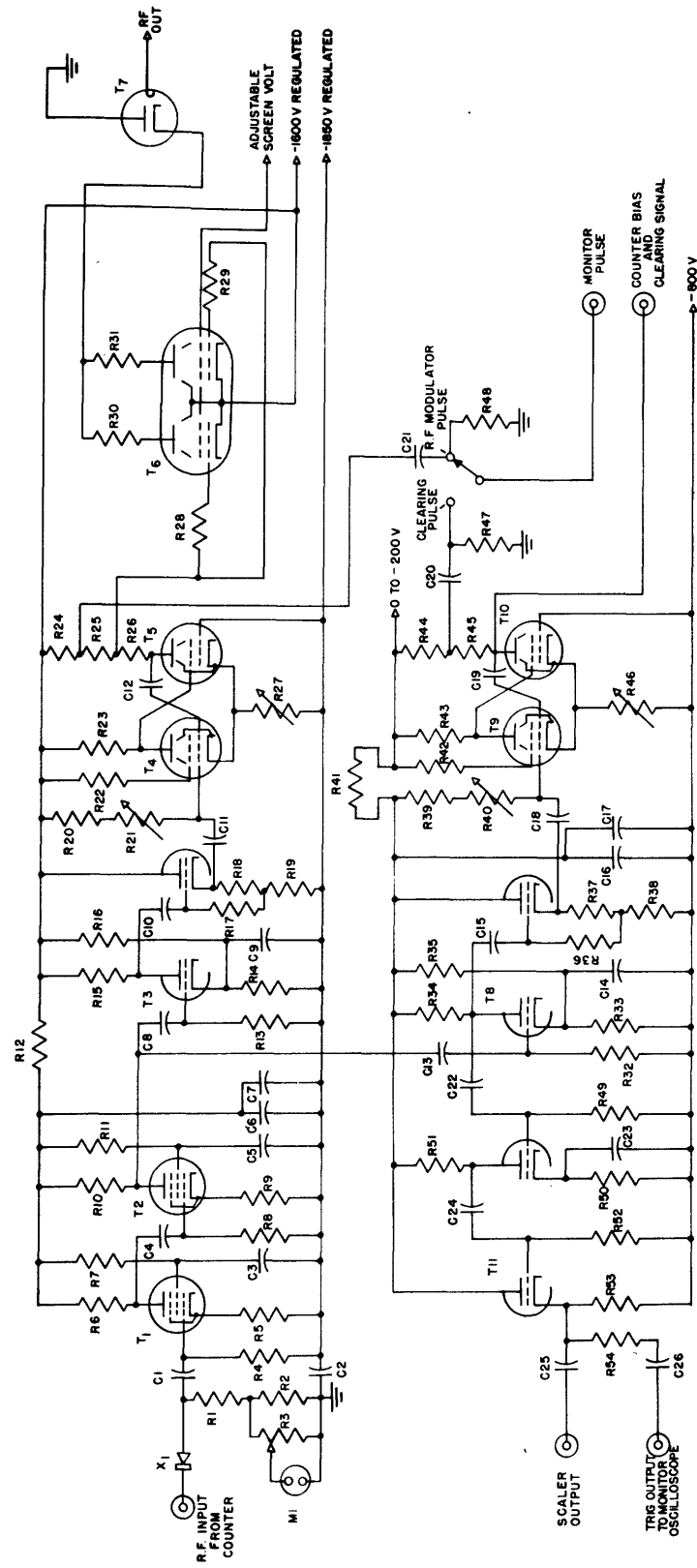
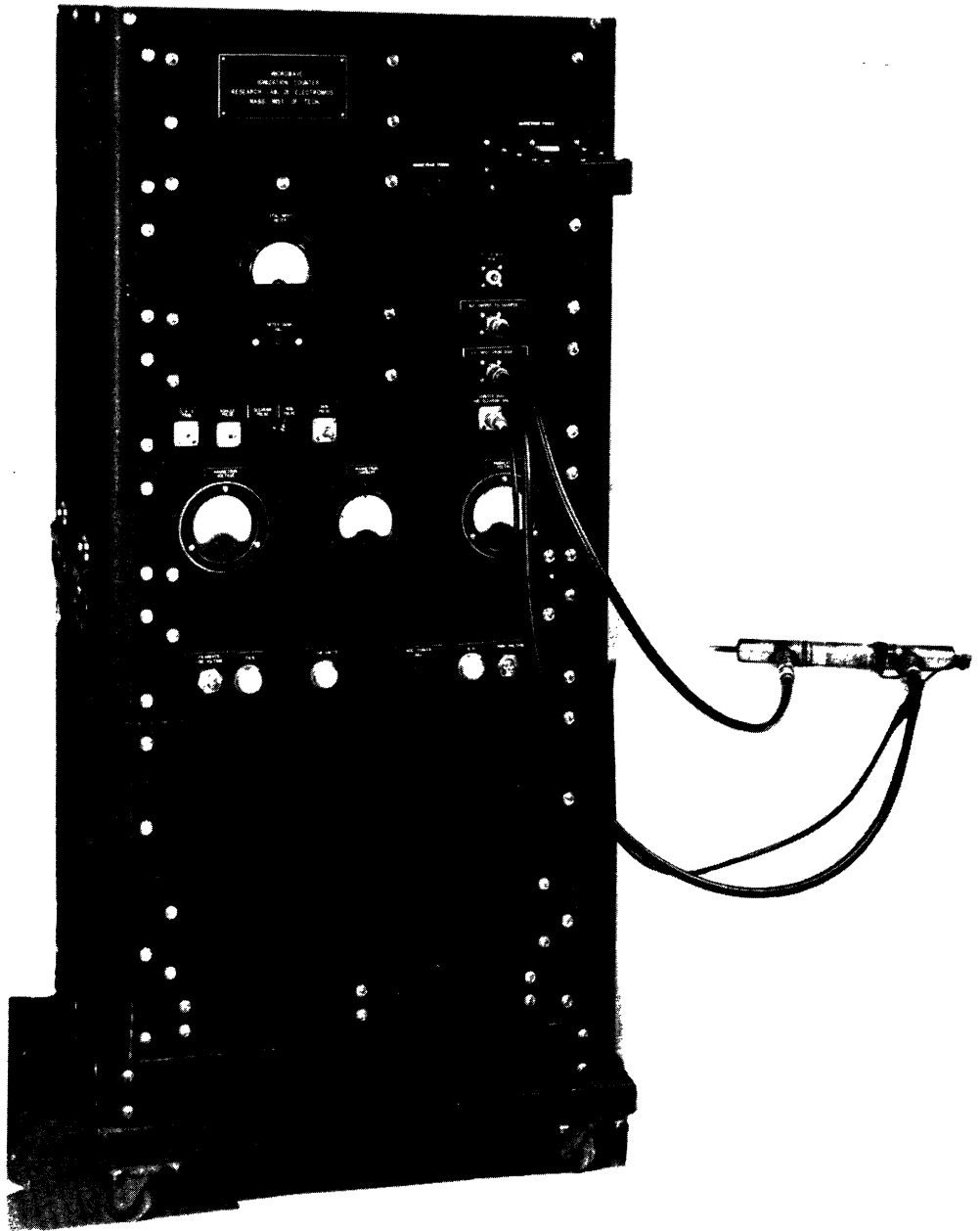

Fig. 12. Circuit diagram of the counter control system.

C1, C13	.001 μ f - 2.5 kv	R23, R45	5 k - 10 w
C2	2 μ f - 2.5 kv	R24, R25	510 Ω - 1/2 w
C3, C5, C7, C9, C17	.01 μ f - 400 v	R26	1 k - 1 w
C6, C16	16 μ f - 450 v	R27	1 k - 4 w w.w. potentiometer
C4, C8, C10, C11, C18, C22	.0001 μ f - 400 v	R28, R29, R37, R50	100 Ω - 1/2 w
C15, C24	.001 μ f - 400 v	R30, R31	100 Ω - 1 w
C12	.00015 μ f - 400 v	R33	3.9 k - 1/2 w
C14, C23	.05 μ f - 400 v	R34	10 k - 1 w
C19	.00005 μ f - 400 v	R35	47 k - 2 w
C20, C25, C26	.01 μ f - 1 kv	R38	10 k - 10 w
C21	.01 μ f - 2.5 kv	R39	470 k - 1 w
M1	0 - 200 μ a meter	R40	10 m - 2 w carbon potentiometer
R1, R4	1 k - 1/2 w	R41	10 k - 20 w
R2	51 Ω - 1/2 w	R42	50 k - 20 w
R3	5 k - 1 w w.w. potentiometer	R43	10 k - 76 w
R5, R9	130 Ω - 1/2 w	R44	510 Ω - 2 w
R6, R10	5.1 k - 1 w	R46	500 Ω - 7 w w.w. potentiometer
R7, R11	33 k - 1 w	R47, R48, R49, R52	1 m - 1/2 w
R8, R13, R17, R32, R36	100 k - 1/2 w	R54	20 k - 1/2 w
R12	2.7 k - 2 w	S1	S.P.D.T. rotary switch
R14	3.6 k - 1/2 w	T1, T2	6SH7GT
R15, R53	10 k - 1/2 w	T3, T8, T11	6SN7GT
R16	43 k - 2 w	T4, T5	6V6GT
R18	200 Ω - 1/2 w	T6	829-B
R19, R51	10 k - 2 w	T7	QK-61 tunable c-w magnetron
R20	220 k - 1/2 w	T9, T10	6L6GA
R21	5 m - 2 w carbon potentiometer	X1	1N21 crystal
R22	5.1 k - 2 w		



(Front view)

Fig. 13. Photograph of the complete counter power supplies and control circuits.

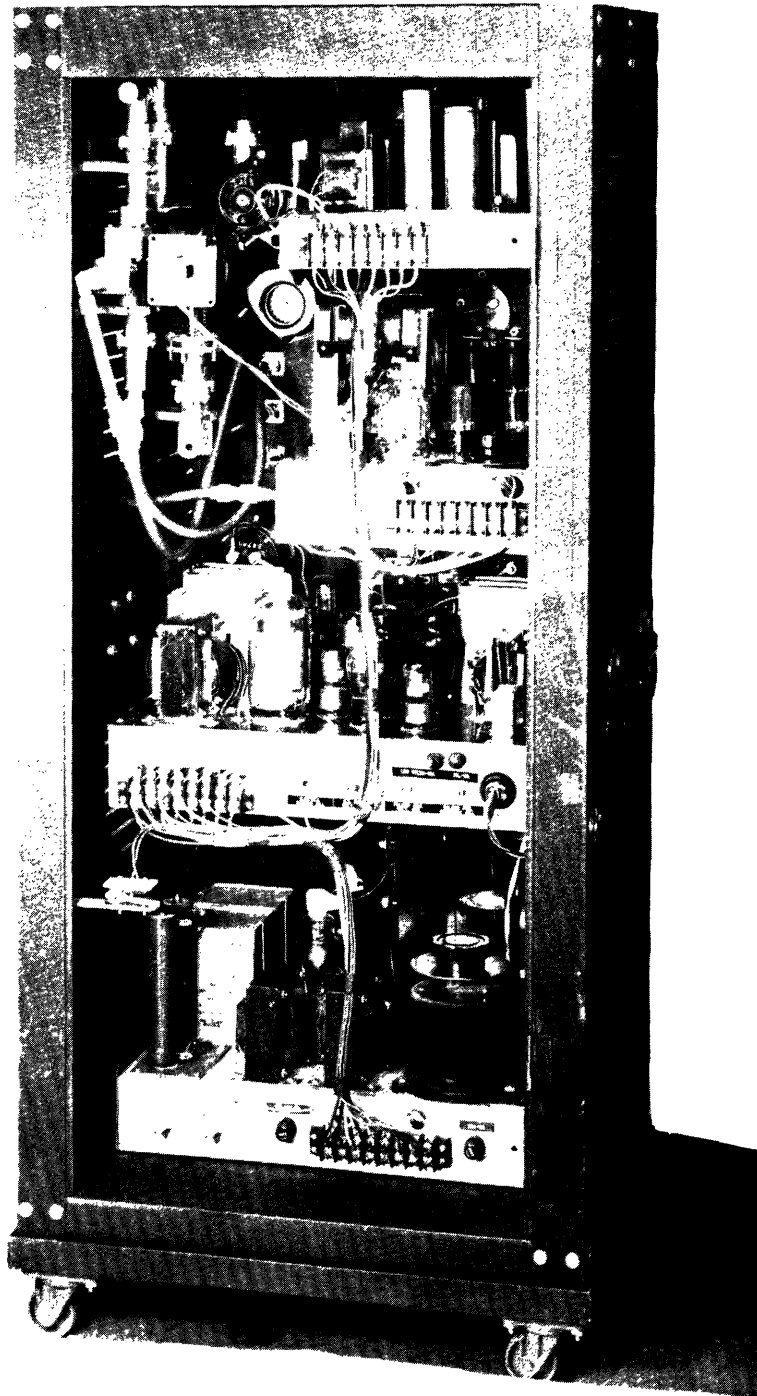

(Rear view)

Fig. 13. Photograph of the complete counter power supplies and control circuits.

magnetron cutoff pulse. For purposes of providing a synchronizing trigger for a monitor oscilloscope and a pulse for a scaler and message register, the negative pulse from the plate of T8 is inverted, amplified, and given a low impedance cathode-follower output in T11. After the pulses from T5 and T10 have expired, T5 and T10 return to their normal non-conducting state and the counter and circuit are again ready for another cycle of operation.

All of the necessary circuits including the magnetron and its power supply can be housed in a single cabinet. A photograph of the front and rear views of such a cabinet is shown in Fig. 13. The counter is shown attached to plugs in the front, while the rear view shows the magnetron and high-frequency plumbing as well as the vacuum tube circuits.

10. Summary

The microwave counter compares with the d-c counter as follows: The microwave counter has a minimum resolving time of two microseconds and a pulse rise time of about 10^{-8} seconds with a detectable pulse 2×10^{-9} seconds after the start of breakdown. These figures show that the microwave discharge is one or two orders of magnitude faster than the d-c discharge of a Geiger-Müller counter. The microwave counter has the same sensitivity to gamma radiation as an equivalent Geiger-Müller counter. Because of the cylindrical geometry, there is a delay between the entrance of the ionizing particle and the initiation of the discharge if the particle does not pass through the cumulative ionization region near the axial wire. This delay is the same as that found in a coaxial proportional counter operated at a potential difference of 100 volts. The necessary auxiliary apparatus to operate the counter is somewhat bulkier than that of a Geiger-Müller counter because of the power supply for the c-w magnetron.

We gratefully acknowledge the continuous assistance of Mrs. Norma W. Donelan in obtaining the data for this investigation.