

PERFORMANCE STUDY OF FLIGHT DECK INTERFACE SYSTEMS FOR
AIR TRAFFIC CONTROL-PILOT DATA LINK COMMUNICATIONS (CPDLC)

by

TERENCE PING CHING FAN

Bachelor of Applied Science in Mechanical Engineering (with Distinction)
University of British Columbia, Vancouver, Canada, 1997

Submitted to the Department of Aeronautics and Astronautics in Partial Fulfilment of the
Requirement for the Degree of Master of Science in Aeronautics and Astronautics

at the

MASSACHUSETTS INSTITUTE OF TECHNOLOGY

June, 1999

© 1999 Massachusetts Institute of Technology

All rights reserved

Aero

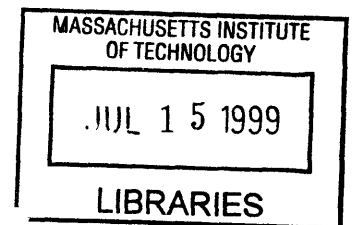

Signature of Author.....

Department of Aeronautics and Astronautics
and Technology and Policy Program

May 21, 1999

Certified by.....

James K. Kuchar, Assistant Professor of Aeronautics and Astronautics
Acting Director, International Center for Air Transportation
Thesis Supervisor

Accepted by.....

Jaime Peraire, Professor of Aeronautics and Astronautics
Chair, Department Graduate Committee

PERFORMANCE STUDY OF FLIGHT DECK INTERFACE SYSTEMS
FOR AIR TRAFFIC CONTROL-PILOT
DATA LINK COMMUNICATIONS (CPDLC)

ABSTRACT

In an effort to reduce saturation in voice radio channels and to take advantage of space-based communication technologies in a cost-effective basis, data link communication between the flight deck and air traffic control (CPDLC) is gradually coming to the fore. Currently, there are three main flight deck interface designs for CPDLC, and a comparative human factors study of these designs is documented in this thesis. However, in spite of the recent development, there is little coherent understanding on the influence of hardware interface components on performance. To contribute to this understanding, the performance of two flight deck CPDLC interface designs were compared at the Boeing Company, and the result was used to estimate the performance of a third interface design. As a follow-on study, an experiment was conducted to examine the relative performance of four simplified interface configurations for CPDLC. The experiment found that there was little difference in performance (task processing time, accuracy and efficiency) among the four interface configurations in simple communication tasks. However, as the level of difficulty of these tasks increases, a dual-interface configuration with separate functionality on each interface required the least amount of time to accomplish the stated tasks. The additional maneuverability provided by a dual-interface configuration with identical functionality on each interface did not appear to lead to significant additional performance gains compared with the dual-interface configuration with separate functionality. In general, the single-interface configurations required longer processing times for complicated tasks and were also found to incur higher workload according to the NASA Task Load Index.

ACKNOWLEDGEMENTS

This work was supported by the National Aeronautics and Space Administration (NASA) Ames Research Center under Grant NAG-2-1111. I must thank the Boeing Company for providing me with the opportunity to work in the Flight Deck Engineering Group in the summer of 1998, where much of the work presented in this thesis was inspired. In addition, the financial support of the Canadian Transportation Research Forum and the National Science and Engineering Research Council of Canada during my Master's study must also be acknowledged.

Sincere gratitude must be expressed to Professor James Kuchar of the Department of Aeronautics and Astronautics for his advice and guidance throughout the my Master's study at MIT, and for his permission for my diverse course selection. I would also like to thank Professors Odoni, Hansman and Clarke at the International Center for Air Transportation (ICAT) for their support and guidance.

I must also thank my parents for providing unwavering support throughout my undergraduate and graduate work, and students at ICAT and MIT in general for their wondrous company.

TABLE OF CONTENT

Abstract	2
Acknowledgements	3
List of Figures	6
List of Tables	8
1. Introduction	9
2. Data Link and Flight Deck Layout	17
2.1 Air-Ground Data Link	17
2.2 Layout of Modern Flight Decks	21
2.3 MCDU-Based Interface System Layout	27
2.4 DCDU-Based Interface System Layout	30
2.3 MFD-Based Interface System Layout	33
3. Comparison of Flight Deck CPDLC Interfaces	37
3.1 Crew Alert Mechanism	38
3.1.1 Aural Alerts	39
3.1.2 Visual Alerts	41
3.2 Interface Performance	44
3.2.1 Responding to a Simple ATC Message	47
3.2.2 Rejecting an ATC Message with Reason	53
3.2.3 Confirm Speed and Assigned Speed	57
3.2.4 Position Report	61
3.2.5 Altitude Request	64
3.3 Overall Comparison	68
4. Interface Design Study	75
4.1 Objectives	75
4.2 Previous Research	76
4.3 Interface Configurations	78
4.4 Classification of Communications Tasks	83
4.5 Subtasks	86
4.7 Selection of Workload Assessment Tool	89
5. Results of The Interface Design Study	93
5.1 Subject Profile	93
5.2 Performance by Task Type	95
5.2.1 Simple Acceptance	95
5.2.2 Questionable Commands	99
5.2.3 Flight Plan Cross-Checking	103

5.2.4	Pilot-Initiated Downlinks	108
5.2.5	Systems-Related Tasks	110
5.3	Overall Impact of Button-Pushes	113
5.4	Subjective Workload	115
6.	Conclusions	119
	References	125
Appendix A	Flight Deck CPDLC Interface Hierarchy	131
Appendix B	Results for Selected CPDLC Procedures	134
Appendix C	Menu Page Links for the Interface Experiment (at MIT)	140
Appendix D	Communication Tasks in Experiment	143

LIST OF FIGURES

Figure 1-1 Air-Ground Radio Communication Paths	11
Figure 2-1 Layout of a Generic Glass-Cockpit Flight Deck	23
Figure 2-2 Schematic of the 777 Glareshield	24
Figure 2-3 Close-up of an MCDU	25
Figure 2-4 Flight Deck of the Boeing 747-400	27
Figure 2-5 ATC Message Alert on EICAS for MCDU-based System	29
Figure 2-6 Flight Deck of the Airbus 340	30
Figure 2-7 Schematic of a DCDU	31
Figure 2-8 Flight Deck of the Boeing 777	33
Figure 2-9 Visual Alert and Actual Message on the 777 EICAS	35
Figure 3-1 Comparison of Timing Results from an Earlier Study	46
Figure 3-2 Procedural Comparison - Displaying Uplinks	47
Figure 3-3 Procedural Comparison - Accepting a Simple Uplink	49
Figure 3-4 Processing Times - Responding to a Simple ATC Message	51
Figure 3-5 Procedural Comparison - Rejecting with Reason	54
Figure 3-6 Processing Times - Rejecting an Uplink with Free-Text Reason	56
Figure 3-7 Procedural Comparison - Speed Confirmation	57
Figure 3-8 Processing Times - Responding to Speed Confirmation Requests	60
Figure 3-9 Procedural Comparison - Position Reporting	62
Figure 3-10 Processing Times - Position Reporting	64
Figure 3-11 Procedural Comparison - Altitude Request	65
Figure 3-12 Processing Times - Altitude Request	67
Figure 3-13 Minimum Number of Button-Presses - Tasks Examined	68
Figure 3-14 Comparison of Total Duration for Communication Tasks	69
Figure 3-15 Minimum Number of Button-Presses for the Hypothetical Flight	72
Figure 3-16 Total Duration for the Communication Tasks on Hypothetical Flight	73
Figure 4-1 First Two CPDLC Interface Configurations in Experiment	80
Figure 4-2 Last Two CPDLC Interface Configurations in Experiment	81
Figure 4-3 Menu Hierarchy in Experiment	83
Figure 4-4 Idealized Response Sequence	87
Figure 5-1 Subject Familiarity with Computer Settings	94
Figure 5-2 Total Duration - Simple Acceptance Tasks	96
Figure 5-3 Response Accuracy - Simple Acceptance Tasks	97
Figure 5-4 Task Efficiency - Simple Acceptance Tasks	99
Figure 5-5 Total Duration - Questionable Commands	100
Figure 5-6 Response Accuracy - Questionable Commands	102
Figure 5-7 Task Efficiency - Questionable Commands	103

Figure 5-8 Total Duration - Flight Plan Cross-Checking Tasks	104
Figure 5-9 Response Accuracy - Flight Plan Cross-Checking Tasks	106
Figure 5-10 Task Efficiency - Flight Plan Cross-Checking Tasks	107
Figure 5-11 Total Duration - Pilot-Initiated Downlinks	108
Figure 5-12 Task Accuracy - Pilot-Initiated Downlinks	109
Figure 5-13 Task Efficiency - Pilot-Initiated Downlinks	110
Figure 5-14 Total Duration - Systems-Related Tasks	111
Figure 5-15 Task Accuracy - Systems-Related Tasks	112
Figure 5-16 Task Efficiency - Systems-Related Tasks	113
Figure 5-17 Mental versus Physical Subjective Workload	116
Figure 5-18 Mean Composite NASA-TLX Rating	117

LIST OF TABLES

Table 2-1	Application and Development Plans for CPDLC Interface Designs	21
Table 3-1	Comparison of Flight Deck CPDLC Interface Components	37
Table 3-2	Summary of Aural Alert Features	41
Table 3-3	Summary of Visual Alert and Message Access Features	42
Table 3-4	Number of Button-Presses - Responding to a Simple Uplink	50
Table 3-5	Number of Button-Presses - Rejecting an Uplink with "Low Fuel"	55
Table 3-6	Number of Button-Presses - Speed Confirmation	59
Table 3-7	Comparison of Button-Presses - Position Reporting	63
Table 3-8	Comparison of Button-Presses - Altitude Requests	66
Table 3-9	Communication Tasks in a Hypothetical Flight Scenario	72
Table 4-1	Number of Tasks by Category for Each Configuration	88
Table 5-1	Regression Estimates	114

1. INTRODUCTION

Recognizing the steady growth of civil aviation, the International Civil Aviation Organization (ICAO) Council in 1983 tasked a special committee with making recommendations for the future development of air navigation for civil aviation over the next few decades. In 1988, the Future Air Navigation System (FANS) Committee, in view of the propagation limitation and imminent saturation of existing communication channels, developed standards for a communication, navigation and surveillance (CNS) system that would reduce the reliance on land-based infrastructure (ICAO, 1988).

Through space-based CNS technologies, the implementation of the FANS architecture is expected to ultimately enable dynamic routing changes by aircraft in the air and reduced airborne aircraft separation standards to be conducted with little reliance on ground-based facilities (IATA, 1995). To take advantage of the full implementation of FANS, airplanes must be equipped for these functions (Allen, 1998):

- Airline operational control data link (with airline operations centers, AOC),
- Air traffic control (ATC) data link,
- Integration of global positioning systems (GPS),
- Automatic dependent surveillance (ADS),
- Capability to meet required navigational performance (RNP), and
- Capability to specify required time of arrival (RTA) at specific way-points.

Even prior to the full implementation of FANS, limited use of data link has proved to be extremely useful in two respects. First, it simplified the transmission and receipt of routine, complicated messages between the aircraft and AOC, and between the aircraft and ATC (e.g. detailed route-clearance messages). Second, its use of compressed, digitized data transmission rendered the use of satellite communication technologies cost-effective.

The cost-effective use of satellite technology circumvents the need for terrestrial-based facilities, and has been a remarkable improvement to the existing technology in oceanic airspace. While the availability of GPS satellites significantly enhanced navigation in oceanic regimes, or in areas devoid of land-based navigation aids, the problem of communication and surveillance had not been adequately solved until the development of satellite data link technology.

Traditional line-of-sight systems have a maximum range of about 370 km (Bailey and Phelan, 1992). When airplanes are out of this range from land-based systems, their only means of communication has until recently been the lower-bandwidth, high-frequency (HF) radios. HF waves reflect from the earth's ionosphere and can be used by pilots to make position reports to ATC, hence circumventing the communication and surveillance problem. However, as a consequence of the unpredictable nature of ionospheric reflection, pilots and air traffic controllers alike do not have prior control of which ground stations the aircraft can contact, and the connected controllers often need to transcribe the voice message and communicate it through terrestrial means to the ATC

facility responsible for the airspace the aircraft is in. This lengthens the overall time needed for communication by anywhere from 20 to 45 minutes. Figure 1-1 summarizes these mechanisms of communications for two aircraft in the airspace controlled by ATC-1, with one within the line-of-sight VHF range of ATC-1 and the other outside of this range.

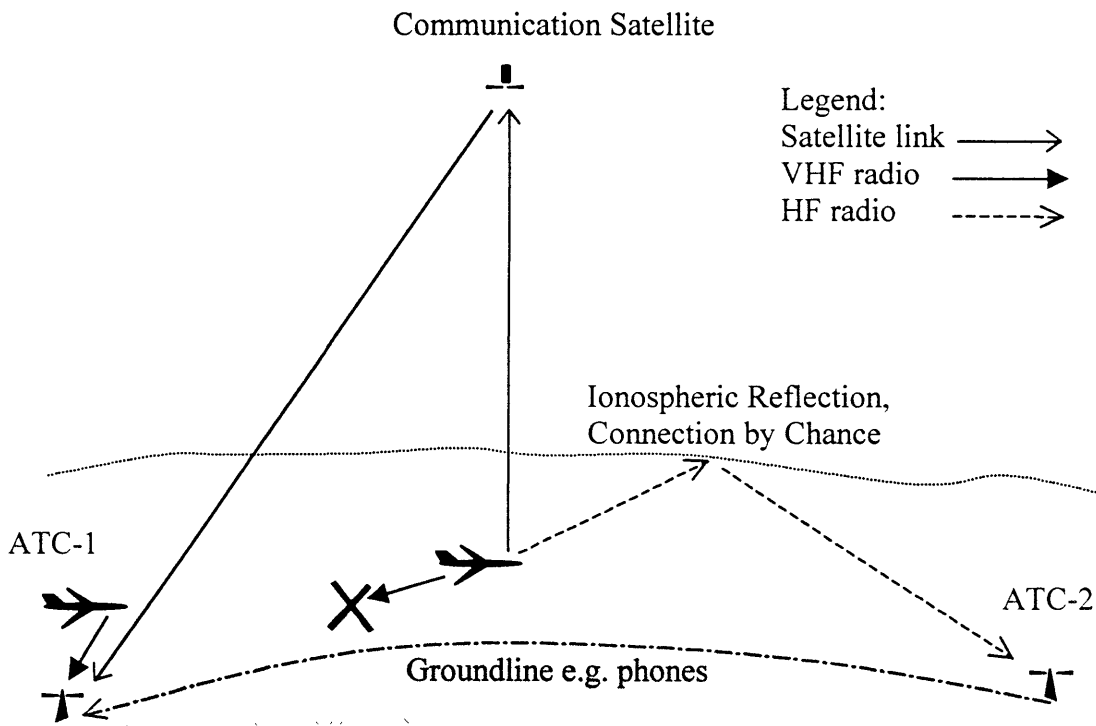

Figure 1-1 Air-Ground Radio Communication Paths

Notice in Figure 1-1 that when an airplane is within the normal communication range of an ATC facility (within line-of-sight of VHF waves), pilots can communicate directly with ATC. However, when it is out of the line-of-sight range of an ATC facility, the only other timely resort is the HF radio. In practice, whichever ATC facility receives

the message from the aircraft would have to look up the contact information and relay the message to the ATC facility responsible for the airspace the aircraft is in by terrestrial telecommunications.

As an illustration, the uncertainties of traditional voice position reporting and the delay associated with HF relayed voice communications in oceanic flight regimes necessitate a significant amount of space to be allowed between any two airplanes. In the Pacific Ocean, this separation is at least 100 nautical miles (n.m. or 185 km) laterally¹ and 120 n.m. (222 km) longitudinally, amounting to about 48,000 square miles (123,000 km²) of airspace to protect one airplane (Allen, 1998).

The existing Very-High-Frequency (VHF) radio channels can also be used for data link, but the satellite communication network circumvents the line-of-sight limitations to provide a global coverage for the transmission. In general, satellite communication can reduce the response time for an airplane to request a change in altitude to a few minutes, thus significantly reducing aircraft separation requirements. By allowing configuration of the data link transmission to automatically switch from VHF radio to satellite communication, this could provide seamless coverage.

With cost-effective satellite communication technologies, however, aircraft would not have to rely on the lengthy relay through HF when they are outside of the line-of-sight range of ATC facilities. Instead, pilots would be able to communicate directly with

¹ This can be compared with a corresponding separation requirement of 110 km for out-of-radar range in North Atlantic and 9 km in continental U.S. and most of Western Europe.

the ground facilities almost instantly, thus dramatically reducing the communication delay and the surveillance uncertainty involved (in oceanic regimes).

From here, it is clear why communications and surveillance concerns in the oceanic regime have been the driving force behind the development of data link technology. Indeed, the first position report sent by an aircraft via data link was performed by a United Airlines aircraft over the Pacific Ocean in 1991. As the data link technology matures, its benefits are recognized in other flight regimes as well. In particular, pilots voiced their preference of data link with an electronic interface over voice communication because of the quieter flight deck and perceived lower communication workload (Waller and Lohr, 1989).

Initial implementations of FANS involved the use of data link communication to replace routine voice communications between pilots and the airline operation centers (AOC). Similar uses between pilots and air traffic controllers (ATC) are slowly becoming more prevalent. The use of the electronic interface also allows lengthier messages to be communicated, such as revised flight plans and gate assignment information for connecting passengers.

For two-way controller-pilot data link communications (CPDLC), there are currently three main FANS flight deck interface equipage designs for the 747-400, the 777 and Airbus aircraft. Unfortunately, even with this development, there is a lack of coherent understanding on the fundamental trade-offs between performance and interface

designs. As noted in the Office of Inspector General report (1999), 10 human factors issues for controllers and pilots represent one of the biggest challenges facing the implementation of data link applications. In particular, the physical location, interface hardware and software designs affect the user-friendliness of an on-board data link interface system.

The primary objective of this thesis is to analyze the trade-off between performance and the flight deck interface design for controller-pilot data link communication (CPDLC). In Chapter 2, an overview of the status of data link technology is presented. This is followed by a discussion of key components in the flight decks of modern civil air transport, and then by an introduction to the three main flight deck CPDLC interface designs. In Chapter 3, the performance of interface systems is compared in terms of their crew alert mechanisms and procedural complexity. With limited access to Boeing's engineering simulators, the processing times of two interface systems for certain common data link functions were recorded and compared. These were then used to estimate the probable performance of the third interface system.

The performance of a particular interface design in turn depends on three main factors: the physical location of the interface components, the arrangement of the interface hardware, and the software design. To add to the fundamental understanding of how the design of the hardware affects the performance of a particular interface configuration, an experiment was conducted. The design of the experiment and a

description of previous related research are discussed in Chapter 4, and the results are presented in Chapter 5. Concluding remarks are presented in Chapter 6.

This page intentionally left blank.

2. DATA LINK AND FLIGHT DECK LAYOUT

Before exploring the details of human factors issues on the design of the flight deck CPDLC interface, it is important to put CPDLC in the larger perspective of data link and to understand the general layout of a modern glass-cockpit flight deck. The first section of this chapter provides an overview of air-ground data link, and is followed by an overview of key components of the flight deck design of modern civil airplanes. The last three sections of this chapter provide an introduction to the three main flight deck CPDLC interfaces currently under development.

2.1 Air-Ground Data Link

As air traffic is projected to grow steadily into the next millennium, and as the traditional air traffic control environment is moving toward a more liberal air traffic management concept, there is a growing need for air-ground information transfers (Hansman *et al*, 1997). Data link technology promises to meet this need while alleviating the problem of saturated voice radio channels and providing an increased capability of information transfer.

Air-ground data link applications have thus far been implemented through the use of an electronic interface instead of digitized/synthesized voice, but not without shortcomings. Apart from increased head-down time in "message preparation and

comprehension", Midkiff and Hansman (1992), and Pritchett and Hansman (1995) identified important information elements overheard from traditional (voice) radio channels that may be lost in a data link environment through an electronic interface. Communication irregularities with ATC both during flight and on the ground were among two of the top five areas where the pilot self-report program at a major U.S. carrier has received the most reports in recent months (Woodworth, 1999). Meanwhile, proponents of speech-based interfaces in the flight deck argue that speech technology can provide significant advantages in low to moderate levels of workload (Cresswell-Starr, 1993).

In spite of these findings, the use of an electronic interface for data link communication allows message elements to be encoded in a standard fashion, which in turn provides for better integration to the aircraft flight management computer (FMC). The use of electronic message displays also allow the messages to be read after pilots finish other more important tasks and at their own desired pace (Kerns, 1990). By the same token, errors in articulating and transcribing messages can be reduced by the use of an electronic interface (see Billings and Cheaney, 1981; Lozito *et al.*, 1993 and Adam *et al.*, 1994). An earlier study (Waller and Lohr, 1989) showed flight crew's preference for a quieter flight deck and the perceived lower communication workload. In view of the merits and shortcomings (Scanlon and Knox, 1991 and Waller, 1992), the introduction of an electronic interface for data link communication has largely been the preference by industry.

Currently, data link communication through an electronic interface is used predominantly between the aircraft and the airline operations centers (AOC) in both North America and abroad for the transmission of gate information, wind data and company route information. This is conducted using the Aircraft Communications Addressing and Reporting System (ACARS) management unit on the airplane (Corwin, 1991). Integration between the communication functions and the flight management computer (FMC) allows a complete routing (with way-points) to be sent from AOC to the airplane and then for the pilots to upload the information to the FMC. As well, messages of lesser importance to flight safety, including changes in the operating status of onward connecting flights, can be communicated via aircraft-AOC data link.

Similarly, data link communication is used on a more limited basis in the Pacific (Stahr, 1991) for the transmission of routine messages between pilots and air traffic controllers (ATC). The selection of the South Pacific as the initial trial site was a result of the oceanic flight regimes (with few communication alternatives) and the relatively few flight control authorities for high-level flights in that area. The number of carriers involved is also low (one each from Australia, New Zealand and the U.S.). Trials for dynamic air route planning (DARP) maneuvers using CPDLC in the region began in the summer of 1998. The ultimate aim of DARP is to allow aircraft to dynamically take advantage of the most fuel-efficient routing (both horizontal routing and vertical altitudes) based on the latest meteorological information. At this writing, the use of CPDLC in DARP on commercial flights is limited to properly equipped 747-400 aircraft. As of 1998, over 15 airlines from around the world have purchased 350 ship-sets of the

FANS upgrade for the 747-400 (Allen, 1998). With CPDLC under evaluation for use in Europe, China and the Russian Far East, it is clear that data link communication is definitely of growing importance (Fan *et al*, 1996; McKinlay, 1996; Shuvaev and Oishi, 1996).

In terms of developmental status, Boeing's FANS-1 equipage was certified on the 747-400 in 1995, on the 777 in 1996 and on the 757/767 in 1998. The FANS-1 package provides capability for two-way CPDLC, the use of global positioning satellites (GPS) for primary navigation and automatic dependent surveillance (ADS) capability. Meanwhile, the Airbus Interoperable Modular-Future Air Navigation System (AIM-FANS) is currently under development, with the version FANS-A catered for the existing infrastructure (Signargout, 1995). The status of development of the three main flight deck FANS-CPDLC designs is summarized in Table 2-1.

Apart from replacing routine voice communication, data link can also be used to transmit near real-time terminal weather information (TWIP) such as wind shear, microburst and storm cell locations to commercial pilots (Campbell and Martin, 1993). Likewise, graphical weather and traffic information can be transmitted to general aviation aircraft via data link (Chandra, 1997 and Lind *et al*, 1994). Meanwhile, the proposed future National Airspace System Architecture (FAA, 1998) calls for expansion of existing regular data link applications to include broader use of CPDLC, automatic dependent surveillance broadcasts (ADS-B) and aviation weather information (AWIN) systems.

Table 2-1 Application and Development Plans for CPDLC Interface Designs

Configuration	Aircraft Types	Certification Plans
MCDU	747-400	FANS-1: Certified in 95, currently in use
MCDU	757/767-200,-300	FANS-1: Certified in 98
MFD	777 (standard feature)	FANS-1: Certified in 96, limited use
MFD	767-400	FANS-1: To be determined
DCDU	A319/320/321	FANS-A: To be certified by 2000/2001
DCDU	A330/340	FANS-A: To be certified by 2000/2001

Over the past 15 years, the Federal Aviation Administration (FAA) has invested US\$420 million in various data link projects. As part of the proposed future National Airspace System architecture, the agency is requesting \$42 million for various data link efforts in the Fiscal Year 2000. With industry participation, the FAA also plans to implement data link communication at the Miami Air Route Traffic Control Center in June 2002, leading to a national deployment beginning a year later in June 2003 through 2015 at a cost of \$645.5 million (excluding equipment for airlines and aircraft) (Office of Inspector General, 1999). From these developments, it is clear that data link communication is coming to the fore in commercial aviation.

2.2 Layout of Modern Flight Decks

The aircraft types designed for or that will be retrofitted with CPDLC equipage belong to the so-called glass-cockpit aircraft. As distinct from older "steam-gauge"

airplanes, most if not all of the flight deck displays are in the form of color flat-panel electronic displays (hence the term "glass cockpit"). Altimeters, speed indicators and vertical speed indicators alike, which were once connected directly to sensors on the outside of the aircraft now have their data processed and even electronically cross-checked before being displaying the pilots.

A list of terms have been established to describe general spatial locations in modern flight decks. Figure 2-1 shows the generic layout of a glass-cockpit flight deck. While this figure was based on the Boeing 747-400 flight deck, it is worthwhile to note that it is very much representative of the flight deck layouts for the 737-600/700/800/900, 757, 767, 777, MD-11, MD-80, MD-90 and the Airbus A318, A319, A320, A321, A330, A340 aircraft. For smaller but relatively recently-designed cockpits of the Canadair Regional Jet CL-62's and CRJ-700, the Embraer Regional Jet EMB-145, and even the 60-seat Indonesian N-250 turboprop aircraft, the layouts are also very similar to Figure 2-1.

In all these aircraft flight decks, one or two centralized display of key airplane system status information and warnings are most likely located in the center forward panel. On Boeing airplanes, this system is called the Engine Indicating and Crew Alerting System (EICAS); on Airbus airplanes, this is termed the Engine Condition and Aircraft Monitor (ECAM). On each of the left and right forward panels are the electronic flight instrument systems (EFIS) showing a primary flight display (PFD) and a navigation display (ND). Pilots generally can control which display to use for the PFD or ND via the

EFIS control panel. As will be discussed in Chapter 3, new routes received from an ATC data link message can be uploaded to the FMC and displayed on the ND.

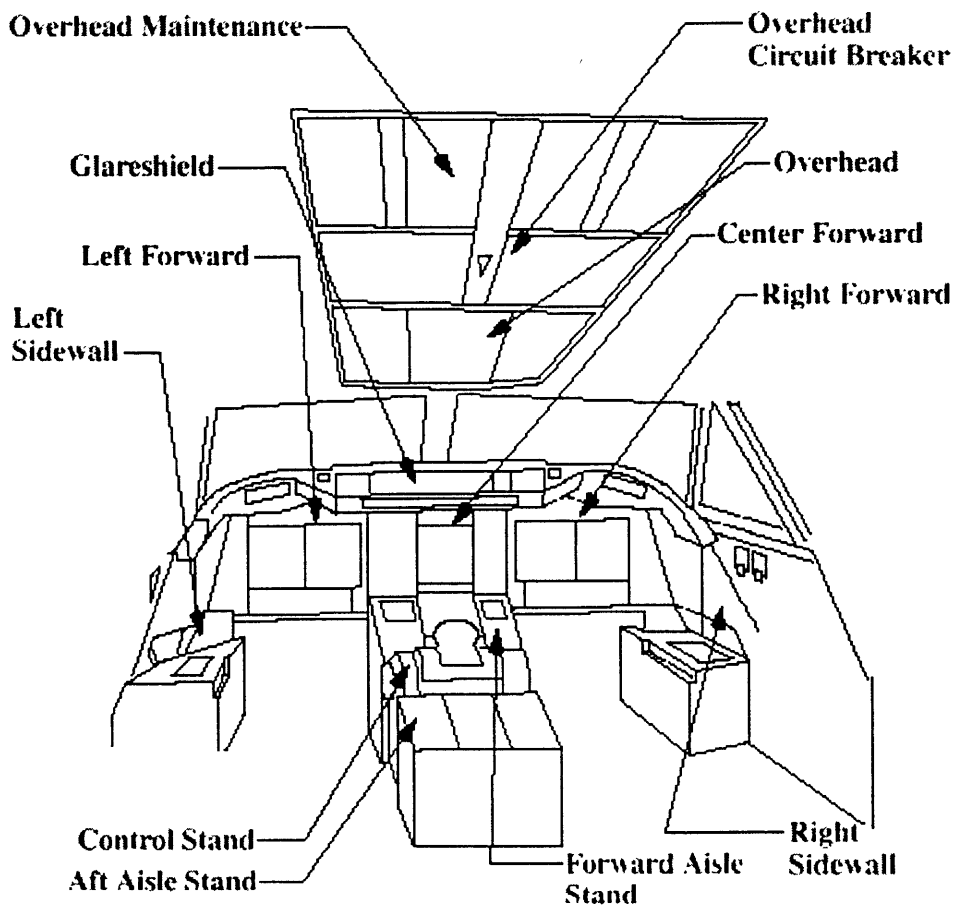

Figure 2-1 Layout of a Generic Glass-Cockpit Flight Deck
(Adapted from Boeing 747-400 flight deck operational illustrations)

Situated above the center forward panel and extended from just beneath the windshield is the glareshield. This is where the EFIS control panels (usually one on each

side) and the autopilot flight controls are located. On Boeing airplanes, these latter controls are located on the Mode Control Panel (MCP). On Airbus aircraft, this panel is referred to as the Flight Control Unit (FCU). The MCP or the FCU allows pilots to input the desired altitude, climb or sink rate, as well as heading or way-points. Upon activation, the aircraft will automatically fly according to the desired flight conditions. For the Boeing 747-400 and 777 at least, an additional Display Select Panel (DSP) is located beside the MCP for pilots to select the information shown in selected displays. Three quick-response buttons for data link communications located on both ends of the 777 glareshield will be discussed later in this chapter. A schematic for the glareshield on the 777 is shown in Figure 2-2.

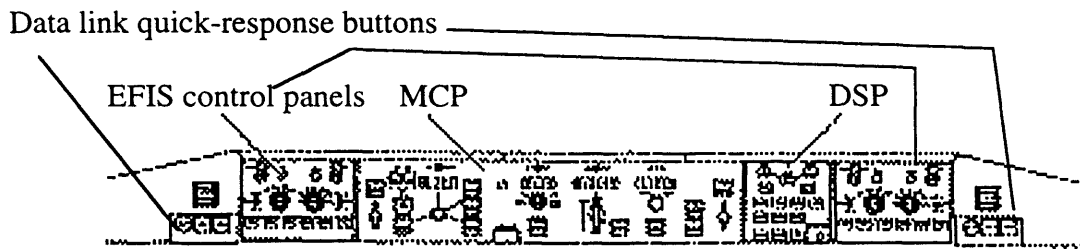

Figure 2-2 Schematic of the 777 Glareshield

Located beneath the center forward panel is the forward aisle stand, which in turn is in front of the control stand and the aft aisle stand. Together, these three stands are referred to as the pedestal on Airbus aircraft. Two MCDUs are situated on the forward aisle stand or the forward part of the pedestal for access to the flight management computer (FMC) or to datalink communications. Figure 2-3 shows a close-up schematic of an MCDU.

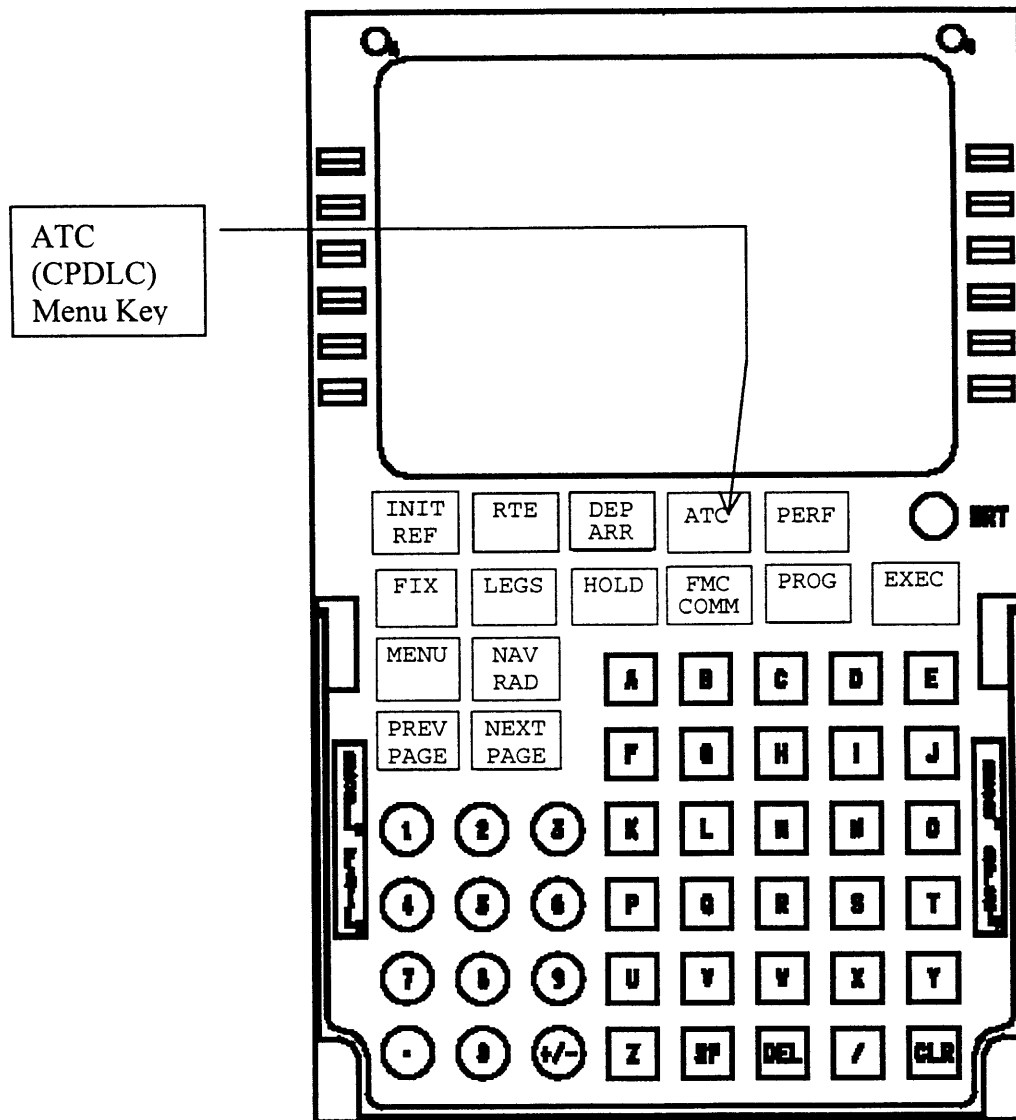

Figure 2-3 Close-up of an MCDU

(Adapted from Boeing 747-400 illustrations)

As shown in the figure, the top-half of a typical MCDU is a display screen, with line select keys (LSK) on both sides for menu selection or text entry. Pressing one of these menu keys normally leads to the respective menu (e.g. route page, leg page, ATC,

etc.). On the bottom-half are three groups of keys: menu keys on the top few lines, a numeric keypad on the left and an alphabetical keypad on the right.

Alpha-numeric characters that are pressed appear on the last line on the screen called the "scratch-pad". Upon pressing one of the appropriate LSKs (depending on the exact field of entry), the content of the scratch-pad will be transferred to the line corresponding to the LSK pressed.

On the 777, an MFD is located between these two MCDUs. When the "Comm" function is selected on the DSP, the communications menu will appear on the MFD (enabling communications with AOC and ATC). A touch-pad cursor control device (CCD) is located behind each of the two forward MCDUs on the 777. When the inboard hand of a pilot is rested on the CCD, the index or middle finger can be used to direct the cursor using a flat track-pad while the thumb naturally rests on a vertically-placed cursor button.

To transfer the scratch-pad content to the MFD (in appropriate modes), the pilot needs to first bring the cursor to the correct field on the MFD (using the index or middle finger) and then press the cursor control key (by the thumb). For certain electronic checklists or forms, the cursor on the MFD by default moves to the next field of entry upon the completion of the previous entry, thereby saving time and effort in moving the cursor to the desired location. Note also that when a pilot's hand is placed on the CCD, the fingers cannot reach the keys of the MCDU unless the entire hand is moved.

2.3 MCDU-Based Interface System Layout

The design based on the Multipurpose Control and Display Units (MCDU) was an attempt to retrofit² the CPDLC functions into existing cockpits of the 747-400, 757 and 767 (-200 and -300 series) aircraft. The flight deck data link interface therefore had to take into account of the space and equipment constraints of these existing flight decks. Figure 2-4 shows the flight deck of the 747-400, including annotations pointing out the MCDU-based ATC data link components.

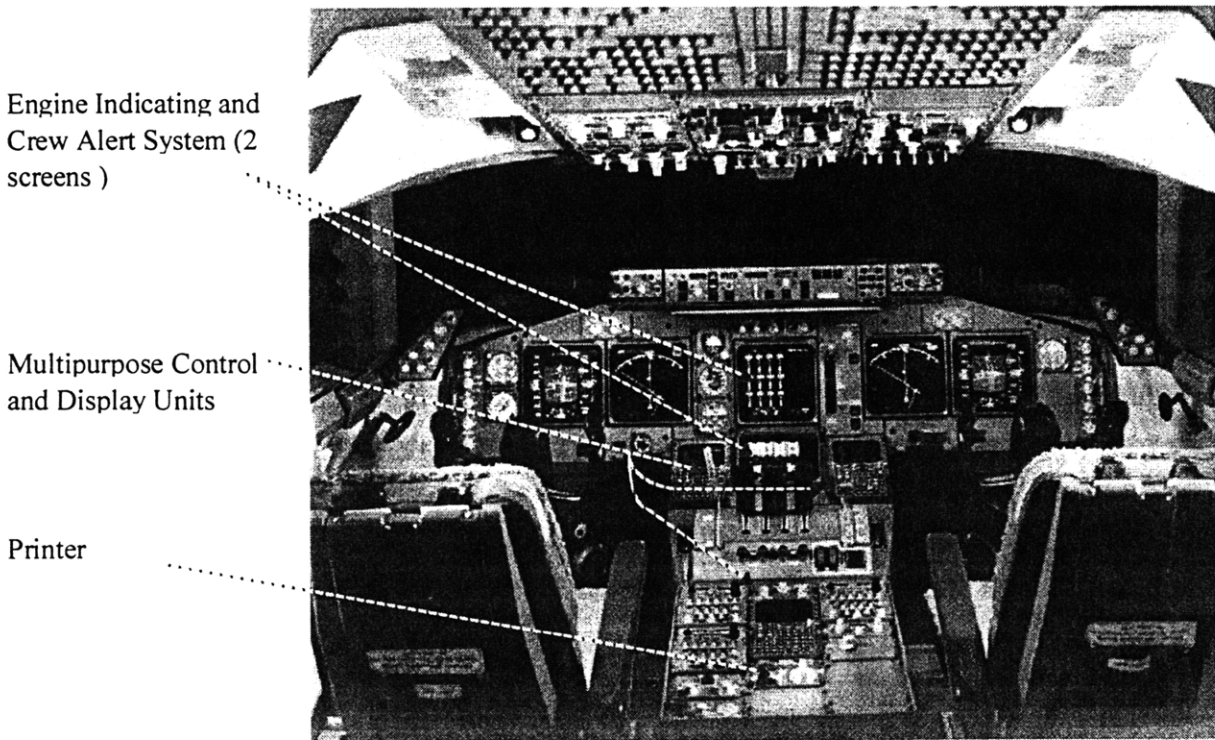

Figure 2-4 Flight Deck of the Boeing 747-400

(Photo courtesy of Boeing)

² In Infield *et al* (1994), the term retrofit data link was once used to refer to a set-up of data link functions on the rear MCDU that is not integrated with the flight management system (FMS). In this thesis, however, all data link configurations mentioned are intended to refer to the set-up that is integrated with the FMS.

As mentioned in the last section, the MCDU is where pilots can access the flight management computer (FMC). Calculations of take-off speeds and the programming of route information, for instance, are performed on the MCDU. The programmed route can be displayed on the Navigation Display (ND) in the forward panel and executed on the MCDU. The MCDU is also where the data link functions (for both ATC and AOC) are accessed, and is connected to a printer at the back of the aft aisle stand.

In the 747-400 flight deck, a total of three MCDU's are present, one by the side of each pilot seat on the forward aisle stand, and the third toward the back of the aft aisle stand. This third MCDU at the back is normally out-of-reach of the pilots when their seats are moved forward to the flying position, and was designed more as a back-up and for the convenience of maintenance personnel than for pilots' use in flight. Logsdon *et al* (1995) found that significantly longer processing times would be required if the ATC data link functions were implemented on the aft MCDU.

The two screens of the Engine Indicating and Crew Alert System (EICAS), situated in the center of the forward instrument panel and the forward aisle stand, together form a centralized system alert display. In the upper EICAS screen, visual alerts of incoming ATC messages are shown (a separate chime is issued at the same time). The visual alert on the EICAS, as shown in Figure 2-5, ensures that the data link alert is integrated with other warnings from the airplane systems. The visual alert will remain displayed until all new ATC messages have been "opened" (displayed).

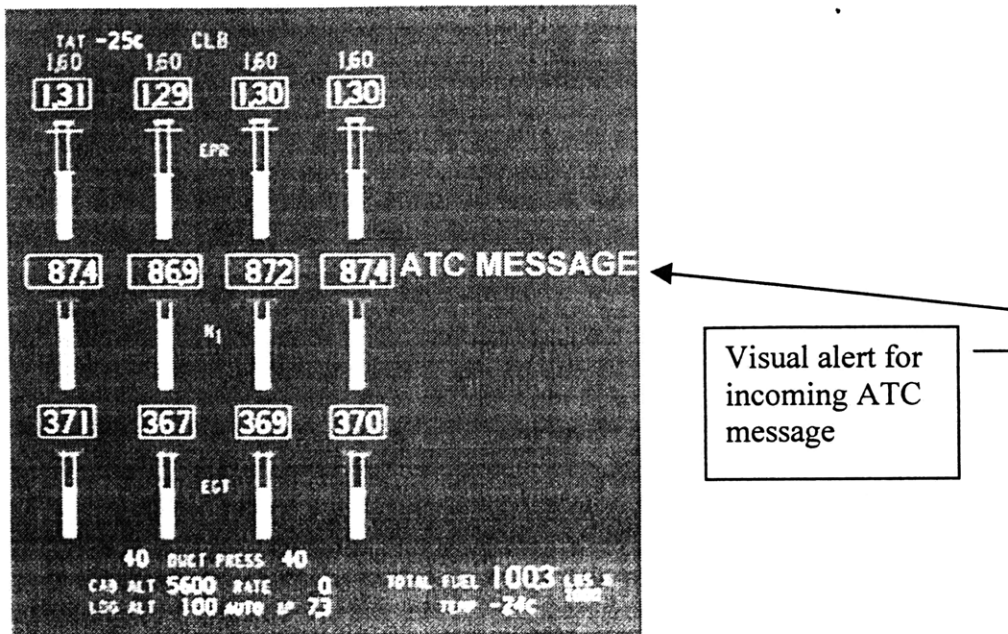

Figure 2-5 ATC Message Alert on EICAS for MCDU-based System

(Modified from Boeing illustrations)

When a new message arrives from ATC, the MCDU-based system uses a single chime to draw the pilots' attention. Moreover, the alert is activated only when there is no other ATC message being responded to (if there is, no aural alert is activated). In the event of an incoming ATC message, pressing the ATC menu key activates the display of the content of this message. In the absence of an incoming message, or when the data link connection is off, pressing this ATC menu key would lead to the ATC menu.

In the MCDU-based interface (and for the MFD-interface as well), the "accept" button is used in place of the verbal "will comply (wilco)", "roger" or "affirm" responses, while the "reject" button is used in place of the verbal "unable" or "negative" response. Should more complicated responses be needed, however, the MFD must be called upon.

2.4 DCDU-Based Interface System Layout

Like the MCDU-based system, the DCDU-based interface system was designed to be retrofitted, but in this case, for Airbus aircraft. However, the fact that there appears to be significant "maneuverable" space for avionic equipment in the Airbus cockpit allows more flexibility in the design of the DCDU-based interface than in the MCDU-based interface. Figure 2-3 shows the layout of an Airbus 340 flight deck.

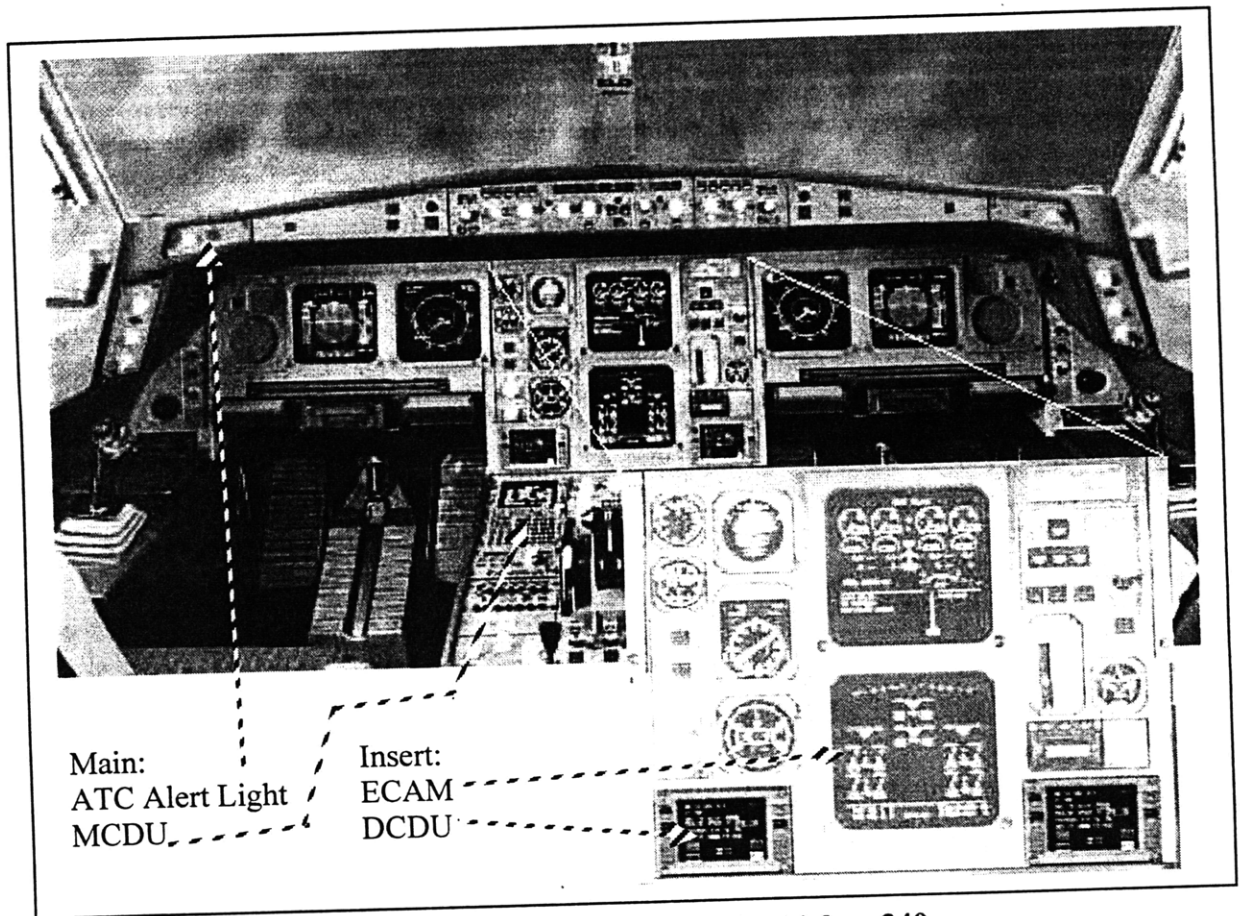

Figure 2-6 Flight Deck of the Airbus 340

(Courtesy of Airbus Industrie)

The same CPDLC interface layout is also used in the A330 and a similar one in the A318/319/320/321 aircraft types. Instead of the EICAS on the 747-400, located in the

center forward panel are two displays of the Engine Condition and Aircraft Monitoring (ECAM) system (Airbus' equivalent of EICAS). The DCDU (referred to as either the Datalink Control and Display Unit or the Data Communication Display Unit), a hallmark of the DCDU based interface system, is dedicated for pilot-ATC data link communications. Each of the two DCDUs is located in the bottom of the central forward panel, immediately above the MCDUs on the aisle stand. The content displayed on the DCDU should be legible for a pilot seated in an up-right position, but the pressing of command buttons on the DCDU requires that pilots bend slightly forward. As illustrated in Figure 2-7, the DCDU is dedicated for the data link communication between the flight deck and air traffic control.

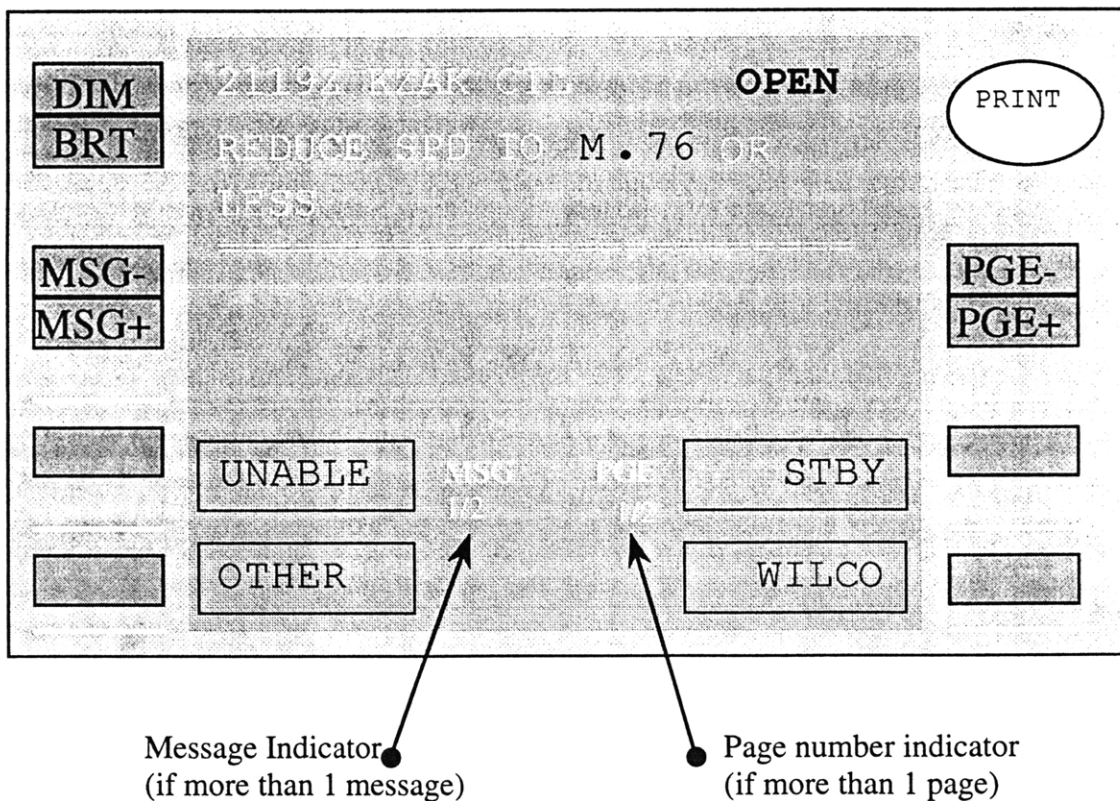

Figure 2-7 Schematic of a DCDU

All incoming messages are first displayed in the DCDU automatically. The DCDU is also the last place where an outgoing message is displayed just prior to being sent. Note that apart from four LSKs on the bottom of the screen, in addition to the default page and message commands, there is no keypad attached to the DCDU. Should manual entries be used, pilots need to rely on the keypad on the MCDU.

As in the 747-400 flight deck, there are three MCDUs in the A340 cockpit: one by each of the pilot seats and a third at the back of the aft aisle stand. Similarly, the printer is located adjacent to the third MCDU (primarily for maintenance) at the back.

Unlike the MCDU-based design, however, the visual alert for a new ATC message is not integrated with the ECAM. Instead, two dedicated ATC-message light-integrated push-buttons, one on each extreme end of the glareshield, flash on the arrival of a new message from ATC. The flashing will stop by either pressing the light-integrated push-button or by responding to the new message. In the event that a new ATC message arrives when the pilot is responding to another, the light-integrated push-button will again start flashing. The pressing of this light-integrated button, however, requires a change of both a pilot's posture and the visual field of view (involves neck-turning).

For the DCDU-based system, the aural alerts differ slightly on the level of urgency of the incoming message. In this system, an ATC message is recognized as either "urgent" or "normal" in priority. An urgent message elicits a repetitive sound once every five seconds, while a normal message elicits a repetitive sound once every fifteen

seconds, with the first sound delayed by fifteen seconds. Both alerts halt when the message is responded to, or when the light-integrated push-button is pressed.

2.3 MFD-Based Interface System Layout

In terms of the overall design philosophy of the flight deck ATC data link interface design, the MFD-based design used on the 777 represents a hybrid of the MCDU-based and the DCDU-based design. Figure 2-8 shows how the interface components are physically arranged in the 777 flight deck.

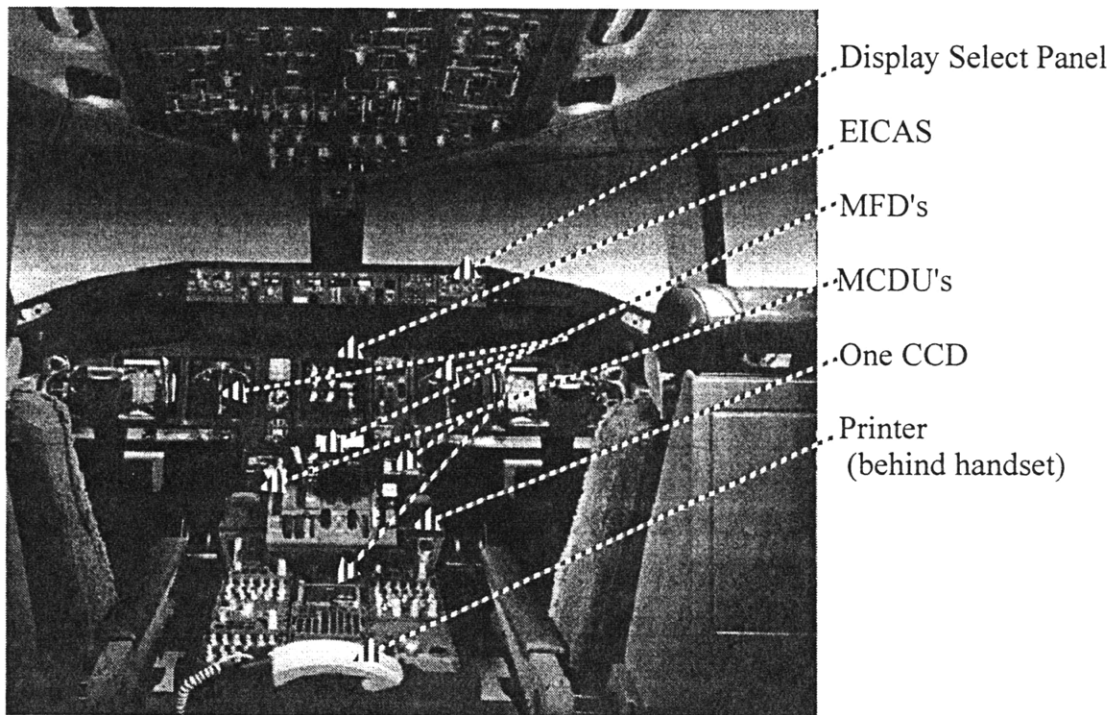

Figure 2-8 Flight Deck of the Boeing 777
(Photo courtesy of Boeing)

Similar to the Boeing 747-400 flight deck examined earlier, the central forward panel is the EICAS, the location of all airplane- and flight-related warnings. As an innovation from the 747-400 flight deck, on both sides on the forward panel and immediately below (on the forward aisle stand) the EICAS are three Multifunction Displays (MFD) whose displayed contents can be changed by pressing the appropriate display key on the Display Select Panel (DSP) on the far right of the glareshield. Under normal circumstances, the two panels flanking the right and left side of EICAS are used as Navigation Displays (ND), while the central MFD can be used to display the electronic check-list and communication menu. While the central MFD is located immediately in front of the throttle control, its content is clearly readable for a pilot seated in the up-right position.

A unique feature for the MFD-based CPDLC interface is a set of quick-response buttons on each of the two ends of the Electronic Flight Instrument System (EFIS) Control Panel adjacent to the autopilot Mode Control Panel (MCP) on the glareshield. Three command options, Accept, Standby and Reject, provide an avenue for pilots to expeditiously respond to ATC messages without having to navigate through the ATC communications menu. Pilots generally do have to lean forward from the seated position to activate these buttons. Figure 2-2 earlier in this chapter showed how these quick-response buttons, the EFIS Control Panel, the DSP and the MCP are arranged on the glareshield. The functions of the "accept" and "reject" command options are the same as in the MCDU-based system. Should more complicated responses be needed, however, the MFD must be called upon.

The alert for a new ATC message ("ATC") is also displayed on the EICAS immediately upon the receipt of a message from ATC, as is the actual content of the message if it is short. This is illustrated in Figure 2-9, showing a dedicated ATC communications box in the lower-left corner of the EICAS. At the same time, the arrival of a new ATC message (if not interrupting the response of another one) is accompanied with an up-down chime.

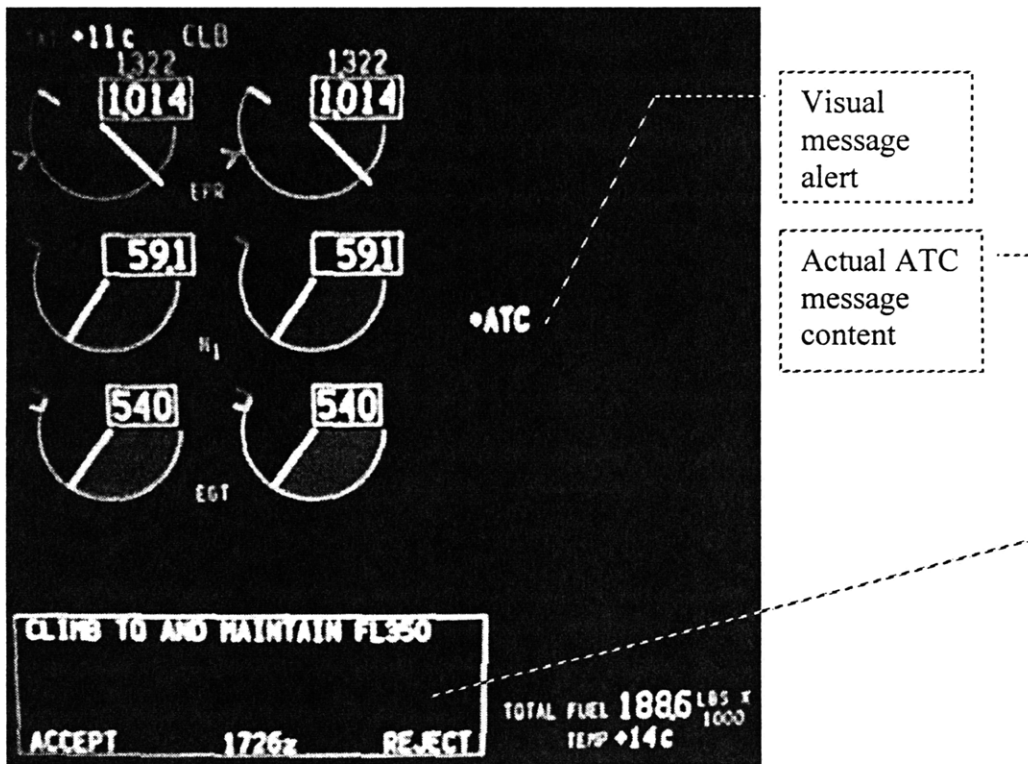

Figure 2-9 Visual Alert and Actual Message on the 777 EICAS
 (Photo courtesy of Boeing)

If the message cannot be displayed in its entirety in the dedicated ATC communication box, it can be viewed on the MFD by selecting the communication

function on the DSP. Even for shorter messages that are displayed immediately on the EICAS, the content can also be accessed via the MFDs by activating the DSP.

These few sections have so far described the physical layout of the three flight deck CPDLC interface designs. These form the basis of discussion on procedural comparisons in the ensuing chapter.

On a miscellaneous note, there is in fact some controversy on the optimal location of the flight deck CPDLC interfaces. Rehmann and Mogford (1996) reported statistically insignificant difference in the amount of processing time needed between the forward-mounted and aft-mounted data link display, while Logsdon *et al* (1995) reported significant difference in clearance viewing or response between the two displays. In this thesis, however, the primary concern is on the space and performance trade-offs in separating communication tasks using different interfaces, and is less concerned with the actual physical location of the interfaces.

3. COMPARISON OF FLIGHT DECK CPDLC INTERFACES

In Chapter 2, the basic operations of three flight deck CPDLC interface systems were discussed. In this chapter, the operational details of these systems are discussed in greater detail and in a comparative fashion. Brief discussions on the merits and shortcomings of each of these designs are also included in this chapter. In particular, the discussion starts from the crew alert mechanisms of these interface designs, then moves to the procedural complexity and processing times of selected communication tasks. As a reminder, Table 3-1 lists the hardware components of these interface designs.

Table 3-1 Comparison of Flight Deck CPDLC Interface Components

Components	CPDLC Interface Configurations		
	MCDU	DCDU	MFD
EICAS	√		√
MCDU	√	√	√
DCDU		√	
MFD			√
CCD			√
Glare-shield Alert Buttons		√	
Glare-shield Response Buttons			√
Printer	√	√	√

√ - Part of the flight deck CPDLC interface

Information on the interface systems was based heavily on customer airline briefings presented by Boeing Commercial Airplanes (1998) and on promotional literature prepared by Airbus Industrie (Potocki and Dambrine, 1995; Airbus, 1998). The information from the former, in particular, can also be found in the airplane operating manuals for the air carriers operating FANS-equipped airplanes. The publicly available information on the DCDU-based interface is less detailed than for the MCDU-based and the MFD-based designs. Certain assumptions on the similarities between the MCDUs used in the MCDU-based system and those used in the DCDU-based system must be made to obtain a comparable performance estimates of the latter. As well, details of certain parts of the menu hierarchy of the DCDU-based system are simply not accessible by the author and a reasonable, hierarchical structure has to be assumed. In spite of these issues, the discussion presented herein should be representative of what could be expected of the DCDU-based system at this writing.

3.1 Crew Alert Mechanism

The effectiveness of a data link communication system to draw the attention of pilots upon a receipt of a new message from ATC is an important issue. On one hand, the crew alerts must be capable of diverting the pilots' attention from other less important tasks (e.g. attending to visitors in the flight deck). On the other hand, the alerts must not distract pilots from a task with a higher priority (e.g. responding to failures of critical airplane systems).

Unfortunately, details on the design of the DCDU system are relatively preliminary, and access to physical mock-ups of only the MCDU-based and the MFD-based systems was available. The relative effectiveness in the crew alert mechanisms of all three designs could therefore not be tested experimentally. Nevertheless, the ensuing discussion highlights the merits and shortcomings in each of the alert schemes, based on reasonable assumptions of how the DCDU system would operate.

3.1.1 Aural Alerts

In line with the other flight deck alerts, the arrival of an incoming message from ATC is accompanied by both an aural and a visual alert in all three designs. In aural alerts, the MCDU-based system uses a single chime to indicate the arrival of a new ATC message while the MFD-based system adopts a "bing-bong" chime for the same purpose. There is no distinction with regards to different urgencies of the message, probably with the reasoning that CPDLC is designed for normal, routine communications (urgent, emergency messages should still be conveyed by voice).

Moreover, the alert is activated only when there is no ATC message being responded to (if there is, no aural alert is activated). The effect of this is to draw pilots' attention from another task but to suppress the alert once the attention is caught. In terms of providing an effective alert but minimal disturbance, then, this aural alerting scheme appears to be adequate.

A drawback, however, is that pilots have no direct means of recognizing that there is more than one message pending response if a second message arrives when the pilots are responding to the first one. The need for sending more than one message at a time arises from the fact that different message elements can be sent in separate messages. This reduces message ambiguity in the event that pilots plan to accept some but not all elements in a large message. However, in the event that ATC delivers an incorrect message to the aircraft, the controllers may want to send a second, correct message right away. If this second message arrives when the first one is being responded to (referred to as "concurrent messages"), the pilots would initially not be aware of its arrival. The pilots may already have initiated a course of action pursuant to the former command by the time they attend to the second message. A simple remedy would be to activate the aural alert or to refresh the visual alert whenever a new message is received.

In terms of initially drawing pilots' attention from another task, the efficacy of the aural alerts in the DCDU-based system should be comparable with the MCDU- and MFD-based systems. However, the muting of the first sound of aural alert for normal ATC messages may add to the overall delay in response to the arrival of the message. Once the pilots' attention is engaged in ATC communication, however, the repetitive sound may present a source of overstimulation. In the event of concurrent messages, the response is similar to the MCDU- and MFD-based systems: no additional aural alert is provided. (There is, however, an additional visual alert in the DCDU-based system for concurrent messages, as discussed in the next section.) If the aural alert has not been stopped by pressing the acknowledgement push-button, it is not unreasonable that some

confusion could be generated by the repetitive sound of this alert as to whether this is activated by a new message.

Table 3-2 lists various features of the aural alerts of the MCDU-based, DCDU-based and the MFD-based flight deck CPDLC interfaces. Note that while all of these designs involve aural alerts, the manner in which such alert is activated in the DCDU-based system is more complicated than in the other two designs.

Table 3-2 Summary of Aural Alert Features

Feature	Interface Systems		
	MCDU	DCDU	MFD
Message Type	All	Urgent Normal	All
Immediate Sound at new message	√	√	√
Repeating sound		√ √	
Sound for concurrent message			

√ - A feature of that interface system

3.1.2 Visual Alerts

Once the pilots' attention is obtained with the aural alert, there should be a visual notice providing key information on the nature of this alert. Alternatively, a visual note should advise pilots of the incoming message when they perform the usual scan across the instrument panel and glare-shield. In all three interface systems studied, certain visual

alerts are used, yet, as shown in Table 3-3, they differ in the manner in which they are displayed.

Table 3-3 Summary of Visual Alert and Message Access Features

Features	CPDLC Interface Systems		
	MCDU	DCDU	MFD
• Short alert message in center of forward panel	√		√
• Flashing light		√	
• Message displayed immediately		√	√*
• Message displayed with 1 button press	√		√**

√ - A feature of that interface system

*Only if the entire message can be displayed on the dedicated space on EICAS

**Whether or not the message can be displayed in its entirety on the EICAS

In both the MCDU-based and the MFD-based systems, the visual alerts for new ATC messages are integrated in the "centralized warning display" of the EICAS. This reinforces the alert recognition system that pilots are already familiar with: upon hearing an aural alert (whether it relates to CPDLC or not), they should look toward the central display panels for information. Figures 2-5 and 2-9 respectively show how the visual alerts are displayed in the MCDU-based and the MFD-based system.

In the DCDU-based system, however, there is no alert message in the centralized ECAM. Instead, the light-integrated ATC alert buttons on both ends of the glare-shield flash on the arrival of an ATC message. While the purpose of the visual alert is served,

this requires a different response strategy for CPDLC-related or other alerts. Upon hearing an aural alert that is associated with the flight or airplane conditions, pilots need to focus on the central panels for information. But if the aural alert is associated with the flashing glare-shield buttons, then the alert is related to CPDLC and pilots need to focus instead on the DCDU for information. This may necessitate an increase in the mental workload of pilots upon hearing aural alerts in general (especially those which resemble the CPDLC alerts), since the pilots need to discern the nature of the alert before deciding where to focus. The presence of the flashing alert would certainly alleviate this concern by catching the pilots' attention first, but the exact trade-off remains to be investigated.

In terms of access to an incoming ATC message, both the MFD-based and the DCDU-based systems provide immediate display of the content of the message in the EICAS and the DCDU respectively. In the former, pilots need to use the MFD if more elaborate responses (e.g. responding with a reason, integrating with FMC, etc.) are called for, or if the entire message cannot be displayed on the EICAS. When the MFD is set up in communication mode, only one button - the "comm" button on the DSP - needs to be pressed and then the ATC message content is then automatically displayed.

3.2 Interface Performance

As an objective comparison of the MCDU, DCDU and MFD-based flight deck CPDLC interface, the performance of these interfaces in accomplishing a set of common communication tasks was studied. In particular, five representative scenarios of applications are discussed in detail in this section. These are: responding to a simple ATC message, rejecting a message with reason, confirming speed (and assigned speed), sending a position report, and requesting altitude change. Further, three more tasks were examined and are briefly noted: logging-on to CPDLC, requesting a route change, and loading information from an ATC message to the FMC.

In comparing the performance of each interface, two methods were used. The first was to assess the procedural complexity of using each of these interfaces for certain communication functions. Here, two indicators of procedural complexity were used: the number of buttons pressed for each task, and the number of electronic pages viewed for each selected task. For reference, a partial list of the menu hierarchy for the three CPDLC interface systems is shown in Appendix A.

Apart from the assumptions on the design and operations of the DCDU-based interface system, there are some additional assumptions on the comparison of procedural complexity. First, all MCDU's were assumed not to be displaying CPDLC pages at the start of a data link scenario. Second, for the MCDU and DCDU systems, ATC messages could fit in one screen on the MCDU or DCDU respectively. Third, for the MFD-based

system, the MFD was not in communication mode (so that pilots needed to first click on the "comm" button on the DSP to put the MFD in communication mode). Fourth, the CCD of the communicating (non-flying) pilot could be readily used for data entry and selection with the MFD.

The second performance indicator was a measure of how long these tasks took to perform (at a minimum) when different interfaces were used. To accomplish this objective, two members of the FANS group at Boeing's Flight Deck Engineering were asked to perform a set of communication tasks using the MCDU-based and MFD-based CPDLC interface at the Company's Engineering Simulators in Seattle, WA, in 1999.

During this study, the times at which buttons were pressed for only the MCDU-based and the MFD-based systems were recorded. As a consequence of the inaccessibility to the DCDU-based system simulator, a reasonable estimate of the performance of the DCDU-based system was made based on the number and kind of buttons pressed.

The size and the extent of testing were primarily limited by the constraints on the availability of the engineering simulator facility. In total, 3 subjects from the Flight Deck Engineering group at Boeing, who were familiar with CPDLC functions, were solicited to participate in the study. In spite of these constraints, the result in fact was in line with earlier records from pilots' performance. Figure 3-1 compares the performance between a previous study (involving more subjects) and this study. Two tasks are compared: the

average time required to respond to an altitude assignment message from ATC using the MCDU-based system, and a simple ATC message using the EICAS and glareshield buttons on the MFD-based system (Boeing, 1996). In the earlier study, a total of 109 observations were made for the MCDU-based study, and 206 observations for the MFD-based study.

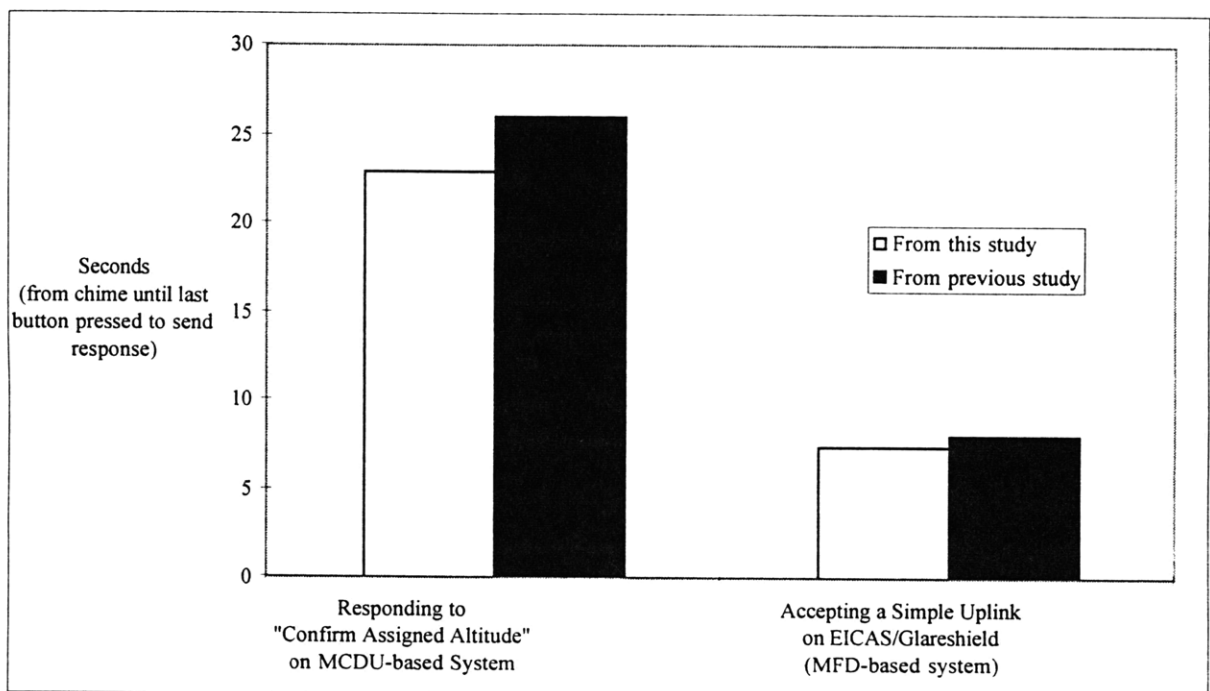

Figure 3-1 Comparison of Timing Results from an Earlier Study

Unfortunately, only the total times for the two specific tasks were recorded in the earlier study and the results were therefore not useful in deducing the time requirements of the DCDU system. As shown in the figure, the mean results from these two studies were within 15% each other, which was acceptable given the small sample size and the

familiarity of interfaces among the participants of the later study. During each scenario, the study participants were asked to verbalize the entire process, including the recognition of that the aural alert was an ATC message alert, and the reading of the actual message content. The ensuing discussion starts with ATC-initiated communication, and then moves to pilot-initiated downlinks.

3.2.1 Responding to a Simple ATC Message

As mentioned in Chapter 2, the arrival of a new message from ATC is ordinarily accompanied by both visual and aural alerts in the three interface systems. Once the source of the alerts (arrival of an ATC message) is identified, pilots can then direct their attention to the content of the message. As a comparison, Figure 3-2 shows how a simple incoming message can be accessed in the three CPDLC interfaces.

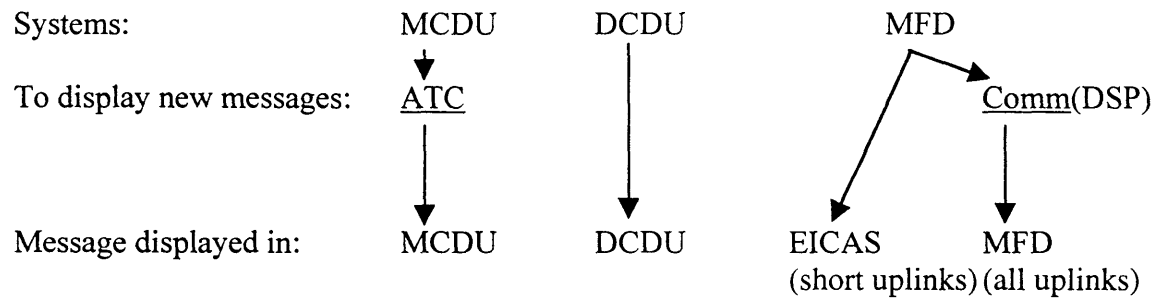

Figure 3-2 Procedural Comparison - Displaying Uplinks

As shown on the left in Figure 3-2, in the MCDU-based system, pressing the ATC menu key (underlined) on the MCDU displays the content of the new message on the

MCDU.³ For the DCDU-based system, the content of the message is automatically displayed on the DCDU (hence no underlined items). For the MFD-based system, if the entire message can be displayed in a dedicated ATC communication area, the message content is displayed on the EICAS automatically. In all cases, the message content can be viewed using the MFD, which is achieved by switching the DSP to the "comm" mode (by pressing the "comm" button). The message content is then displayed on the refreshed MFD screen.

Once a new ATC message is displayed, in general, the communicating pilot should read the entire message to the flying pilot, who decides together with the communicating pilot on what action to take. After a decision has been made on the response to ATC, the communicating pilot then sends the response and the appropriate pilot enters the information to the airplane systems, if necessary. Figure 3-3 compares this process in the three interface systems, assuming that the uplink is displayed on the MCDU, DCDU, MFD or EICAS respectively. For instance, in the DCDU system, pilots need to press the "Wilco" button, and then the "Send" command on the next electronic page in order to send the reply message.

For most simple ATC messages, the expected responses from the pilots include "wilco (for will comply)", "affirm", "roger", "unable", and "negative". In both the MCDU- and the MFD-system, two general replies, "accept" and "reject", are used to represent one of these five expected responses ("accept" represents the first three, and

³ For pre-departure route clearances, however, the details of the route (e.g. way-points) are shown only on a paper print-out, since the small size of the MCDU screen is difficult to fit all the routing details legibly.

"reject" the last two, depending on the nature of the uplink). In the DCDU-system, the exact responses (e.g. wilco) are shown. As well, a "standby" in all three interfaces allow pilots to acknowledge the receipt of the ATC message but delay the reply. However, the standby response alone does not constitute a satisfactory reply to the message, and all ATC messages on standby status eventually need to be replied to with one of the five expected responses listed above.

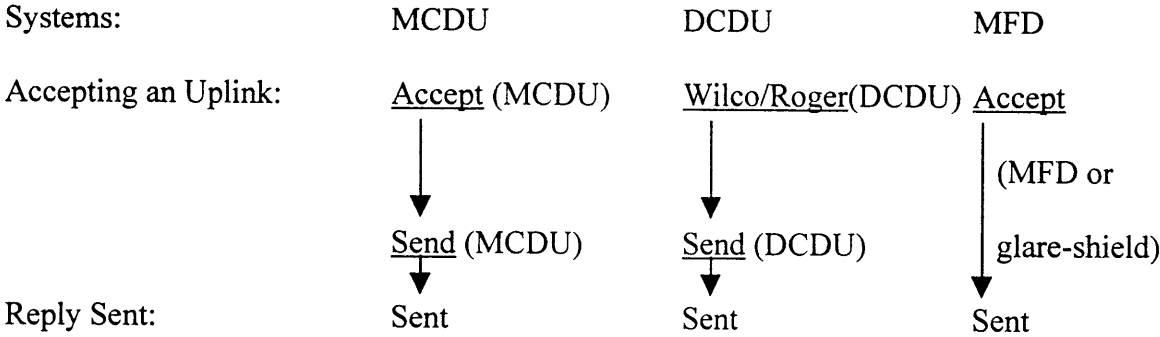

Underlined items need to be selected or entered by the pilots

Figure 3-3 Procedural Comparison - Accepting a Simple Uplink

To respond to a message once it is displayed, pilots simply need to press the appropriate command buttons (e.g. "accept"). In both the MCDU and the DCDU-systems, pilots need to authorize the transmission of the response by pressing a "send" button after choosing the response. This provides an opportunity for the pilots to change their minds, or to modify their responses with additional inputs. For routine messages, this can also create frustration in the added step or confusion as to whether or not the response has been sent. In the MFD-based system, one click on the "accept" or "reject" button, on either the glare-shield or the MFD, is sufficient to send the response to ATC.

For the entire process from the moment when a simple ATC message arrives to the point when the simple "accept" or "wilco" response is sent (last button pressed), the minimum number of button-presses required is tabulated in Table 3-4.

Table 3-4 Number of Button-Presses - Responding to a Simple Uplink

Systems	MCDU	DCDU (est.)	MFD (EICAS)	MFD (MFD)
Menu Buttons (on MCDU or DSP)	1	0	0	1 (DSP)
Glare-shield reply buttons	0	0	1	0
Line-select/cursor-control	2	2	0	1
Number of all keys pressed	3	2	1	2
Number of pages of displays	2	2	1	1

Note that for the MFD-based system, two ways of responding to this uplink are documented. The shortest way is to read out the message from the EICAS and to respond using the glare-shield quick-response buttons. The other way entails the display of the message in the MFD (starting from selecting the "comm" mode in the DSP) and then replying on the MFD. While the latter way is more circuitous, it offers more response options than the first one, and allows pilots to append reasons to their responses. When applicable, more complicated response options are also displayed on the MFD but not on EICAS/glare-shield.

Figure 3-13 compares the total duration required for the process of responding to a simple ATC message, from the sound of the chime to pressing the last "accept" or "send" button. These time periods were measured from human-in-the-loop study for the MCDU-based and MFD-based systems. The estimates for the DCDU-based system are based on the average time of button-presses in the above systems.

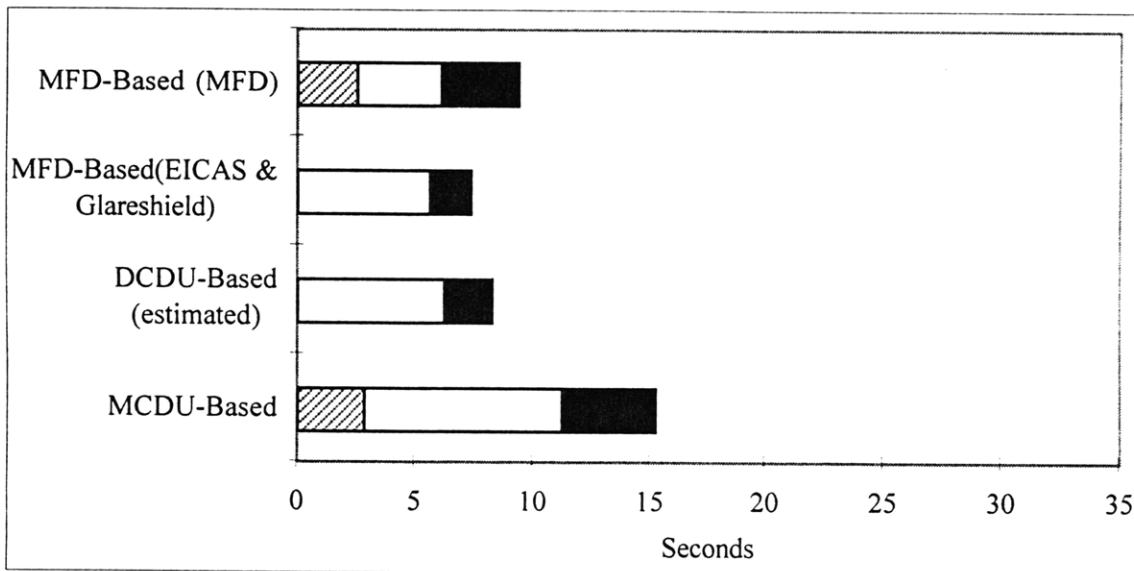



 Access to right page (till pressing of last button to display the message)
 Reading message and verbalizing course of action
 Responding to the message

Figure 3-4 Processing Times - Responding to a Simple ATC Message

Note that the time required to access the content of the ATC message using both the MFD and the MCDU is about the same. However, the time needed to read the content of the message was significantly shorter for using the EICAS in the MFD-based system than with the MCDU-based system. This is most likely as result of its larger screen and sharper font size of the MFD. The difference between using the DCDU set-up and the

EICAS and glare-shield of the MFD-based system was not statistically significant ($p > 0.05$).

In general, the significantly shorter time requirements of the DCDU-system and of using the EICAS of the MFD-system for short messages are directly attributable to the use of dedicated display space for ATC messages. More importantly, having a dedicated space for ATC messages allows the messages to be displayed while the pilots search for the appropriate information needed for the response. For the MCDU-based system, if pilots need to have access to specific information on the FMC (e.g. future way-points), they would need to temporarily exit the CPDLC function on the MCDU, proceed to the FMC to obtain the information and then come back to complete the CPDLC task. The same is true if the ATC message is too long to be displayed on the EICAS and needs to be displayed on the MFD. In these cases, pilots would not be able to simultaneously have access to information that also requires the MFD for displays (e.g. data link records with AOC).

While this shortcoming may not be important in the current operating environments where simple data link messages are sent, this may be important in an operating environment where aircraft intent and position information is broadcast not just to ATC centers but also to other aircraft in the neighbourhood. This issue will be explored later in Chapters 4 and 5.

3.2.2 Rejecting an ATC Message with Reason

In the previous section, the communication task involved giving a simple answer (e.g. "accept" or "reject") in response to a simple ATC message. Sometimes, however, pilots may not be able to comply with the ATC command because of weather, aircraft performance limitations, or special flight conditions.

In both the MCDU-based and MFD-based systems, "due to performance limitations" and "due to weather" were two standard reasons that can be selected with a single button. In both cases, the available options appear once the reject decision is chosen ("reject" for MCDU and "reject reasons" for MFD). In addition, alternative reasons or additional information can be provided in free text format as part of the downlink message.

In comparison, the available information on the DCDU system does not appear to indicate any pre-formatted reasons for rejecting an ATC command. Free text appears to be the only alternative at this point, although minor software changes may be able to remedy this shortcoming. In any case, if free text needs to be entered, it must be done using the MCDU. Then, the process of responding to the ATC message first starts with the DCDU, moves to the MCDU for the free text entry, and shifts back to the DCDU. Not only is this shifting between hardware components not desirable, the use of the MCDU keypad and screen would necessarily eclipse information that pilots need to access from the MCDU, and therefore partially negate the advantages of having a dedicated DCDU for data link communications.

Figure 3-5 compares the menu options and layers that pilots need to proceed through in order to reject an ATC command with a reason entered in free text. The assumption was that the message is already on the display. Note in particular the relatively circuitous menu navigation and the shift between the MCDU and the DCDU that is necessary for the DCDU interface.

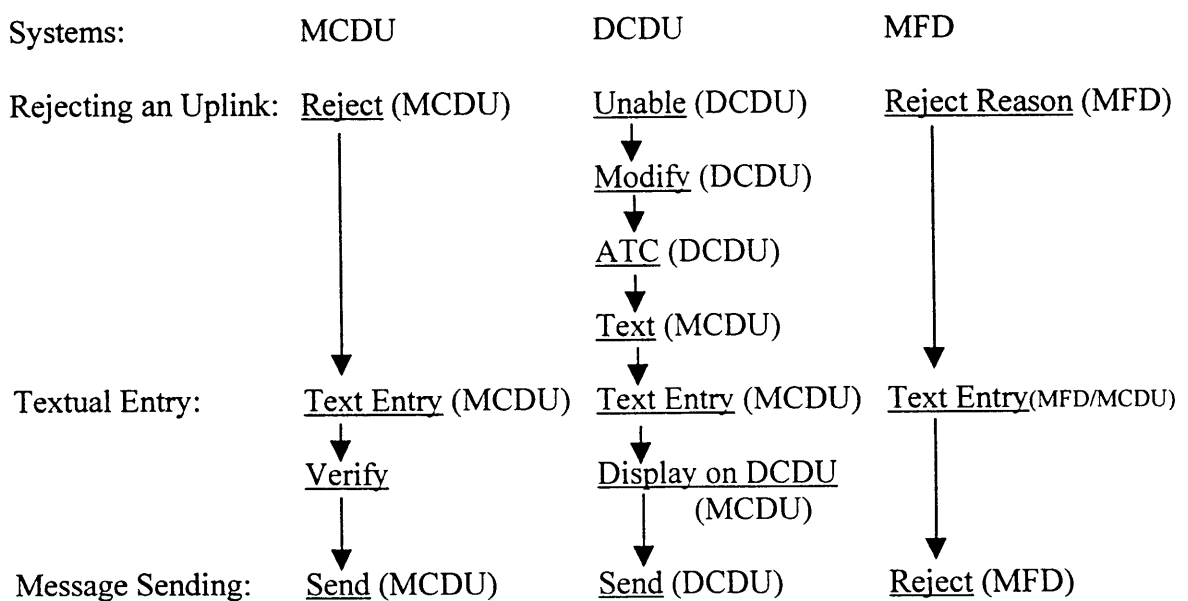

Underlined items need to be selected or entered by the pilots

Figure 3-5 Procedural Comparison - Rejecting with Reason

For example, in the DCDU-based system, after deciding on a reply, pilots would need to press the "Unable" command below the message content (on the same screen), and then the "Modify" command on the next page. After this, pilots would need to activate the MCDU (possibly by pressing the ATC Menu and then the "Text" command) and enter the free-text message using the key-pad and the scratch-pad. The text message

can then be transferred from the MCDU to the DCDU by pressing the "Display on DCDU" button on the MCDU, and be sent by pressing the "Send" button on the DCDU. The time penalty of the need of such shifting between hardware components is revealed later in Figure 3-6.

As an illustration, "low fuel" was used as a reason in free-text format to reject an ATC command. Table 3-5 compares the minimum number of button-presses required in each interface systems for rejecting an ATC command with the "low fuel" reason. Again, this assumes that the ATC message has already been displayed in the MCDU, DCDU and the MFD respectively for the three interface systems. The counting of button-presses stops at the last button-press before the message is sent to ATC.

Table 3-5 Number of Button-Presses - Rejecting an Uplink with "Low Fuel"

Systems	MCDU	DCDU (est.)	MFD
Menu Buttons (on MCDU)	1	1	0
Alphanumeric	8	8	8
Line-select/cursor-control	4	5	4
Number of all keys pressed	13	14	12
Number of pages of displays viewed	3	5	2

Figure 3-6 shows the times required for the process from the time when the aural alert was first activated. Note that while all three systems require similar numbers of button-pushes in the rejection process, the shifting between hardware components in the

DCDU-system resulted in significantly longer total processing time than the other two systems.

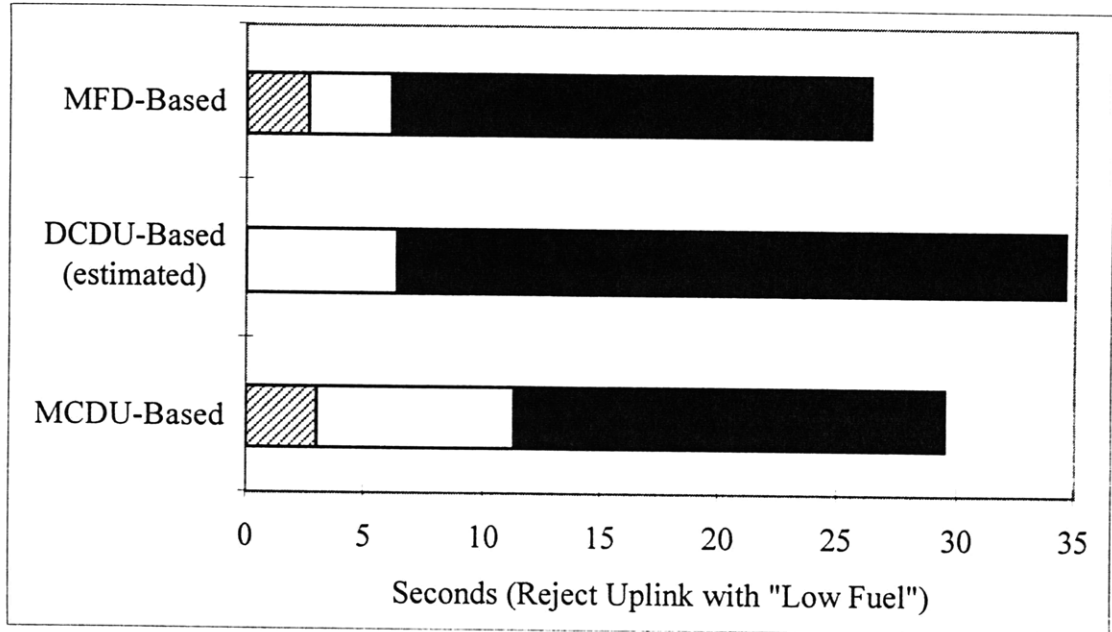

▨ Access to right page (till pressing of last button to display the message)
□ Reading message and verbalizing course of action
■ Responding to the message

Figure 3-6 Processing Times - Rejecting an Uplink with Free-Text Reason

As demonstrated in Section 3.2.1, the time needed to complete the reading of the message content is significantly longer in the MCDU than in the MFD, owing to the larger size and better display format of the latter. In the MCDU-based system, the time to complete the data entry process is the shortest, but the time penalty in message reading overwhelmed this advantage in the total duration for the entire response procedures. In contrast, the message content displayed on the MFD takes relatively little time to read, but the shifting of attention between the MCDU keypad and the CCD in entering the text on the MFD adds significant time penalty in the whole process.

3.2.3 Confirm Speed and Assigned Speed

To maintain adequate separation between aircraft, ATC may occasionally need to check the current speed or confirm the assigned speed to a particular aircraft. In future air traffic management environments where aircraft trajectory is planned on a four-dimensional basis (including time), such messages are expected to be more prevalent. The ATC message element "confirm speed" asks for the current speed of the aircraft while "confirm assigned speed" asks for the speed that has been assigned to the aircraft. Figure 3-7 summarizes the procedures for responding a speed confirmation request in all three interface systems.

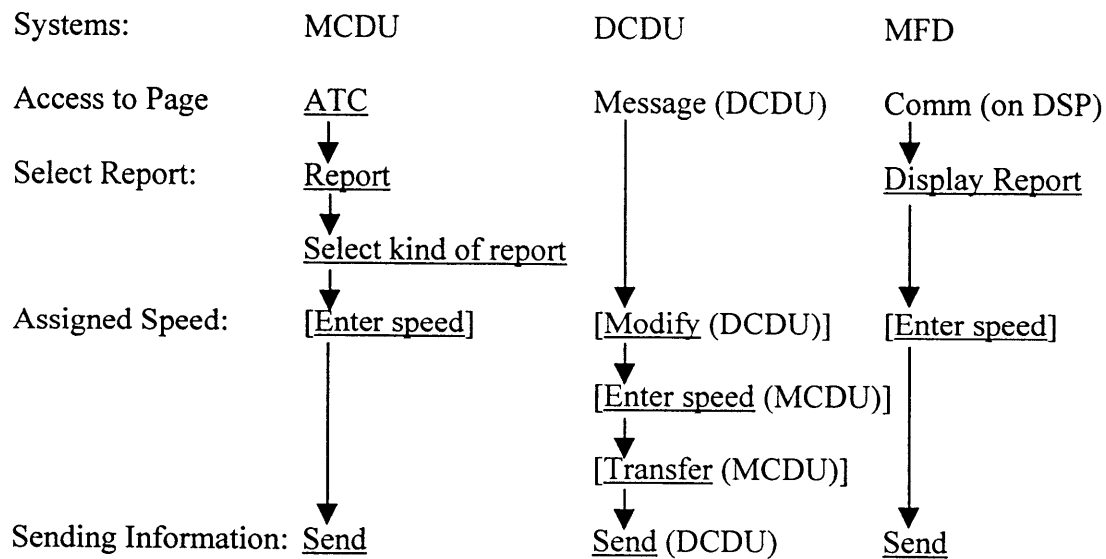

Underlined items need to be selected or entered by the pilots

Figure 3-7 Procedural Comparison - Speed Confirmation
 (Modification processes for assigned speed confirmation in square brackets)

Because ATC is asking for specific information from the pilots, no accept or reject is needed in the pilots' response. Instead, a response with the requested information is sufficient. In the MCDU- and MFD-based systems, the display of such ATC requests is accompanied by the command option "report" or "display report" respectively. On choosing this option, an appropriate report will be generated, showing the present speed or assigned speed, depending on the actual request. In the report of present speed in both systems, the actual speed is automatically inserted in the report when it is first shown, but it can be modified by the flight crew before being sent. In the report of assigned speed, the entry in the MCDU-based system is blank and needs to be manually entered, while the entry in the MFD-based system is either the assigned speed (if any) or the present speed (if there is no assigned speed entered into the system). Upon cross-checking the entry, the report can be sent by pressing the "send" option.

In the DCDU-based system, only the procedures for confirming assigned speed are available, but it is not unreasonable to expect a similar set of procedures for confirming present speed. For this system, as soon as the confirmation request is received from ATC, the requested information is obtained from the FMC and a tentative report is proposed on the DCDU. The "modify" option allows the flight crew to manually enter or change the information, but the MCDU key-pad remains the only mechanism to do so. Should modification of the proposed report be required, then, there would again be a shift of attention from the DCDU to the MCDU and then back to the DCDU in the process. A primary advantage of the automation of the report generation is that it reduces the chance

of confusion as to what the appropriate response should be. In a previous experiment involving airline pilots in the MFD-based data link environment, despite having been trained specifically for data link tasks, a significant portion of the participating pilots did not recognize the need to choose "display report" on receiving the speed confirmation request. (Boeing, 1996).

Table 3-6 compares the number of button-presses required in the three interface systems for speed confirmation, tracing from the sound of the message alert chime. Where the number of button-presses differs between the response to a speed confirmation request and to an assigned speed confirmation request, the latter figures are shown in parentheses. It is assumed that three numeric characters need to be entered manually to the assigned speed report.

Table 3-6 Number of Button-Presses - Speed Confirmation

Systems	MCDU	DCDU (est.)	MFD
Menu Buttons (on MCDU or DSP)	1	0	1
Alphanumeric	0 (3)	0 (3)	0 (3)
Line-select/cursor-control	3 (4)	1 (3)	2 (3)
Number of all keys pressed	4 (8)	1 (6)	3 (7)
Number of pages of displays viewed	3 (3)	1 (3)	2 (2)

Figures for the responding to "Confirm Assigned Speed" shown in brackets.

Figure 3-8 compares the estimated time needed for the operation for all three interfaces, both for responding to a speed confirmation request and for responding to and

manually entering the assigned speed to an ATC confirmation request. In particular, the automation of the report generation procedure in the DCDU-based system reduced a significant number of both button-presses and processing time for the speed confirmation request. However, the DCDU-based system requires the least number of button-presses in both operations, but the shifting between the MCDU and DCDU in the latter operation incurred a significant time penalty.

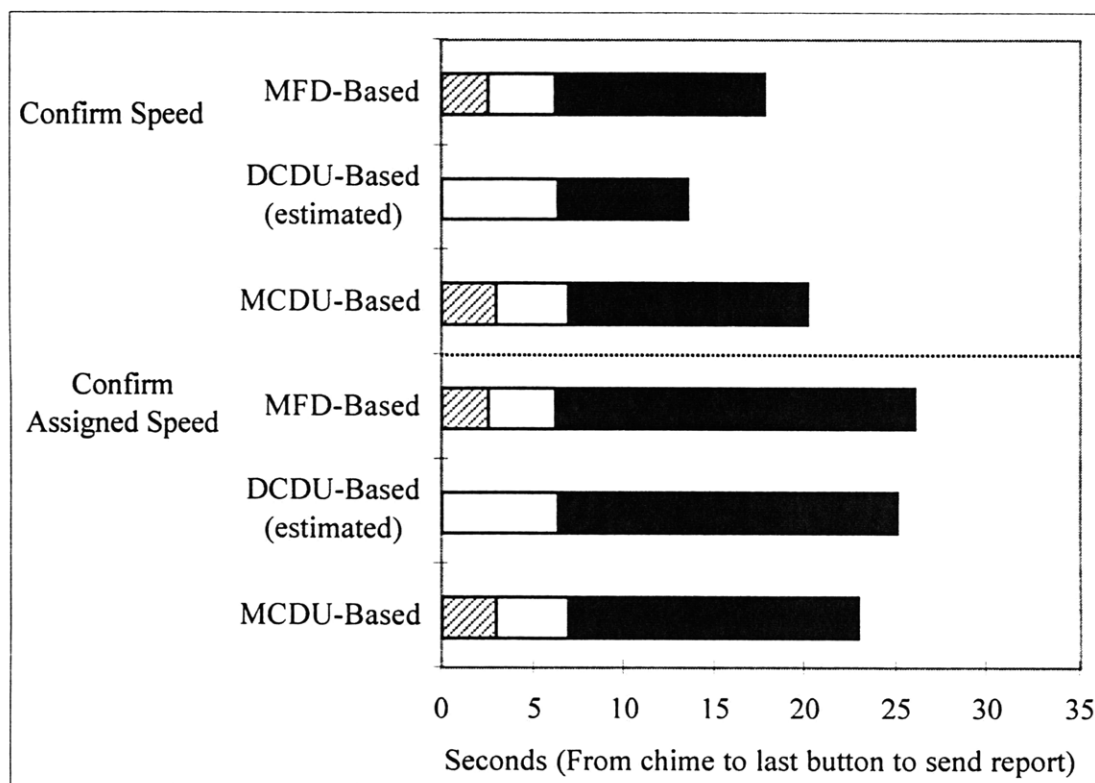

- Access to right page (till pressing of last button to display the message)
- Reading message and verbalizing course of action
- Responding to the message

Figure 3-8 Processing Times - Responding to Speed Confirmation Requests

Apart from speed, ATC can ask pilots to confirm other information like altitude, speed, heading, next way-point, and ground track. The procedures for responding to these

requests are similar to the speed confirmation procedures outlined here. Further, ATC can ask pilots to inform them when a certain altitude is reached, a way-point is passed, or when the airplane is back on a planned route. For these kinds of requests where the reports need to be generated at a later time, both the MCDU-based and the MFD-based systems allow pilots to “arm a report”, i.e., set up a report to be automatically sent when a specific condition is met (e.g. reaching altitude). The available literature on the DCDU-based system does not provide any information on this type of report, but the relatively highly automated nature of the system in other functions is indicative of comparable functions as in the other two systems.

3.2.4 Position Report

In the last three sub-sections, the communication tasks examined involved responding to an incoming ATC message. In this and the next sub-sections, the focus shifts to two pilot-initiated communication tasks with ATC: position reports and altitude change requests.

Position reports from the aircraft are normally issued when an ATC reporting point is passed over, or is passed abeam when an off-set flight is in progress. In the absence of automatic dependent surveillance (ADS) as envisioned in the full implementation of FANS, pilots can make position reports via CPDLC. From an operational perspective, when inbound from an area without CPDLC availability, the first position report via CPDLC should be sent to the responsible ATC center after the

3.2.3 Confirm Speed and Assigned Speed

To maintain adequate separation between aircraft, ATC may occasionally need to check the current speed or confirm the assigned speed to a particular aircraft. In future air traffic management environments where aircraft trajectory is planned on a four-dimensional basis (including time), such messages are expected to be more prevalent. The ATC message element "confirm speed" asks for the current speed of the aircraft while "confirm assigned speed" asks for the speed that has been assigned to the aircraft. Figure 3-7 summarizes the procedures for responding a speed confirmation request in all three interface systems.

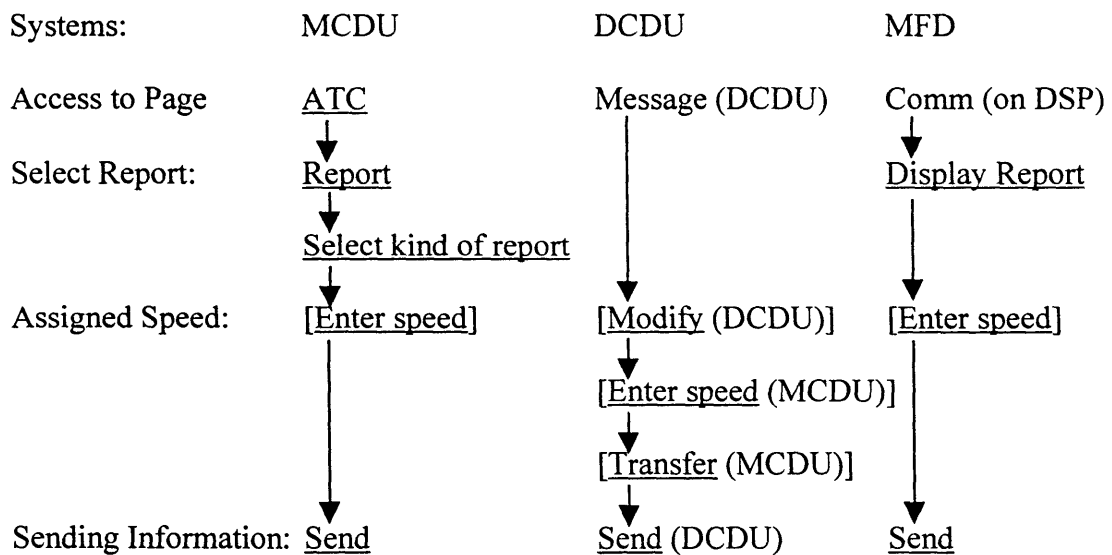

Underlined items need to be selected or entered by the pilots

Figure 3-7 Procedural Comparison - Speed Confirmation
 (Modification processes for assigned speed confirmation in square brackets)

For example, in the MFD-based system (similar procedures for the MCDU-based system), the DSP "Comm" button is first activated to put the MFD in communication mode. The option of ATC (versus AOC) data link should be chosen next with the CCD. This in turn activates a list of about a dozen menu options, one of which is position report. On the position report page, the latitude-longitude of the aircraft is automatically inserted, with supplemental information such as ride quality up to pilots' discretion for entry. The report can be sent by pressing the "Send" button on the same page.

Similar to the text entry required for a reject reply, the procedure for position reporting requires a shift of attention from the MCDU to the DCDU for the DCDU-based system. However, the minimum number of button-presses needed for this system is about the same as the other two systems. Table 3-5 shows the minimum number of button-presses required.

Table 3-7 Comparison of Button-Presses - Position Reporting

Systems	MCDU	DCDU (est.)	MFD
Menu Buttons (on MCDU or DSP)	1	1	1
Line-select/cursor-control	2	4	3
Number of all keys pressed	3	5	4
Number of pages of displays viewed	2	2	2

Figure 3-9 compares the processing times to send a position report using the three interface systems. Time at zero seconds marked the point when the pilot started to move

to begin the communication task. An average of 4 seconds were used by the pilots to verify the report before it was sent in all three interface systems.

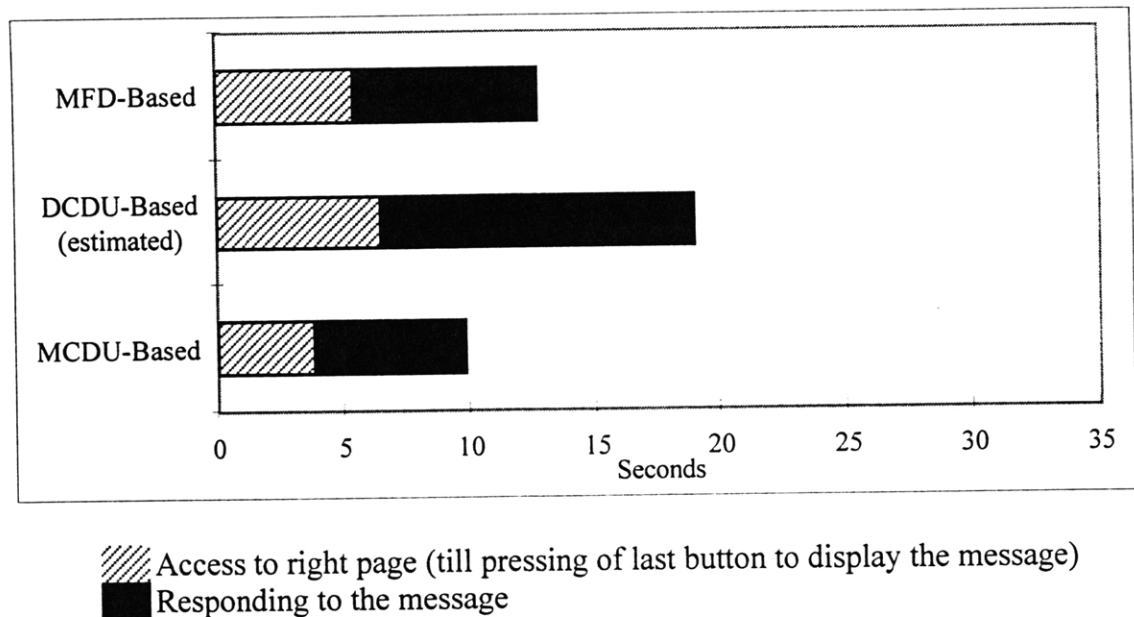

Figure 3-10 Processing Times - Position Reporting

In this case, the higher number of button-presses and shift of attention from the MCDU to the DCDU were estimated to translate to a higher overall processing time. However, if the message can be sent directly from either the MCDU or the DCDU in the DCDU system, the time savings relative to the time requirement of the other two interface systems could be significant.

3.2.5 Altitude Request

For reasons ranging from ride quality to fuel efficiency concerns, pilots may opt to request a change in altitude during flight. This kind of altitude request, as well as

requests for cruise climb, can be handled through CPDLC. Some simple examples are for pilots to "request climb to FL___" (a new flight level), "request descent to FL___", or "request VMC (visual meteorological conditions) descent". Similar procedures also work for lateral route offset requests, speed requests, and asking when to expect future clearances for a change in altitude, speed or route.

Figure 3-11 compares the levels of menu hierarchy through which pilots need to navigate to complete send an altitude request to ATC. For this task, the DSP is assumed to have been selected to the "comm" mode. As shown in the Figure 3-11, for the MCDU- and the MFD-based systems, the altitude request can be conducted on the MCDU and the MFD respectively. However, the DCDU system again requires that the process start on the MCDU and then move to the DCDU.

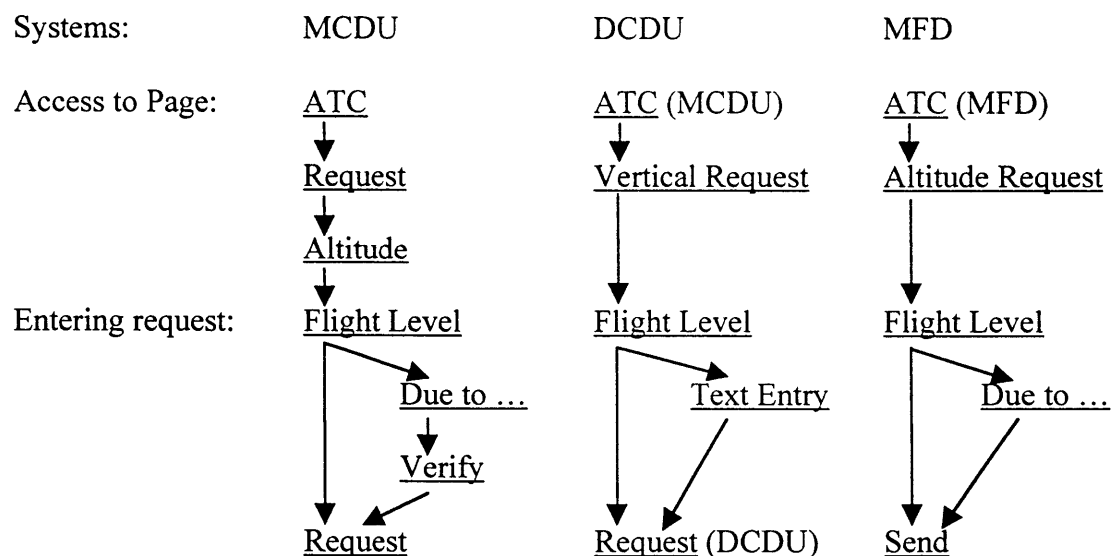

Underlined items need to be selected or entered by the pilots

Figure 3-11 Procedural Comparison - Altitude Request

Apart from the request itself, pilots can also append the reasons for the request. The MCDU- and MFD-based systems, for instance, have three optional reasons available: due to performance, due to weather, and at pilots' discretion. These messages are transmitted in text form but save pilots the time in typing. In addition, free text messages can be appended. In the DCDU system, such built-in options are not available, although pilots could still append the rationale in a free-text format.

Meanwhile, the presence of moderate or severe weather systems often cause pilots to request routing or altitude changes (see Fan *et al*, 1998a, 1998b). It is reasonable to expect that "due to weather" would often be appended to strengthen the request. In cases where this rationale is needed, then, the DCDU system requires the text to be entered manually, thereby significantly increasing the number of button-pushes and overall processing times compared with the other two interfaces. This is reflected in Table 3-8.

Table 3-8 Comparison of Button-Presses - Altitude Requests

Systems	MCDU	DCDU (est.)	MFD
Menu Buttons (on MCDU or DSP)	1	1	1
Alphanumeric	3	3 (17)	3
Line-select/cursor-control	4 (6)	3 (5) on MCDU 1 on DCDU	4 (6)
Number of all keys pressed	8 (10)	8 (24)	8 (10)
Number of pages of displays viewed	4	3 (4)	2 (3)

Numbers in parentheses - when "due to weather" is appended to the request

Figure 3-12 compares the total duration required by initiating an altitude change request, both with and without appending the reason "due to weather". In this case, the text entry in the DCDU-based system incurs significant time penalties compared with the other two systems, primarily as a result of the need to enter the reason by text. In the absence of this text entry, however, the three systems appear to have similar total processing time requirements, but with the DCDU-system estimated to take less time for the pilots to navigate to the altitude request page.

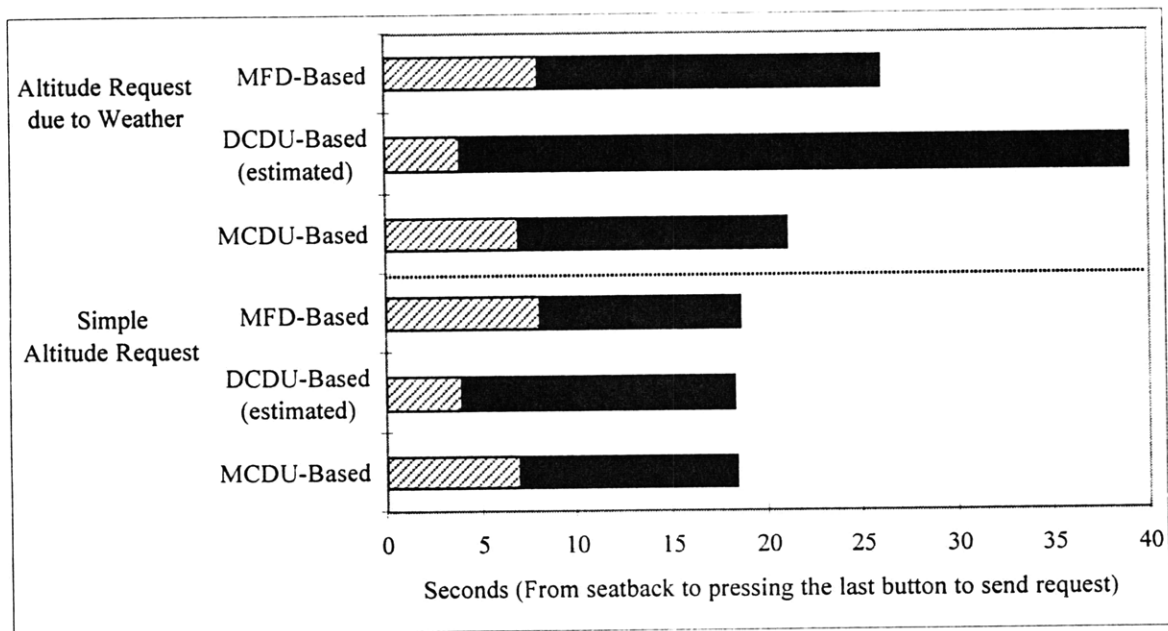



 Access to right page (till pressing of last button to display the message)
 Responding to the message

Figure 3-12 Processing Times - Altitude Request

3.3 Overall Comparison

In addition to the five different CPDLC applications examined in section 3.2, the following applications were examined: logging-on to CPDLC, requesting a route change, and loading information from an ATC message to the FMC. The procedural and processing time comparisons for these tasks are available in Appendix B.

As a summary of comparison for the communication tasks reviewed in section 3.2, Figure 3-13 shows the minimum number of button presses needed for selected tasks.

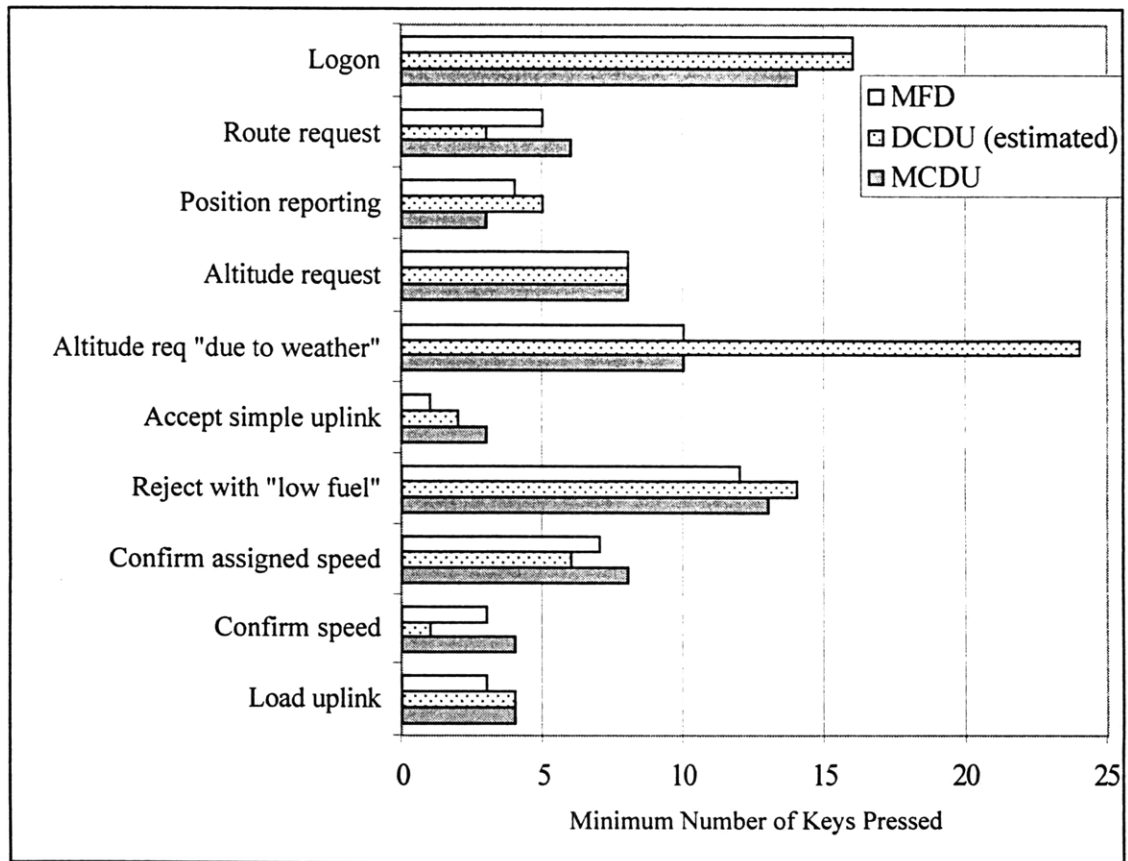

Figure 3-13 Minimum Number of Button-Presses - Tasks Examined

As shown in Figure 3-13, the minimum number of button-presses for the set of communication tasks examined is in fact very similar for the three interface systems. Two notable exceptions are the inclusion of the rationale "due to weather" in requesting a change of altitude (where this needs to be entered by text in MCDU of the DCDU-based system), and the speed confirmation task (where the highly automated feature of the DCDU-based system resulted in fewer number-presses needed). Figure 3-14 compares the total duration required or projected to complete the same list of tasks.

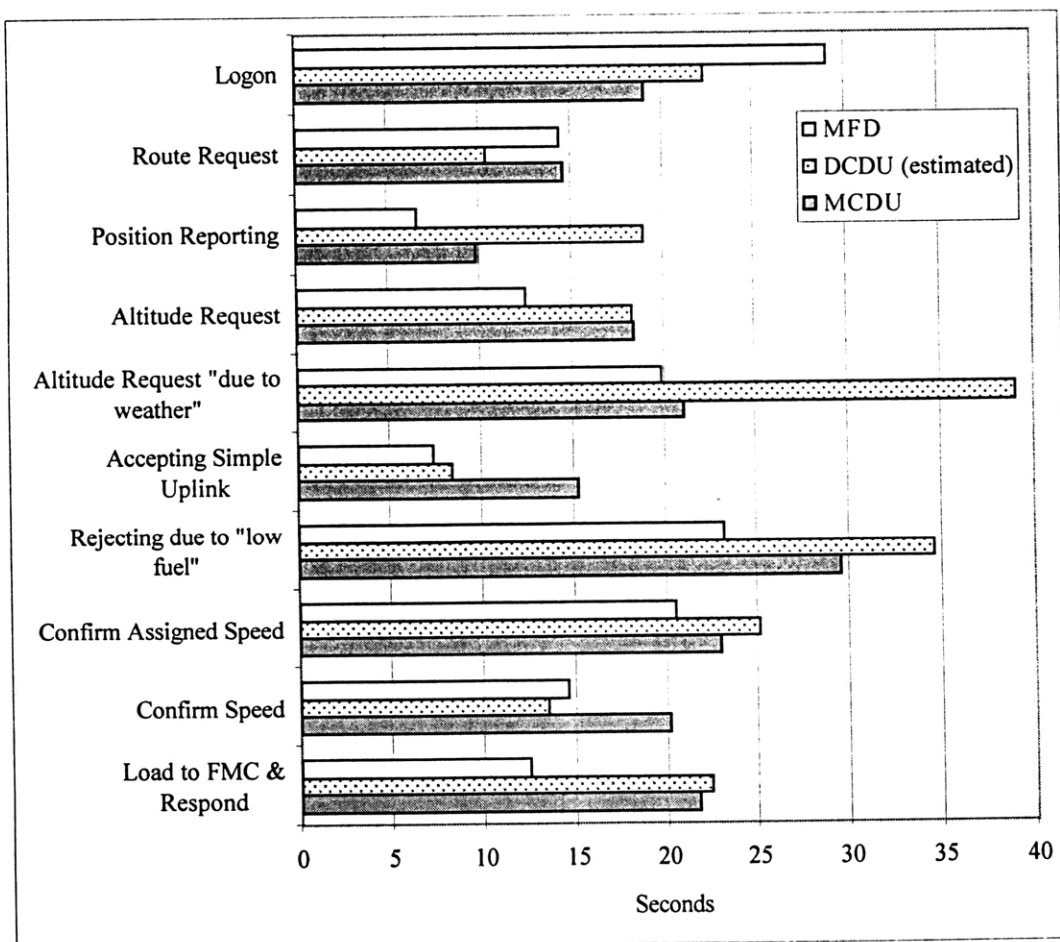

Figure 3-14 Comparison of Total Duration for Communication Tasks

Comparing Figures 3-13 with 3-14 reveals that the use of a dedicated ATC message display in the DCDU- and MFD-based systems dramatically reduced the time to respond to simple ATC messages (both accepting simple uplinks and confirming speed). The use of a dedicated facility for data link communications with ATC allows pilots in many cases to simultaneously access the FMC while responding to or initiating ATC messages. In future operating environments where frequent ATC messages are needed for four-dimensional control of aircraft position and time, this dedicated capability may prove to be vital.

A major disadvantage of the DCDU-based system, however, is the significant time penalty incurred in switching between the DCDU and the MCDU when alphanumeric entry is required. This is evidenced when requesting an altitude change with the "due to weather" reason, rejecting an ATC uplink with "low fuel", and, to a lesser extent, the confirmation of assigned speed (where the assigned speed needs to be manually entered). Further, the software design of the menu hierarchy for the DCDU-system is also expected to result in time penalties in sending position reports.

As for the MCDU-based system, the staff members of the Flight Deck Engineering group prior to this study felt that this interface was the most rudimentary and least user-friendly. The study here shows that while this might be correct as a general notion, the MCDU-based system performed well in cases where alphanumeric entries are required (as in log-on procedures). In fact, in many other cases, the total time required to

complete a communication task on the MCDU interface was estimated to be shorter than using the DCDU-based interface (where shifts between the MCDU and the DCDU are often required). However, it was not clear from this study what additional mental workload is created with forcing pilots to use the single interface of the MCDU in this system (compared to having information available on multiple interfaces).

Except for the log-on procedures, route request and speed confirmation, the MFD-system took the shortest time in completing all the tasks examined. The most notable time savings in using the MFD were in accepting simple uplinks with the EICAS and glare-shield buttons, and in loading route information from an ATC message to the FMC.

In alphanumeric entry to the MFD, the use of both the key-pad on the MCDU and the CCD incurred more time penalty than using the key-pad and the line-select keys on the MCDU in the other two interfaces. Nevertheless, the larger screen of the MFD allows a "flatter" menu hierarchy and more command options to be displayed on the same page than the other two interfaces, and hence resulted in an overall time saving.

Over the course of a flight, the total number of communication tasks performed using CPDLC can vary significantly depending on the airspace traversed. As an illustration, Table 3-9 shows an example of the number tasks each type of communication tasks are required on a hypothetical flight.

Table 3-9 Communication Tasks in a Hypothetical Flight Scenario

Communication Task	No. of Times	Communication Task	No. of Times
Log-on	1	Confirm speed	1
Route request	1	Confirm assigned speed	1
Position report	5	Load route to FMC	1
Simple uplink acceptance	5	Altitude change request	2
Reject simple uplink with "low fuel"	1	Altitude change request with "due to weather"	1

Figure 3-15 shows the minimum number of button-presses needed to complete this list of tasks, based on this hypothetical flight. The assumptions on the set-up of the interface system prior to the beginning of these tasks are the same as the ones described before. The only difference here is that there is one more scenario examined: that the MFD is already in the communication mode when ATC messages are received (no need to press the "Comm" key on the DSP at the beginning).

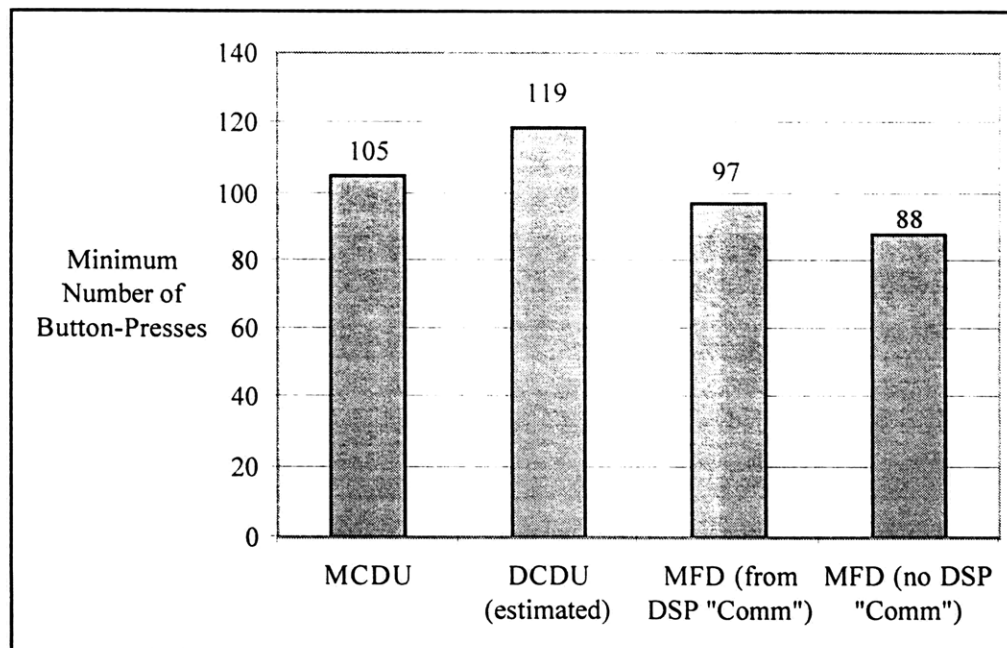

Figure 3-15 Minimum Number of Button-Presses for the Hypothetical Flight

As shown in Figure 3-15, in this hypothetical flight, the DCDU-based system requires about 13% more button-presses than the MCDU-system, and about 23% more than the MFD-system requiring the DSP-COMM activation. Figure 3-16 shows the total length of time estimated to complete all the communication tasks on this flight.

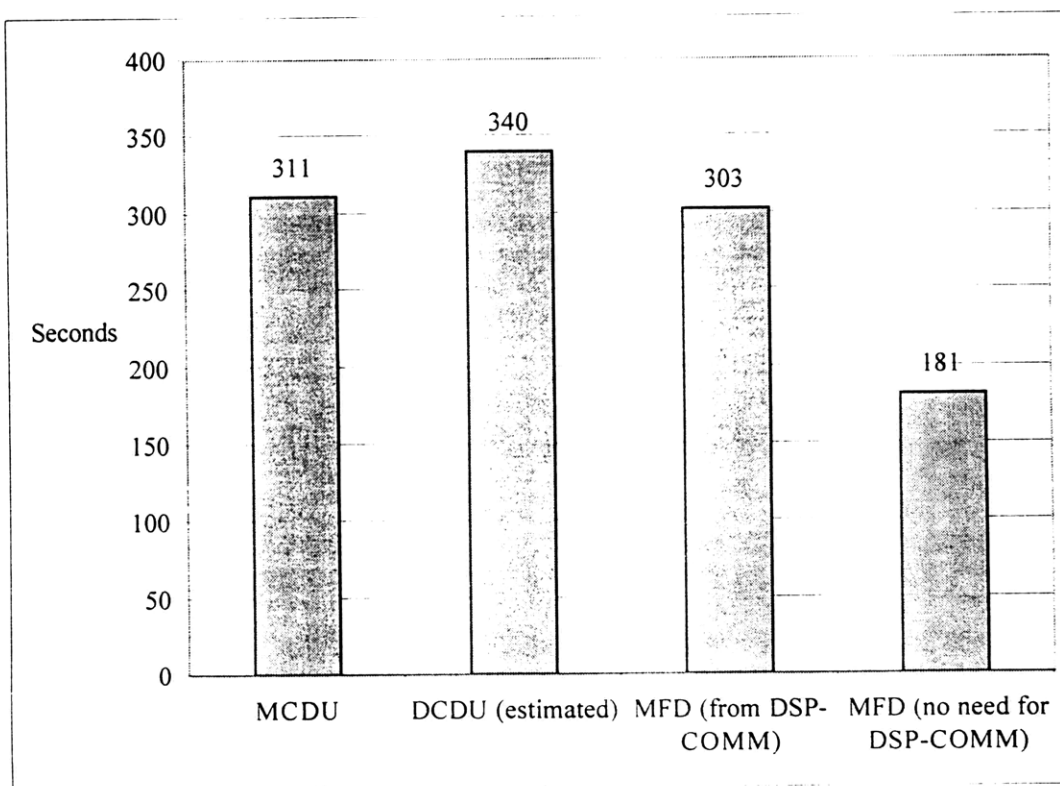

Figure 3-16 Total Duration for the Communication Tasks on Hypothetical Flight

Note the pattern in Figure 3-16 mirrors the one in Figure 3-15, pointing out the fact that the number of button-presses probably is the most important determinant on the total length of time needed to complete a communication task using CPDLC, at least for this hypothetical flight. For the case where pilots do not have to press the "Comm" button in the DSP at the beginning of the task, the resultant time saving is significant. This is evidence of the time penalty in requiring the pilots to shift their attention from one piece

of the interface hardware to the next. Note that while the difference in time requirements is not large among the different interfaces, this is an aggregate result of different trade-offs among these systems when the pilots are totally focused on the CPDLC functions and when they know exactly which path to navigate. In reality, these two assumptions often do not hold, and must be taken into account. Further, the workload issue has also not been explored in this study. These motivate the design of an experiment which attempts to incorporate these realistic concerns in a concerted fashion, as is described in the next Chapter.

4. INTERFACE DESIGN STUDY

4.1 Objectives

The performance data discussed in Chapter 3 can in general be attributed to three different influences: the physical arrangement of the communications interfaces (e.g., where the interfaces are located in the flight deck), the design of the interface hardware (e.g., how many display line-select keys are provided) and the software in the interface (e.g. the design of the menu hierarchy). Given that all these factors vary in the existing interface communications, it is difficult to pin-point the extent of influence of each of these factors. Using a computer interface in a standard setting, the effect of different physical locations is isolated. With the same fundamental menu hierarchies (with minor changes across different configurations), the effect of using different menu structures is standardized. These allow the effect of interface design on subjects' performance to be fairly compared across different interface configurations in a controlled experiment.

An experiment was conducted to illuminate how human performance is influenced by the design of the interface hardware. Specifically, it was hypothesized that given the same amount of information required to be accessed in a particular task, an increase in the number of available interfaces that can be used to access the required information elements, the shallower the menu hierarchy that can be designed for each interface. A shallow menu hierarchy is expected to reduce the task processing time and mental workload (leading to more desirable performance). As the number of interfaces increases, however, subjects may need more time to think about how these interfaces are to be used, and to "manage" all the interfaces at a global level. At some point then, the performance gains (reduced task processing time and mental workload) in having more individual interfaces would be overwhelmed by the complexity of having to manage all these

interfaces. The experiment was designed to investigate this nature of performance trade-offs by varying the amount of overall workload in a particular situation.

To simulate flight deck applications, common functions in CPDLC were used. For simplicity, the control and display units were modeled on the screen of a workstation, requiring mouse-clicks to activate the command buttons. A Java program was written to provide this simplified and interactive data link communications interface on the SGI workstation at the MIT International Center for Air Transportation. All the assigned tasks and information needed were displayed on the screen. These reduced the variance in experimental conditions for different subjects.

4.2 Previous Research

Much research in the area of human-computer interface designs has focused on the design of menu hierarchies. Miller (1981) conducted a classic experiment on the depth-breadth trade-off in the design of menu hierarchies. He concluded that in the design of a menu hierarchy for 64 randomly arranged terminal options, the mean time of accessing the correct option and the error rate reached a minimum at having eight options in each of two menu layers. The accessing time and error rate increased from this point with an increasing number of options per menu layer and with an increasing number of menu layers. Based on Miller's work, Snowberry, Parkinson and Sisson (1983) showed that a proper grouping of the command options lowered both the accessing time and error rate at increasing number of options (up to 64) per menu layer (and a decreasing number of menu layers).

In a more general context, Lee and MacGregor (1985) formulated an expression for the number of options per menu page that minimized the access time for any particular

option as a function of reading speed, key-press time and computer response time. For a self-terminating search (where the user terminates the search as soon as the correct option is encountered), three options per page was found to correspond to a minimum access time. For an exhaustive search where all options on a page are read, this increased to four per page.

Paap and Roske-Hofstrand (1986) argued that further reductions in the access time could be achieved if the command options were properly grouped together. However, in the context of flight deck interface designs, constraints in hardware size often reduce the number of total command options displayed per page and hence the effect of properly grouped options. Meanwhile, Fisher, Moss and Yungkurth (1989, 1990) incorporated the probability that a particular option is accessed by a user in the prediction of average access times to a list of terminal command options in a menu hierarchy. This set a framework in comparing task processing times using different nested menu hierarchical structures.

The menu designs mentioned so far have all been hierarchical in nature. With the advent of electronic screens, computer menus can in fact also be network-like (access to specific options not restricted by strict hierarchies). Mohageg (1992) compared the efficiency of information retrieval using the linear (like reading a book from cover to cover), hierarchical, and network menu structures, as well as a mixed hierarchical and network structure. He concluded that the hierarchical linking structure outperforms the network linking structure in information retrieval, and that the mixed structure provided no consistent advantages over the purely hierarchical one.

In terms of flight deck-specific interfaces, far fewer studies have been conducted. A notable one, by Abbott (1995), involved an evaluation of a multiple-window concept of graphical user interface. Resembling the operating environment of personal computers

or workstations, multiple windows could be opened within the CDU, with only one window being worked on at any given time. These multiple windows are primarily used to select or enter alternate values (e.g. alternative altitude or speed) for, say, a specific way-point. Due to the size of the CDU screen, however, the major weakness of this design was that the one active window often covered most of the information presented by other non-active windows. In the eight tasks evaluated, the independently rated performance of the multiple-window CDU was significantly better than the conventional CDU in only one task.

For future research, Abbott (1997) suggested that “the functions provided in the CDU should more directly support pilot operational tasks, especially in the area of ATC clearance requirements,” and that “a window or page hierarchy that offers a natural linking and tractability mechanisms” be provided.

The proposed experimental design, as will be discussed in later sections of this chapter, has taken these considerations into account. In particular, the designs investigated in the experiment avoid the use of overlapping windows, and instead opt for multiple display screens and interfaces.

4.3 Interface Configurations

A total of four different data link communications interface configurations were examined in this study. Each configuration had five basic elements: a small alert message window, the main display screen, command option buttons, a prompt display and an interruption display. When an ATC message arrives, a new message notification is displayed in the alert message window to serve as a visual alert. The main display screen and the command option buttons beneath the screen are (functionally integrated with the main display screen) used to simulate the multipurpose control and display unit

(MCDU) in the flight deck. The prompt display is used for the display of pilot-initiated downlinks and non-communication-related tasks (not initiated by the arrival of an ATC message). The interruption display is used to show the interrupting task if there is one. When an interruption task is activated, the subjects must first complete the interruption (by pressing a command option button within the interruption window) before being able to select command options in the primary task.

Figures 4-1 and 4-2 depict the four interface configurations used, with their descriptions as follows:

- Configuration 1: One fully functional interface, with a display-only screen and four command buttons. Prompt messages and tasks generated from a source other than air traffic control are displayed on the top right adjacent to the interface. Interruption tasks are shown on the bottom right adjacent to the interface.
- Configuration 2: One fully functional interface, with an additional display-only portion of the screen (on the top) showing an unreplied message. As in Configuration 1, prompt messages and tasks generated from a source other than air traffic control are displayed on the top right adjacent to the interface, while interruption tasks are shown on the bottom right adjacent to the interface.
- Configuration 3: Two fully functional interfaces with access to non-overlapping sets of functions: the left one accesses communications-based functions whereas the right one accesses information and commands related to airplane systems. Prompt messages and tasks generated from a source other than air traffic control are displayed on the top right adjacent to the right fully functional interface, while interruption tasks are shown beneath these.

Configuration 1: Single Interface

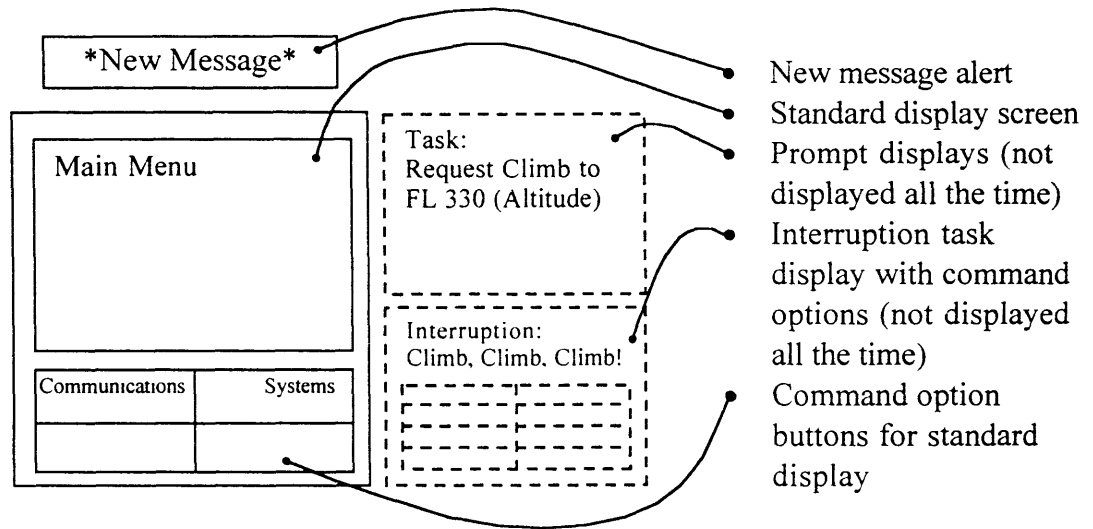

Configuration 2: Single Interface + Display-only Screen

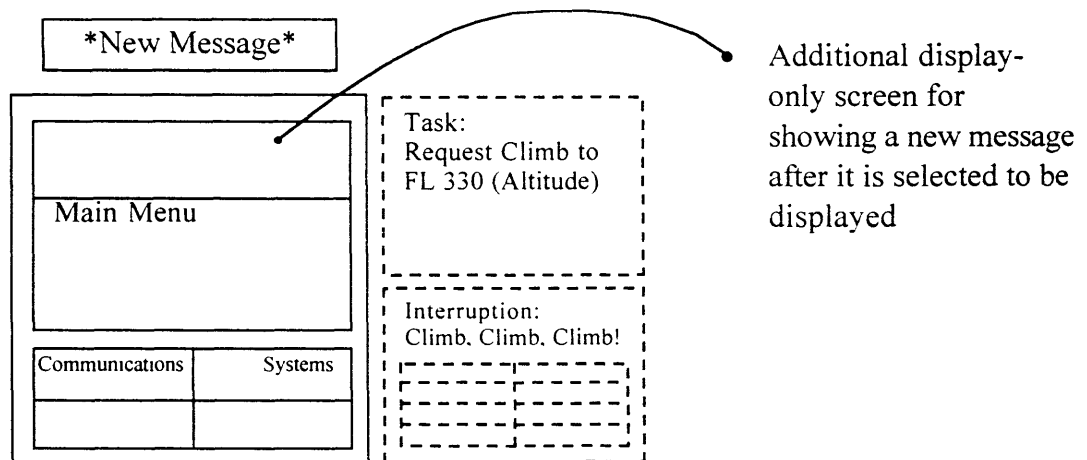
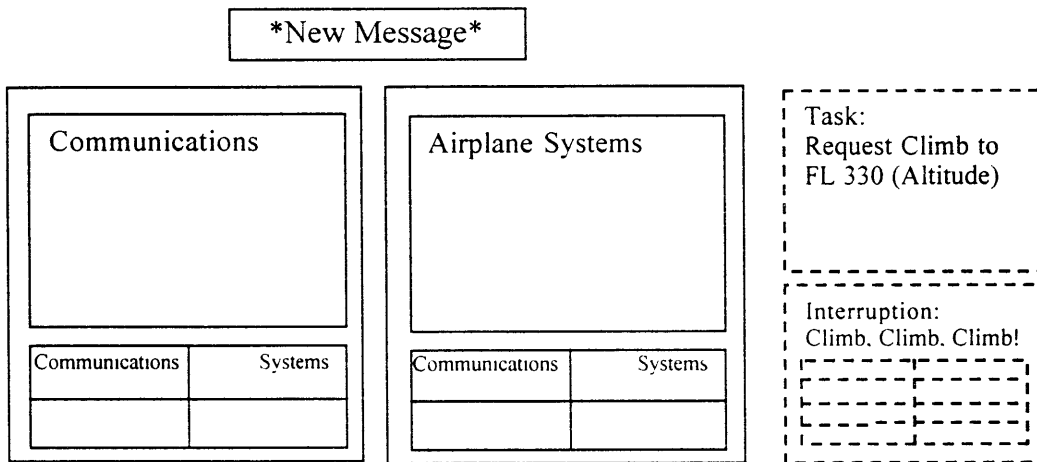

Figure 4-1 First Two CPDLC Interface Configurations in Experiment

Configuration 3: Two Interfaces - Separate Functions



Configuration 4: Two Interfaces - Same Functions

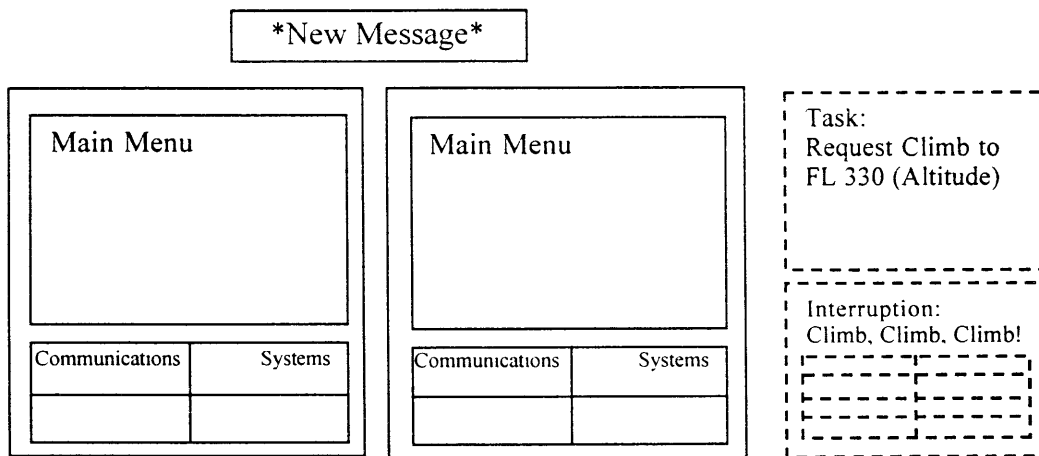

Figure 4-2 Last Two CPDLC Interface Configurations in Experiment

- Configuration 4: Essentially the same as configuration 3, except that both fully functional interfaces can be used to access the same set of functions and information. It is up to the subject to decide which interface to use.

Notice from Figures 4-1 and 4-2 that a small screen above the standard, fully functional interface is where the “New Message” alert is shown. This new message notification extinguishes when the assigned task (in the message) is completed. Both the main display and the display-only screen for the interfaces are scrollable if the message or body text cannot be displayed on one screen. Below the main display are four simplified menu buttons. These take the place of line-select keys on the MCDU and the DCDU on the flight deck. In line with existing data link interface designs, the primary responses to incoming messages are either “accept” (representing “will comply”, “affirm” and “roger”) or “reject” (representing “unable” and “negative”). The displays for prompt messages and tasks not originated from air traffic control are shown in dotted lines as they appear on the screen only intermittently.

As mentioned, the menu hierarchies used in the four configurations were essentially the same in all configurations. The exception was in Configuration 3 (two interfaces, separate functions) where the communications- and airplane system-related functions were available on separate interfaces, and hence there was no need for a main menu that allowed subjects to select either communications or airplane systems. Figure 4-3 shows the higher levels of the menu hierarchy used in the experiment while Appendix C shows the details of the page links.

To mitigate the effect of learning among different interface configurations, the order in which these configurations are used in the experiment was counterbalanced. There is an equal chance that a subject may start with configuration 1 and end with configuration

3 than, say, starting with configuration 2 and ending with configuration 4. This also required at least 24 subjects for at least one set of data to be collected in each of the sequence of interface configurations used.

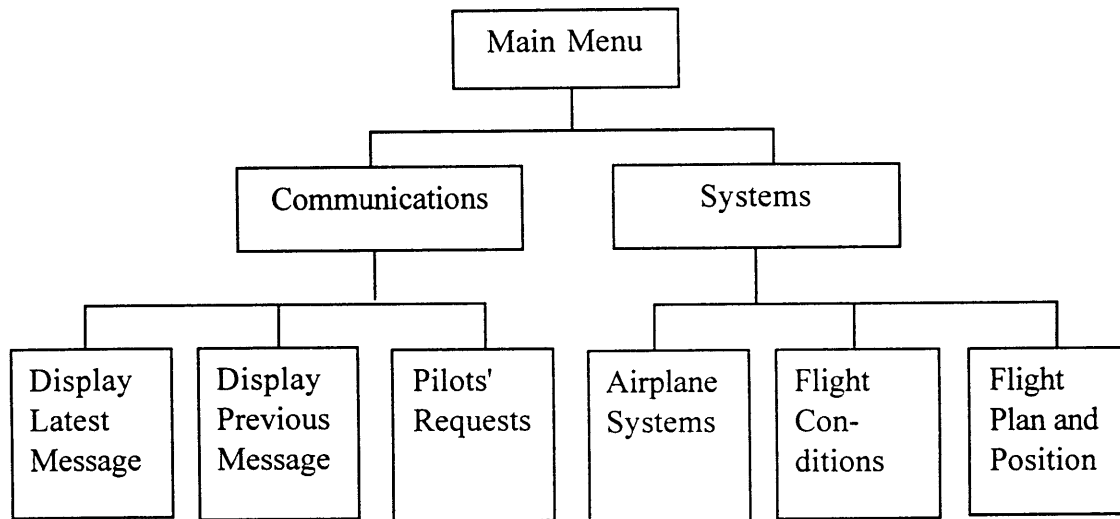

Functional Examples:

- Respond -Respond -Speed -Temperature -Altitude -Flight Plan

Figure 4-3 Menu Hierarchy in Experiment

4.4 Classification of Communications Tasks

In the interface design experiments, communications tasks assigned to the subjects were categorized in four different groups. Each group was characterized by a set of required responses from the subject. The basic groups of tasks were: simple acceptance messages, pilot-initiated requests, questionable commands, and flight-plan cross-checking. The tasks used in the experiment are shown in Appendix D.

Simple acceptance messages were sent by air traffic control and required nothing more than a simple acknowledgement (e.g. “roger”). These messages were used as a baseline measurement for subsequent comparisons. In the experiment, subjects would need to display the message and then respond by accepting it. Examples of these messages include “Expect further clearance at a later time”, “Maintain flight altitude” and “Resume normal speed”.

In aviation, pilots from time to time need to initiate requests to change assigned routing or speed to air traffic control. In the experiment, the subjects were asked to act as a communicating pilot to send requests to air traffic control (upon request from the flying pilot, etc.). The instructions for these tasks were given in the prompt display, and therefore there was no need to display the message and respond to the message. The subjects could proceed directly to the desired menu and command option. Examples of these tasks include “Request a new altitude, speed or route” and “When can we expect to change altitude, speed or route”.

On some occasions, air traffic controllers may ask the pilots if they could accept certain altitudes or speed, or may assign an altitude or speed beyond the performance limitations for a particular aircraft under specific loading conditions. Pilots should check whether these new conditions could be met by the aircraft before sending a reply indicating compliance. In the experiment, upon receiving such questionable messages from air traffic control, the subjects were asked to check for aircraft performance limitations before replying. Further, they were told to accept these commands only when they could be met, and to reject otherwise. The interface in the experiment was programmed to illustrate different performance limitations such that the subjects would have to access the performance limitations every time such messages arrived.

Closely related to the questionable commands are flight-plan cross-checking tasks. Occasionally, air traffic control may ask pilots to confirm the routing of an aircraft, in which case pilots would need to double-check the assigned routing, the route programmed in the flight management computer, and the route sent in from the airline operations center, if applicable. At least in commercial aviation, air-ground data link interfaces usually allow route clearance messages to be printed for ease of comparison. However, there is usually a penalty of a few seconds' delay in the printing process, and pilots may opt to compare two flight plans using electronic displays. Alternatively, the route clearance message can be uploaded to the navigation display for comparison with the existing flight plan information. Flight plan cross-checking tasks were created to simulate such situations, where subjects were asked to compare two flight plans using the available interfaces.

To balance the demand of communications tasks, systems-related (not initiated by incoming ATC messages) tasks were also introduced in the experiments. These tasks simulate situations when the pilots are asked by cabin attendants to adjust cabin temperatures, when the pilot checks the current versus assigned heading, when the data link communication has to be reconnected, and when a position report needs to be made.

Occasionally, when the subjects were at an electronic page two pages after the display of the ATC message or task prompt, they were interrupted by a TCAS warning that demanded immediate attention and response. The TCAS warning was used as an interruption task, and was displayed in the bottom right window. The purpose of introducing interruption task was to simulate actual flight deck operations where pilots have to tend to other tasks than communications with ATC, and to remove the status of communications tasks from the subjects' working memory. Together with systems-related tasks, the interruption tasks also served to add variety to the otherwise purely communications-related tasks.

4.5 Subtasks

The processing of data link communications tasks can be separated into a number of sub-tasks. Figure 4-4 shows a linear sequence of specific events in an idealized, uninterrupted data link communication exercise. Note that in reality, the sequence may be interrupted, or, for the case of pilot-initiated requests, the initial access to the new ATC message may not be required.

At least in theory, then, a data link communication task can be broken into many sub-tasks. However, only a few of the events listed in the sequence in Figure 4-3 can be observed and recorded objectively. To ensure that the time required to carry out important sub-tasks can be measured unambiguously in the experiment, three broad stages in the processing of communication tasks were identified: accessing the new message, accessing the needed information (may not always be applicable), and completion of the task.

For the purposes of the experiment, the time between the display of the new message alert and the display of the relevant message was considered a reasonable estimate of the duration for the first subtask (access to new message). The duration for the second subtask (access to information), applicable for questionable commands and flight plan cross-checking, began at the end of the first subtask and ended at the last button-press just before the relevant information was displayed. The third subtask (task execution) began at the end of the second subtask and lasted until the end of the task.

Specific Events in a Timeline:

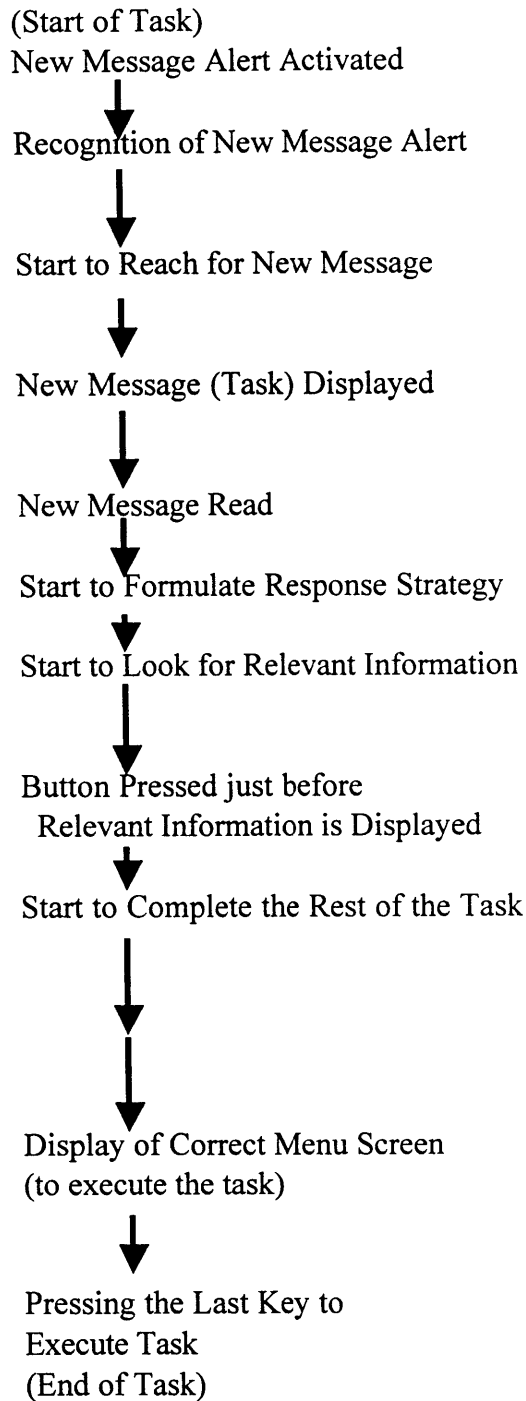

Broad Stages with Observable Start- and End-Points:

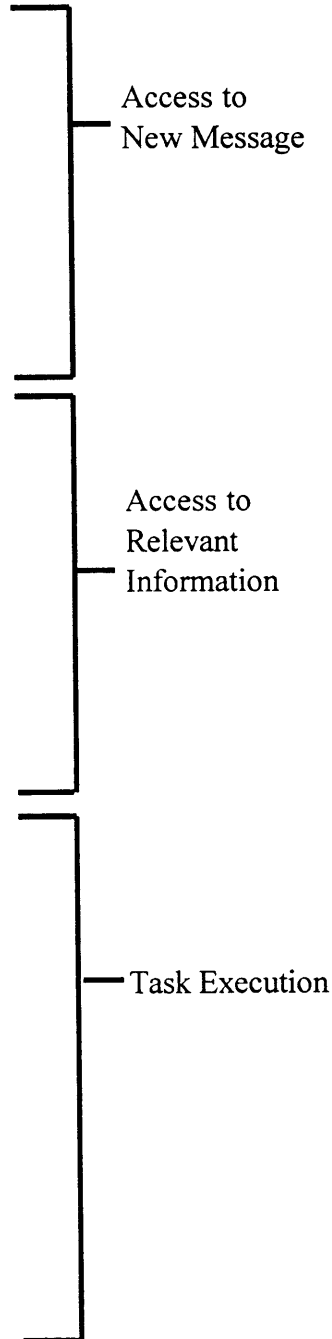

Figure 4-4 Idealized Response Sequence

4.6 Experimental Setup

Before the experiment, subjects were presented with a brief introduction to the background of data link communication and the experimental setup. They were then presented with the first interface configuration (which was equally likely to have been any of the four configurations) to familiarize themselves with the communications and systems menus. After they became familiar with the interface, they were given training tasks that resemble those in the experiment. They were guided through this training process and their navigation on the interface was not recorded in this stage. In the experiment, subjects were asked to perform a series of tasks, as shown in Table 4-1, in all four interface configurations.

Table 4-1 Number of Tasks by Category for Each Configuration

Task Category	Interrupted	Uninterrupted
Simple Acceptance	2	1
Pilot-Initiated Downlinks	2	1
System-related Tasks	2	0
Questionable Commands	2	1
Cross-Checking Flight Plans	2	0
Subtotal	10	3
(The actual order of tasks was randomized.)	Total: 13 Tasks	

4.7 Selection of Workload Assessment Tool

In evaluating the relative merits of the different communications interface designs, it is important to evaluate the amount of workload the imposed communication tasks require using different interfaces. In particular, three techniques that have received the greatest attention and having the widest range of applicability were considered. These were the Cooper-Harper scale, the Subjective Workload Assessment Technique (SWAT) and the National Aeronautics and Space Administration Task Load Index (TLX).

In the Cooper-Harper scale (Cooper and Harper, 1969), subjects are asked a series of questions in a decision tree. Based on the answers to these questions, the level of workload is eventually identified in one of ten different levels (in the modified scale, see Wierwille, Casali, Connor and Rahimi, 1986). While this single-dimensional scale has been used in assessing the workload in commercial aviation, there are fundamental drawbacks with this scale. A close examination of the description of the various workload ratings reveals that each rating describes a combination of mental workload and either performance or error. In the context of communications interface designs, however, the difference between mental and physical workload may be significant. This distinction may be important when considering the demand of simultaneous tasks. As well, as pointed out by Hart (1986), the fact that the scale requires a different factor be considered at consecutive decision points poses a problem. Moreover, Kilmer et al. (1988) reported that the Modified Cooper-Harper Scale appeared to be less sensitive than the SWAT

scale, to be discussed next. The Cooper-Harper scale was therefore not chosen for this experiment.

The SWAT scale, first suggested by Sheridan and Simpson (1979) and further developed by Reid et al. (1981), is based on conjoint measurement methodology. It identifies three dimensions of workload: time load, mental effort load, and stress load, and subjects are asked to rank how combinations of different levels of these loads contribute to the overall workload. A rescaling of the data set then maps these rankings to a single-dimensional workload scale. With three levels of workload in each of the three dimensions, a total of 27 combinations need to be ranked. The sheer number of combinations to be evaluated can arguably introduce significant error in the subjective assessment. In the interface design experiment, little stress was imposed, and there was no explicit time constraint (subjects were told before the experiment that they could take as long as they wanted to complete the tasks). These then effectively reduce the SWAT scale to a single-dimensional scale for the perceived effort, which would not be able to distinguish the difference between, say, physical and mental effort.

Developed and evaluated at NASA Ames Research Centre (Hart, Battiste and Lester, 1984; Hart and Staveland, 1988), the TLX is a multidimensional rating procedure for subjective assessment of workload. In addition to the workload rating in six dimensions (mental workload, physical workload, temporal workload, individual performance levels, effort to accomplish stated level of performance, and frustration.), the

TLX provides an overall workload score based on a weighted average of the individual ratings. In this way, the TLX is quite similar to SWAT, and both have been shown to be sensitive, reliable and highly correlated measures of mental workload (Vidulich et al., 1985; Hayworth et al., 1987). However, the more detailed differentiation of different sources of workload in the TLX, especially the delineation between mental and physical demand, likely contributes to a higher sensitivity in the workload assessment. Indeed, the TLX was shown by Battiste and Bortolussi (1988) to be more sensitive to subtle workload changes in low-workload environments than the SWAT scale.

Nygren (1991) did point out that an advantage of SWAT over TLX is the capability of the former to act as a psychological model of subjective judgment. In studies which individual differences are a major concern, then, SWAT would be a better scale than TLX. However, in the context of the interface design experiments, TLX appears to be more appropriate, and was chosen as the tool to assess subjective workload.

This page intentionally left blank.

5. RESULTS OF THE INTERFACE DESIGN STUDY

The coding of the software program of the experiment began in January, 1999, and refinements of the experimental design were made concurrently. The experiment was conducted from the end of March to early April, 1999. The subject profile is discussed first, followed by the results of the experiment.

5.1 Subject Profile

A total of 24 students recruited from the MIT community took part in the study from mid-March to April, 1999. The age of the group ranged between 20 and 29, with an average of 25 and a standard deviation of 2.8 years. Seven were female, representing 29% of the subject pool.

Six of the subjects, or 25%, had some sort of piloting experience, averaging 146 total flight hours. Three of these six subjects had acquired a commercial flying licence, an instrument and a multi-engine rating, with an average of 1133 flight hours. The other three in this group were working toward their private pilot licence, with an average of 37 flight hours. Among these six subjects, three had experience with the FMC, but none with CPDLC.

In terms of familiarity with computers, the subjects were asked to rate whether they were very comfortable, somewhat comfortable or not comfortable with the windows-based setup (in personal computers, unix systems, etc.), the mouse and computer games. The responses to these questions are summarized in Figure 5-1.

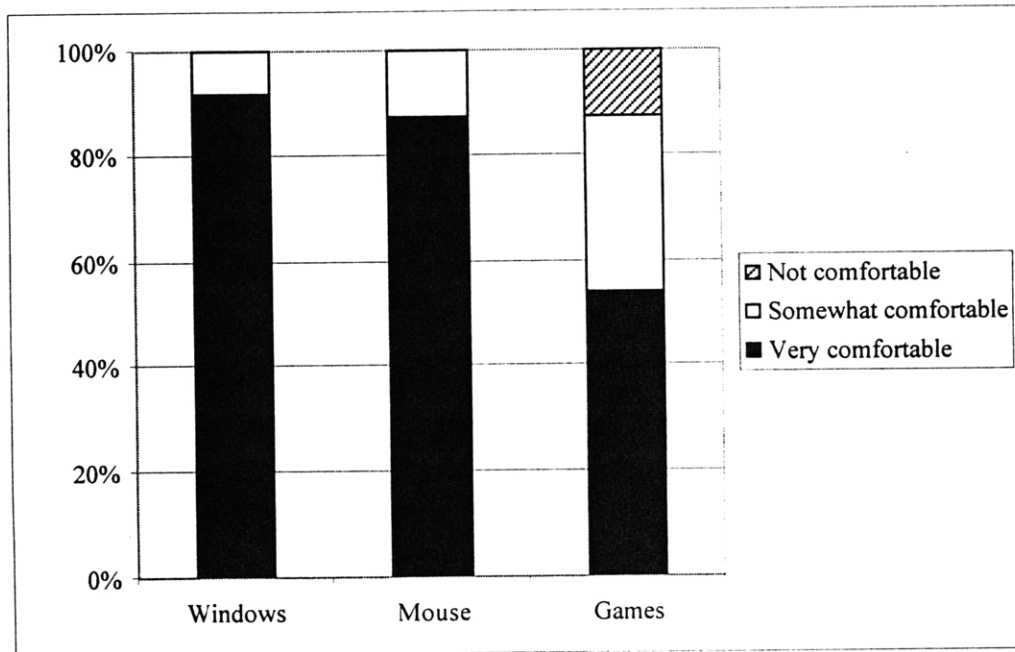

Figure 5-1 Subject Familiarity with Computer Settings

As the experiment was conducted on a Java-platform, with windows-like settings, familiarity with this basic setting would substantially facilitate the training for this experiment. In short, none of the subjects rated themselves as "not comfortable" with the window-based setup or the mouse. The majority of subjects were very comfortable with these two items. As for computer games, over half of all subjects were very comfortable, and only 12.5% rated themselves as not comfortable. Overall, the subjects were comfortable with the basic computer environment in which the experiment was conducted.

5.2 Performance by Task Type

The ensuing discussion of subjects' performance is grouped under the five task categories. As a reminder, the task categories are as follows: simple acceptance, questionable commands, flight-plan cross-checking, pilot-initiated downlinks, and systems-related tasks. In particular, interruptions were introduced in all task categories except the flight-plan cross-checking tasks (to reduce the size of the test matrix). In each task category, subjects' performance is examined in three aspects: task duration (time needed to accomplish the task), accuracy, and efficiency (the ratio of the minimum number of button presses to the actual number).

Note that while the interface configurations may be referred to as first, second, third or fourth for convenience, these do not necessarily reflect the order that these configurations were used. As mentioned before, the exact order through which the subjects used these interface configurations was counterbalanced, and no two subjects used them in the same order.

5.2.1 Simple Acceptance

In simple acceptance tasks, the task content was delivered to the subjects in the form of an incoming message from ATC. At the end of the message, the subjects were instructed to simply accept it as is.

Figure 5-2 shows the average total duration taken to complete simple acceptance tasks. Note that for a specific interface configuration, there is a significant difference in the average times needed to process the tasks on an uninterrupted basis versus an interrupted basis.

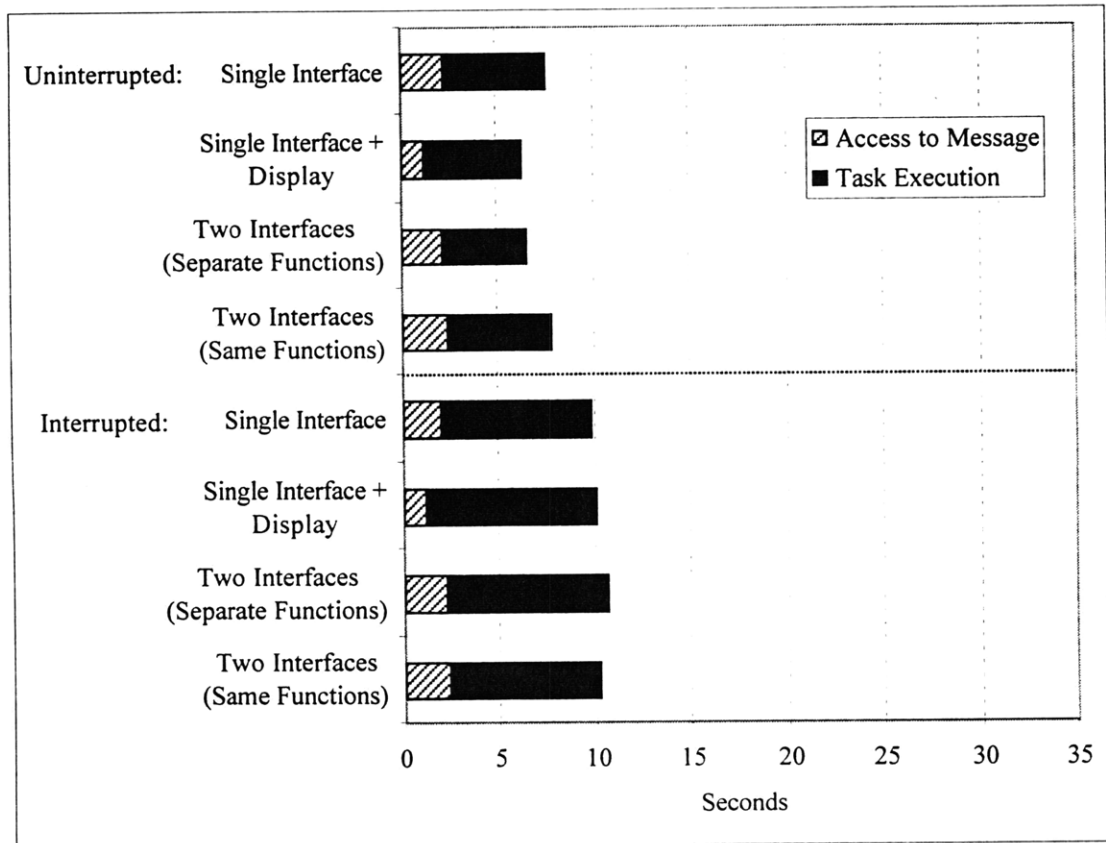

Figure 5-2 Total Duration - Simple Acceptance Tasks

While there appears to be differences in the average times taken to complete the same tasks in different configurations, these differences are not statistically significant at the 5% level ($p > 0.05$).

The accuracy of carrying out the primary tasks, both with or without interruptions, as well as the interruption tasks themselves (denoted by "Interruption"), is shown in Figure 5-3. Most simple acceptance tasks were carried out correctly. The differences in task accuracy among the simple-acceptance tasks and the interruption tasks were not statistically significant ($p < 0.05$), except between the uninterrupted simple-acceptance tasks and those tasks with a 100% task accuracy.

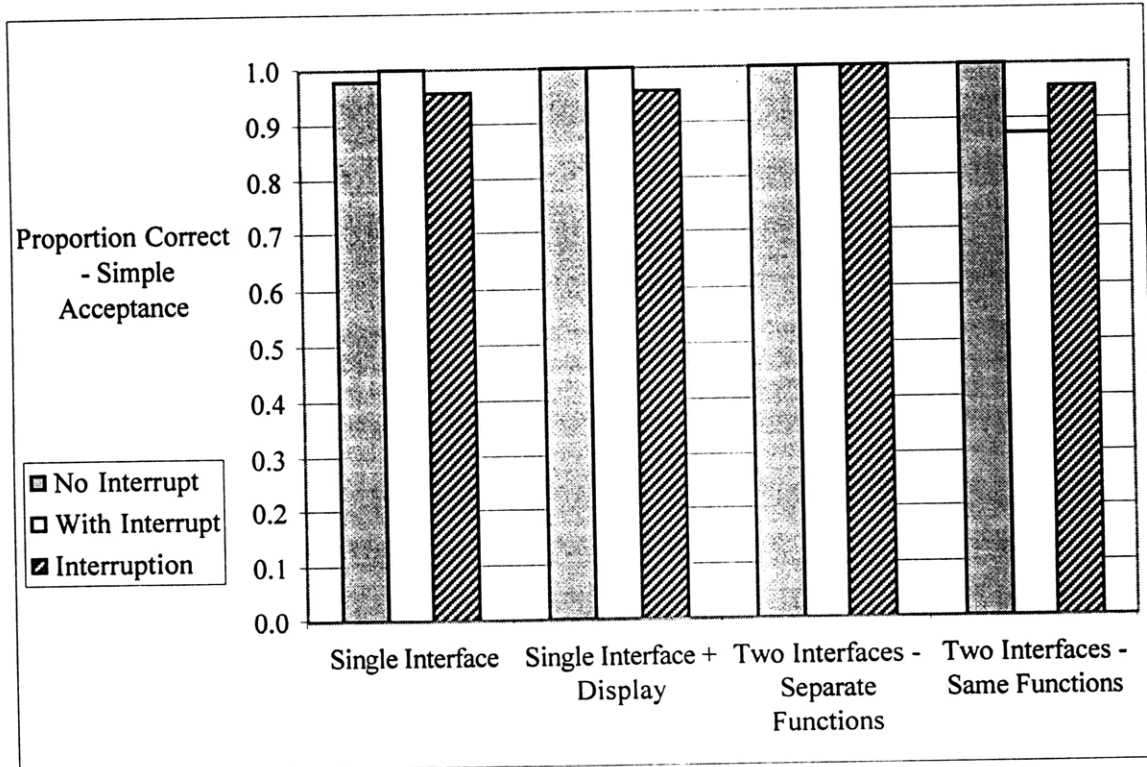

Figure 5-3 Response Accuracy - Simple Acceptance Tasks

For simple acceptance tasks to be conducted in the configuration with two separate sets of interfaces, a minimum of four button pushes was required. For all other configurations, a minimum of five button pushes was required. By counting the total number of button pushes actually performed by the subjects, a measure of task efficiency can be estimated:

$$\text{Task Efficiency} = \frac{\text{Minimum No. of Buttons Pressed}}{\text{Actual No. of Buttons Presses}} \cdot 100\%$$

A task efficiency of 100% then represents the shortest menu navigation path was used to accomplish the task (all the necessary task elements). An efficiency measure much lower than 100% indicates that some sort of unnecessary detour was taken in accomplishing the task (or certain elements of the task).

Figure 5-4 shows the task efficiency for the simple acceptance tasks across different interface configurations. At a first glance at the figure, uninterrupted tasks generally incurred equal or lower task efficiency than interrupted tasks. This is counter-intuitive. However, a more detailed analysis reveals that none of the efficiency measures were in fact significantly different from 100% (the shortest menu navigation path) with ($p < 5\%$).

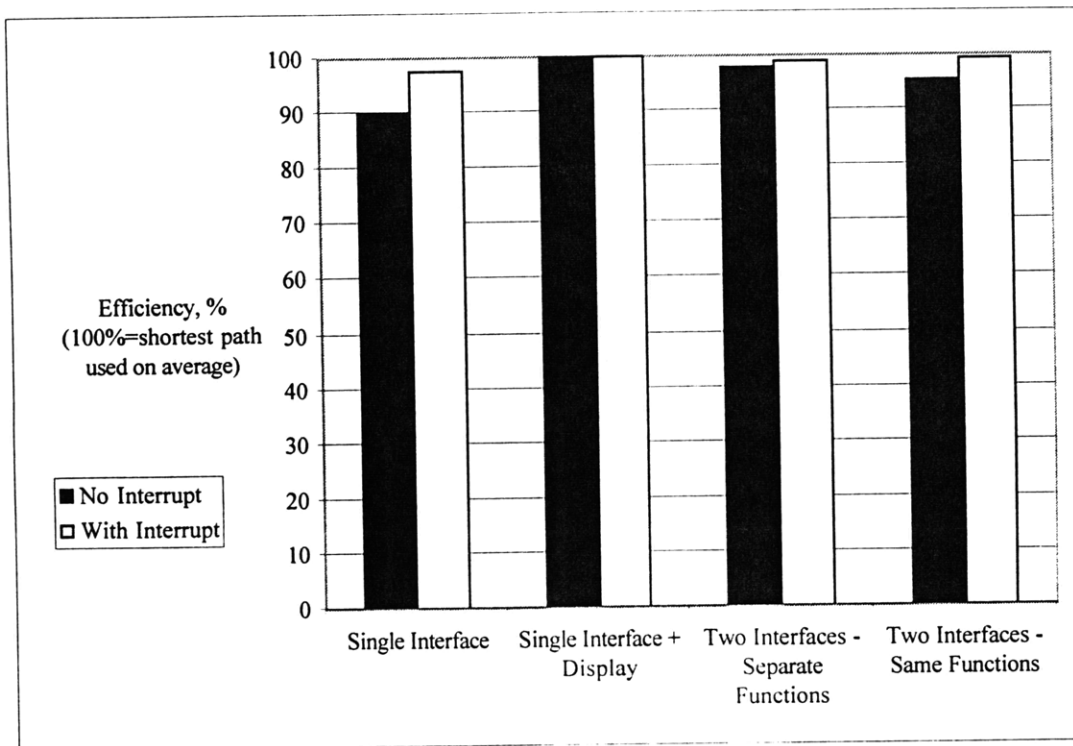

Figure 5-4 Task Efficiency - Simple Acceptance Tasks

5.2.2 Questionable Commands

In the questionable commands, subjects were asked to first check for a relevant piece of information (e.g. maximum speed, maximum altitude, etc.) before responding to ATC's message.

The total time needed to respond to questionable commands was therefore expected to differ among different interface configurations used. As shown in Figure 5-5, this was partially the case. Apart from the difference between the tasks with and without

interruptions, there was a clear and statistically significant ($p < 0.05$) difference in the total times required to respond to questionable commands between using single-interface configurations and dual-interface (same or different functionalities) configurations. Between the two single-interface configurations (first and second), however, the difference is not statistically significant ($p > 0.05$). Between the two dual-interface configurations (third and fourth), the difference was only marginally significant ($p < 0.10$) for uninterrupted tasks.

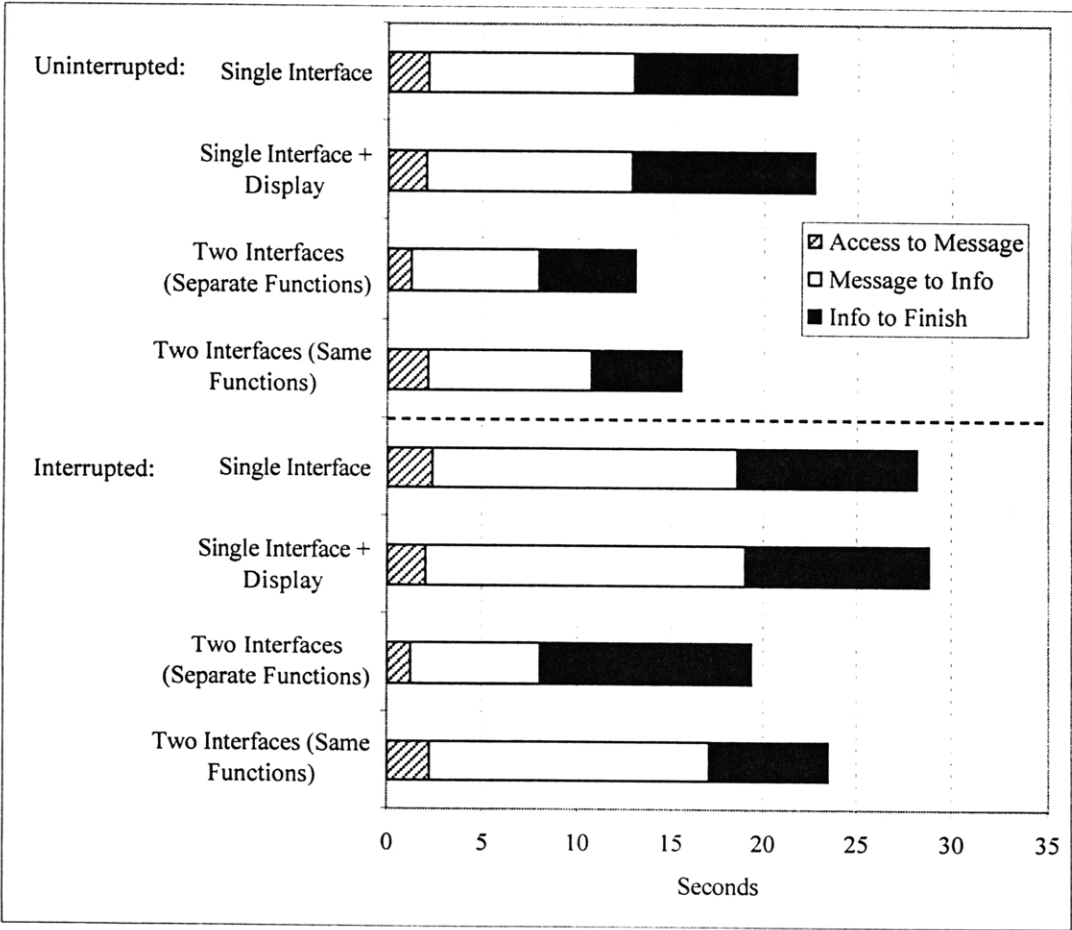

Figure 5-5 Total Duration - Questionable Commands

The time increment as a result of an interruption is roughly the same for all configurations. Note that in all but the third configuration (two interfaces with separate functions), the interruption occurred in the second subtask. In the third configuration, the interruption occurred just at the beginning of the third sub-task, owing to the flattened menu hierarchy of this configuration. This slight difference in the activation of an interruption did not appear to alter the basic pattern of performance for the four configurations examined.

For both the interrupted and uninterrupted cases, the change from single-interface systems to a dual-interface system resulted in an average saving of about 5 to 7 seconds of processing time (from the display of the message content to the completion of the primary tasks). This was equivalent to a reduction of 20% to 40% of the processing time, depending on the exact configuration.

The accuracy of responses to both interrupted and uninterrupted questionable commands is shown in Figure 5-6. Among the interrupted and uninterrupted questionable commands (primary tasks), the near-100% task accuracy rates among the interface configurations were not significantly different from one another, with $p < 0.05$. As well, among the interruption tasks, the task accuracy rates for the four interface configurations were not significantly different from one another ($p < 0.05$), although these rates are much lower than the primary tasks. Contrasting this with the accuracy for interruption tasks illustrated in Figure 5-3 (for simple acceptance tasks) reveals that as the task

complexity increases, the accuracy of the interruption tasks decreases but the accuracy of the primary tasks remains relatively the same.

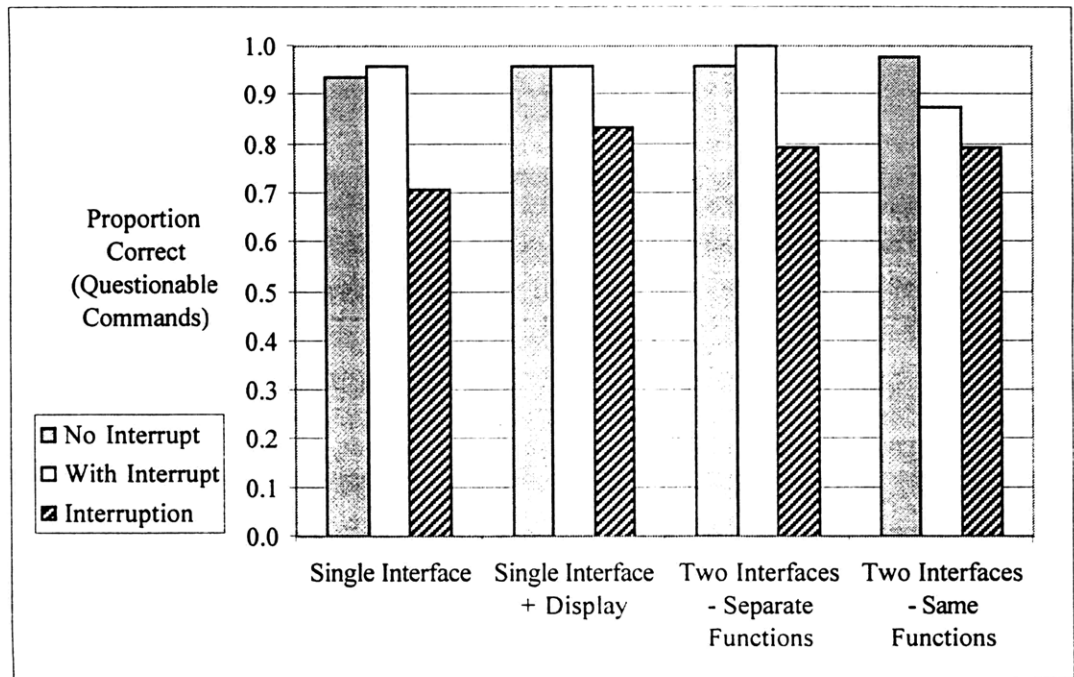

Figure 5-6 Response Accuracy - Questionable Commands

In the first and second configurations (both with a single interface), a minimum of 12 button pushes were required for questionable commands to be appropriately responded. This requirement dropped to 6 for the third configuration, and to 8 for the fourth configuration. For task efficiency, the responses to questionable commands were generally more uniform than those for simple acceptance tasks, as shown in Figure 5-7. In fact, there was no statistically significant differences among different interface configurations in task efficiency.

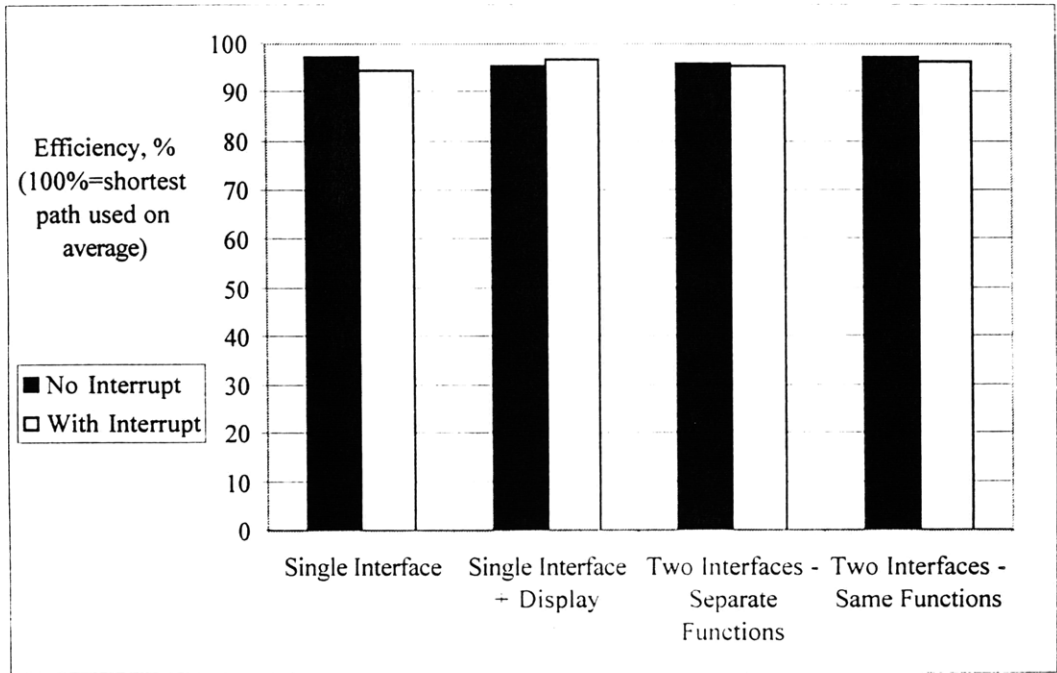

Figure 5-7 Task Efficiency - Questionable Commands

5.2.3 Flight Plan Cross-Checking

The flight plan cross-checking tasks were intended to be the most demanding in terms of time and effort. As such, no interruption tasks were introduced. Most subjects made use of paper and pen to aid in accomplishing this task when only one interface and no additional display was available (first configuration).

As shown in Figure 5-8, the average total time required to respond to a flight-plan cross-checking task using the single-interface configuration was close to 40 seconds, more than 4 times the average needed for a simple acceptance task using the same configuration. The average time needed for the configuration with both a single interface

and an additional display (just under 30 seconds), however, was significantly lower ($p < 0.05$). The average duration required for the two dual-interface configurations were still significantly lower ($p < 0.05$), but the difference between them was not significant (with $p > 0.05$).

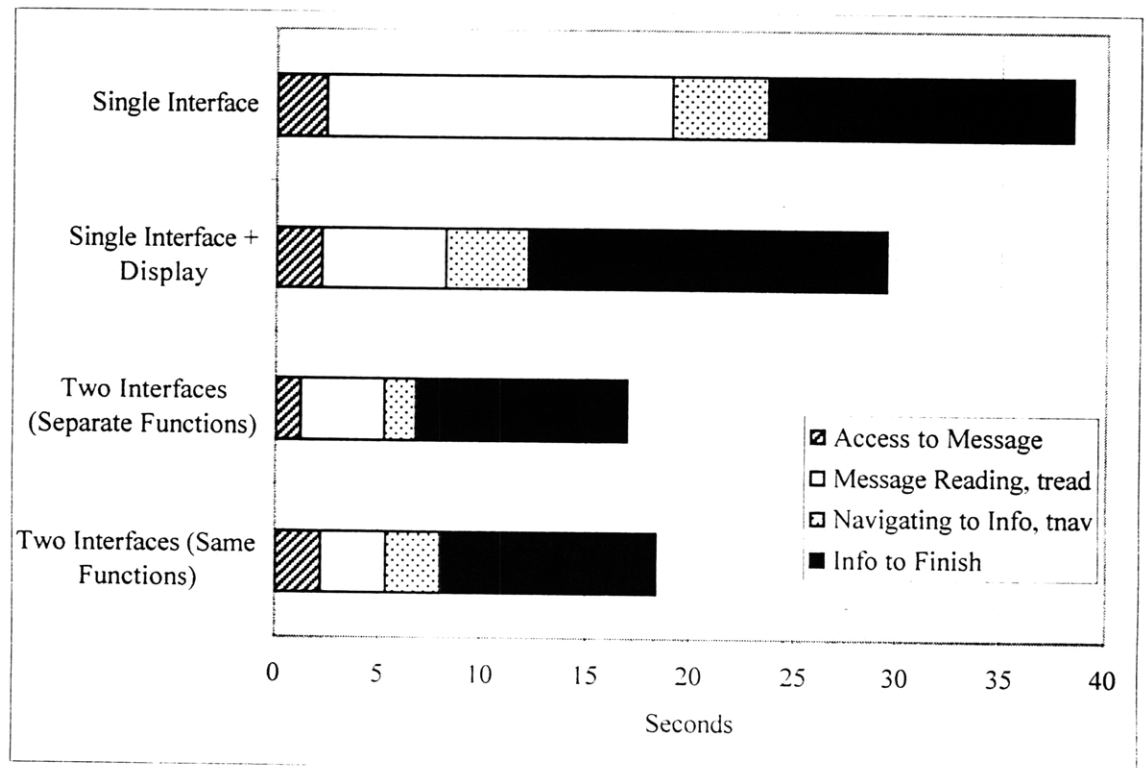

Figure 5-8 Total Duration - Flight Plan Cross-Checking Tasks

For Configuration 1 (single interface only), many subjects opted to write down the flight plan in the ATC message for comparison with the actual one in the FMC, hence the long duration between the display of the message and the access to the flight plan information in the FMC. In the other three configurations, subjects had full access to both the flight plan in the ATC message and the one in the FMC simultaneously. The only difference between the Configuration 2 and the dual interfaces was that in the former, the

display-only screen was not able to display all of the flight plan information at once (and at least one scrolling was needed to view all of the details). It was apparent that this limited display did significantly ($p < 0.05$) lengthen the total time needed to complete the flight-plan cross-checking tasks compared with the dual interfaces.

In Figure 5-8, the sub-task of reading a message and accessing the correct information for an appropriate response was further sub-divided into two tasks: message reading (from the display of the message to the first button-push thereafter), and navigating to the necessary information (from first button-push after the display of the message to the display of the necessary information). Let the average time taken to perform these two subtasks as t_{read} and t_{nav} respectively. Then, from moving to a single-interface (configuration 1) to an additional display-only screen (configuration 2), t_{read} was reduced by 63% and t_{nav} by 17%. Meanwhile, the time from the access of information to the completion of the communication task, t_{finish} , however, increased by about 15% in moving from configurations 1 to 2. The total average time saving for the sum of t_{read} , t_{nav} and t_{finish} in moving from configurations 1 to 2 was about 25%.

In moving from configurations 2 to 3 (two interfaces, separate functions), t_{read} was further reduced by 23%, t_{nav} by 59%, and t_{finish} by 42% (compared to the processing times for configuration 2). The total average time saving for the sum of t_{read} , t_{nav} and t_{finish} in moving from configurations 2 to 3 was about 43%. In total, moving from configuration 1 to 3 reduced the sum of t_{read} , t_{nav} and t_{finish} by 66% (more than a half).

In contrast, there was little difference in the average time requirements between configurations 3 and 4. The difference between these two was less than 10% (of each other). The additional flexibility in menu navigation provided in configuration 4 therefore did not translate into additional reduction in processing time.

In terms of the accuracy of response, the results for the flight plan cross-checking tasks were also quite different from those for the questionable commands. As shown in Figure 5-9, the lowest task accuracy (just below 90% correct) for flight plan cross-checking was recorded in the second interface configuration (single interface and display). This was followed by the first configuration (single interface alone), with just under 92% of this group of tasks correctly accomplished. While these accuracy rates are not significantly different from one another ($p > 0.05$), these rates as a whole did appear to be lower compared with other communication tasks examined.

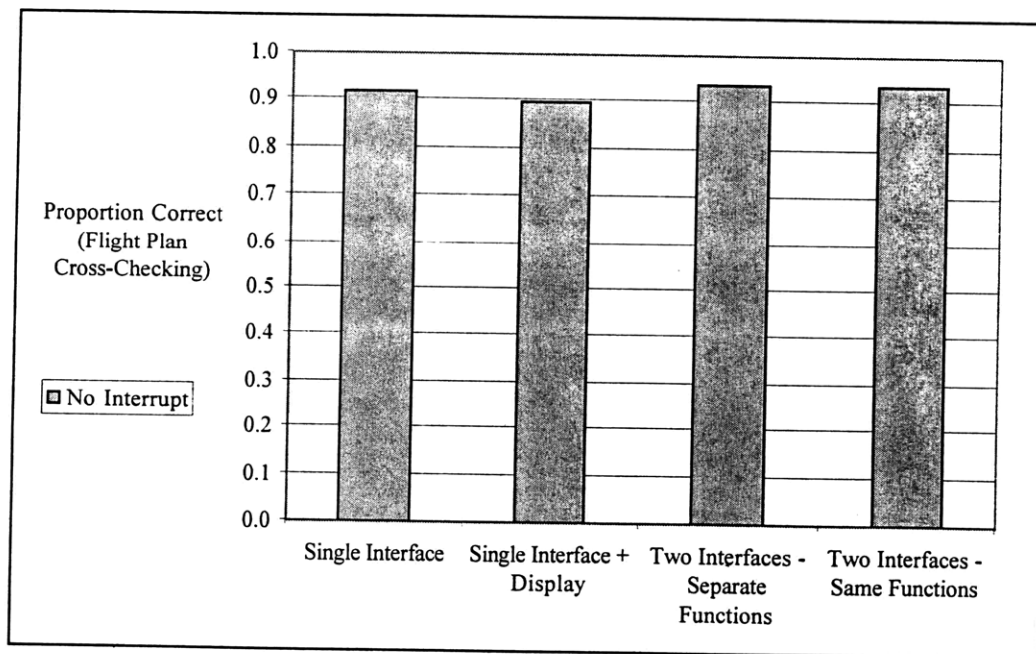

Figure 5-9 Response Accuracy - Flight Plan Cross-Checking Tasks

The flight plan cross-checking tasks required a minimum of 12 button pushes for the two single-interface configurations (first and second), and 6 and 8 button pushes for the third and fourth configurations respectively. Note that the use of the scroll-bar was not considered a button push in this experiment as it did not generate a "new" page *per se*. As shown in Figure 5-10, the task efficiency measures for this group of tasks were all significantly below 100% (with $p < 0.05$). This in general reflected the repeated visits to the flight plan information page by the subjects. Interestingly, the task efficiency as measured by the total number of button presses for the third configuration (two interfaces, separate functionalities) was lowest among the four configurations, but led to both a high accuracy and short task processing time. In comparison, the second configuration (one interface with an additional display) had the highest efficiency but resulted in fewer correct responses and a longer total time requirement than the dual-interface configurations.

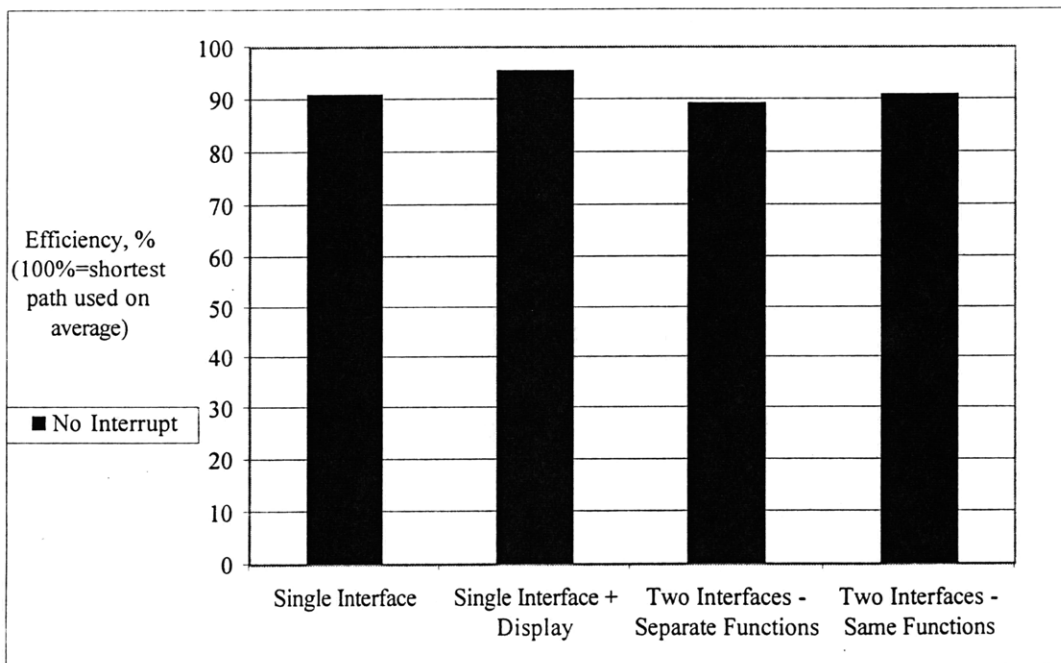

Figure 5-10 Task Efficiency - Flight Plan Cross-Checking Tasks

5.2.4 Pilot-Initiated Downlinks

Instead of being incorporated in the ATC message, the task messages of pilot-initiated downlinks appeared in the form of a prompt display at the start of the task. Subjects carried out the tasks without having to first display the incoming message. The difficulty here involved recognizing certain key words in the task message and relating these key words to the menu hierarchy of the interface configurations. In terms of the total time required for the tasks, Figure 5-11 shows that there is a slight difference in using single-interface versus dual-interface configurations.

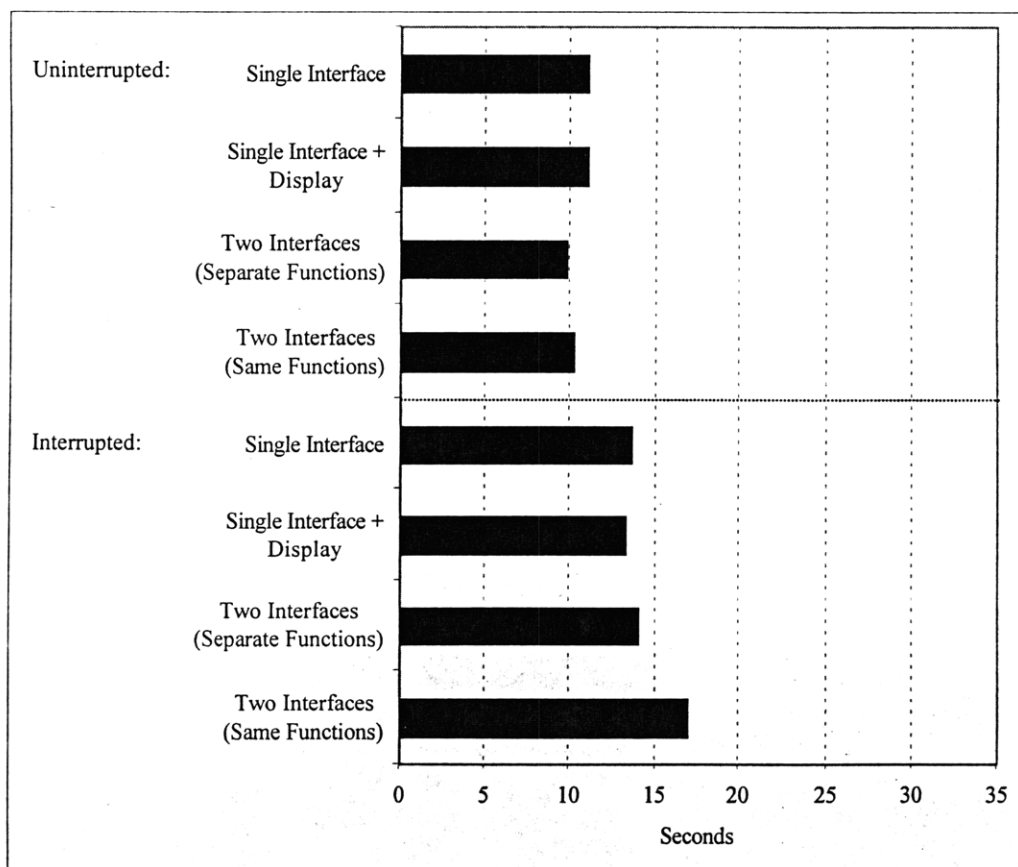

Figure 5-11 Total Duration - Pilot-Initiated Downlinks

In Figure 5-11, the tasks were not broken into subtasks, as there was no need for subjects to access the message content (the task was presented in the prompt display at the beginning), and there was no need to look for certain pieces of information before responding. In general, the difference among the uninterrupted, pilot-initiated downlink tasks was not statistically significant (with $p > 0.05$). The only statistically significant ($p < 0.05$) differences were in the interrupted tasks, between Configuration 4 (dual-interface, same functions) and Configuration 1 (single-interface only), and between Configuration 4 and Configuration 2 (single-interface with display-only screen).

In terms of task accuracy, pilot-initiated downlink tasks were almost always carried out accurately. As illustrated in Figure 5-12, there was no statistically significant difference in task accuracy among the four configurations ($p < 0.05$).

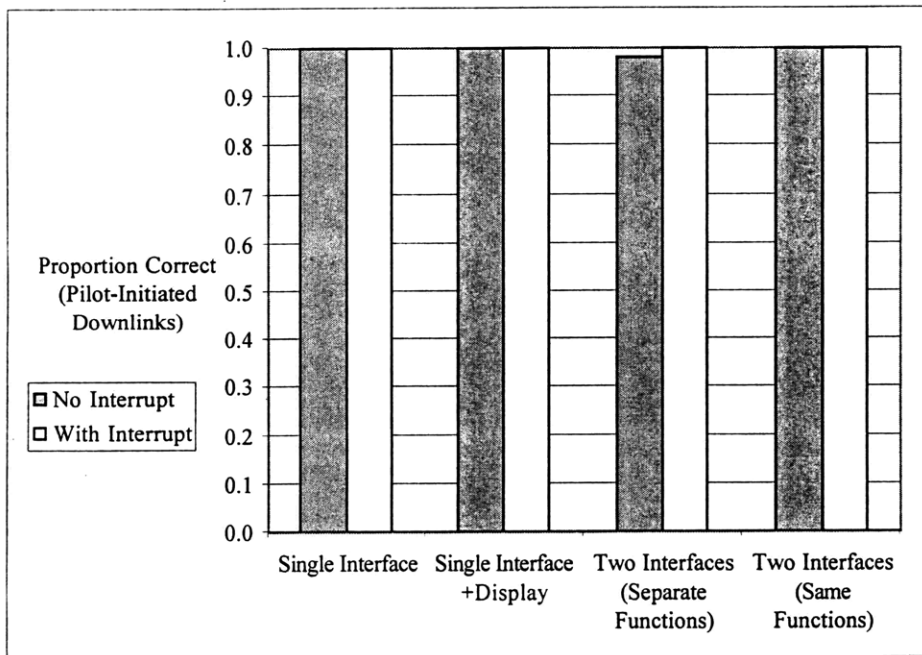

Figure 5-12 Task Accuracy - Pilot-Initiated Downlinks

In terms of efficiency, the results are shown in Figure 5-13. Here, the minimum number of button presses needed for the third configuration (dual-interface with separate functions) was four, and was five for the other configurations. Interestingly, the interrupted tasks had a higher efficiency than the uninterrupted ones, in spite of the longer total duration for the former. In particular, the task efficiency measures for the uninterrupted tasks were significantly below a 100% efficiency (with $p < 0.05$). As for the interrupted tasks, none was significantly different from 100% ($p > 0.05$).

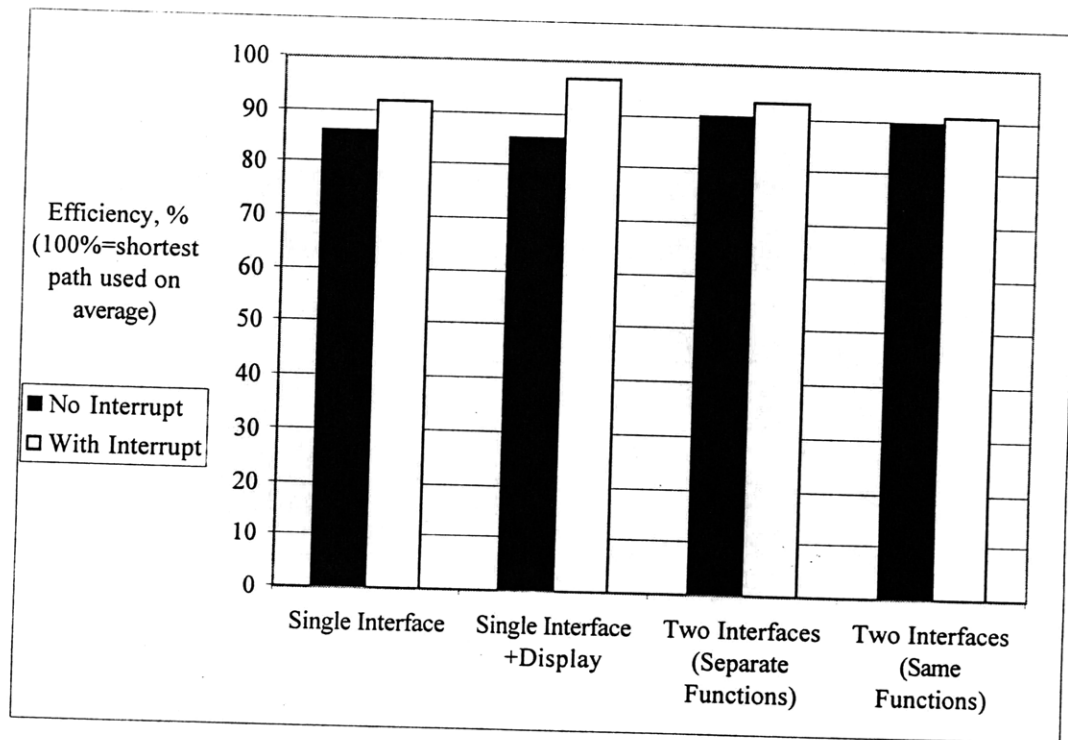

Figure 5-13 Task Efficiency - Pilot-Initiated Downlinks

5.2.5 Systems-Related Tasks

Apart from tasks directly related communications with ATC, a few non-communication tasks were inserted to make the experiment more realistic. Similar to

pilot-initiated downlinks, these systems-related tasks did not require that the subjects first display an incoming message.

Figure 5-14 shows the total duration taken for the systems-related tasks (none interrupted). Again, the processing time was not divided into sub-tasks as there was no need for the subjects to navigate to the message display and to navigate to the necessary pieces of information. The differences in total duration among the four interface configurations were apparently not statistically significant at the 5% level.

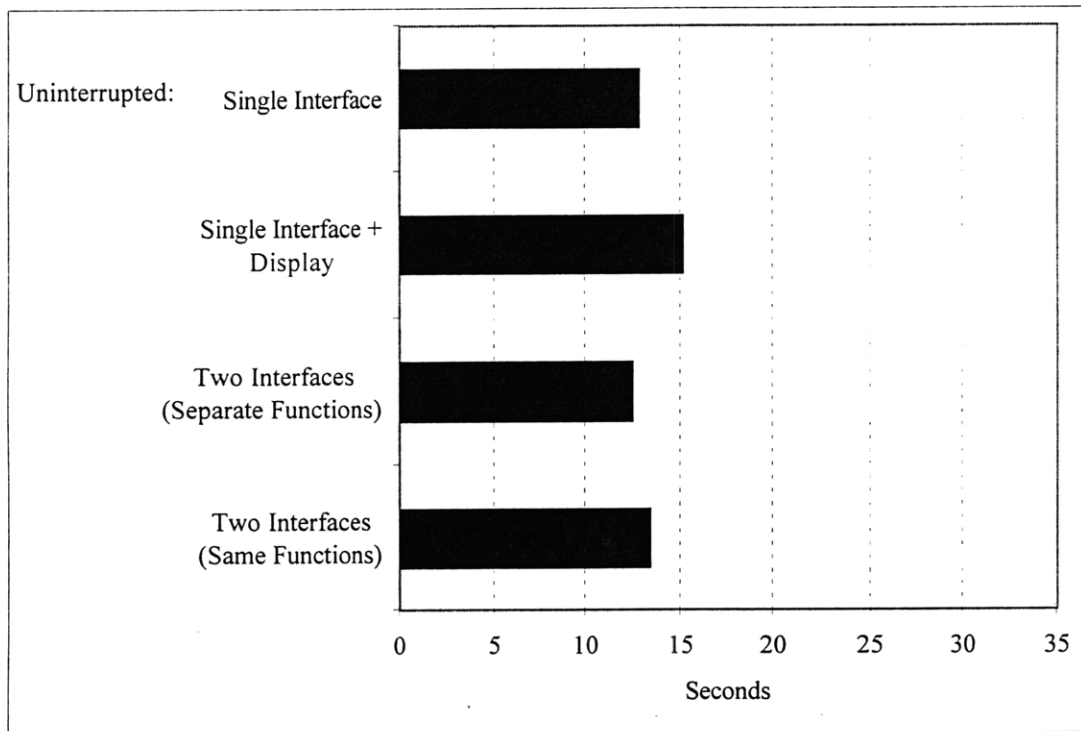

Figure 5-14 Total Duration - Systems-Related Tasks

Similar to the pilot-initiated downlinks, almost all of the systems-related tasks were carried out correctly. None differed significantly from 100% at $p = 0.05$. This is illustrated in Figure 5-15.

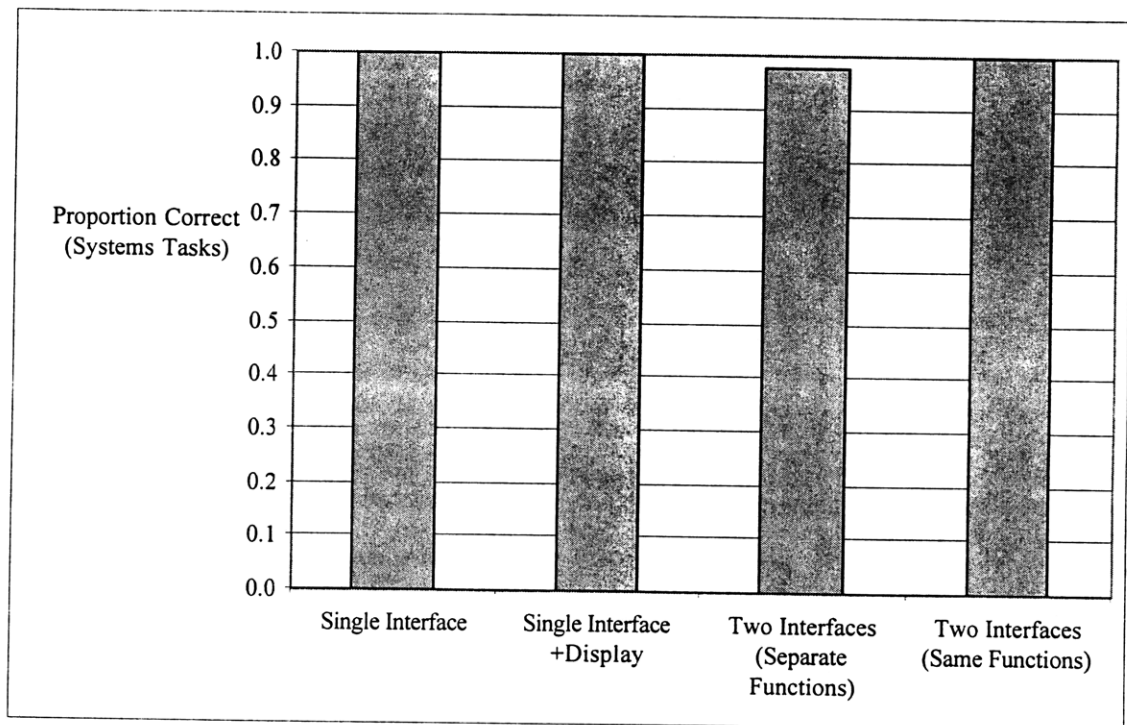

Figure 5-15 Task Accuracy - Systems-Related Tasks

In terms of task efficiency, however, the results for the systems-related tasks were all significantly lower than 100%. As shown in Figure 5-16, the configuration with a single interface and an additional display incurred the lowest task efficiency in systems-related tasks (significantly different from the other configurations, with $p < 0.05$). This was indeed unexpected, as both single-interface configurations have exactly the same menu hierarchy. As a whole, the task efficiency rates for all four configurations were significantly different from 100% ($p < 0.05$).

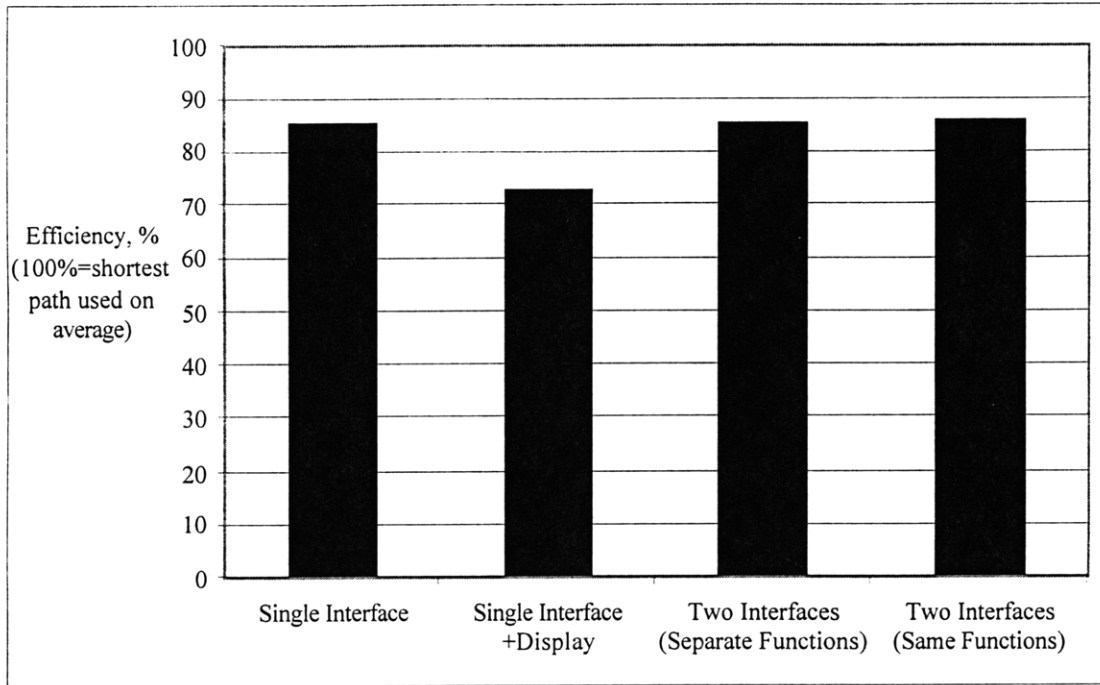

Figure 5-16 Task Efficiency - Systems-Related Tasks

5.3 Overall Impact of Button-Pushes

A question arises whether or not, on average, the impact on task processing times is affected more by the specific interface hardware arrangement or by the depth of the menu hierarchy (and hence the number of button-pushes). As shown in the last section, the performance of a specific interface configuration depends largely on the type of tasks it is used to accomplish.

One approach to shed light on this question is to examine the average time needed for each button pressed using the four different interface configurations. An ordinary least-squares regression was performed on this expression:

$$T = \alpha_1BP_1 + \alpha_2BP_2 + \alpha_3BP_3 + \alpha_4BP_4 + \alpha_5Interrupt + \varepsilon$$

Where T = total time required to process a CPDLC task

BP_i = total number of button-presses (excluding interruption tasks) for configuration i, as defined in Chapter 4

α_i = parameters to be estimated, for all i in the equation

Interrupt = dummy variable, set to 1 when the task was interrupted, 0 otherwise

ε = stochastic error with zero mean and unrelated to the explanatory variables

The estimation outputs of the above regression model are shown in Table 5-1 below.

Table 5-1 Regression Estimates

	Multiple R ² =0.745	R ² = 0.545	Adjusted R ² =0.543	Obs.: 1248
Estimates:	Estimated Value	Standard Error	t-Statistic	P - Value
α ₁	1.945	0.039	49.582	0.000
α ₂	1.836	0.040	46.365	0.000
α ₃	2.140	0.069	31.073	0.000
α ₄	1.776	0.053	33.473	0.000
α ₅	1.887	0.411	4.596	0.000

As a result of the variety of tasks involved, the R^2 and adjusted R^2 values are not very high. However, all of the coefficients are statistically significant at $p = 0.05$. Based on the results of the regression analysis, then, there is a statistically significant change in the average time of button-pushes when changing from one interface configuration to another. With the same hierarchy, the difference in total processing time is therefore expected to increase with increasing number of button-pushes required. Nevertheless, the estimated coefficients of α_1 through α_4 are not far apart from one another, especially in light of the average human reaction time of about 0.5 second. Given a communication task requiring a small number of button-pushes (e.g. under 2 button-pushes to complete), a reduction in processing time achieved by switching from one interface configuration to another may be comparable (in magnitude) with a reduction in processing time achieved by reducing the depth of menu hierarchy in the same interface configuration (thereby reducing the number of button-pushes needed).

5.4 Subjective Workload

An important issue that has not been examined so far in the discussion of interface performance is the amount of subjective workload experienced by the subject. While the amount of processing time is important, the subjects in the study were fully aware that their primary task was communication. In contrast, the primary task for pilots is flying, with both surveillance of nearby traffic and navigation of the airplane having higher priorities in many cases than communication with ATC. The design objective of a

CPDLC interface is therefore to minimize the amount of workload that communication tasks would impose on the pilots.

As part of the NASA TLX questions, the subjective mental and physical workload experienced by the subjects were surveyed. The results are shown in Figure 5-17. The maximum rating for individual components (e.g. mental, physical, etc.) of the TLX scale is 33.33. In this light, the subjects did not on average feel overloaded with tasks. In particular, there was no significant difference between the ratings for subjective physical and mental workload. However, the pattern observed for the mental workload rating is reminiscent of the processing times of the more demanding tasks (e.g. questionable commands, flight-plan cross-checking).

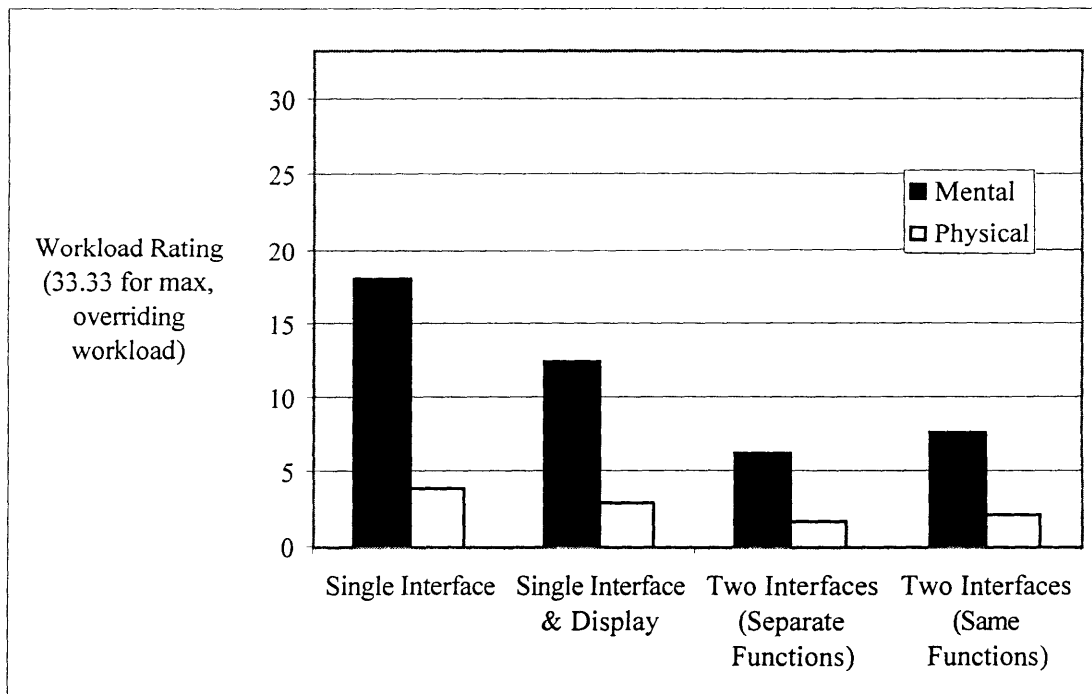

Figure 5-17 Mental versus Physical Subjective Workload

Figure 5-18 shows the results for the composite NASA TLX scale. The pattern observed here is again reminiscent of the processing times for the more difficult tasks, and of the mental workload rating. Configuration 3 (with dual-interface with separate functions) on average was rated to have the least amount of workload among the four interface configurations investigated, according to the NASA TLX scale.

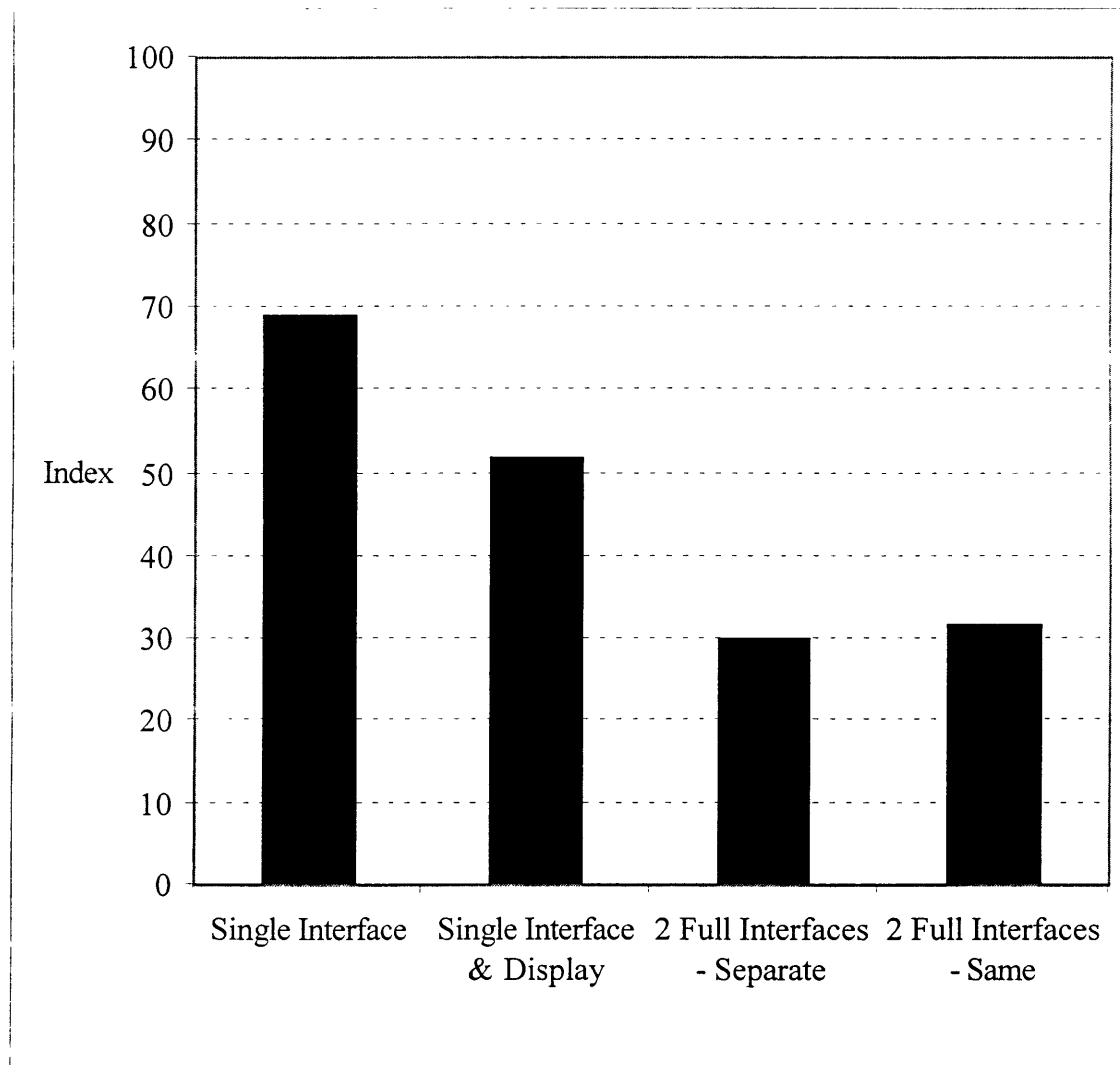

Figure 5-18 Mean Composite NASA-TLX Rating

This page intentionally left blank

6. CONCLUSIONS

As part of the architecture for the Future Air Navigation System (FANS), air-ground data link has proved to be extremely useful in two ways. First it simplifies the transmission and receipt of routine, complicated messages. Second, the use of compressed, digitized data transmission renders the use of satellite communication technologies cost-effective. As well, these two advantages combined with global positioning system (GPS) satellites drastically reduce the need for terrestrial-based communication, navigation and surveillance facilities. As a consequence, data link has been used relatively extensively for communication between aircraft and airline operations centers (AOC), and its use is slowly increasing in use for communication between aircraft and air traffic control (ATC), especially for the oceanic flight regimes. Meanwhile, different flight deck interface designs for controller-pilot data link communication (CPDLC) are emerging, and there is no coherent understanding on the fundamental trade-offs between interface designs and performance.

The three flight deck CPDLC interface configurations are the MCDU (multiple control and display unit)-based system, the DCDU (data-link control and display unit)-based system and the MFD (multi-function display)-based system. The MCDU-based interface encompasses all the CPDLC functions on one interface component - the MCDU. In contrast, the DCDU-based system features a dedicated interface for CPDLC functions only, and includes the MCDU for text entry and access to the FMC. The MFD-

based interface is an intermediate between these two, featuring an MFD that is dedicated for CPDLC and other electronic display functions.

An examination of the common CPDLC communication tasks, together with processing times recorded at the Boeing Engineering Simulator, revealed the comparative merits and shortcomings of each design. The MCDU-based system requires the least amount of button-presses and the shortest duration for processing communication tasks with a substantial amount of alphanumeric entry. The larger screen of the MFD allows a "shallower" menu hierarchy and more command options to be displayed on the same page than the other two interfaces, and hence resulted in an overall time saving. Based on estimates from publicly available promotional literature, the DCDU-based system is expected to require the least amount of button-presses in responding to simple ATC messages. However, the necessity for pilots to shift between the DCDU and the MCDU for text entry and FMC-related tasks incurs penalties in the total duration of these tasks. The prime advantage of the dedicated DCDU, and to a lesser extent, the MFD, is that it allows pilots simultaneous access to the FMC and other airplane system information while responding to or initiating ATC messages.

The results from the study of the three flight deck interfaces were in fact influenced by three factors: the physical arrangement of the communications interfaces, the design of interface components, and the software of the menu hierarchy in these interfaces. An interface experiment was designed to examine the effect of the design of interface components, keeping both the physical arrangement of the interfaces and the

menu hierarchy essentially the same. A total of twenty-four subjects were recruited from the MIT community and asked to perform a series of CPDLC tasks using four simplified interface configurations. These four configurations were: a single interface only (resembling the MCDU), a single interface with an additional display-only screen (resembling the MFD), a dual-interface system with dedicated functions on each interface (resembling the DCDU), and a dual-interface system with the same full set of functions accessible on both interfaces.

Specifically, it is hypothesized that given the same amount of information required to be accessed in a particular task, an increase in the number of available interface components to access the required information elements allows a "shallower" menu hierarchy to be developed. The shallower menu hierarchy is in turn expected to correlate with a reduced level of subjective workload, which likely amounts to shorter processing times and increased accuracy. However, subjects need to have a global awareness of all the relevant interfaces and of how to manage them to accomplish the stated tasks. In turn, this need for a global awareness and management increases with the number of available interfaces, and incurs time penalties for the subjects to decide which interfaces to use, and in what sequence. Beyond a certain point, the performance gains (e.g. processing times) in using more interfaces would be overwhelmed by the associated negative impact (e.g. time penalties for a global management of the interface use).

For simple tasks, the interface experiment did not find significant performance differences among the various interface configurations, in total processing time, task

accuracy and task efficiency (the minimum number of buttons pressed divided by the actual number of buttons pressed). For tasks that require subjects to look for specific information outside of the communication mode (e.g. confirming questionable commands, and cross-checking flight plans), a performance pattern emerged in which the single-interface systems required significantly longer processing times than the dual-interface systems. In terms of task efficiency and accuracy, however, there were no significant differences among the different configurations. In general, however, the collective task efficiencies and accuracies tended to decrease in more complicated tasks.

The subjective workload of using different interface configurations as measured with the NASA Task Load Index showed decreasing workload experienced from the single-interface systems to the dual-interface systems (highest for the single-interface system, next highest for the single-interface system with an additional display-only screen, etc.). As with the processing times observed in more complicated tasks, the dual-interface system with separate functions in each interface component appeared to be the most desirable (lowest workload and shortest processing times).

In investigating the relative impact of a shallower menu hierarchy and the effect of interface hardware, a regression analysis was performed to ascertain whether the time incurred for each button-press differs among the interface configurations. While the differences among the interface configurations in the time attributed to each button-press were found to be statistically significant, the magnitudes of the differences were small (within 1 second). This points to the fact that given a communication task requiring a

small number of button-presses to accomplish, making the menu hierarchy shallower may improve the performance of an interface configuration more than changing to a different interface configuration altogether. However, to accomplish a communication task requiring a large number of button-presses in high work-load situations, the use of different interface configurations (together with the accompanying change in the depth of menu hierarchies) may significantly reduce the task processing time.

This page intentionally left blank.

REFERENCES

- Abbott, T. S. (1997) A comparison of two control display unit concepts on flight management system training. *NASA Technical Memorandum 4744*, NASA Langley Research Center, Hampton, VA.
- Adam, G. L., Kelley, D. R. and Steinbacher, J. G. (1994) Reports by airline pilots on airport surface operations: Part 1. Identified problems and proposed solutions for surface navigation and communications. The MITRE Corporation MTR94W60, McLean, VA.
- Airbus Industrie (1998) *A330/A340, A319/A320/A321 Airbus Interoperable Modular – Future Air Navigation System presentation*. Presentation. October.
- Allen, D. (1998). Operator benefits of Future Air Navigation Systems, *Aero*, Boeing Commercial Airplane Group, No. 2, April, pp. 37-41.
- Bailey, J. and Phelan, P. (1992) Pacific Progress, *Flight International*, Vol. 141 No. 4311, March 25-31, pp. 24-26.
- Battiste, V. and Bortolussi, M. (1988) Transport pilot workload - a comparison of two subjective techniques. *Proceedings of the Human Factors Society 32nd Annual Meeting*, pp. 150-154.
- Billings, C. E. and Cheaney, E. S. (1981) *Information Transfer Problems in the Aviation System*, NASA Technical Paper TP-1875.
- Boeing Commercial Airplanes Group (1996) *ATC Terminal Data Link Benefits Study*, Internal Documentation, Flight Deck Engineering - Crew Operations Communications, Everett, WA.
- Boeing Commercial Airplanes Group (1998) *FAN Tips – 747-400 and 777 versions (Draft)*. Everett, WA.
- Campbell, S. D. and Martin, R. C. (1993) Dissemination of terminal weather products to the flight deck via data link, *Fifth International Conference on Aviation Weather Systems*, Vianne, VA, American Meteorological Society, August 2-6, pp. 348-352.
- Chandra, D. C. (1997) Pilot evaluation of data link services for general aviation, *Proceedings of the Ninth International Symposium on Aviation Psychology*, Columbus, OH, Ohio State University, April 27 - May 1, pp.679-684.
- Cooper, G. E., and Harper, R. P. (1969) *The use of pilot ratings in the evaluation of aircraft handling qualities* (NASA Technical Report TN D-5153). Washington, D. C., National Aeronautics and Space Administration.

- Corwin, W. H. (1991) Data link integration in commercial transport operations. *Proceedings of the Sixth International Symposium on Aviation Psychology*, Columbus, OH, April 29 - May 2, pp. 145-153.
- Cresswell-Starr, A. F. (1993) 'Is control by voice the right answer for the avionics environment?' In Baber, C. and Noyes, J. M. (Eds) *Interactive Speech Technology: Human Factors in the Application of Speech Input/Output to Computers*, Taylor Francis: London.
- Fan, T., Hyams, D. and Kuchar, J. (1998a) Study of In-flight Replanning Decision Aids, *AIAA Guidance, Navigation and Control Conference and Exhibit - Collection of Technical Papers*, AIAA-98-4294, Part 2, Boston, MA, American Institute of Aeronautics and Astronautics, August 10-12, pp. 980-988.
- Fan, T., Hyams, D. and Kuchar, J. (1998b) *Preliminary Study of In-flight Replanning Performed on the Flight Deck*, National Center of Excellence in Aviation Operations Research, NEXTOR Report RR-98-4, MIT, Cambridge, MA, April 30.
- Fan, W., Zhang, J., Tian, Z. and Bi, X. (1996) Implementation of VHF data link for civil aviation in China, *Proceedings of the IEEE 1996 Position, Location and Navigation Symposium*, Atlanta, GA, Institute of Electrical and Electronics Engineers, April 22-26, pp. 188-190.
- Farley, T.C. (1999) *An Experimental Study of the Effect of Shared Information on Pilot/Controller Re-Route Negotiation*, Master of Science Thesis, Department of Aeronautics and Astronautics, Massachusetts Institute of Technology, Cambridge, MA.
- Federal Aviation Administration (1998). *National Airspace Systems Architecture*. FAA Office of System Architecture and Investment Analysis (ASD-1), Federal Aviation Administration, Washington, D.C.
- Fisher, D. L., Moss, S. M. and Yungkurth, E. (1989) Menu navigation: minimizing the time to find a terminal option. *Advances in instrumentation and control - Proceedings of the Instrument Society of America International Conference and Exhibition '98*, Vol. 44 Part 3, pp.971-978.
- Fisher, D. L., Moss, S. M. and Yungkurth, E. (1990). Optimal menu hierarchy design: syntax and semantics. *Human Factors*, Vol. 32, No. 6, pp.665-683.
- Hansman, R. J., Kuchar, J. K., Clarke, J. P., Vakil, S. V., Barhydt, R., and Pritchett, A. R. (1997). Integrated human-centered systems approach to the development of advanced air traffic management systems. First USA/Europe Air Traffic Management Research and Development Seminar, Saclay, France.

Hart, S. G. (1986). Theory and measurement of human workload. In J. Zeidner (Ed.), *Human productivity enhancement: Training and Human Factors in Systems Design*, vol. 1, pp. 396-456. New York: Praeger.

Hart, S. G., Battiste, V. and Lester, P. T. (1984). POPCORN: A supervisory control simulation for workload and performance research, *Proceedings of the 20th Annual Conference on Manual Control*, pp.431-454. Washington, D.C.: NASA (NASA CP-2341).

Hart, S. G. and Staveland, L. (1988). Development of the NASA task load index (TLX): Results of empirical and theoretical research. In P. A. Hancock and N. Meshkati (Eds.), *Human Mental Workload*, pp. 139-183. Amsterdam: North-Holland.

Hayworth, L. A., Bivens, C. C. and Shively, R. J. (1987). An investigation of single-pilot advanced cockpit and control configurations for nap-of-the-earth helicopter combat mission task. *Proceedings of the 1986 Meeting of the American Helicopter Society*, pp.657-672. Washington, D.C.: American Helicopter Society.

Infield, S., Palen, L., Pepitone, D., Kimball, S., Smith, D., Possolo, A., Corker, K. and Lozito, S. (1994). The effects of ATC datalink on instrument and environmental scanning during flight operations, *Human Factors in Aviation Operations: Proceedings of the 21st Conference of the European Association for Aviation Psychology (EAAP)*, Vol. 3, Eds. Fuller, R., Johnston, N. and McDonald, N., Dublin, Ireland, pp. 63-68.

International Air Transport Association (1995). *FANS-CNS/ATM User Driven Implementation Plans for Asia and Pacific Region*, Second Edition, July, 1, Singapore, pp. 7-12.

International Civil Aviation Organization (1988). *Report of the Fourth Meeting of the Special Committee on Future Air Navigation Systems*, Document 9524, FANS-4, International Civil Aviation Organization, Montréal, Canada.

Kerns, K. (1990). *Data Link Communication between Controllers and Pilots: A Review and Synthesis of the Simulation Literature*, MITRE Corporation Publication MP - 90W00027, McLean, VA.

Kilmer, K. J., Knapp, R., Burdsal, C. Jr., Borrensens, R., Bateman, R. and Malzahn, D. (1988). Techniques of subjective assessment: a comparison of the SWAT and modified Cooper-Harper scales. *Proceedings of the Human Factors Society 32nd Annual Meeting*, vol. 1, pp.155-159.

Lee, E. and MacGregor, J. (1985). Minimizing user search time in menu retrieval systems. *Human Factors*, Vol. 27, No. 2, pp.157-162.

Lind, A. T., Dershowitz, A and Bussolari, S. R. (1994). *The influence of data link-provided graphical weather on pilot decision-making*, U. S. Department of Transportation - Federal Aviation Administration RD-94/9 or Massachusetts Institute of Technology-ATC-215.

Logsdon, E. W., Lozito, S., Mackintosh, M, McGann, A., Infield, S. E. and Possolo, A. (1995). Cockpit data link technology and flight crew communication procedures, *Proceedings of the Eighth International Symposium on Aviation Psychology*, Columbus, OH, April 24-27, Vol. 1, pp. 324-329.

Lozito, S., McGann, A. and Corker, K. (1993). Data link air traffic control and flight deck environments - Experiment in flight crew performance, *Proceedings of the Seventh International Symposium on Aviation Psychology*, Columbus, OH, April 26-29, Vol. 2, pp.1009-1015.

McKinlay, R. A. (1996). Data-link comes of age? *Proceedings of the Conference on Data-link Applications*, London, Royal Aeronautical Society, October 30, pp. 1-6.

Midkiff, A. H. and Hansman, R. J. Jr. (1992). Identification of important "party line" information elements and the implications for situation awareness in datalink environment, *Proceedings of the Aerotech'92 Conference - Enhanced situation awareness technology for retrofit and advanced cockpit design*. Anaheim, CA, October 5-8, Society of Automotive Engineers, pp. 141-154.

Miller, D. P. (1981). The depth/breadth tradeoff in hierarchical computer menus. *Proceedings of the Human Factors Society 25th Annual Meeting*, pp.296-300.

Mohageg (1992) The influence of hypertext linking structures on the efficiency of information retrieval. *Human Factors*, Vol. 34, No. 3, pp.351-367.

Moroney, W. F., Biers, D. W., Eggemeier, F. T. and Mitchell, J. A. (1992) A comparison of two scoring procedures with the NASA task load index in a simulated flight task. *Proceedings of the IEEE 1992 National Aerospace and Electronics Conference*, pp.734-740. Dayton, OH: IEEE.

Nygren, T. E. (1991) Psychometric properties of subjective workload measurement techniques: Implications for their use in the assessment of perceived mental workload. *Human Factors*, Vol. 33, No. 1, pp.17-33.

Office of Inspector General (1999) *Air Traffic Control Modernization - Federal Aviation Administration*, Report AV-1999-065, March 30, pp.9, 29-33.

Paap, K. R. and Roske-Hofstrand, R. J. (1986) The optimal number of menu options per panel. *Human Factors*, Vol. 28, No. 4, pp.377-385.

Potocki, P. and J. P. Dambrine (1995) *Future Air Navigation System and New Flight Management System – Technical Press Briefing*, Airbus Industrie, May.

Pritchett, A. and Hansman, R. J. Jr. (1995) 'Party line' information use studies and implications for ATC datalink communications, *Proceedings of the 14th AIAA/IEEE Digital Avionics Systems Conference (DASC)*, Cambridge, MA, November 5-9, Institute of the Electrical and Electronics Engineer, pp.26-31.

Radio Technical Commission on Aeronautics (1993) *Minimum Operational Performance Standards for ATC Two-Way Data Link Communications*, RTCA DO-219, August 27, Appendix A.

Rehmann, A. J. and Mogford, R. H. (1996) *Airborne Data Link Study Report*, U.S. Department of Transportation - Federal Aviation Administration CT-TN95/62.

Reid, G. B., Shingledecker, C. A. and Eggemeier, F. T. (1981) Application of conjoint measurement to workload scale development. *Proceedings of Human Factors Society 25th Annual Meeting*, pp.522-526.

Scanlon, C. H. and Knox, C. E. (1991) Flight tests show potential benefits of data link as primary communication medium. *International Aeronautical Telecommunications Symposium on Data Link Integration*, McLean, VA. May 20-23, Paper 13.

Sheridan, T. B. and Simpson, R. W. (1979) Toward the definition and measurement of the mental workload of transport pilots. MIT Flight Transportation Laboratory Report R79-4, January.

Shuvaev, A. P. and Oishi, R. T. (1996) Preoperational testing of data link-based air traffic management systems in Magadan, Far East Russia. *Proceedings of the IEEE 1996 Position, Location and Navigation Symposium*, Atlanta, GA, Institute of Electrical and Electronics Engineers, April 22-26, pp. 184-187.

Signargout, L. (1995). "Aircraft builder emphasizes flexible approach of implementation of satellite-based systems", *ICAO Journal*, Vol. 50. No. 2, March.

Snowberry, K., Parkinson, S. R. and Sisson, N. (1983) Computer menu display. *Ergonomics*, Vol. 26, No. 7, pp.699-712.

Stahr, R. S. (1991) Implementing data link across the Pacific, *Society of Automotive Engineers Aerospace Technology Conference and Exposition*, Long Beach, CA, September 23-26, pp. 9 (pre-print).

Vidulich, M. A. and Tsang, P. S. (1985) Assessing subjective workload assessment: a comparison of SWAT and NASA-bipolar methods. *Proceedings of Human Factors Society 29th Annual Meeting*, pp. 71-75. Santa Monica, CA: Human Factors Society.

Waller, M. C. (1992) *Flight Deck Benefits of Integrated Data Link Communication*, NASA Technical Paper 3219.

Waller, M. C. and Lohr, G. W. (1989) *A Piloted Simulation Study of Data Link ATC Message Exchange*, NASA Technical

Wierville, W. W., Casali, J. G., Connor, S. A. and Rahimi, M. (1986) Evaluation of the sensitivity and intrusion of mental workload estimation techniques. In W. Rorer (Ed.) *Advances in Man-machine Systems Research*, Vol. 2, pp. 51-127. Greenwich, CT: JAI Press.

Woodworth, M. (1999). ASAP - A View from the Line, *The Flight Deck*, American Airlines, Inc., Dallas-Fort Worth Airport, TX, March-April, pp.10-14.

APPENDIX A FLIGHT DECK CPDLC INTERFACE HIERARCHY

Partial Menu Hierarchy for the MCDU-based system:

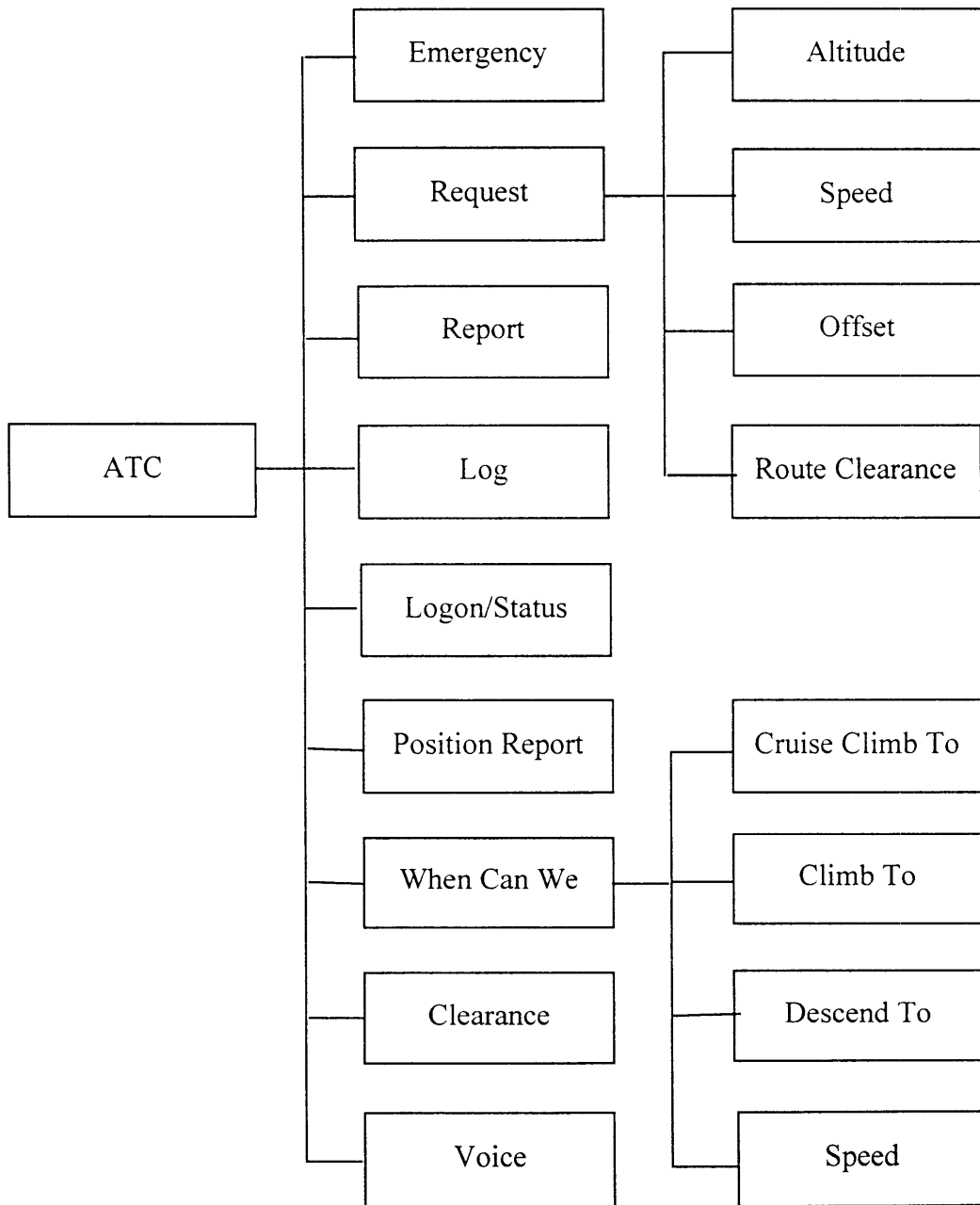

Partial Menu Hierarchy for the DCDU-based system:

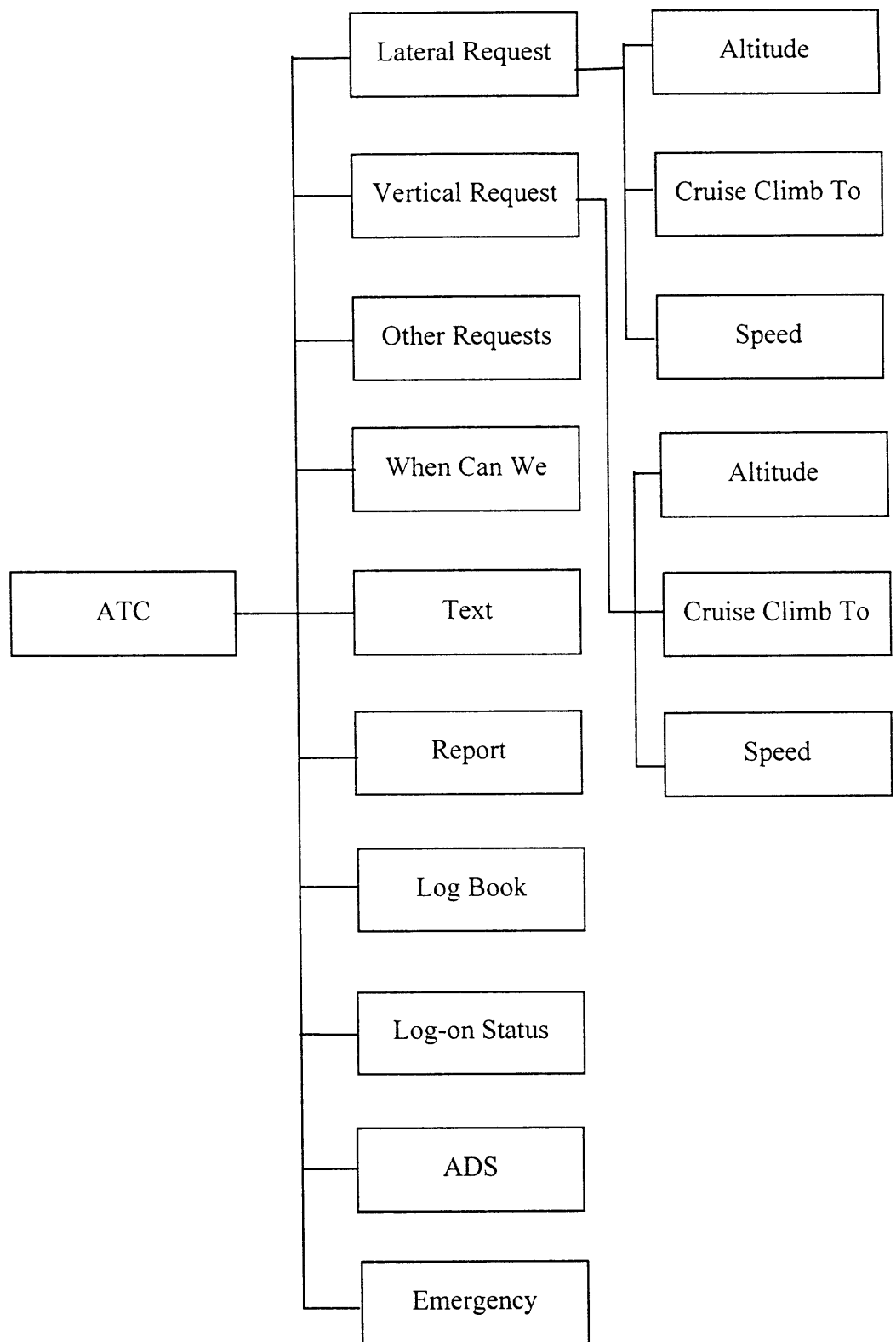

Partial Menu Hierarchy for the MFD-based system:

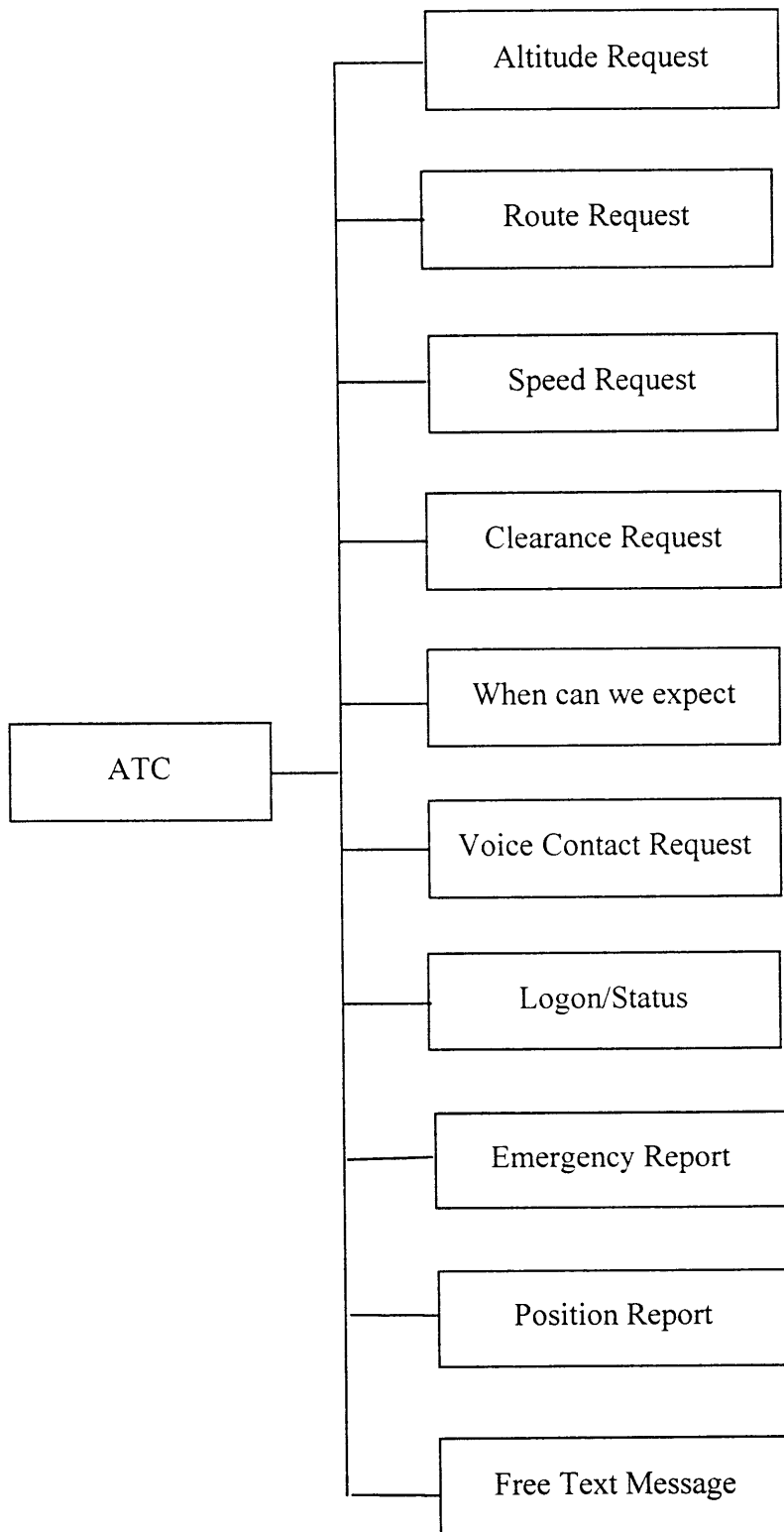

APPENDIX B RESULTS FOR SELECTED CPDLC PROCEDURES

In this appendix, the procedures and processing time requirements for logging on to CPDLC, requesting a route clearance and for loading route information from an ATC message to the FMC are compared. Note again that while the processing time data was taken for the MCDU-based and MFD-based systems at the Boeing Engineering Simulators, the performance of the DCDU-based system was estimated.

Comparison of Log-On Procedures:

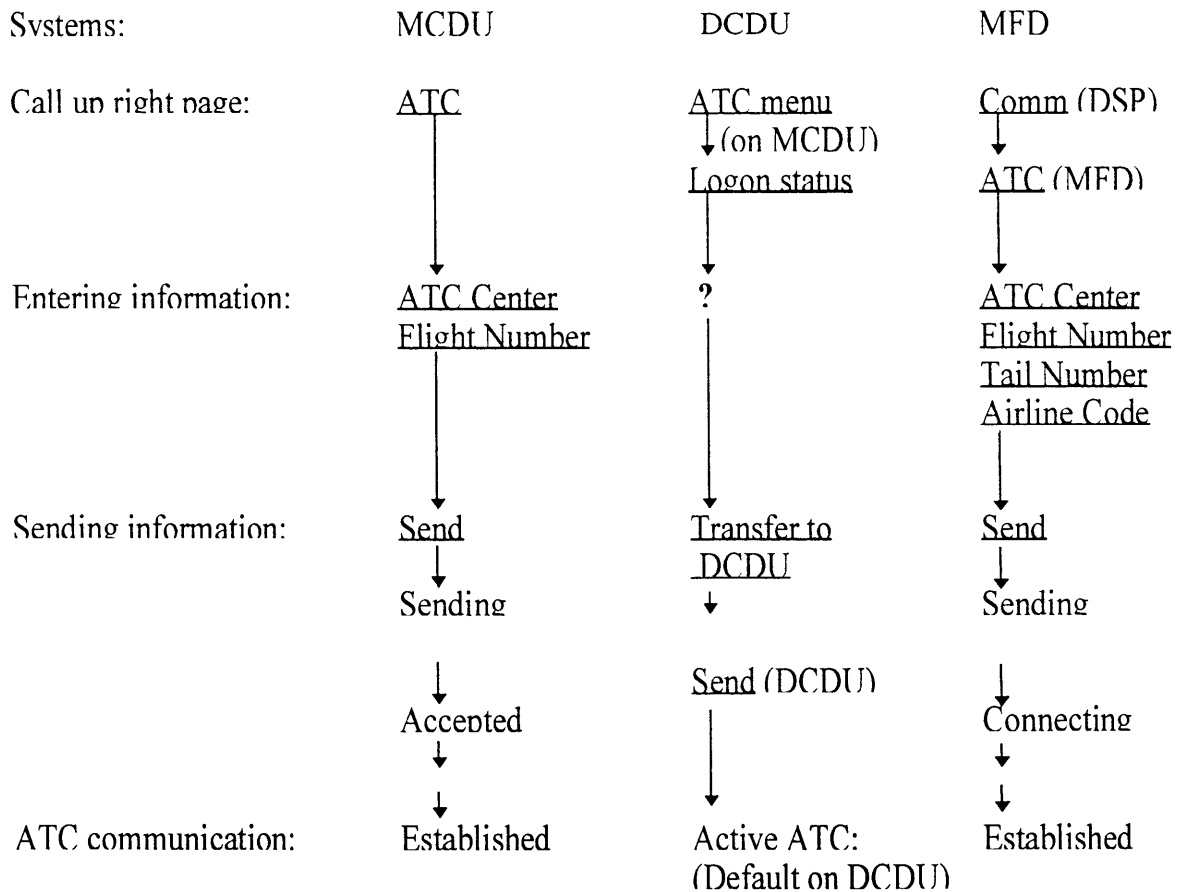

Underlined items are entered by the pilots.

Items not underlined are shown on the screen to show the progress status



Comparison of Log-on Procedural Complexity:

Systems	MCDU	MCDU-DCDU	MFD
Menu Buttons (on MCDU or DSP)	1	1	1
Alphanumeric	10	10	10(18)
Line-select/cursor-control	3	4 on MCDU 1 on DCDU	5(7)
Number of all keys pressed	14	16	16(26)
Number of pages of displays viewed	1	2 on MCDU 1 on DCDU	2

Figures in parentheses represent the case in the MFD-based system where the tail number and airline code need to be entered separately.

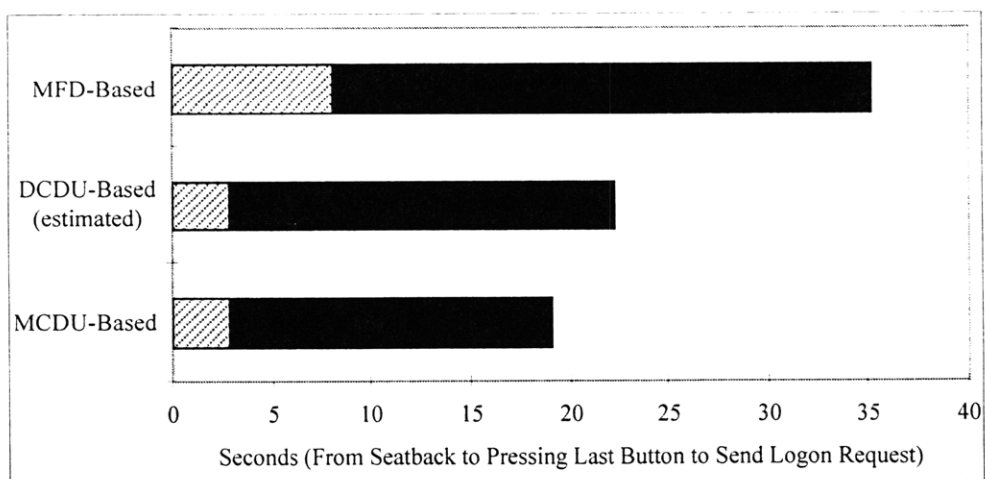
Processing Times for Log-On Procedures:



 Access to right page (till pressing of last button to display the message)
 Responding to the message

Procedural Comparison for Route Clearance Requests:

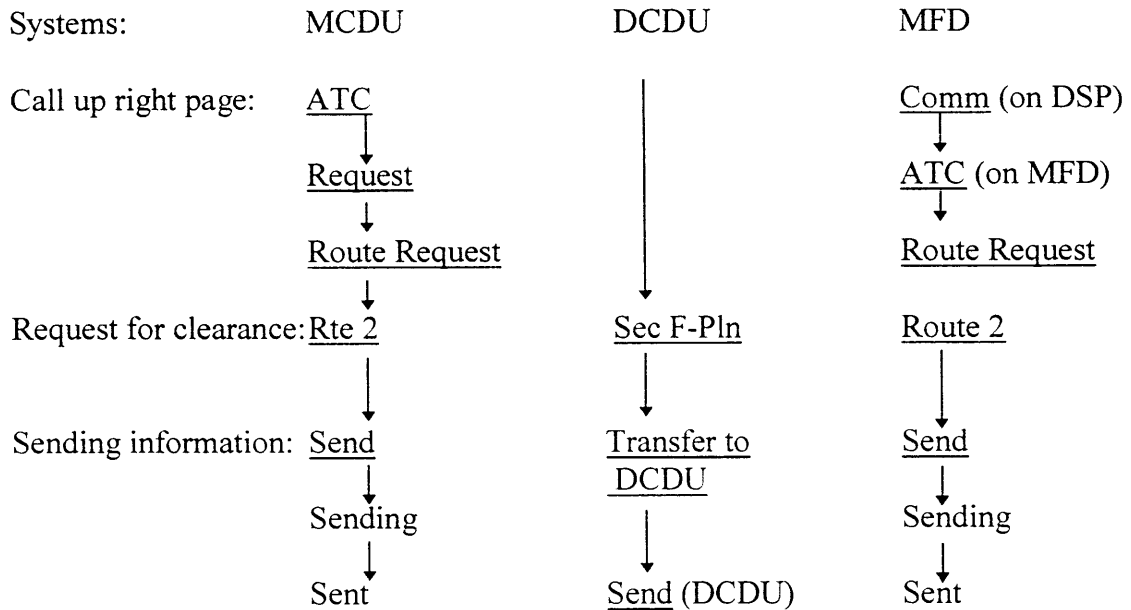

Underlined items are entered by the pilots.
Items not underlined are shown on the screen to show the progress status

Comparison of Procedural Complexity for Route Clearance Requests:

Systems	MCDU	MCDU-DCDU	MFD
Menu Buttons (on MCDU or DSP)	1	1	1
Alphanumeric	0	0	0
Line-select/cursor-control	5	1 on MCDU 1 on DCDU	4
Number of all keys pressed	6	3	5
Number of pages of displays viewed	4	2	2

Processing Times for Route Clearance Requests:

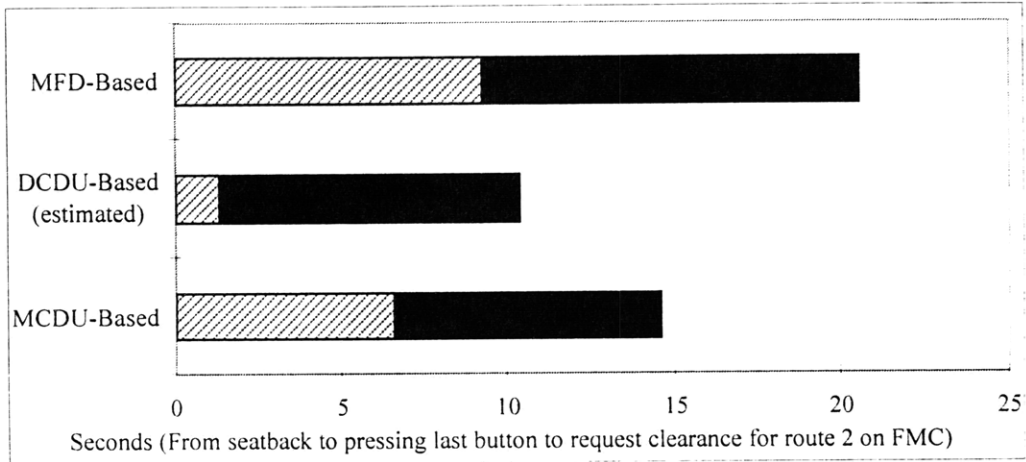

Access to right page (till pressing of last button to display the message)
 Responding to the message

Procedural Comparison for Loading Route Information from an ATC Message to FMC

(From receipt of the message):

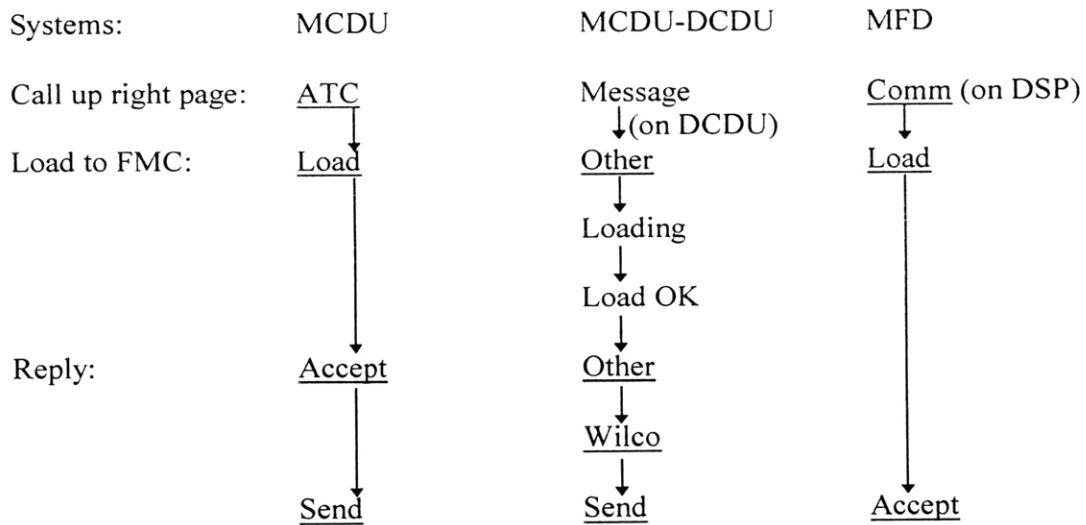

Comparison of Procedural Complexity for Loading Route Information from an ATC

Message to FMC:

Systems	MCDU	MCDU-DCDU	MFD
Menu Buttons (on MCDU or DSP)	1	0	1
Alphanumeric	0	0	0
Line-select/cursor-control	3	4	2
Number of all keys pressed	4	4	3
Number of pages of displays viewed	2	4	1

Comparison for Processing Times for Loading Route Information from an ATC Message to FMC:

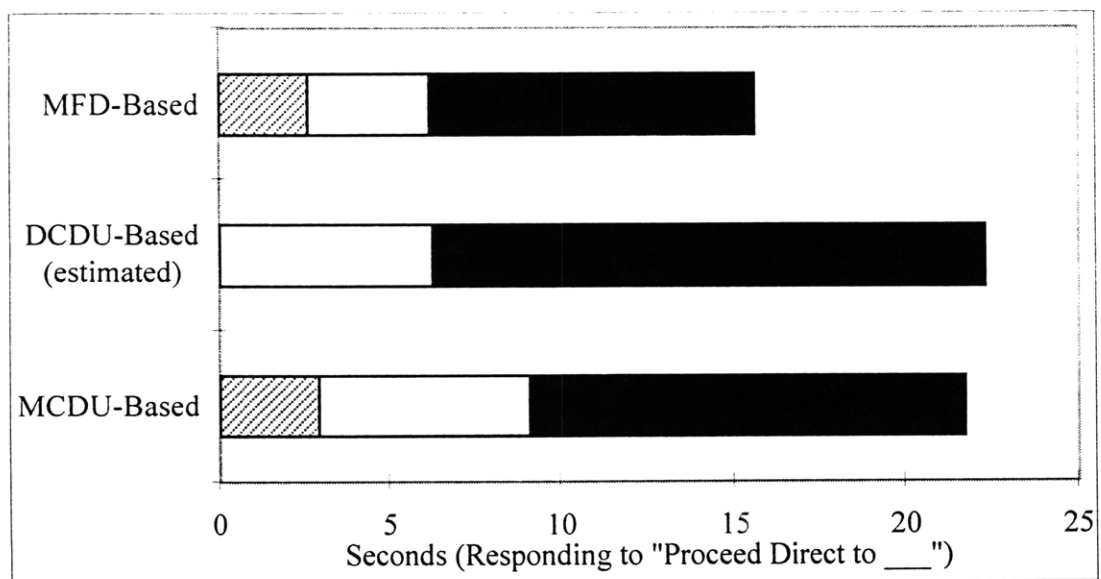

- Access to right page (till pressing of last button to display the message)
- Reading message and verbalizing course of action
- Responding to the message

APPENDIX C MENU PAGE LINKS FOR THE INTERFACE

EXPERIMENT (AT MIT)

Interface Configurations 1, 2 and 4: Main Window

The number at the end of the button shows identify the screen to be displayed next.

No	Title	Button1	Button2	Button3	Button4	Remarks
0	Main Menu	Communication,1	Systems, 2			
1	Communication Menu	Display message, 3	Respond to new message, 4	Pilots' requests, 20	Main menu, 0	
2	System Menu	Airplane systems, 50	Flight conditions, 32	Flight plan & position, 57	Main menu, 0	
3	Latest Unreplied Message	Respond to latest message, 4	Last message, 16	Previous page, 1	Main menu, 0	Body: (New message:) [shows latest message]
4	Respond to Message	Accept, 6	Reject, 10	Previous Page, 1 or 3	Main menu, 0	
5	Accept New Message	Will comply as is, 6	Will comply with note, 7	Previous page, 4	Main menu, 0	
6	Accepting New Message	Continue, 0	Last message, 3	Previous page, 5	Main menu, 0	
7	Accept New Message - Note	Prefer original route, 8	Prefer smoother altitude, 9	Previous page, 6	Main menu, 0	
8	Accepting New Message	Continue, 0	Last message, 3	Previous page, 7	Main menu, 0	Body: prefer original route
9	Accepting New Message	Continue, 0	Last message, 3	Previous page, 7	Main menu, 0	Body: prefer smoother altitude
10	Reject New Message	Reject as is, 11	Reject with reason, 12	Previous page, 4	Main menu, 0	
11	Rejecting New Message as is	Continue, 0	Last message, 3	Previous page, 10	Main menu, 0	
12	Rejecting New Message with Reason	Due to weather, 13	Due to airplane performance, 14	Due to low fuel, 15	Previous page, 10	
13	Rejecting New Message	Continue, 0	Last message, 3	Previous Page, 12	Main menu, 0	Body: due to weather
14	Rejecting New Message	Continue, 0	Last message, 3	Previous page, 12	Main menu, 0	Body: due to airplane performance
15	Rejecting New Message	Continue, 0	Last message, 3	Previous page, 12	Main menu, 0	Body: due to low fuel
16	Last Unreplied Message	Accept, 17	Reject, 18	Previous page, 3	Main menu, 0	Body: Last Unreplied Message: ...(shows last unreplied

						message)
17	Accepting Last Message	Continue, 0	Latest Message, 3	Previous Page, 16	Main Menu, 0	
18	Rejecting Last Message	Continue, 0	Latest Message, 3	Previous Page, 16	Main Menu, 0	
20	Pilots' Requests	Requests, 21	When can we, 39	Previous page, 1	Main menu, 0	
21	Requests	Altitude change, 22	Route change, 25	Speed change, 28	Previous page, 20	
22	Altitude Change	FL330, 24	FL370, 23	Text input, 22	Previous page, 21	
23	Altitude Change	Confirm, 0	Other requests, 20	Previous page, 22	Main menu, 0	Body: FL370 requested
24	Altitude Change	Confirm, 0	Other requests, 20	Previous page, 22	Main menu, 0	Body: FL330 requested
25	Route Change	Direct to NUTRE, 26	Route offset, 27	Previous page, 21	Main menu, 0	
26	Route Change	Confirm, 0	Other requests, 20	Previous page, 25	Main menu, 0	Body: Direct to NUTRE N28472 W068339
27	Route Offset	Confirm, 0	Other requests, 20	Previous page, 25	Main menu, 0	Body: Route Offset
28	Speed Change	To Mach 0.82, 29	To Mach 0.80, 30	To Mach 0.78, 31	Previous page, 25	
29	Speed Change	Confirm, 0	Other requests, 20	Previous page, 28	Main menu, 0	Body: To Mach 0.82
30	Speed Change	Confirm, 0	Other requests, 20	Previous page, 28	Main menu, 0	Body: To Mach 0.80
31	Speed Change	Confirm, 0	Other requests, 20	Previous page, 28	Main menu, 0	Body: To Mach
32	Flight Conditions	Speed, 44	Heading, 45	Altitude, 56	Previous page, 2	
33	Data Link Status	Reconnect, 34	Terminate data link, 0	Previous page, 50	Main menu, 0	Body: Data link connection off
34	Data Link Status	Continue, 0			Main menu, 0	Body: Data link reconnected
35	Current Position	Report to ATC, 36	Report with turbulence, 37	Report with icing, 38	Previous page, 57	Body: (see Pages.java)
36	Position Reporting	Confirm, 0	Status menu, 32	Previous page, 35	Main menu, 0	Body: Report to ATC
37	Position Reporting	Confirm, 0	Status menu, 32	Previous page, 35	Main menu, 0	Body: Report now with turbulence
38	Position Reporting	Confirm, 0	Status menu, 32	Previous page, 35	Main menu, 0	Body: Report now with icing
39	When can we expect to	Be back on original route, 40	Change altitude, 41	Change speed, 42	Previous page, 20	
40	When can we expect to	Confirm, 0	Pilots' requests, 20	Previous page, 39	Main menu, 0	Body: Be back on original route
41	When can we expect to	Confirm, 0	Pilots' requests, 20	Previous page, 39	Main menu, 0	Body: Change altitude
42	When can we	Confirm, 0	Pilots' requests, 20	Previous page, 39	Main menu, 0	Body: Change

	expect to		20	39	menu, 0	speed
44	Current Speed	Send speed info to ATC, 0		Previous page, 32	Main menu, 0	Body: Current speed: Mach 0.75
45	Current Heading	Maintain Current Heading, 0	Turn to assigned heading, 0	Previous page, 32	Main menu, 0	Body: Current heading: 300 Assigned heading: (varies)
50	Airplane Systems	Cabin temperature, 51	Available fuel, 55	Data link system, 33	Previous page, 2	
51	Cabin Temperature	Much higher, 52	Higher, 53	Lower, 54	Previous page, 50	
52	Cabin Temperature	Confirm, 0		Previous page, 51	Main menu, 0	Body: Adjusted much higher
53	Cabin Temperature	Confirm, 0		Previous page, 51	Main menu, 0	Body: Adjusted higher
54	Cabin Temperature	Confirm, 0		Previous page, 51	Main menu, 0	Body: Adjusted lower
55	Available Fuel	Acknowledge, 0		Previous page, 50	Main menu, 0	Body: [Random(080, 070, 060)]x1000lbs - Lower than expected
56	Current Altitude			Previous page, 32	Main menu, 0	Body: Current: FL250, Maximum: (varies depending on tasks)
57	Flight Plan and Heading	Flight Plan, 58	Current position, 35	Previous page, 2	Main menu, 0	
58	Active Flight Plan			Previous page, 57	Main menu, 0	Body: (Depends on number of task combo shown)
59	Flight Plan By Waypoint	Print (Wait time > 5 seconds), #		Previous page, 57	Main menu, 0	Body: PULLS NUTRE KRAFT CHOCK LENNT PLING SAALR SJU

Interface Configuration 3:

Exactly the same as before, except that:

- Left interface: only communications-related functions
- Right interface: only non-communications functions (no overlap with left window)

APPENDIX D COMMUNICATION TASKS IN EXPERIMENT

No.	From ATC?	ATC Message/ Task Prompt	Remarks
	A	Acceptance - simple uplinks requiring simple acceptance	
1	From ATC	CONTACT SJU ON 125.1 Mhz	
2	From ATC	CONTACT JFK ON 118.1 Mhz	
3	From ATC	EXPECT DIRECT TO KRAFT (WAYPOINT)	
4	From ATC	EXPECT DIRECT TO PULLS (WAYPOINT)	
5	From ATC	EXPECT DESCENT AT PERKS (WAYPOINT)	
6	From ATC	EXPECT DESCENT IN 5 MILES	
7	From ATC	EXPECT NORMAL SPEED IN 5 MILES	
8	From ATC	EXPECT HIGHER ALTITUDE IN 3 MINS	
9	From ATC	EXPECT TO CROSS LINND (WAYPOINT) AT FL240 (ALTITUDE)	
10	From ATC	EXPECT TO CROSS PULLS (WAYPOINT) AT FL240 (ALTITUDE)	
11	From ATC	MAINTAIN FL270 (ALTITUDE)	
12	From ATC	MAINTAIN FL290 (ALTITUDE)	
13	From ATC	MAINTAIN MACH 0.74 (SPEED)	
14	From ATC	MAINTAIN MACH 0.75 (SPEED)	
15	From ATC	MAINTAIN MACH 0.76 (SPEED)	
16	From ATC	RESUME OWN NAVIGATION	
17	From ATC	RESUME NORMAL SPEED	
18	From ATC	PROCEED BACK ON ROUTE	
19	From ATC	REJOIN ROUTE AT PULLS (WAYPOINT)	
	Q	Questions - uplinks requiring information check before replying	
1	From ATC	CLIMB TO FL270 (ALTITUDE)	
2	From ATC	CLIMB TO FL290 (ALTITUDE)	
3	From ATC	CLIMB TO FL330 (ALTITUDE)	
4	From ATC	CLIMB TO FL370 (ALTITUDE)	
5	From ATC	CLIMB TO AND MAINTAIN FL270 (ALTITUDE)	
6	From ATC	CLIMB TO AND MAINTAIN FL290 (ALTITUDE)	
7	From ATC	CLIMB TO AND MAINTAIN FL330 (ALTITUDE)	
8	From ATC	CLIMB TO AND MAINTAIN FL370 (ALTITUDE)	
9	From ATC	INCREASE TO MACH 0.79 (SPEED)	
10	From ATC	INCREASE TO MACH 0.81 (SPEED)	
11	From ATC	INCREASE TO MACH 0.83 (SPEED)	
12	From ATC	INCREASE TO MACH 0.85 (SPEED)	

13 From ATC CAN YOU ACCEPT M0.81 (SPEED)
 14 From ATC CAN YOU ACCEPT M0.79 (SPEED)
 15 From ATC CAN YOU ACCEPT M0.85 (SPEED)
 16 From ATC CAN YOU ACCEPT M0.83 (SPEED)
 17 From ATC HOLD AT SAALR (Waypoint)

D

Downlinks - pilot-initiated downlinks

1 From Pilot REQUEST CLIMB TO FL330 (ALTITUDE)
 2 From Pilot REQUEST DIRECT TO NUTRE (WAYPOINT)
 3 From Pilot REQUEST WEATHER DEVIATION (ROUTE OFFSET)
 5 From Pilot WHEN CAN WE EXPECT BACK ON ROUTE
 6 From Pilot WHEN CAN WE CHANGE ALTITUDE
 7 From Pilot WHEN CAN WE CHANGE SPEED
 8 From Pilot REQUEST MACH 0.80 (SPEED)
 9 From Pilot REQUEST MACH 0.82 (SPEED)
 10 From Pilot REQUEST MACH 0.78 (SPEED)

S

Systems - airplane system parameters

1 From System CHECK CURRENT SPEED
 2 From System RECONNECT DATA LINK COMMUNICATIONS
 7 From Prompt TURN CABIN TEMPERATURE MUCH HIGHER
 8 From Prompt TURN CABIN TEMPERATURE HIGHER
 9 From Prompt TURN CABIN TEMPERATURE DOWN
 10 From Prompt MONITOR TRAFFIC
 11 From Prompt MONITOR VERTICAL SPEED
 12 From Prompt CLIMB - CLIMB - CLIMB!
 13 From Prompt CLIMB, CLIMB NOW!
 14 From Prompt INCREASE CLIMB
 15 From Prompt REDUCE CLIMB
 16 From Prompt DESCEND - DESCEND - DESCEND!
 17 From Prompt DESCEND, DESCEND NOW!
 18 From Prompt INCREASE DESCENT
 19 From Prompt REDUCE DESCENT
 20 From Prompt REMAIN HEADING IF SAME AS ASSIGNED heading 300
 - OTHERWISE TURN TO ASSIGNED assigned
 HEADING
 21 From Prompt REPORT POSITION (NO ICING OR TURBULENCE)
 22 From Prompt REPORT POSITION (WITH ICING)
 23 From Prompt REPORT POSITION (WITH TURBULENCE)
 24 From Prompt REMAIN HEADING IF SAME AS ASSIGNED heading 310
 - OTHERWISE TURN TO ASSIGNED assigned

	HEADING	
25 From Prompt	REMAIN HEADING IF SAME AS ASSIGNED	heading 290
	- OTHERWISE TURN TO ASSIGNED	assigned
	HEADING	

C Cross-checking - alphanumeric cross-checking of flight plans

1 From ATC	CONFIRM YOU ARE ESTABLISHED ON ROUTE:	
Body:	On Interface:	
RAFIN	RAFIN	
4550N	4550N	
4540N	4540N	
4730N	4730N	
5020N	5020N	
DOLIP	DOLIP	
2 From ATC	CONFIRM YOU ARE ESTABLISHED ON ROUTE:	
Body:	On Interface:	
FRILL	FRILL	
4550N	4550N	
4540N	4540N	
4730N	4370N	
5020N	5020N	
NUMPO	NUMPO	(reject)
3 From ATC	CONFIRM YOU ARE ESTABLISHED ON ROUTE:	
Body:	On Interface:	
DOPHN	DOPHN	
4550N	4550N	
4530N	4540N	
4720N	4730N	
5010N	5020N	
BUNCE	BUNCE	(reject)
11 From ATC	CONFIRM YOU ARE ESTABLISHED ON ROUTE:	
Body:	On Interface:	
KANNI	KANNI	
5010N	5010N	
5120N	5120N	
5230N	5230N	
5340N	5340N	
EVRIN	EVRIN	
12 From ATC	CONFIRM YOU ARE ESTABLISHED ON ROUTE:	
Body:	On Interface:	
SHIPP	SHIPP	

5010N	5010N	
5120N	5120N	
5230N	5320N	
5340N	5340N	
NIGIT	NIGIT	(reject)
13 From ATC	CONFIRM YOU ARE ESTABLISHED ON ROUTE:	
Body:	On Interface:	
LINND	LINND	
5010N	5010N	
5130N	5120N	
5240N	5230N	
5350N	5340N	
DOPHN	DOPHN	(reject)
21 From ATC	CONFIRM YOU ARE ESTABLISHED ON ROUTE:	
Body:	On Interface:	
CORK	CORK	
5115N	5115N	
5020N	5020N	
4925N	4925N	
4830N	4830N	
DOPHN	DOPHN	
22 From ATC	CONFIRM YOU ARE ESTABLISHED ON ROUTE:	
Body:	On Interface:	
OCKHAM	OCKHAM	
5115N	5115N	
5020N	5020N	
4925N	4925N	
4830N	4380N	(reject)
JFK	JFK	
23 From ATC	CONFIRM YOU ARE ESTABLISHED ON ROUTE:	
Body:	On Interface:	
LHR	LHR	
5115N	5115N	
5030N	5020N	
4935N	4925N	
4840N	4830N	
KANNI	KANNI	(reject)
31 From ATC	CONFIRM YOU ARE ESTABLISHED ON ROUTE:	
Body:	On Interface:	
BUNCE	BUNCE	

5025N	5025N	
4940N	4940N	
4835N	4835N	
4740N	4740N	
FRILL	FRILL	
32 From ATC	CONFIRM YOU ARE ESTABLISHED ON ROUTE:	
Body:	On Interface:	
OCK	OCK	
5025N	5025N	
4940N	4940N	
4835N	4385N	
4740N	4740N	
FRILL	FRILL	(reject)
33 From ATC	CONFIRM YOU ARE ESTABLISHED ON ROUTE:	
Body:	On Interface:	
NIGIT	NIGIT	
5025N	5025N	
4940N	4920N	
4835N	4825N	
4740N	4730N	
RAFIN	RAFIN	(reject)

F Filler - No need to respond

1 From System	Cabin temperature: 18oC
2 From System	Cabin temperature: 19oC
3 From System	Cabin temperature: 20oC
4 From System	Cabin temperature: 21oC
5 From System	Datalink normal
6 From System	Engine No. 1 normal
7 From System	Engine No. 2 normal
8 From System	Outside temperature: -30oC
9 From System	Outside temperature: -31oC
10 From System	Outside temperature: -32oC
11 From System	Outside temperature: -33oC
12 From System	Ground speed: 849km/hr
13 From System	Ground speed: 850km/hr
14 From System	Ground speed: 851 km/hr
15 From System	Ground speed: 852km/hr

This page intentionally left blank.