

## X. ANALOG COMPUTER RESEARCH

Prof. E. A. Guillemin  
Prof. R. E. Scott

Prof. J. M. Ham  
O. N. Becker  
S. Fine

A. MacMullen, Jr.  
R. E. Woods

### A. THE OPERATION OF PRESENT COMPUTERS

#### 1. The Macnee Differential Analyzer

For any given problem there are a number of machine interconnections which may be used to arrive at a solution. A study is being made of the errors associated with various alternative procedures in order to determine which one is optimum for a given problem. Four basic methods are being considered.

a. In the simultaneous equation method a closed loop is set up for each of the dependent variables having derivatives. Mutual terms are included as connecting links between the loops. The following equations for a network with two nodes illustrate the simultaneous equation method.

$$\frac{d^2 e_1}{dt^2} - \frac{de_1}{dt} + e_1 = - \frac{de_2}{dt}$$

$$\frac{d^2 e_2}{dt^2} - e_2 = e_1.$$

In the connection diagram of Fig. X-1 an integrator and an adder are represented as follows:

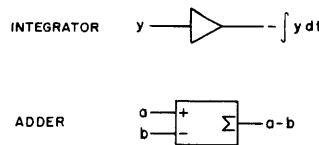

The differentiation symbol  $d/dt = p$ .

b. The transfer function method requires a multiple closed loop for the denominator of the transfer function plus one additional adder for the numerator of the transfer function. A typical form for such a transform is

$$T = \frac{E_o}{E_1} = \frac{p^4 + \alpha p^2 + \beta}{p^5 + \gamma p^4 + \delta p^3 + \sigma p^2 + \tau p + \nu}$$

Figure X-2 shows the machine connection for this transfer function.

c. The direct simulation method requires that the equations be broken down into their simplest elements; for example, Kirchoff current law equations, and Ohm's law equations. One adder or integrator must then be used for each Ohm's law equation and

## (X. ANALOG COMPUTER RESEARCH)

one adder for each voltage and current law equation. If any inductive or capacitive nodes (or loops) occur, then one differentiator must be added for each such node (or loop). The following equations for the network shown in Fig. X-3 illustrate the direct simulation method.

Ohm's law equations

$$e_1 = i_1 R_1$$

$$e_2 = \frac{1}{c_1} \int i_2 dt$$

$$i_3 = \frac{1}{L_1} \int e_3 dt$$

$$i_4 = \frac{1}{L_2} \int e_4 dt$$

$$e_5 = \frac{1}{c_2} \int i_5 dt$$

$$e_6 = R_2 i_6$$

Current law equations

$$i_5 = i_6$$

$$i_3 = i_4 + i_5$$

$$i_1 = i_2 + i_3$$

Voltage law equations

$$e = e_1 + e_2$$

$$e_2 = e_3 + e_4$$

$$e_4 = e_5 + e_6$$

The connection diagram is shown in Fig. X-4.

d. The pole and zero method utilizes cascaded groups of interconnected elements. Each element has a transfer function containing at most two poles and two zeros. The following is a typical transfer function factored to place in evidence its poles and zeros.

$$T = \frac{E_o}{E_1} = \frac{(p+a)(p+c)}{(p+b)[(p+d)^2 + e^2](p+f)}$$

Figure X-5 shows the corresponding machine connection.

For the case of ideal computing amplifiers, i. e. infinite gain, infinite bandwidth,

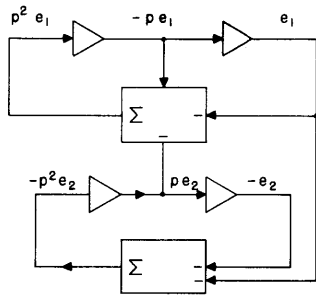

Fig. X-1

Connection diagram for simultaneous equation method.

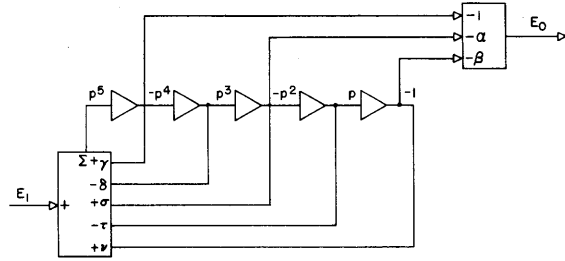

Fig. X-2

Connection diagram for transfer function method.

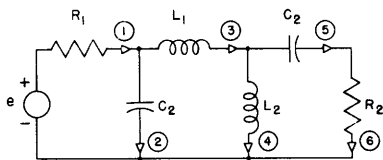

Fig. X-3

Circuit diagram for direct simulation method.

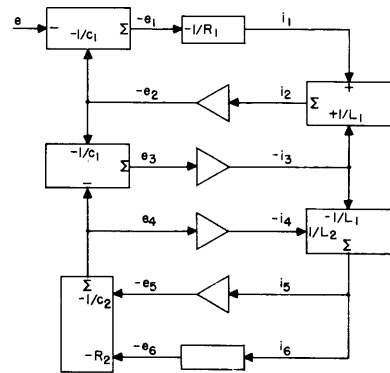

Fig. X-4

Connection diagram for direct simulation method.

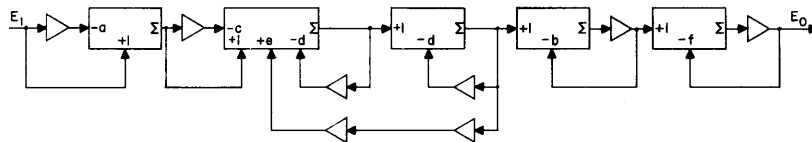

Fig. X-5

Connection diagram for the pole and zero method.

## (X. ANALOG COMPUTER RESEARCH)

infinite input impedance, zero output impedance, linear, etc., all four of these methods will produce the same answer to the same problem. Unfortunately however, few computers are ideal.

One of the major difficulties encountered so far is that of the limitation on the accuracy of adjustment of parameters, i. e. a potentiometer can be knowingly adjusted to a ratio  $\alpha$  which contains only a finite number of significant figures. In the solution of network problems using the simultaneous equations method, this limitation introduces stray unilateral elements into the network. The direct simulation method eliminates the stray unilateral elements in the solution of network problems but in some cases introduces the need for extremely high gain amplifiers.

Another major difficulty is the limitation of the gain and bandwidth of the amplifiers to finite values. This factor is particularly serious in a differentiator.

Instability of gains due to line voltage fluctuations, variable loading, and temperature variations creates havoc in the determination of instability points in equations by the variation of parameters.

No results have yet been obtained which relate the minimization of errors to a particular method for any general class of problem.

R. E. Woods

### 2. The Use of Computing Elements in Nonlinear Time Domain Filters

It should be possible to remove the noise from any signal provided that the signal and the noise differ in some fashion, and provided that one has an a priori knowledge of what this difference will be. For example, if the signal and the noise occupy different bands in the frequency spectrum it is possible to separate them by a linear filter. When they occupy the same frequency regions linear filters are of limited use. For example, suppose it is required to separate a sine wave and a square wave of the same frequency.

A technique which has been successful for problems of the latter type is the following. The signal is differentiated. It is then clipped to a level which removes most of the differentiated noise and finally it is reintegrated. Some results obtained with simple diode clipping are shown in Figs. X-6 through X-12. More complex clippers would of course give even better results.

R. E. Scott, A. MacMullen, Jr.

## B. THE DESIGN OF NEW COMPUTING ELEMENTS

### 1. Integral Equation Computer

With the exception of the tape punch, all computing elements for the integral equation solver have been constructed and tested.

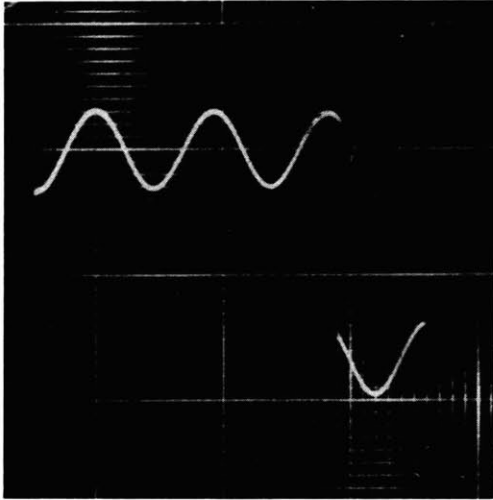

Fig. X-6  
Sine wave plus square wave.

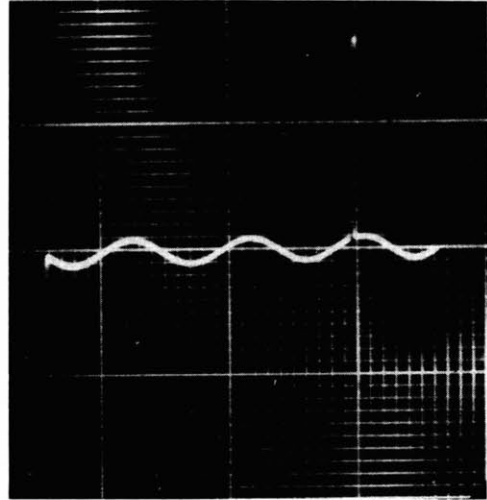

Fig. X-7  
Differentiated sine wave  
plus square wave.

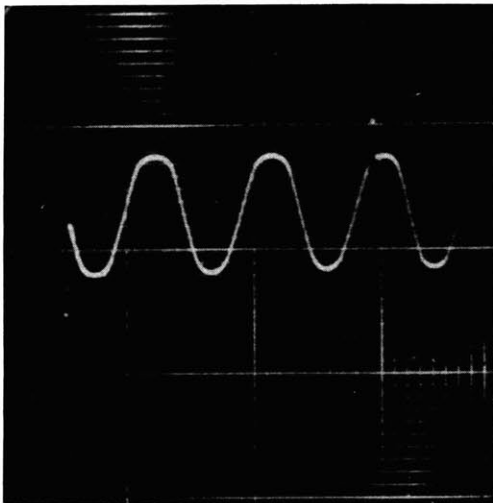

Fig. X-8  
The result after clipping.

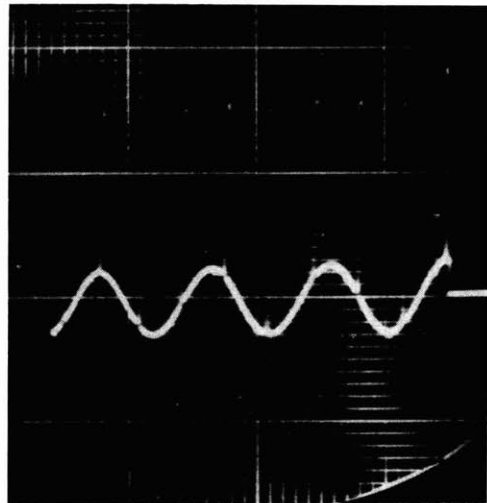

Fig. X-9  
A sine wave plus impulse noise.

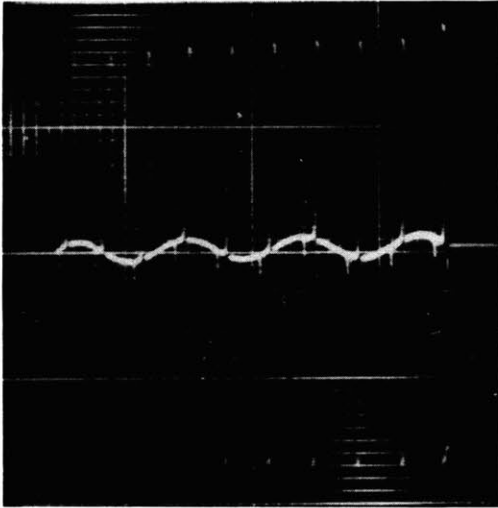

Fig. X-10  
The signal of Fig. X-9  
after differentiation.

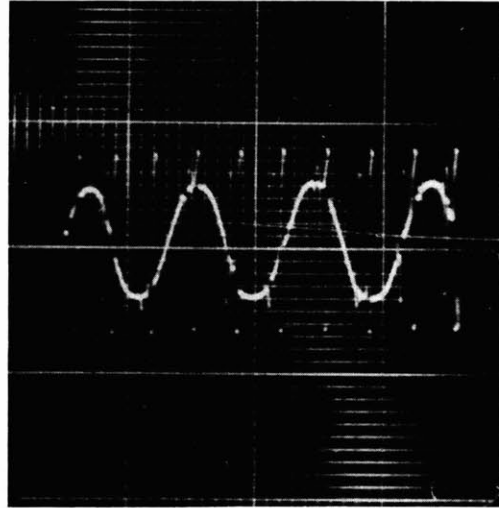

Fig. X-11  
The signal after clipping.

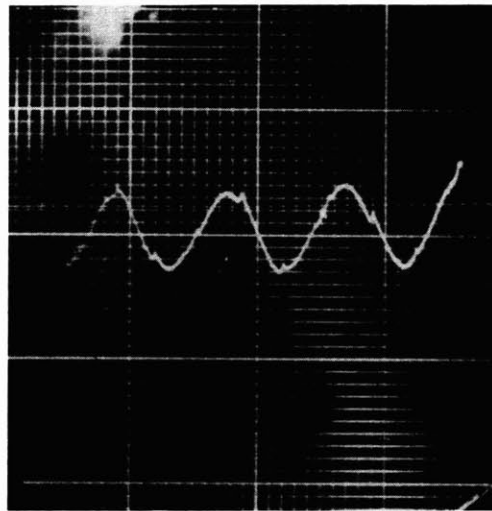

Fig. X-12  
The re-integrated signal.

(X. ANALOG COMPUTER RESEARCH)

The design of the computer was stimulated by the desire to implement the solution of integral formulations of linear and subsequently nonlinear problems arising in engineering research. The class of problems being studied may be characterized by an operational equation of the form  $Pa + \beta = 0$  defined in a Hilbert space.  $P$  is a given transformation which maps an unknown vector  $a$  into a known vector  $\beta$ . The general method adopted for solution is that of constructing a sequence  $\{a_n\}$  of approximate solution vectors which define a trajectory terminating in a solution vector. The form of the sequence is determined by the character of  $P$ .

Current study of successive approximation methods for solving system formulations derived from either differential or integral equations has led to an effort to coordinate within a Hilbert-space or vector-space model some of the many threads of research flourishing under the name of relaxation and iterative methods. An example in point is the following interpretation of a method introduced by Fox(1) with the simple verification that it works.

Let  $Pa + \beta = 0$  denote a set of  $n$  simultaneous linear equations which represent a finite difference approximation on  $n$  points to a linear ordinary differential equation defined on a finite interval with ordinate boundary conditions. The  $n$  rows of  $P$  are the ordinate weighting coefficients for the finite difference equation at each of the  $n$  unknown ordinates  $a_1, a_2 \dots a_n$ . The vector  $\beta$  defines the forcing function and boundary conditions. In the computational method devised by Fox, the matrix operator  $P$  is separated into two component matrices  $P'$  and  $P''$  such that  $P = P' + P''$ . The solution vector  $a$  is sought in the form  $a = a_0 + a_1 + \dots + a_n + \dots$  where

$$\begin{aligned} P'a_0 + \beta &= 0 \\ P'a_1 + P''a_0 &= 0 \\ P'a_2 + P''a_1 &= 0 \\ &\vdots \end{aligned}$$

If  $Q$  denotes  $(P')^{-1}(-P'')$ , the above sequence of equations defines  $a$  as

$$a = (I + Q + Q^2 + \dots + Q^n) a_0$$

where  $a_0 = (P')^{-1}(-\beta)$ ,  $I$  is the unit matrix and  $Q^n = QQQ\dots$  to  $n$  times. A sufficient condition for the convergence of the series is that the largest modulus of the eigenvalues of the matrix  $Q$  be less than unity (2).

For computational purposes, this method exchanges the problem of solving once an equation involving the matrix operator  $P$  for the problem of solving several times an equation involving the matrix  $P'$ . In the latter case the matrix  $P''$  always occurs in a

substitutional role. In the applications due to Fox,  $P'$  is derived from the principal diagonal and adjacent diagonals of  $P$  and represents a first-order finite-difference approximation to the differential equation.  $P''$  contains the equivalent of the higher-order difference terms that are allowed by the  $n$ -tuple basis for the equation.

The above procedure applies directly to integral equations and the characterization given suggests various divisions of  $P$  into component matrices. For example, if the principal diagonal of  $P$  is normalized to unity and selected as the matrix  $P' = I$ ,  $P'' = (P-I) = Q$ . In the above procedure then  $\alpha_0 = -\beta$ . A sufficient condition for the convergence of the series is that the norm of  $P$  be less than unity. This choice of  $P'$  and  $P''$  corresponds to the classical iteration method of simultaneous displacements (3).

J. M. Ham, S. Fine

#### References

1. L. Fox: Proc. Roy. Soc. A, 190, 31-59, 1947
2. A. Dresden: Bull. Am. Math. Soc. 48, 577-579, 1942
3. H. Geiringer: Reissner Anniversary Volume, Edwards Bros., Ann Arbor, Mich. 365-393, 1949

#### 2. Function Generator

The work on the use of an RCA 5527 ionoscope as a function generator has been terminated. A report on the results is being prepared. Functions have been projected on the mosaic by inserting an opaque function mask in a uniform light beam illuminating the mosaic. The method of loop feedback using an intensity modulated beam to scan the light-dark edge of the mosaic pattern has been shown to have very definite limitations.

O. N. Becker