

## MIT Open Access Articles

*Sensible organizations: Technology and methodology for automatically measuring organizational behavior*

The MIT Faculty has made this article openly available. **Please share** how this access benefits you. Your story matters.

**Citation:** Mohan, A., K. Ara, and A. Pentland, with Olguin, D.O., and B.N. Waber, Taemie Kim. "Sensible Organizations: Technology and Methodology for Automatically Measuring Organizational Behavior." *Systems, Man, and Cybernetics, Part B: Cybernetics*, IEEE Transactions On 39.1 (2009) : 43-55. © 2008 IEEE

**As Published:** <http://dx.doi.org/10.1109/TSMCB.2008.2006638>

**Publisher:** Institute of Electrical and Electronics Engineers

**Persistent URL:** <http://hdl.handle.net/1721.1/62024>

**Version:** Final published version: final published article, as it appeared in a journal, conference proceedings, or other formally published context

**Terms of Use:** Article is made available in accordance with the publisher's policy and may be subject to US copyright law. Please refer to the publisher's site for terms of use.



# Sensible Organizations: Technology and Methodology for Automatically Measuring Organizational Behavior

Daniel Olguín Olguín, *Student Member, IEEE*, Benjamin N. Waber, *Student Member, IEEE*, Taemie Kim, *Student Member, IEEE*, Akshay Mohan, Koji Ara, and Alex Pentland, *Member, IEEE*

**Abstract**—We present the design, implementation, and deployment of a wearable computing platform for measuring and analyzing human behavior in organizational settings. We propose the use of wearable electronic badges capable of automatically measuring the amount of face-to-face interaction, conversational time, physical proximity to other people, and physical activity levels in order to capture individual and collective patterns of behavior. Our goal is to be able to understand how patterns of behavior shape individuals and organizations. By using on-body sensors in large groups of people for extended periods of time in naturalistic settings, we have been able to identify, measure, and quantify social interactions, group behavior, and organizational dynamics. We deployed this wearable computing platform in a group of 22 employees working in a real organization over a period of one month. Using these automatic measurements, we were able to predict employees' self-assessments of job satisfaction and their own perceptions of group interaction quality by combining data collected with our platform and e-mail communication data. In particular, the total amount of communication was predictive of both of these assessments, and betweenness in the social network exhibited a high negative correlation with group interaction satisfaction. We also found that physical proximity and e-mail exchange had a negative correlation of  $r = -0.55$  ( $p < 0.01$ ), which has far-reaching implications for past and future research on social networks.

**Index Terms**—Organizational behavior, social computing, socio-metric badges, wearable computing.

## I. INTRODUCTION

THE STUDY of human behavior has always intrigued social scientists interested in enhancing organizational effectiveness and individual well-being in the workplace. Organizational behavior is a multidisciplinary field that seeks knowledge of behavior in organizational settings by systematically

Manuscript received April 15, 2007; revised November 26, 2007. First published December 2, 2008; current version published January 15, 2009. This work was supported in part by Hitachi, Ltd., by the members of the MIT Media Laboratory Things That Think Consortium, and by Analog Devices, Inc. This paper was recommended by Guest Editor A. Nijholt.

D. Olguín Olguín, B. N. Waber, T. Kim, A. Mohan, and A. Pentland are with the Human Dynamics Research Group, Media Laboratory, Massachusetts Institute of Technology, Cambridge, MA 02139 USA (e-mail: dolguin@media.mit.edu; bwaber@media.mit.edu; taemie@media.mit.edu; amohan@media.mit.edu; pentland@media.mit.edu)

K. Ara is with the Hitachi Advanced Research Laboratory, Tokyo 185-8601, Japan.

Color versions of one or more of the figures in this paper are available online at <http://ieeexplore.ieee.org>.

Digital Object Identifier 10.1109/TSMCB.2008.2006638

studying individual, group, and organizational processes. Some of the questions it tries to answer are the following [1]: How can goals be set to enhance people's job performance? How may jobs be designed so as to enhance employees' feelings of satisfaction? Under what conditions do individuals make better decisions than groups? What can be done to improve the quality of organizational communication? How can leaders enhance the effectiveness of their teams? In this paper, we set the foundations for developing the technology and methodology that will enable social scientists to automatically measure individual and collective patterns of behavior, predict human behavior from unconscious social signals, identify social affinity among individuals, and enhance social interactions by providing real-time feedback. Our purpose is to shed some light on the questions posed by the field of organizational behavior.

Standard methods to measure and evaluate human behavior, such as surveys, often suffer from subjectivity and memory effects. In [2], Pentland envisioned a device that could accurately and continuously track the behavior of hundreds of humans at the same time, recording even the finest scale behaviors with great accuracy. Such a device would replace expensive and unreliable human observations with automated computer-mediated ones. The automatic discovery and characterization of face-to-face communication and social interaction would allow us to gather interaction data from large groups of people. This could potentially remove two of the current limitations in the analysis of human behavior: the number of people that can be surveyed and the frequency with which they can be surveyed.

Data mining of e-mail has also provided important insights into how organizations function and what management practices lead to greater productivity [3], but important communications are usually face-to-face [4]. Some previous research also anticipates the incompleteness of data based on e-mail communication and surveys [5]. Today people carry cell phones and wear radio frequency ID badges. These body-worn sensor networks mean that we can potentially know who talks to whom and even how they talk to each other. Organizations will become truly *sensible* when they start deploying hundreds or thousands of wireless environmental and wearable sensors capable of monitoring human behavior, extracting meaningful information, and providing managers with group performance metrics and employees with self-performance evaluations and recommendations [6].

Even though some devices already incorporate sensors capable of capturing context information, we believe that there is no

single platform capable of measuring a wide range of variables such as the amount of face-to-face interaction, nonlinguistic social signals, location, physical proximity to other people, and context information to facilitate the study of human behavior in organizations.

In this paper, we present the design, implementation, and evaluation of a wearable computing platform for measuring and analyzing human behavior by capturing and analyzing the aforementioned variables. We have instrumented a group of 22 employees working in a real organization for a period of one month to study communication patterns (face-to-face interaction versus e-mail), proximity to other people, physical activity levels, and conversational time. The remainder of this paper is organized as follows. Section II describes the background and previous work on socially aware wearable platforms and electronic badges. Section III describes the proposed technology. Section IV describes the proposed methodology to automatically measure organizational behavior. Section V presents related theory and our hypotheses. Section VI presents experimental results. Section VII examines different applications of this wearable computing platform. Finally, Section VIII presents the conclusions and future work.

## II. BACKGROUND AND PREVIOUS WORK

### A. Socially Aware Systems

Psychologists have firmly established that social signals are a powerful determinant of human behavior and speculate that they may have evolved as a way to establish hierarchy and group cohesion [7]–[9]. Most culture-specific social communications are conscious; however, other social signals function as a subconscious collective discussion about relationships, resources, risks, and rewards. In essence, they become a subconscious “social mind” that interacts with the conscious individual mind. In many situations, the nonlinguistic signals that serve as the basis for this collective social discussion are just as important as the conscious content for determining human behavior [7]–[11].

How can socially aware systems change human communications? How can knowing the social context and, particularly, speaker attitude help? A simple way is to provide people with feedback on their own interactions. Did a person adopt a forceful attitude during a negotiation? Did a person project a helpful empathic attitude during the teleconference? Such feedback can potentially head off many unnecessary problems.

Measurements of social signaling can also help group interactions. Social scientists have carefully studied how groups of people make decisions and the role of social context in that process. Unfortunately, what they have found is that socially mediated decision making has some serious problems, including group polarization, *groupthink*, and several other types of irrational behaviors that consistently undermine group decision making [8]–[10], [12]. To improve group function, one needs to be able to monitor social communication and provide real-time intervention. Human experts can do that (they are called facilitators or moderators) but, to date, machines have been blind to the social signals that are such an important part of

human group function. The challenge, then, is how to make a computer recognize social signaling patterns.

Similarly, the ability to measure social variables like interest and trust ought to enable more productive discussions, while the ability to measure social competition offers the possibility of reducing problems like *groupthink* and polarization. If a computer can measure the early signs of problems, then it can intervene before the situation becomes unsalvageable.

Our research group (the *Human Dynamics Group*) at the MIT Media Laboratory has developed several socially aware platforms to measure different aspects of social context. We describe some of these platforms next.

- 1) *The SocioMeter*. A wearable sensor package designed to measure face-to-face interactions between people with an infrared (IR) transceiver, a microphone, and two accelerometers [13]. It was used to learn social interactions from sensory data and model the structure and dynamics of social networks.
- 2) *VibeFones*. The VibeFone application is a mobile social software that uses the location, proximity, and tone of voice to gain a sophisticated understanding of people’s social lives by mining their face-to-face and phone interactions. It was used in several applications such as the automatic characterization of social and workplace interactions, a courtesy reminder for phone conversations, and a personal trainer for dating encounters. This application augments the traditional means of gathering social interaction data (surveys or ethnographic studies) and speech data. The mobile phone platform is highly conducive to collecting long-term continuous data and sampling the user for training labels [14].
- 3) *Social Motion*. In this application, two types of sensors were used: proximity and motion sensors. Gips [15] showed that these sensing modalities could be incorporated into current mobile devices without disrupting the usage patterns and form factors to which people have grown accustomed. He also demonstrated that these sensor signals contained the information necessary to infer the underlying social structure of groups of people about which no information is known *a priori* by identifying groups of friends taking part at a career fair, team membership of students participating in a treasure hunt game, and company affiliation of visitors attending a conference.

### B. Electronic Badges

Wearable ID badges are common devices that employees wear in large organizations to identify themselves to others or to gain access to certain locations or information. The *Active Badge* developed at Xerox PARC in 1992 was one of the first attempts to augment inanimate name tags with electronics. Containing only a small microprocessor and an IR transmitter, this badge could broadcast the identity of its wearer and trigger automatic doors, automatic telephone call forwarding, and computer displays [16], [17].

More complex badge platforms have been developed after the *Active Badge*. In 1996, the *Thinking Tags* [18] were the

first computationally augmented name tags that were capable of displaying how much two people at a conference or meeting had in common. Two years later they evolved into the *Meme Tags* [19], allowing conference participants to electronically share brief ideas or opinions through a large LCD screen. This later became the *nTAG System*, a commercial solution to improve, measure, and automate meetings and events [20].

The *Wearable Sensor Badge* developed at Philips Research Labs in 1999 [21] was capable of detecting simple preambulatory activities using an accelerometer. The *iBadge* [22] was designed to be worn by children to capture interactions with teachers and common classroom objects. The *UbER Badge* [23], developed at the MIT Media Laboratory, is a research platform for facilitating interaction in large groups of people. A more recent research platform developed jointly by Intel Research and the University of Washington is the *Mobile Sensing Platform*. It is a multimodal sensor board that captures data from seven different sensors and is primarily designed for embedded user activity recognition [24].

The best known commercially available badge system is the 802.11-based *Vocera Communications System* [25]. Users interact through wearable badges that can be clipped to coat pockets, worn as pendants, or carried in holsters. The system centers on a server that maintains voice dialing phrases, badge session identifiers, e-mail addresses, telephone numbers, and names. Our wearable electronic badge has a similar form factor to the Vocera badge since the latter is already accepted by thousands of users in hospitals, retail stores, and service organizations [26].

### III. SOCIOMETRIC BADGES

In [27], we presented the design of a wearable *communicator* badge, a push-to-talk system capable of playing audio messages and reminders through a speaker. Since then, the *communicator* badge has evolved into what we call a *sociometric* badge, a device whose main purpose is to automatically capture individual and collective patterns of behavior. We have manufactured 300 *sociometric* badges and used them in real organizations to automatically measure individual and collective patterns of behavior, predict human behavior from unconscious social signals, identify social affinity among individuals working in the same team, and enhance social interactions by providing feedback to the users of our system [28]. Fig. 1 shows a picture of our *sociometric* badge.

#### A. Capabilities

The *sociometric* badges have a small form factor, are comfortable to wear over long periods of time, and have a long battery life. To achieve this, the badges were designed for very low power wake-up directly from sensor stimuli. In addition to some of the main features offered by previous badge platforms, the *sociometric* badges are capable of the following.

- 1) Recognizing common daily human activities (such as sitting, standing, walking, and running) in real time with at least 80% accuracy on average, using a three-axis



Fig. 1. Wearable *sociometric* badge.

accelerometer combined with a mobile phone containing a second accelerometer [29].

- 2) Extracting speech features in real time to capture nonlinguistic social signals such as interest and excitement, the amount of influence each person has on another in a social interaction, and unconscious back-and-forth interjections, while ignoring the words themselves in order to assuage privacy concerns [30].
- 3) Communicating with radio base stations in the 2.4-GHz frequency band for sending and receiving information to and from different users, and transferring data. The base stations can either be other badges placed at fixed locations or compatible radio base stations, such as the *Plug* sensor network developed in the Responsive Environments group at the MIT Media Laboratory [31].
- 4) Performing indoor user localization by measuring received signal strength and using different triangulation algorithms that can achieve position estimation errors as low as 1.5 m [32], [33].
- 5) Communicating with Bluetooth-enabled cell phones, personal digital assistants, and other devices to study user behavior, detect people in close proximity, and even predict people's day-to-day and person-to-person communication with more than 95% accuracy [34].
- 6) Capturing face-to-face interaction time using an IR sensor that can detect when two people wearing badges are facing each other within a 30° cone and 1-m distance). Choudhury [13] showed that it was possible to detect face-to-face conversations using the *SocioMeter* badges with 87% accuracy when looking at segments that lasted at least 1 min.

#### B. Technical Specifications

Each badge uses an omnidirectional microelectromechanical systems (MEMS) microphone (Knowles Acoustics, SPM0103-NE3) to capture the user's speech and extract different speech features without recording the actual speech signal. The microphone is connected to a noninverting operational amplifier (Analog Devices, AD8542), with a high-pass filtering cutoff frequency of 85 Hz and a low-pass cutoff frequency of

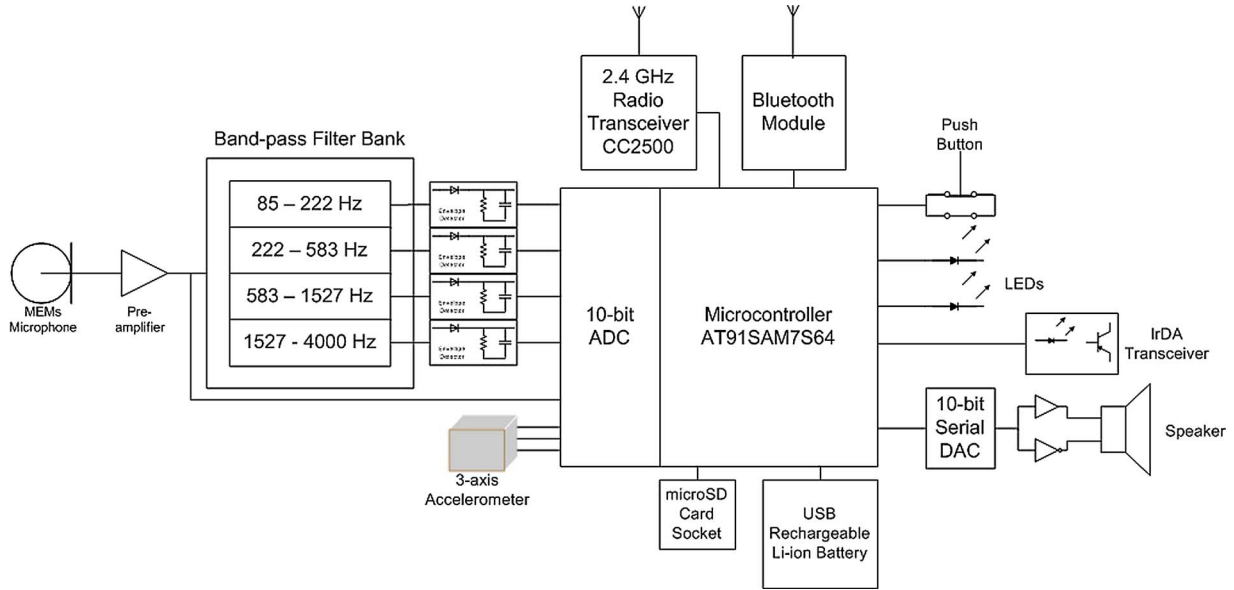

Fig. 2. Wearable *sociometric* badge's block diagram.

4000 Hz. The amplified microphone signal is then applied to an array of micropower single-op-amp Sallen–Key bandpass filters that divide the speech frequency spectrum into four octaves:  $f_1$  from 85 to 222 Hz,  $f_2$  from 222 to 583 Hz,  $f_3$  from 583 to 1527 Hz, and  $f_4$  from 1527 to 4000 Hz. A diode-capacitor peak detector is used after each bandpass filter to obtain the spectral envelope in each frequency band. These four spectral envelopes are used to segment the audio signal into speaking and nonspeaking regions. A three-axis MEMS accelerometer (Analog Devices, ADXL330) is used to detect when a person is moving and identify different activities such as sitting, standing, walking, or running. An IR transceiver module (Vishay, TFDU4300) is used to detect when two people are facing each other. A bridged-output audio power amplifier (Analog Devices, SSM2211) drives an electromagnetic speaker on the badge to play back messages and reminders.

The main processing unit is an ARM microcontroller (Atmel, AT91SAM7S256). A 2.4-GHz wireless transceiver (Chipcon, CC2500) and a class 2.0 Bluetooth module (BlueRadios, BR-46AR) have been incorporated for enabling wireless communications with fixed base stations and other Bluetooth-enabled devices. A microSD memory card socket has been included for storing data when the user is out of range of a fixed point or when the badge is used as a self-contained sensor package. The badge is powered by a 950-mAh lithium-polymer battery that is rechargeable through USB. In addition, data can also be transferred through the USB port. The dimensions of the badge inside the plastic enclosure (as shown in Fig. 1) are  $4.5 \times 10 \times 2$  cm, and the total weight including the battery is 110 g. Fig. 2 shows a block diagram of the badge.

#### IV. METHODOLOGY

In this section, we describe the methodology for automatically measuring human behavior in organizational settings using *sociometric* badges. This methodology can also be applied to other wearable sensing devices with similar capabilities.

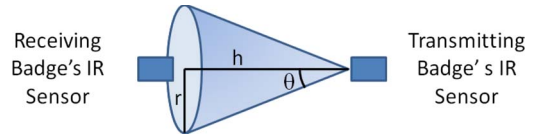

Fig. 3. Face-to-face interaction is detected when the receiving badge's IR sensor is within the transmitting badge's IR signal cone.

Our proposed approach to capture social signals and measure human behavior has several advantages over existing methods such as the direct observation by humans, the use of pervasive cameras to videotape social interactions, or the use of surveys. The direct observation of humans by humans is expensive and limited to a few subjects per observer, and observers do not always agree. Deploying pervasive cameras is extremely expensive, and their range of measurement is constrained to a particular place. The use of surveys is subjective, inaccurate, and time consuming. In contrast, being able to automatically capture the behavior of hundreds of people at the same time using the technology described in Section III allows us to perform fine-grained analyses of an organization's minute-to-minute operations without the need of human observers.

##### A. Detecting Face-to-Face Interactions

IR can be used as a proxy for the detection of face-to-face interaction between people. In order for one badge to be detected through IR, two *sociometric* badges must have a direct line of sight. The receiving badge's IR sensor must be within the transmitting badge's IR signal cone of height  $h \leq 1$  m and radius  $r \leq h \tan \theta$ , where  $\theta = \pm 15^\circ$  for the IR sensor described in Section III-B. Fig. 3 shows a receiving badge's IR sensor within the specified range. Every time an IR signal is detected by a badge, we say that face-to-face interaction may occur.

We define the total amount of face-to-face interaction time per person as the total number of consecutive IR detections per person multiplied by the IR transmission rate.

## B. Measuring Physical Proximity and Location Using Bluetooth

The *sociometric* badges can detect other Bluetooth devices in close proximity in an omnidirectional fashion (within a 10-m radius). In the past, this functionality has been used to identify location, behavioral patterns, and social ties [34]. It is possible to determine approximate location from base stations and other mobile badges using Bluetooth technology. If a person is detected within the Bluetooth transceiver's range, it does not necessarily mean that they are interacting with each other. However, we can ascertain that they are in close proximity to each other, easily reachable for face-to-face interaction. It is possible to obtain more accurate proximity measurements (1-m resolution) by using received signal strength indicator values from the Bluetooth or wireless transceiver.

## C. Detecting Physical Activity Levels

The three-axis accelerometer signal is sampled at  $f_s = 250$  Hz, which should be able to capture the range of human movement and could be as low as 30 Hz since 99% of the acceleration power during daily human activities is contained below 15 Hz [35]. The range of values for the accelerometer signal varies between  $-3g$  and  $+3g$ , where  $g = 9.81$  m/s<sup>2</sup> is the gravitational acceleration. To normalize the signals, a calibration procedure is necessary to obtain the absolute value of gravity  $|\vec{g}|$  and the zero gravity point  $\vec{g}_0 = (g_{x_0}, g_{y_0}, g_{z_0})$ . To obtain these values, one badge should be slowly rotated in all directions.

The accelerometer samples recorded from each badge  $\vec{a}_i = (a_{x_i}, a_{y_i}, a_{z_i})$  are normalized as follows:

$$\vec{a}'_i = \frac{\vec{a}_i - \vec{g}_0}{|\vec{g}|}. \quad (1)$$

The acceleration signal vector magnitude (SVM) provides a measure of the degree of movement intensity that includes the effect of signal variations in the three axes of acceleration [36]. The SVM is calculated on the normalized  $i$ th acceleration sample as follows:

$$\text{SVM}_i = |\vec{a}'_i| = \sqrt{a'^2_{x_i} + a'^2_{y_i} + a'^2_{z_i}}. \quad (2)$$

To distinguish between periods of activity and rest, the average SVM is calculated over 1-min segments

$$\text{SVM}(k) = \frac{1}{f_s T} \sum_{i=1+f_s T(k-1)}^{f_s T k} \text{SVM}_i \quad (3)$$

where  $T = 60$  is the time segment (in seconds) over which the average SVM is calculated and  $k = 1, \dots, K$  is the number of minutes a person was wearing the badge during the day. When the badge is static and not being worn,  $\text{SVM}(k) \leq 1$ , since only the component of gravitational acceleration is detectable. The individual daily activity level is defined as  $\text{SVM}_d = 1/K \sum_{k=1}^K \text{SVM}(k)$ , where  $K$  is the number of minutes that a person was wearing the badge and  $d$  is the date.

We say that a person is in a *high* activity level when their activity level is one standard deviation above the mean value of everyone wearing the badge at the same time. A person is in a *low* activity level if their activity level is one standard deviation below that mean value, and they are in a *regular* activity level if their activity level is within one standard deviation of that mean value.

## D. Detecting Speech

Objective social signaling measures based on nonlinguistic vocal attributes to determine social context have been developed within our research group [30]. We take a similar approach to characterize the interaction between individuals and determine the percentage of time that an individual is engaged in a conversation.

The audio signal captured by the badge is sampled at  $f_s = 8000$  Hz; then, it is passed through an array of four bandpass filters and peak detectors to obtain the spectral envelopes for each frequency band (described in Section III-B). These five values derived from the raw audio signal and the filter envelopes are averaged over 64 samples (8 ms). The averaging ensures that one cannot determine the content of the conversation or identify the speaker from the data. Offline analysis of the stored data is done to determine time segments when an individual was in a conversation. The audio is divided into frames and variation in amplitude calculated for each frame, where a frame here means 32 ms of audio with an overlap of 16 ms, corresponding to four and two samples of the averaged signal, respectively. This variation in amplitude for each frame can be used to determine whether the individual was involved in a conversation during the given frame.

## E. E-mail Analysis

E-mail has been frequently used to measure social ties between individuals [3]. Not only is it easy to measure but also, in the modern workplace, employees are interacting with each other more and more frequently through e-mail. These data are also easily quantifiable, since we know exactly who sent an e-mail to whom and when. Because e-mail only captures digital interactions, it is unclear whether this accurately represents "real world" interactions. In our analysis, we take the approach of comparing e-mail data with the data collected by the *sociometric* badges. In general, large-scale unidirectional e-mails have little value when analyzing one-on-one interaction. Therefore, we only consider reciprocated e-mails when examining relationships between individuals.

## F. Combining Face-to-Face and Electronic Communication

Another question that arises is how to combine social network data from multiple sources. It is still unclear how many e-mails are equivalent to face-to-face interactions detected over IR. However, if we normalize the values such that the greatest number of monthly pairwise (IR detections)/(e-mails) is 1, then we can posit that this will offer a better solution than simply adding the two adjacency matrices together. Ideally, we would



use a weighting factor that would discount the e-mail ties by some multiplicative factor because of the intuition that e-mail indicates weaker social ties than face-to-face interaction, but currently, we cannot justify choosing a particular factor. In future work, we plan to study this relationship in greater detail.

We must also account for links between actors through e-mail that are entirely absent in the face-to-face network. If two people are seen as accessible to each other over Bluetooth and have no face-to-face interaction but do have e-mail exchanges, there are two possible explanations. The first is that these individuals simply do not know that they are proximate to each other. This is unlikely, since the range of Bluetooth is 10 m, and individuals that communicate with each other frequently over e-mail would likely interact if they saw each other in person. Although IR does not detect all face-to-face interactions, over the course of a month, it would likely catch one if the individuals occasionally interacted. The second explanation is that a social tie does not exist between these two actors, that they are, in fact, exchanging e-mail as a matter of their official duties, such as CC-ing all members of the division. Therefore, when combining information, we remove e-mail ties that fall into this category. We define “total communication” as the combined information of IR detections and e-mail exchanged.

### G. Relational Data Analysis

Relational data (i.e., IR detections, e-mail exchanged, and Bluetooth proximity) must be placed into an adjacency matrix in order to analyze it under a social network framework. In relational data, there are two participants: a sender  $i$  and a receiver  $j$ . We, for example, define the matrix  $A$  with elements  $a_{ij}$  such that

$$a_{ij} = \max(a_{ij}, a_{ji})$$

where  $a_{ij}$  is the amount of communication measured between  $i$  and  $j$ . This procedure creates a symmetric matrix and a social network representation.

We define the “betweenness” of a node  $n$  in a social network as the proportion of all paths between any two nodes in the network that pass through  $n$  [37]. Mathematically, we have

$$b_n = \sum_{n \neq v \neq t \forall v, t \in V} \frac{\alpha_{vt}(n)}{\sum_{i \neq v \neq t \forall i \in V} \alpha_{vt}(i)} \quad (4)$$

where  $\alpha_{vt}(n)$  is the number of unique paths in the social network from node  $v$  to node  $t$  that pass through  $n$  and  $b_n$  is the betweenness of  $n$ .

## V. RELATED THEORY AND HYPOTHESES

### A. Copresence Versus Electronic Communication

Copresent communication occurs when there is direct face-to-face interaction. There are several factors that affect face-to-face communication. For instance, Zahn [38] studied the effects of hierarchical relationships and physical arrangements on face-to-face communication in an office environment.

Mutual exposure and physical distance were used as predictors of communication time.

Electronic communication channels include telephone, fax, e-mail, instant messaging, and video conferencing among others. Previous studies have attempted to extract social network structures by looking at e-mail only [39]. For instance, Grippa *et al.* [5] compared the social networks implied by four different media: e-mail, face-to-face, chat, and phone in order to identify to what extent the network implied by e-mail differs from the network implied by other communication media. They found that e-mail alone defined 72% of a social network’s density, the total number of edges implied by merging e-mail and chat explained 85% of the overall network density, and the complete network’s density was entirely described by combining e-mail and face-to-face communication.

Thus, in common with most research in this area, we hypothesized as follows.

*Hypothesis 1 (H1):* The greater the number of people who are in close proximity to an individual, the greater volume of electronic communication the individual will have.

### B. Total Communication and Satisfaction

There has been extensive research on the occurrence of communication overload and its effects [40]–[46]. Individuals who become overloaded with communication responsibilities have difficulties focusing on the tasks at hand and coping with their responsibilities [44]. Subsequently, their overall level of satisfaction with their situation will decrease [40]. If we are able to capture both face-to-face and electronic communication, then we should be able to gauge the degree of communication overload experienced by an individual. This leads us to the following.

*Hypothesis 2 (H2):* The greater the amount of total communication an individual has, the lower level of satisfaction the individual will have.

### C. Social Role and Satisfaction

There has been substantial research on the effect of official role on job satisfaction [47]–[49]. However, the effects of the social role of employees have not been thoroughly studied. Social role is often represented by the centrality of individual employees in the social network. There are multiple measures of centrality: in-degree, out-degree, betweenness, and closeness [50]. However, we chose to use betweenness as our centrality measure because betweenness indicates the degree to which an individual is playing an “intermediary” role in the social network. The betweenness of an individual measures the extent to which they can play the part of a “broker” or “gatekeeper” with the potential for control over others [37].

Brass found that people with higher betweenness had lower level of satisfaction [51]. Brass explains this negative correlation by the strong relationship of job satisfaction and job characteristics, such as autonomy and variety. Since individuals with low centrality tend to be in jobs with high autonomy and low task interdependencies, they are easily satisfied by

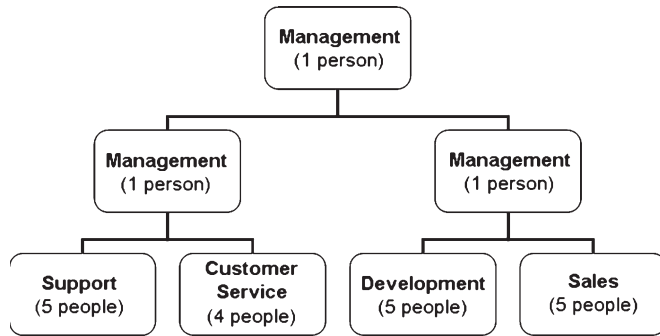

Fig. 4. Organizational chart.

individual compensation structures [52]. Hence, we posit the following.

*Hypothesis 3 (H3):* The more central an individual is in an organization, the lower level of satisfaction the individual will have.

## VI. EXPERIMENT

### A. Experimental Setup

We deployed the *sociometric* badges described in Section III for a period of one month (20 working days) in the marketing division of a bank in Germany that consisted of 22 employees distributed into four teams. Each employee was instructed to wear a badge every day from the moment they arrived at work until they left their office. In total, we collected 2200 h of data (100 h per employee) and 880 reciprocal e-mails.

The employee pool had exactly the same number of men as women, but all of the managers were men. The division contained four functional teams consisting of either three or four employees. Each of these teams was overseen by a manager, who was, in turn, supervised by a midlevel manager. These midlevel managers were responsible for two teams, and they reported directly to the division manager. The division's organizational chart is shown in Fig. 4. We treated the mid- and division-level managers as a single team in the analysis.

The bank division itself also had a very interesting physical layout. The division was split across two floors, and some teams were colocated in a single room while others had employees from multiple teams in them. There were six rooms in the second floor and four rooms in the third floor. In fact, one of the reasons why this division took such an interest in the experiment was to determine precisely what effect this physical layout had on the interactions that occurred within the division.

The objective of the experiment was to use data collected using our wearable electronic badges to correlate temporal changes in social interaction patterns (including amount of face-to-face interaction, conversational time, physical proximity to other people, and physical activity levels) with performance of individual actors and groups. We obtained e-mail logs as well as self-reported individual and group performance satisfaction data as part of a case study on the impact of electronic communications on the business performance of teams [53]. These data gave us a very detailed picture of the inner operations of the division.

### B. Experimental Procedure

The *sociometric* badges logged IR detections (containing the transmitting badge's ID) every time they were facing other badges, Bluetooth devices' IDs, motion data from the accelerometer, and raw and bandpass filtered audio. The IR transmission rate was set to one ID transmission every 2 s. Each badge was detectable over Bluetooth every 10 s, and each badge performed a Bluetooth scan every 5 s. The audio was sampled at 8 kHz and averaged over 64 samples so that the raw speech signal could not be reconstructed in order to maintain privacy. All data collected were anonymized, and each participant had access only to their own data upon request.

In addition to the 22 wearable badges, 14 badges were used as base stations and placed in fixed locations across two floors of the bank's building to roughly track the location of interaction events as well as subjects. Base stations were continually discoverable over Bluetooth. A central computer was used for data collection and was placed in the division's conference room, where employees could easily retrieve their badges when they arrived and plug them into a USB hub before they left for the day. This operation allowed data to be automatically transferred via the badge's USB port and uploaded to a server in our laboratory once a day, while at the same time, recharged the badge's battery.

At the end of each day, employees were asked to respond to an online survey that included the following questions.

- Q1) What was your level of productivity today?
- Q2) What was your level of job satisfaction today?
- Q3) How much work did you do today?
- Q4) What was the quality of your group interaction today?

We modeled our questions on those that are frequently used in the literature [54]. Each question could be answered according to the following five-point likert scale: (1 = very high)(2 = high)(3 = average)(4 = low)(5 = very low). Each person had to enter their badge number when they answered the survey. In the following sections, we describe the results of this experiment.

### C. Results—Copresence and Electronic Communication

In this experiment, we used e-mail as a representative proxy for electronic communication since it was the most frequently used means of communication among employees of this organization. In future experiments, we plan to incorporate other electronic communication channels in our analysis.

Initially, we hypothesized that Bluetooth detections could be used to recognize office level locations and conversational groups. However, the large range of the Bluetooth receivers made this task extremely difficult, limiting the resolution of our data. This caused us to take a different approach to the analysis. Since closer devices were detected more often, we say that two people are in close proximity to each other only if their Bluetooth IDs were detected for more than 15 min during 1 h. This accounts for the limited Bluetooth detection rate.

Over the course of the experiment, the average number of different people in close proximity to an individual per hour was measured using this approach. The range of values for this



measure was 0.125–4.12 people per hour. The total number of e-mail exchanges during the study was in the range of 15–149. We found that the number of people in close proximity had a high negative correlation with the number of e-mail exchanges ( $r = -0.55$ ,  $p < 0.01$ ,  $N = 22$ ). This is contrary to hypothesis H1, and therefore, we can conclude that the greater the number of people who are in close proximity to an individual, the lower volume of electronic communication the individual will have. This has powerful implications for previous work that has used e-mail communication as a proxy for the social network of an organization, since in the past, e-mail has been used as a proxy for all communication channels [55].

We can attribute this to several factors. First, if you are in close proximity to another individual, it makes more sense to interact with them in the real world rather than send them an e-mail. Second, proximity information also picks up on informal relations, while in this particular organization, e-mail is used mainly for business purposes. This result points toward the necessity of having face-to-face interaction information in order to have a full view of the social network.

When we grouped people by floor, we observed that people on the second floor had a lower number of easily reachable people per day than people on the third floor ( $\mu_{2\text{nd}} = 4.08$  people,  $\mu_{3\text{rd}} = 15.08$  people, with  $p < 0.01$  and  $N = 22$ ), and the average number of e-mails exchanged during the entire month was higher for people on the second floor ( $\mu_{2\text{nd}} = 96.4$  e-mails,  $\mu_{3\text{rd}} = 37.7$  e-mails, with  $p < 0.001$  and  $N = 22$ ). However, we were not able to group people by room since the Bluetooth range was greater than the separation between rooms. Hence, we can posit that people on the third floor are more stationary, staying in their office most of the time, allowing for predictable face-to-face communication, and mitigating the need for e-mail. On the other hand, people on the second floor are more mobile, often out of their office, requiring them to use more asynchronous communication channels such as e-mail. These results were obtained using a one-way analysis of variance.

These results also suggest that, while social mobility is important, it causes an individual to be less available for face-to-face communication, thus increasing e-mail exchanges. It would be interesting, however, to examine which way the causality actually goes. Plotting the individual patterns on a Bluetooth detection versus e-mail exchange plane allows us to see the distinct patterns of the two floors (Fig. 5). With only the e-mail count, we would have seen a continuous pattern of communication in the individuals. However, Bluetooth detection allows us to see another dimension of how people interact with each other, verifying the limits of using only e-mail as a measure of social interaction.

#### D. Results—Total Communication and Satisfaction

When we examined the total communication of each individual, we found that it had a very high negative correlation with the monthly averages of questions Q2 (job satisfaction) and Q4 (group interaction satisfaction) ( $r = -0.48$  and  $r = -0.53$ , respectively, with  $p < 0.05$  and  $N = 22$  in both cases). This confirms hypothesis H2, namely, that as an individual

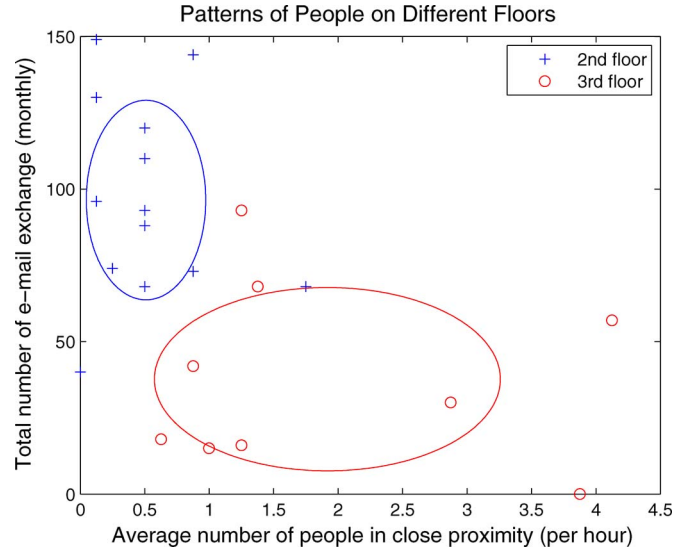

Fig. 5. Copresence and electronic communication patterns of people on different floors. People on the second floor have lower Bluetooth detections and more e-mail exchanges than people on the third floor. Points denote individuals; ellipses denote the one-sigma boundaries of each class.

engages in more and more communication, their satisfaction level decreases.

It is important to note that this relationship was not found when examining face-to-face and e-mail data separately; the data had to be combined. This result stresses the importance of capturing face-to-face communication, since if only e-mail data are collected, significant measures of social context are lost.

#### E. Results—Social Role and Satisfaction

Observing the betweenness calculated from the pattern of total communication, we found that betweenness was highly negatively correlated with the monthly average of Q4 (group interaction satisfaction) ( $r = -0.49$ ,  $p < 0.05$ ) and therefore confirms hypothesis H3. This relationship is shared with total communication and Q4; however, betweenness and total communication were not significantly correlated.

In line with the results of hypothesis H2, this strong negative correlation was found only in the communication network of total communication, not in separate observations of face-to-face and e-mail. Hence, we can understand that the individual's role in the communication network, including both copresent and electronic communication, is a strong indicator or an employee's satisfaction level.

#### F. Results—Predicting Satisfaction

A multilinear regression was fit to model question Q4 (group interaction satisfaction) using total communication and betweenness. We found that this regression had a correlation coefficient of  $r = 0.62$  with  $p = 0.01$  (explaining about 30% of the variance in group interaction satisfaction) and coefficients  $\beta_0 = 3.81$ ,  $\beta_1 = -0.19$ , and  $\beta_2 = -0.17$ , where  $\beta_0$  is the intercept coefficient, and  $\beta_1$  and  $\beta_2$  are the coefficients for total communication and betweenness, respectively. Thus, the combination of these two measures has good explanatory

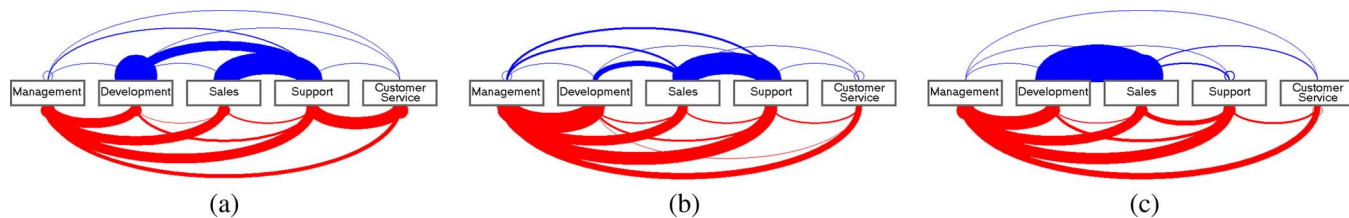

Fig. 6. (Arcs below each block) E-mail exchange volume and (arcs above each block) face-to-face communication time. (a) Day 1. (b) Day 2. (c) Day 3.

power, and since their coefficients are nearly the same size, they are both explaining different portions of the data.

## VII. APPLICATIONS

### A. Communication Flow Visualization

Using e-mail and face-to-face interaction data collected in the experiment described in Section VI, we were able to create a dynamic visualization that shows communication flow within and between teams. While e-mail data shows little variation across days, face-to-face communication patterns change dramatically day by day.

In Fig. 6(a)–(c), the amount of e-mail messages exchanged across teams is represented by the thickness of the red arcs below each box, and the amount of face-to-face interaction is represented by the thickness of the blue arcs above each box. This provides a useful and intuitive method of visualizing the total communication within an organization. This display, along with similar visualizations, provided the evidence that guided the bank described in Section VI-A to reorganize this division.

### B. Team Dynamics Analysis

By studying the correlation among behavioral patterns (e.g., attitude, communication, and business processes) and performance (e.g., productivity, sales, and customer satisfaction), we can discover and quantify effective behavior patterns. Comparison between and within teams would allow managers and team members to identify what behavior patterns lead to desirable results and subsequently replicate those behaviors. Once we uncover effective behavior patterns, we can try to improve productivity and individual satisfaction by changing various factors.

1) *Physical Environment*: Studies have consistently shown that, in office environments where employees can easily access each other, productivity flourishes [56]. However, exactly what is the change effected by removing cubicle walls? If an organization has specific problems, how can these be combatted architecturally? Using the *sociometric* badge sensing platform, organizations and architects can measure the social effects of minute changes in the physical environment and allow others' knowledge to be transferred across organizations. This may lead to a new understanding of how to design environments.

2) *Information Technology Environment*: Precisely measuring the effects of changes to the information technology environment has also been a challenge, although researchers have recently begun tackling this problem [55]. Our sensing architecture allows managers to perform social science experiments of their own to determine if providing new tools to parts of

the organization is worth the investment. Instead of looking at largely meaningless individual and group metrics, managers can see how changes quantitatively effect individual and group behavior.

3) *Organizational Communication Methods*: If an employee is promoted to lead another group, what is the effect on the group that they left? If the high performing individual who was promoted ended up being the connector who held together group communication, substantial preparation would be needed to ensure that the team could still function without this individual. Our sensing platform naturally leads to this type of analysis. It may also be found that certain teams function better because of their communication opportunities in the form of accepted contact channels. This can be automatically extracted from the data our sensors provide.

4) *Individual Behavior*: Certain individuals are better at interacting with people. While this is a fact of life, it is often the ethereal nature of such a quality that leads us to believe that we cannot capture even part of it. However, previous research from our group has shown that we can indeed tease out characteristics of interaction that lead to favorable (and unfavorable) outcomes [30]. By communicating this information to the applicable set of individuals, we can expand the social capital of an organization tied in communication by an order of magnitude.

### C. Sensible Orb

We can encourage movement toward higher performance and motivation by providing individual activity data for self-reflection. Both real-time and longitudinal information can be used for this purpose, and it is also helpful if individuals can compare their behavior with skilled or experienced others or aggregates of the total population.

There is extensive previous work on expressing quantitative and qualitative data using color spectra. Liu and Maes [57] proposed to visualize opinions through color and texture, and in a later work, he denoted textual context by using color patterns [58]. In the commercial world, users can purchase an Ambient Orb [59] and customize it so that it will retrieve data from the Web. This includes information such as stock prices, weather, and traffic conditions. The result is displayed using a mapping to a color spectrum.

The *Sensible Orb* is another implementation of such intuitive visualization tools. A major objective of the *Sensible Orb* is to provide users with multiple channels of processed data in an informative and manageable way. This gives users a reflection tool that allows them to make a more educated decision on how they should act in the future. The first version that we have

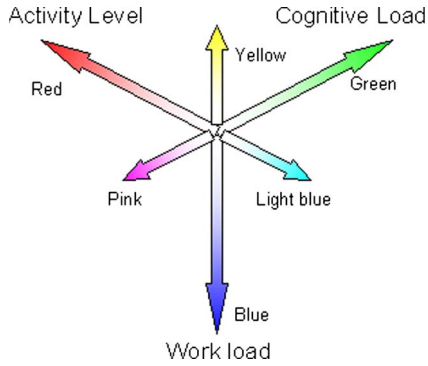

Fig. 7. *Sensible Orb's* color map.

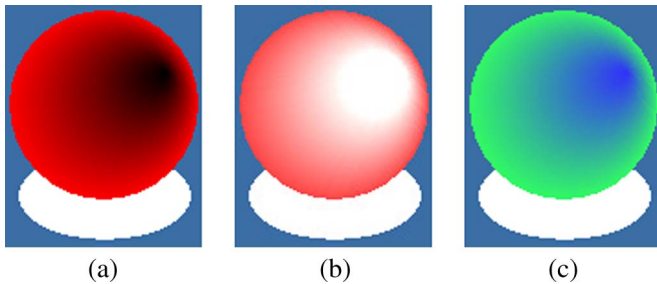

Fig. 8. User's state transition. (a) Moving toward less activity. (b) Moving toward a balanced flow state. (c) Increasing workload.

implemented indicates a user's estimated activity level, cognitive load, and workload by varying the color of the orb. Activity level, cognitive load, and workload are assigned to the colors red, green, and blue, respectively. The color mappings used in the *Sensible Orb* are shown in Fig. 7. Each measurement can be a function of the following parameters (features currently used for display are in *italics*):

- 1) activity level: *number of keys typed*, movement energy;
- 2) cognitive load: frequency of changing tasks, number of interruptions, *number of e-mails to read*;
- 3) workload: *hours of work*, number of e-mails sent.

The transition of the user's state is represented by the color pattern of the orb. For example, suppose we map the temporally recent feature values to the middle of the orb and aggregated features to the edge of the orb. Then, we can draw the whole orb by interpolating between these two colors. Fig. 8(a) shows a situation where the user is moving toward less activity, while Fig. 8(b) shows a situation where the user is moving toward a balanced flow state. In Fig. 8(c), we show a situation where the user's behavior patterns suggest that their overall state is changing from appropriate cognitive load (green) to a condition of heavier workload (blue). The "ideal" color is pure white, which indicates a "flow state" balancing workload, stress, and abilities.

Sensor readings from the badge are used to give feedback to the user. This tool gives users the ability to reflect on their actions and improve their behavior through an iterative learning process.

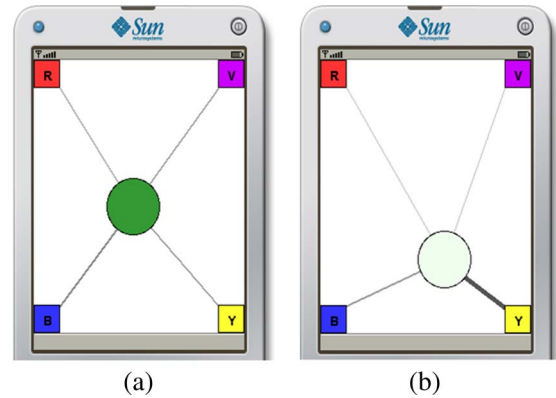

Fig. 9. *Meeting mediator* is an example of a mobile phone-*sociometric* badge application. Each square in the corner represents a participant. The position of the center circle denotes speech participation balance, and the color of the circle denotes the group interactivity level. Fig. 9(a) shows a well balanced and highly interactive group meeting whereas Fig. 9(b) shows that participant Y is heavily dominating the conversation with a low level of turn taking between the participants.

#### D. Meeting Mediator

We have also used mobile phones to display behavior. Mobile phones can communicate with the *sociometric* badge as well as a server via Bluetooth in real time.

The *meeting mediator* is one of the mobile phone applications that we have implemented. It uses *sociometric* badges to help users better understand the flow of a meeting and possibly improve their behavior. This application can be used in various forms of meetings such as lectures, brainstorming sessions, or one-on-one conversations. For example, in a brainstorming session, the *sociometric* badge detects the speaking balance and turn taking pattern of the conversation, and displays this information as shown in Fig. 9. Often, people do not realize how much they are talking and can benefit from reminders to participate more or less in conversations [12], [60].

Initial studies have shown that this application does not interfere with the group task and yet has significant effects on meeting dynamics [61].

## VIII. CONCLUSION AND FUTURE WORK

We have presented the design, implementation, and deployment of a wearable computing platform for measuring and analyzing human behavior in organizational settings. We demonstrated the use of wearable electronic sensors capable of measuring social signals derived from vocal features, body motion, relative location, proximity, and face-to-face interaction to capture individual and collective patterns of behavior. We used *sociometric* badges in a group of 22 employees in a real organization for a period of one month. The badges performed as expected, and users reported of not being self-conscious about wearing them after a few days.

The widespread acceptance of this technology depends on the ability to guarantee the users' privacy and give them feedback about their organization's dynamics. This technology allows us to have a very detailed picture of an individual's social network and their day-to-day actions. However, there is a need for proper data management tools that will allow individuals to share only the data that they are willing to share in an

anonymous way and give them access to aggregated statistics in real time.

Using these automatic measurements, we were able to measure the employees' self-assessment of job satisfaction and their own perception of group interaction quality by combining data collected with our wearable badges and e-mail communication data. We found that the total amount of communication was predictive of both of these assessments ( $r = -0.48$  and  $r = -0.53$ , respectively, with  $p < 0.05$  in both cases), while betweenness in the social network exhibited a high negative correlation with group interaction satisfaction ( $r = -0.49$ ,  $p < 0.05$ ). By combining these two measures (amount of total communication and betweenness), we were able to explain about 30% of the variance in group interaction satisfaction.

We found many interesting results involving different communication channels and behavior patterns. An important finding was that physical proximity to other people was strongly negatively correlated with e-mail communication ( $r = -0.55$ ,  $p < 0.01$ ). This points toward the necessity of having face-to-face interaction information in order to have a full view of the social network. These results demonstrate that we have built a useful platform that can give us information about how people interact and that a network formed from a single communication channel does not accurately represent the complete social network structure. This information would not be available without the use of a device such as the *sociometric* badge. Our results and the ease of deployment argue strongly for the use of automatic sensing data collection tools to understand social systems.

We presented a number of applications that use the collected data to provide feedback to individuals and organizations in an intuitive and valuable manner. In future work, we will refine our analytic methodology by looking at the temporal relationships between different features. We will also perform other experiments to gain a more general understanding of how organizations work. By automatically quantifying human behavior using wearable sensors, we can find relationships between sensor data and organizational performance and thus identify optimal behavior patterns that would lead to improved performance. Further theories that explain the causality of such relationships need to be considered.

The implications of a system that can measure social context are important in a mobile geographically dispersed society. Propagating social context could transform distance learning, for example, letting users become better integrated into ongoing projects and discussions, and thus improve social interaction, teamwork, and social networking. Teleconferencing might become more reflective of actual human contact, since participants can now quantify the communication's value. Our long-term goal is to develop a set of interventions and recommendations that can lead to better individual and group performance.

#### ACKNOWLEDGMENT

The authors would like to thank J. A. Paradiso, the *Responsive Environments Group* at the MIT Media Laboratory, A. Chang, N. Davis, A. Mehta, A. Yeh, P. Gloor, N. Kanehira, D. Oster, and D. Suzuki for their invaluable help in this project.

#### REFERENCES

- [1] J. Greenberg and R. A. Baron, *Behavior in Organizations*, 8th ed. Upper Saddle River, NJ: Prentice-Hall, 2003.
- [2] A. Pentland, "Automatic mapping and modeling of human networks," *Physica A*, vol. 378, no. 1, pp. 59–67, May 2006.
- [3] A. Sinan, E. Brynjolfsson, and M. W. Van Alstyne, "Information, technology and information worker productivity: Task level evidence," in *Proc. Int. Conf. Inf. Syst.*, Dec. 2006, pp. 1–37.
- [4] B. L. Kirkman, B. Rosen, P. Tesluk, and C. B. Gibson, "The impact of team empowerment on virtual team performance: The moderating role of face-to-face interaction," *Acad. Manage.*, vol. 47, no. 2, pp. 175–192, 2004.
- [5] F. Grippa, A. Zilli, R. Laubacher, and P. Gloor, "E-mail may not reflect the social network," in *Proc. North Amer. Assoc. Comput. Social Organizational Sci. Conf.*, Jun. 2006, pp. 1–6.
- [6] K. Ara, N. Kanehira, E. Megally, Y. Poltorak, G. Singh, R. Smith, D. Suzuki, M. Mortensen, M. Van Alstyne, and A. Pentland "Sensible organizations inspired by social sensor technologies," MIT Media Lab., Sloan School Manage., Cambridge, MA, May 2006. Tech. Rep. [Online]. Available: <http://vismod.media.mit.edu/tech-reports/TR-602.pdf>
- [7] A. Pentland, "Social dynamics: Signals and behavior," in *Proc. 3rd Int. Conf. Developmental Learn.*, Oct. 2004, pp. 263–267.
- [8] C. Nass and S. Brave, *Voice Activated: How People Are Wired for Speech and How Computers Will Speak With Us*. Cambridge, MA: MIT Press, 2004.
- [9] N. Ambady and R. Rosenthal, "Thin slices of expressive behavior as predictors of interpersonal consequences: A meta-analysis," *Psychol. Bull.*, vol. 2, no. 111, pp. 256–274, 1992.
- [10] R. Brown, *Group Polarization in Social Psychology*. New York: Free Press, 1986.
- [11] M. Gladwell, *The Tipping Point: How Little Things Can Make a Big Difference*. New York: Little Brown, 2000.
- [12] M. Norton, J. DiMicco, R. Caneel, and D. Arieli, "Antigroupware and second messenger," *BT Technol. J.*, vol. 22, no. 4, pp. 83–88, Oct. 2004.
- [13] T. Choudhury, "Sensing and modeling human networks," Ph.D. dissertation, MIT Media Lab., Cambridge, MA, Feb. 2004.
- [14] A. Madan and A. Pentland, "VibeFones: Socially aware mobile phones," in *Proc. 10th Int. Symp. Wearable Comput.*, Oct. 2006, pp. 109–112.
- [15] J. P. Gips, "Social motion: Mobile networking through sensing human behavior," M.S. thesis, MIT Media Lab., Cambridge, MA, Sep. 2006.
- [16] M. Weiser, "The computer for the 21st century," *Pervasive Comput.*, vol. 1, no. 1, pp. 19–25, Jan.–Mar. 2002. first published in *Scientific American*, Sep. 1991.
- [17] M. Weiser, "The computer for the 21st century," *Sci. Amer.*, vol. 265, no. 3, pp. 94–104, Sep. 1991.
- [18] R. Borovoy, M. McDonald, F. Martin, and M. Resnick, "Things that blink: Computationally augmented name tags," *IBM Syst. J.*, vol. 35, no. 3, pp. 488–495, 1996.
- [19] R. Borovoy, F. Martin, S. Vemuri, M. Resnick, B. Silverman, and C. Hancock, "Meme tags and community mirrors: Moving from conferences to collaboration," in *Proc. ACM Conf. Comput. Supported Cooperative Work*, 1998, pp. 159–168.
- [20] *nTAG Interactive*. [Online]. Available: <http://www.ntag.com/>
- [21] J. Farrington, A. J. Moore, N. Tilbury, J. Church, and P. Biemond, "Wearable sensor badge and sensor jacket for context awareness," in *Proc. 3rd Int. Symp. Wearable Comput.*, Oct. 1999, pp. 107–113.
- [22] S. Park, I. Locher, A. Savvides, A. Chen, R. Muntz, and S. Yuen, "Design of a wearable sensor badge for smart kindergarten," in *Proc. 6th Int. Symp. Wearable Comput.*, Oct. 2002, pp. 231–238.
- [23] M. Laibowitz, J. Gips, R. Aylward, A. Pentland, and J. A. Paradiso, "A sensor network for social dynamics," in *Proc. 5th Int. Conf. Inf. Process. Sensor Netw.*, Apr. 2006, pp. 483–491.
- [24] T. Choudhury, S. Consolvo, B. Harrison, J. Hightower, A. LaMarca, L. LeGrand, A. Rahimi, A. Rea, G. Borriello, B. Hemingway, P. Klasnja, K. Koscher, J. A. Landlay, J. Lester, D. Wyatt, and D. Haehnel, "The mobile sensing platform: An embedded activity recognition system," *Pervasive Comput.*, vol. 7, no. 2, pp. 32–41, Apr.–Jun. 2008.
- [25] Vocera Communications. [Online]. Available: <http://www.vocera.com>
- [26] V. Stanford, "Beam me up, doctor McCoy," *Pervasive Comput.*, vol. 2, no. 3, pp. 13–18, Jul.–Sep. 2003.
- [27] D. Olguin Olguin, J. A. Paradiso, and A. Pentland, "Wearable communicator badge: Designing a new platform for revealing organizational dynamics," in *Proc. 10th Int. Symp. Wearable Comput. (Student Colloq.)*, Oct. 2006, pp. 4–6.
- [28] D. Olguin Olguin, "Sociometric badges: Wearable technology for measuring human behavior," M.S. thesis, MIT Media Lab., Cambridge, MA, May 2007.



- [29] D. Olguin Olguin and A. Pentland, "Human activity recognition: Accuracy across common locations for wearable sensors," in *Proc. 10th Int. Symp. Wearable Comput. (Student Colloq.)*, Oct. 2006, pp. 11–13.
- [30] A. Pentland, "Socially aware, computation and communication," *Computer*, vol. 38, no. 3, pp. 33–40, Mar. 2005.
- [31] J. Lifton, M. Feldmeier, Y. Ono, C. Lewis, and J. A. Paradiso, "A platform for ubiquitous sensor deployment in occupational and domestic environments," in *Proc. 6th Int. IEEE/ACM Conf. Inf. Process. Sensor Netw.*, Apr. 2007, pp. 119–127.
- [32] M. Sugano, T. Kawazoe, Y. Ohta, and M. Murata, "Indoor localization system using RSSI measurement of wireless sensor network based on ZigBee standard," in *Proc. IASTED Int. Conf. WSN*, Jul. 2006, pp. 1–6.
- [33] Y. Gwon, R. Jain, and T. Kawahara, "Robust indoor location estimation of stationary and mobile users," in *Proc. 23rd Annu. Joint Conf. IEEE Comput. Commun. Societies*, Mar. 2004, pp. 1032–1043.
- [34] N. Eagle and A. Pentland, "Eigenbehaviors: Identifying structure in routine," Human Dynamics Research Group, Media Laboratory, Massachusetts Institute of Technology, Sep. 2006, pp. 1–16, Tech. Rep. 601.
- [35] M. J. Mathie, A. C. F. Coster, N. H. Lovell, and B. G. Celler, "Accelerometry: Providing an integrated, practical method for long-term, ambulatory monitoring of human movement," *Physiol. Meas.*, vol. 25, no. 2, pp. R1–R20, Apr. 2004.
- [36] D. M. Karantonis, M. R. Narayanan, M. Mathie, N. H. Lovell, and B. G. Celler, "Implementation of a real-time human movement classifier using a triaxial accelerometer for ambulatory monitoring," *IEEE Trans. Inf. Technol. Biomed.*, vol. 10, no. 1, pp. 156–167, Jan. 2006.
- [37] J. Scott, *Social Network Analysis: A Handbook*. Thousand Oaks, CA: SAGE, 2006.
- [38] L. Zahn, "Face-to-face communication in an office setting: The effects of position, proximity, and exposure," *Commun. Res.*, vol. 18, no. 6, pp. 737–754, 1991.
- [39] C. Bird, A. Gourley, P. Devanbu, M. Gertz, and A. Swaminathan, "Mining email social networks," in *Proc. Int. Workshop Mining Softw. Repositories*, 2006, pp. 137–143.
- [40] D. Gardner and C. Winder, "Using benchmarking to improve organizational communication," *Qual. Assur.*, vol. 6, no. 4, pp. 201–211, Oct. 1998.
- [41] A. Baum, L. Calesnick, E. Glenn, and R. Gatchel, "Individual differences in coping with crowding: Stimulus screening and social overload," *J. Pers. Soc. Psychol.*, vol. 43, no. 4, pp. 821–830, 1982.
- [42] R. Johansen, J. Vallee, and K. Spangler, *Electronic Meetings: Technological Alternatives and Social Choices*. Reading, MA: Addison-Wesley, 1979.
- [43] J. Vallee, R. Johansen, R. Randolph, and A. Hastings, *Group Communication through Computers*, vol. 4. Menlo Park, CA: Inst. Future, 1978.
- [44] E. Kerr and S. R. Hiltz, *Computer-Mediated Communication Systems: Status and Evaluation*. New York: Academic, 1982.
- [45] S. R. Hiltz and M. Turoff, "Structuring computer-mediated communication systems to avoid information overload," *Commun. ACM*, vol. 28, no. 7, pp. 680–689, Jul. 1985.
- [46] S. G. Rogelberg, D. J. Leach, P. B. Warr, and J. L. Burnfield, "'Not another meeting!' Are meeting time demands related to employee well-being?" *Appl. Psychol.*, vol. 91, no. 1, pp. 86–96, 2006.
- [47] O. Pruden and R. Reese, "Interorganization role-set relations and the performance and satisfaction of industrial salesmen," *Adm. Sci. Q.*, vol. 17, no. 4, pp. 601–609, Dec. 1972.
- [48] L. Dyne and S. Ang, "Organizational citizenship behavior of contingent workers in Singapore," *Acad. Manage. J.*, vol. 41, no. 6, pp. 692–703, Dec. 1998.
- [49] A. Kalleberg, "Nonstandard employment relations: Part-time, temporary and contract work," *Annu. Rev. Sociol.*, vol. 26, pp. 341–365, 2000.
- [50] R. Cross and A. Parker, *The Hidden Power of Social Networks*. Boston, MA: Harvard Bus. School Publishing, 2004.
- [51] D. Brass, "Structural relationships, job characteristics, and worker satisfaction and performance," *Adm. Sci. Q.*, vol. 26, no. 3, pp. 331–348, Sep. 1981.
- [52] G. Van der Vegt, B. Emans, and E. Van de Vliert, "Team members' affective responses to patterns of intragroup interdependence and job complexity," *J. Manage.*, vol. 26, no. 4, pp. 633–655, Jul. 2002.
- [53] D. Oster, "Angewandte Analyse Sozialer Netzwerke in Unternehmen: Auswirkungen Elektronischer Kommunikation Auf Die Performanz Von Teams," Diploma thesis, Dept. Inf. Syst. Inf. Manage., Univ. Cologne, Cologne, Germany, 2007.
- [54] G. Van der Vegt and E. Van de Vliert, "Intragroup interdependence and effectiveness: Review and proposed directions for theory and practice," *J. Manag. Psychol.*, vol. 17, no. 1, pp. 50–67, 2002.
- [55] A. Sinan, E. Brynjolfsson, and D. Wu, "Which came first, it or productivity? The virtuous cycle of investment and use in enterprise systems," in *Proc. Int. Conf. Inf. Syst.*, Dec. 2006, pp. 1–22.
- [56] W. Baker, *Achieving Success Through Social Capital*. New York: Wiley, 2000.
- [57] H. Liu and P. Maes, "What would they think? A computational model of attitudes," in *Proc. ACM Int. Conf. Intell. User Interfaces*, Jan. 2004, pp. 38–45.
- [58] H. Liu and P. Maes, "The aesthetoscope: Visualizing aesthetic readings of text in color space," in *Proc. 18th Int. FLAIRS Conf. Special Track AI Music Art*, May 2005, pp. 74–79.
- [59] Ambient Devices, [Online]. Available: <http://www.ambientdevices.com>
- [60] R. J. Rienks, "Meetings in smart environments: Implications of progressing technology," Ph.D. dissertation, Univ. Twente, Enschede, The Netherlands, Jul. 2007.
- [61] T. Kim, A. Chang, L. Holland, and A. Pentland, "Meeting mediator: Enhancing group collaboration and leadership with sociometric feedback," in *Proc. ACM Conf. Comput. Supported Cooperative Work*, Nov. 2008, pp. 1–10.



**Daniel Olguin Olguin** (S'99) received the B.S. degree in electronics and communications engineering and the M.S. degree in electronic systems engineering from the Tecnológico de Monterrey, Monterrey, Mexico, in 2003 and 2005, respectively, and the M.S. degree in media arts and sciences from the Massachusetts Institute of Technology (MIT), Cambridge, in 2007. He is currently working toward the Ph.D. degree in the Human Dynamics Research Group, Media Laboratory, MIT.

His research interests include wearable computing, context-aware computing, machine learning, pattern recognition, and organizational engineering.



**Benjamin N. Waber** (S'07) received the B.A. and M.A. degrees in computer science from Boston University, Boston, MA, in 2006. He is currently working toward the Ph.D. degree in the Human Dynamics Research Group, Media Laboratory, Massachusetts Institute of Technology, Cambridge.

His research interests include social networks, opinion aggregation, computational psychology, and body sensor networks.



**Taemie Kim** (S'07) received the B.S. degree in electrical engineering and computer science from the Korea Advanced Institute of Science and Technology, Daejeon, Korea, in 2003 and the M.S. degree in electrical engineering from Stanford University, Stanford, CA, in 2006. She is currently working toward the Ph.D. degree in the Human Dynamics Research Group, Media Laboratory, Massachusetts Institute of Technology, Cambridge.

Her research interests include human-computer interaction, human behavior modeling, and mobile

feedback systems.



**Akshay Mohan** received the B.Tech. degree from the Indian Institute of Technology, Kanpur, India, and the M.S. degree in media arts and sciences from the Massachusetts Institute of Technology, Cambridge.

Since 2004, he has been a Consultant and Researcher in technology design, organizational frameworks, and interorganizational collaborations. He is currently with the Human Dynamics Research Group, Media Laboratory, Massachusetts Institute of Technology. His research interests include human

behavior modeling and change.



**Koji Ara** received the B.Sc. and M.Sc. degrees in electrical engineering from Waseda University, Tokyo, Japan, in 1996 and 1998, respectively.

In 1998, he was with the Hitachi Central Research Laboratory, Tokyo, Japan. From 2005 to 2007, he was a Visiting Scientist in the Media Laboratory, Massachusetts Institute of Technology, Cambridge. He is currently a Researcher with the Hitachi Advanced Research Laboratory, Tokyo. His research interests include design methodologies and applications for sensor-network systems and large-scale

integration.



**Alex (Sandy) Pentland** (M'99) received the B.G.S degree from the University of Michigan, Ann Arbor, in 1976 and the Ph.D. degree in psychology from the Massachusetts Institute of Technology (MIT), Cambridge, in 1982.

He is a pioneer in wearable computers, mobile information systems, technology for developing countries, consumer health, and smart environments. He is one of the most-cited computer scientists in the world. He is a Cofounder of the wearable computing research community, the autonomous mental development research community, and the Center for Future Health and was the Founding Director of the Media Lab Asia. He is currently with MIT, where he was formerly the Academic Head of the Media Laboratory and is now the Toshiba Professor of Media Arts and Sciences and the Founder and Faculty Director of the Human Dynamics Research Group.

Prof. Pentland is the recipient of numerous international awards in the arts, sciences, and engineering.