

AN INDUSTRIALIZED HOUSING SYSTEM

By:

Shyng Miin Chen

Master of Science in Architecture, Cheng Kung University, Taiwan (1973)
Bachelor of Science in Architecture, Cheng Kung Univ., Taiwan (1970)

Submitted in Partial Fulfillment of the Requirements for the
Degree of MASTER OF ARCHITECTURE, ADVANCED STUDIES

At the
MASSACHUSETTS INSTITUTE OF TECHNOLOGY
May 9, 1975

Author..... Department of Architecture

Certified by..... Thesis Advisor

Accepted by..... Chairman, Department Committee on Graduate Students

Rotch



May 9, 1975

Dean William Porter
School of Architecture and Planning
Massachusetts Institute of Technology

Dear Dean Porter:

In partial fulfillment of the requirements for the degree of Master of
Architecture, Advanced Studies, I hereby submit this thesis entitled:

An Industrialized Housing System

Respectfully,

Shyng Miin Chen

ACKNOWLEDGEMENTS

The author gratefully acknowledges the following people who assisted in the development of this thesis:

Eduardo Catalano, Thesis Advisor
Professor of Architecture
Department of Architecture, MIT

Waclaw P. Zalewski
Professor of Structures
Department of Architecture, MIT

TABLE OF CONTENTS

Title Page
Letter of Submittal
Acknowledgements
Table of Contents

Abstract
Objectives
Basic Constraints
Description of the System

TYPICAL MODULAR UNIT
DWELLING UNIT PLANS
ELEVATION, SECTION AND FLOOR PLANS
CONSTRUCTION DETAILS

BIBLIOGRAPHY

ABSTRACT

AN INDUSTRIALIZED HOUSING SYSTEM

By: Shyng Miin Chen

Submitted to the Department of Architecture on May 9, 1975, in partial fulfillment of the requirements for the degree of Master of Architecture, Advanced Studies.

The intention of this thesis is to develop a modular housing system employing steel as structural materials. The modules in various lengths are produced in the factory with the capability of being assembled into different configurations to provide greater flexibility of space planning for low-cost housing.

The design proposal demonstrates how the system works, suggest some dwelling unit plans and building types which are applicable to this system, and also illustrates some technical details which make this system possible.

OBJECTIVES:

To develop a modular system to produce low-cost housing which has the following capabilities:

- 1) To provide a wide range of dwelling units that accommodate different life styles of, and that are affordable by low income and medium income people.
- 2) To provide housing for urban and suburban situations.
- 3) To provide housing for medium-rise (up to 9 stories) and low-rise configurations.
- 4) To provide greater flexibility of physical integration with the existing city fabric.

BASIC CONSTRAINTS:

- 1) Maximum unit size under existing highway regulations and street conditions:
13'-0" maximum shipping width.

13'-6" maximum shipping height from ground.

60'-0" maximum shipping length.

2) Code Requirements:

All modules and buildings were designed to comply with the requirements of the BOCA Basic Building Code. The following fire resistance ratings specified in this code were assumed to be met in all boxes which were designed as Noncombustible Construction Type 2B:

Exterior Walls	3/4 hr.
Exitway Access Hallways & Walls between Apartments	3/4 hr.
Other Non-bearing Partitions	Non-combustible
Floor-ceiling Assembly including beams	3/4 hr.
Roof Construction including beams	3/4 hr.
Columns	3/4 hr.

The areas and heights of all buildings between exterior walls or between exterior walls and fire walls are also governed by the code. For Type 2B residential buildings, the maximum building height is generally restricted to 4 stories. But when such buildings are separated not less

than 50 feet from any other building on the lot and from interior lot lines, and the first floor is not less than one and one half hours fireresistive construction, the total building height may be increased to nine stories or one hundred feet in height. In such cases, the floor area shall be reduced depending on the number of stories as specified below:

<u>No. of Stories</u>	<u>Limits of Floor Areas</u>
9	4,500 SF
8	6,000 SF
7	7,500 SF
6	9,000 SF
5	10,500 SF
4	12,000 SF
3	12,000 SF
2	15,000 SF
1	15,000 SF

DESCRIPTION OF THE SYSTEM:

Basic Modular Units:

The basic elements of this system are those modular units of three

dimensions which are to be assembled in the factory and then be shipped to the site for erection. They are in the same width and height but allow various lengths to provide greater flexibility for space planning. The box is typically formed by a ceiling panel, a floor panel and several columns for structural purposes and shall be properly protected and temporarily braced during transport. Dwelling units are made up by one or more modules in various ways, while boxes are connected parallel or perpendicular to each other.

Building Types:

Different building types including towers, slab-types, walk-up buildings and row houses are applicable to this system, if they are not higher than 9 stories and their floor areas are within the limits of the code requirements.

Erection:

The modules are assembled one by one lifted by readily-available cranes and welded to the tubings which are positioned just before boxes are placed (refer to the diagram of construction sequence). Tubings varying

in gauge for different location are fabricated in two-story lengths, except those stacked on the first floor and on the top floor. The joints between any two tubings always occur 3' above the roof level of the lower box so as not to complicate the connections between tubings and modules (see detail drawings). Bracing can be done between tubings when necessary.

Mechanical System:

A hot water radiation system is provided for low-income housing. For medium-income groups, a fan-coil system is recommended. Final utility connections are made either before assembling the adjacent box or by removing the removable wall panel.



TYPICAL MODULAR UNIT

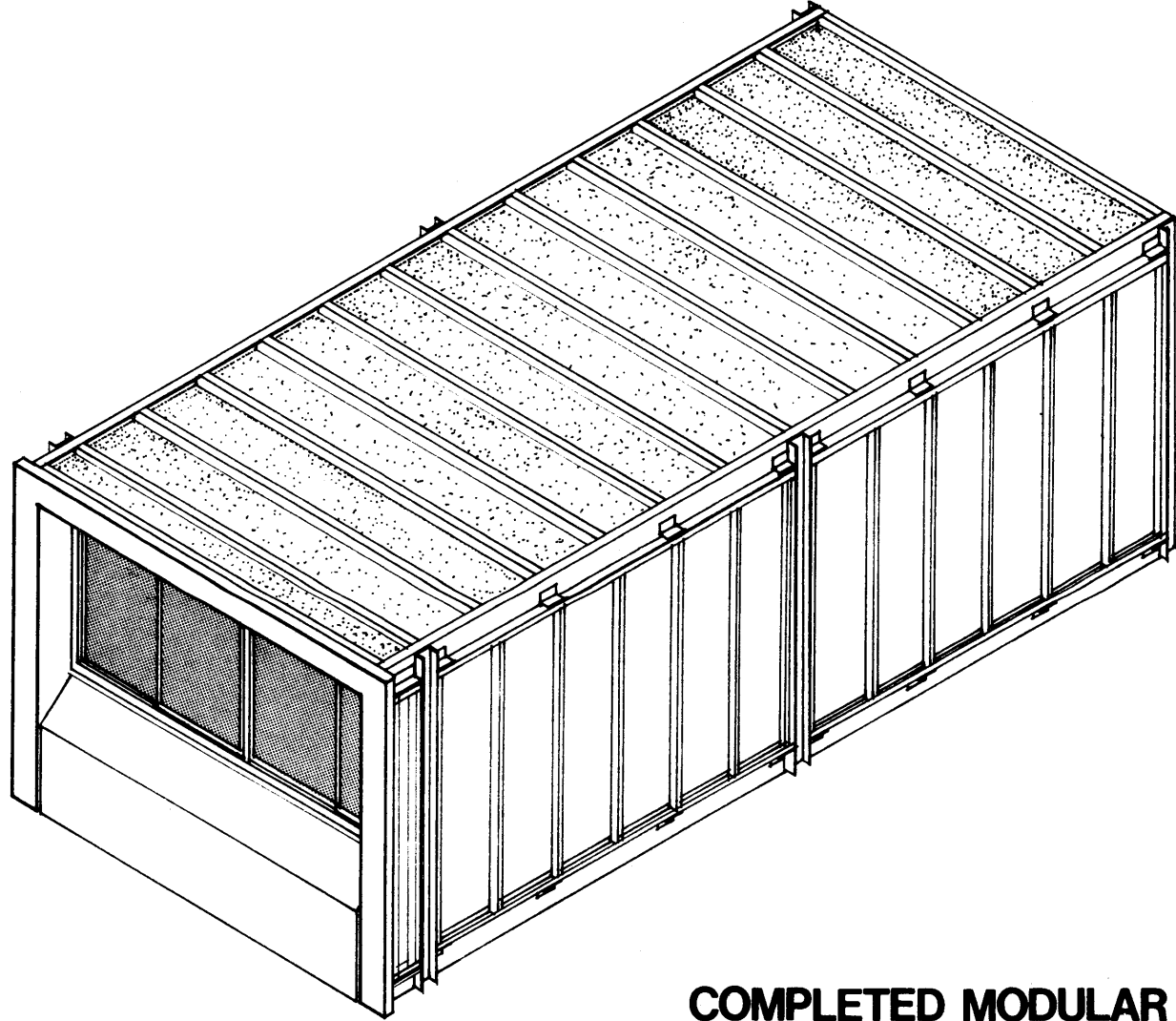

COMPLETED MODULAR UNIT

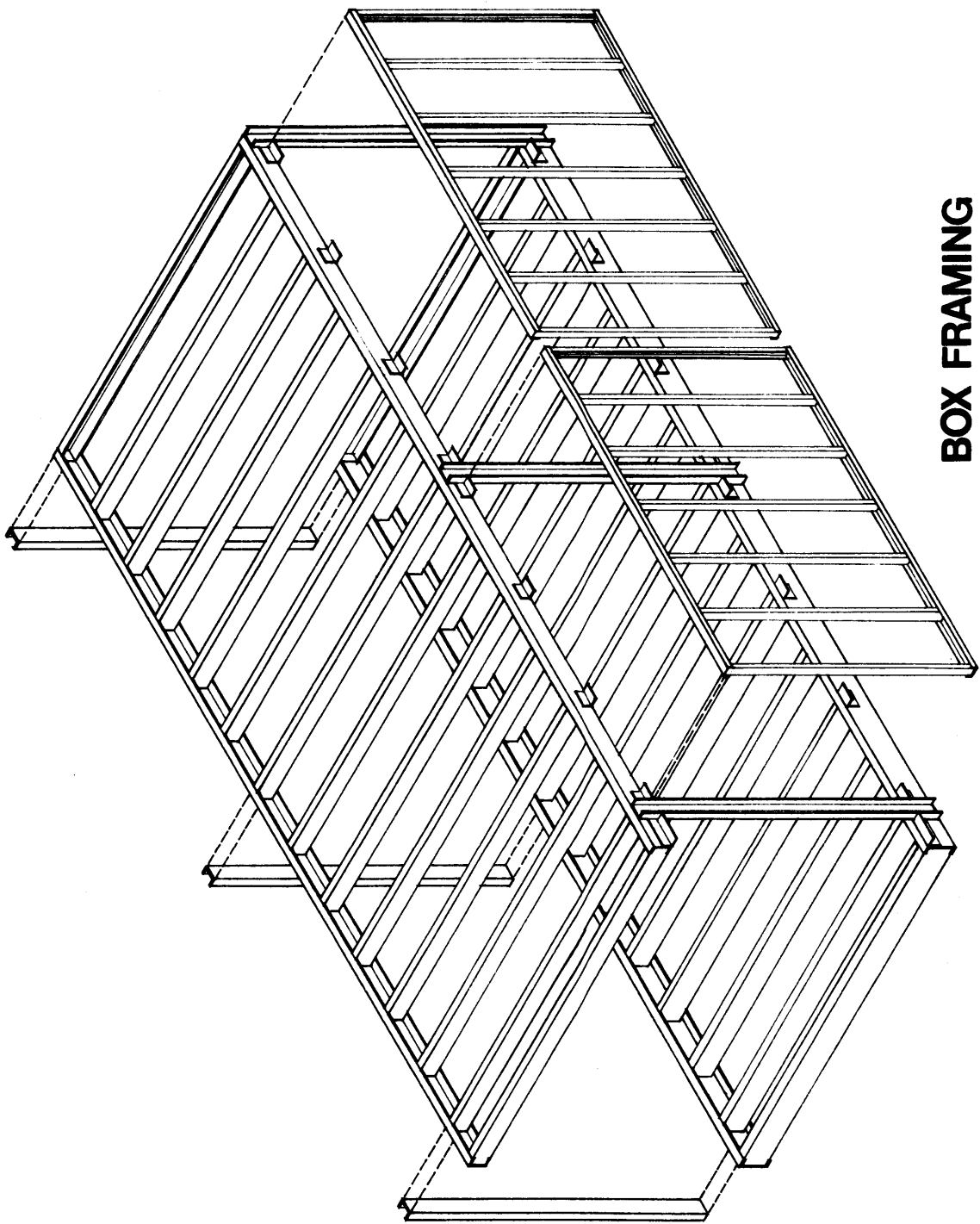

BOX FRAMING

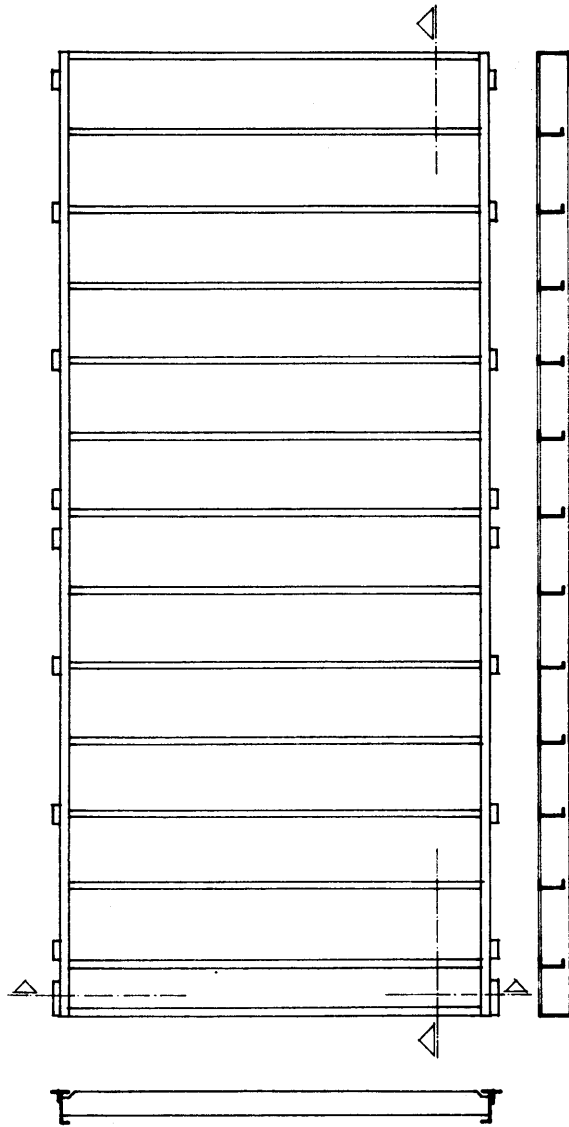

FLOOR FRAMING
 $3/16'' = 1'-0''$

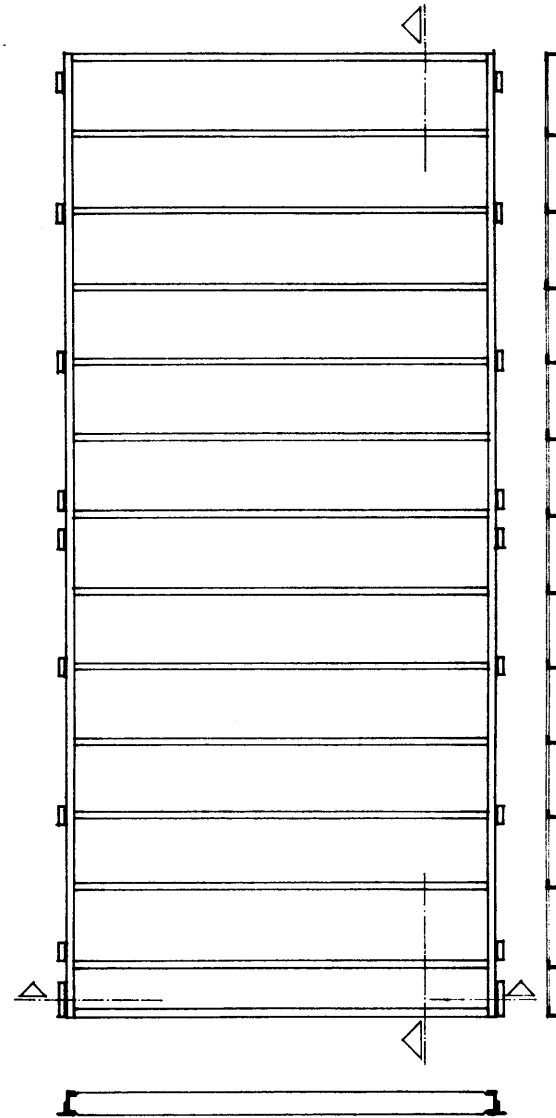

CEILING FRAMING

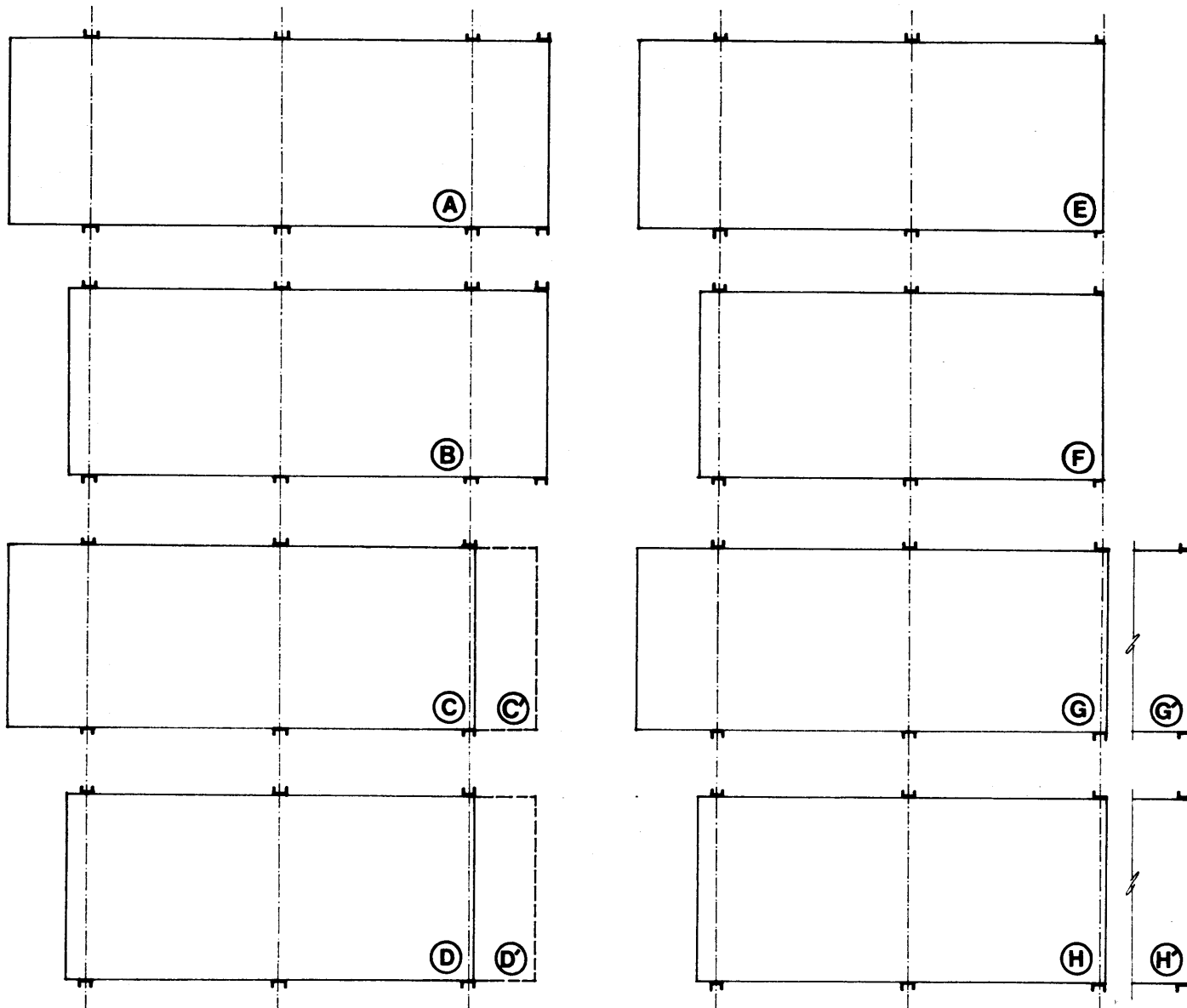

EIGHT BOX TYPES IN VARIOUS LENGTH AND WITH DIFFERENT COLUMN SECTIONS
 FOR MULTI-STORY BUILDINGS $3/32'' = 1'-0''$

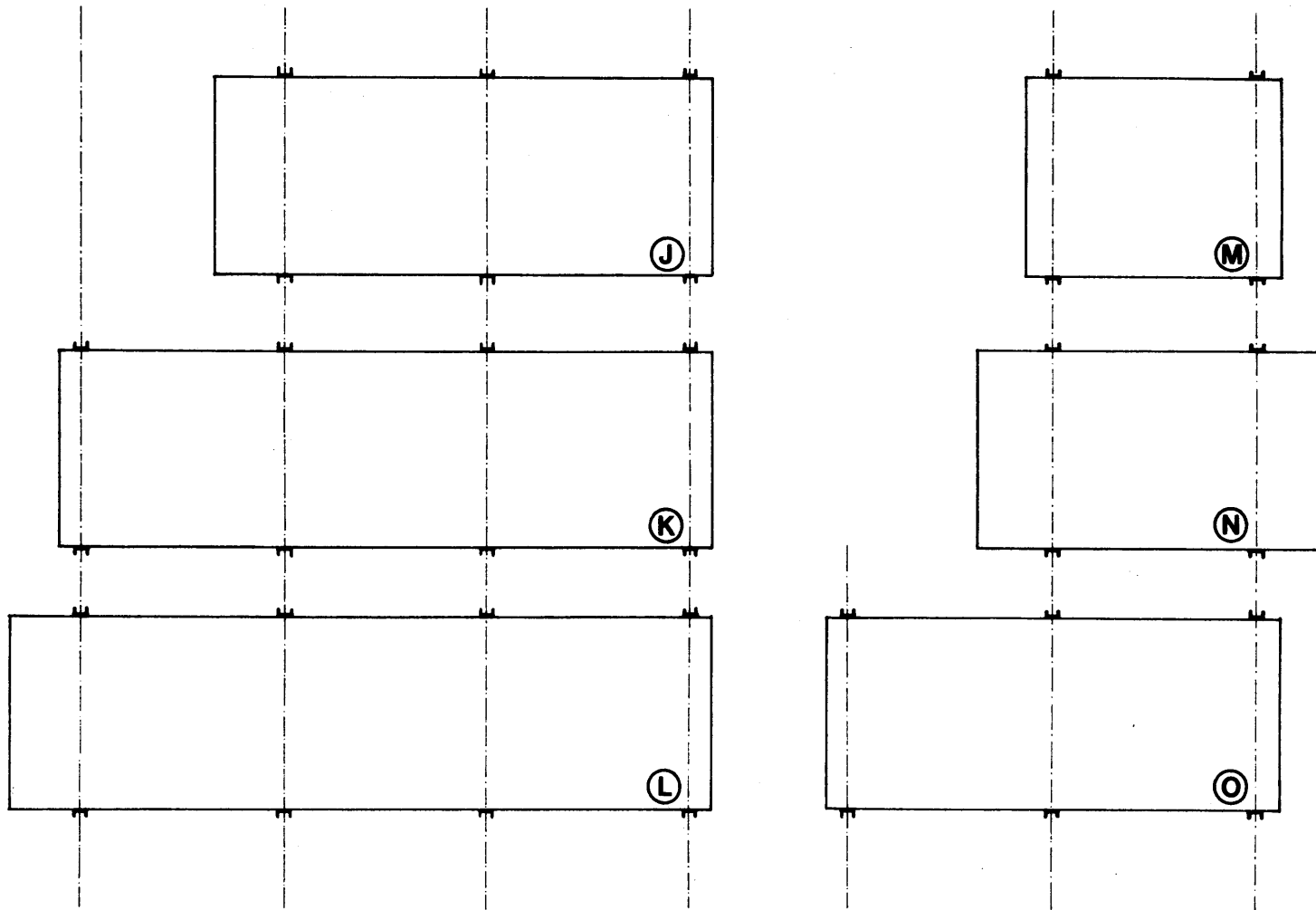

SIX BOX TYPES FOR ROW-HOUSE-TYPE APARTMENTS $3/32'' = 1'-0''$



DWELLING UNIT PLANS

1/8"=1'-0"

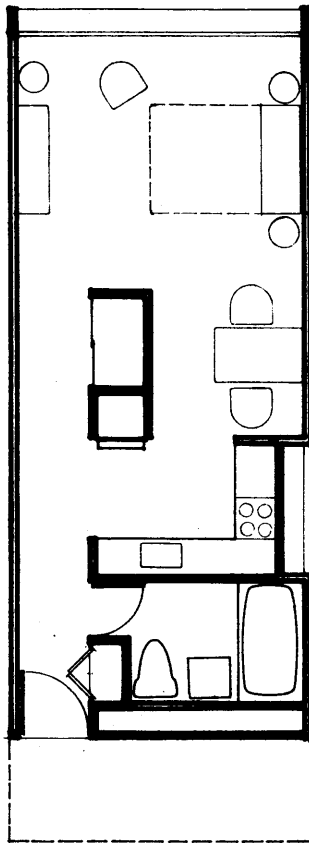

TYPE Ea

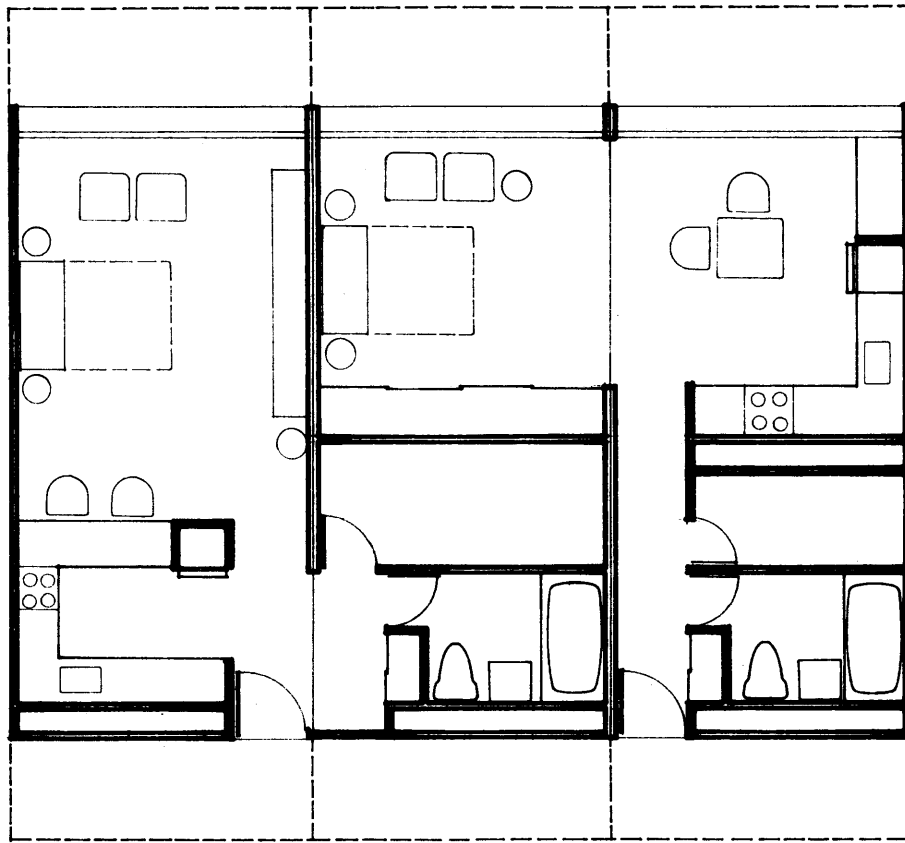

TYPE Eb

TYPE Ec

APARTMENT PLANS EFFICIENCY UNITS

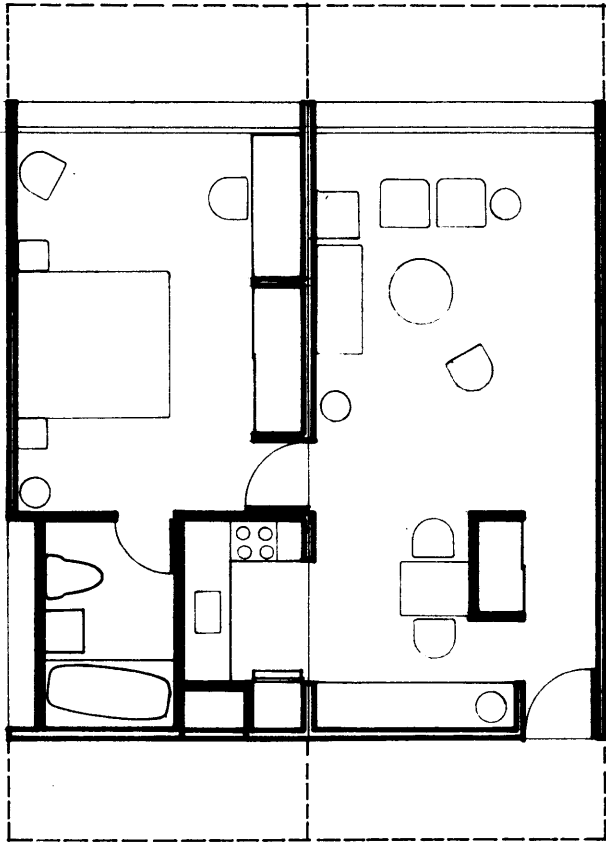

TYPE Aa

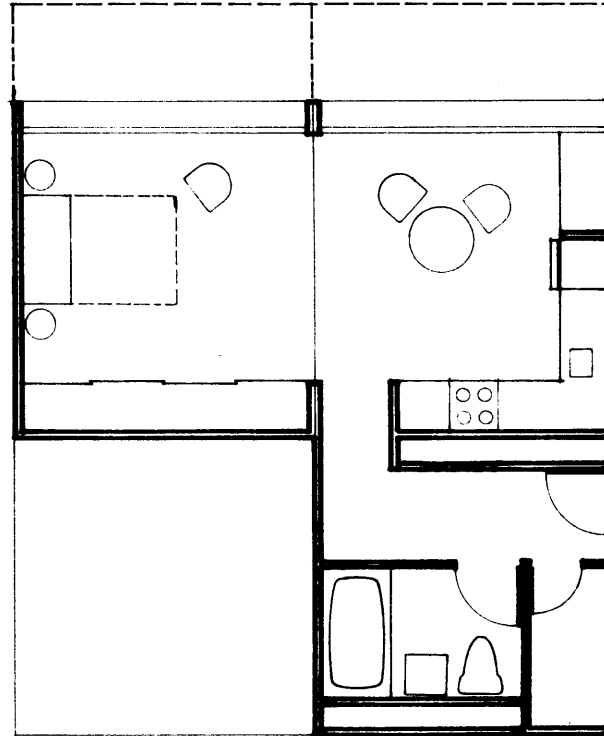

TYPE Ed

APARTMENT PLANS 1-BR UNIT & EFFICIENCY

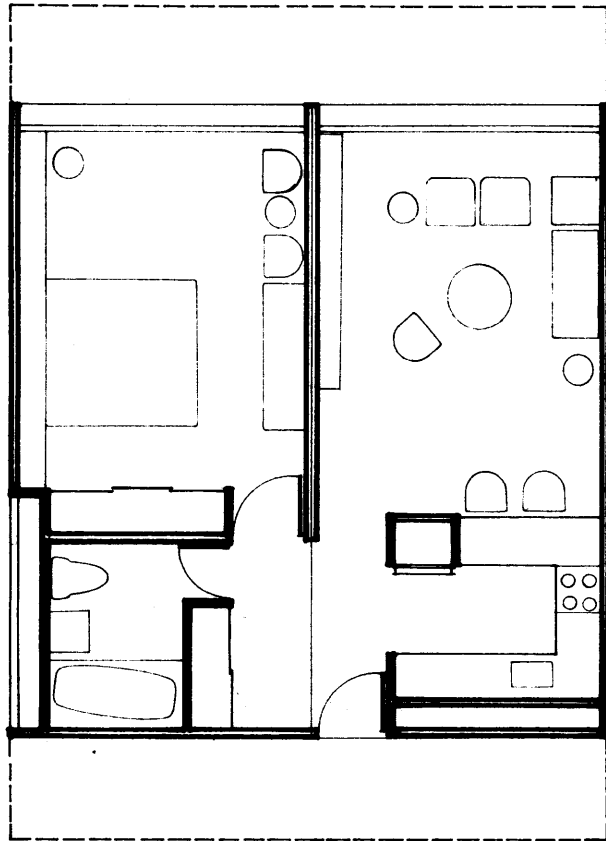

TYPE Ab

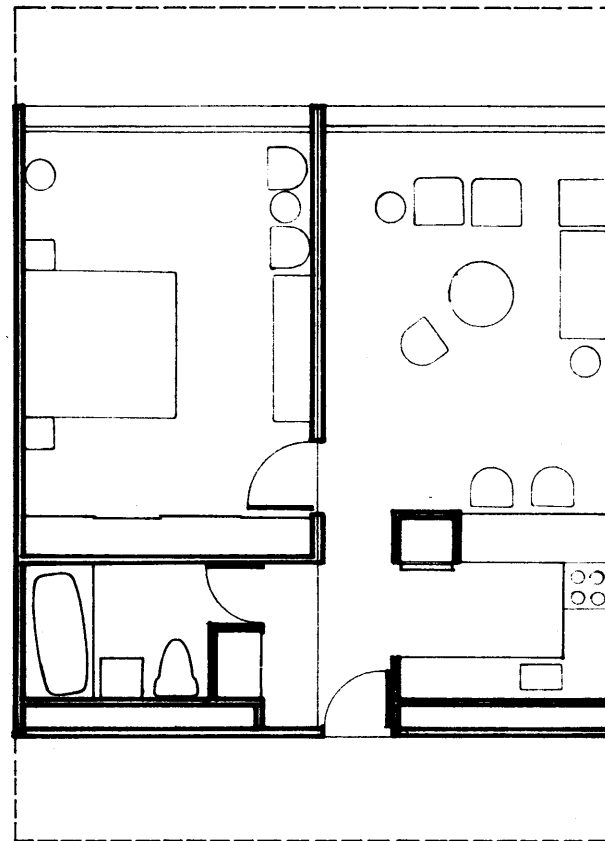

TYPE Ac

APARTMENT PLANS 1-BR UNITS

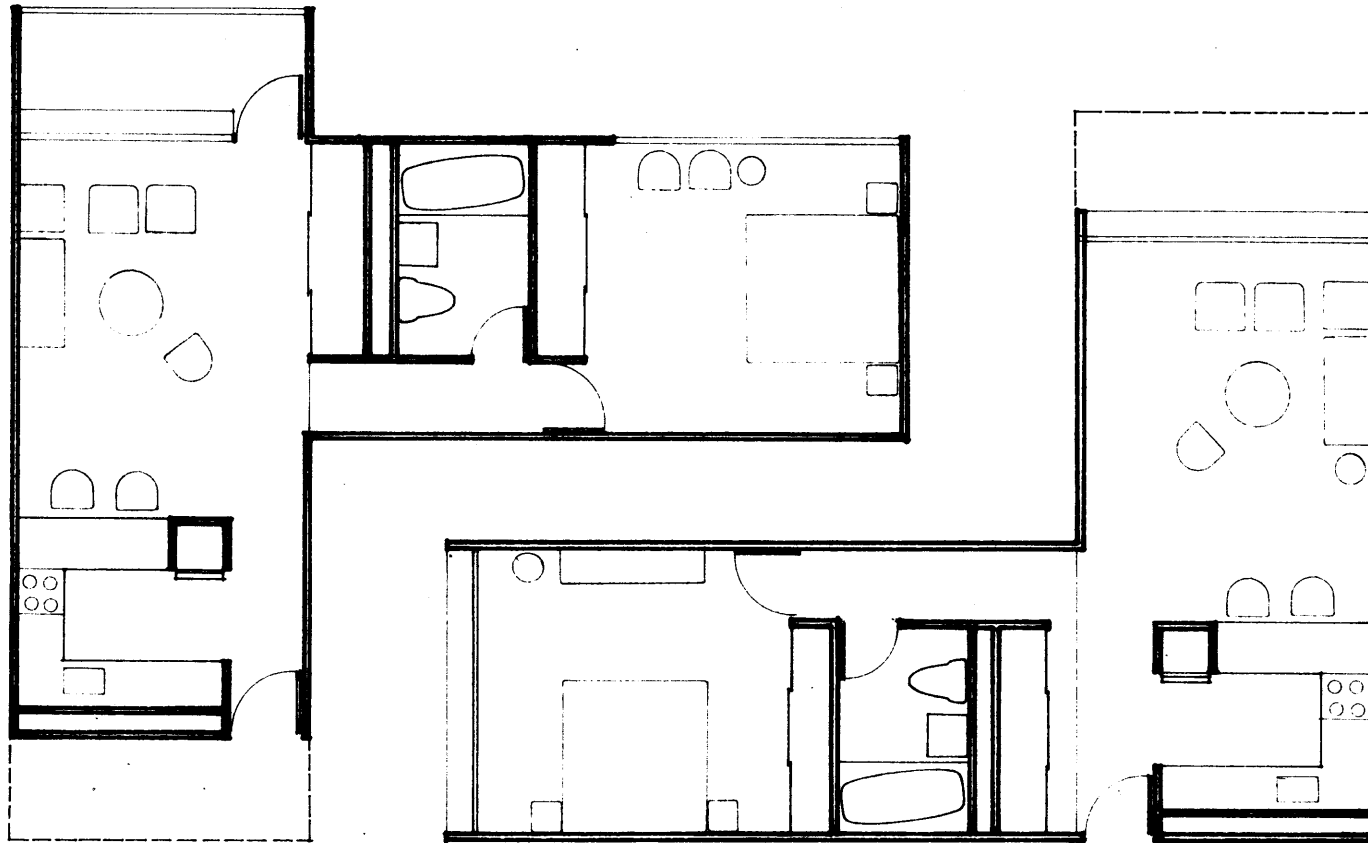

TYPE Ad

TYPE Ae

APT. PLANS 1-BR UNITS

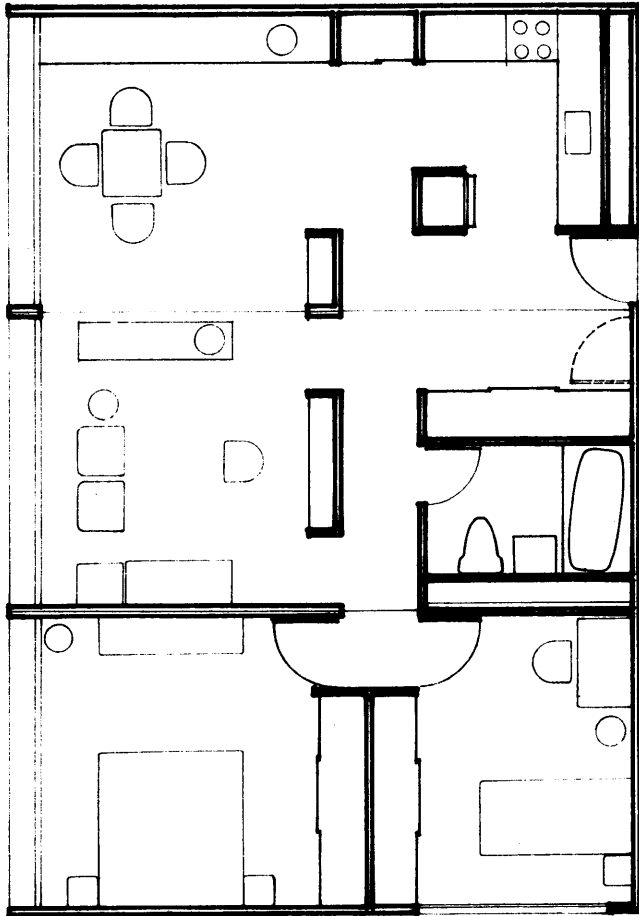

TYPE Ba

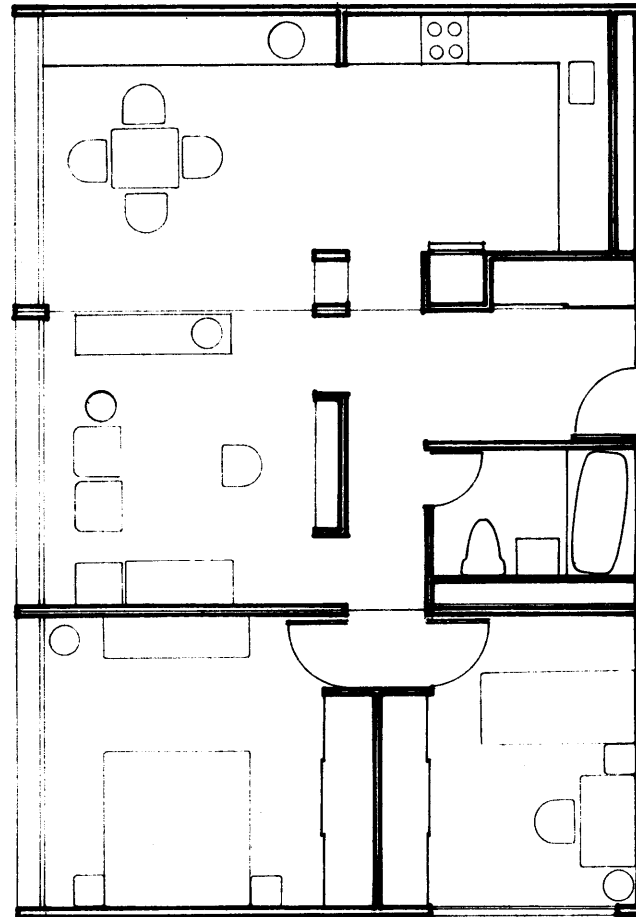

TYPE Bb

2-BR UNITS

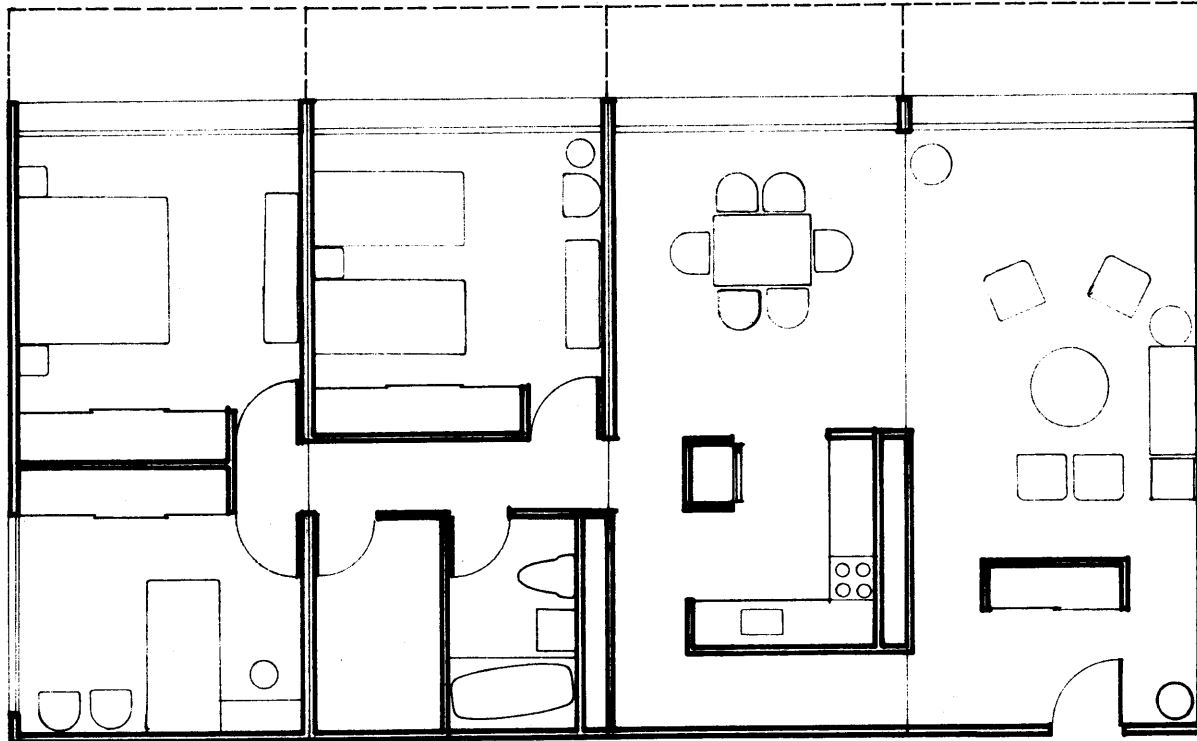

TYPE Ca

3-BR UNIT

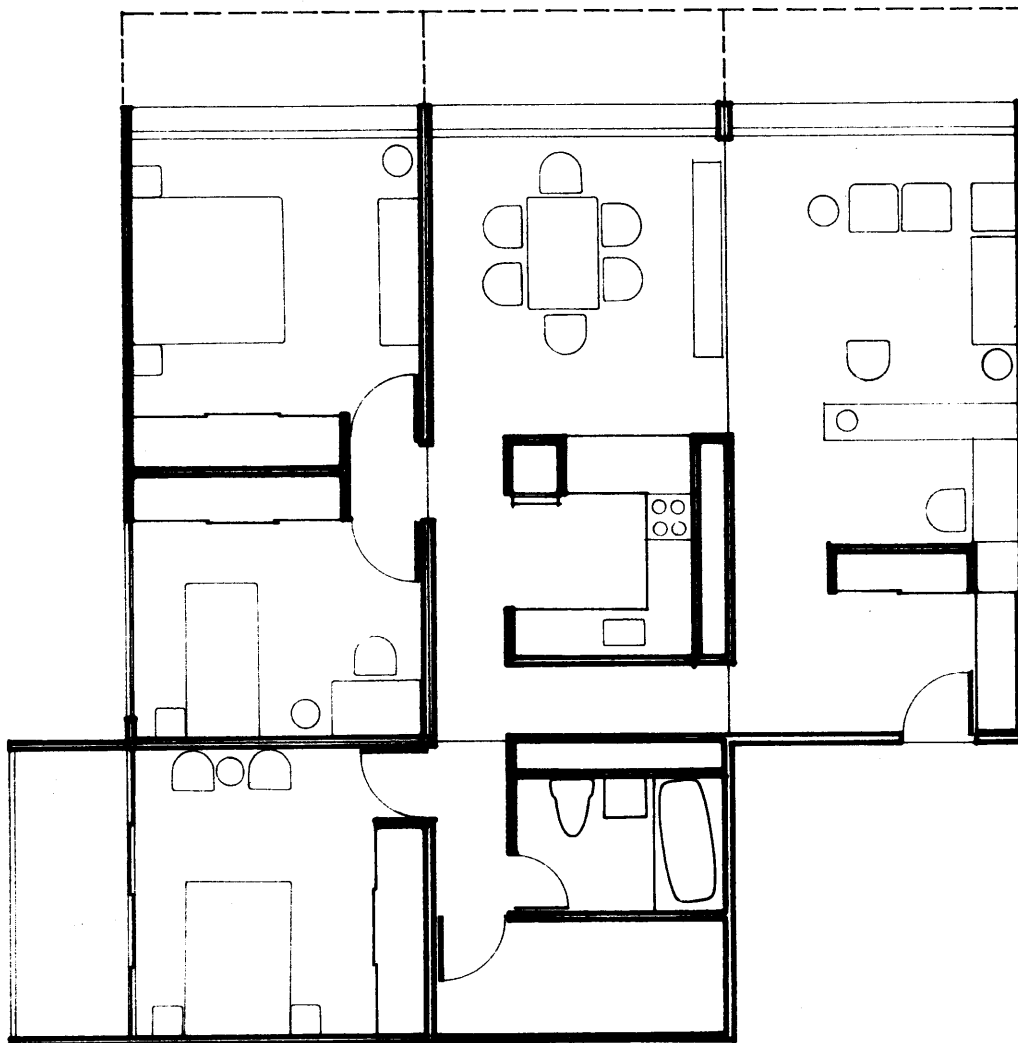

TYPE Cb

3-BR UNIT

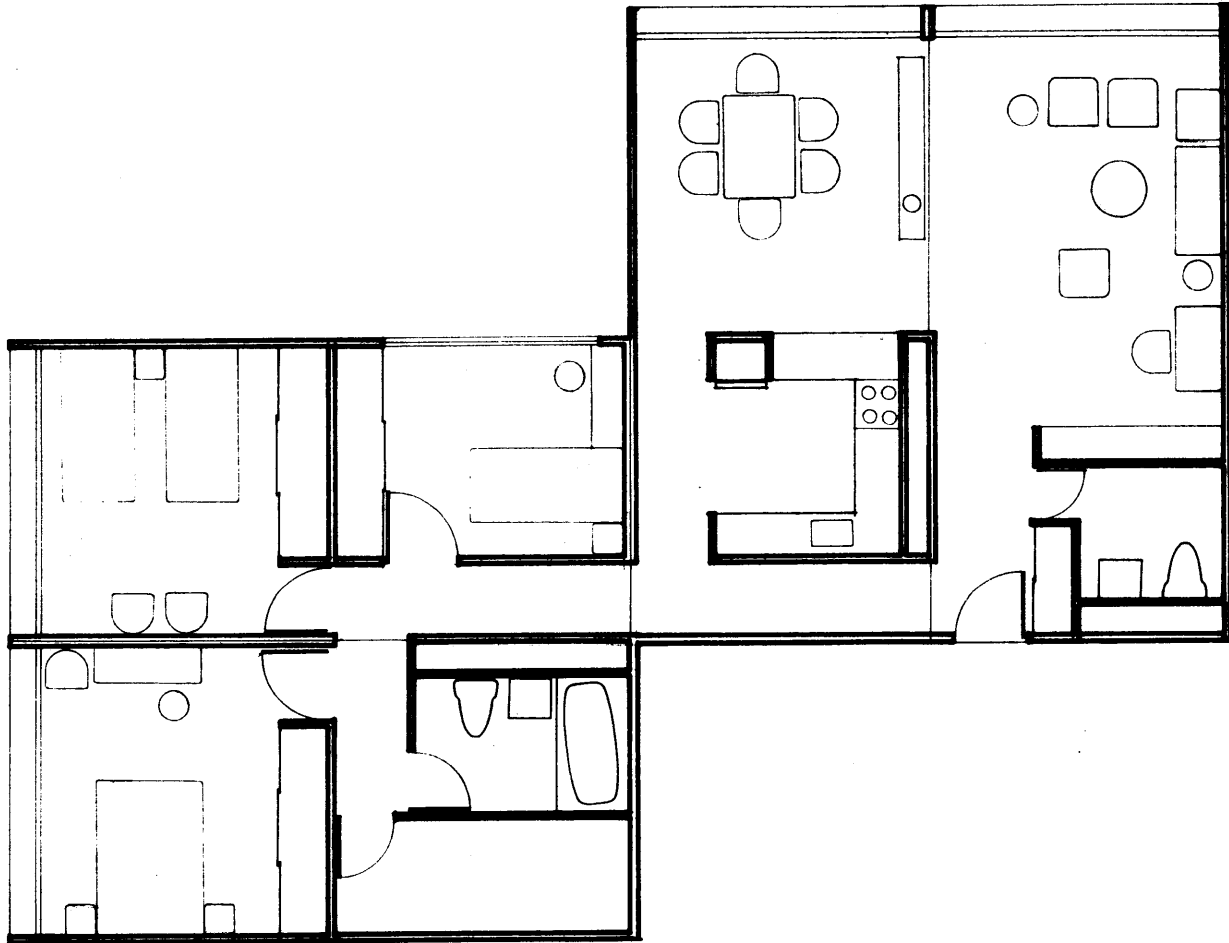

TYPE Cc

3-BR UNIT

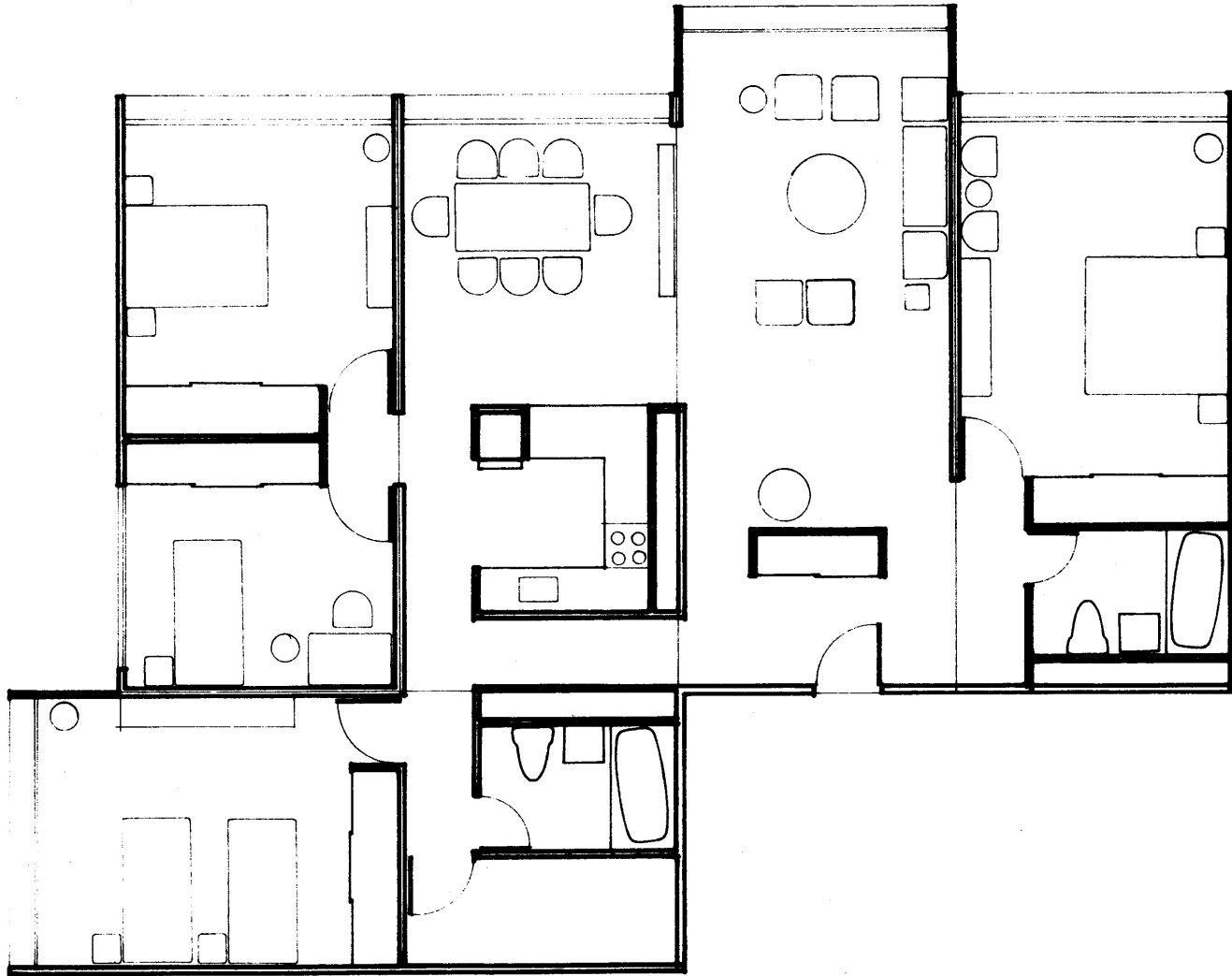

TYPE Da

4-BR UNIT

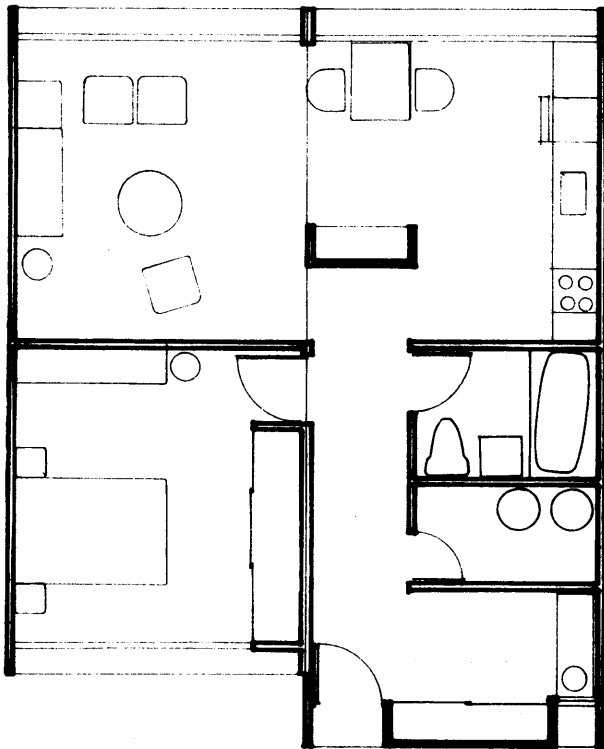

TYPE Af

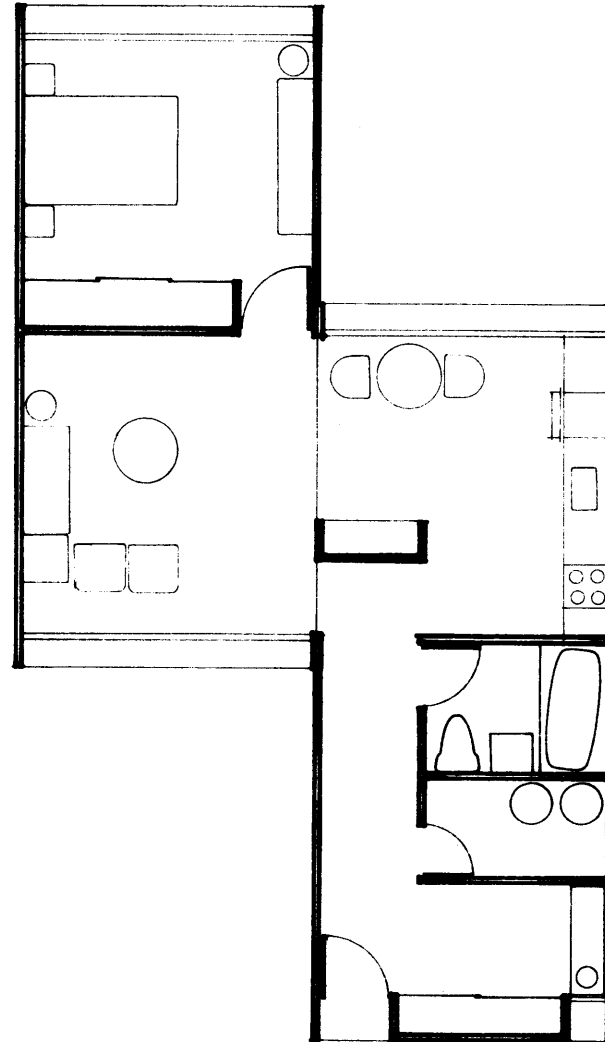

TYPE A9

ROW HOUSES 1-BR UNITS

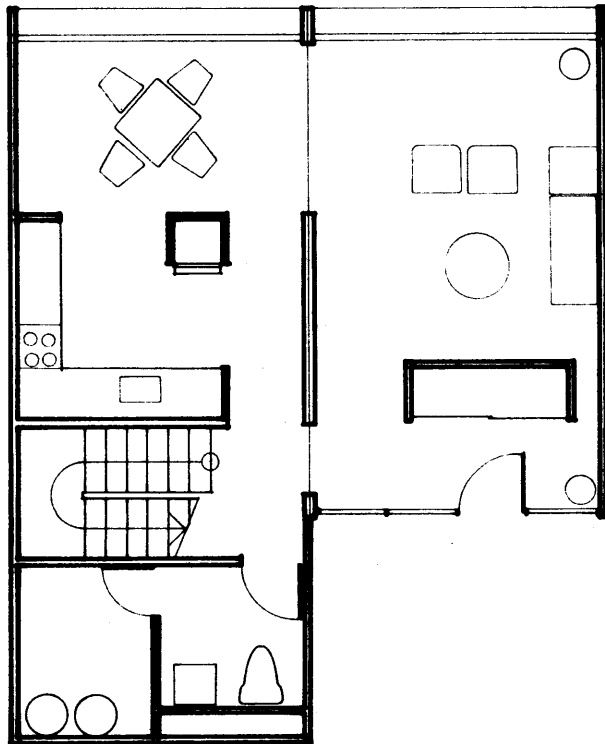

TYPE Bc LOWER LEVEL

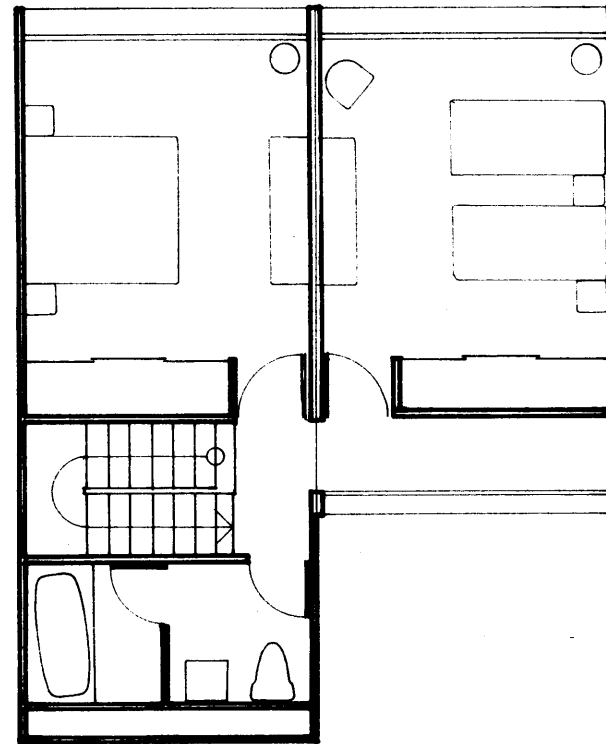

TYPE Bc UPPER LEVEL

2-BR UNIT

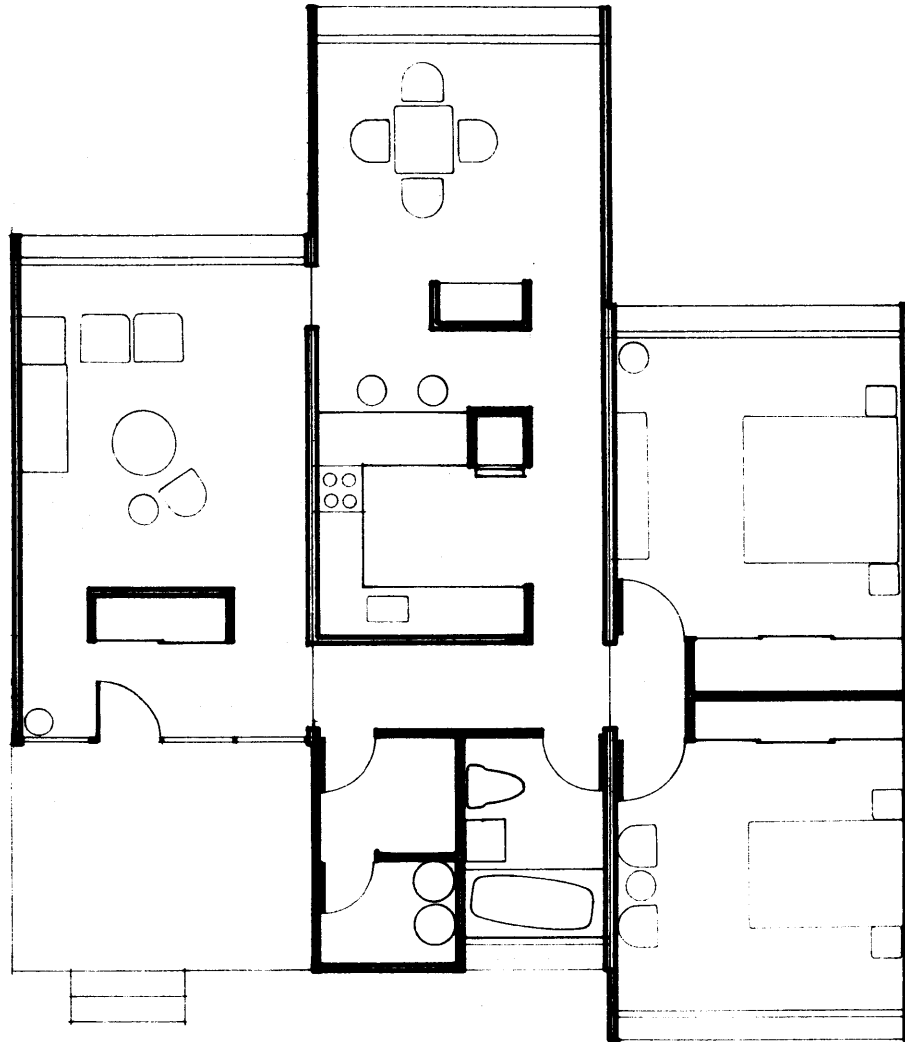

TYPE Bd

2-BR UNIT

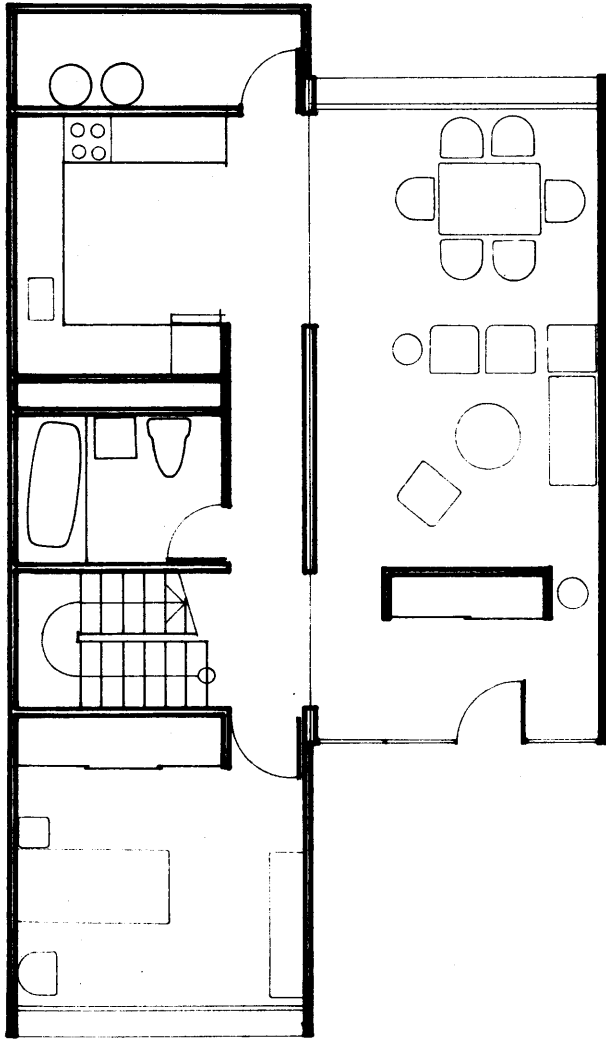

TYPE Cd LOWER LEVEL

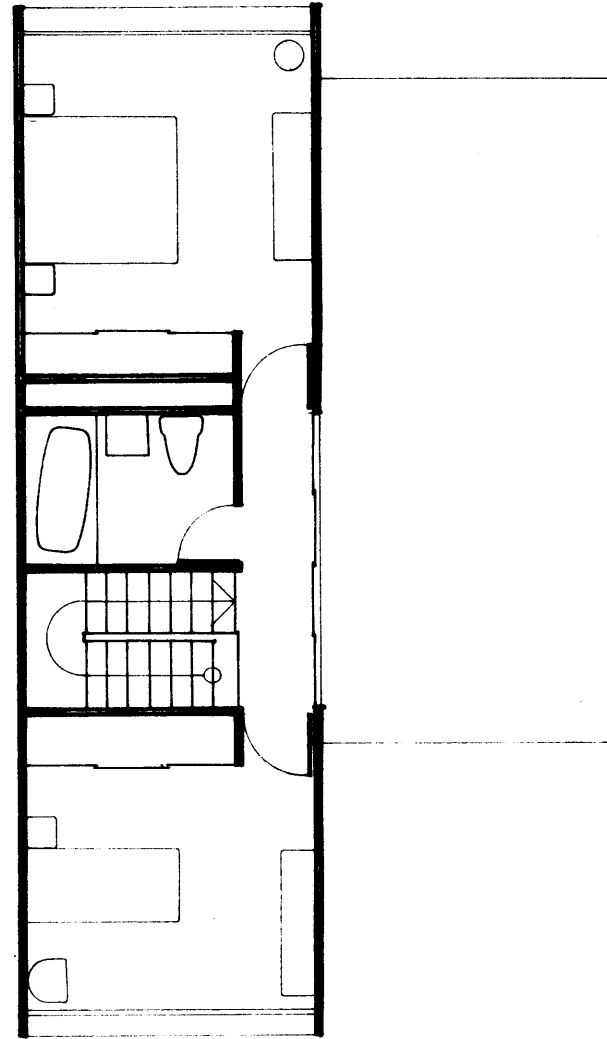

UPPER LEVEL

3-BR UNIT

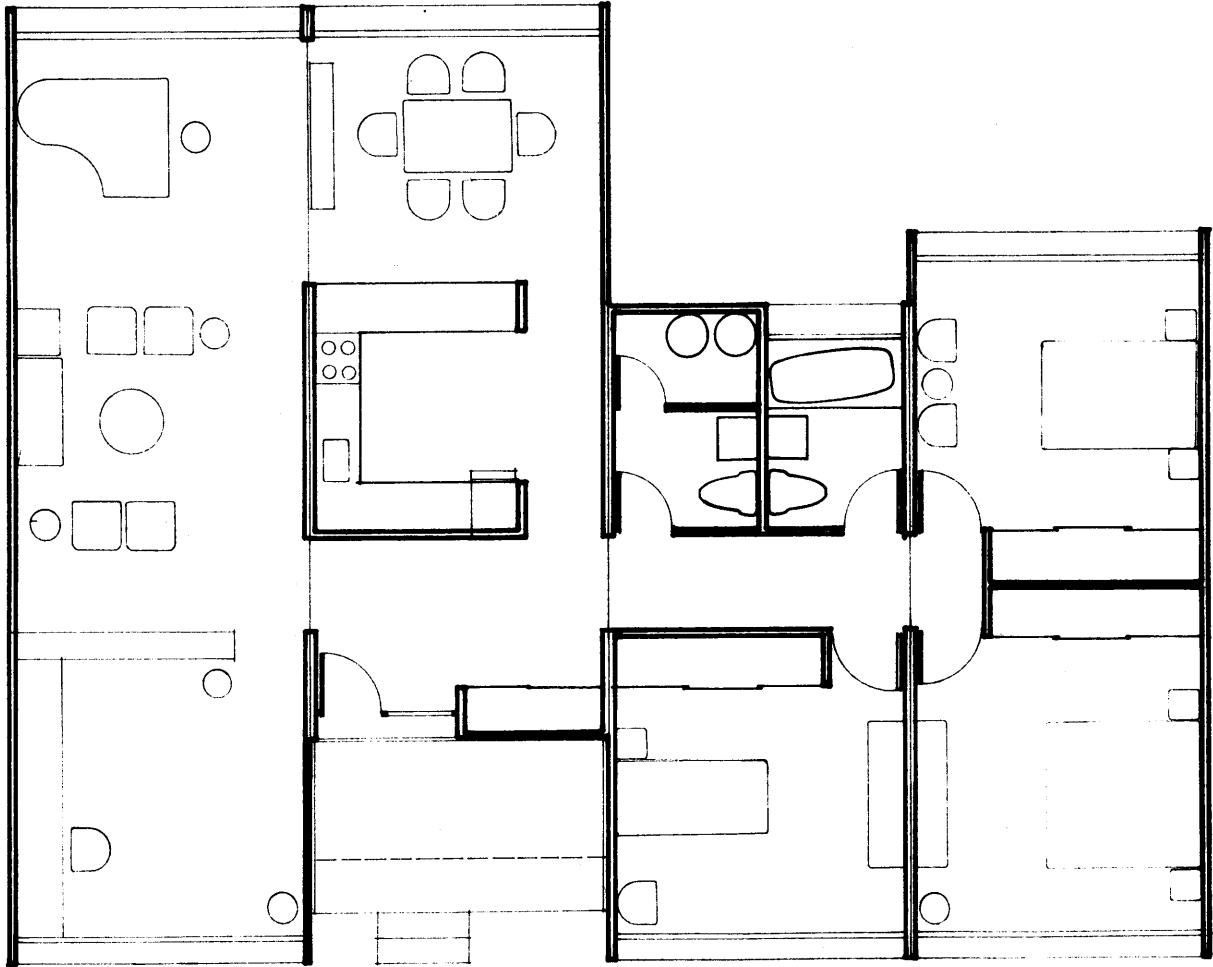

TYPE Ce

3-BR UNIT



ELEVATION
SECTION & **FLOOR PLANS**
 $1/25'' = 1'-0''$

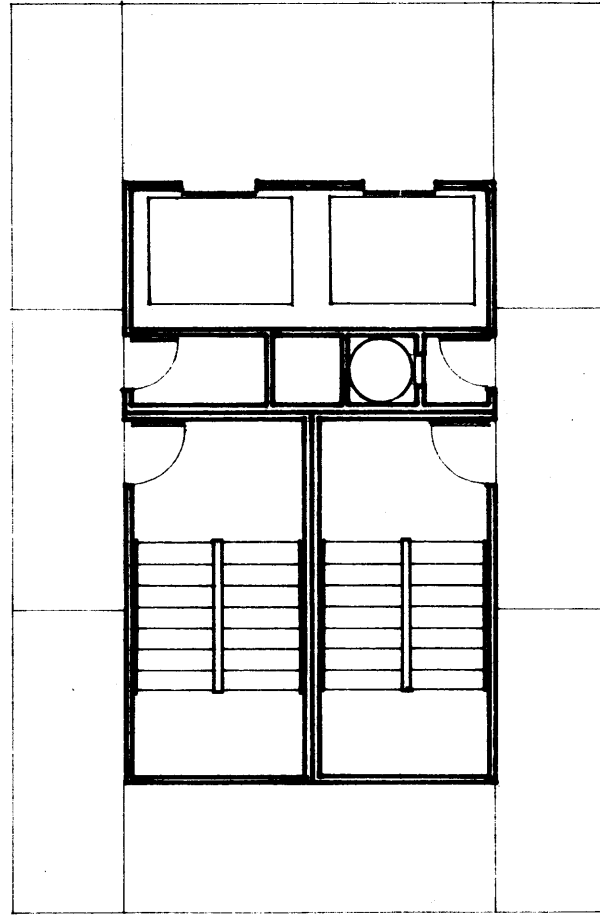
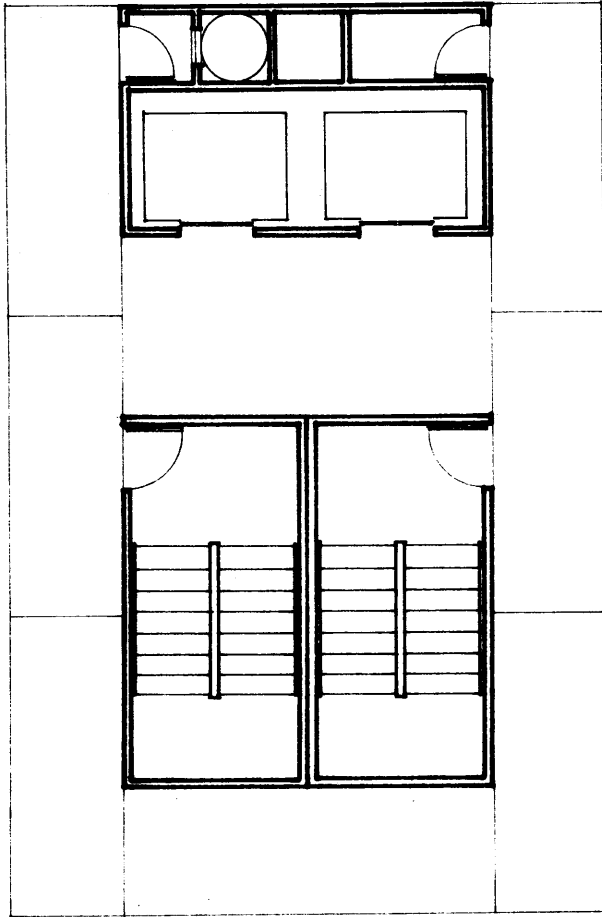

CORE PLANS FOR TOWERS $1/8"=1'-0"$

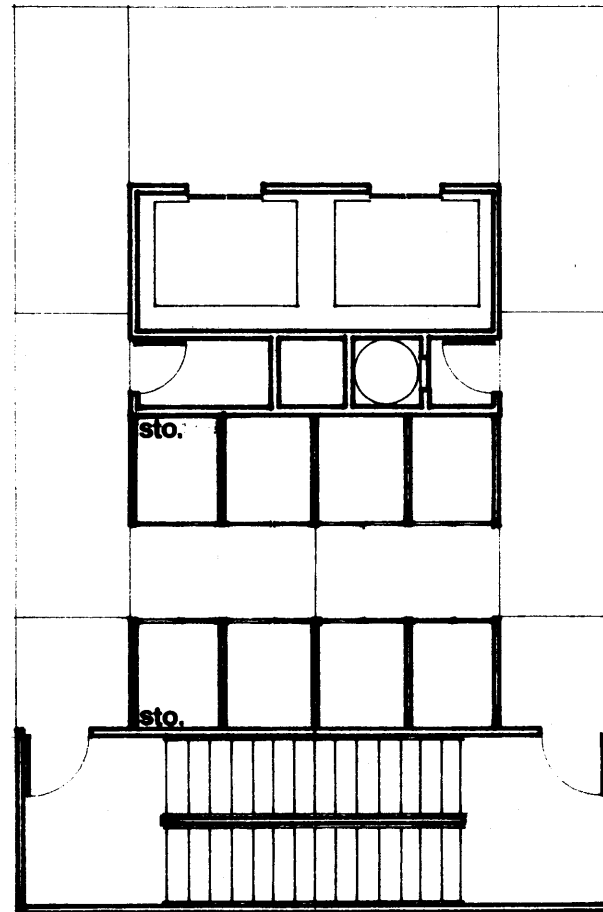
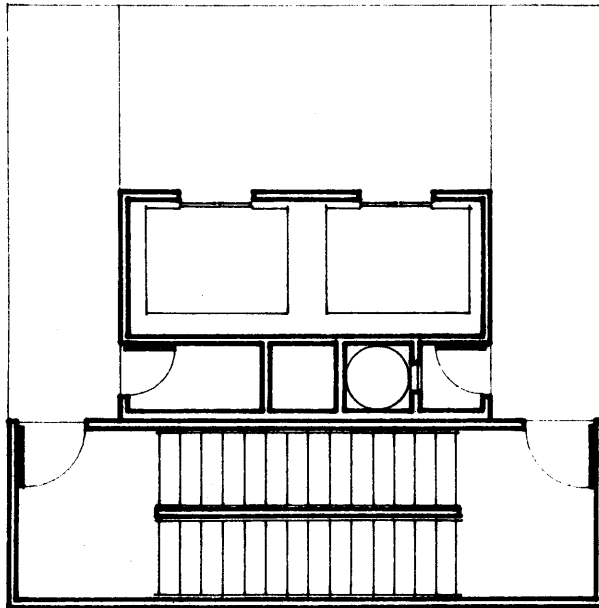

CORE PLANS FOR TOWERS $1/8" = 1'-0"$

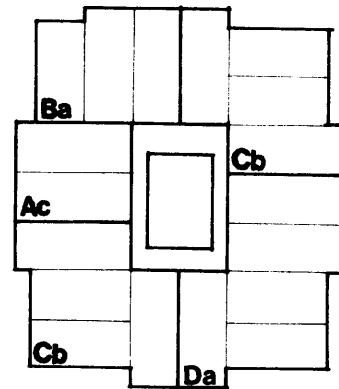
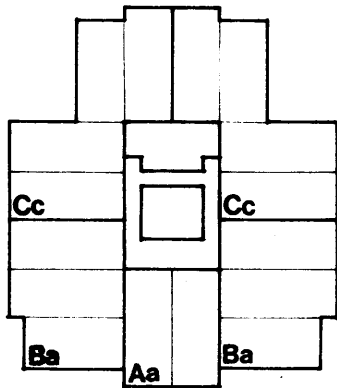
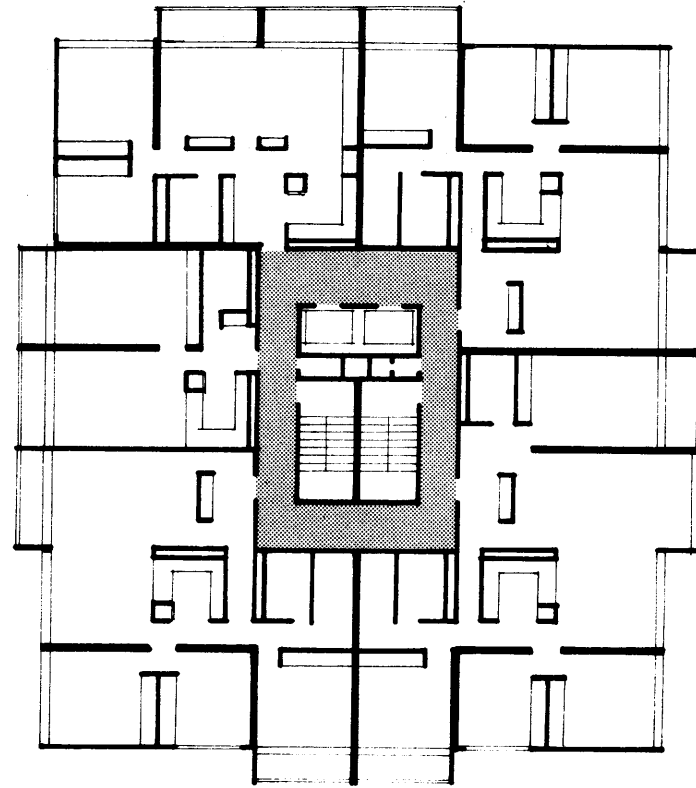
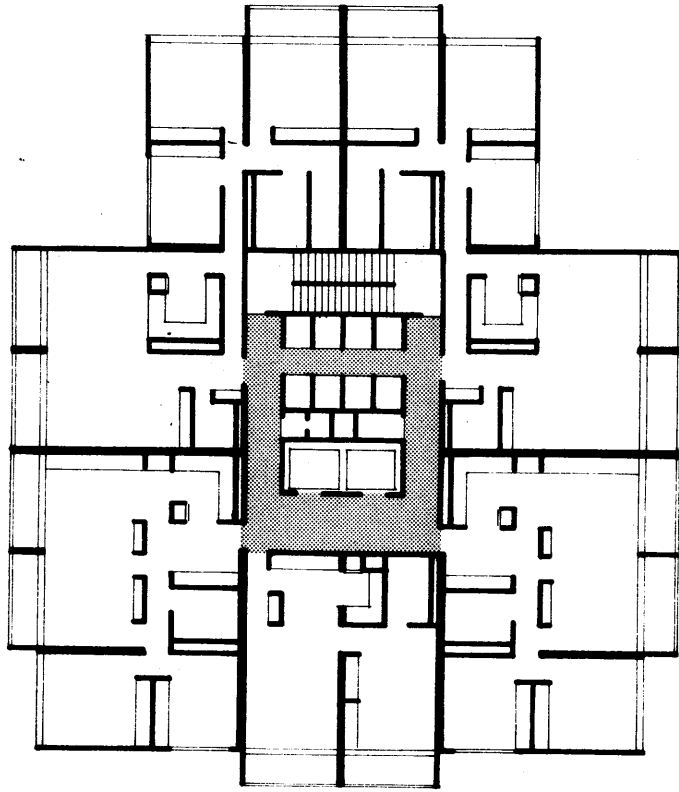

TOWERS

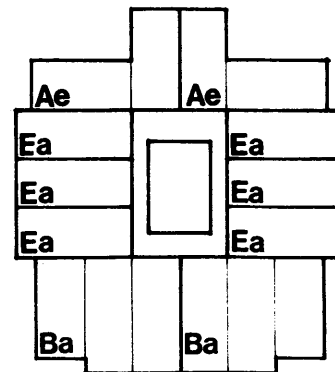
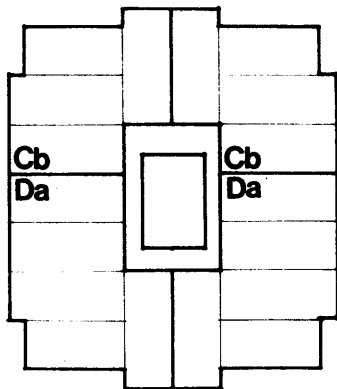
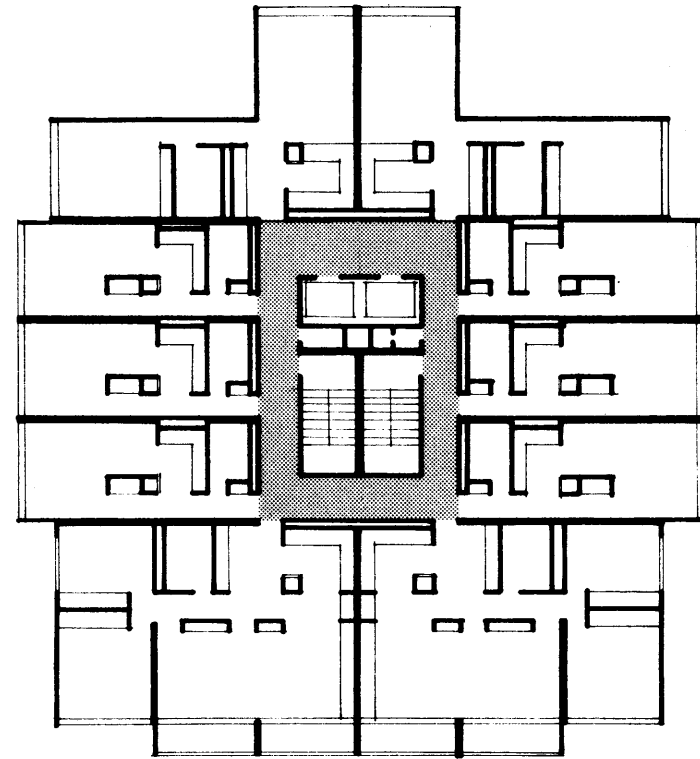
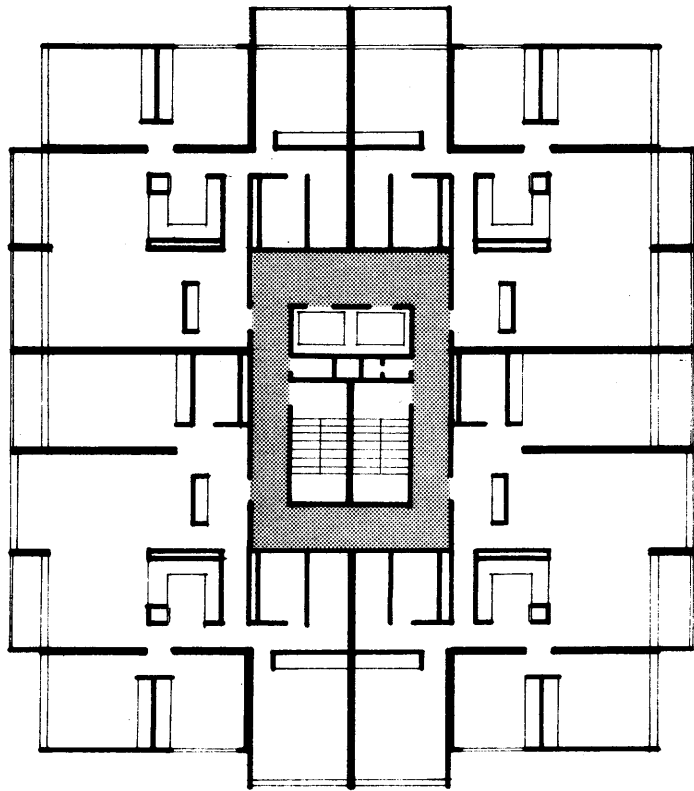

TOWERS

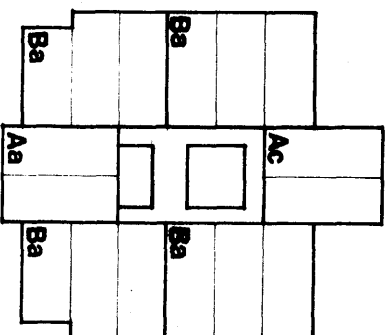
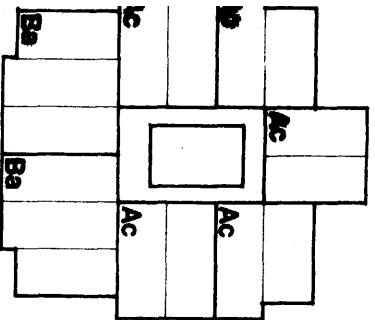
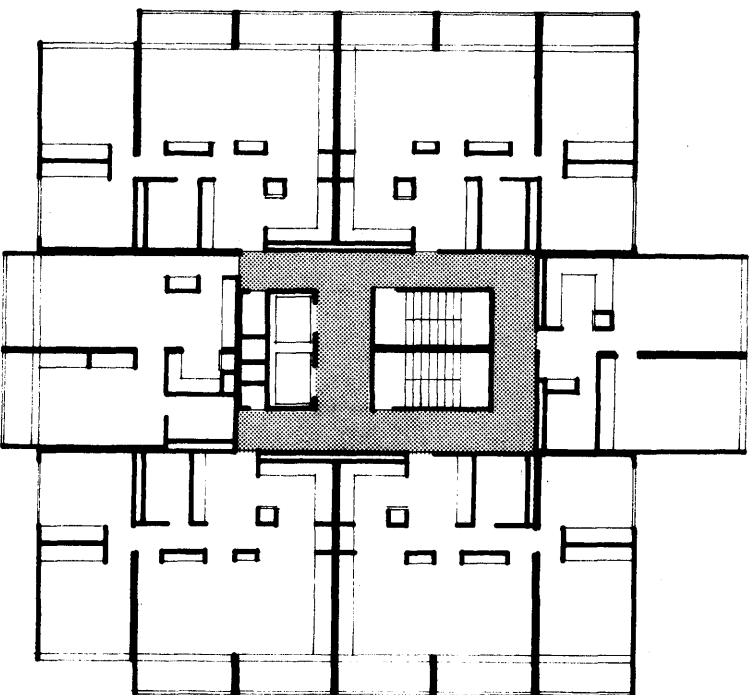
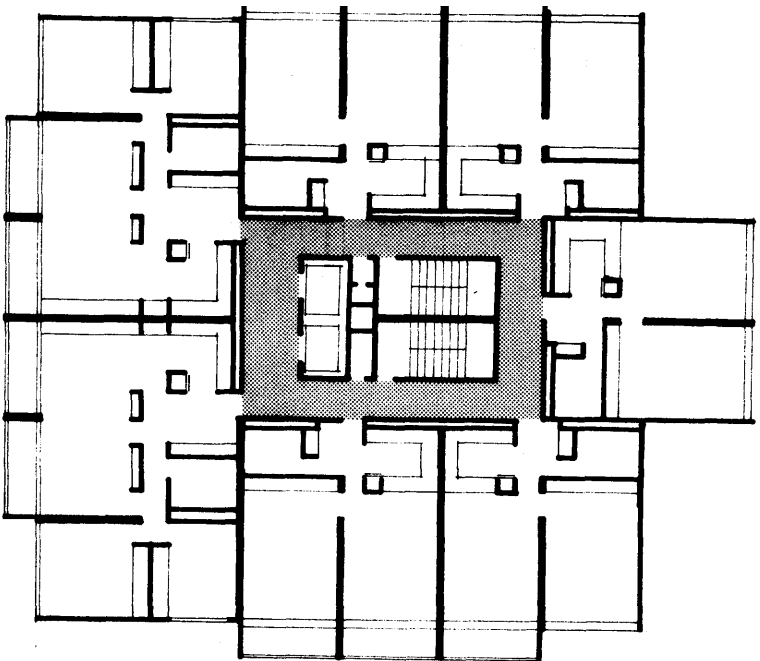

TOWERS

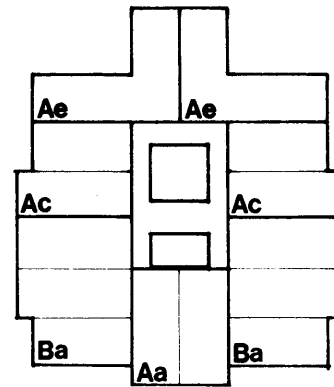
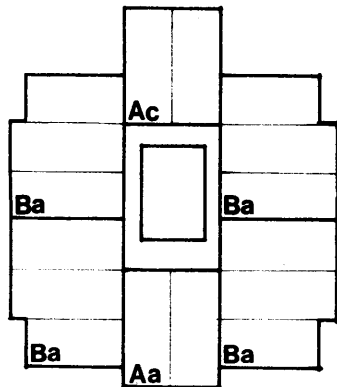
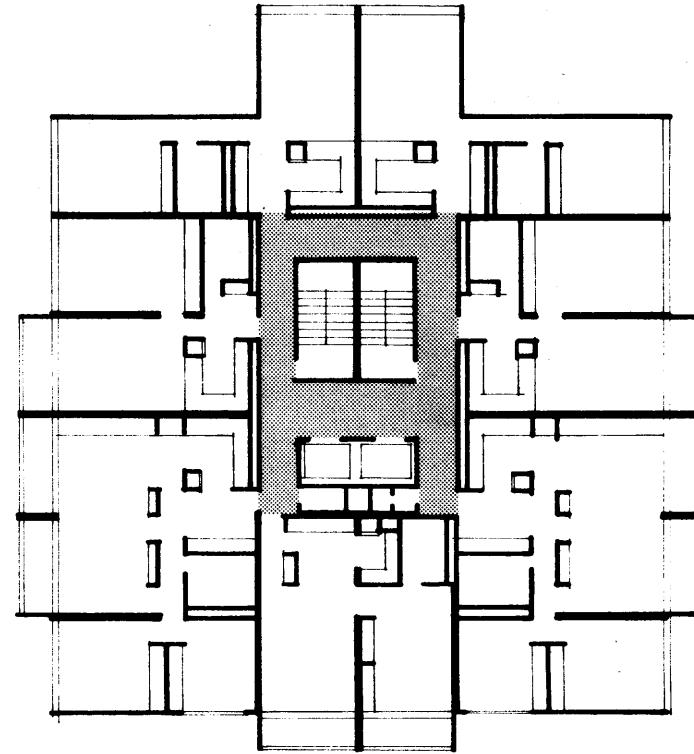
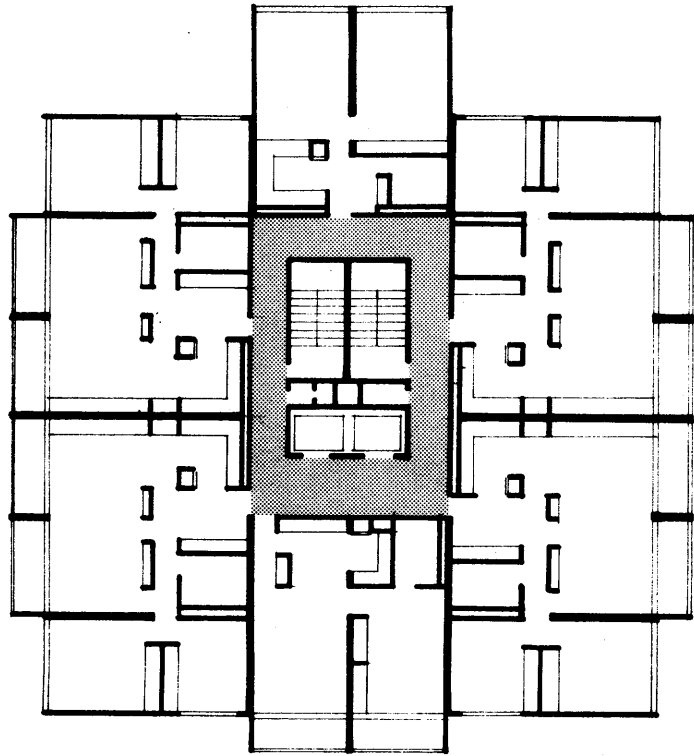

TOWERS

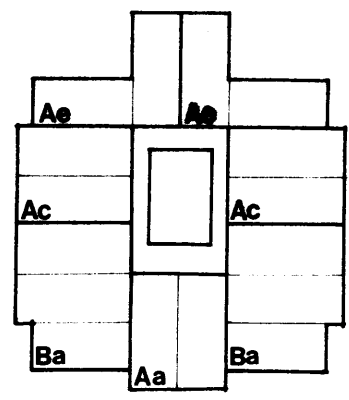
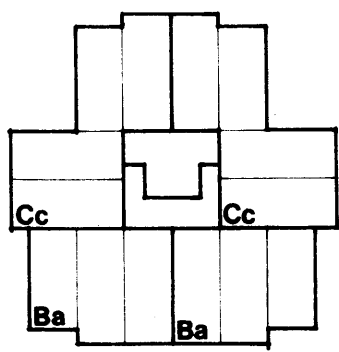
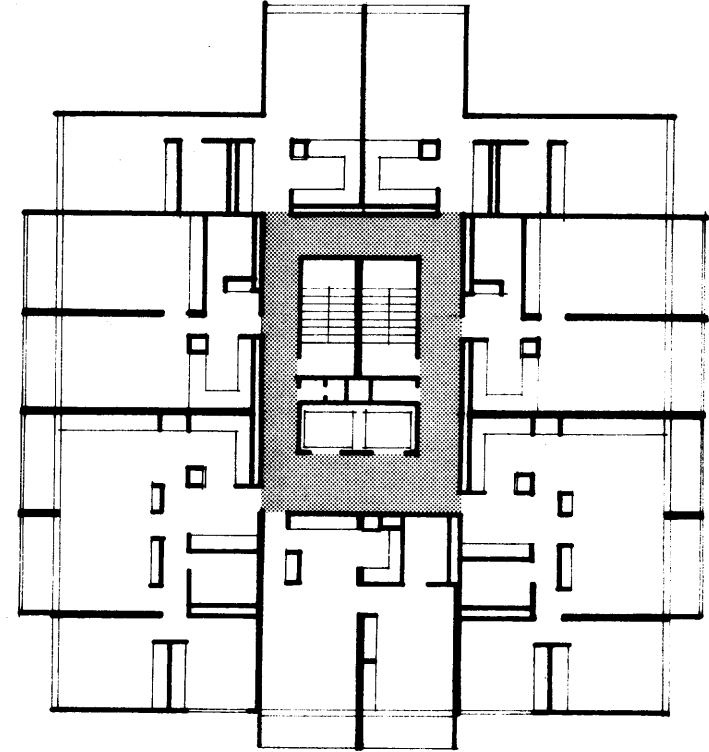
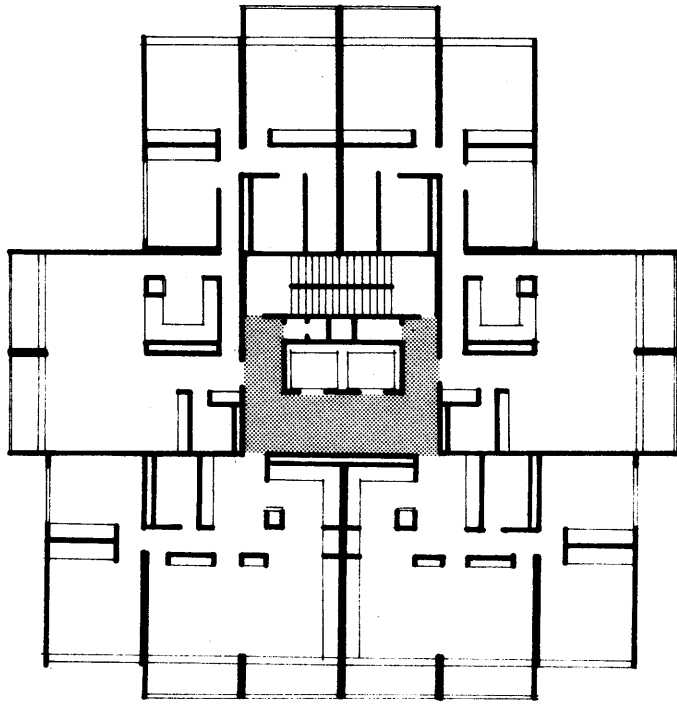

TOWERS

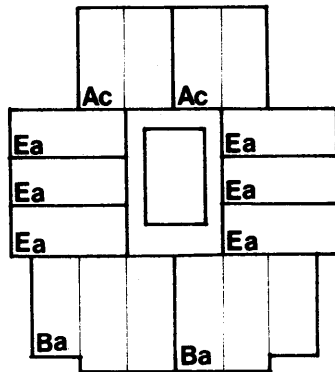
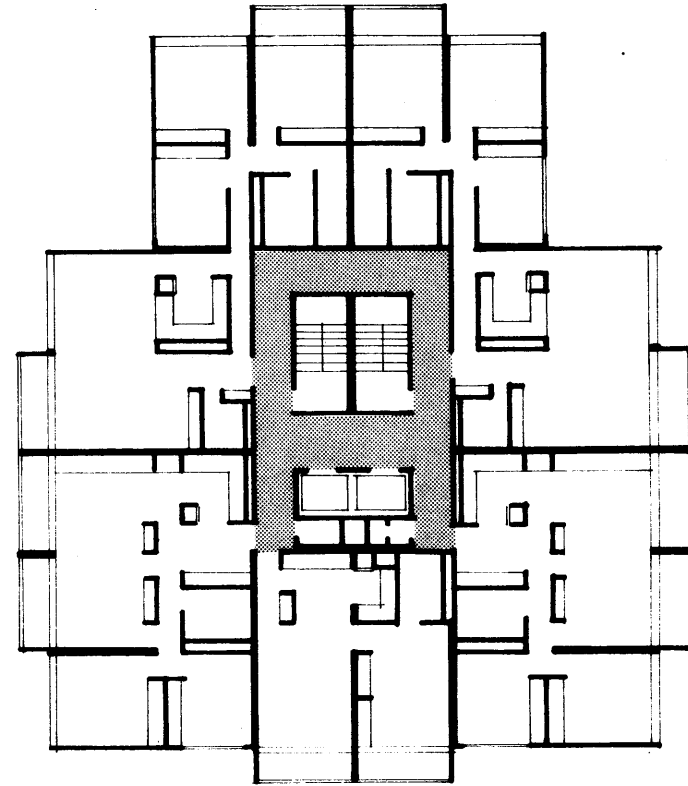
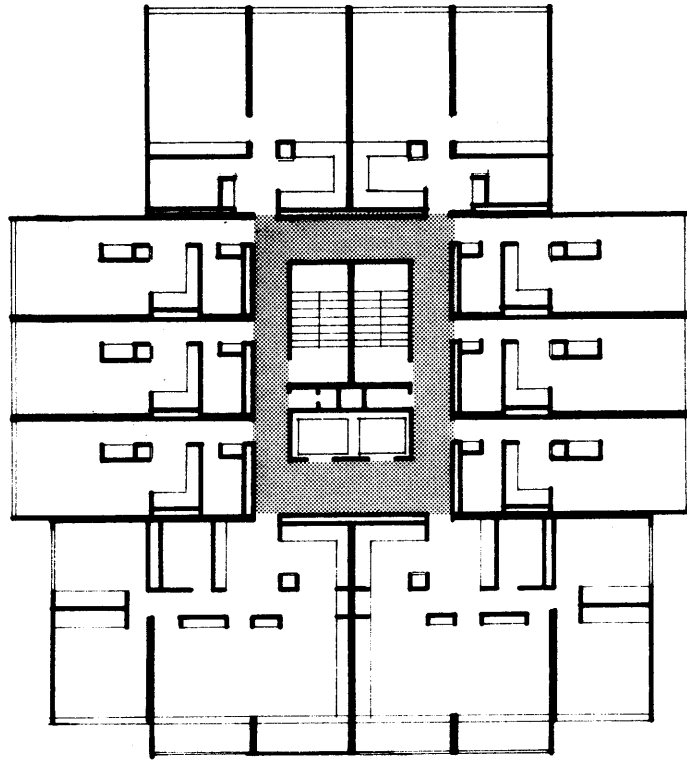

$1/25" = 1'-0"$

TOWERS

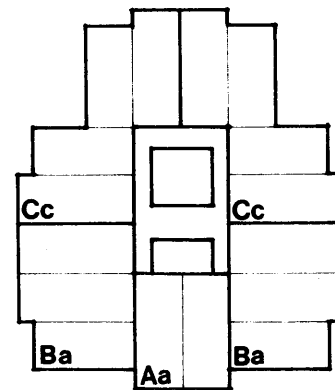

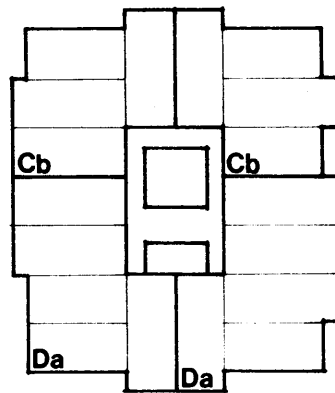
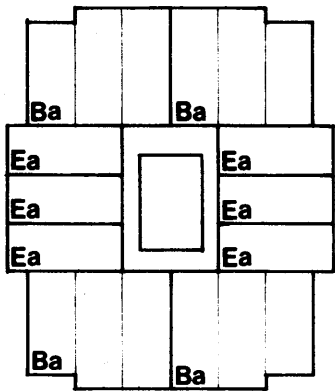
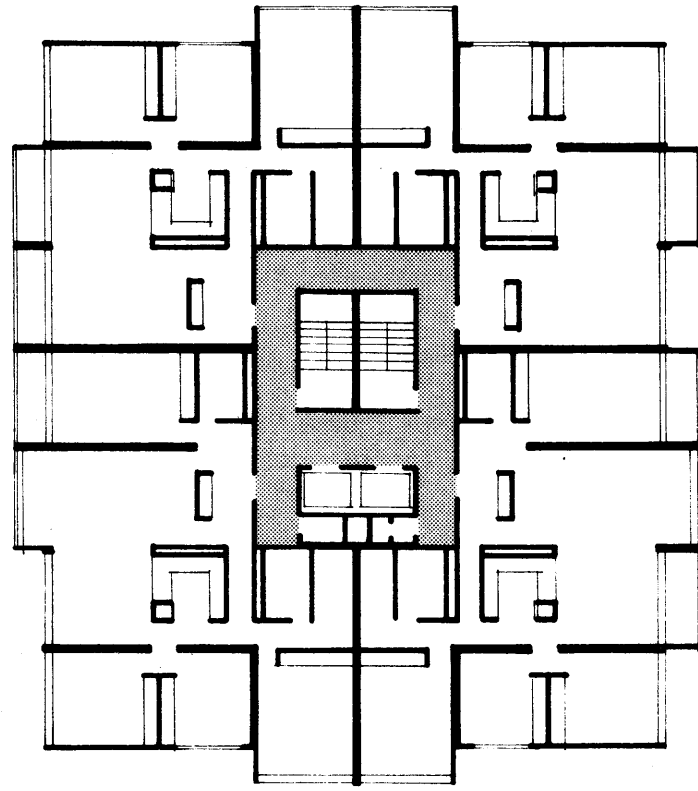
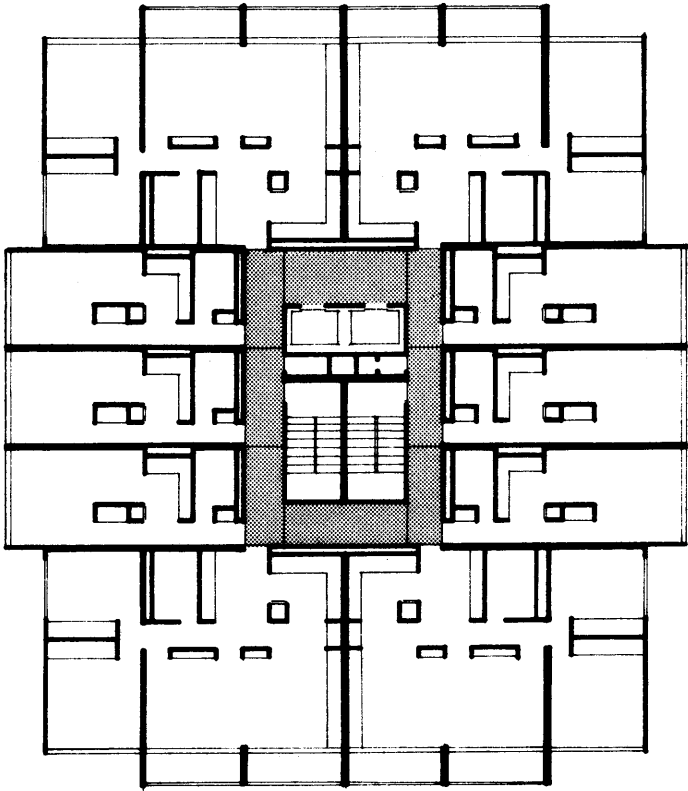

TOWERS

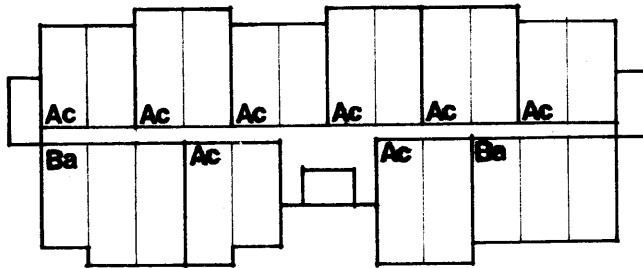
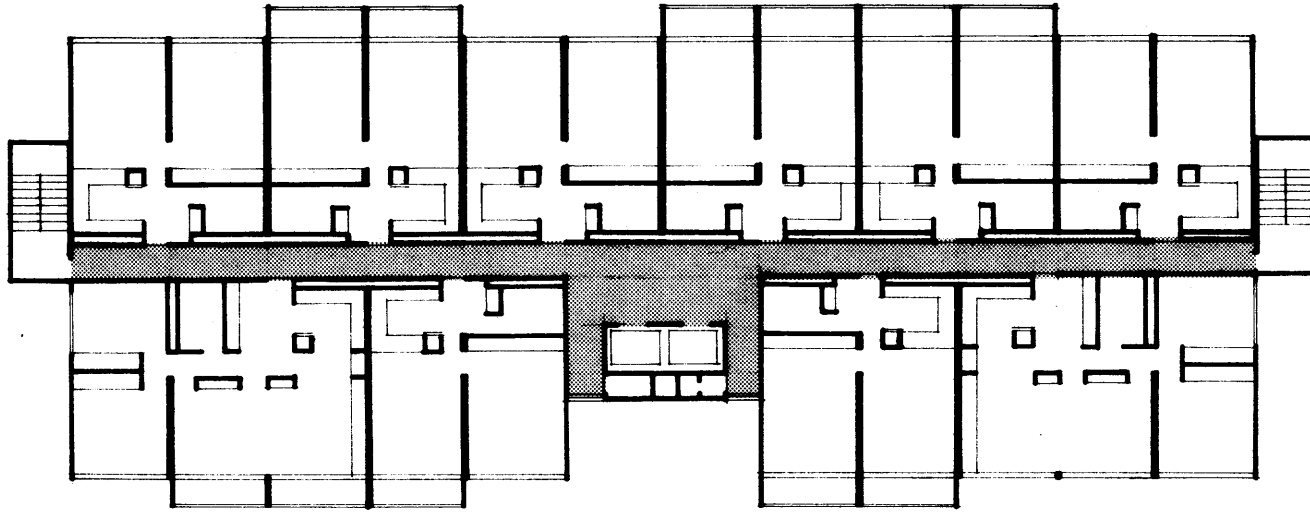

SLAB TYPE

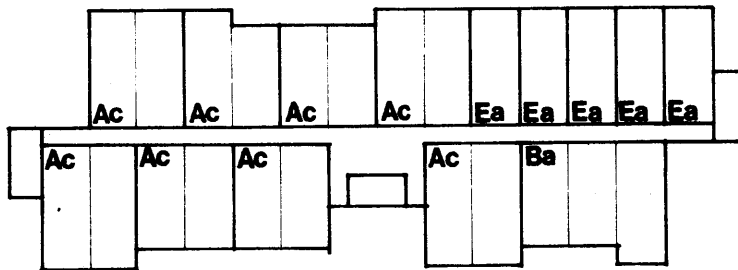
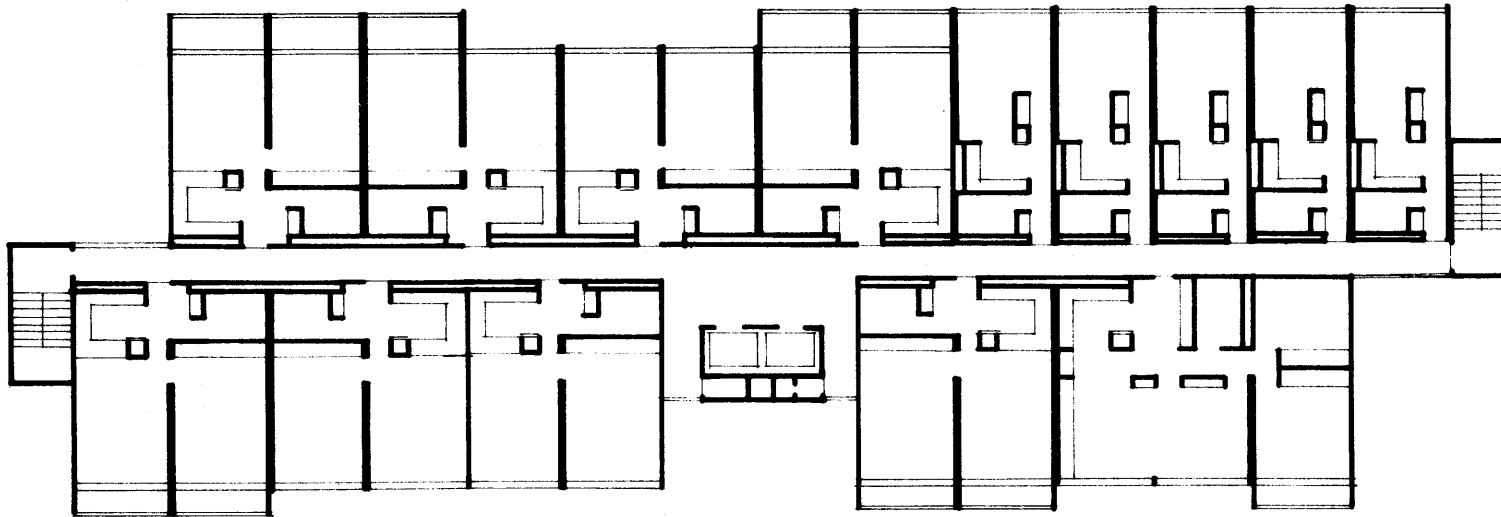

SLAB TYPE

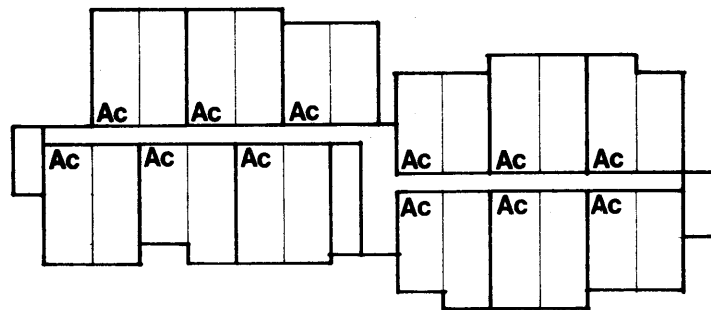
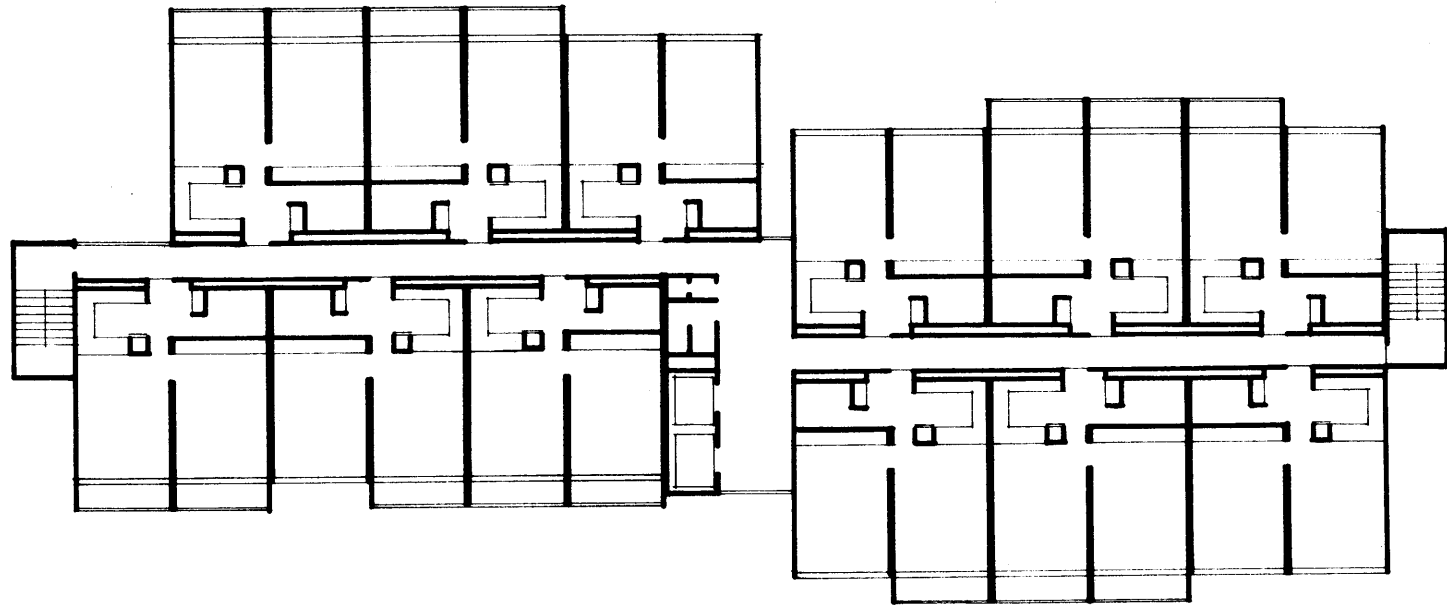

SLAB TYPE

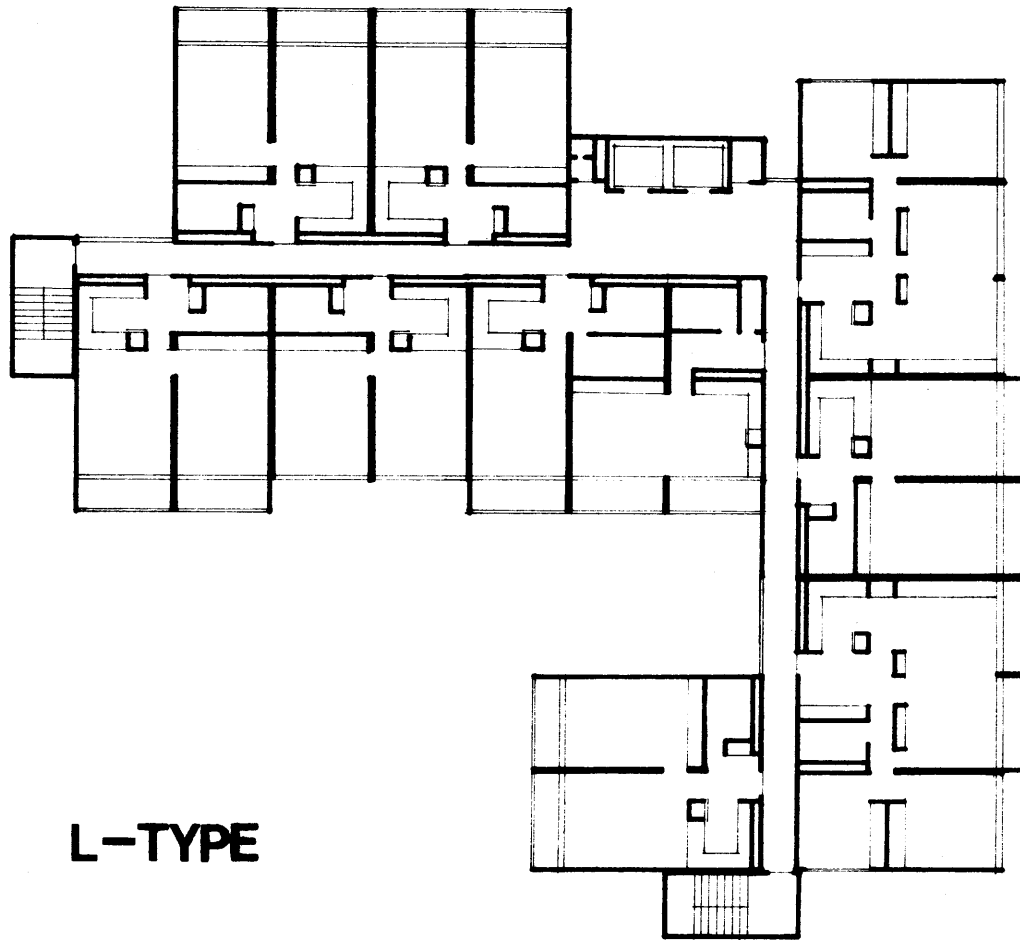

L-TYPE

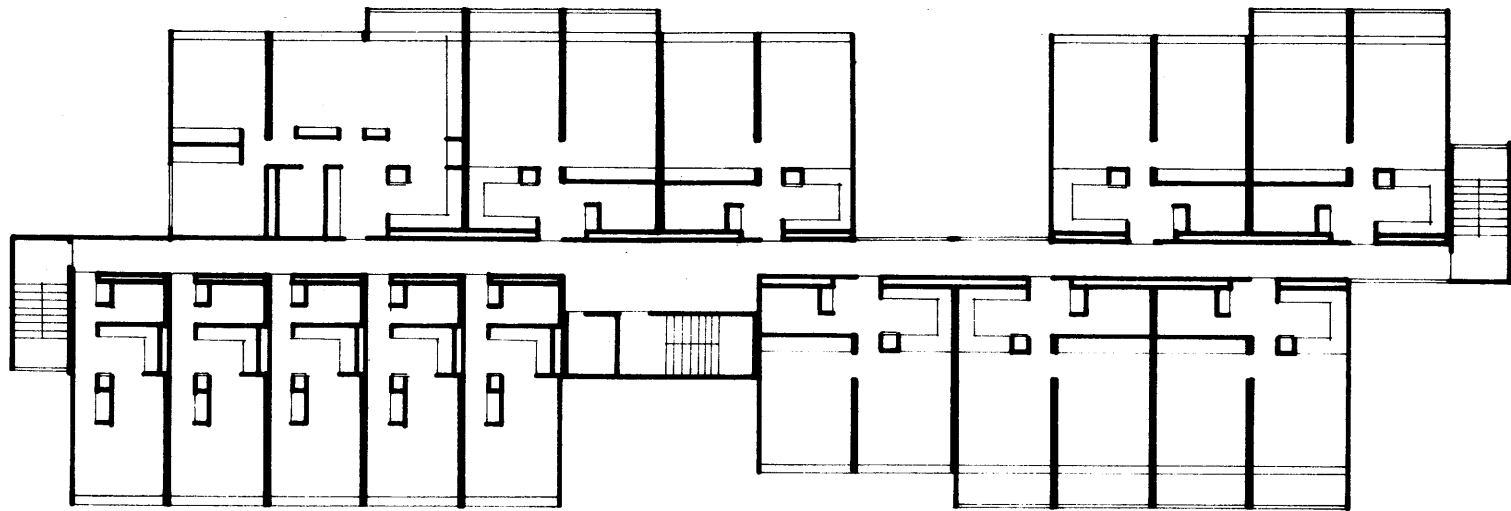

WALK-UP

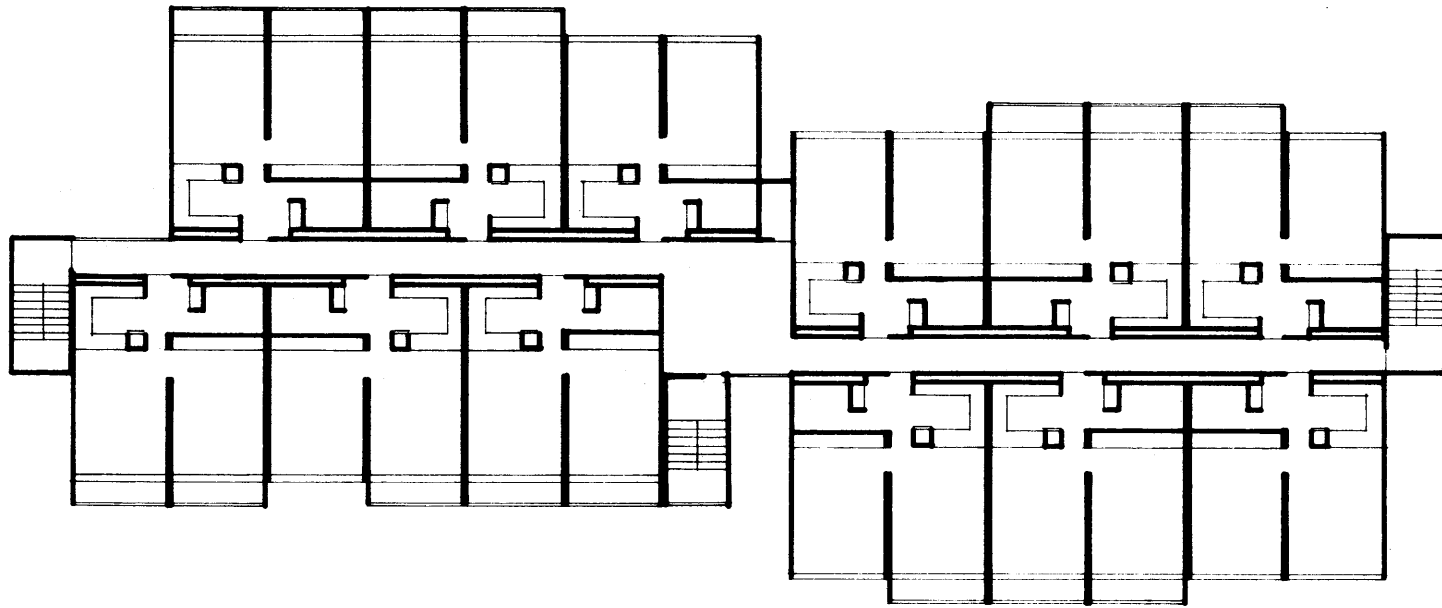

WALK-UP

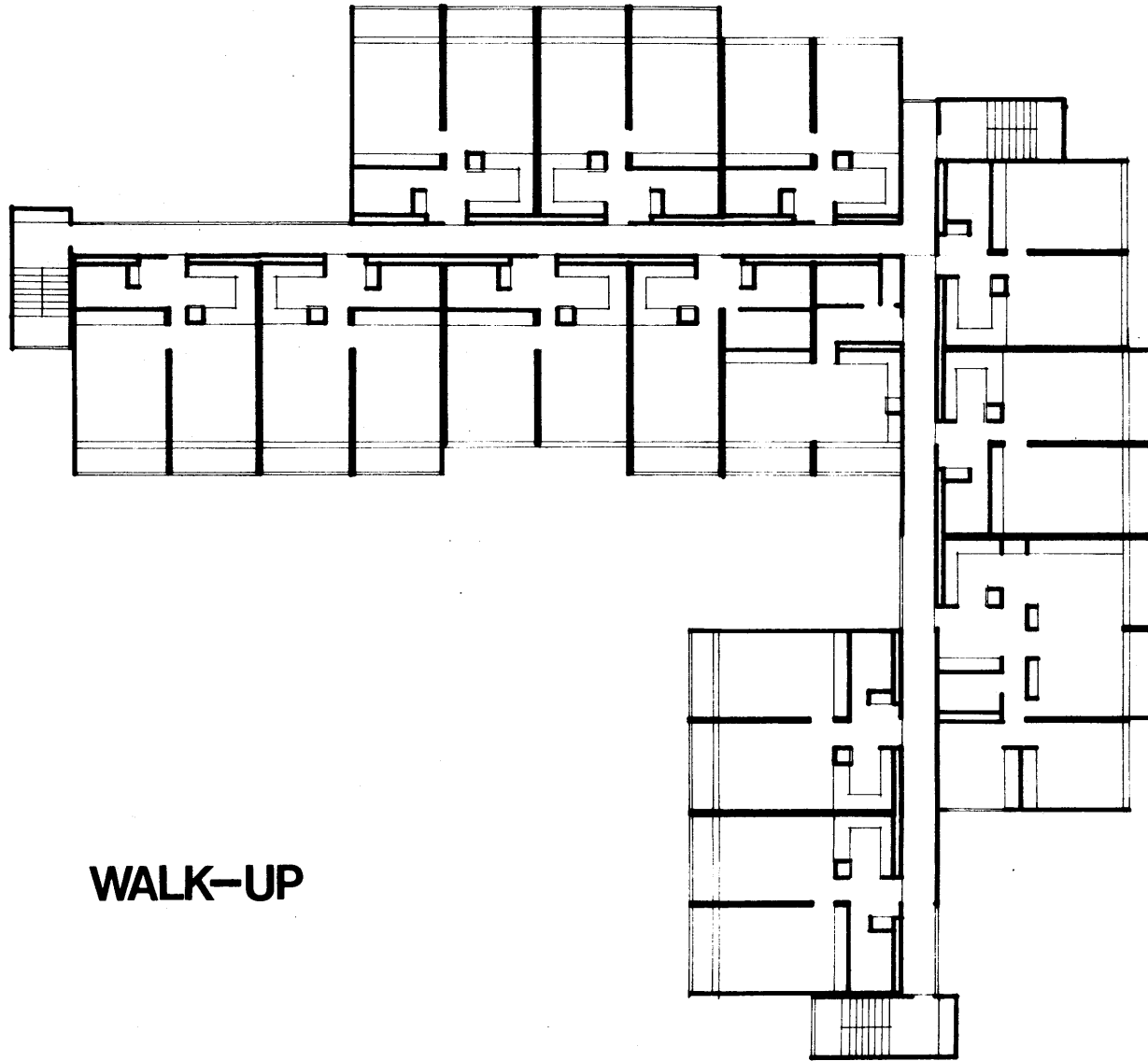

WALK-UP

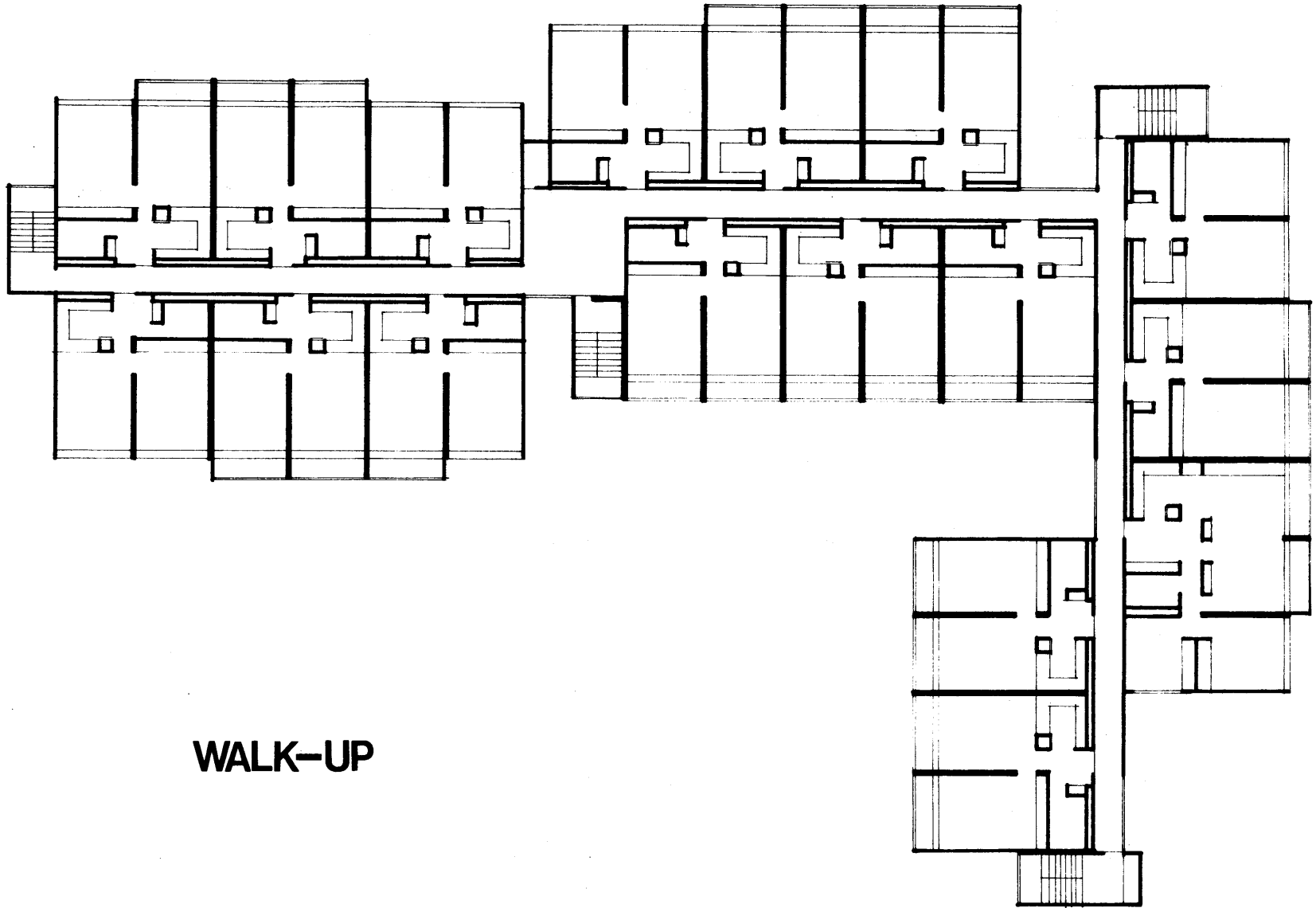

WALK-UP

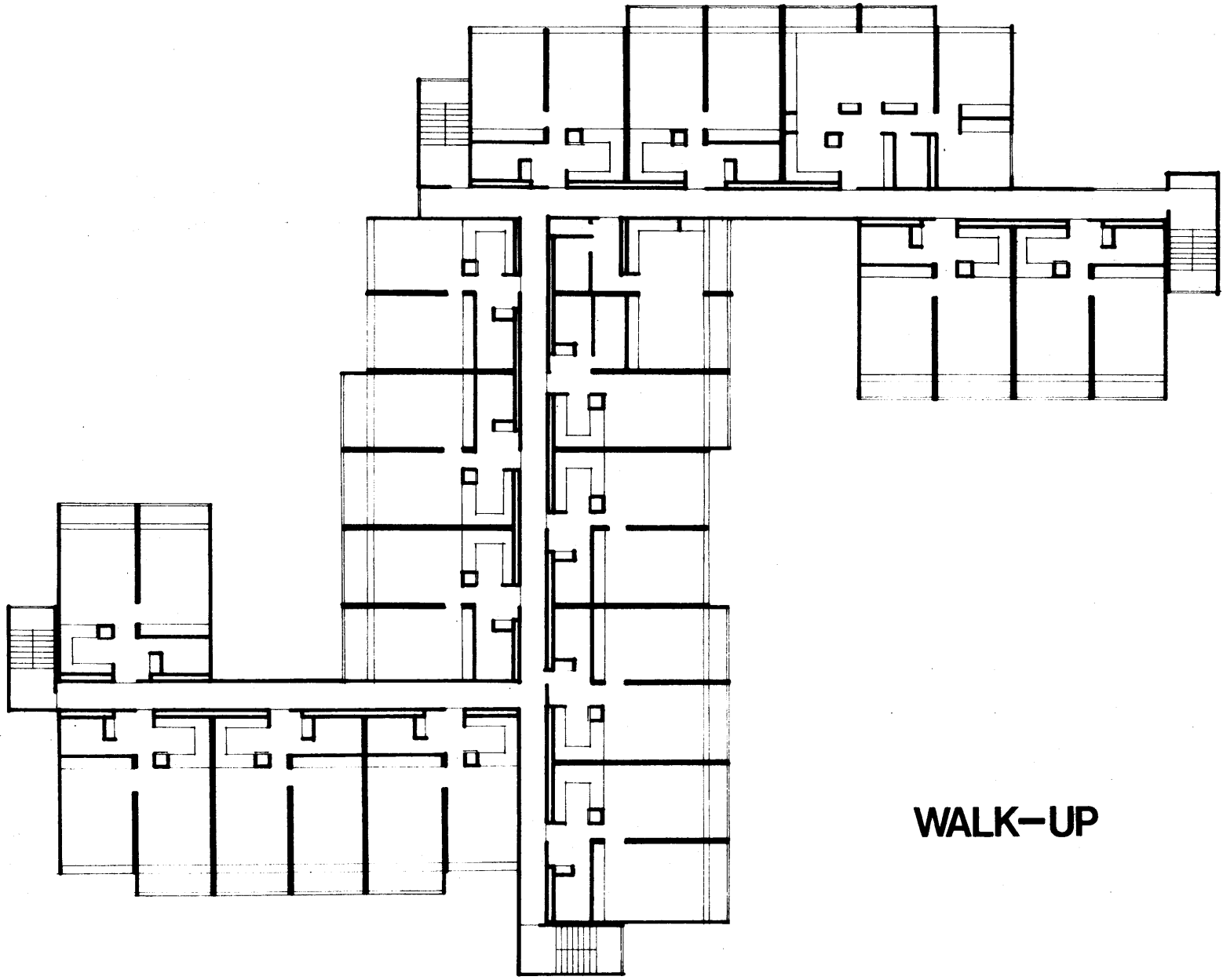

WALK-UP

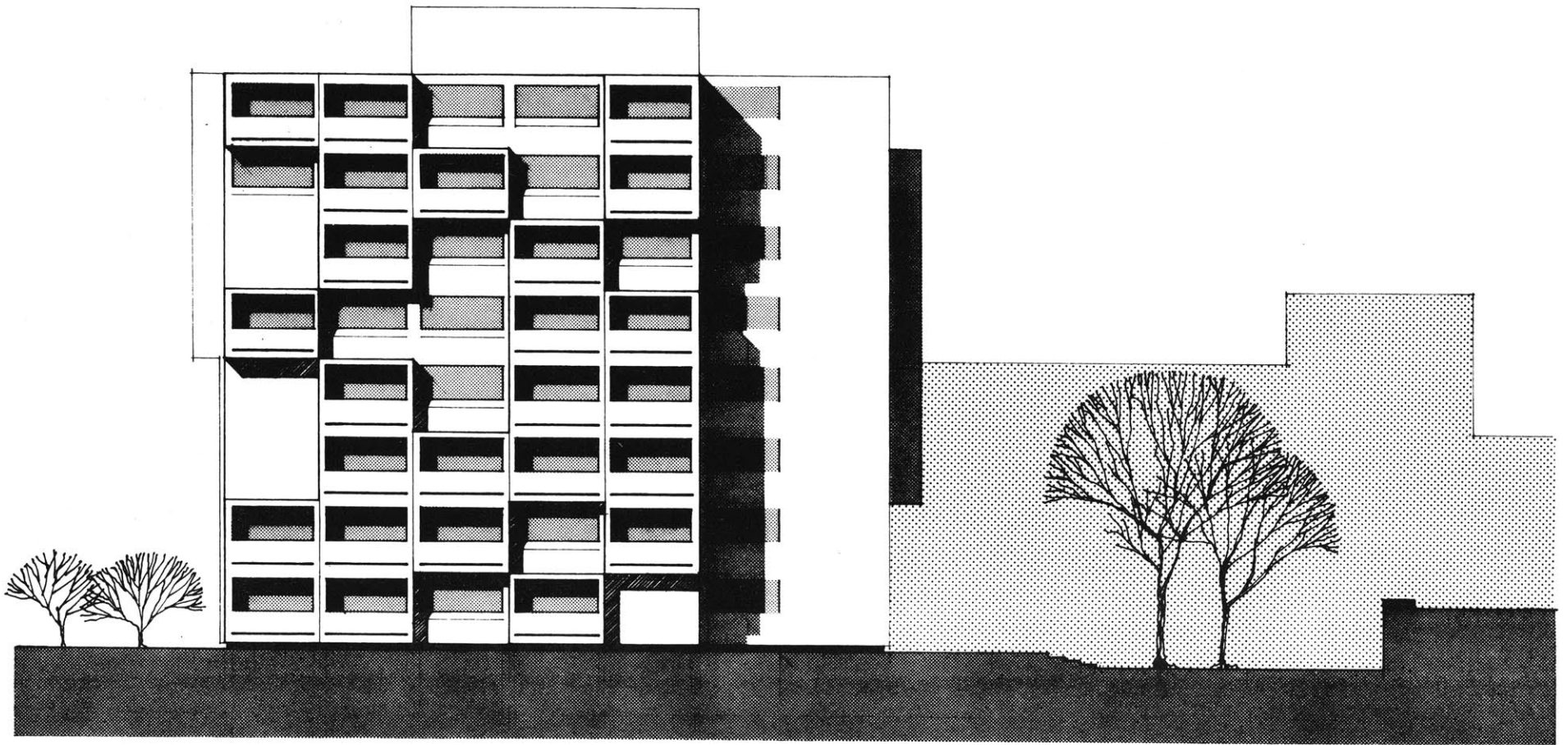

GENERAL ELEVATION

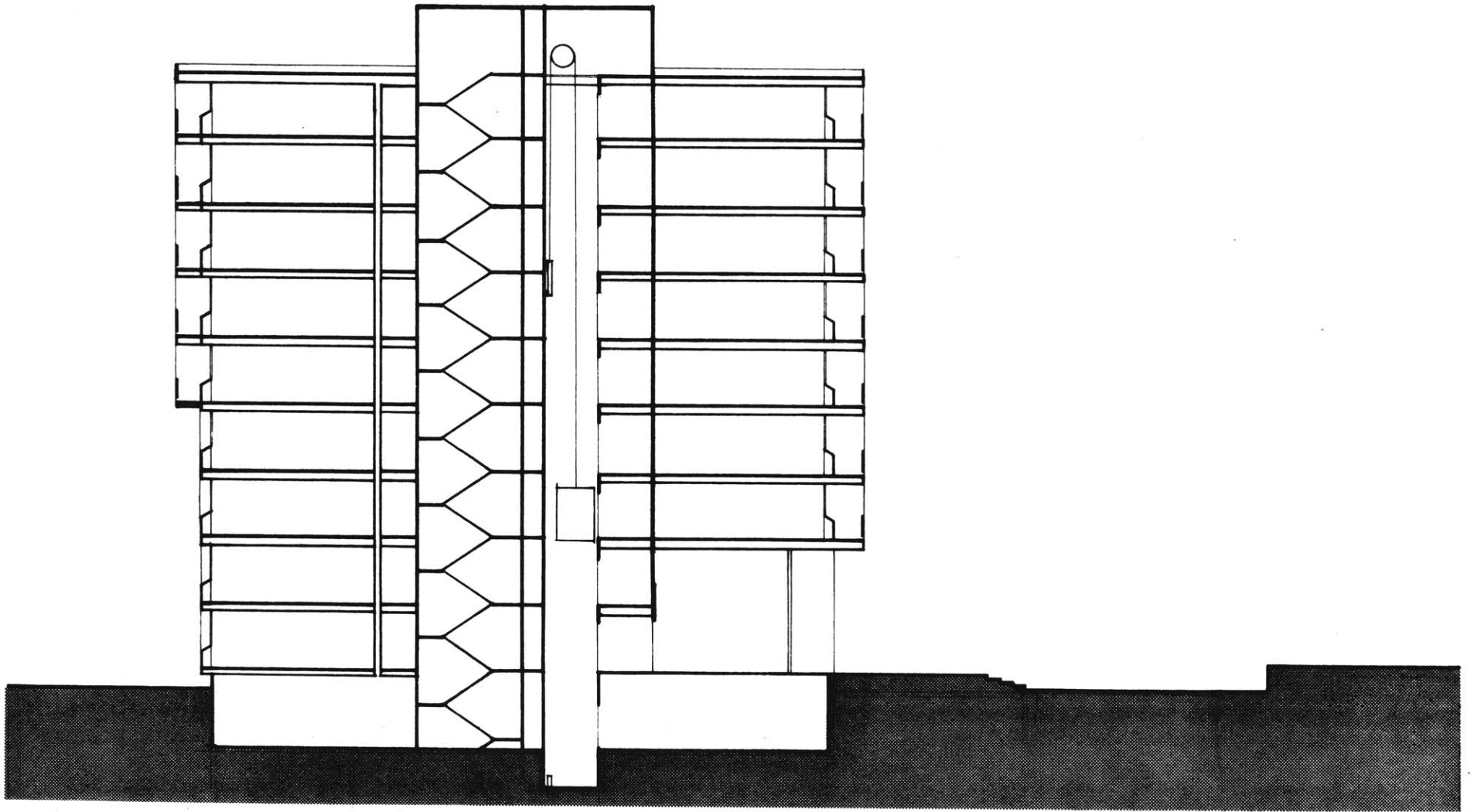

GENERAL SECTION

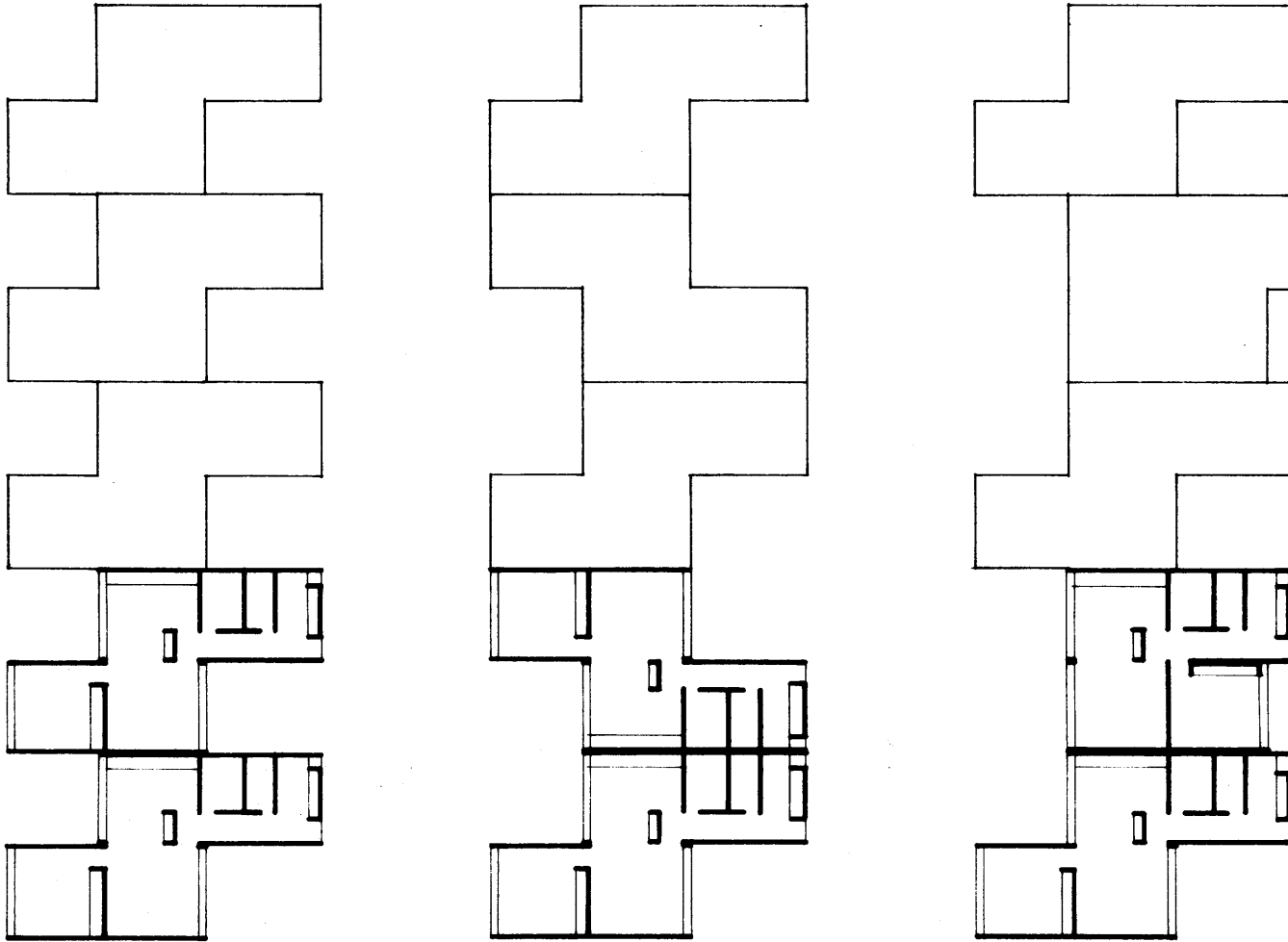

ROW HOUSES CLUSTERED IN VARIOUS WAYS



CONSTRUCTION DETAILS

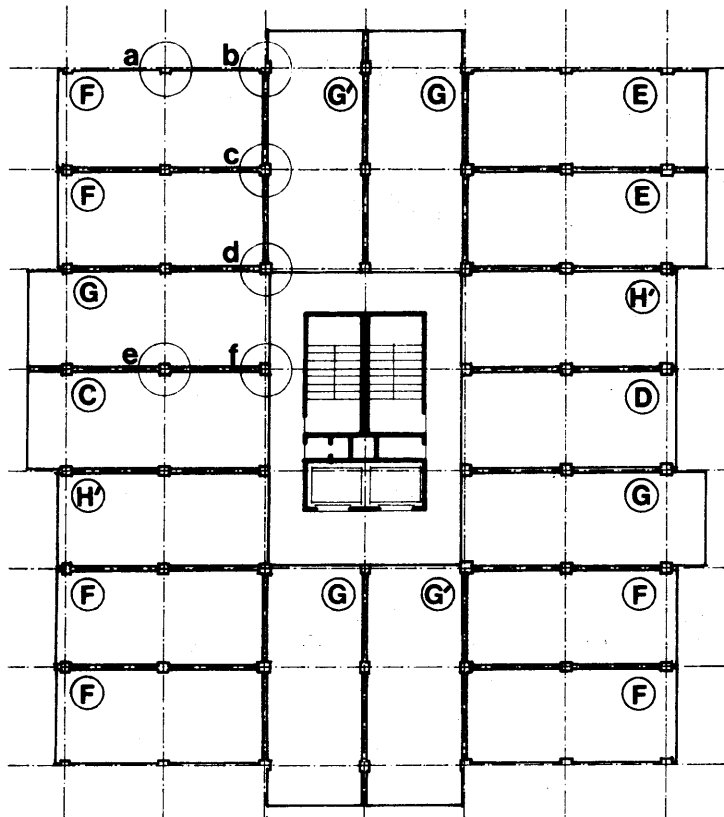

CIRCLED LETTERS INDICATE BOX TYPES

COMBINATION OF BOXES

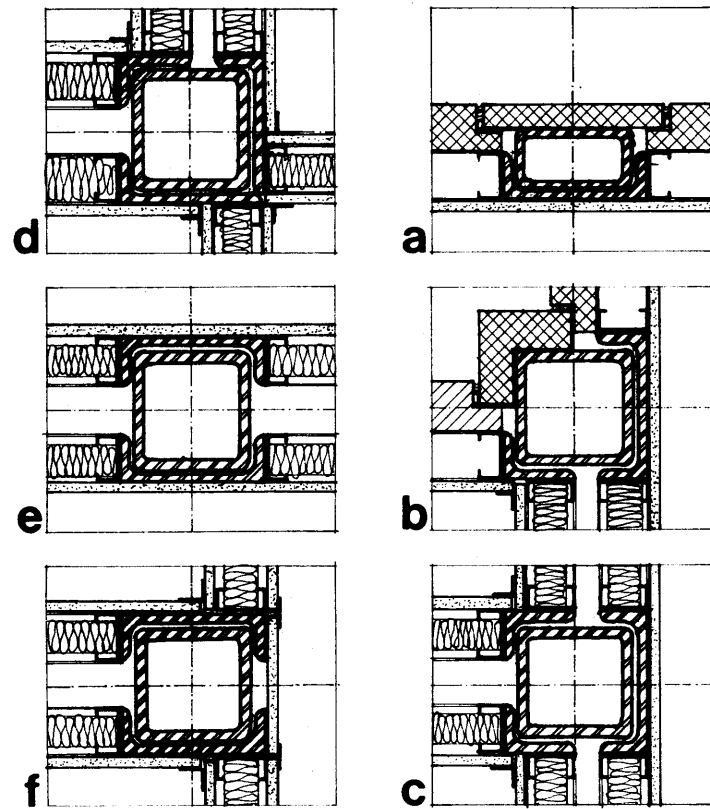

PLANS OF COLUMNS $\frac{1}{2}'' = 1'-0''$

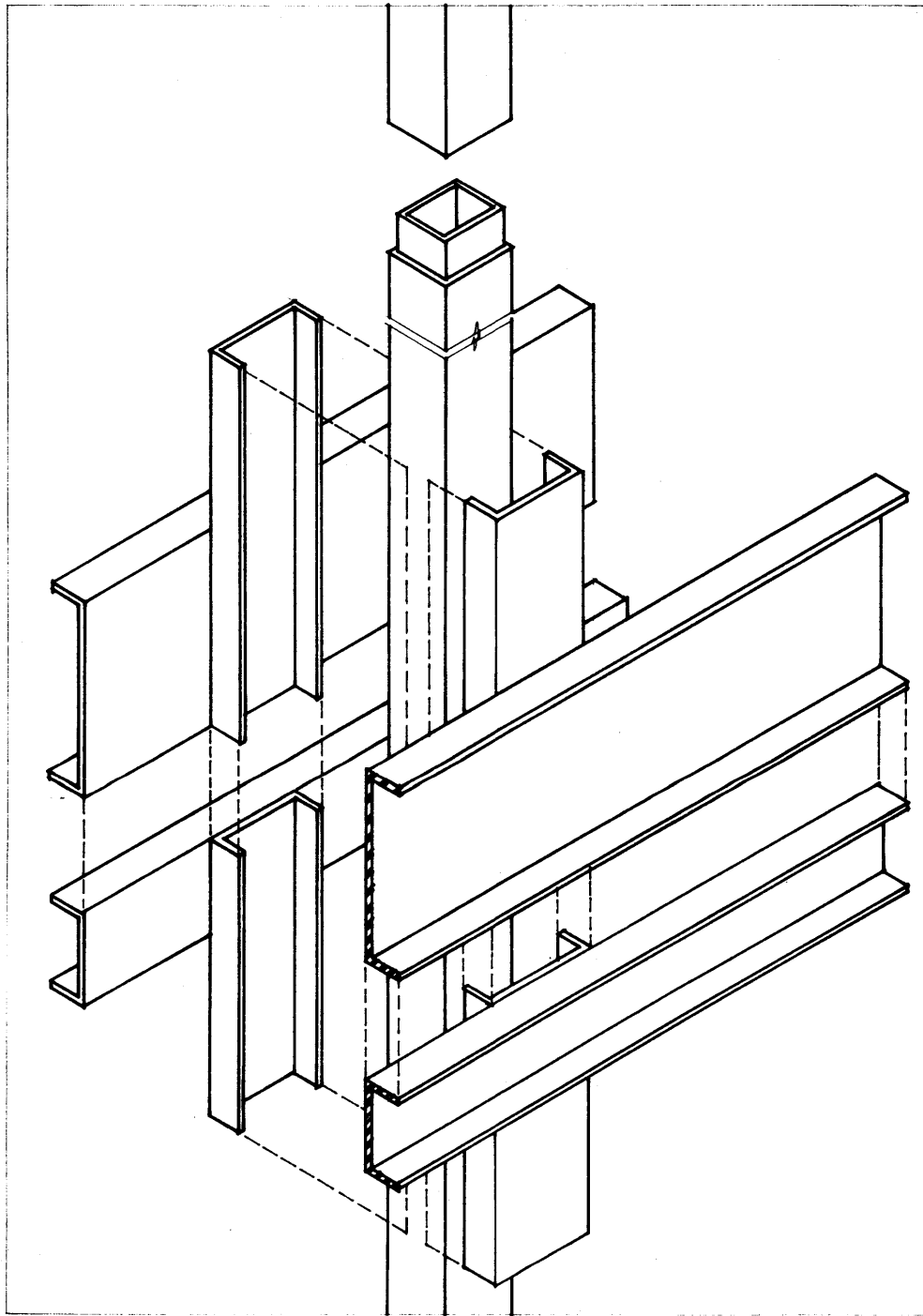

**DETAIL AT JUNCTION OF
FOUR MODULAR UNITS** 55

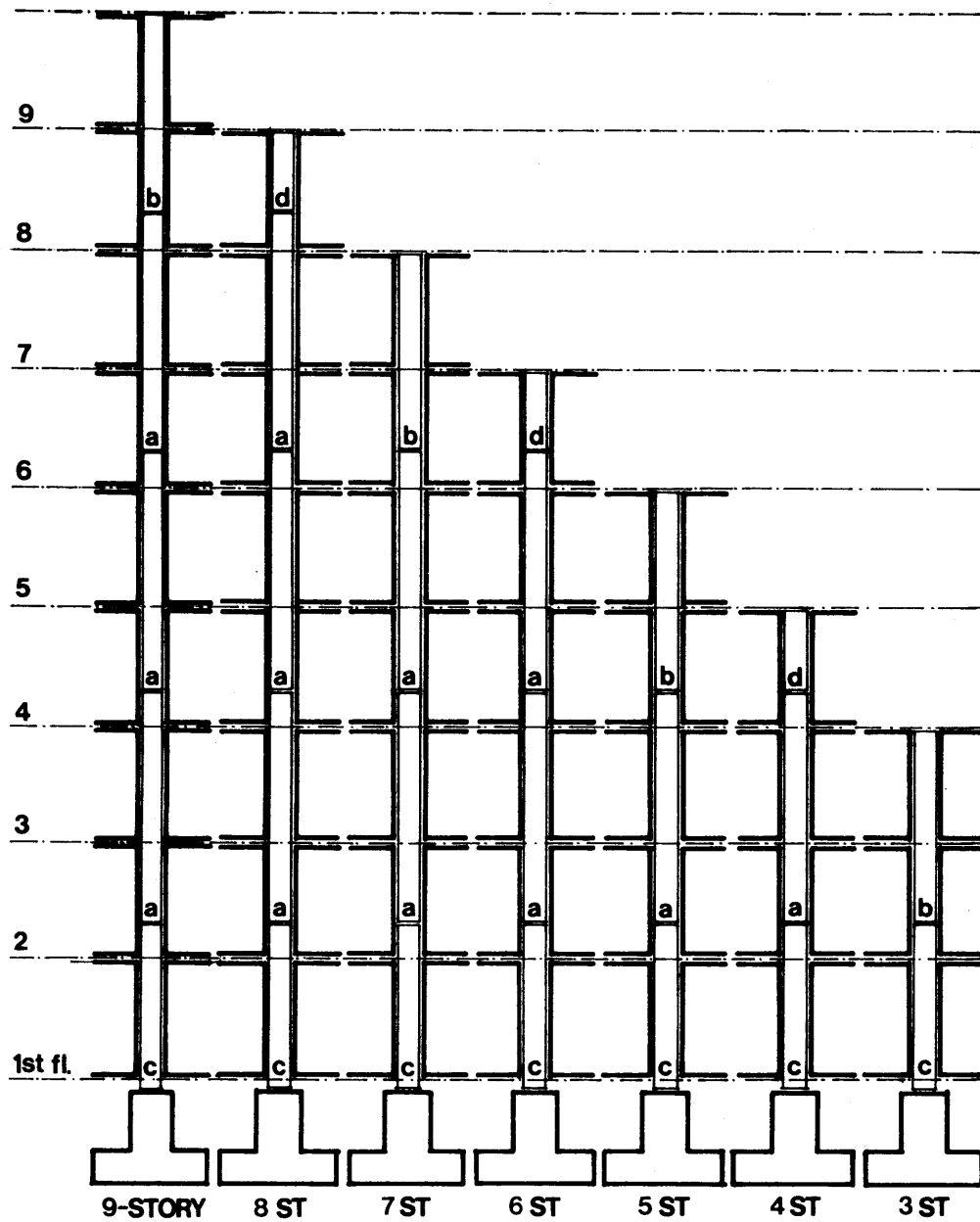

STACKING DIAGRAM OF TUBINGS NOT TO SCALE

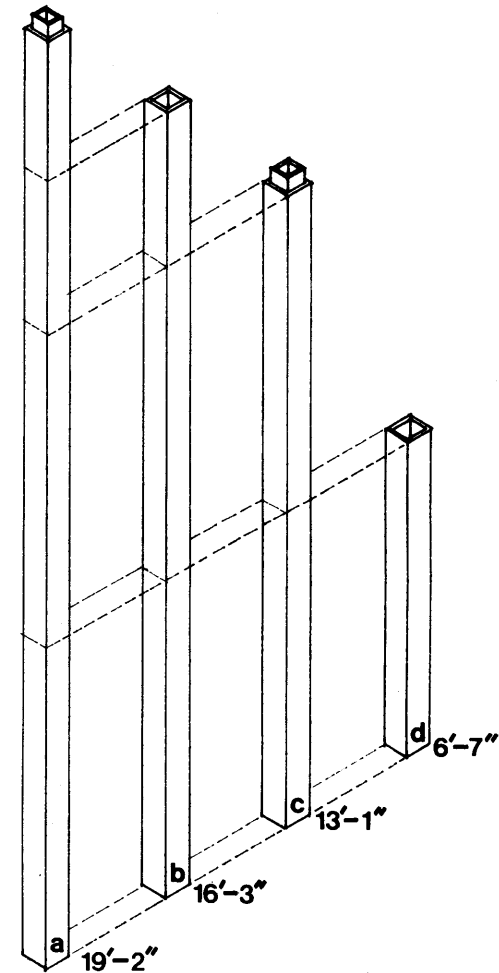

TUBING TYPES

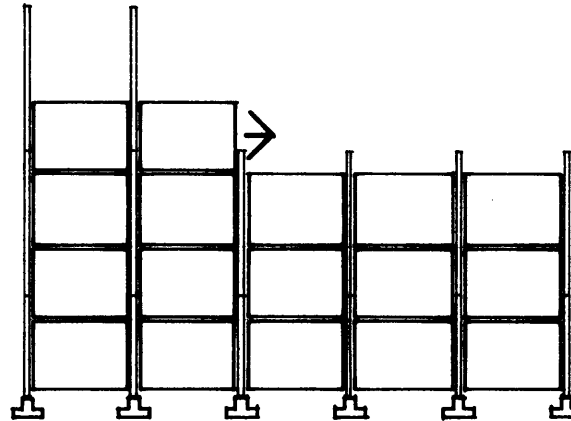
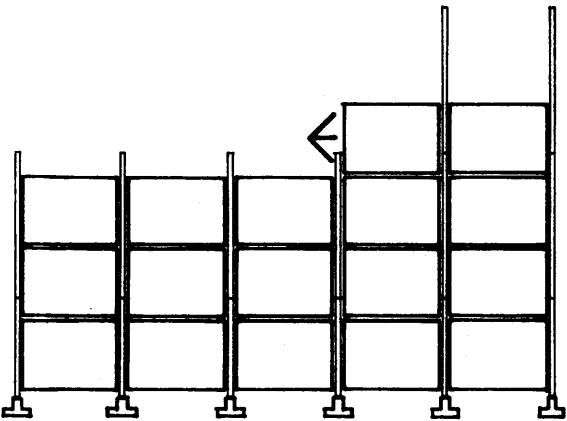
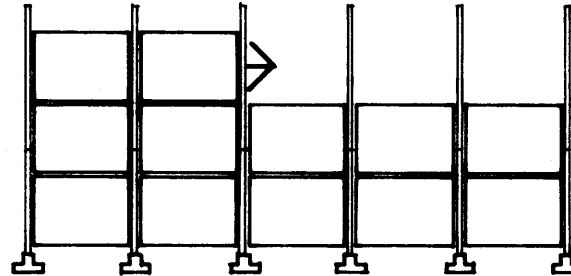
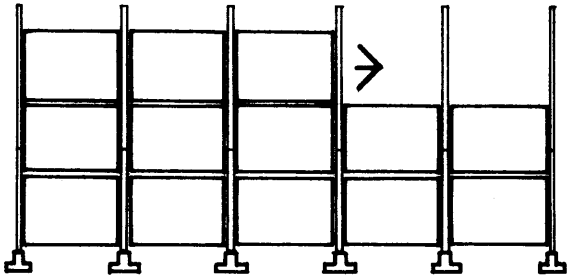
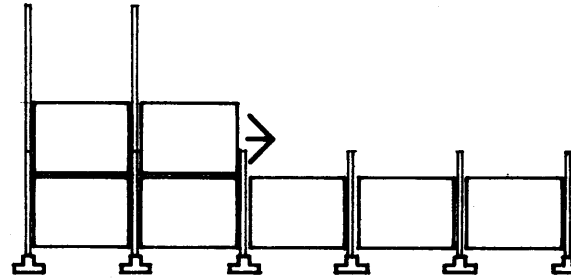
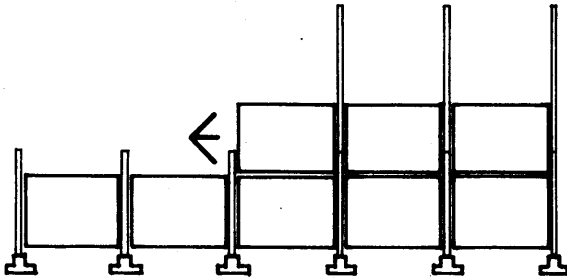
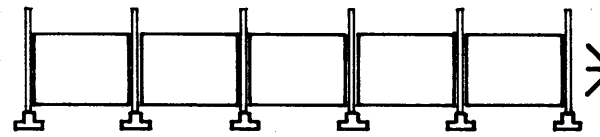
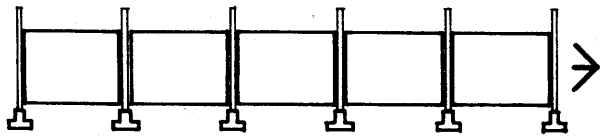

SCHEME A

SCHEME B

CONSTRUCTION SEQUENCE

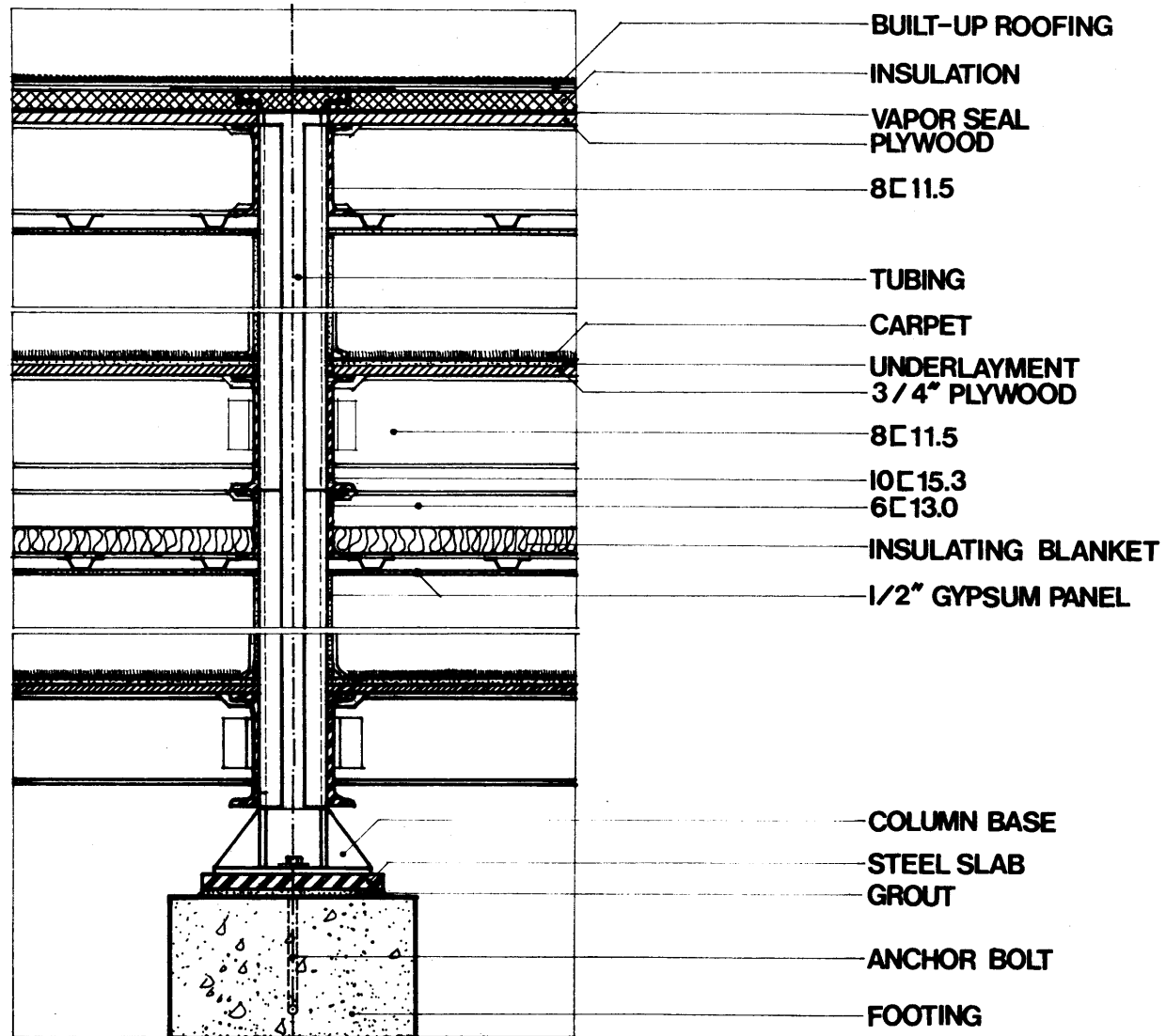

SECTION OF WALL AT COLUMNS 3/4"=1'-0"

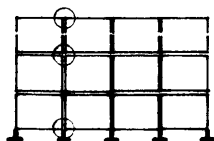

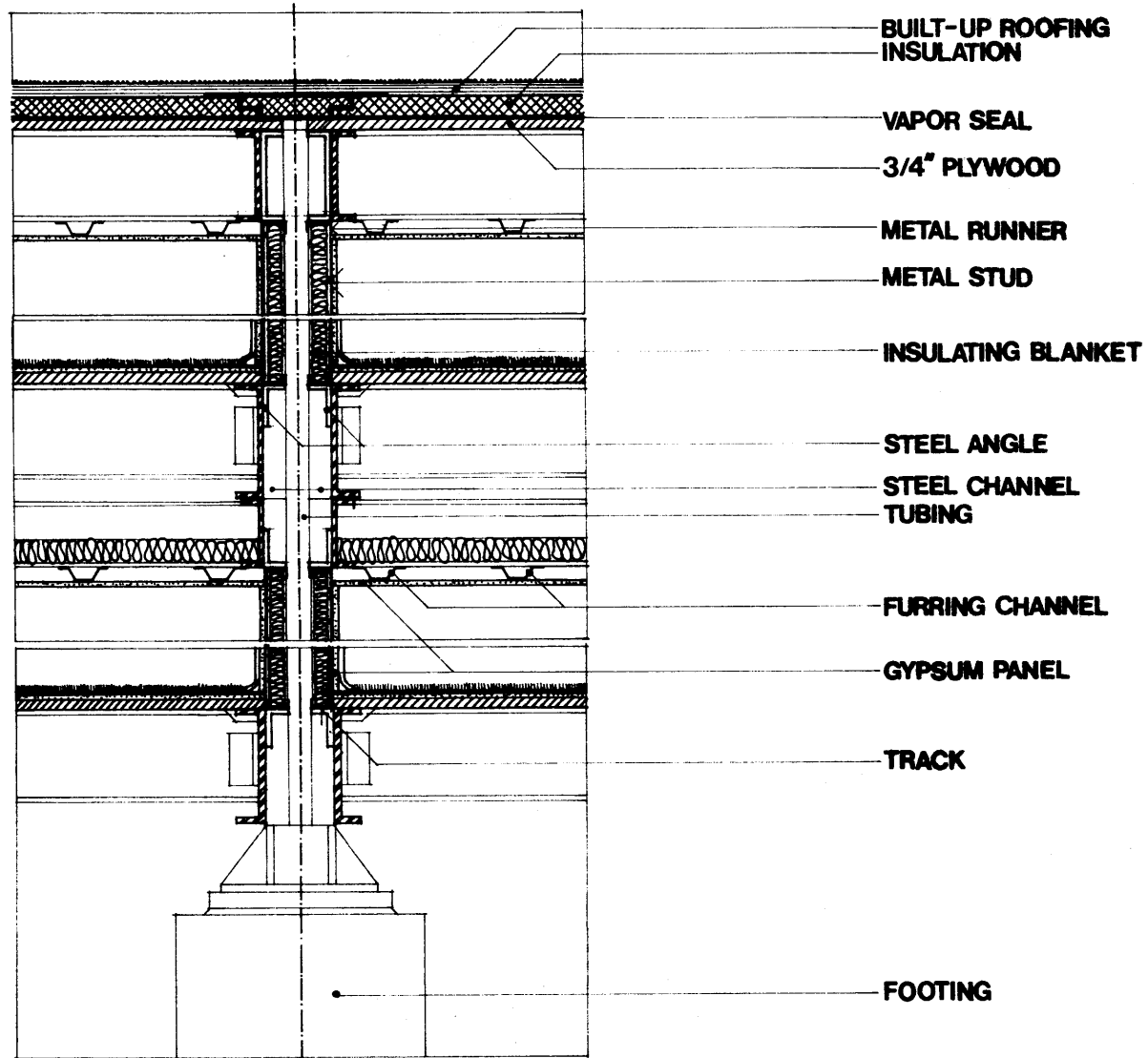

SECTION OF WALL 3/4" = 1'-0"

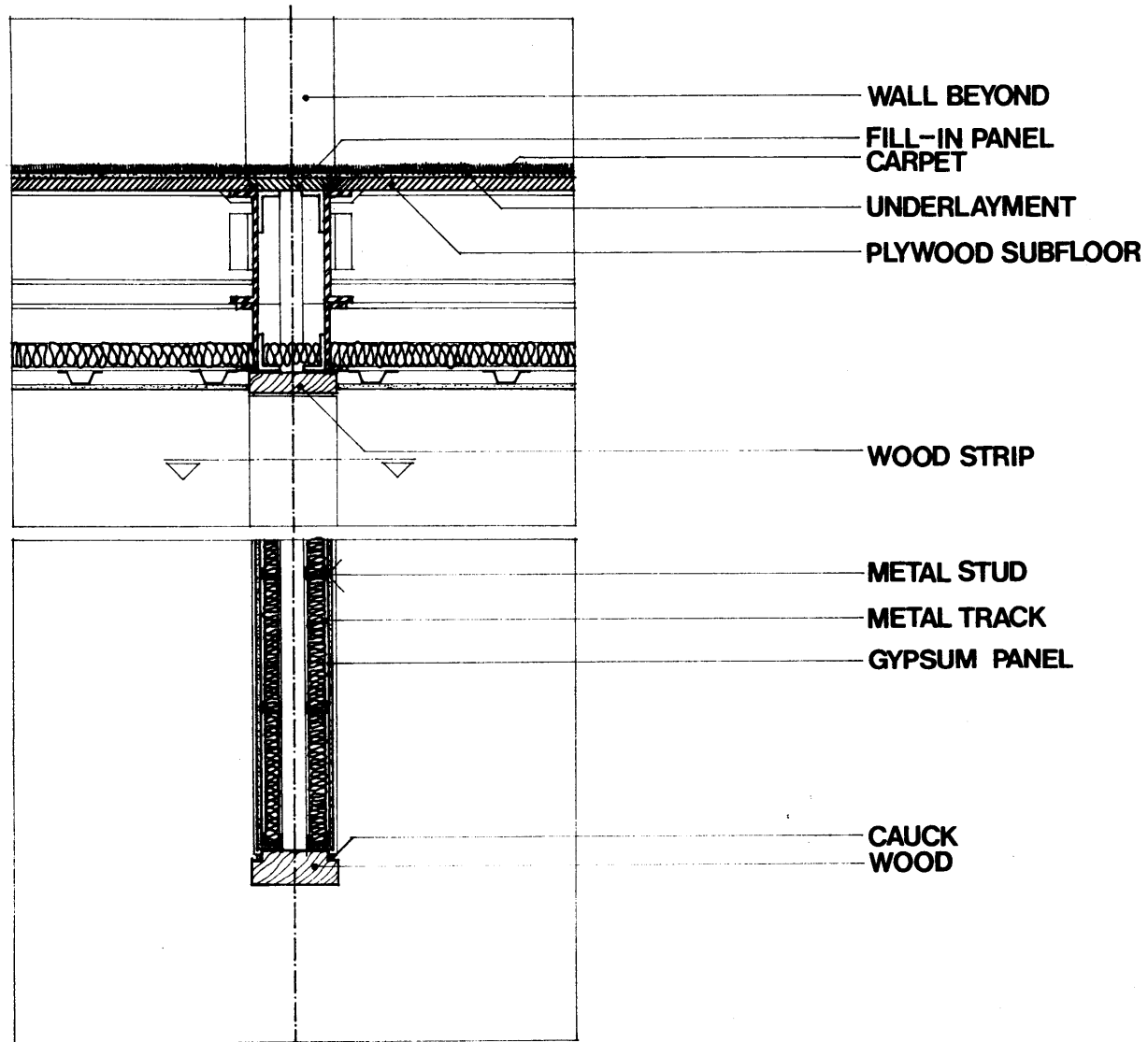

SECTION & PLAN AT OPENING BETWEEN TWO MODULAR UNITS

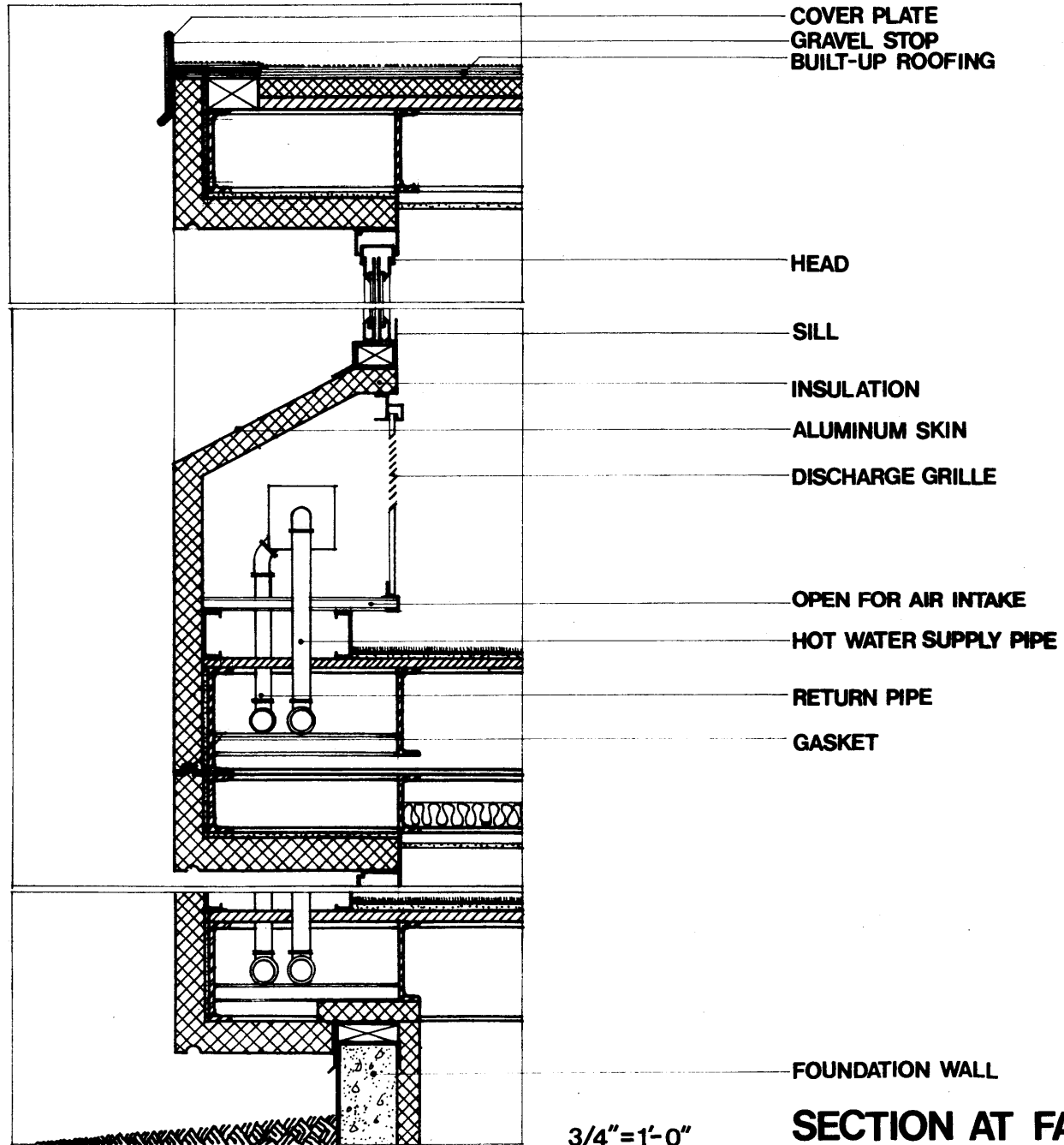

SECTION AT FACADE

BIBLIOGRAPHY

1. Carreio, Joseph, The New Building Block, Research Report No. 8, Center for Housing and Environmental Studies, Ithaca: Cornell University, 1968.
2. Hersey, Anthony and Litle, William A., Industrialized Housing Feasibility Study, Cambridge, Mass.: MIT Press, 1971.
3. MIT 1971 Department of Architecture Master's Class, Housing Systems: Seven Studies of Factory Produced Steel and Concrete Modular Units.
4. U. S. Department of Housing and Urban Development, In-Cities Experimental Housing Research and Development Project: Phase I Composite Report, Vol. III-Technology, Washington, D.C.: U. S. Department of Commerce, 1969.
5. Dietz, Albert G.H. ed., Industrialized Building Systems for Housing, Cambridge, Mass.: MIT Press, 1971.
6. U. S. Department of Housing and Urban Development, Housing Systems Proposals for Operation Breakthrough, Washington, D.C.: U. S. Govt. Printing Office, 1970.