

**System Dynamics Approach
to Address Urban Youth Homicide**

by

Carol Y. Choi

Submitted to the Department of Electrical Engineering and Computer Science
in Partial Fulfillment of the Requirements for the Degrees of
Bachelor of Science in Electrical Engineering and Computer Science
and Master of Engineering in Electrical Engineering and Computer Science
at the Massachusetts Institute of Technology

May 21, 1999
[June 1999]

© Copyright 1999 Carol Y Choi. All rights reserved.

The author hereby grants to M.I.T. permission to reproduce and
distribute publicly paper and electronic copies of this thesis
and to grant others the right to do so.

Author

Department of Electrical Engineering and Computer Science

May 21, 1999

Certified by

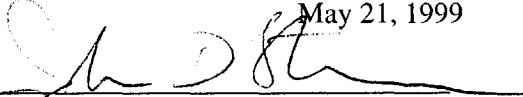
John Sterman
Thesis Supervisor

Accepted by

Arthur C. Smith
Chairman, Department Committee on Graduate Theses

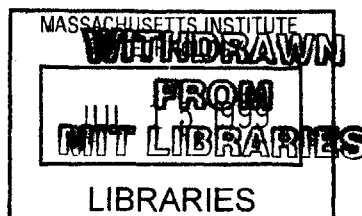

ENG

Table of Contents

Abstract	5
Acknowledgements	7
1.0 Introduction	9
1.1 Problem Statement	9
1.2 Motivation and Goal	10
2.0 Background	12
2.1 Boston Gun Project	13
2.2 Related Policy Research	15
2.3 Related System Dynamics Work	19
3.0 HOMICIDE Model	21
3.1 Introduction to the Model	21
3.2 Population Sector	24
3.3 Handguns Sector	26
3.4 Homicides Sector	29
3.5 Gun Project Sector	31
4.0 Policy Experiments and Recommendations	34
4.1 Base Run Description	34
4.2 Program Implementation	34
4.3 Sensitivity Tests	37
4.3.1 Gun Removal Probabilities	37
4.3.2 Incarceration Time	38
4.3.3 Acquisition Time Effects	40
4.3.4 SocioEconomic Level	42
4.4 Theft and Reselling	43
4.5 Limited Resources	45
4.6 Conclusion	47
5.0 Bibliography	49
6.0 Appendix A – HOMICIDE Model Documentation	51

Table of Figures

Figure 1: Homicide Victimization Rates per 100,000 Youths ages 14-17	12
Figure 2: Annual Homicide Rates for Selected Cities, 1985-1994	13
Figure 3: Basic Dynamics	22
Figure 4: Population Sector	24
Figure 5: Population Conversion Rate Formulation	26
Figure 6: Handguns Sector	27
Figure 7: Handgun Acquisition Rate Formulation	28
Figure 8: Homicides Sector	29
Figure 9: Conflicts Formulation	29
Figure 10: Fatality Probability Formulation	30
Figure 11: Effort Formulation	31
Figure 12: Gun Project Sector	32
Figure 13: Results of Program Implementation	35
Figure 14: Gun Removal Time Sensitivity Tests	38
Figure 15: Incarceration Time Sensitivity Tests	39
Figure 16: Illegal Acquisition Time Sensitivity Tests	41
Figure 17: SEL Sensitivity Tests	42
Figure 18: Presence of Theft and Reselling	44
Figure 19: Effects of Program Termination in year 2000	47

System Dynamics Approach to Address Urban Youth Homicide

by

Carol Y. Choi

Submitted to the

Department of Electrical Engineering and Computer Science

May 21, 1999

In Partial Fulfillment of the Requirements for the Degree of
Bachelor of Science in Electrical Engineering and Computer Science
and Master of Engineering in Electrical Engineering and Computer Science

ABSTRACT

The increasing prevalence of homicides among youths has been a problematic issue since the crystallization of ghettos in the 1950s. The implications of public policies designed to combat the rates of lethal crimes among youths are often not well understood. With the added restriction of limited resources with which to address this issue, policy makers often find themselves at odds in determining how to focus efforts. One major reason for the contention is that the feedback effects of policies implemented today are often not apparent for extensive periods of time, making it difficult to associate tomorrow's benefits and/or negative consequences with the actions taken today.

The HOMICIDE system dynamics model provides a tool for persons concerned with addressing the issue of juvenile homicides from handgun wounds in disadvantaged communities. It permits the exploration of the dynamics within a community of adolescents leading to and from population mix, supply of handguns, rate of homicide, and social and economic conditions. It also allows users to explore the effects of supply-side gun enforcement and prevention policies.

Thesis Supervisor: John Sterman

Title: J. Spencer Standish Professor of Management

Acknowledgements

I would like to offer my humble and sincere gratitude to:

My Parents and Family, for always supporting me in every endeavor and opportunity, even in those times when you found it necessary to turn your heads away in opposition;

My Friends, for so many years of sympathy and understanding;

Andre Willis, for helping me to get started in this endeavor;

The Sloan PC Lab Thesis Crew, for amusing me through the final stretch with gossips, one-way stories, and tight tales of princesses;

My Students, for taking up every last second of my time all year long so I could never get to work on my thesis;

System Dynamics Doctoral Seminar Group, for all the feedback and suggestions;

Nelson Repenning and *Jim Hines*, for teaching me all the little I understand about system dynamics;

& *John Sterman*, for supervising my work and never once pressuring me.

1.0 Introduction

1.1 Problem Statement

The causes and prevention of adolescent violence generate continuing controversy. Violence is an especially problematic issue for adolescents who live in disadvantaged urban neighborhoods typified by limited legitimate employment opportunities, high rates of unemployment, poor quality schools, and few appropriate role models. These adolescents are more likely to be exposed at a young age to violence as a normal and/or necessary pattern of behavior. They are also too often characterized by a high rate of victimization and involvement in violent and even homicidal incidents.

Until recently, the rate of youth homicides in the U.S. has been rising. Between 1984 and 1993, the rate of homicides committed by juveniles in the U.S. grew 169%.¹

However, this trend is not necessarily irreversible. In 1995, the juvenile murder arrest rate declined 15.2%, the largest one-year decline in more than a decade. From 1993 to 1997, the juvenile murder arrest rate dropped 22.8%². In Boston, from July of 1995 to September of 1998, there was not one homicide by gunfire reported for youths under the age of 17. This is in contrast to the ten deaths by gunshot wound reported in Boston in 1990 alone³.

A renewed concern for youth safety and aggressive enforcement and prevention oriented initiatives have been cited as a major reason for the recent success in Boston. One such initiative is the Boston Gun Project, a component of the "Operation Ceasefire" strategy

¹ NCJRS, 1996

² NCJRS, 1996

which enforces “zero tolerance” for violence in city neighborhoods. The Boston Gun Project targets the illegal firearms supplied to juveniles by removing firearms from the community and using ATF tracing to identify suppliers of illegal firearms to youths and felons.

Are these programs actually a cause of the lowered homicide rates and, more importantly, can these sanguine results be sustained in the long run?

1.2 Motivation and Goal

The standard approaches to determine the effectiveness of strategies designed to combat juvenile homicides have inevitably been limited. A lack of understanding and preparation for the unexpected consequences, both good and bad, of any policy can hamper its success. This is even more problematic when real lives and limited resources are at stake.

The obvious drawback to the experimental method of testing policies is the risk involved. Because the interplay of forces leading to the perpetuation of the ghetto is so dynamically complex, it becomes virtually impossible for any one person or group of persons to mentally keep track of all the possible implications of a potential policy. This is especially true when many of these consequences might not appear until several years down the line.

Yet the difficulty of thoroughly understanding the system is not a sufficient excuse for ignoring it. A failed experimental program can be costly for those involved, for those funding the project, and for those attempting to encourage general efforts overall. It can

³ Nifong, 1997

lead many otherwise enthusiastic supporters of a slightly misguided but potentially effective policy to abandon the cause as hopeless altogether.

The methods of system dynamics address this issue directly by providing interested parties the opportunity to test single or multiple policies in a computer simulated environment, and to explore each policy's potential consequences on the homicide rates of youths as well as on other symbols of the ghetto environment. It also forces those persons involved in the formulation of the model to clarify and formalize their understanding of the causal structures leading to certain ghetto pathologies such as high homicide rates.

2.0 Background

The homicide rate of inner city youths has risen dramatically over the past twenty years. Homicide is the leading cause of death of young black males and the second or third leading cause of death of young white males. Half of all the victims of homicide are African-American, although blacks constitute only 12% of the American population.⁴

Only since 1993 have the national statistics begun to decline.

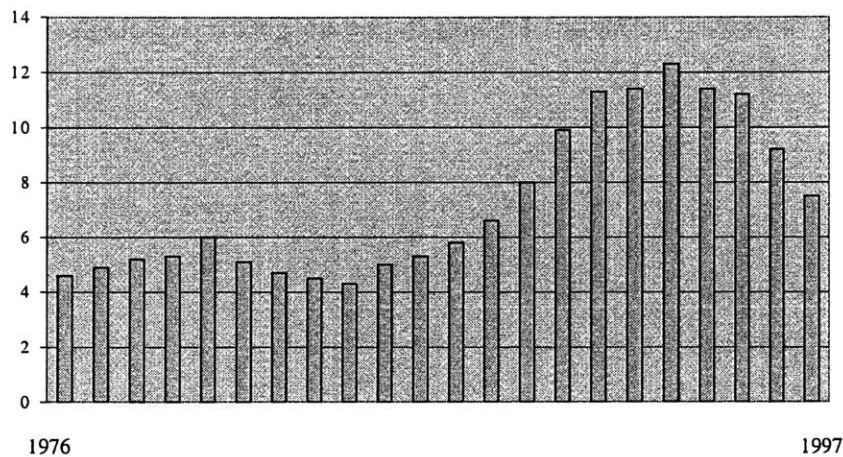

Figure 1: Homicide Victimization Rates per 100,000 Youths ages 14-17⁵

But even with the recent decline in homicide rates nationally, many major cities have experienced anomalous behavioral trends. **Figure 2** shows that New Orleans' general homicide rates continue to skyrocket while Miami's remains relatively stable. Variations in socioeconomic conditions and local criminal policies certainly account for some of the differences. Do legislative programs account for some of the rest of the difference?

⁴ Prothrow-Stith, 199, p. 3

⁵ U.S. Department of Justice, BJS 1998

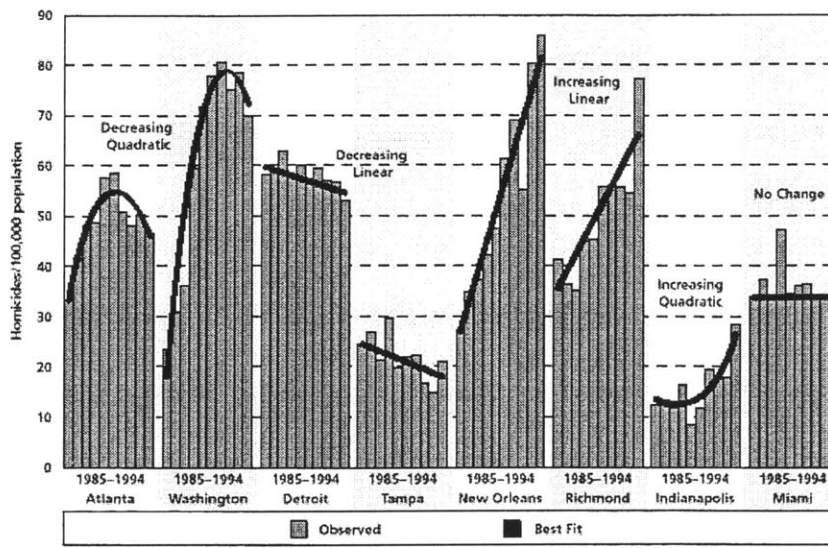

Figure 2: Annual Homicide Rates for Selected Cities, 1985-1994⁶

Boston has been lauded for its efforts in fighting juvenile crime and delinquency. For these efforts, in 1997, the U.S. Justice Department selected Boston as one of five cities nationwide to serve as models for juvenile crime-fighting programs. At the time, the proof of Boston’s success was the startlingly persuasive statistic that no one under the age of 17 had been killed by gunfire since July of 1995. This achievement was then sustained until the fall of 1998.⁷ This is in contrast to the ten juveniles who died in 1990 in Boston of gunshot wounds. Among Boston’s initiatives were programs targeting at-risk youths, cracking down on gun sales to juveniles, and building stronger working relationships between juvenile handling agencies and local police.

2.1 Boston Gun Project

The Boston Gun Project is one component of the “Operation Cease Fire” strategy in the Roxbury, Dorchester, Mattapan, and South End areas of Boston. The Boston Gun Project

⁶ U.S. Department of Justice, NIJ, 1997, p. 3

⁷ NCJRS, 1996

emphasizes cooperation among law enforcement parties to target suppliers of guns involved in crimes. The agencies involved are the Boston Police Department, the Suffolk County District Attorney's Office, the U.S. Attorney's Office, ATF, and researchers at the Kennedy School of Government at Harvard University.

The project aims to crack down on suppliers of guns to juveniles and felons. Data show that 41.7% of guns used in crimes by juveniles are acquired in-state while 29.0% are acquired out-of-state.⁸ Therefore, while it does aim to stem the flow of handguns into Massachusetts, it more particularly focuses on the local illegal markets.

Using ATF tracing data sets, the Boston Gun Project attempts to disrupt illegal local gun markets. ATF attempts to trace every gun recovered by the Boston Police Department through ATF's National Tracing Center to identify sources of illegal weapons and gun-trafficking patterns. BPD and ATF also conduct joint inspections of all federally licensed firearm dealers in Boston, checking to ensure that they are in compliance with Federal, State, and local laws and regulations. Since the program began in 1994, 65 license holders (80%) decided not to renew their licenses or to surrender them, leaving only 17 licensed dealers in Boston⁹. Combined with gun buy-back programs, the aim is to reduce the availability of firearms to juveniles. Based on the success of the BGP, ATF then used it as a model to launch the Youth Crime Gun Interdiction Initiative in 17 cities nationwide in 1996.

⁸ U.S. Department of the Treasury, ATF, 1999

⁹ U.S. Department of Justice, OJJDP, 1998

2.2 Related Policy Research

Early studies of ghettos attempt to explain the transformation of urban minority neighborhoods into physical and institutional slums. Osofsky, (1966) in his study of Harlem, and Spear, (1967) in his look on Chicago discuss the economic and social motivation for the formation of racially homogeneous communities in the late 1800s and early 1900s. They both emphasize that these neighborhoods tended to begin as affluent residential minority communities. They were characterized by distinct physical boundaries as well as institutionalized social boundaries. Institutional boundaries refer to segregated political, social, community, and secular organizations, as well as institutional and business enterprises. The physical boundaries were drawn as a response to out-group racism - hostility generated by the more powerful, predominantly white majority. But the institutionalized boundaries were primarily encouraged by in-group leaders who believed in Booker T. Washington's doctrine that self-help¹⁰ would lead to improved political, economic, and social conditions.¹¹

The turning point for many of these minority inner-city communities occurred in the 1920s. The post WWI era saw a massive flux of African-Americans from the South to the urban North. Although by this time the ghettos were already fully formed, the unceasing migration of poor southern blacks seeking jobs in urban centers strained the capacity of the minority organizations beyond all reasonable bounds. Racism kept these blacks within the growing boundaries of the high-rent ghettos. But the institutions within the ghettos did not have the capability to house, care for, and employ the rapidly growing numbers.

¹⁰ Washington, 1988

¹¹ Spear, 1967, p. 111

However, even during this period, the ghetto communities were considered safe areas to visit by both in and out-group members. By the 1950s, these conditions had changed. The problems of unemployment and poverty quickly transformed and crystallized into additional problems of social neglect and decay. Ghettos became typified by high rates of unwed teen pregnancies, school drop-outs, drug use, fear, and violence.

Within the past two decades, Wilson (1978, 1987) has focused attention on the underclass group he terms the ghetto-poor to capture their economic, social, and environmental marginality. He declares that the conditions within ghettos are still continuing to decline. The position of the underclass has been deteriorating as compared to the improving conditions of the black middle class which has successfully been fleeing inner city neighborhoods. As the most economically disadvantaged are being abandoned in the most neglected communities, their positions are deteriorating at an increasingly distressing rate. For this reason, there has been a dramatic worsening of conditions in the ghettos from the 1950's to the present. The causal links of these worsened conditions to the history of slavery are not a sufficient explanation. Characteristic ghetto problems such as single parenthood, disproportionate non-marital status, and high crime rates arose largely in the late 20th century. Wilson cites the major out-migration of the older, wealthier classes from the urban black areas as the cause of the degradation.

He also refutes Murray (1984) who attributes the condition of the ghetto-poor to cultural differences and social policies such as the Great Society. Murray claims that the increasing rates of joblessness, crime, out-of-wedlock births, female-headed families, and welfare dependency are a result of the changed rewards and penalties governing human behavior created by such social-welfare programs.

Segregation as a reason for the perpetuation of the ghetto had been set aside for a number of decades. Massey (1993) brings the issue of racism back to the table. His main goal is to refocus the discussion on segregation, a word that he claims has disappeared from the American vocabulary since the 1960's. He cites racial segregation as an important and relevant source of many of the problems plaguing inner city ghettos.

Segregation may or may not be a problem in itself, but it is a problem for African-Americans due to the degree of forced racial isolation that it achieves. It allows the dominant group to penalize and exploit isolated minority groups without repercussion to the greater society. When black poverty rates rise in a totally segregated city, the drop in income is confined to neighborhoods inhabited exclusively by blacks, and primarily by poor blacks. It "ignites a cycle of escalating crime and disorder in the residential environment of poor blacks."¹² Although racially homogeneous neighborhoods are more able to elect representatives to legislation, it is more difficult for these legislators to form coalitions with others while in office due to a lack of common interests and goals.

Prothrow-Stith (1991) refocuses the problems of disadvantaged neighborhoods on their manifestations in adolescent violence. As a physician and public health official, she takes the stance that youth violence prevention is a valid standard health issue, on par with awareness campaigns on the hazards of smoking. Adolescents who grow up in ghetto neighborhoods are not only disadvantaged by restricted opportunities but also by the behavior of other poor individuals suffering from the same constraints. In these neighborhoods, adolescents are more likely to see violence as a way of life. Many are

¹² Massey, 1993, p. 137-139

never taught how to control aggression. Changing the climate of violence requires a wide array of techniques and strategies for teaching kids to cope with anger.

In a more recent study, Zimring (1997) states that people do not fear crime in general. They fear lethal violence. To focus on eradicating crime is to spread resources and efforts over too large a range of issues. Lethal violence is a problem separate and distinct from general crime rates. This is demonstrated by the similar crime rates in most developed nations and the 4-18 times greater lethal violence rates in America.¹³ Changes in the levels of property crime do not appear to be an important cause of homicides. In other words, “crime is not an inherent threat to public safety.”¹⁴

There is no single cause for lethal violence and causes for general crime may not be the same as those for homicides. Addressing prevention of homicides is not necessarily the same as addressing the causes of violence in general.

In this way, Zimring refocuses attention away from searching for the causes of general crime to the problem of searching for proximate causes of lethal crime. From this vantage, the presence of guns assumes a huge importance, the impact of the mass media is not very substantial, and lethal violence is not an inevitable element of an illegal drug market.

Patterns of gun use contribute to the explanation for the high death rates from American violence. Guns increase death rates due to the greater injurious impact of bullets, the longer range of firearms, and the greater capacity of firearms for executing multiple

¹³ Zimring, 1997, p. 3-20

¹⁴ Zimring, 1997, p. 33

attacks. There is the felt need to use more lethal instruments of assault than one's adversaries. There is also the increased willingness to use guns and other lethal weapons in personal conflicts due to the prevalence of such weapons. In addition, there is an increase in the number of people who would normally not carry a firearm but who choose to out of fear of being victimized in an attempted assaults by an armed assailant.

The conclusion is that "current evidence suggests that a combination of the ready availability of guns and the willingness to use maximum force in interpersonal conflict is the most important single contribution to the high U.S. death rate from violence. Our rate of assault is not exceptional; our death rate from assault is exceptional."¹⁵

2.3 Related System Dynamics Work

The dynamics of urban-related systems have previously been analyzed using the system dynamics methodology. Forrester (1969) in his system dynamics classic, Urban Dynamics, captures the decay of housing in urban environments. He concludes that the then highly popular policy of providing low-income housing to compensate for inner-city poverty is in fact detrimental to the improvement of urban areas. It uses valuable space that could otherwise be used as sites for businesses. These businesses would likely employ local residents. Instead, low-income housing projects attract low-wage and unemployed workers who are then not financially able to support and improve the community.

Homer (1979) expands on this work by examining how the physical, economic, and social aspects of a suburban community work together to create sometimes self-

sustaining, rapid transitions in the conditions of a community. He explores how a home insurance company might deal with the transitions that can produce losses. The model is parameterized to represent Melrose, MA, north of Boston. He concludes that a home insurance company is generally not positioned to have a high-leverage influence on the quality of a neighborhood community.

Like the Urban Dynamics model, Homer's insurance model divides the population into three levels: upper-class, middle-class, and lower-class. Although Homer does not employ inter-class movement, there is migration into and out of the community. Migration is influenced by the quality of the neighborhood, which in turn is a measure of the available community services and stability.

[Hirsch, Levin, and Roberts, 1975] focus on the system of forces that lead to the growth of heroin use in urban environments. They analyze the socioeconomic causes of addiction as well as a variety of corrective strategies for combating the growth of addiction. Their model is parameterized to reflect their research in the Sound View-Throg's Neck section of Bronx in New York.

The heroin model is divided into 10 sectors. The User and Addict sectors track the conversion and migration of soft-drug users and addicts. The Community Response and Change sectors track the crime rates and determine their effects on the community's socioeconomic level and response efforts. A variety of program sectors capture the dynamics of addicts moving through incarceration, maintenance programs, and detoxification programs. The Cost sector tabulates the various costs of these programs.

¹⁵ Zimring, 1997, p. 123

3.0 HOMICIDE Model

3.1 Introduction to the Model

The HOMICIDE model can be used to analyze the internal dynamics of an inner city juvenile population and how juvenile homicide rates affect and are affected by the prevalence of handguns within the community. (See **Appendix A** for complete technical documentation.)

The social and economic conditions of the community studied are assumed to be constant within the time bounds of the model runs. The conditions are calibrated to represent an inner city community with limited opportunities, commonly typified by high rates of unemployment, poverty, poor schools, unwed mothers, few role models, etc. The appropriate social and economic levels as dictated by the current rate of homicides is tracked for the purpose of determining both the attractiveness of the community and the pressure to acquire a handgun.

The population is restricted to youths from the ages of 14-17. Although the term “youths” commonly refers to anyone under the age of 21, for the purpose of this study the terms “youths,” “adolescents,” and “juveniles” will be used interchangeably to describe youths from the ages of 14-17 only.

The population is subdivided by participation in recent criminal activity. It is not subdivided by sex, class, race, or age.

Approximately 70% of all homicides in the U.S. occur by gun wound. Within this portion, 75% are by handguns¹⁶. The HOMICIDE model tracks only homicides by handgun which occur within the population being studied. It is certainly plausible that the rate of homicides by other means can influence the rate of homicides by handgun, but this dynamic is outside the scope of this model.

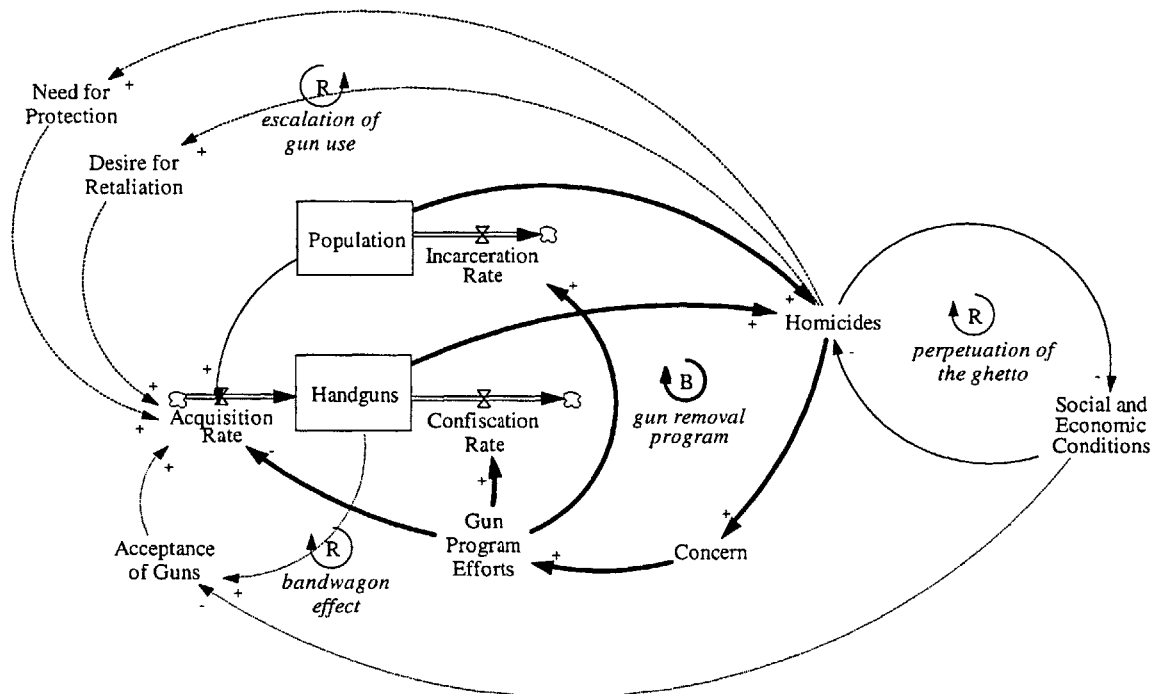

Figure 3: Basic Dynamics

The basic dynamics of the HOMICIDE model are shown in **Figure 3**. High homicide rates reduce the attractiveness of the neighborhood, contributing to the poor socioeconomic level of the community. As the social and economic infrastructures within the community decline, the lack of appropriate guidance, employment, and education of youths contribute to a further increase in the homicide rate. This leads to a

¹⁶ Zimring, 1997 p. 25-29

reinforcement and perpetuation of both the physical and institutional ghetto social structures. This is captured by the *perpetuation of the ghetto* loop.

The lack of appropriate social guidance combined with the prevalence of guns within the community contribute to making handgun possession both acceptable and “cool.” The greater presence that guns have within the community, the more pressure there is for youths to join their friends in owning a gun. This is displayed in the *bandwagon effect* loops.

The high homicide rate leads to both an increase in retaliation of wrongs committed and a general decline of safety within the community. The *escalation of gun use* loops explain the increasing rate of gun acquisition in order to meet the greater needs of the community.

Concern stemming from the rate of youth homicides leads public officials to implement initiatives such as the Boston Gun Project. These types of gun supply reduction initiatives may focus efforts in three directions. ATF traces are used to identify suppliers of illegal guns to youths and felons. The ATF trace information is used to disrupt the illegal market and stymie the flow of guns into the community. Buy-back programs can also reduce the distribution of guns throughout the community by encouraging community members to give up old, idle, or secondary firearms. Finally, police officials may target the most violent and influential youth criminals for removal from the streets. The removal of violent youth leaders has a tendency to disrupt and disband youth gangs. These dynamics are captured by the *gun removal program* loops.

3.2 Population Sector

Figure 4 shows the basic structure of the population. There are three levels within the population sector: *At-Risk Juveniles*, *Minor Criminals*, and *Major Criminals*. *At-Risk Juveniles* consist of all 14-17 year olds within the community being studied who do not participate in criminal activities.

All three population levels are changed by aging-out rates and migration rates. In addition, the *At-Risk Juveniles* level is increased by the rate of growth of the population. I have assumed for simplicity that all youths aging into the population enter through the *At-Risk Juveniles* stock, even though a small fraction does enter directly into the *Minor* and *Major Criminals* stocks.

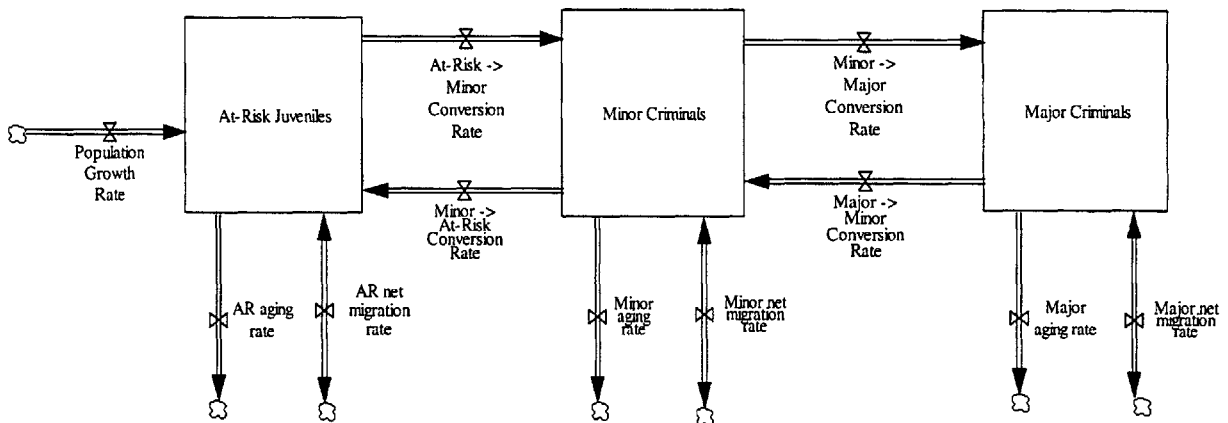

Figure 4: Population Sector

The stock of *Major Criminals* consists of those youths who have been involved in a homicidal incident or have committed at least one major crime recently. The stock of *Minor Criminals* consists of the group of youths who have been involved in petty crimes such as shoplifting, delinquency, soft-drug possession, etc. within the past few years or who have been involved in a major crime more than two years previously. The group of *At-Risk Juveniles* includes all other youths within the community. On average, the entire

population of youths is assumed to be homogeneous, therefore every youth is equally likely to eventually flow around the chain of levels.

The distinction between the stocks of people in the total youth population is made for the reason that the three types of youths have different probabilities of becoming involved in a situation in which a homicide might result. More than 50% of homicides are non-criminal,¹⁷ meaning between family and friends. Heated altercations in the presence of nearby firearms can lead to deadly situations. Therefore all youths have a minimal chance of becoming involved in a homicide. Although all youths within the community are subject to the same social and economic conditions, those youths who have been previously involved in a homicidal incident are much more likely to be involved in another one. You can imagine the scenario in which Youth A has been involved in a gang fight between gangs A and B in which a member of gang B has been killed. Youth A, now aware that his/her own life is jeopardized, protects him/herself by carrying a 0.28 caliber semiautomatic. When Youth B eventually encounters Youth A, both pull out their weapons and the probability of death is much higher than otherwise. Therefore, the stock of *Major Criminals* has a higher probability of killing or being killed than *Minor Criminals* who then have a higher probability of killing or being killed than *At-Risk Juveniles*.

The conversion rates between population stocks are first order control flows. **Figure 5** shows the structure for the flow from the *At-Risk Juvenile* stock to the *Minor Criminal* stock. Given that the population is homogeneous and well-mixed, all youths are equally likely to convert from the stock, *At-Risk Juvenile*, to the stock, *Minor Criminal*. Despite

this, all youths do not eventually convert to the *Minor Criminal* stock. A portion of the youths either age-out or migrate before they have the opportunity to commit a minor crime. The average length of time during which a youth resides in the *At-Risk Youth* stock given that he/she does not age-out or migrate is determined by the *Average Time to Convert to Minor Criminal*. The conversion rates from *Minor Criminal* to *Major Criminal*, from *Major Criminal* to *Minor Criminal*, and from *Minor Criminal* to *At-Risk Juvenile* are determined in similar fashion.

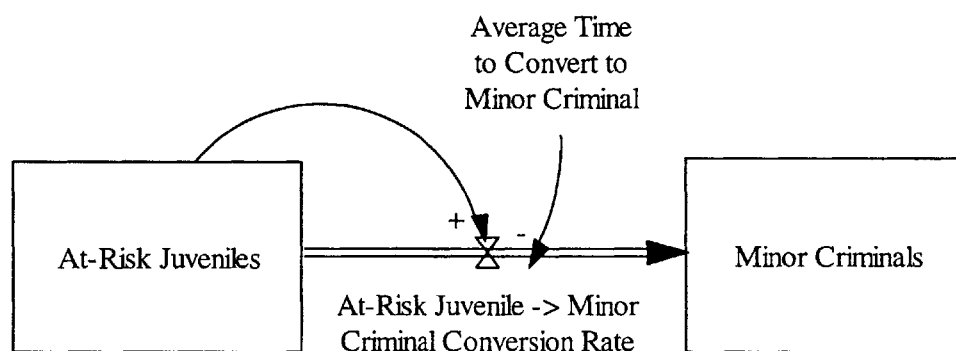

$$\text{"At-Risk Juvenile -> Minor Criminal Conversion Rate"} = \text{At-Risk Juvenile} / \text{Average Time to Convert to Minor Criminal}$$

Figure 5: Population Conversion Rate Formulation

3.3 Handguns Sector

The only guns in this model are handguns such as pistols and semiautomatics. 70% of homicides are committed by firearms, and 75% of these are committed using a handgun. But handguns only represent one-third of the present 50 million guns in circulation nationwide.¹⁸ Although other firearms and weapons present a significant threat as well, handguns pose a far greater proportional threat to safety. For this reason, this study is restricted to tracking handguns only.

¹⁷ Prothrow-Stith, p. 21-23

¹⁸ Prothrow-Stith, p. 17-20

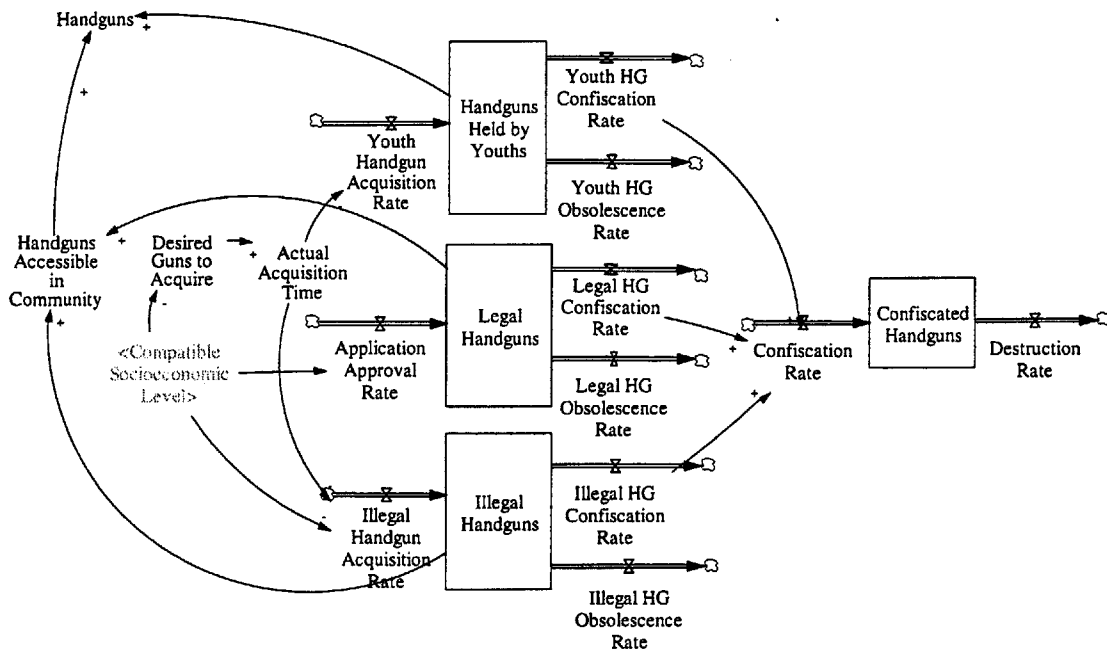

Figure 6: Handguns Sector

The pool of handguns is subdivided into four levels: *Handguns held by Youths*, *Legal Handguns*, *Illegal Handguns*, and *Confiscated Handguns*. The first three levels are increased to match a desired level dictated by the indicated socioeconomic level compatible with the current homicide rate. The time it takes to illegally acquire a handgun is increased by the efforts of gun programs and reduced by larger supplies in the illegal market. The three levels are decreased by the inevitable obsolescence of handguns from aging, breakage, and loss. They are also decreased through routine confiscation by police drug busts, presence on crime scenes, etc. Confiscated handguns can eventually reenter the stocks of possessed guns through theft and reselling to the community. *Handguns held by Youths* are all handguns illegally acquired and owned by juveniles. *Legal Handguns* are those handguns legally possessed by adults within the community

and purchased in agreement with federal, state, and local legislation. *Illegal Handguns* are the handguns illegally possessed and acquired by adults, often by felons.

Handguns totals the number of handguns presently in the possession of youths in addition to the fraction of guns in the general community to which they have ready access.

Confiscated Handguns represent those guns seized by police either through normal police activity or through the direct efforts of repurchase programs. It is increased by confiscation rates from the three stocks of possessed handguns and decreased by theft, resells to the public, or mass destruction.

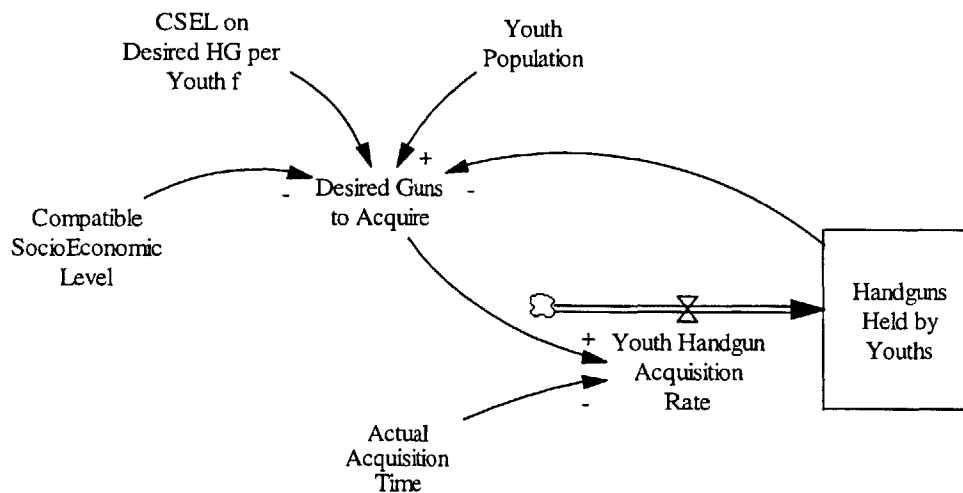

$$\text{Desired Guns to Acquire} = \text{Youth Population} * \text{CSEL on Desired HG Per Youth } f(\text{Compatible SEL}) - \text{Handguns held by Youths}$$

$$\text{Youth Handgun Acquisition Rate} = \text{MAX}(0, \text{Desired Guns to Acquire} / \text{Actual Acquisition Time})$$

Figure 7: Handgun Acquisition Rate Formulation

The *Compatible SocioEconomic Level* measures the social and economic conditions of the community based on the *SocioEconomic Level* and the current homicide rate. It is the *Compatible SocioEconomic Level* that determines the desired ratio of guns to youths. This relationship is given by the *CSEL on Desired HG per Youth f*. As the *Compatible*

SocioEconomic Level falls, the desired ratio of guns to youths increases exponentially. Youths then purchase illegal guns at a rate to bring the actual number of *Handguns held by Youths* in line with the desired number of guns.

3.4 Homicides Sector

The homicides studied are restricted to those committed by handgun strictly between two juveniles. Gang warfare is not within the boundary of the model, except at the micro-level where one individual points a weapon at another individual.

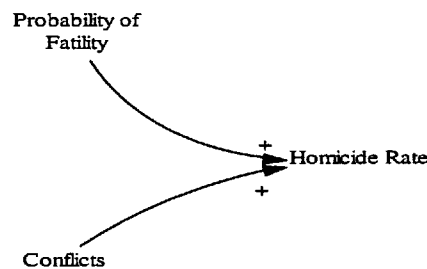

$$\text{Homicide Rate} = \text{Conflicts} * \text{Probability of Fatality}$$

Figure 8: Homicides Sector

The *Homicide Rate* is a factor of the rate at which members of the population are involved in potentially lethal conflicts and the probability that conflicts actualizes into homicides.

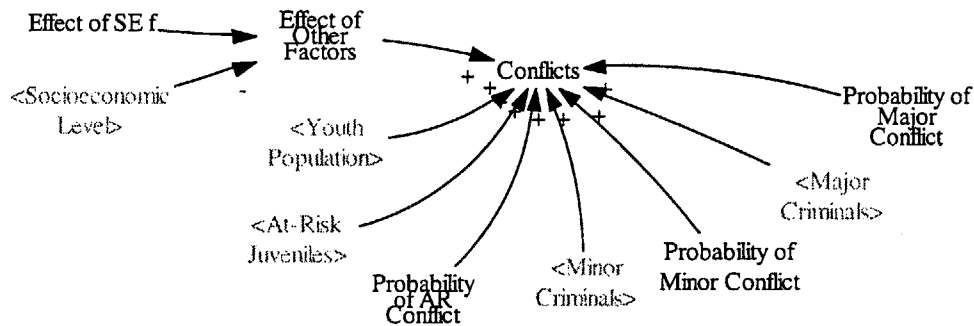
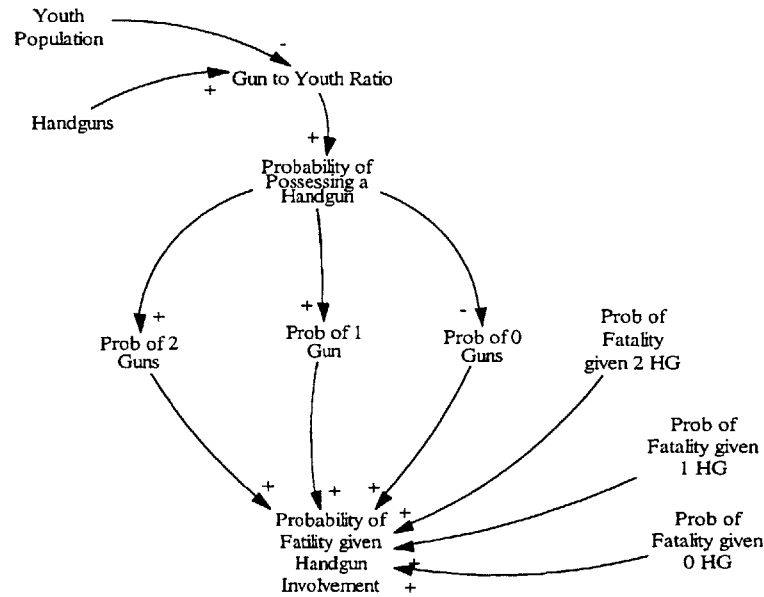

Figure 9: Conflicts Formulation

The conflict rate is a weighted sum of the rates of involvement in conflicts of each type of youth in the community by each type's proportional presence in the youth population.



$$\text{Prob of 2 Guns} = \text{Probability of Possessing a Handgun} * \text{Probability of Possessing a Handgun}$$

$$\text{Prob of 1 Gun} = \text{Probability of Possessing a Handgun} * (1 - \text{Probability of Possessing a Handgun}) + \text{Probability of Possessing a Handgun} * (1 - \text{Probability of Possessing a Handgun})$$

$$\text{Prob of 0 Guns} = (1 - \text{Probability of Possessing a Handgun}) * (1 - \text{Probability of Possessing a Handgun})$$

$$\text{Probability of Fatality given Handgun Involvement} = (\text{Prob of Fatality given 2 HG} * \text{Prob of 2 Guns}) + (\text{Prob of Fatality given 1 HG} * \text{Prob of 1 Gun}) + (\text{Prob of Fatality given 0 HG} * \text{Prob of 0 Guns})$$

Figure 10: Fatality Probability Formulation

The probability of fatality is a weighted sum of the probabilities of possession of exactly zero, one, or two guns amongst two participants in a conflict. It is assumed that the presence of more than two guns does not significantly increase the likelihood of death. The probabilities that there are exactly zero, one or two guns involved in an incident are joint probabilities of independent, identically distributed events.

3.5 Gun Project Sector

The gun project within the model may be activated using the *Gun X* switch to represent legislative approval or disapproval of budgetary funds towards these types of programs.

The amount of effort put into the project, once implemented, is dependent on the weighted sum of two types of concern, as shown in **Figure 11**. The first type of concern is that toward current levels of homicide rates. The second type of concern is towards the trend in homicide rates over the previous two years. Therefore if homicide rates are high, then regardless of the general trend in homicides, concern will push for the success of the program. But if current homicide rates are low, then only an upward trend in homicides will cause concern to jump up again.

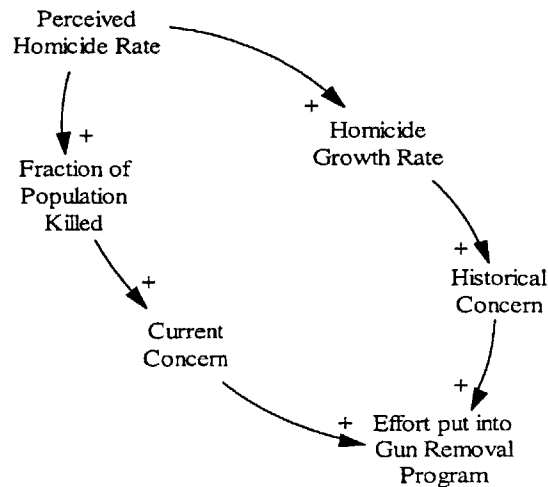

$$\text{Effort put into Gun Removal Project} = \text{SMOOTH}(\text{Gun X} * (0.8 * \text{Current Concern} + 0.2 * \text{Historical Concern}), 0.25, 0)$$

Figure 11: Effort Formulation

Figure 11 shows the program’s three main implementation focuses. The first is to remove excess guns from the community. Buy-back programs allow citizens to sell back used firearms to local officials for small monetary amounts. This encourages people to

give up old, idle, or secondary weapons. The process reduces the number of guns that juveniles might come across in their homes and the homes of friends and neighbors. It is captured by an increase in the confiscation rates of handguns, the magnitude of which is dependent on the level of concern within the community. Confiscated guns may return to the community through thefts or reselling to the public, if permitted.

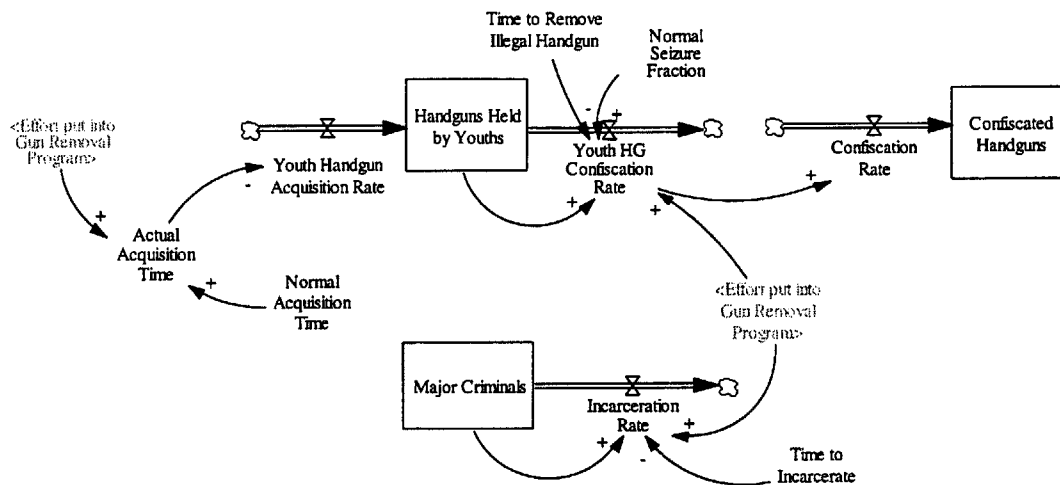

$$\text{Actual Acquisition Time} = \text{Normal Acquisition Time} * (1 + \text{Effort put into Gun Removal Program})$$

$$\text{Youth HG Confiscation Rate} = \text{Handguns Held by Youths} * (\text{Normal Seizure Fraction} + (1/\text{Time to Remove Illegal Handgun}) * \text{Effort put into Gun Removal Program})$$

$$\text{Incarceration Rate} = (\text{Major Criminals}/\text{Time to Incarcerate}) * \text{Effort put into Gun Removal Program}$$

Figure 12: Gun Project Sector

The second focus of the project is to hinder the handgun acquisition process by disrupting the illegal gun market. Studies have shown that, contrary to common belief, the majority of crime guns used in Boston were probably illegally trafficked within state as opposed to having been brought in across state lines. The use of ATF traces allows police officials to locate the original seller and purchaser of many guns used in crimes in the hopes of increasing enforcement efforts directed against those who supply or traffic illegal

firearms to youths. This is captured in the relative increase in the time to acquire an illegal handgun due to program efforts.

The third focus of the project involves the identification and strategic removal of the most dangerous juvenile gang and drug offenders from the streets. Deprived of their most dangerous and influential leaders, gangs have a tendency to fall apart and become less lethal. This is captured by the *Incarceration Rate* reducing the *Major Criminals* stock.

4.0 Policy Experiments and Recommendations

4.1 Base Run Description

The base case is parameterized to represent the scenario in which high homicide rates generate no efforts specifically aimed at reducing the supply of illegal guns. A minimal number of guns are confiscated and subsequently destroyed each year through routine busts and criminal investigations. None of these confiscated guns reenter the public domain either through theft or reselling. The socioeconomic conditions and attractiveness of the community do not vary over time. The population grows at a rate to keep the total population constant despite aging. The simulation begins in 1985 with a total population of 101,059 youths, including 27,190 minor criminals and 7,250 major criminals.

The result is that the juvenile homicide rate from handgun wound is constant over time between 21-22 deaths per year. Concern remains stable but unfocused.

4.2 Program Implementation

If concern over the youth homicide problem grows, the community may choose to implement an initiative based on the Boston Gun Project model. Such an initiative has three main emphases:

- 1) Gun owners may be persuaded to remove excess guns from the community by monetary incentive based gun buy-back programs.
- 2) A growth of the gun supply may be prevented by enforced reduction of the illegal gun market.
- 3) Criminals may be forcefully removed from the community.

Handguns

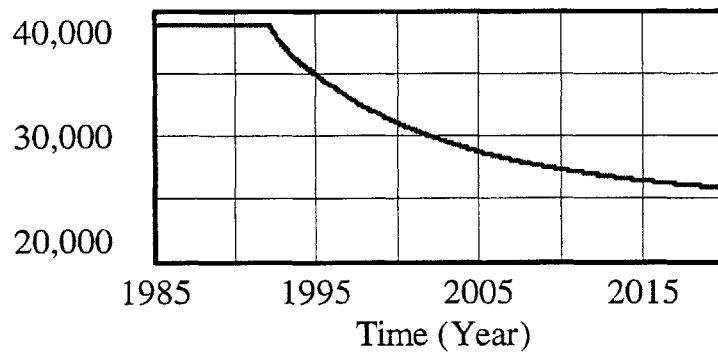

Handguns : program 1992 — guns

Homicide Rate

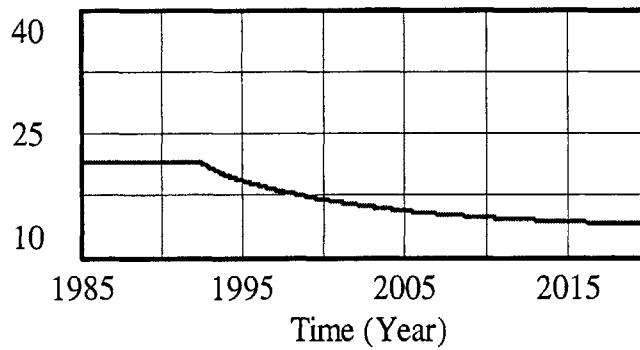

Homicide Rate — people/Year

	1985	1995	2005	2015	% reduction from 1985 - 2015
Handgun Stock	38,911	34,867	28,763	26,451	32%
Homicide Rate	21.59	19.11	15.59	14.30	33.8%

Figure 13: Results of Program Implementation

The activation of the *gun removal program* loops slows the growth of the *escalation of gun use* and *bandwagon effect* loops and provides them with an artificially enforced lower limit (see **Figure 3**).

Figure 13 shows that the result of implementing the program within the HOMICIDE model in the year 1992 is the anticipated drop in both the stock of handguns and the rate of youth homicide.

The base parameters of the model with the gun program activated are as follows:

Probability of Removal of Illegal Handgun = 0.2/year

Probability of Removal of Legal Handgun = 0.1/year

Time to Incarcerate = 25 years

Actual Acquisition Time = Normal Acquisition Time * (1+Program Effort)

Average Time to Theft = N/A

Average Time to Resell = N/A

The youth homicide rate is reduced by 33.8% from 21.59 deaths per year in 1985 to 14.30 deaths per year in 2015. The stock of handguns including those owned illegally by youths and those owned by adults but accessible to youths drops by 32% from 38,911 guns in 1985 to 26,451 guns in 2015.

Both the homicide rate and the stock of handguns settle at non-trivial equilibrium values. The stock of handguns is never completely eliminated. As guns become scarcer it becomes increasingly more difficult with the same incentives to entice the remaining owners to give up their guns. As long as handguns remain within the community, the probability that a handgun will be involved in a conflict will be some positive value and homicides by gun wound will persist. The percentage reduction in the homicide rate is

greater than the percentage reduction in the stock of handguns for two reasons. The first reason involves the probabilities of fatality. Although the probability of involvement in a conflict with two guns is less than half the probability of involvement in a conflict with one gun, the probability of fatality given the presence of two handguns is one order of magnitude greater than either the probabilities of fatality given one or zero guns. Thus, reductions in the probability of multiple guns result in amplified reductions in the fatality rate.

The second reason is that the gun program specifically targets the incarceration of major juvenile criminals. Major criminals are more frequently involved in potentially dangerous conflicts. Reducing their numbers results in amplified reductions of the overall number of potentially dangerous conflicts.

4.3 Sensitivity Tests

4.3.1 Gun Removal Probabilities

Results from varying the probabilities of successful handgun removal are shown in **Figure 14**. As the probability of convincing community members to sell back used guns is increased the effects on homicide rate reduction are also increased.

Increasing the confiscation rate by providing more attractive buy-back incentives reduces the stock of handguns. The decline in both gun and homicide levels allows for the de-escalation of gun use for purposes of retaliation and protection as well as the decline of their general acceptance. This reinforces the diminution of the gun levels via the reduced acquisition rate of new guns.

Graph for Handguns

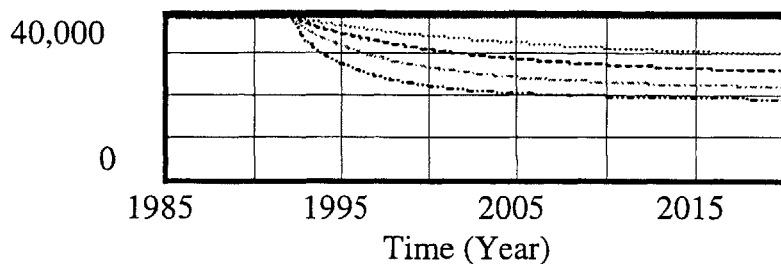

Handguns : none _____ guns
 Handguns : removal probability x 1/2 guns
 Handguns : program 1992 - - - - - guns
 Handguns : removal probability x 2 - - - - - guns
 Handguns : removal probability x 4 - - - - - guns

Graph for Homicide Rate

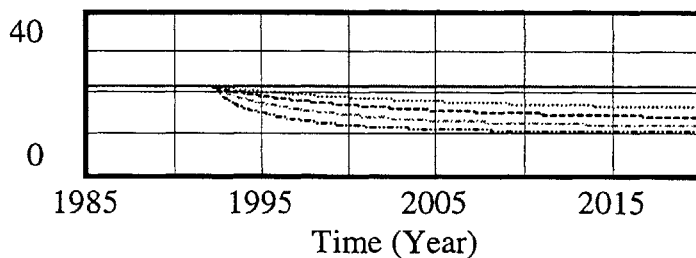

Homicide Rate : none _____ people/Year
 Homicide Rate : removal probability x 1/2 people/Year
 Homicide Rate : program 1992 - - - - - people/Year
 Homicide Rate : removal probability x 2 - - - - - people/Year
 Homicide Rate : removal probability x 4 - - - - - people/Year

% Reduction by year 2010

Removal Probability	No Program	x 1/2	Base	x 2	x 4
Handgun Stock	0%	19.4%	29.7%	40.5%	49.3%
Homicide Rate	0%	20.8%	31.4%	42.5%	51.3%

Figure 14: Gun Removal Time Sensitivity Tests

4.3.2 Incarceration Time

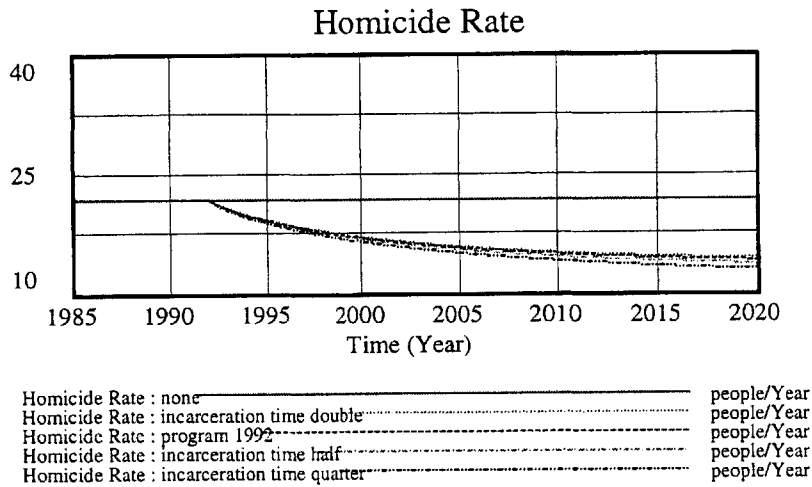
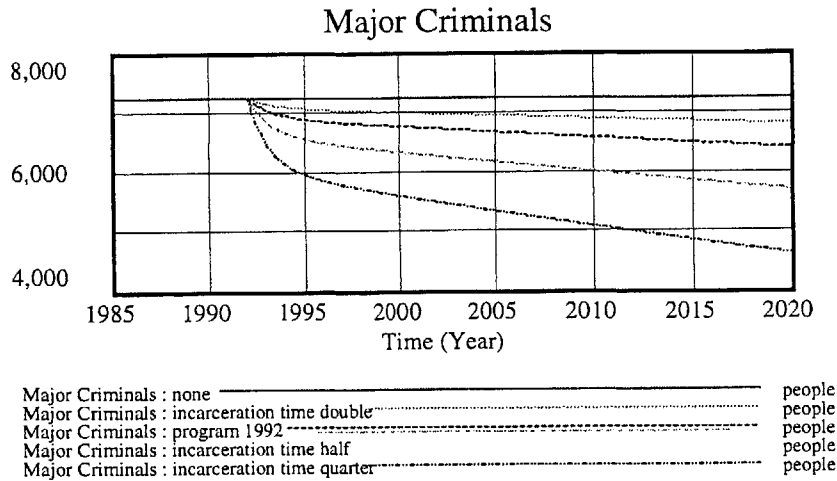

% Reduction by year 2010

Incarceration Time	No Program	x 2	Base	x 1/2	x 1/4
Major Criminals	0%	4.8%	9.3%	17.2%	29.9%
Homicide Rate	0%	30.7%	31.4%	32.9%	35.3%

Figure 15: Incarceration Time Sensitivity Tests

Sensitivity tests were run on the amount of emphasis placed on targeting and incarcerating influential juvenile criminals by varying the length of the *Time to Incarcerate* a major juvenile criminal. **Figure 15** shows that increased emphasis on forcefully removing juvenile criminals from the streets reduced their numbers but did not significantly impact the homicide rate.

Major Criminals are a relatively small portion of the total youth community, initially comprising 7.2% of the total *Youth Population*. Even a significant decrease in the number of youth criminals can only result in a small reduction of the total population. Both the total population and the gun distribution remain fairly constant. Even though the activities of youth criminals result in a disproportionate portion of community homicides, the reduction of their presence does not necessarily convert to a significant reduction of general violent criminal activity. Targeting *Major Criminals* is a low leverage point for achieving reduced homicide rates.

4.3.3 Acquisition Time Effects

Increasing the efforts on the illegal gun market also does not in general have a dramatic effect on the homicide rate. As the time to acquire an illegal gun grows, signifying increased police enforcement, the initial drop in the illegal handgun acquisition rate causes the desired number of guns to jump up. Given the increased demand in the market, there inevitably are people willing to supply the demand. This causes the acquisition rate to remain fairly stable in matching gun demand for reasonable enforcement effort levels.

Graph for Handguns

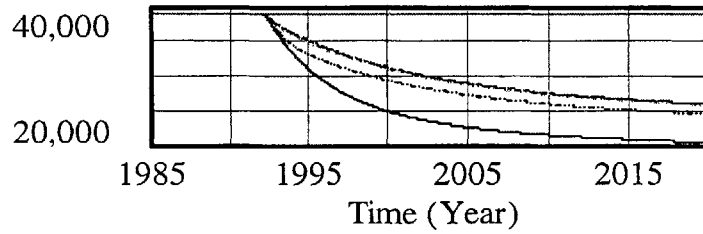

Handguns : none _____ guns
 Handguns : acquisition time effect p01 guns
 Handguns : acquisition time effect p1 - - - - - guns
 Handguns : program 1992 guns
 Handguns : acquisition time effect 10 guns
 Handguns : acquisition time effect 100 _____ guns

Graph for Homicide Rate

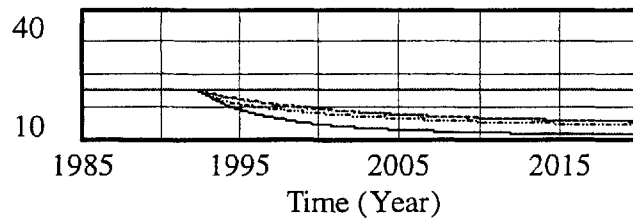

Homicide Rate : none _____ people/Year
 Homicide Rate : acquisition time effect p01 people/Year
 Homicide Rate : acquisition time effect p1 - - - - - people/Year
 Homicide Rate : program 1992 people/Year
 Homicide Rate : acquisition time effect 10 people/Year
 Homicide Rate : acquisition time effect 100 _____ people/Year

% Reduction by Year 2010

Acquisition Time Effect	No Program	x 1/100	x 1/10	Base	x 10	x 100
Handgun Stock	0%	29.2%	29.3%	29.7%	33.2%	44.8%
Homicide Rate	0%	30.9%	31.0%	31.4%	35.1%	46.8%

Figure 16: Illegal Acquisition Time Sensitivity Tests

As can be seen in **Figure 16**, in order to create a notable impact on homicide rates via handgun supply, it is necessary to increase the acquisition time to very long lengths on the order of several years.

4.3.4 SocioEconomic Level

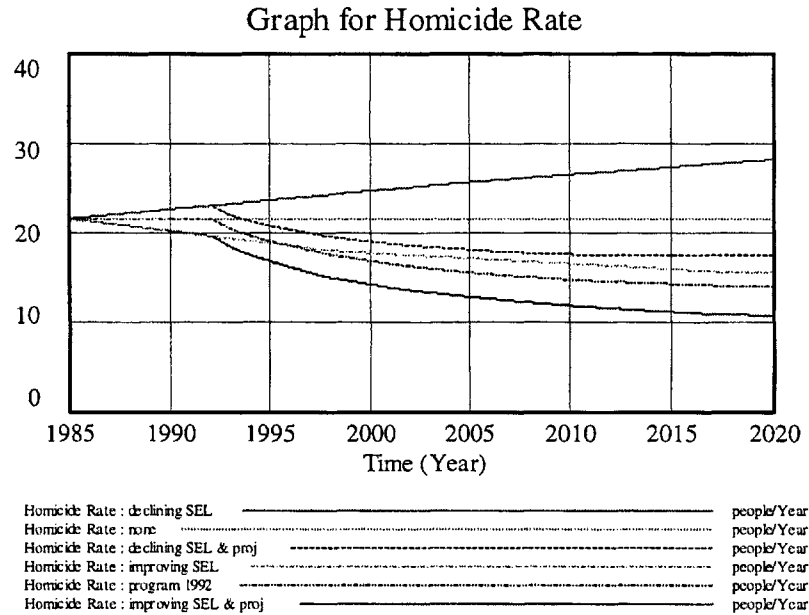

Homicide Rate in year 2010

	No Program	With Program	% Reduction
No Change in SEL	21.59	14.80	31.4%
Improving SEL	16.58	11.90	28.2%
Declining SEL	26.51	17.64	33.5%

Figure 17: SEL Sensitivity Tests

The previous analyses have been performed under the assumption that the socioeconomic condition of the community being studied is stable and unchanging over the time period being observed. I modified this assumption to observe the effectiveness of performing a gun-supply focused program on neighborhoods with declining or improving social and economic conditions.

The results are that these types of programs can be effective in either type of environment, but not to the same degree. **Figure 17** shows that in a community in which conditions are already improving, the program can help reduce the homicide rate another 28%. In a community in which the conditions are declining and homicide rates are rising, the implementation of such a program can reverse the trend and reduce the homicide rate by 34%.

Looking back at the basic dynamics of the community as presented in **Figure 3**, it is evident that when the *perpetuation of the ghetto* loop is working in an unfavorable direction, the gun program can assist in limiting the *escalation of gun use* and *bandwagon effect* loops. If social and economic conditions are poor and homicide rates are rising, concern builds and efforts to implement gun programs are more effective relative to in more prosperous communities.

4.4 Theft and Reselling

In an ideal world, guns, once confiscated from a community would remain removed and isolated from that community. In the real world, these guns often make their way back into the public domain either through the legal reselling of used guns or the illegal theft

and distribution of stolen used guns. For the previous analyses, it was assumed that confiscated guns were never stolen or resold.

Implementing a policy in which guns, whether confiscated through routine busts or specifically through buy-back programs, may be resold legally or illegally has very little effect on the homicide rate. These results can be seen in **Figure 18**. With the allowance of theft and reselling, the acquisition time is reduced but the desired rate of acquisition is not altered significantly.

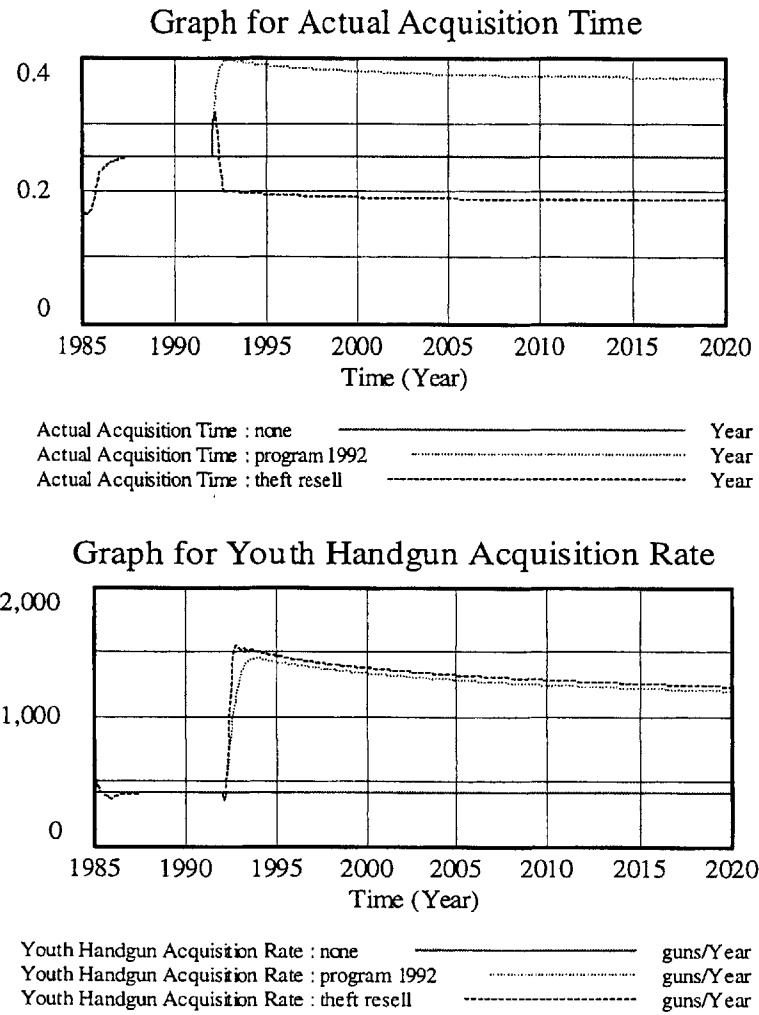

Figure 18: Presence of Theft and Reselling

The rate at which youths acquire guns is determined by the community's social and economic conditions as well as the effects of the current homicide rate on the general acceptance and need for guns. The mere presence of excess guns in the legal and illegal markets does not impact the acquisition rate in a way similar to that of limiting the gun supply.

4.5 Limited Resources

The limitation of available resources is an issue that cannot be ignored. With the success of any legislative program eventually comes the self-congratulatory feeling that the problem has been resolved and that the success will naturally be sustained. Attention soon turns to focus on other more pressing matters. The limited fiscal budget gets allocated elsewhere.

To represent this situation, I tested the effects of deactivating the gun program in the year 2000. **Figure 19** shows that over time the successes of the gun program are compromised by the lack of sustained interest and effort. The homicide rate slowly but eventually creeps back up to levels comparable to the pre-program period.

When the limit created by the *gun removal program* loops is relaxed, the reinforcing loops around the community acceptance and need for guns cause the handgun stocks and homicide rate to grow until they reach the next limit. Although this process is slow in the model, it can be speeded by changes in the socioeconomic conditions, injections of handguns into the community, and alterations in the distribution of youths throughout the community.

Graph for Handguns

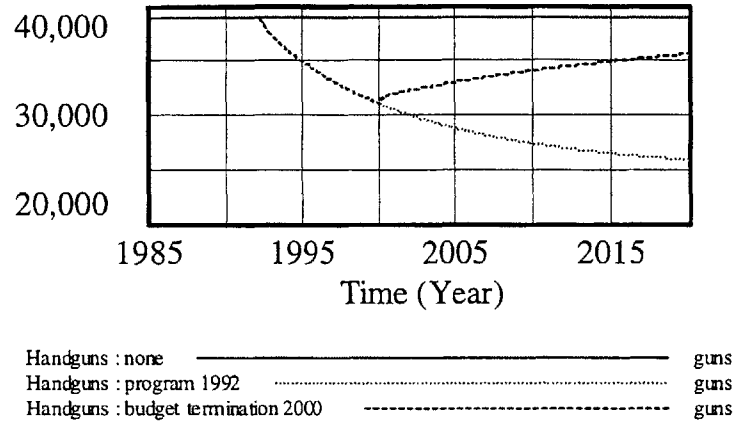

Graph for Homicide Rate

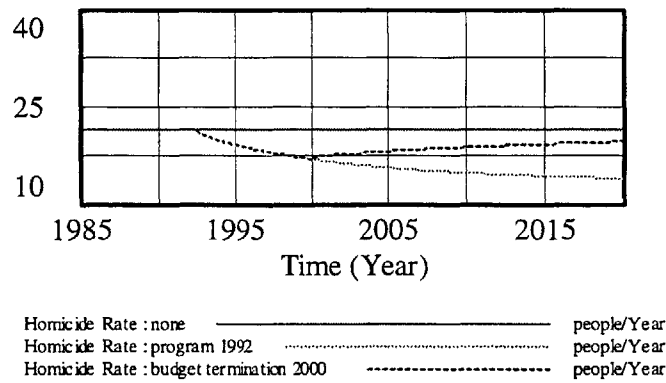

Handgun Level and Homicide Rate in year 2010

	No Program	Program	Program Terminated	% Reduction with Program	% Reduction with Termination
Handgun Stock	38,911	27,353	34,045	29.7%	12.5%
Homicide Rate	21.59	14.80	18.75	31.4%	13.2%

Figure 19: Effects of Program Termination in year 2000

4.6 Conclusion

My analysis in the previous section indicates that there cannot be a clear-cut evaluation of supply-side focused programs such as the Boston Gun Project, nor is any such program going to be completely successful in eliminating homicides among youths. The implementation of the current program is moderately successful in reducing the homicide rate among youths. Although it does not eradicate youth homicides, it does significantly reduce the rate of homicides of youths by handgun. Combined with other programs, the program could prove to be even more successful.

For this program to have a significant effect upon the homicide rate there must be a substantial removal of handguns from the community. Supply reduction is the high leverage policy point of the program. Concentrated effort needs to be directed towards increasing the probability of successfully confiscating substantial numbers of handguns, legally or illegally possessed. This might be done through more attractive incentives or increased awareness of the effects of eliminating excess guns from neighborhoods. The reduction of excess handguns in the community has the immediate effect of making streets safer by reducing the probability that a gun will be involved in a conflict. As homicide rates fall, the acceptance of guns in the community and the pressure to acquire them for purposes of retaliation and safety fall as well. Thus the effects of gun supply reduction can be compounded into greater success in reducing homicide rates.

Nonetheless, some resistance to this process occurs as people attempt to compensate for the removal of guns from the community by increasing the rate at which they acquire new guns. Even with efforts aimed at disrupting the illegal gun market, the increased

demand for guns will cause the market to continue to exist. Efforts must be directed not only at reducing the supply of handguns into the community but also at altering the demand for guns. By lowering the homicide rate via gun supply programs, the demand for guns also decreases. But programs specifically aimed at reducing the demand further are necessary.

The key point to take away is that unless efforts towards reducing the distribution of guns in the community are sustained, then any successes gained in curtailing the rate of homicides among youths may be lost. This becomes especially crucial when considering that legislative budgets are limited and policy maker's decisions are often political. When low homicide rates coincide with a lack of interest in youth violence then programs such as the Boston Gun Project are set aside as low priority items. Continued support of these types of programs is crucial for their sustained success.

5.0 Bibliography

- Forrester, Jay W. 1969. *Urban Dynamics*. Cambridge, MA: The M.I.T. Press.
- Homer, Jack B. 1979. "INSUR1: A Dynamic Model of Property Insurance Coverage in an Urban Neighborhood. Available from the Alfred P. Sloan School of Management.
- , 1979. "An Addendum to the INSUR1 Report: Further Conclusions." Available from the Alfred P. Sloan School of Management.
- , 1979. "Home Insurance in a Changing Residential Community: A System Dynamics Approach and Case Study." Available from the Alfred P. Sloan School of Management.
- Leland, John. June 1, 1998. "Savior of the Streets." *Newsweek*.
- Levin, Gilbert, Edward B. Roberts, and Gary B. Hirsch. 1975. *The Persistent Poppy: A Computer-Aided Search for Heroin Policy*. Cambridge, MA: Ballinger Publishing Company.
- Massey, Douglas S., and Nancy A. Denton. 1993. *American Apartheid: Segregation and the Making of the Underclass*. Cambridge, MA: Harvard University Press.
- Murray, Charles. 1984. *Losing Ground: American Social Policy, 1950-1980*. New York: Basic Books.
- National Criminal Justice Reference Service. 1996. *Youth Violence: A Community-based Response, One City's Success Story*. <http://www.ncjrs.org/txtfiles/boston.txt>.
- Nifong, Christina. February 20, 1997. "How Boston Brought Down Youth Crime." *Christian Science Monitor*.
- Osofsky, Gilbert. 1966. *Harlem: the Making of a Ghetto: Negro New York, 1890-1930*. New York: Harper & Row.
- Prothrow-Stith, Deborah. 1991. *Deadly Consequences*. New York: HarperCollins Publishers.
- Spear, Allan H. 1967. *Black Chicago: the Making of a Negro Ghetto, 1890-1920*. Chicago: University of Chicago Press.
- U.S. Department of Justice, Bureau of Justice Statistics. 1997. *Law Enforcement Management and Administrative Statistics, 1990-1993*. Washington D.C.: U.S. Government Printing Office.
- , 1998. *Homicide Trends in the United States, 1976-1997*. <http://www.ojp.usdoj.gov/bjs/homicide/homtrnd.htm>.
- U.S. Department of Justice, Federal Bureau of Investigation. 1998. *Uniform Crime Reports, 1970-1997*. Washington D.C.: U.S. Government Printing Office.
- U.S. Department of Justice, National Institute of Justice. 1997. *A Study of Homicide in Eight U.S. Cities: An NIJ Intramural Research Project*. <http://ncjrs.org/pdffiles/homicide.pdf>.
- U.S. Department of Justice, Office of Juvenile Justice and Delinquency Prevention. 1998. *Promising Strategies to Reduce Gun Violence*. http://ojjdp.ncjrs.org/pubs/gun_violence/contents.html.
- U.S. Department of the Treasury, Bureau of Alcohol, Tobacco, and Firearms. 1999. *ATF, The Youth Crime Gun Interdiction Initiative – Crime Gun Trace Analysis Report: The Illegal Youth Firearms Market in Boston*. Washington, D.C.: U.S. Government Printing Office.

- Washington, Booker T. 1899. *The Future of the American Negro*. Boston: Small, Maynard & Co.
- Whitman, David. May 5, 1997. "The Youth Crisis." *U.S. News*.
- Wilson, William J. 1978. *The Declining Significance of Race: Blacks and Changing American Institutions*. Chicago: University of Chicago Press.
- . 1987. *The Truly Disadvantaged: The Inner City, the Underclass, and Public Policy*. Chicago: The University of Chicago Press.
- . 1996. *When Work Disappears: the World of the New Urban Poor*. New York: Random House Inc.
- Woodwards, Kenneth L. June 1, 1998. "The New Holy War." *Newsweek*.
- Zimring, Franklin E., and Gordon Hawkins. 1997. *Crime is Not the Problem: Lethal Violence in America*. New York: Oxford University Press.

6.0 Appendix – HOMICIDE Model Documentation

.Control

BuyBack X=

1*Gun X

Units: dimensionless

Switch to activate gun buy-back emphasis of gun removal program.

FINAL TIME =

2020

Units: Year

The final time for the simulation.

Gun X=

0*STEP(1, 1992)+0*STEP(-1, 2005)

Units: dimensionless

Switch to activate the gun removal program.

Incarceration X=

1*Gun X

Units: dimensionless

Switch to activate the incarceration emphasis of the gun program.

INITIAL TIME =

1985

Units: Year

The initial time for the simulation.

Mig X=

0

Units: dimensionless

Switch to activate net migration flow.

Pop X=

1

Units: dimensionless

Switch to turn population aging on/off.

Resell X=

0

Units: dimensionless

Switch to allow the reselling of confiscated guns back to the adult legal public.

SAVEPER =

TIME STEP

Units: Year

The frequency with which output is stored.

SEL X=

1

Units: dimensionless

Switch to activate the socioeconomic effects on the rate of conflict.

Supply X=

1*Gun X

Units: dimensionless

Switch to activate illegal gun supply emphasis of gun removal program.

Theft X=

1

Units: dimensionless

Switch to allow the theft of confiscated guns to be sold back to the illegal public on the black market.

TIME STEP =

0.0625

Units: Year

The time step for the simulation.

Figure Pages

Figure 1: Population Sector

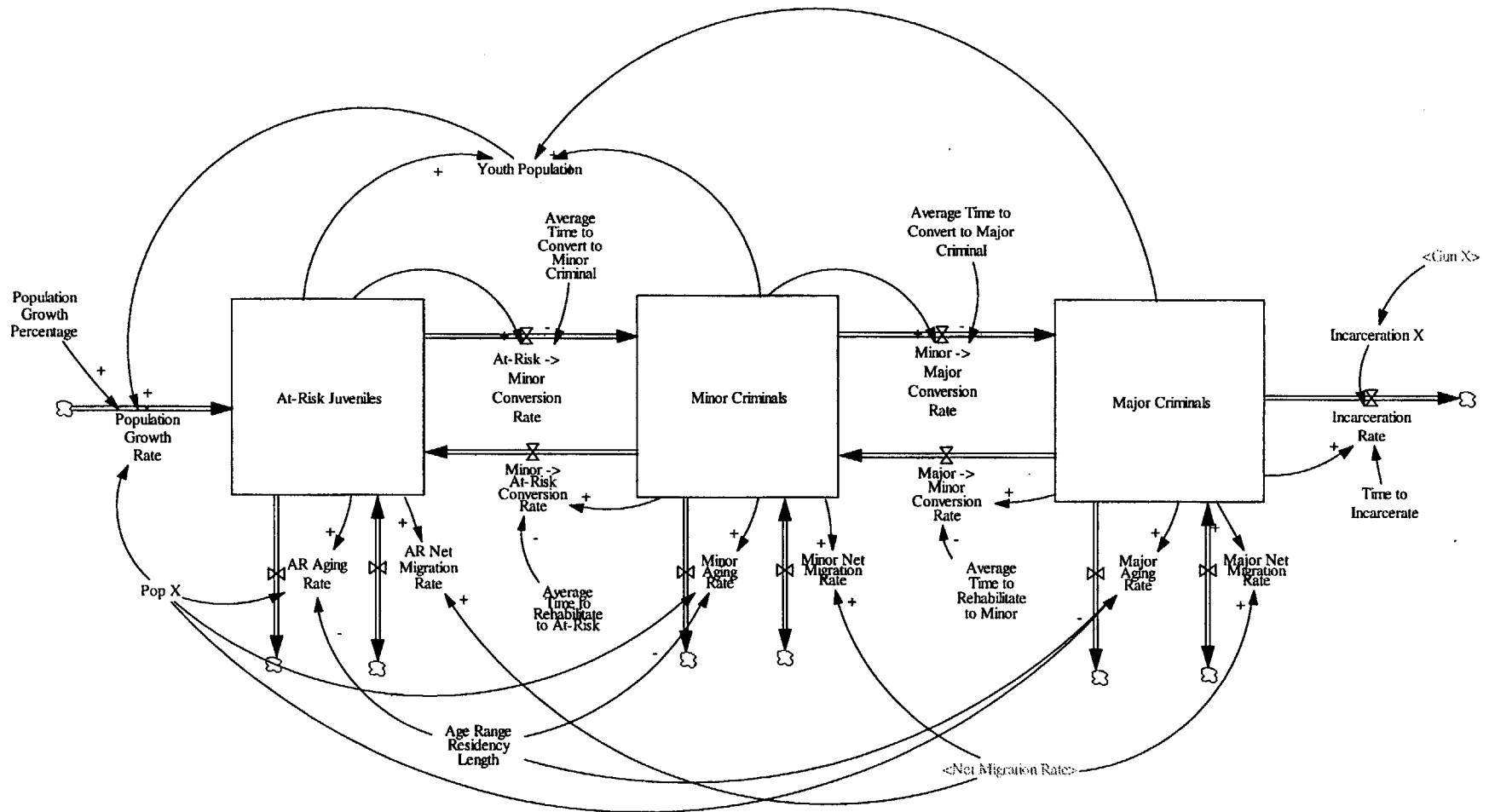

Figure 2: Handguns Sector

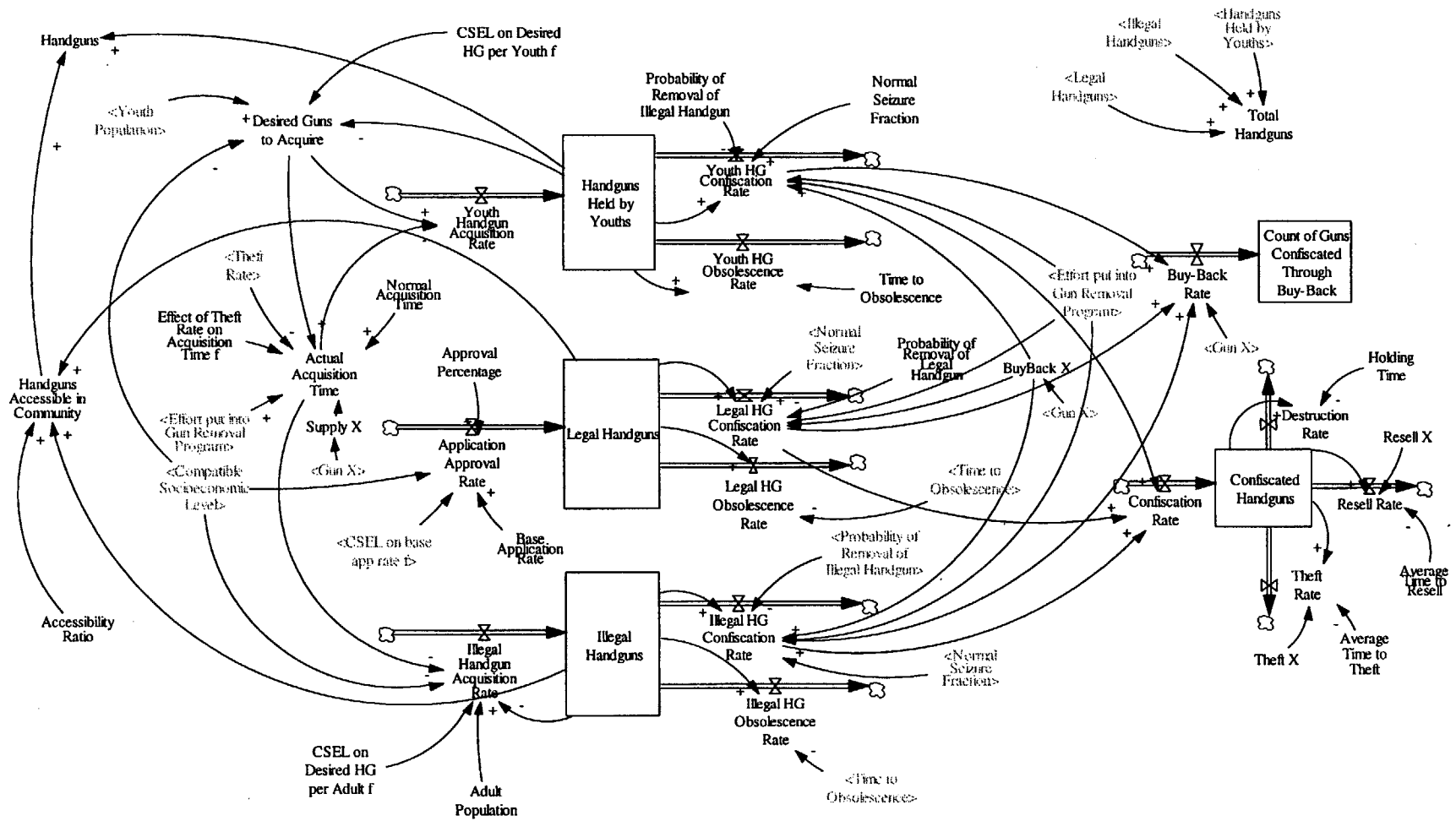

Figure 3: Homicides Sector

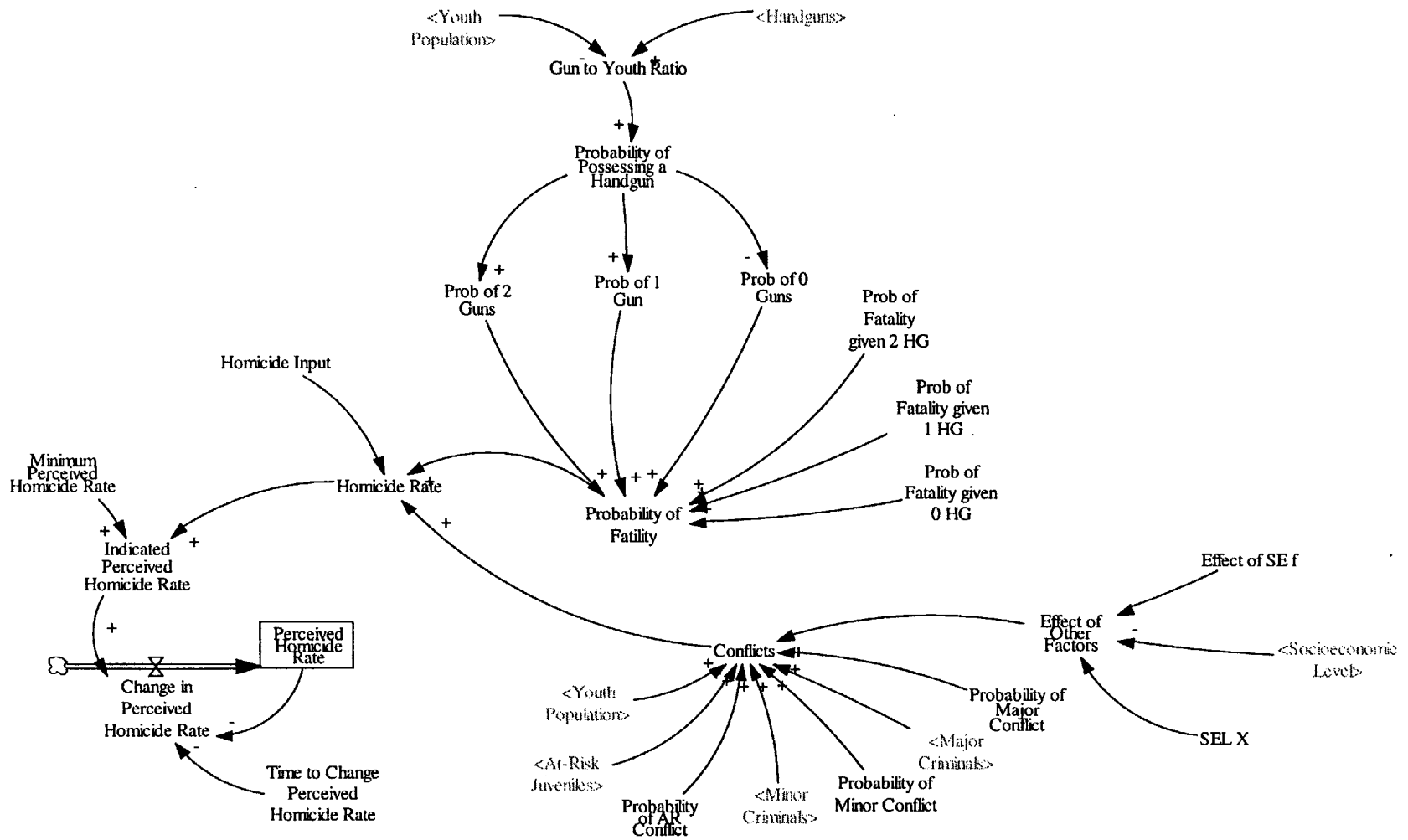

Figure 4: Gun Removal Project Sector

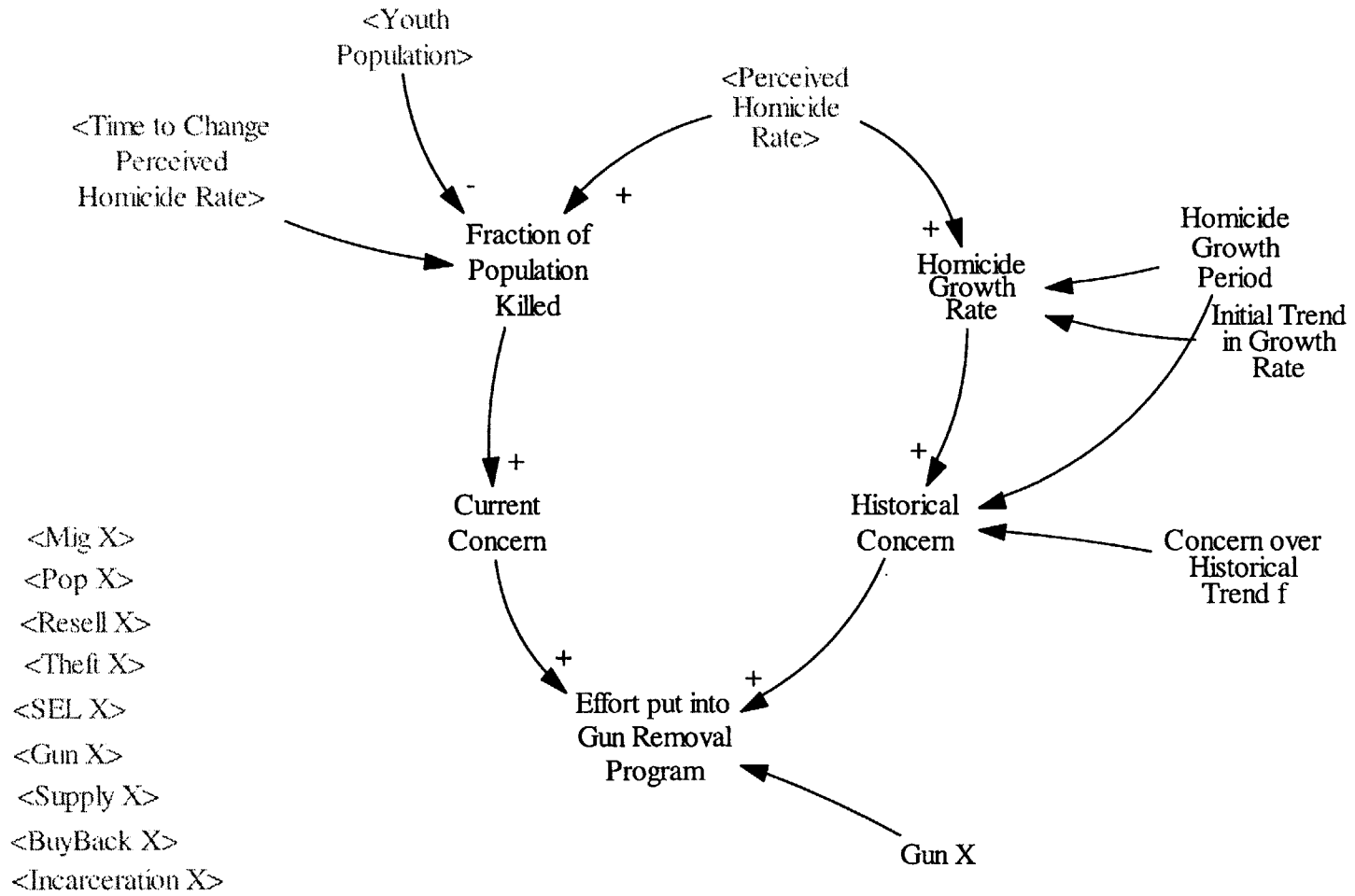
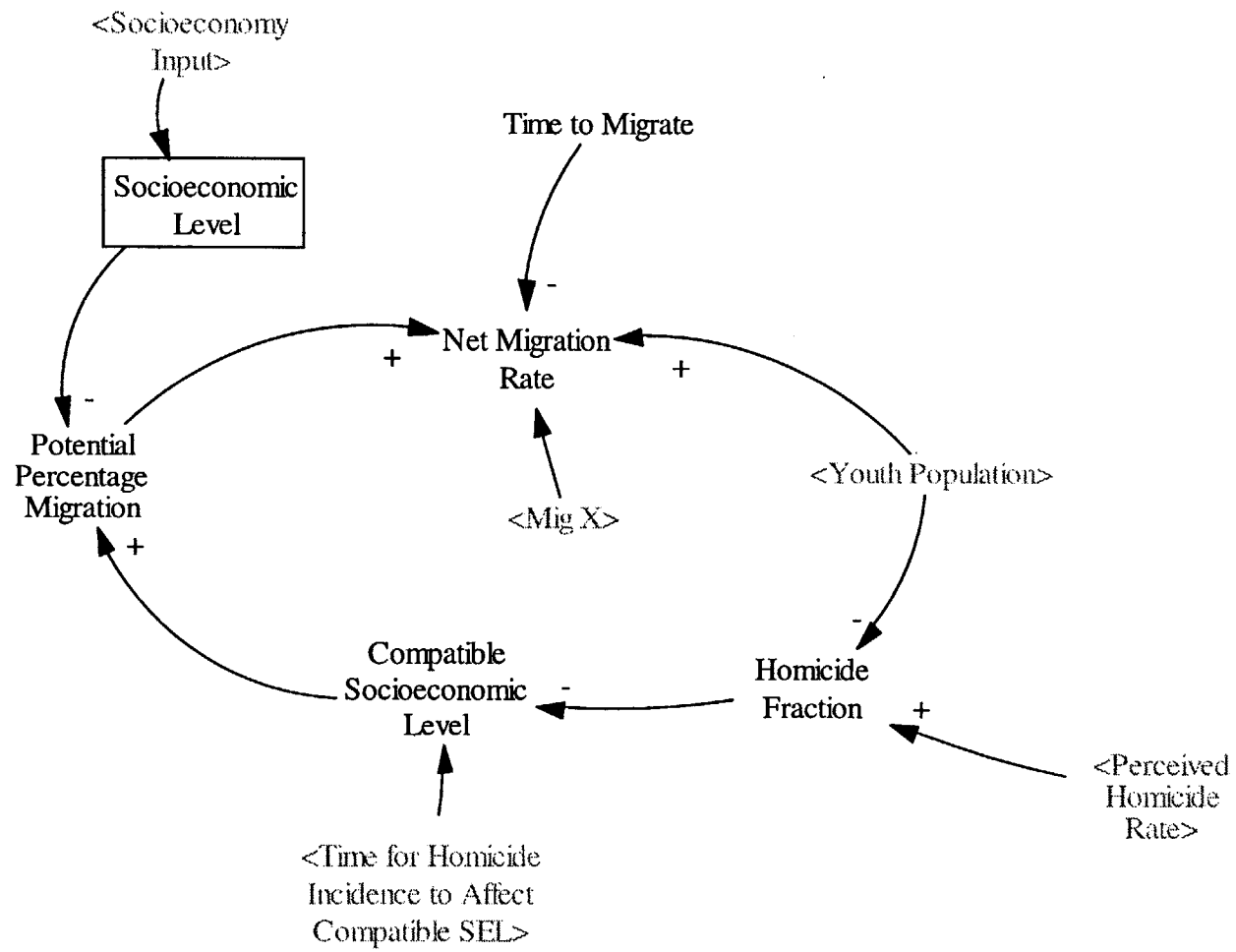

Figure 5: SocioEconomy Sector



.Population

Age Range Residency Length=

4

Units: Year

The age range is restricted to juveniles ages 14-17. This age range was chosen for statistical convenience as well as to ensure that all guns held by "juveniles" are by default illegally possessed.

AR Aging Rate=

"At-Risk Juveniles"/Age Range Residency Length*Pop X

Units: people/Year

Normal aging rate from the stock of At-Risk Juveniles as the population leaves the age range of interest.

AR Net Migration Rate=

Net Migration Rate*("At-Risk Juveniles"/Youth Population)

Units: people/Year

Net migration rate into and out of the stock of At-Risk Juveniles. In need of first order control as well as check the influence of the effects of the attractiveness of the community as dictated by the current and compatible socioeconomic levels.

"At-Risk -> Minor Conversion Rate"=

"At-Risk Juveniles"/Average Time to Convert to Minor Criminal

Units: people/Year

The at-risk juvenile to minor criminal conversion rate assumes first order control. Because the population of youths is assumed to be completely homogeneous and well-mixed, all at-risk juveniles are equally likely to eventually convert to minor criminal, unless they age out first.

"At-Risk Juveniles"=

INTEG ((Population Growth Rate+"Minor -> At-Risk Conversion Rate"+AR Net Migration Rate)-("At-Risk -> Minor Conversion Rate"+AR Aging Rate), (Initial Youth Population*Population Growth Percentage*Pop X+Minor Criminals/"Average Time to Rehabilitate to At-Risk")/(1/Age Range Residency Length + 1/Average Time to Convert to Minor Criminal))

Units: people

At-risk juveniles are assumed to be all youths (less minor and major criminals) who reside in inner-city areas typified by high rates of unemployment, youthful age structures, out-of-wedlock births, female-headed households, welfare dependency, etc.

Average Time to Convert to Major Criminal=

5

Units: Year

Average length of time until a minor juvenile criminal will commit a major felony.

Average Time to Convert to Minor Criminal=

3

Units: Year

Average length of time until an at-risk juvenile will commit a minor crime.

"Average Time to Rehabilitate to At-Risk"=

2

Units: Year

Average length of time during which a youth who has previously committed a minor crime must remain crime-free in order to be considered rehabilitated.

Average Time to Rehabilitate to Minor=

2

Units: Year

Average length of time during which a youth who has previously committed a major crime must remain felony-free in order to be considered rehabilitated.

Initial Youth Population=

101064

Units: people

"Major -> Minor Conversion Rate"=

Major Criminals/Average Time to Rehabilitate to Minor

Units: people/Year

The major criminal to minor criminal conversion rate assumes first order control. Because the population of youths is assumed to be completely homogeneous and well-mixed, all major criminals are equally likely to eventually rehabilitate to minor criminals, unless they age out first.

Major Aging Rate=

Major Criminals/Age Range Residency Length* Pop X

Units: people/Year

Normal aging rate from the stock of Major Criminals as the population leaves the age range of interest.

Major Criminals=

INTEG (("Minor -> Major Conversion Rate"+Major Net Migration Rate)-("Major -> Minor Conversion Rate"+Incarceration Rate+Major Aging Rate),(Minor Criminals/Average Time to Convert to Major Criminal)/(1/Average Time to Rehabilitate to Minor + 1/Age Range Residency Length* Pop X))

Units: people

Major Criminals include only those youths who have committed a recent major felony.

Major Net Migration Rate=

Net Migration Rate*(Major Criminals/Youth Population)

Units: people/Year

Net migration rate into and out of the stock of Major Criminals. In need of first order control as well as check the influence of the effects of the attractiveness of the community as dictated by the current and compatible socioeconomic levels.

"Minor -> At-Risk Conversion Rate"=

Minor Criminals/"Average Time to Rehabilitate to At-Risk"

Units: people/Year

The minor criminal to at-risk juvenile conversion rate assumes first order control. Because the population of youths is assumed to be completely homogeneous and well-mixed, all minor criminals are equally likely to eventually rehabilitate to at-risk juveniles, unless they age out first.

"Minor -> Major Conversion Rate"=

Minor Criminals/Average Time to Convert to Major Criminal

Units: people/Year

The minor criminal to major criminal conversion rate assumes first order control. Because the population of youths is assumed to be completely homogeneous and well-mixed, all minor criminals are equally likely to eventually convert to major criminal, unless they age out first.

Minor Aging Rate=

Minor Criminals/Age Range Residency Length*Pop X

Units: people/Year

Normal aging rate from the stock of Minor Criminals as the population leaves the age range of interest.

Minor Criminals=

INTEG (("At-Risk -> Minor Conversion Rate"+"Major -> Minor Conversion Rate"+Minor Net Migration Rate)-("Minor -> At-Risk Conversion Rate"+"Minor -> Major Conversion Rate"+Minor Aging Rate), 27190)

Units: people

Minor Criminals consists of those youths who have committed criminal activity but not a major felony recently.

Minor Net Migration Rate=

Net Migration Rate*(Minor Criminals/Youth Population)

Units: people/Year

Net migration rate into and out of the stock of Minor Criminals. In need of first order control as well as check the influence of the effects of the attractiveness of the community as dictated by the current and compatible socioeconomic levels.

Population Growth Percentage=

0.25

Units: 1/Year

The growth percentage of 25% was selected in order to maintain the population at a constant level given that the aging rate is determined by a 4 year residency time length. In order to model net increases in the population, a population growth percentage greater than 25% must be used.

Population Growth Rate=

Youth Population*Population Growth Percentage*Pop X

Units: people/Year

Population growth rate captures the aging rate from 13 year olds, outside the boundary of the model, to 14 year olds being studied. Net increase in the total population size is attributable to a generational increase in birth rates. According to FBI statistics, the population grew at 0.87% in 1998. Net total population growth is not allowed within this model. Assumption: at the age of 14, everyone entering the population through aging falls into the at-risk group.

Youth Population=

"At-Risk Juveniles"+Minor Criminals+Major Criminals

Units: people

Sum of all youths of ages 14-17 residing within the community being studied.

.Handguns

Accessibility Ratio=

0.2

Units: dimensionless

The fraction of the guns in the general community which youths can access easily via family, neighbors, and friends.

Actual Acquisition Time=

Normal Acquisition Time*Effect of Theft Rate on Acquisition Time
f(Theft Rate/Desired Guns to Acquire* Normal Acquisition Time) *
(1+Effort put into Gun Removal Program*Supply X)

Units: Year

The normal time to acquire a gun can be reduced by increases in the supply of guns in the illegal market.

Adult Population=

277490

Units: people

Adult population of community being studied.

Application Approval Rate=

Approval Percentage*Base Application Rate*Effect of Compatible SEL
on base app rate f(Compatible Socioeconomic Level)

Units: guns/Year

The application approval rate is the approval fraction of the base application rate which is affected by the socioeconomic level compatible with the current rate of homicide.

Approval Percentage=

0.8

Units: dimensionless

Percentage used to determine what portion of applications for handgun ownership passes approval.

Base Application Rate=

6000

Units: guns/Year

Base application rate for handgun ownership.

Desired Guns to Acquire=

Youth Population*Effect of Compatible SEL on Desired HG per Youth
f(Compatible Socioeconomic Level)-Handguns Held by Youths

Units: guns

The number of desired guns to acquire is the difference between the number of guns desired among youths in the community as dictated by the socioeconomic level compatible with the current rate of homicides and the current actual number of handguns held by youths in the community.

CSEL on base app rate f(

[(0,0)-(1,1.5)],(0,1.5),(0.0876133,1.31579),(0.226586,1.16447),(0.401813,1.07237),(0.625378,1.01754),(0.8,1),(1,1))

Units: dimensionless

As the socioeconomic level decreases, the effect is to increase the application rate.

CSEL on Desired HG per Adult f(

[(0,0)-(1,10)],(0,10),(0.0271903,4.47368),(0.0845921,2.5),(0.175227,1.27193),(0.323263,0.526316),(0.498489,0.263158),(0.81571,0.0877193),(1,0.1))

Units: guns/people

As the socioeconomic level compatible with the current rate of homicide declines, the desired number of handguns per adult in the community increases at an increasing rate.

CSEL on Desired HG per Youth f(

[(0,0)-(1,10)],(0,10),(0.0120846,5.65789),(0.0755287,2.58772),(0.193353,1.14035),(0.371601,0.394737),(0.586103,0.219298),(0.794562,0.0877193),(1,0.1))

Units: guns/people

As the socioeconomic level compatible with the current rate of homicide declines, the desired number of handguns per youth in the community increases at an increasing rate.

Effect of Theft Rate on Acquisition Time f(

[(0,0)-(1,1)],(0,1),(0.172205,1),(0.34139,0.903509),(0.501511,0.692982),(0.649547,0.587719),(0.836858,0.513158),(1,0.5))

Units: dimensionless

As Theft Rate goes to 0, the effect on Acquisition Time becomes neutral or equal to 1. As theft rate increases to levels comparable to acquisition rates, the greatest effect it can have is to reduce the acquisition time by 1/2.

Handguns=

Handguns Held by Youths+Handguns Accessible in Community

Units: guns

Handguns calculates the total number of guns to which juveniles have access. This is the sum of the handguns held by youths and the portion of the handguns within the general community to which youths have access.

Handguns Accessible in Community=

$(\text{Legal Handguns} + \text{Illegal Handguns}) * \text{Accessibility Ratio}$

Units: guns

The number of guns in the general community to which youths have easy access. The ratio of guns they can access is determined by the accessibility ratio.

Handguns Held by Youths=

$\text{INTEG}(\text{Youth Handgun Acquisition Rate} - \text{Youth HG Obsolescence Rate} - \text{Youth HG Confiscation Rate}, \text{Youth Population} * \text{Effect of Compatible SEL on Desired HG per Youth } f(\text{Compatible Socioeconomic Level}) / \text{Normal Acquisition Time} / (\text{Normal Seizure Fraction} + 1 / \text{Time to Obsolescence} + 1 / \text{Normal Acquisition Time}))$

Units: guns

All Handguns held by youths are considered to be illegally obtained.

Illegal Handgun Acquisition Rate=

$\text{MAX}(0, (\text{Adult Population} * \text{Effect of Compatible SEL on Desired HG per Adult } f(\text{Compatible Socioeconomic Level}) - \text{Illegal Handguns}) / \text{Actual Acquisition Time})$

Units: guns/Year

Given the socioeconomic level of the community compatible with the current rate of homicide, there is some desired ratio of handguns to adults. The lack of actual handguns compared to the desired level drives the acquisition rate. The difficulties in obtaining a gun determine the acquisition time. As stolen handguns are released into the market, the acquisition time is decreased.

Illegal Handguns=

$\text{INTEG}(\text{Illegal Handgun Acquisition Rate} - \text{Illegal HG Confiscation Rate} - \text{Illegal HG Obsolescence Rate}, \text{Adult Population} * \text{Effect of Compatible SEL on Desired HG per Adult } f(\text{Compatible Socioeconomic Level}) / \text{Normal Acquisition Time} / (\text{Normal Seizure Fraction} + 1 / \text{Time to Obsolescence} + 1 / \text{Normal Acquisition Time}))$

Units: guns

Illegal handguns are all handguns illegally obtained or held by an adult or adult felon. It is assumed that the number of guns held by pre-14 year olds is not significant.

Illegal HG Confiscation Rate=

$\text{Illegal Handguns} * (\text{Normal Seizure Fraction} + \text{Probability of Removal of Illegal Handgun} * \text{Effort put into Gun Removal Program} * \text{BuyBack } X)$

Units: guns/Year

Sum of the normal confiscation rate from routine busts and seizures and the confiscation rate through buy-back type programs. The magnitude of the confiscation rate from buy-back program is determined by the effort put into the gun program.

Illegal HG Obsolescence Rate=

Illegal Handguns/Time to Obsolescence

Units: guns/Year

Illegal Handgun Obsolescence Rate is the rate at which guns held by youths get lost, broken, or out of use.

Legal Handguns=

$INTEG (Application\ Approval\ Rate - Legal\ HG\ Obsolescence\ Rate - Legal\ HG\ Confiscation\ Rate, Application\ Approval\ Rate / (Normal\ Seizure\ Fraction + 1/Time\ to\ Obsolescence))$

Units: guns

Legal handguns are obtained according to federal, state, and local regulation by adults.

Legal HG Confiscation Rate=

$Legal\ Handguns * (Normal\ Seizure\ Fraction + Probability\ of\ Removal\ of\ Legal\ Handgun * Effort\ put\ into\ Gun\ Removal\ Program * BuyBack\ X)$

Units: guns/Year

Sum of the normal confiscation rate from routine busts and seizures and the confiscation rate through buy-back type programs. The magnitude of the confiscation rate from buy-back program is determined by the effort put into the gun program.

Legal HG Obsolescence Rate=

Legal Handguns/Time to Obsolescence

Units: guns/Year

Legal HG Obsolescence Rate is the rate at which guns in the general community get lost, broken, or go out-of-date.

Normal Acquisition Time=

0.25

Units: Year

The normal length of time to acquire an illegal gun.

Normal Seizure Fraction=

0.001

Units: 1/Year

Fraction of the handguns that are seized under routine busts each year.

Probability of Removal of Illegal Handgun=

0.2

Units: 1/Year

Percentage per year of successfully removing an illegal handgun through buy-back programs.

Probability of Removal of Legal Handgun=

0.1

Units: 1/Year

Percentage per year of removing a legal handgun through buy-back programs.

Time to Obsolescence=

25

Units: Year

The Time to Obsolescence is the average time for a gun to get lost, broken, or out-of-use. This time might be less for the youthful population versus the general population. Youths tend to like newer guns.

Total Handguns=

Handguns Held by Youths+Legal Handguns+Illegal Handguns

Units: guns

Tally of the total number of guns in the public domain.

Youth Handgun Acquisition Rate=

$\text{MAX}(0, \text{Desired Guns to Acquire}/\text{Actual Acquisition Time})$

Units: guns/Year

Given the socioeconomic level of the community compatible with the current rate of homicide, there is some desired ratio of handguns to youths. The lack of actual youth handguns compared to the desired level drives the acquisition rate. The difficulties in obtaining a gun determine the acquisition time. As stolen handguns are released into the market, the acquisition time is decreased.

Youth HG Confiscation Rate=

$\text{Handguns Held by Youths} * (\text{Normal Seizure Fraction} + \text{Probability of Removal of Illegal Handgun} * \text{Effort put into Gun Removal Program} * \text{BuyBack X})$

Units: guns/Year

Sum of the normal confiscation rate from routine busts and seizures and the confiscation rate through buy-back type programs. The magnitude of the confiscation rate from buy-back program is determined by the effort put into the gun program.

Youth HG Obsolescence Rate=

$\text{Handguns Held by Youths}/\text{Time to Obsolescence}$

Units: guns/Year

The Youth Handgun Obsolescence Rate is the rate at which guns held by youths get lost, broken, or out of use.

.Homicides

Change in Perceived Homicide Rate=

(Indicated Perceived Homicide Rate-Perceived Homicide Rate)/Time to
Change Perceived Homicide Rate

Units: people/Year/Year

Conflicts=

Youth Population*((("At-Risk Juveniles"/Youth Population)*Probability
of AR Conflict)+((Minor Criminals/Youth Population)*Probability of
Minor Conflict)+((Major Criminals/Youth Population)*Probability of
Major Conflict))*Effect of Other Factors

Units: people/Year

The rate of juveniles involved in conflicts or attacks which have the
potential to lead to violence.

Effect of Other Factors=

1+SEL X*Effect of SE f(Socioeconomic Level)

Units: dimensionless

Normally set to the value 1 in order to have no effect. The effects of the
socioeconomic level, ie and imperfect community, serve to increase the
number of conflicts in which youths participate.

Gun to Youth Ratio=

Handguns/Youth Population

Units: guns/people

Ratio of handguns to which youths have access over the number of youths
in the population determines the average distribution of guns within the
community.

Homicide Input=

0*PULSE(1992, 0.5)

Units: people/Year

Homicide Rate=

Conflicts*Probability of Fatality given Handgun Involvement +
25*Homicide Input

Units: people/Year

The current homicide rate. Limited strictly to homicides within youth
population, ages 14-17 years old, by handgun wound. Should go to 0 if
there are no handguns available.

Indicated Perceived Homicide Rate=

MAX(Homicide Rate,Minimum Perceived Homicide Rate)

Units: people/Year
Indicated rate tracks the current rate unless it goes below the minimum rate.

Minimum Perceived Homicide Rate=
0

Units: people/Year
Rationality bound on the minimum possible homicides per year.

Perceived Homicide Rate=
INTEG (Change in Perceived Homicide Rate,21.59)

Units: people/Year
Homicide rate perceived by community delayed by perception delay.

Prob of 0 Guns=
 $(1 - \text{Probability of Possessing a Handgun}) * (1 - \text{Probability of Possessing a Handgun})$

Units: dimensionless
The probability that exactly 0 guns will be involved in a given conflict.

Prob of 1 Gun=
 $\text{Probability of Possessing a Handgun} * (1 - \text{Probability of Possessing a Handgun}) + \text{Probability of Possessing a Handgun} * (1 - \text{Probability of Possessing a Handgun})$

Units: dimensionless
Probability of having exactly one party possessing a gun in a conflict.

Prob of 2 Guns=
 $\text{Probability of Possessing a Handgun} * \text{Probability of Possessing a Handgun}$

Units: dimensionless
Probability that both parties will possess a handgun.

Prob of Fatality given 0 HG=
0

Units: dimensionless
Given that there are exactly 0 handguns involved in a conflict, the probability of death must be 0.

Prob of Fatality given 1 HG=
0.01

Units: dimensionless
Given that there is exactly 1 handgun involved in a conflict, the probability of death resulting is 0.01.

Prob of Fatality given 2 HG=
0.1

Units: dimensionless

Given that there are exactly 2 handguns involved in a conflict, the probability of death resulting is 0.1.

Probability of AR Conflict=

0.2

Units: 1/Year

Rate at which at-risk juveniles come into conflict.

Probability of Fatality=

Prob of Fatality given 2 HG*Prob of 2 Guns+Prob of Fatality given 1 HG*Prob of 1 Gun+Prob of Fatality given 0 HG*Prob of 0 Guns

Units: dimensionless

The probability of fatality by handgun wound given that a conflict occurs between two youths. The presence of more than two guns in a conflict is assumed to be not statistically more significant than the presence of exactly 0, 1, or 2 guns.

Probability of Major Conflict=

0.9

Units: 1/Year

Rate at which major juvenile criminals come into conflict.

Probability of Minor Conflict=

0.6

Units: 1/Year

Rate at which minor juvenile criminals come into conflict.

Probability of Possessing a Handgun=

$\text{MIN}(1, 0.05 * \text{Gun to Youth Ratio})$

Units: dimensionless

Bounded by [0,1]. The probability of that any one person possesses a gun is lower than the actual gun to youth ratio. Possessed guns are not in the immediate vicinity at all times.

Time to Change Perceived Homicide Rate=

0.333

Units: Year

Perception delay.

.Socioeconomy

Compatible Socioeconomic Level=

$\text{MIN}(1, \text{SMOOTH}(1/(1000 * \text{Homicide Fraction}), \text{Time for Homicide Incidence to Affect Compatible SEL}))$

Units: dimensionless

The Compatible Socioeconomic Level is the community's socioeconomic level indicated by the perceived homicide rate.

Effect of SE f(

$[(0,0)-(1,1)], (0,1), (0.148036, 0.881579), (0.317221, 0.692982), (0.498489, 0.442982), (0.63142, 0.201754), (0.821752, 0.0482456), (1,0))$

Units: dimensionless

As the attractiveness of the community or the social and economic levels of the community decrease, the rate at which youths come into conflict increases.

Homicide Fraction=

$\text{Perceived Homicide Rate} / \text{Youth Population}$

Units: 1/Year

Calculates the fraction of the population that dies by homicide.

Net Migration Rate=

$\text{SMOOTH}(\text{Youth Population} * \text{Potential Percentage Migration} / \text{Time to Migrate}, \text{Time to Migrate}) * \text{Mig X}$

Units: people/Year

When not activated, has a value of 0 to signal no net migration. When activated, the rate of net migration flow causes the ratio of the numbers of types of youths within the community to be compatible with socioeconomic level indicated by the current homicide rate.

Potential Percentage Migration=

$\text{Compatible Socioeconomic Level} - \text{Socioeconomic Level}$

Units: dimensionless

The PPM determines the rate of migration into or out of the community. It calculates the difference between the socioeconomic level compatible with the perceived homicide rate and the community's current socioeconomic level.

Socioeconomic Level=

$\text{MAX}(0, \text{MIN}(1, 0.5 + \text{Socioeconomy Input}))$

Units: dimensionless

The socioeconomic level describes the attractiveness of the community as well as its social and economic conditions based on its age structures, rates of employment, out-of-wedlock births, female-headed households, welfare dependency, etc. It is bounded by [0,1]. The initial value of the socioeconomic level is set at 0.5 to represent the more disadvantaged community being studied. The socioeconomic level will not vary.

Socioeconomy Input=

-RAMP(0.01, 1985, 2000)*0

Units: dimensionless

Time for Homicide Incidence to Affect Compatible SEL=

0.5

Units: Year

The length of time over which the past values of Homicide Incidence are relevant for determining the Compatible Socioeconomic level of the community.

Time to Migrate=

4

Units: Year

Average time to migrate.

.Gun Removal Project

Average Time to Resell=

3

Units: Year

Time until confiscated guns are resold to the public through legal means.

Average Time to Theft=

4

Units: Year

Time until confiscated guns are stolen or sold to the public through illegal means.

"Buy-Back Rate"=

((Youth HG Confiscation Rate+Legal HG Confiscation Rate+Illegal HG Confiscation Rate)-(Total Handguns*Normal Seizure Fraction))*Gun X

Units: guns/Year

The rate at which guns are confiscated through buy-back type programs. This flow is controlled via the Gun X switch. It is set to 0 when the gun program is not implemented. It sums the confiscation rates from youth, legal, and illegal gun stocks less the normal confiscation rate from routine busts and seizures.

Concern over Historical Trend f(

[(-0.2,0)-(1,1)],(-0.2,0),(-0.0586103,0.302632),(0.122659,0.671053),(0.293051,0.842105),(0.480363,0.934211),(0.752266,0.97807),(1,1))

Units: dimensionless

As the growth in the change in the homicide rate increase the concern increases, but at a diminishing rate. For values of change near 0, the concern is a small positive number. Even if the homicide rate is fairly stable, there is some concern due to the lack of decrease.

Confiscated Handguns=

INTEG (Confiscation Rate-Resell Rate-Theft Rate-Destruction Rate, Total Handguns*Normal Seizure Fraction*Holding Time)

Units: guns

Pool of confiscated guns through both normal seizure during routine busts and through buy-back programs targeted at removing excess guns from the streets. Initial value set to match destruction rate to normal seizure rate.

Confiscation Rate=

Youth HG Confiscation Rate+Legal HG Confiscation Rate+Illegal HG Confiscation Rate

Units: guns/Year

Rate of confiscation of handguns from youth, legal, and illegal gun stocks. This includes both guns confiscated through normal routine busts and seizures as well as guns confiscated specifically through buy-back type programs.

"Count of Guns Confiscated Through Buy-Back"=

INTEG ("Buy-Back Rate", 0)

Units: guns

Tally of the total number of guns confiscated through buy-back type programs. Initial value is set to 0 assuming that no such program exists initially.

Current Concern=

MAX(0,-1/(40000*Fraction of Population Killed)+1)

Units: dimensionless

Level of concern triggered by the current levels of homicide rates as a fraction of the total population. Bounded by [0,1]. As the fraction of the population that is homicidally killed increases, the level of concern increases.

Destruction Rate=

Confiscated Handguns/Holding Time

Units: guns/Year

The normal rate at which seized guns are destroyed.

Effort put into Gun Removal Program=

SMOOTH(Gun X*(0.8*Current Concern+0.2*Historical Concern), 0.25,0)

Units: dimensionless

Measure of the effectiveness of gun removal programs. Bounded by [0,1]. Initially set to equal 0 in order to have no flow.

Fraction of Population Killed=

Perceived Homicide Rate*Time to Change Perceived Homicide Rate/Youth Population

Units: dimensionless

The fraction of the population that has been killed over the period of time it takes to perceive changes in the homicide rate.

Historical Concern=

Concern over Historical Trend f(Homicide Growth Rate*Homicide Growth Period)

Units: dimensionless

The level of concern determined by the growth in the homicide rate over the past 2 years. Bounded by [0,1].

Holding Time=

5

Units: Year

Average time til confiscated guns are destroyed.

Homicide Growth Period=

2

Units: Year

Past period of time over which the growth of the homicide rate is a concern.

Homicide Growth Rate=

TREND(Perceived Homicide Rate,Homicide Growth Period, Initial Trend in Growth Rate)

Units: 1/Year

Rate of change of the homicide rate over the past 2 years.

Incarceration Rate=

Major Criminals/Time to Incarcerate* Gun X

Units: people/Year

The incarceration rate assumes first order control. Because the population of major criminals is assumed to be completely homogeneous and well-mixed, all major criminals are equally likely to be incarcerated. In reality, the gun program targets the most influential and violent criminals for incarceration. This should have a disproportionate effect on the rate of homicide. This dynamic is not captured by this model.

Initial Trend in Growth Rate=

0

Units: 1/Year

Resell Rate=

Confiscated Handguns/Average Time to Resell*Resell X

Units: guns/Year

Rate at which confiscated guns are resold to the public through legal means. The flow is controlled by the Resell X switch. Rate is set to 0 when the switch is off. Rate is controlled by first order control when on.

Theft Rate=

Confiscated Handguns/Average Time to Theft*Theft X

Units: guns/Year

Rate at which confiscated guns are stolen or sold to the public through illegal means. Theft rate is controlled by Theft X switch. Theft rate is set

to 0 when the switch is off. Theft is under first order control when the switch is on.

Time to Incarcerate=

25

Units: Year

Average length of time until any given juvenile felon will be incarcerated. This number is high due to the significant legal constraints in trying a juvenile.

7423 - 10