

MIT Open Access Articles

Conformal loop ensembles: the Markovian characterization and the loop-soup construction

The MIT Faculty has made this article openly available. *Please share* how this access benefits you. Your story matters.

Citation: Sheffield, Scott, and Wendelin Werner. "Conformal loop ensembles: the Markovian characterization and the loop-soup construction." *Annals of Mathematics* 176, no. 3 (November 1, 2012): 1827-1917.

As Published: <http://dx.doi.org/10.4007/annals.2012.176.3.8>

Publisher: Princeton University Press

Persistent URL: <http://hdl.handle.net/1721.1/80824>

Version: Original manuscript: author's manuscript prior to formal peer review

Terms of use: Creative Commons Attribution-Noncommercial-Share Alike 3.0



Conformal loop ensembles: the Markovian characterization and the loop-soup construction

SCOTT SHEFFIELD* and WENDELIN WERNER†

Abstract

For random collections of self-avoiding loops in two-dimensional domains, we define a simple and natural conformal restriction property that is conjecturally satisfied by the scaling limits of interfaces in models from statistical physics. This property is basically the combination of conformal invariance and the locality of the interaction in the model. Unlike the Markov property that Schramm used to characterize SLE curves (which involves conditioning on partially generated interfaces up to arbitrary stopping times), this property only involves conditioning on entire loops and thus appears at first glance to be weaker.

Our first main result is that there exists exactly a one-dimensional family of random loop collections with this property—one for each $\kappa \in (8/3, 4]$ —and that the loops are forms of SLE_κ . The proof proceeds in two steps. First, uniqueness is established by showing that every such loop ensemble can be generated by an “exploration” process based on SLE.

Second, existence is obtained using the two-dimensional Brownian loop-soup, which is a Poissonian random collection of loops in a planar domain. When the intensity parameter c of the loop-soup is less than 1, we show that the outer boundaries of the loop clusters are disjoint simple loops (when $c > 1$ there is a.s. only one cluster) that satisfy the conformal restriction axioms. We prove various results about loop-soups, cluster sizes, and the $c = 1$ phase transition.

Taken together, our results imply that the following families are equivalent:

1. The random loop ensembles traced by branching Schramm-Loewner Evolution (SLE_κ) curves for κ in $(8/3, 4]$.
2. The outer-cluster-boundary ensembles of Brownian loop-soups for $c \in (0, 1]$.
3. The (only) random loop ensembles satisfying the *conformal restriction axioms*.

*Massachusetts Institute of Technology. Partially supported by NSF grants DMS 0403182 and DMS 0645585 and OISE 0730136.

†Université Paris-Sud 11 and Ecole Normale Supérieure. Research supported in part by ANR-06-BLAN-00058

Contents

1	Introduction	4
1.1	General introduction	4
1.2	Main statements and outline: The Markovian construction	6
1.3	Main statements and outline: The loop-soup construction	9
1.4	Main statements and outline: Combining the two steps	11
1.5	Further background	13
 Part one: the Markovian characterization		15
2	The CLE property	15
2.1	Definitions	15
2.2	Simple properties of CLEs	17
3	Explorations	18
3.1	Exploring CLEs – heuristics	18
3.2	Discovering the loops that intersect a given set	19
3.3	Discovering random configurations along some given line	23
4	The one-point pinned loop measure	26
4.1	The pinned loop surrounding the origin in \mathbb{U}	26
4.2	The infinite measure on pinned loops in \mathbb{H}	28
4.3	Discrete radial/chordal explorations, heuristics, background	31
4.4	A priori estimates for the pinned measure	34
5	The two-point pinned probability measure	38
5.1	Restriction property of the pinned measure	38
5.2	Chordal explorations	41
5.3	Definition of the two-point pinned measure	43
5.4	Independence property of two-point pinned loops	47
6	Pinned loops and SLE excursions	49
6.1	Two-point pinned measure and SLE paths	49
6.2	Pinned measure and SLE excursion measure	55
7	Reconstructing a CLE from the pinned measure	57
7.1	The law of $\gamma(i)$	58
7.2	Several points	60
8	Relation to CLE_κ's	63
8.1	Background about $\text{SLE}(\kappa, \kappa - 6)$ processes	63
8.2	$\text{SLE}(\kappa, \kappa - 6)$ and Poisson point process of pinned loops	66

8.3	CLE and the SLE $(\kappa, \kappa - 6)$ exploration “tree”	67
Part two: construction via loop-soups		70
9	Loop-soup percolation	70
10	Relation between c and κ	77
11	Identifying the critical intensity c_0	80
11.1	Statement and comments	80
11.2	An intermediate way to measure the size of sets	81
11.3	Estimates for loop-soup clusters	84
12	An open problem	87

1 Introduction

1.1 General introduction

SLE and its conformal Markov property. Oded Schramm’s SLE processes introduced in [35] have deeply changed the way mathematicians and physicists understand critical phenomena in two dimensions. Recall that a chordal SLE is a random non-self-traversing curve in a simply connected domain, joining two prescribed boundary points of the domain. Modulo conformal invariance hypotheses that have been proved to hold in several cases, the scaling limit of an interface that appears in various two-dimensional models from statistical physics, when boundary conditions are chosen in a particular way, is one of these SLE curves. For instance, in the Ising model on a triangular lattice, if one connected arc d_+ of the boundary of a simply connected region D is forced to contain only $+$ spins whereas the complementary arc d_- contains only $-$ spins, then there is a random interface that separates the cluster of $+$ spins attached to d_+ from the cluster of $-$ spins attached to d_- ; this random curve has recently been proved by Chelkak and Smirnov to converge in distribution to an SLE curve (SLE_3) when one lets the mesh of the lattice go to zero (and chooses the critical temperature of the Ising model) [46, 7].

Note that SLE describes the law of one particular interface, not the joint law of all interfaces (we will come back to this issue later). On the other hand, for a given model, one expects all macroscopic interfaces to have similar geometric properties, i.e., to locally look like an SLE.

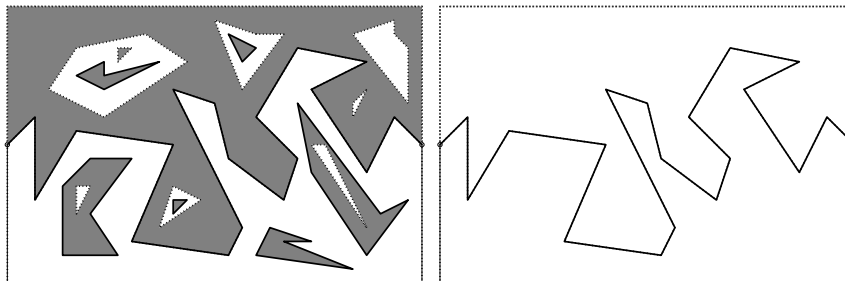

Figure 1: A coloring with good boundary conditions (black on one boundary arc, white on the complementary boundary arc) and the chordal interface (sketch)

The construction of SLE curves can be summarized as follows: The first observation, contained in Schramm’s original paper [35], is the “analysis” of the problem: Assuming that the two-dimensional models of statistical physics have a conformally invariant scaling limit, what can be said about the scaling limit of the interfaces? If one chooses the boundary conditions in a suitable way, one can identify a special interface that joins two boundary points (as in the Ising model mentioned above). Schramm argues that if this curve has a scaling limit, and if its law is conformally invariant, then it

should satisfy an “exploration” property in the scaling limit. This property, combined with conformal invariance, implies that it can be defined via iterations of independent random conformal maps. With the help of Loewner’s theory for slit mappings, this leads naturally to the definition of the (one parameter) family of SLE processes, which are random increasing families of compact sets (called Loewner chains), see [35] for more details. Recall that Loewner chains are constructed via continuous iterations of infinitesimal conformal perturbations of the identity, and they do not a priori necessarily correspond to actual planar curves.

A second step, essentially completed in [34], is to start from the definition of these SLE processes as random Loewner chains, and to prove that they indeed correspond to random two-dimensional curves. This constructs a one-parameter family of SLE random curves joining two boundary points of a domain, and the previous steps shows that if a random curve is conformally invariant (in distribution) and satisfies the exploration property, then it is necessarily one of these SLE curves.

One can study various properties of these random Loewner chains. For instance, one can compute critical exponents such as in [18, 19], determine their fractal dimension as in [34, 1], derive special properties of certain SLE’s – locality, restriction – as in [18, 21], relate them to discrete lattice models such as uniform spanning trees, percolation, the discrete Gaussian Free Field or the Ising model as in [20, 45, 46, 5, 38], or to the Gaussian Free Field and its variants as in [38, 10, 27, 28] etc. Indeed, at this point the literature is far too large for us to properly survey here. For conditions that ensure that discrete interfaces converge to SLE paths, see the recent contributions [12, 43].

Conformal Markov property for collections of loops. A natural question is how to describe the “entire” scaling limit of the lattice-based model, and not only that of one particular interface. In the present paper, we will answer the following question: Supposing that a discrete random system gives rise in its scaling limit to a conformally invariant collection of loops (i.e., interfaces) that remain disjoint (note that this is not always the case; we will comment on this later), what can these random conformally invariant collections of loops be?

More precisely, we will define and study random collections of loops that combine conformal invariance and a natural restriction property (motivated by the fact that the discrete analog of this property trivially holds for the discrete models we have in mind). We call such collections of loops Conformal Loop Ensembles (CLE). The two main results of the present paper can be summarized as follows:

- Theorem 1.1.**
- *For each CLE, there exists a value $\kappa \in (8/3, 4]$ such that with probability one, all loops of the CLE are SLE_κ -type loops.*
 - *Conversely, for each $\kappa \in (8/3, 4]$, there exists exactly one CLE with SLE_κ type loops.*

In fact, these statements will be derived via two almost independent steps, that involve different techniques:

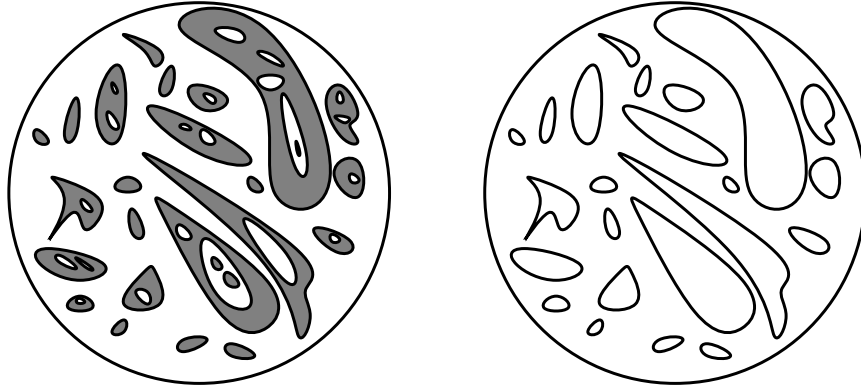

Figure 2: A coloring and the corresponding outermost loops (sketch)

1. We first derive the first of these two statements together with the uniqueness part of the second one. This will involve a detailed analysis of the CLE property, and consequences about possible ways to “explore” a CLE. Here, SLE techniques will be important.
2. We derive the existence part of the second statement using clusters of Poisson point processes of Brownian loops (the Brownian loop-soups).

In the end, we will have two remarkably different explicit constructions of these conformal loop ensembles CLE_κ for each κ in $(8/3, 4]$ (one based on SLE, one based on loop-soups). This is useful, since many properties that seem very mysterious from one perspective are easy from the other. For example, the (expectation) fractal dimensions of the individual loops and of the set of points not surrounded by any loop can be explicitly computed with SLE tools [40], while many monotonicity results and FKG-type correlation inequalities are immediate from the loop-soup construction [50]. One illustration of the interplay between these two approaches is already present in this paper: One can use SLE tools to determine exactly the value of the critical intensity that separates the two percolative phases of the Brownian loop-soup (and to our knowledge, this is the only self-similar percolation model where this critical value has been determined).

In order to try to explain the logical construction of the proof, let us outline these two parts separately in the following two subsections.

1.2 Main statements and outline: The Markovian construction

Let us now describe in more detail the results of the first part of the paper, corresponding to Sections 2 through 8. We are going to study random families $\Gamma = (\gamma_j, j \in J)$ of non-nested simple disjoint loops in simply connected domains. For each simply connected D , we let P_D denote the law of this loop-ensemble in D . We say that this family is

conformally invariant if for any two simply connected domains D and D' (that are not equal to the entire plane) and conformal transformation $\psi : D \rightarrow D'$, the image of P_D under ψ is $P_{D'}$.

We also make the following “local finiteness” assumption: if D is equal to the unit disc \mathbb{U} , then for any $\varepsilon > 0$, there are $P_{\mathbb{U}}$ almost surely only finitely many loops of radius larger than ε in Γ .

Consider two simply connected domains $D_1 \subset D_2$, and sample a family $(\gamma_j, j \in J)$ according to the law P_{D_2} in the larger domain D_2 . Then, we can subdivide the family $\Gamma = (\gamma_j, j \in J)$ into two parts: Those that do not stay in D_1 , and those that stay in D_1 (we call the latter $(\gamma_j, j \in J_1)$). Let us now define D_1^* to be the random set obtained when removing from the set D_1 all the loops of Γ that do not fully stay in D_1 , together with their interiors. We say that the family P_D **satisfies restriction** if, for any such D_1 and D_2 , the conditional law of $(\gamma_j, j \in J_1)$ given D_1^* is $P_{D_1^*}$ (or more precisely, it is the product of P_D for each connected component D of D_1^*). When a family is conformally invariant and satisfies restriction, we say that it is a Conformal Loop Ensemble (CLE). The goal of the paper is to characterize and construct all possible CLEs.

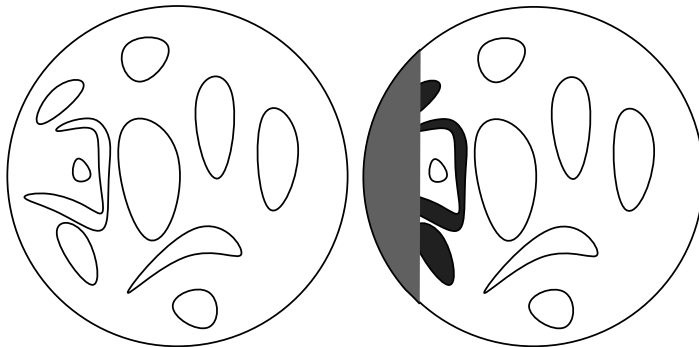

Figure 3: Restriction property (sketch): given the set of loops intersecting $D_2 \setminus D_1$ (the grey wedge on the left of the right figure) the conditional law of the remaining loops is an independent CLE in each component of the (interior of the) complement of this set.

By conformal invariance, it is sufficient to describe P_D for one given simply connected domain. Let us for instance consider D to be the upper half-plane \mathbb{H} . A first step in our analysis will be to prove that for all $z \in \mathbb{H}$, if Γ is a CLE, then the conditional law of the unique loop $\gamma(z) \in \Gamma$ that surrounds z , conditionally on the fact that $\gamma(z)$ intersects the ε -neighborhood of the origin, converges as $\varepsilon \rightarrow 0$ to a probability measure P^z on “pinned loops”, i.e., loops in \mathbb{H} that touch the real line only at the origin. We will derive various properties of P^z , which will eventually enable us to relate it to SLE. One simple way to describe this relation is as follows:

Theorem 1.2. *If Γ is a CLE, then the measure P^z exists for all $z \in \mathbb{H}$, and it is equal to the limit when $\varepsilon \rightarrow 0$ of the law of an SLE_κ from ε to 0 in \mathbb{H} conditioned*

to disconnect z from infinity in \mathbb{H} , for some $\kappa \in (8/3, 4]$ (we call this limit the SLE_κ bubble measure).

This shows that all the loops of a CLE are indeed in some sense “ SLE_κ loops” for some κ . In fact, the way in which P^z will be described (and in which this theorem will actually be proved) can be understood as follows (this will be the content of Proposition 4.1) in the case where $z = i$: Consider A the lowest point on $[0, i] \cap \gamma(i)$, and H the unbounded connected component of the domain obtained by removing from $\mathbb{H} \setminus [0, A]$ all the loops of the CLE that intersect $[0, A]$. Consider the conformal map Φ from H onto \mathbb{H} with $\Phi(i) = i$ and $\Phi(A) = 0$. Then, the law of $\Phi(\gamma(i))$ is exactly P^i .

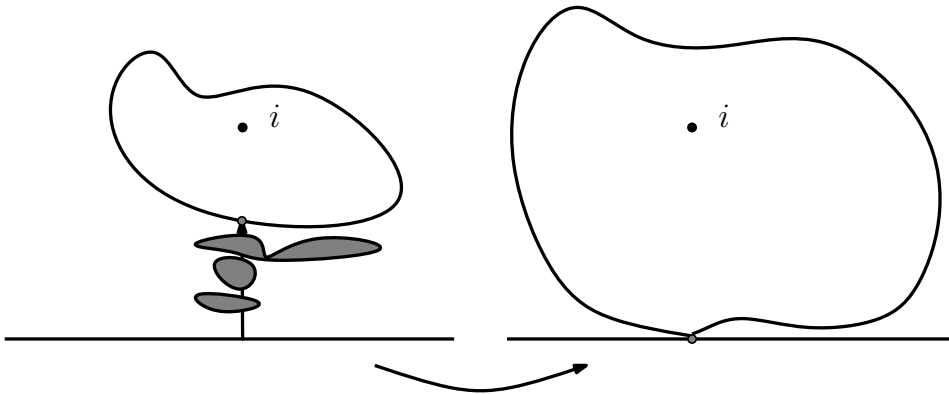

Figure 4: Description of P^i (sketch).

Theorem 1.2 raises the question of whether two different CLE distributions can correspond to the same measure P^z . We will prove that it is not possible, i.e., we will describe a way to reconstruct the law of the CLE out of the knowledge of P^z only, using a construction based on a Poisson point process of pinned loops:

Theorem 1.3. *For each $\kappa \in (8/3, 4]$, there exists at most one CLE such that P^z is the SLE_κ bubble measure.*

In a way, this reconstruction procedure can be interpreted as an “excursion theory” for CLEs. It will be very closely related to the decomposition of a Bessel process via its Poisson point process of excursions. In fact, this will enable us to relate our CLEs to the random loop ensembles defined in [43] using branching SLE processes, which we now briefly describe. Recall that when $\kappa \leq 4$, SLE_κ is a random simple curve from one marked boundary point a of a simply connected domain D to another boundary point b . If we now compare the law of an SLE from a to b in D with that of an SLE from a to b' in D when $b \neq b'$, then they clearly differ, and it is also immediate to check that the laws of their initial parts (i.e., the laws of the paths up to the first time they exit some fixed small neighborhood of a) are also not identical. We say that SLE_κ is not target-independent. However, a variant of $SLE(\kappa)$ called $SLE(\kappa, \kappa - 6)$ has been shown

by Schramm and Wilson [42] (see also [43]) to be target-independent. This makes it possible to couple such processes starting at a and aiming at two different points b and b' in such a way that they coincide until the first disconnection point. This in turn makes it possible to canonically define a conformally invariant “exploration tree” of SLE $(\kappa, \kappa - 6)$ processes rooted at a , and a collection of loops called Conformal Loop Ensembles in [43]. It is conjectured in [43] that this one-parameter collection of loops indeed corresponds to the scaling limit of a wide class of discrete lattice-based models, and that for each κ , the law of the constructed family of loops is independent of the starting point a .

The branching SLE $(\kappa, \kappa - 6)$ procedure works for any $\kappa \in (8/3, 8]$, but the obtained loops are simple and disjoint loops only when $\kappa \leq 4$. In this paper, we use the term CLE to refer to any collection of loops satisfying conformal invariance and restriction, while using the term CLE_κ to refer to the random collections of loops constructed in [43]. We shall prove the following:

Theorem 1.4. *Every CLE is in fact a CLE_κ for some $\kappa \in (8/3, 4]$.*

Let us stress that we have not yet proved at this point that the CLE_κ are themselves CLEs (and this was also not established in [43]) – nor that the law of CLE_κ is root-independent. In fact, it is not proved at this point that CLEs exist at all. All of this will follow from the second part.

1.3 Main statements and outline: The loop-soup construction

We now describe the content of Sections 9 to 11. The Brownian loop-soup, as defined in [23], is a Poissonian random countable collection of Brownian loops contained within a fixed simply-connected domain D . We will actually only need to consider the outer boundaries of the Brownian loops, so we will take the perspective that a loop-soup is a random countable collection of simple loops (outer boundaries of Brownian loops can be defined as $SLE_{8/3}$ loops, see [53]). Let us stress that our conformal loop ensembles are also random collections of simple loops, but that, unlike the loops of the Brownian loop-soup, the loops in a CLE are almost surely all disjoint from one another.

The loops of the *Brownian loop-soup* $\mathcal{L} = (\ell_j, j \in J)$ in the unit disk \mathbb{U} are the points of a Poisson point process with intensity $c\mu$, where c is an *intensity* constant, and μ is the *Brownian loop measure* in \mathbb{U} . The Brownian loop-soup measure $\mathbb{P} = \mathbb{P}_c$ is the law of this random collection \mathcal{L} .

When A and A' are two closed bounded subsets of a bounded domain D , we denote by $L(A, A'; D)$ the μ -mass of the set of loops that intersect both sets A and A' , and stay in D . When the distance between A and A' is positive, this mass is finite [23]. Similarly, for each fixed positive ϵ , the set of loops that stay in the bounded domain D and have diameter larger than ϵ , has finite mass for μ .

The conformal restriction property of the Brownian loop measure μ (which in fact characterizes the measure up to a multiplicative constant; see [53]) implies the following

two facts (which are essentially the only features of the Brownian loop-soup that we shall use in the present paper):

1. Conformal invariance: The measure \mathbb{P}_c is invariant under any Moebius transformation of the unit disc onto itself. This invariance makes it in fact possible to define the law \mathbb{P}_D of the loop-soup in any simply connected domain $D \neq \mathbb{C}$ as the law of the image of \mathcal{L} under any given conformal map Φ from \mathbb{U} onto D (because the law of this image does not depend on the actual choice of Φ).
2. Restriction: If one restricts a loop-soup in \mathbb{U} to those loops that stay in a simply connected domain $U \subset \mathbb{U}$, one gets a sample of \mathbb{P}_U .

We will work with the usual definition (i.e., the usual normalization) of the measure μ (as in [23] — note that there can be some confusion about a factor 2 in the definition, related to whether one keeps track of the orientation of the Brownian loops or not). Since we will be talking about some explicit values of c later, it is important to specify this normalization. For a direct definition of the measure μ in terms of Brownian loops, see [23].

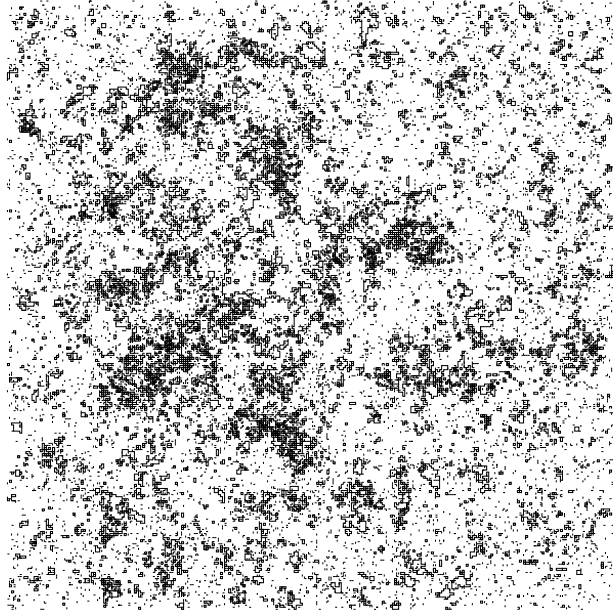

Figure 5: Sample of a random-walk loop-soup approximation [22] of a Brownian loop-soup in a square, by Serban Nacu

As mentioned above, [50] pointed out a way to relate Brownian loop-soups clusters to SLE-type loops: Two loops in \mathcal{L} are said to be adjacent if they intersect. Denote by $\mathcal{C}(\mathcal{L})$ the set of clusters of loops under this relation. For each element $C \in \mathcal{C}(\mathcal{L})$ write

\overline{C} for the closure of the union of all the loops in C and denote by $\overline{\mathcal{C}}$ the family of all \overline{C} 's.

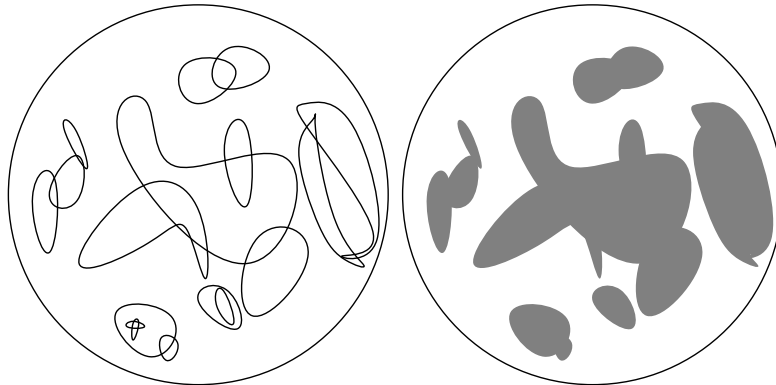

Figure 6: A loup-soup and the fillings of its outermost clusters (sketch)

We write $F(C)$ for the *filling* of C , i.e., for the complement of the unbounded connected component of $\mathbb{C} \setminus \overline{C}$. A cluster C is called *outermost* if there exists no C' such that $C \subset F(C')$. The *outer boundary* of such an outermost cluster C is the boundary of $F(C)$. Denote by Γ the set of outer boundaries of outermost clusters of \mathcal{L} .

Let us now state the main results of this second step:

Theorem 1.5. *Suppose that \mathcal{L} is the Brownian loop-soup with intensity c in \mathbb{U} .*

- *If $c \in (0, 1]$, then Γ is a random countable collection of disjoint simple loops that satisfies the conformal restriction axioms.*
- *If $c > 1$, then there is almost surely only one cluster in $\mathcal{C}(\mathcal{L})$.*

It therefore follows from our Markovian characterization that Γ is a CLE_κ (according to the branching $\text{SLE}(\kappa, \kappa - 6)$ based definition in [43]) for *some* $\kappa \in (8/3, 4]$. We will in fact also derive the following correspondence:

Theorem 1.6. *Fix $c \in (0, 1]$ and let \mathcal{L} be a Brownian loop-soup of intensity c on \mathbb{U} . Then Γ is a CLE_κ where $\kappa \in (8/3, 4]$ is determined by the relation $c = (3\kappa - 8)(6 - \kappa)/2\kappa$.*

1.4 Main statements and outline: Combining the two steps

Since every $\kappa \in (8/3, 4]$ is obtained for exactly one value of $c \in (0, 1]$ in Theorem 1.6, we immediately get thanks to Theorem 1.4 that the random simple loop configurations satisfying the conformal restriction axioms are precisely the CLE_κ where $\kappa \in (8/3, 4]$, which completes the proof of Theorem 1.1 and of the fact that the following three descriptions of simple loop ensembles are equivalent:

1. The random loop ensembles traced by branching Schramm-Loewner Evolution (SLE_κ) curves for κ in $(8/3, 4]$.
2. The outer-cluster-boundary ensembles of Brownian loop-soups for $c \leq 1$.
3. The (only) random loop ensembles satisfying the CLE axioms.

Let us now list some further consequences of these results. Recall from [1] that the Hausdorff dimension of an SLE_κ curve is almost surely $1 + (\kappa/8)$. Our results therefore imply that the boundary of a loop-soup cluster of intensity $c \leq 1$ has dimension

$$\frac{37 - c - \sqrt{25 + c^2 - 26c}}{24}.$$

Note that just as for Mandelbrot's conjecture for the dimension of Brownian boundaries [17], this statement does not involve SLE, but its proof does. In fact the result about the dimension of Brownian boundaries can be viewed as the limit when $c \rightarrow 0$ of this one.

Furthermore we may define the *carpet* of the CLE_κ to be the random closed set obtained by removing from \mathbb{U} the interiors (i.e. the bounded connected component of their complement) of all the loops γ of Γ , and recall that SLE methods allowed [40] to compute its "expectation dimension" in terms of κ . The present loop-soup construction of CLE_κ enables to prove (see [29]) that this expectation dimension is indeed equal to its almost sure Hausdorff dimension d , and that in terms of c ,

$$d(c) = \frac{187 - 7c + \sqrt{25 + c^2 - 26c}}{96} \tag{1}$$

The critical loop-soup (for $c = 1$) corresponds therefore to a carpet of dimension $15/8$.

Another direct consequence of the previous results is the "additivity property" of CLE's: If one considers two independent CLE's in the same simply connected domain D with non-empty boundary, and looks at the union of these two, then either one can find a cluster whose boundary contains ∂D , or the outer boundaries of the obtained outermost clusters in this union form another CLE. This is simply due to the fact that each of the CLE's can be constructed via Brownian loop soups (of some intensities c_1 and c_2) so that the union corresponds to a Brownian loop-soup of intensity $c_1 + c_2$. This gives for instance a clean direct geometric meaning to the general idea (present on various occasions in the physics literature) that relates in some way two independent copies of the Ising model to the Gaussian Free Field in their large scale limit: The outermost boundaries defined by the union of two independent CLE_3 's in a domain (recall [7] that CLE_3 is the scaling limit of the Ising model loops, and note that it corresponds to $c = 1/2$) form a CLE_4 (which corresponds to "outermost" level lines of the Gaussian Free Field, see [39, 10] and to $c = 1 = 1/2 + 1/2$).

1.5 Further background

In order to put our results in perspective, we briefly recall some closely related work on conformally invariant structures.

Continuous conformally invariant structures giving rise to loops. There exist several natural ways to construct conformally invariant structures in a domain D . We have already mentioned the Brownian loop-soup that will turn out be instrumental in the present paper when constructing explicitly CLEs. Another natural conformally invariant structure that we have also just mentioned is the Gaussian Free Field. This is a classical basic object in Field Theory. It has been shown (see [38, 10]) that it is very closely related to SLE processes, and that one can detect all kinds of SLEs within the Gaussian Free Field. In particular, this indicates that CLEs (at least when $\kappa = 4$) can in fact also be defined and found as “geometric” lines in a Gaussian Free Field.

Discrete models. A number of discrete lattice-based models have been conjectured to give rise to conformally invariant structures in the fine-mesh limit. For some of these models, these structures can be described by random collections of loops. We have already mentioned that Smirnov [45, 46, 47] has proved this conjecture for some important models (percolation, Ising model — see also [20, 37, 38] for some other cases). Those models that will be directly relevant to the present paper (i.e., with disjoint simple loops) include the Ising model and the discrete Gaussian Free Field level lines ([47, 7, 38, 10]). The scaling limits of percolation and of the FK-model related to the Ising model give rise to interfaces that are not disjoint. These are of course also very interesting objects (see [41, 5, 48] for the description of the percolation scaling limit), but they are not the subject of the present paper. Conjecturally, each of the CLEs that we will be describing corresponds to the scaling limit of one of the so-called $O(N)$ models, see e.g. [30, 13], which are one simple way to define discrete random collections of non-overlapping loops.

In fact, if one starts from a lattice-based model for which one controls the (conformally invariant) scaling limit of an observable (loosely speaking, the scaling limit of the probability of some event), it seems possible (see Smirnov [46]) to use this to actually prove the convergence of the entire discrete “branching” exploration procedure to the corresponding branching $SLE(\kappa, \kappa - 6)$ exploration tree. It is likely that it is not so much harder to derive the “full” scaling limit of all interfaces than to show the convergence of one particular interface to SLE.

Another quite different family of discrete models that might (more conjecturally) be related to the CLEs that we are studying here, are the “planar maps”, where one chooses at random a planar graph, defined modulo homeomorphisms, and that are conjecturally closely related to the above (for instance via their conjectured relation with the Gaussian Free Field). It could well be that CLEs are rather directly related to random planar maps chosen in a way to contain “large holes”, such as the ones that are studied in [24]. In fact, CLEs, planar maps and the Gaussian Free Field should all be related to each other via Liouville quantum gravity, as described in [11].

Conformal Field Theory. Note finally that Conformal Field Theory, as developed in the theoretical physics community since the early eighties [2], is also a setup to describe the scaling limits of all correlation functions of these critical two-dimensional lattice models. This indicates that a description of the entire scaling limit of the lattice models in geometric SLE-type terms could be useful in order to construct such fields. CLE-based constructions of Conformal Field Theoretical objects “in the bulk” can be found in Benjamin Doyon’s papers [8, 9]. It may also be mentioned that aspects of the present paper (infinite measures on “pinned configurations”) can be interpreted naturally in terms of insertions of boundary operators.

Part one: the Markovian characterization

2 The CLE property

2.1 Definitions

A **simple loop** in the complex plane will be the image of the unit circle in the plane under a continuous injective map (in other words we will identify two loops if one of them is obtained by a bijective reparametrization of the other one; note that our loops are not oriented). Note that a simple loop γ separates the plane into two connected components that we call its interior $\text{int}(\gamma)$ (the bounded one) and its exterior (the unbounded one) and that each one of these two sets characterizes the loop. There are various natural distances and σ -fields that one can use for the space \mathcal{L} of loops. We will use the σ -field Σ generated by all the events of the type $\{O \subset \text{int}(\gamma)\}$ when O spans the set of open sets in the unit plane. Note that this σ -field is also generated by the events of the type $\{x \in \text{int}(\gamma)\}$ where x spans a countable dense subset Q of the plane (recall that we are considering simple loops so that $O \subset \text{int}(\gamma)$ as soon as $O \cap Q \subset \text{int}(\gamma)$).

In the present paper, we will consider (at most countable) collections $\Gamma = (\gamma_j, j \in J)$ of simple loops. One way to properly define such a collection is to identify it with the point-measure

$$\mu_\Gamma = \sum_{j \in J} \delta_{\gamma_j}.$$

Note that this space of collections of loops is naturally equipped with the σ -field generated by the sets $\{\Gamma : \#(\Gamma \cap A) = k\} = \{\Gamma : \mu_\Gamma(A) = k\}$, where $A \in \Sigma$ and $k \geq 0$.

We will say that $(\gamma_j, j \in J)$ is a **simple loop configuration** in the bounded simply connected domain D if the following conditions hold:

- For each $j \in J$, the loop γ_j is a simple loop in D .
- For each $j \neq j' \in J$, the loops γ_j and $\gamma_{j'}$ are disjoint.
- For each $j \neq j' \in J$, γ_j is not in the interior of $\gamma_{j'}$: The loops are not nested.
- For each $\varepsilon > 0$, only finitely many loops γ_j have a diameter greater than ε . We call this the **local finiteness** condition.

All these conditions are clearly measurable with respect to the σ -field discussed above.

We are going to study random simple loop configurations with some special properties. More precisely, we will say that the random simple loop configuration $\Gamma = (\gamma_j, j \in J)$ in the unit disc \mathbb{U} is a **Conformal Loop Ensemble** (CLE) if it satisfies the following properties:

- Non-triviality: The probability that $J \neq \emptyset$ is positive.
- Conformal invariance: The law of Γ is invariant under any conformal transformation from \mathbb{U} onto itself. This invariance makes it in fact possible to define the law of the loop-ensemble Γ_D in any simply connected domain $D \neq \mathbb{C}$ as the law of the image of Γ under any given conformal map Φ from \mathbb{U} onto D (this is because the law of this image does not depend on the actual choice of Φ). We can also define the law of a loop-ensemble in any open domain $D \neq \mathbb{C}$ that is the union of disjoint open simply connected sets by taking independent loop-ensembles in each of the connected components of D . We call this law P_D .
- Restriction: To state this important property, we need to introduce some notation. Suppose that U is a simply connected subset of the unit disc. Define

$$I = I(\Gamma, U) = \{j \in J : \gamma_j \not\subset U\}$$

and $J^* = J^*(\Gamma, U) = J \setminus I = \{j \in J : \gamma_j \subset U\}$. Define the (random) set

$$U^* = U^*(U, \Gamma) = U \setminus \bigcup_{j \in I} \overline{\text{int}(\gamma_j)}.$$

This set U^* is a (not necessarily simply connected) open subset of \mathbb{U} (because of the local finiteness condition). The restriction property is that (for all U), the conditional law of $(\gamma_j, j \in J^*)$ given U^* (or alternatively given the family $(\gamma_j, j \in I)$) is P_{U^*} .

This definition is motivated by the fact that for many discrete loop-models that are conjectured to be conformally invariant in the scaling limit, the discrete analog of this restriction property holds. Examples include the $O(N)$ models (and in particular the critical Ising model interfaces). The goal of the paper is to classify all possible CLEs, and therefore the possible conformally invariant scaling limits of such loop-models.

The non-nesting property can seem surprising since the discrete models allow nested loops. The CLE in fact describes (when the domain D is fixed) the conjectural scaling limit of the law of the “outermost loops” (those that are not surrounded by any other one). In the discrete models, one can discover them “from the outside” in such a way that the conditional law of the remaining loops given the outermost loops is just made of independent copies of the model in the interior of each of the discovered loops. Hence, the conjectural scaling limit of the full family of loops is obtained by iteratively defining CLEs inside each loop.

At first sight, the restriction property does not look that restrictive. In particular, as it involves only interaction between entire loops, it may seem weaker than the conformal exploration property of SLE (or of branching SLE($\kappa, \kappa - 6$)), that describes the way in which the path is progressively constructed. However (and this is the content of Theorems 1.2 and 1.3), the family of such CLEs is one-dimensional too, parameterized by $\kappa \in (8/3, 4]$.

2.2 Simple properties of CLEs

We now list some simple consequences of the CLE definition. Suppose that $\Gamma = (\gamma_j, j \in J)$ is a CLE in \mathbb{U} .

1. Then, for any given $z \in \mathbb{U}$, there almost surely exists a loop γ_j in Γ such that $z \in \text{int}(\gamma_j)$. Here is a short proof of this fact: Define $u = u(z)$ to be the probability that z is in the interior of some loop in Γ . By Moebius invariance, this quantity u does not depend on z . Furthermore, since $P(J \neq \emptyset) > 0$, it follows that $u > 0$ (otherwise the expected area of the union of all interiors of loops would be zero). Hence, there exists $r \in (0, 1)$ such that with a positive probability p , the origin is in the interior of some loop in Γ that intersects the slit $[r, 1]$ (we call A this event). We now define $U = \mathbb{U} \setminus [r, 1]$ and apply the restriction property. If A holds, then the origin is in the interior of some loop of Γ . If A does not hold, then the origin is in one of the connected components of \tilde{U} and the conditional probability that it is surrounded by a loop in this domain is therefore still u . Hence, $u = p + (1 - p)u$ so that $u = 1$.
2. The previous observation implies immediately that J is almost surely infinite. Indeed, almost surely, all the points $1 - 1/n, n \geq 1$ are surrounded by a loop, and any given loop can only surround finitely many of these points (because it is at positive distance from $\partial\mathbb{U}$).
3. Let $M(\theta)$ denote the set of configurations $\Gamma = (\gamma_j, j \in J)$ such that for all $j \in J$, the radius $[0, e^{i\theta}]$ is never locally “touched without crossing” by γ_j (in other words, θ is a local extremum of none of the $\arg(\gamma_j)$ ’s). Then, for each given θ , Γ is almost surely in $M(\theta)$. Indeed, the argument of a given loop that does not pass through the origin can anyway at most have countably many “local maxima”, and there are also countably many loops. Hence, the set of θ ’s such that $\Gamma \notin M(\theta)$ is at most countable. But the law of the CLE is invariant under rotations, so that $P(\Gamma \in M(\theta))$ does not depend on θ . Since its mean value (for $\theta \in [0, 2\pi]$) is 1, it is always equal to 1.

If we now define, for all $r > 0$, the Moebius transformation of the unit disc such that $\psi(1) = 1$, $\psi(-1) = -1$ and $\psi'(1) = r$, the invariance of the CLE law under ψ shows that for each given r , almost surely, no loop of the CLE locally touches $\psi([-i, i])$ without crossing it.

4. For any $r < 1$, the probability that $r\mathbb{U}$ is entirely contained in the interior of one single loop is positive: This is because each simple loop γ that surrounds the origin can be approximated “from the outside” by a loop η on a grid of rational meshsize with as much precision as one wants. This implies in particular that one can find one such loop η in such a way that the image of one loop γ in the CLE under a conformal map from $\text{int}(\eta)$ onto \mathbb{U} that preserves the origin has an interior containing $r\mathbb{U}$. Hence, if we apply the restriction property to $U = \text{int}(\eta)$,

we get readily that with positive probability, the interior of some loop in the CLE contains $r\mathbb{U}$. Since this property will not be directly used nor needed later in the paper, we leave the details of the proof to the reader.

5. The restriction property continues to hold if we replace the simply connected domain $U \subset \mathbb{U}$ with the union U of countably many disjoint simply connected domains $U_i \subset \mathbb{U}$. That is, we still have that the conditional law of $(\gamma_j, j \in J^*)$ given U^* (or alternatively given the family $(\gamma_j, j \in I)$) is P_{U^*} . To see this, note first that applying the property separately for each U_i gives us the marginal conditional laws for the set of loops within each of the U_i . Then, observe that the conditional law of the set of loops in U_i is unchanged when one further conditions on the set of loops in $\cup_{i' \neq i} U_{i'}$. Hence, the sets of loops in the domains $U_1^*, \dots, U_i^*, \dots$ are in fact independent (conditionally on $(\gamma_j, j \in I)$).

3 Explorations

3.1 Exploring CLEs – heuristics

Suppose that $\Gamma = (\gamma_j, j \in J)$ is a CLE in the unit disc \mathbb{U} . Suppose that $\varepsilon > 0$ is given. Cut out from the disc a little given shape $S = S(\varepsilon) \subset \mathbb{U}$ of radius ε around 1. If y is a point on the unit circle, then we may write yS for y times the set S — i.e., S rotated around the circle via multiplication by y . The precise shape of S will not be so important; for concreteness, we may at this point think of S as being equal to the ε -neighborhood of 1 in the unit disc. Let U_1 denote the connected component that contains the origin of the set obtained when removing from $U'_1 := \mathbb{U} \setminus S$ all the loops that do not stay in U'_1 . If the loop γ_0 in the CLE that surrounds the origin did not go out of $\mathbb{U} \setminus S$, then the (conditional) law of the CLE restricted to U_1 (given the knowledge of U_1) is again a CLE in this domain (this is just the CLE restriction property). We then define the conformal map Φ_1 from U_1 onto \mathbb{U} with $\Phi_1(0) = 0$ and $\Phi'_1(0) > 0$.

Now we again explore a little piece of U_1 : we choose some point y_1 on the unit circle and define U'_2 to be the domain obtained when removing from U_1 the preimage (under Φ_1) of the shape S centered around y_1 (i.e., $U'_2 = \Phi_1^{-1}(\mathbb{U} \setminus y_1S)$). Again, we define the connected component U_2 that contains the origin of the domain obtained when removing from U'_2 the loops that do not stay in U'_2 and the conformal map Φ_2 from U_2 onto \mathbb{U} normalized at the origin.

We then explore in U_2 if $\gamma_0 \subset U_2$, and so on. One can iterate this procedure until we finally “discover” the loop γ_0 that surrounds the origin. Clearly, this will happen after finitely many steps with probability one, because at each step the derivative $\Phi'_n(0)$ is multiplied by a quantity that is bounded from below by a constant $v > 1$ (this is because at each step, one composes Φ_n with a conformal map corresponding to the removal of at least a shape y_nS in order to define Φ_{n+1}). Hence, if we never discovered γ_0 , it would follow from Koebe’s 1/4-Theorem that $d(\partial U_n, 0) \rightarrow 0$ as $n \rightarrow \infty$, and this

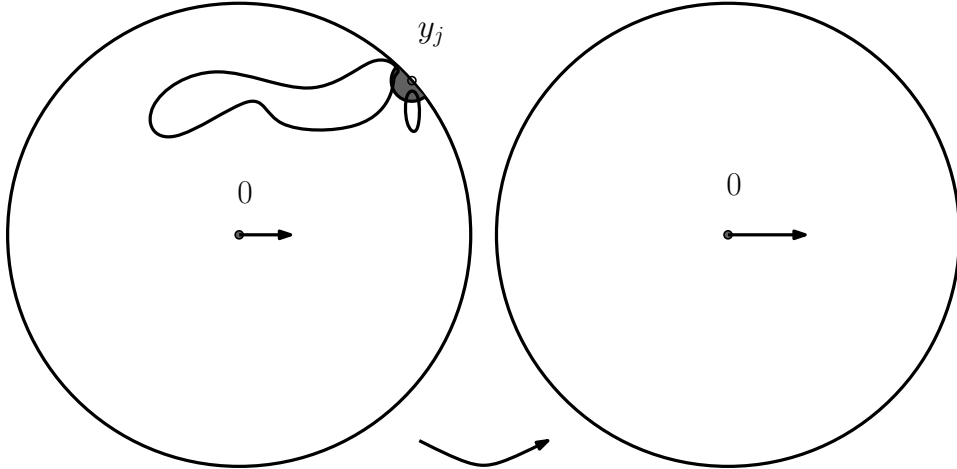

Figure 7: The first exploration step (sketch)

would contradict the fact that γ_0 is almost surely at positive distance from 0.

We call N the random finite step after which the loop γ_0 is discovered i.e., such that $\gamma_0 \subset U_N$ but $\gamma_0 \not\subset U'_{N+1}$. It is important to notice that at each step until N , one is in fact repeating the same experiment (up to a conformal transformation), namely cutting out the shape S from \mathbb{U} and then cutting out all loops that intersect S . Because of the CLE's conformal restriction property, this procedure defines an i.i.d. sequence of steps, stopped at the geometric random variable N , which is the first step at which one discovers a loop surrounding the origin that intersects $\mathbb{U} \setminus y_N S$. This shows also that the conditional law of the CLE in \mathbb{U} given the fact that $\gamma_0 \cap S \neq \emptyset$ is in fact identical to the image under $y_N^{-1} \Phi_N$ of the CLE in U_N .

In the coming sections, we will use various sequences $y_n = y_n(\varepsilon)$. One natural possibility is to simply always choose $y_n = 1$. This will give rise to the ε radial-explorations that will be discussed in Section 4. However, we first need another procedure to choose $y_n(\varepsilon)$ that will enable to control the behavior of $\Phi_{N(\varepsilon)}$, of $U_{N(\varepsilon)}$ and of $y_{N(\varepsilon)}$ as ε tends to 0. This will then allow us show that the conditional law of the CLE in \mathbb{U} given the fact that $\gamma_0 \cap S(\varepsilon) \neq \emptyset$ has a limit when $\varepsilon \rightarrow 0$.

3.2 Discovering the loops that intersect a given set

The precise shape of the sets S that we will use will in fact not be really important, as long as they are close to small semi-discs. It will be convenient to define, for each y on the unit circle, the set $D(y, \varepsilon)$ to be the image of the set $\{z \in \mathbb{H} : |z| \leq \varepsilon\}$, under the conformal map $\Psi : z \mapsto y(i - z)/(i + z)$ from the upper half-plane \mathbb{H} onto the unit disc such that $\Psi(i) = 0$ and $\Psi(0) = y$. Note that $|\Psi'(0)| = 2$, so that when ε is very small, the set $D(y, \varepsilon)$ is close to the intersection of a small disc of radius 2ε around y with the unit disc. This set $D(1, \varepsilon)$ will play the role of our set $S(\varepsilon)$.

Suppose that $\Gamma = (\gamma_j, j \in J)$ is a given (deterministic) simple loop-configuration in \mathbb{U} . (In this section, we will derive deterministic statements that we will apply to CLEs in the next section.) We suppose that:

1. In Γ , one loop (that we call γ_0) has 0 in its interior.
2. $A \subset \overline{\mathbb{U}}$ is a given closed simply connected set such that $\mathbb{U} \setminus A$ is simply connected, A is the closure of the interior of A , and the length of $\partial A \cap \partial \mathbb{U}$ is positive.
3. The loop γ_0 does not intersect A .
4. All γ_j 's in Γ that intersect ∂A also intersect the interior of A .

Our goal will be to explore almost all (when ε is small) large loops of Γ that intersect A by iterating explorations of ε -discs.

When $\varepsilon > 0$ is given, it will be useful to have general criteria that imply that a subset V of the unit disc contains $D(y, \varepsilon)$ for at least one $y \in \mathbb{U}$: Consider two independent Brownian motions, B^1 and B^2 started from the origin, and stopped at their first hitting times T_1 and T_2 of the unit circle. Consider U^a and U^b the two connected components of $\mathbb{U} \setminus (B^1[0, T_1] \cup B^2[0, T_2])$ that have an arc of $\partial \mathbb{U}$ on their boundary. Note that for small enough ε , the probability $p(\varepsilon)$ that both U^a and U^b contain some $D(y, \varepsilon)$ is clearly close to 1.

Suppose now that V is a closed subset of \mathbb{U} such that $\mathbb{U} \setminus V$ is simply connected, and let $u(V)$ be the probability that one of the two random sets U^a or U^b is a subset of V . Then:

Lemma 3.1. *For all $u > 0$, there exists a positive $\varepsilon_0 = \varepsilon_0(u)$ such that there exists $y \in \partial \mathbb{U}$ with $D(y, \varepsilon) \subset V$ as soon as $u(V) \geq u$.*

Proof. The definition of $p(\varepsilon)$ and of $u(V)$ shows that V contains some $D(y, \varepsilon)$ with a probability at least $u - (1 - p(\varepsilon))$. Since this is a deterministic fact about V , we conclude that the set V does indeed contain some set $D(y, \varepsilon)$ for some $y \in \partial \mathbb{U}$ as soon as $p(\varepsilon) \geq 1 - u/2$. It therefore suffices to choose ε_0 in such a way that $u_0 = 2(1 - p(\varepsilon_0))$. \square

Define now a particular class of iterative exploration procedures as follows: Let $U_0 = \mathbb{U}$ and $\Phi_0(z) = z$. For $j \geq 0$:

- Choose some y_j on $\partial \mathbb{U}$ in such a way that $\Phi_j^{-1}(D(y_j, \varepsilon)) \subset A$.
- Define U_{j+1} as the connected component that contains the origin of the set obtained by removing from $U'_j := U_j \setminus \Phi_j^{-1}(D(y_j, \varepsilon))$ all the loops in Γ that do not stay in U'_j .
- Let Φ_{j+1} be the conformal map from U_{j+1} onto \mathbb{U} such that $\Phi_{j+1}(0) = 0$ and $\Phi'_{j+1}(0) > 0$.

There is only one way in which such an iterative definition can be brought to an end, namely if at some step N_0 , it is not possible anymore to find a point y on $\partial\mathbb{U}$ such that $\Phi_{N_0}^{-1}(D(y, \varepsilon)) \subset A$ (otherwise it means that at some step N , one actually has discovered the loop γ_0 , so that U_{N+1} is not well-defined but we know that this cannot be the case because we have assumed that $\gamma_0 \cap A = \emptyset$). Such explorations $(\Phi_n, n \leq N_0)$ will be called ε -admissible explorations of the pair (Γ, A) .

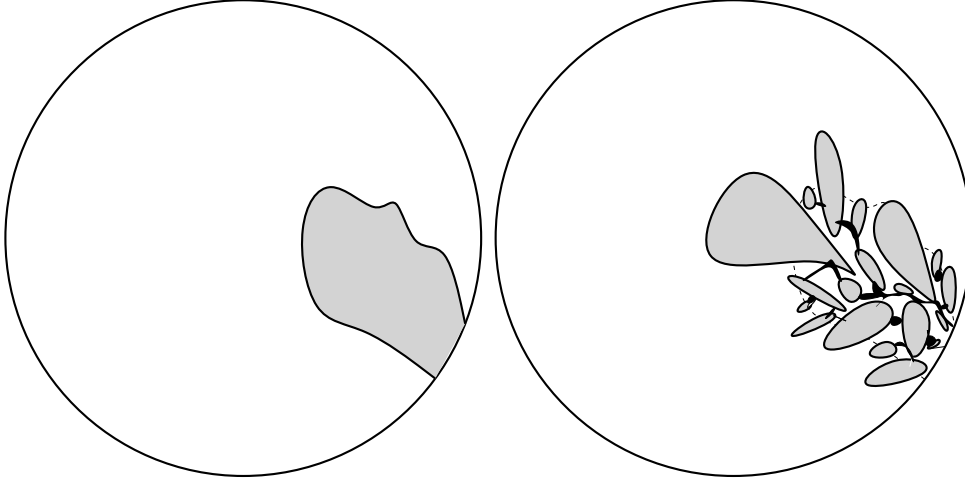

Figure 8: A domain A , sketch of a completed ε -admissible exploration of (Γ, A)

Our goal is to show that when ε gets smaller, the set U_{N_0} is close to \tilde{U} , where \tilde{U} is the connected component containing the origin of $U \setminus \cup_{i \in I(U)} \gamma_i$ (here $U = \mathbb{U} \setminus A$).

The local finiteness condition implies that the boundary of \tilde{U} consists of points that are either on ∂U or on some loop γ_j (in this case, we say that this loop γ_j contributes to this boundary).

Lemma 3.2. *For every $\alpha > 0$, there exists $\varepsilon'_0 = \varepsilon'_0(\Gamma, \alpha, A)$ such that for all $\varepsilon \leq \varepsilon'_0$, every loop of diameter greater than α that contributes to $\partial\tilde{U}$ is discovered by any ε -admissible exploration of (Γ, A) .*

Proof. Suppose now that γ_j is a loop in Γ that contributes to the boundary of \tilde{U} . Our assumptions on Γ and A ensure that γ_j therefore intersects both the interior of A and $\mathbb{U} \setminus A$. This implies that we can define three discs d_1 , d_2 and d_3 in the interior of γ_j such that $d_1 \subset \mathbb{U} \setminus A$, and $\overline{d_2} \subset d_3 \subset A$.

Suppose that for some $n \leq N_0$, this loop γ_j has not yet been discovered at step n . Since $\gamma_j \cap \partial\tilde{U} \neq \emptyset$ and $\tilde{U} \subset U_n$, we see that $\gamma_j \subset U_n$. Since this loop has a positive diameter, and since Γ is locally finite, we can conclude that with a positive probability u that depends on $(\Gamma, A, \gamma_j, d_1, d_2, d_3)$, two Brownian motions B^1 and B^2 started from the origin behave as follows:

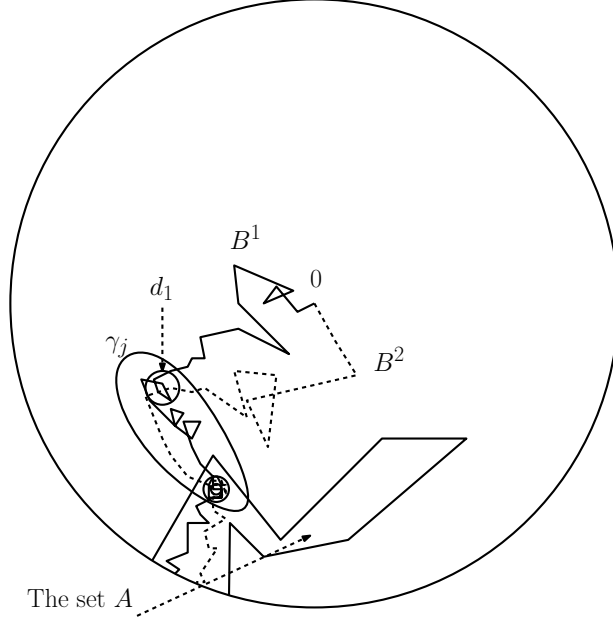

Figure 9: The loop γ_j , the three discs and the Brownian motions (sketch)

- They both enter d_1 without hitting A or ∂U or any of the other loops γ_i for $i \in I(U)$.
- They both subsequently enter d_2 without going out of $\text{int}(\gamma_j)$.
- They both subsequently disconnect d_2 from the boundary of d_3 before hitting it. (This in particular guarantees that the curves hit one another within the annulus $d_3 \setminus d_2$.)
- They both subsequently hit ∂U without going out of A .

This shows that one of the sets U^a and U^b as defined before Lemma 3.1 is contained in A with probability at least u . In fact, if we stop the two Brownian motions at their first exit of U_n instead on the hitting time of ∂U , the same phenomenon will hold: One of the two sets U_n^a and U_n^b (with obvious notation) will be contained in $U_n \cap A$ with probability at least u . By conformal invariance of planar Brownian motion, if we apply Lemma 3.1 to the conformal images of these two Brownian motions under Φ_n , we get that if ε is chosen to be sufficiently small, then it is always possible to find an ε -admissible point y_{n+1} . Hence, $N_0 > n$, i.e. n is not the final step of the exploration.

As a consequence, we see that the loop γ_j is certainly discovered before N_0 , i.e., that $\gamma_j \subset U \setminus U_{N_0}$, for all $\varepsilon \leq \varepsilon'_0(\gamma_j, \Gamma, A)$. The lemma follows because for each positive α , there are only finitely many loops of diameter greater than α in Γ . \square

Loosely speaking, this lemma tells us that indeed, U_{N_0} converges to \tilde{U} as $\varepsilon \rightarrow 0$. We now make this statement more precise, in terms of the conformal maps Φ_{N_0} and $\tilde{\Phi}$,

where $\tilde{\Phi}$ denotes the conformal map from \tilde{U} onto \mathbb{U} with $\tilde{\Phi}(0) = 0$ and $\tilde{\Phi}'(0) > 0$. Let us first note that $\tilde{U} \subset U_{N_0}$ because the construction of U_{N_0} implies that before N_0 one can only discover loops that intersect A .

Let us now consider a two-dimensional Brownian motion B started from the origin, and define T (respectively \tilde{T}) the first time at which it exits U (resp. \tilde{U}). Let us make a fifth assumption on A and Γ :

- 5. Almost surely, $B_T \in \partial\mathbb{U} \cup (\cup_j \text{int}(\gamma_j))$.

Note that this is indeed almost surely the case for a CLE (because Γ is then independent of B_T so that B_T is a.s. in the interior of some loop if it is not on $\partial\mathbb{U}$). This assumption implies that almost surely, either $\tilde{T} < T$ (and $B_{\tilde{T}}$ is on the boundary of some loop of positive diameter) or $B_T = B_{\tilde{T}} \in \partial\mathbb{U}$. The previous result shows that if \hat{T} denotes the exit time of U_{N_0} (for some given ε -admissible exploration), then $\hat{T} = \tilde{T}$ for all small enough ε .

It therefore follows that Φ_{N_0} converges to $\tilde{\Phi}$ in the sense that for all proper compact subsets K of \mathbb{U} , the functions $\Phi_{N_0}^{-1}$ converge uniformly to $\tilde{\Phi}^{-1}$ in K as $\varepsilon \rightarrow 0$. We shall use this notion of convergence on various occasions throughout the paper. Note that this it corresponds to the convergence with respect to a distance d , for instance

$$d(\varphi_1, \varphi_2) = \sum_{n \geq 1} 2^{-n} \max_{|z| \leq 1-1/n} \|\varphi_1^{-1}(z) - \varphi_2^{-1}(z)\|.$$

We have therefore shown that:

Lemma 3.3. *For each given loop configuration and A (satisfying conditions 1-5), $d(\Phi_{N_0}, \tilde{\Phi})$ tends to 0 as $\varepsilon \rightarrow 0$, uniformly with respect to all ε -admissible explorations of (Γ, A) .*

Suppose now that γ_0 intersects the interior of A . Exactly the same arguments show that there exists $\varepsilon_1 = \varepsilon(\Gamma, A)$ such that for all “ ε -admissible choices” of the y_j ’s for $\varepsilon \leq \varepsilon_1$, one discovers γ_0 during the exploration (and this exploration is then stopped in this way).

3.3 Discovering random configurations along some given line

For each small δ , we define the wedge $W_\delta = \{ue^{i\theta} : u \in (0, 1) \text{ and } |\theta| \leq \delta\}$. For each positive r , let \tilde{W}_r denote the image of the positive half disc $\{z \in \mathbb{U} : \text{Re}(z) > 0\}$ under the Moebius transformation of the unit disc with $\psi(1) = 1$, $\psi(-1) = -1$ and $\psi'(1) = r$. Note that $r \mapsto \tilde{W}_r$ is continuously increasing on $(0, 1]$ from $\tilde{W}_{0+} = \{1\}$ to the positive half-disc \tilde{W}_1 . For all non-negative integer $k \leq 1/\delta$, we then define

$$A^{\delta, k} = W_\delta \cap \tilde{W}_{k\delta}.$$

Suppose that δ is fixed, and that Γ is a loop-configuration satisfying conditions 1-5 for all set $A^{\delta,k}$ for $k \leq K$, where

$$K = K(\Gamma, \delta) = \max\{k : \gamma_0 \cap A_k^\delta = \emptyset\}.$$

We are going to define the conformal maps $\tilde{\Phi}^{\delta,1}, \dots, \tilde{\Phi}^{\delta,K}$ corresponding to the conformal map $\tilde{\Phi}$ when A is respectively equal to $A^{\delta,1}, \dots, A^{\delta,K}$.

For each given δ and ε , it is possible to define an ε -admissible chain of explorations of Γ and $A^{\delta,1}, A^{\delta,2}, \dots$ as follows: Let us first start with an ε -admissible exploration of $(\Gamma, A^{\delta,1})$. If $K \geq 1$, then such an exploration does not encounter γ_0 , and we then continue to explore until we get an ε -admissible exploration of $(\Gamma, A^{\delta,2})$, and so on, until the last value K' of k for which the exploration of $(\Gamma, A^{\delta,k})$ fails to discover γ_0 . In this way, we define conformal maps

$$\tilde{\Phi}_\varepsilon^{\delta,1}, \dots, \tilde{\Phi}_\varepsilon^{\delta,K'}$$

corresponding to the sets discovered at each of these K' explorations. Note that $K' \geq K$. One can then also start to explore the set $A^{\delta,K'+1}$ until one actually discovers the loop γ_0 .

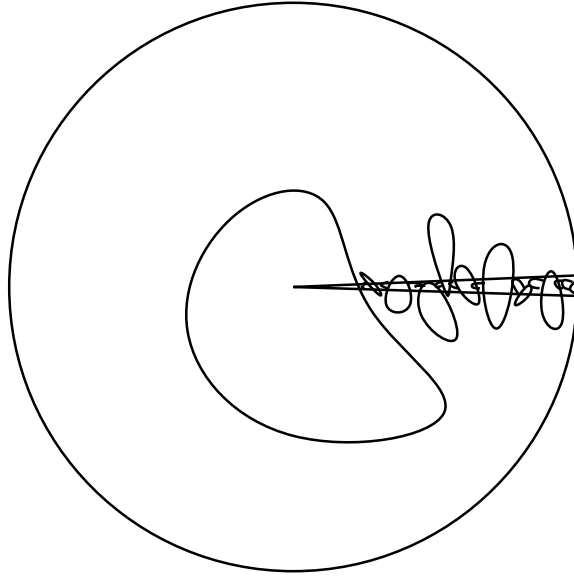

Figure 10: An exploration-chain and γ_0 (sketch)

This procedure therefore defines a single ε -admissible exploration (via some sequence (Φ_n, y_n)), that explores the sets $A^{\delta,j}$'s in an ordered way, and finally stops at some step N , i.e., the last step before one actually discovers γ_0 . We call this an ε -admissible exploration chain of $A^{\delta,1}, A^{\delta,2}, \dots$. Our previous results show that uniformly over all such ε -admissible exploration-chains (for each given Γ and δ):

- $K' = K$ for all sufficiently small ε .

- $\lim_{\varepsilon \rightarrow 0} (\tilde{\Phi}_\varepsilon^{\delta,1}, \dots, \tilde{\Phi}_\varepsilon^{\delta,K'}) = (\tilde{\Phi}^{\delta,1}, \dots, \tilde{\Phi}^{\delta,K})$.

We now suppose that Γ is a *random* loop-configuration. Then, for each δ , $K = K(\Gamma, \delta)$ is random. We assume that for each given δ , the conditions 1-5 hold almost surely for each of the K sets $A_1^\delta, \dots, A_K^\delta$. The previous results therefore hold almost surely; this implies for instance that for each $\eta > 0$, there exists $\varepsilon_2(\delta)$ such that for all such ε -admissible exploration-chain of $(\Gamma, A_1^\delta, A_2^\delta, \dots)$ with $\varepsilon \leq \varepsilon_2(\delta)$,

$$P(K' = K \text{ and } d(\tilde{\Phi}_\varepsilon^{\delta,K}, \tilde{\Phi}^{\delta,K}) < \eta) \geq 1 - \eta.$$

We will now wish to let δ go to 0 (simultaneously with ε , taking $\varepsilon(\delta)$ sufficiently small) so that we will (up to small errors that disappear as ε and δ vanish) just explore the loops that intersect the segment $[0, 1]$ “from 1 to 0” up to the first point at which it meets γ_0 . We therefore define

$$R = \max\{r \in [0, 1], r \in \gamma_0\}.$$

We define the open set \hat{U} as the connected component containing the origin of the set obtained by removing from $\mathbb{U} \setminus [R, 1]$ all the loops that intersect $(R, 1]$. Note that $\gamma_0 \subset \hat{U} \cup \{R\}$. We let $\hat{\Phi}$ denote the conformal map from \hat{U} onto \mathbb{U} such that $\hat{\Phi}(0) = 0$ and $\hat{\Phi}'(0) > 0$. We also define $\hat{y} = \hat{\Phi}(R)$.

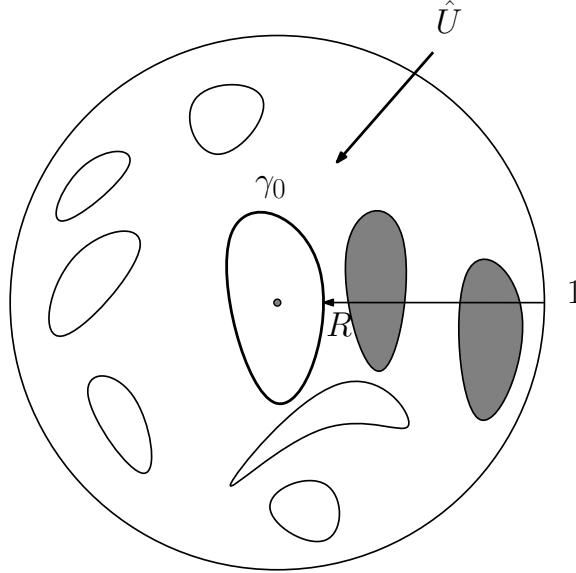

Figure 11: Exploring up to γ_0 (sketch)

Proposition 3.4. *For a well-chosen function $\varepsilon_3 = \varepsilon_3(\delta)$ (that depends on the law of Γ only), for any choice of $\varepsilon(\delta)$ -admissible exploration-chain of the random loop-configuration Γ and $A^{\delta,1}, \dots$ with $\varepsilon(\delta) \leq \varepsilon_3(\delta)$, the random pair (Φ_N, y_N) converges almost surely to the pair $(\hat{\Phi}, \hat{y})$ as $\delta \rightarrow 0$.*

Proof. Note first that our assumptions on Γ imply that almost surely $\Phi^{\delta,K} \rightarrow \hat{\Phi}$ as $\delta \rightarrow 0$ (this is a statement about Γ that does not involve explorations).

We know that γ_0 intersects $A^{\delta,K+1} \setminus A^{\delta,K}$. The local finiteness of Γ and the fact that any two loops are disjoint therefore implies that the diameter of the second largest loop (after γ_0) of Γ that intersects this set almost surely tends to 0 as $\delta \rightarrow 0$. This in particular implies that almost surely, the distance between Φ_N and $\tilde{\Phi}_\varepsilon^{\delta,K}$ tends to 0 as $\delta \rightarrow 0$ (uniformly with respect to the choice of the exploration, as long as $\varepsilon(\delta)$ tends to 0 sufficiently fast).

Recall finally that for each given δ , $\tilde{\Phi}_\varepsilon^{\delta,K} \rightarrow \Phi^{\delta,K}$ as $\varepsilon \rightarrow 0$. Hence, if $\varepsilon(\delta)$ is chosen small enough, the map Φ_N indeed converges almost surely to $\hat{\Phi}$ as $\delta \rightarrow 0$.

It now remains to show that $y_N \rightarrow \hat{y}$. Note that $R \in U_N$ (because at that step, γ_0 has not yet been discovered), that $R \in A^{\delta,K'+1} \setminus A^{\delta,K'}$ (with high probability, if $\varepsilon(\delta)$ is chosen to be small enough). On the other hand, the definition of the exploration procedure and of K' shows that

$$\Phi_N^{-1}(D(y_N, \varepsilon)) \cap (A^{\delta,K'+1} \setminus A^{\delta,K'}) \neq \emptyset$$

so that if we choose $\varepsilon(\delta)$ small enough, then the Euclidean distance between $\Phi_N^{-1}(D(y_N, \varepsilon))$ and R tends to 0 almost surely.

Let us look at the situation at step N : The loop $\Phi_N(\gamma_0)$ in the unit disc is intersecting $D(y_N, \varepsilon)$ (by definition of N), and it contains also the point $\Phi_N(R)$ (because $R \in \gamma_0$). Suppose that $|\Phi_N(R) - y_N|$ does not almost surely tend to 0 (when $\delta \rightarrow 0$); then, with positive probability, we could find a sequence $\delta_j \rightarrow 0$ such that $\Phi_N(R)$ and y_N converge to different points on the unit circle along this subsequence. In particular, the harmonic measure at the origin of any of the two parts of the loop between the moment it visits $\Phi_N(R)$ and the ε -neighborhood of y_N in \mathbb{U} is bounded away from 0. Hence, this is also true for the preimage γ_0 under Φ_N : γ_0 contains two disjoint paths from R to $\Phi_N^{-1}(D(y_N, \varepsilon))$ such that their harmonic measure at 0 in \mathbb{U} is bounded away from 0. Recall that $\Phi_N^{-1}(D(y_N, \varepsilon)) \subset A^{\delta,K'+1}$. In the limit when $\delta \rightarrow 0$, we therefore end up with a contradiction, as we have two parts of γ_0 with positive harmonic measure from the origin, that join R to some point of $[R, 1]$, which is not possible because $\gamma_0 \cap (R, 1] \neq \emptyset$ and γ_0 is a simple loop. Hence, we can conclude that $|\Phi_N(R) - y_N| \rightarrow 0$ almost surely.

Finally, let us observe that $\Phi_N(R) \rightarrow \hat{\Phi}(R)$ almost surely (this follows for instance from the fact that a continuous path that stays inside γ_0 and joins the origin to R stays both in all U_N 's and in \hat{U}). It follows that y_N converges almost surely to \hat{y} . \square

4 The one-point pinned loop measure

4.1 The pinned loop surrounding the origin in \mathbb{U}

We will use the previous exploration mechanisms in the context of CLEs. It is natural to define the notion of Markovian explorations of a CLE. Suppose now that Γ is a CLE in the unit disc and that ε is fixed. When $\gamma_0 \cap D(1, \varepsilon) = \emptyset$, define just as before the

set U_1 and the conformal map Φ_1 obtained by discovering the set of loops Γ_1 of Γ that intersect $D(y_0, \varepsilon)$. Then we choose y_1 and proceed as before, until we discover (at step $N + 1$) the loop γ_0 that surrounds the origin. We say that the exploration is Markovian if for each n , the choice of y_n is measurable with respect to the σ -field generated by $\Gamma_1, \dots, \Gamma_n$, i.e., the set of all already discovered loops.

A straightforward consequence of the CLE's restriction property is that for each n , conditionally on $\Gamma_1, y_1, \dots, \Gamma_n, y_n$ (and $n \leq N$), the law of the set of loops of Γ that stay in U_n is that of a CLE in U_n . In other words, the image of this set of loops under Φ_n is independent of $\Gamma_1, y_1, \dots, \Gamma_n, y_n$ (on the event $\{n \leq N\}$). In fact, we could have used this independence property as a definition of Markovian explorations (it would allow extra randomness in the choice of the sequence y_n).

In other words, an exploration is Markovian if we can choose y_n as we wish using the information about the loops that have already been discovered, but we are not allowed to use any information about the yet-to-be-discovered loops. This ensures that one obtains an iteration of i.i.d. explorations as argued in subsection 3.1. In particular, if an exploration is Markovian, the random variable N is geometric

$$P(N \geq n) = P(\gamma_0 \cap D(1, \varepsilon) = \emptyset)^n,$$

and $y_N^{-1}\Phi_N^{-1}(\gamma_0)$ is distributed according to the conditional law of γ_0 given $\{\gamma \cap D(1, \varepsilon) \neq \emptyset\}$.

Recall that a CLE is a random loop configuration such that for any given δ and $k \leq 1/\delta$, almost surely, all loops that intersect $A^{\delta, k}$ also intersect its interior. We can therefore apply Proposition 3.4, and use Markovian $\varepsilon(\delta)$ -admissible successive explorations of $A^{\delta, 1}, A^{\delta, 2}, \dots$. Combining this with our description of the conditional law of γ_0 given $\{\gamma \cap D(1, \varepsilon) \neq \emptyset\}$, we get the following result:

Proposition 4.1. *When $\varepsilon \rightarrow 0$, the law of γ_0 conditioned on the event $\{\gamma_0 \cap D(1, \varepsilon) \neq \emptyset\}$ converges to the law of $\hat{y}^{-1}\hat{\Phi}(\gamma_0)$ (using for instance the weak convergence with respect to the Hausdorff topology on compact sets).*

Note that local finiteness of the CLE ensures that $\hat{\Phi}(\gamma_0)$ is a simple loop in $\bar{\mathbb{U}}$ that intersects $\partial\mathbb{U}$ only at \hat{y} , so that $\hat{y}^{-1}\hat{\Phi}(\gamma_0)$ is indeed a loop in $\bar{\mathbb{U}}$ that touches $\partial\mathbb{U}$ only at 1.

This limiting law will inherit from the CLE various interesting properties. The loop γ_0 in the CLE can be discovered along the ray $[1, 0]$ in the unit disc as in this proposition, but one could also have chosen any other smooth continuous simple curve from $\partial\mathbb{U}$ to 0 instead of that ray and discovered it that way. This fact should correspond to some property of the law of this pinned loop. Conformal invariance of the CLE will also imply some conformal invariance properties of this pinned loop. The goal of the coming sections is to derive and exploit some of these features.

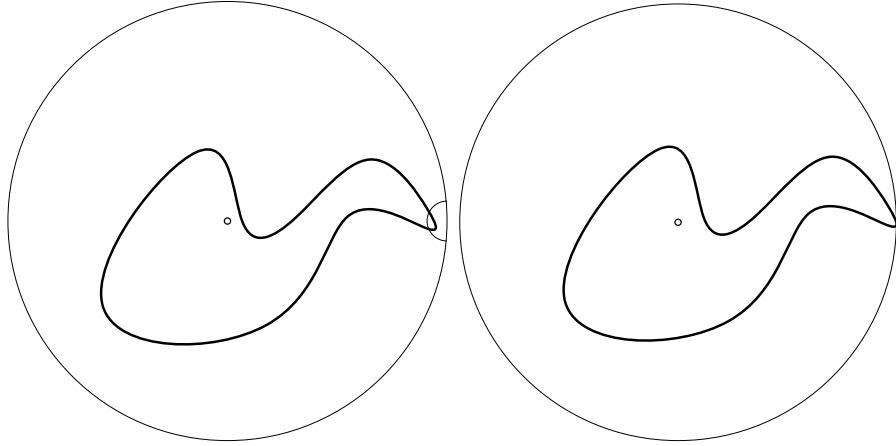

Figure 12: The law of γ_0 conditioned on the event $\{\gamma_0 \cap D(1, \varepsilon) \neq \emptyset\}$ converges (sketch)

4.2 The infinite measure on pinned loops in \mathbb{H}

We are now going to associate to each CLE a natural measure on loops that can loosely be described as the law of a loop “conditioned to touch a given boundary point”. In the previous subsection, we have constructed a probability measure on loops in the unit disc that was roughly the law of γ_0 (the loop in the CLE that surrounds the origin) “conditioned to touch the boundary point 1”. We will extend this to an infinite measure on loops that touch the boundary at one point; the measure will be infinite because we will not prescribe the “size” of the boundary-touching loop; it can be viewed as a CLE “excursion measure” (“bubble measure” would also be a possible description). We find it more convenient at this stage to work in the upper half-plane rather than



Figure 13: The construction of μ^i (sketch)

the unit disc because scaling arguments will be easier to describe in this setting. We therefore first define the probability measure μ^i as the image of the law of $\hat{\Phi}(\gamma_0)$ under the conformal map from \mathbb{U} onto the half-plane that maps 0 to i , and \hat{y} to 0 (we use the notation μ^i instead of P^i as in the introduction, because we will very soon be handling measures that are not probability measures). In other words, the probability measure μ^i is the limit as $\varepsilon \rightarrow 0$ of the law of the loop $\gamma(i)$ that surrounds i in a CLE in the

upper half-plane, conditioned by the fact that it intersects the set C_ε defined by

$$C_\varepsilon = \{z \in \mathbb{H} : |z| = \varepsilon\}.$$

For a loop-configuration Γ in the upper half-plane and $z \in \mathbb{H}$, we denote by $\gamma(z)$ the loop of Γ that surrounds z (if this loop exists).

When $z = i\lambda$ for $\lambda > 0$, scale invariance of the CLE shows that the limit as $\varepsilon \rightarrow 0$ of the conditional law of $\gamma(i\lambda)$ given that it intersects the disc of radius $\lambda\varepsilon$ exists, and that it is just the image of μ^i under scaling.

Let us denote by $u(\varepsilon)$ the probability that the loop $\gamma(i)$ intersects the disc of radius ε around the origin in a CLE. The description of the measure μ^i (in terms of $\hat{\Phi}$) derived in the previous section shows that at least for almost all λ sufficiently close to one, the loop that surrounds i also surrounds $i\lambda$ and i/λ with probability at least $1/2$ under μ^i , and that i/λ as well as λi are a.s. not on $\gamma(i)$ (when λ is fixed).

Let O_i denote the interior of the loop $\gamma(i)$. We know that

$$\lim_{\varepsilon \rightarrow 0} \frac{P(\lambda i \in O_i \text{ and } \gamma(i) \cap C_{\lambda\varepsilon} \neq \emptyset)}{u(\lambda\varepsilon)} = \mu^i(\lambda i \in O_i).$$

On the other hand, the scaling property of the CLE shows that when $\varepsilon \rightarrow 0$,

$$\begin{aligned} & \frac{P(\lambda i \in O_i \text{ and } \gamma(i) \cap C_{\lambda\varepsilon} \neq \emptyset)}{u(\lambda\varepsilon)} \\ &= \frac{P(i \in O_{\lambda i} \text{ and } \gamma(\lambda i) \cap C_{\lambda\varepsilon} \neq \emptyset)}{u(\lambda\varepsilon)} \\ &= \frac{P(i/\lambda \in O_i \text{ and } \gamma(i) \cap C_\varepsilon \neq \emptyset)}{u(\varepsilon)} \times \frac{u(\varepsilon)}{u(\lambda\varepsilon)} \\ &\sim \mu^i(i/\lambda \in O_i) \times \frac{u(\varepsilon)}{u(\lambda\varepsilon)} \end{aligned}$$

Hence, for all λ sufficiently close to 1, we conclude that

$$\lim_{\varepsilon \rightarrow 0} \frac{u(\lambda\varepsilon)}{u(\varepsilon)} = \frac{\mu^i(i/\lambda \in O_i)}{\mu^i(\lambda i \in O_i)}.$$

If we call $f(\lambda)$ this last quantity, this identity clearly implies that this convergence in fact holds for all positive λ , and that $f(\lambda\lambda') = f(\lambda)f(\lambda')$. Furthermore, we see that $f(\lambda) \rightarrow 1$ as $\lambda \rightarrow 1$. Hence:

Proposition 4.2. *There exists a $\beta \geq 0$ (β cannot be negative since $\varepsilon \mapsto u(\varepsilon)$ is non-decreasing) such that for all positive λ ,*

$$f(\lambda) = \lim_{\varepsilon \rightarrow 0} \frac{u(\lambda\varepsilon)}{u(\varepsilon)} = \lambda^\beta.$$

This has the following consequence:

Corollary 4.3. $u(\varepsilon) = \varepsilon^{\beta+o(1)}$ as $\varepsilon \rightarrow 0+$.

Proof. Note that for any $\beta' < \beta < \beta''$, there exists $\varepsilon_0 = 2^{-n_0}$ such that for all $\varepsilon \leq \varepsilon_0$,

$$2^{\beta'} < u(2\varepsilon)/u(\varepsilon) < 2^{\beta''}.$$

Hence, for all $n \geq 0$ it follows that

$$u(\varepsilon_0)2^{-n\beta''} < u(\varepsilon_0 2^{-n}) < u(\varepsilon_0)2^{-n\beta'}.$$

It follows that $u(\varepsilon_0 2^{-n}) = 2^{-n\beta+o(n)}$ when $n \rightarrow \infty$. Since $\varepsilon \mapsto u(\varepsilon)$ is a non-decreasing function of ε , the corollary follows. \square

Because of scaling, we can now define for all $z = i\lambda$, a measure μ^z on loops $\gamma(z)$ that surround z and touch the real line at the origin as follows:

$$\mu^z(\gamma(z) \in \mathcal{A}) = \lambda^{-\beta} \mu^i(\lambda\gamma(i) \in \mathcal{A})$$

for any measurable set \mathcal{A} of loops. This is also the limit of $u(\varepsilon)^{-1}$ times the law of $\gamma(z)$ in an CLE, restricted to the event $\{\gamma(z) \cap C_\varepsilon \neq \emptyset\}$.

Let us now choose any z in the upper half-plane. Let $\psi = \psi_z$ now denote the Moebius transformation from the upper half-plane onto itself with $\psi(z) = i$ and $\psi(0) = 0$. Let $\lambda = 1/\psi'(0)$. Clearly, for any given $a > 1$, for any small enough ε , the image of C_ε under ψ is “squeezed” between the circles $C_{\varepsilon/a\lambda}$ and $C_{a\varepsilon/\lambda}$. It follows readily (using the fact that $f(a) \rightarrow 1$ as $a \rightarrow 1$) that the measure μ^z defined for all measurable \mathcal{A} by

$$\mu^z(\gamma(z) \in \mathcal{A}) = \lambda^{-\beta} \mu^i(\psi^{-1}(\gamma(i)) \in \mathcal{A})$$

can again be viewed as the limit when $\varepsilon \rightarrow 0$ of $u(\varepsilon)^{-1}$ times the distribution of $\gamma(z)$ restricted to $\{\gamma(z) \cap C_\varepsilon \neq \emptyset\}$.

Finally, we can now define our measure μ on pinned loops. It is the measure on simple loops that touch the real line at the origin and otherwise stay in the upper half-plane (this is what we call a pinned loop) such that for all $z \in \mathbb{H}$, it coincides with μ^z on the set of loops that surround z . Indeed, the previous limiting procedure shows immediately that for any two points z and z' , the two measures μ^z and $\mu^{z'}$ coincide on the set of loops that surround both z and z' . On the other hand, we know that a pinned loop necessarily surrounds a small disc: thus, the requirement that μ coincides with the μ^z 's (as described above) fully determines μ .

Let us sum up the properties of the pinned measure μ that we will use in what follows:

- For any conformal transformation ψ from the upper half-plane onto itself with $\psi(0) = 0$, we have

$$\psi \circ \mu = |\psi'(0)|^{-\beta} \mu.$$

This is the *conformal covariance property* of μ . Note that the maps $z \mapsto -za/(z-a)$ for real $a \neq 0$ satisfy $\psi'(0) = 1$ so that μ is invariant under these transformations.

- For each z in the upper half-plane, the mass $\mu(\{\gamma : z \in \text{int}(\gamma)\})$ is finite and equal to $\psi'(0)^\beta$, where ψ is the conformal map from \mathbb{H} onto itself with $\psi(0) = 0$ and $\psi(z) = i$.
- For each z in the upper half-plane, the measure μ restricted to the set of loops that surround z is the limit as $\varepsilon \rightarrow 0+$ of $u(\varepsilon)^{-1}$ times the law of $\gamma(z)$ in a CLE restricted to the event $\{\gamma(z) \cap C_\varepsilon \neq \emptyset\}$. In other words, for any bounded continuous (with respect to the Hausdorff topology, say) function F on the set of loops,

$$\mu(1_{\{z \text{ is surrounded by } \gamma\}} F(\gamma)) = \lim_{\varepsilon \rightarrow 0} \frac{1}{u(\varepsilon)} E(1_{\{\gamma(z) \cap C_\varepsilon \neq \emptyset\}} F(\gamma(z))).$$

Since this pinned measure is defined in a domain with one marked point, it is also quite natural to consider it in the upper half-plane \mathbb{H} , but to take the marked point at infinity. In other words, one takes the image of μ under the mapping $z \mapsto -1/z$ from \mathbb{H} onto itself. This is then a measure μ' on loops “pinned at infinity, i.e. on double-ended infinite simple curves in the upper-half plane that go from and to infinity. It clearly also has the scaling property with exponent β , and the invariance under the conformal maps that preserve infinity and the derivative at infinity is just the invariance under horizontal translations.

4.3 Discrete radial/chordal explorations, heuristics, background

We will now (and also later in the paper) use the exploration mechanism corresponding to the case where all points y_n are chosen to be equal to 1, instead of being tailored in order for the exploration to stay in some a priori chosen set A as in Section 3. Let us describe this discrete radial exploration (this is how we shall refer to it) in the setting of the upper half-plane \mathbb{H} : We fix $\varepsilon > 0$, and we wish to explore the CLE in the upper half-plane by repeatedly cutting out origin-centered semi-circles C_ε of radius ε (and the loops they intersect) and applying conformal maps. The first step is to consider the set of loops that intersect C_ε . Either we have discovered the loop $\gamma(i)$ (i.e., the loop that surrounds i), in which case we stop, or we haven't, in which case we define the connected component of the complement of these loops in $\mathbb{H} \setminus C_\varepsilon$ that contains i , and map it back onto the upper half-plane by the conformal map φ_1^ε such that $\varphi_1^\varepsilon(i) = i$ and $(\varphi_1^\varepsilon)'(i) > 0$. We then start again, and this defines an independent copy φ_2^ε of φ_1^ε .

In this way, we define a random geometric number $N = N(\varepsilon)$ of such conformal maps $\varphi_1^\varepsilon, \dots, \varphi_N^\varepsilon$. The $N + 1$ -th map can not be defined because one then discovers the loop that surrounds i . The probability that $N \geq n$ is equal to $(1 - u(\varepsilon))^n$. The difference with the exploration procedure of Section 3 is that we do not try to explore “along some prescribed curve”, but we just iterate i.i.d. conformal maps in such a way that the derivative at i remains a positive real, i.e. we consistently target the inner point i .

Another natural exploration procedure uses a discrete chordal exploration that targets a boundary point: We first consider the set of loops in a CLE in \mathbb{H} that intersect C_ε . Now, we consider the unbounded connected component H_1 of the complement in $\mathbb{H} \setminus C_\varepsilon$ of the union of these loops. We map it back onto the upper half-plane using the conformal map φ_1^ε normalized at infinity, i.e. $\varphi_1^\varepsilon(z) \sim z + o(1)$ as $z \in \mathbb{H}$. Then we iterate the procedure, defining an infinite i.i.d. sequence $\varphi_1^\varepsilon, \varphi_2^\varepsilon, \dots$ of conformal maps, and a decreasing family of domains $H_n = (\varphi_n^\varepsilon \circ \dots \circ \varphi_1^\varepsilon)^{-1}(\mathbb{H})$ (unlike the radial exploration, this chordal exploration never stops).

Let us make a little heuristic discussion in order to prepare what follows. When ε is very small, the law of the sets that one removes at each step in these two exploration mechanisms can be rather well approximated thanks to the measure μ . Let us for instance consider the chordal exploration. Because of μ 's scaling property, the μ -mass of the set of loops of half-plane capacity (which scales like the square of the radius) larger than η should decay as $\eta^{-\beta/2}$. In particular, in the discrete exploration, the average number of exploration steps where one removes a set $\varphi_n^\varepsilon(H_n \setminus H_{n+1})$ with half-plane capacity larger than x is equal (in the $\varepsilon \rightarrow 0$ limit) to $x^{-\beta/2}$ times the average number of exploration steps where one removes a set with half-plane capacity larger than one.

Readers familiar with Lévy processes will probably have recognized that in the $\varepsilon \rightarrow 0$ limits, the capacity jumps of the chordal exploration process will be distributed like the jumps of a $(\beta/2)$ -stable subordinator. It is important to stress that we know a priori that the limiting process has to possess macroscopic capacity jumps (corresponding to the discovered macroscopic loops). Since α -stable subordinators exist only for $\alpha \in (0, 1)$, we expect that $\beta < 2$. Proving this last fact will be the main goal of this section.

In fact, we shall see that the entire discrete explorations (and not only the process of accumulated half-plane capacities) converge to a continuous “Lévy-exploration” defined using a Poisson point process of pinned loops with intensity μ . We however defer the more precise description of these Lévy explorations to Section 7, where we will also make the connection with branching $\text{SLE}(\kappa, \kappa - 6)$ processes and show how to reconstruct the law of a CLE using the measure μ only, i.e., that the measure μ characterizes the law of the CLE.

In fact, the rest of this part of the paper (until the constructive part using Brownian loop-soups) has two main goals: The first one is to show that the CLE definition yields a description of the pinned measure μ in terms of SLE_κ for some $\kappa \in (8/3, 4]$. The second one is to prove that the pinned measure μ characterizes the law of the entire CLE and also to make the connection with $\text{SLE}(\kappa, \kappa - 6)$. We choose to start with the SLE-description of μ ; in the next subsection, we will therefore only derive those

two results that will be needed for this purpose, leaving the more detailed discussion of continuous chordal explorations for later sections.

For readers who are not so familiar with Lévy processes or Loewner chains, let us now briefly recall some basic features of Poisson point processes and the stability of Loewner chains that will hopefully help making the coming proofs more transparent.

Stability of Loewner chains: Let \mathcal{S} denote the class of conformal maps $\varphi = \varphi_H$ from a subset H of the complex upper half-plane back onto the upper half-plane \mathbb{H} such that $i \in H$, $\varphi(i) = i$ and $\varphi'(i)$ is a positive real. Note that (because $H \subset \mathbb{H}$), $\varphi'(i) \geq 1$. Let us then define $a(\varphi) = \log \varphi'(i)$. This is a decreasing function of the domain H (the smaller H , the larger a), which is closely related to the conformal radius of the domain (one can for instance conjugate with $z \mapsto (i - z)/(i + z)$ in order to be in the usual setting of the disc). It is immediate to check that for some universal constant C , for all $r < 1/2$ and for all φ such that the diameter of $\mathbb{H} \setminus H$ is smaller than r ,

$$a(\varphi) \leq Cr^2.$$

On the other hand, for some other universal constant C' , for all $r < 1/2$ and for all H such that $ir \notin H$,

$$a(\varphi) \geq C'r^2.$$

Suppose now that $\varphi_1, \dots, \varphi_N$ are N given conformal maps in \mathcal{S} . Define $\Phi = \varphi_N \circ \dots \circ \varphi_1$ to be the composition of these conformal maps. It is an easy fact (that can be readily deduced from simple distortion estimates, or via Loewner's theory to approximate these maps via Loewner chains for instance) that for any family $(\psi_0^\delta, \dots, \psi_N^\delta)_{\delta > 0}$ of conformal maps in \mathcal{S} such that

$$\lim_{\delta \rightarrow 0} a(\psi_0^\delta) + \dots + a(\psi_N^\delta) = 0,$$

the conformal maps

$$\Phi^\delta = \psi_N^\delta \circ \varphi_N \circ \psi_{N-1}^\delta \circ \varphi_{N-1} \circ \dots \circ \varphi_1 \circ \psi_0^\delta$$

converge in Carathéodory topology (viewed from i) to Φ as $\delta \rightarrow 0$. In other words, putting some perturbations of the identity between the iterations of φ 's does not change things a lot, as long as the accumulated “size” (measured by a) of the perturbations is small.

Poisson point processes discrete random sequences: We will approximate Poisson point processes via discrete sequences of random variables. We will at some point need some rather trivial facts concerning Poisson random variables, that we now briefly derive. Suppose that we have a sequence of i.i.d. random variables $(X_n, n \geq 1)$ that take their values in some finite set $\{0, 1, \dots, k\}$ with $P(X_1 = 0) > 0$. Let N denote the smallest n value at which $X_n = 0$. For each $j \in \{1, \dots, k\}$, let N_j denote the cardinality of $\{n \in \{1, \dots, N-1\} : X_n = j\}$. We want to control the joint law of (N_1, \dots, N_k) .

One convenient way to represent this joint law is to consider a Poisson point process $(X_j, T_j)_{j \in J}$ on $\mathcal{A} \times [0, \infty)$ with intensity $\mathcal{M} \times dt$, where \mathcal{M} is some σ -finite measure

on a space \mathcal{A} . Consider disjoint measurable sets A, A_1, \dots, A_k in \mathcal{A} with $\mathcal{M}(A) = 1$, $\mathcal{M}(A_1) = a_1 < \infty, \dots, \mathcal{M}(A_k) = a_k < \infty$. We define

$$T = \inf\{t > 0 : \exists j \in J \text{ such that } T_j \leq t \text{ and } X_j \in A\},$$

i.e., loosely speaking, if we interpret t as a time-variable, T is the first time at which one observes an X in A . Since $\mathcal{M}(A) = 1$, the law of T is exponential with parameter 1. In particular, $P(T > 1) = 1/e$. We now define, for $j = 1, \dots, k$,

$$N_j = \#\{j : T_j \leq T \text{ and } X_j \in A_j\},$$

i.e., the number of times one has observed an X in A_j before the first time at which one observes an X in A . Then the law of N_1, \dots, N_k is the same as before, where $P(X_1 = j) = a_j/(1 + a_1 + \dots + a_j)$.

Because of the independence properties of Poisson point processes, the conditional law of (N_1, \dots, N_k) given T is that of k independent Poisson random variables with respective means $TM(A_1), \dots, TM(A_k)$. Hence, $E(N_j) = E(T)M(A_j) = M(A_j)$. Furthermore, if we condition on the event $\{T > 1\}$, the (joint) conditional distribution of N_1, \dots, N_k “dominates” that of k independent Poisson random variables of parameter a_1, \dots, a_k .

4.4 A priori estimates for the pinned measure

Let us denote the “radius” of a loop γ in the upper half-plane by

$$R(\gamma) = \max\{|z| : z \in \gamma\}.$$

Lemma 4.4. *The μ -measure of the set of loops with radius greater than 1 is finite.*

Proof. Let us use the radial exploration mechanism. The idea of the proof is to see that if the μ -mass of the set of loops of radius greater than 1 is infinite, then one “collects” too many macroscopic loops before finding $\gamma(i)$ in the exploration mechanism, which will contradict the local finiteness of the CLE.

Recall that, at this moment, we know that for any given point $z \in \mathbb{H}$, the measure μ^z is the limit when $\varepsilon \rightarrow 0$ of $u(\varepsilon)^{-1}$ times the law of $\gamma(z)$ restricted to the event that $\gamma(z)$ intersects the ε -neighborhood of the origin. Furthermore, for any given point $z \in \mathbb{H}$, the distance between z and γ is μ -almost always positive. This implies that for any given finite family of points z_1, \dots, z_n in \mathbb{H} , the measure μ restricted to the set $\mathcal{A} = \mathcal{A}(z_1, \dots, z_n)$ of loops that surrounds at least one of these points is the limit when $\varepsilon \rightarrow 0$ of $u(\varepsilon)^{-1}$ times the (sum of the) laws of loops in \mathcal{A} that intersect the ε -neighborhood of the origin.

Suppose now that $\mu(\{\gamma : R(\gamma) \geq 1\}) = \infty$. This implies clearly that for each $M > 1$, one can find a finite set of points z_1, \dots, z_n at distance greater than one of the origin such that $\mu(\mathcal{A}(z_1, \dots, z_n)) > M$. Hence, it follows that when ε is small enough,

at each exploration step, the probability to discover a loop in \mathcal{A} is at least M times bigger than $u(\varepsilon)$. The number of exploration steps before N at which this happens is therefore geometric with a mean at least equal to M . It follows readily that with probability at least c_0 (for some universal positive c_0 that does not depend on ε), this happens at least $M/4$ times.

Note that the harmonic measure in \mathbb{H} at i of a loop of radius at least 1 that intersects also $C_{1/2}$ is bounded from below by some universal positive constant c_1 . If at some step $j \leq N$, the radius of $\mathbb{H} \setminus (\varphi_j^\varepsilon)^{-1}(\mathbb{H})$ is greater than 1, then it means that there is a loop in the CLE in \mathbb{H} that one explores at the j -th step that has a radius at least 1 and that intersects $C_{1/2}$. Its preimage under $\varphi_{j-1}^\varepsilon \circ \dots \circ \varphi_1^\varepsilon$ (which is a loop of the original CLE that one is discovering) has therefore also a harmonic measure (in \mathbb{H} and at i) that is bounded from below by c_1 . Hence, we conclude that with probability at least c_0 , the original CLE has at least $M/4$ different loops such that their harmonic measure seen from i in \mathbb{H} is bounded from below by some universal constant c_1 .

This statement holds for all M , so that with probability at least c_0 , there are infinitely many loops in the CLE such that their harmonic measure seen from i in \mathbb{H} is bounded from below by c_1 .

On the other hand, we know that $\gamma(i)$ is almost surely at positive distance from i , and this implies that for some positive α , the probability that some loop in the CLE is a distance less than α of i is smaller than $c_0/2$. Hence, with probability at least $c_0/2$, the CLE contains infinitely many loops that are all at distance at least α from i and all have harmonic measure at least c_1 . A similar statement is therefore true for the CLE in the unit disc if one maps i onto the origin. It is then easy to check that the previous statement contradicts the local finiteness (because the diameter of the conformal image of all these loops is bounded from below). Hence, the μ -mass of the set of pinned loops that reach the unit circle is indeed finite. \square

Let us now list various consequences of Lemma 4.4:

- For all $r > 0$, let us define $\mathcal{A}_r := \{\gamma : R(\gamma) > r\}$. Because of scaling, we know that for all $r > 0$, $\mu(\mathcal{A}_r) = r^{-\beta} \mu(\mathcal{A}_1)$. Clearly, this cannot be a constant finite function of r ; this implies that $\beta > 0$. Also, we get that for each fixed r , $\mu(R(\gamma) = r) = 0$.
- We can now define the function $v(\varepsilon)$ as the probability that in the CLE, there exists a loop that intersects C_ε and C_1 . We know that

$$\lim_{\varepsilon \rightarrow 0^+} \frac{v(\varepsilon)}{u(\varepsilon)} = \mu(R(\gamma) \geq 1) \quad (2)$$

(because $\mu(R(\gamma) = 1) = 0$). Hence, it follows that for any $\delta < 1$, $v(\delta\varepsilon)/v(\varepsilon) \rightarrow \delta^\beta$ as $\varepsilon \rightarrow 0$. This will be useful later on.

- We can rephrase in a slightly more general way our description of μ in terms of limits of CLE loops. Note that $\mathcal{A}_r = \cup_n \mathcal{A}(z_1, \dots, z_n)$, where $(z_n, n \geq 1)$ is some given dense sequence on $\{z : |z| = r\}$.

For each simple loop configuration Γ , and for each ε , let us define $\tilde{\gamma}(\varepsilon)$ to be the loop in the configuration Γ that intersects the disc of radius ε and with largest radius (in case there are ties, take any deterministic definition to choose one). We know from (2) that the probability that $R(\tilde{\gamma}(\varepsilon)) > r$ decays like $u(\varepsilon) \times r^{-\beta} \mu(\mathcal{A}_1)$ as $\varepsilon \rightarrow 0$ (for each fixed $r > 0$).

Furthermore, we note that the probability that there exist two different loops of radius greater than r that intersect the circle C_ε decays like $o(u(\varepsilon))$ as $\varepsilon \rightarrow 0$. Indeed, otherwise, for some sequence $\varepsilon_n \rightarrow 0$, the probability that in our exploration procedure, two macroscopic loops are discovered simultaneously remains positive and bounded from below, which is easily shown to contradict the fact that almost surely, any two loops in our CLE are at positive distance from each other.

Hence, for each n , the measure μ restricted to $\mathcal{A}(z_1, \dots, z_n)$ is the limit when $\varepsilon \rightarrow 0$ of $u(\varepsilon)^{-1}$ times the law of $\tilde{\gamma}(\varepsilon)$, restricted to the event that it surrounds at least one of the points z_1, \dots, z_n .

We conclude that the measure μ restricted to \mathcal{A}_r can be viewed as the weak limit when $\varepsilon \rightarrow 0$ of $u(\varepsilon)^{-1}$ times the law of $\tilde{\gamma}(\varepsilon)$ restricted to \mathcal{A}_r . In other words, if we consider the set of pinned loops of strictly positive size (i.e., the loop of zero length is not in this set) endowed with the Hausdorff metric, we can say that μ is the vague limit of $u(\varepsilon)^{-1}$ times the law of $\tilde{\gamma}(\varepsilon)$.

Let us finally state another consequence of this result, that will turn out to be useful in the loop-soup construction part of the paper. Consider a CLE in \mathbb{H} and let us consider the set of loops that intersect the unit circle. Define \mathcal{R} to be the radius of the smallest disc centered at the origin that contains all these loops. Note that scaling shows that $P(\mathcal{R} > x) = v(1/x)$ for $x \geq 1$.

Corollary 4.5. *If $\beta > 1$, then $E(\mathcal{R}^{(1+\beta)/2}) < \infty$.*

Proof. Just note that

$$\begin{aligned} E(\mathcal{R}^{(1+\beta)/2}) &= \int_0^\infty dr P(\mathcal{R}^{(1+\beta)/2} \geq r) \\ &\leq 1 + \int_1^\infty dr v(r^{-2/(1+\beta)}) \\ &\leq 1 + \int_1^\infty \frac{dr}{r^{2\beta/(1+\beta)+o(1)}} < \infty \end{aligned}$$

because $2\beta > 1 + \beta$. □

With the $8/\kappa = 1 + \beta$ identification that we will derive later, $\beta > 1$ corresponds to $\kappa < 4$ and then $(1 + \beta)/2 = 4/\kappa$.

The next proposition corresponds to the fact that α -stable subordinators exist only for $\alpha \in (0, 1)$.

Proposition 4.6. *The scaling exponent β described above lies in $(0, 2)$.*

Proof. We use the radial exploration mechanism again. Let us now assume that $\beta \geq 2$ and focus on the contribution of the “small” loops that one discovers before actually discovering $\gamma(i)$.

Let $\mathcal{A}_1, \dots, \mathcal{A}_k$ be k fixed disjoint (measurable) sets of loops that do not surround i , with $a_l = \mu(\mathcal{A}_l) < \infty$. We suppose that all \mathcal{A}_l 's for $l \leq k$ belong to the algebra of events generated by the events of the type $\{\gamma : \gamma \text{ surrounds } z\}$. We let $N_\varepsilon(\mathcal{A}_l)$ denote the number of loops in \mathcal{A}_l that one has discovered in this way before one actually discovers the loop that surrounds i . Our previous results show that when $\varepsilon \rightarrow 0$, the joint law of $N_\varepsilon(\mathcal{A}_1), \dots, N_\varepsilon(\mathcal{A}_k)$ converges to that of the N_1, \dots, N_k that we described at the end of the previous subsection.

For each integer j , we define \mathcal{A}_j to be the set of loops that surround $2^{-j}i$ but that do not surround any point $2^{-k}i$ for $k < j$. The scaling property of μ implies that for all j , $\mu(\mathcal{A}_j) = 2^{j\beta} \mu(\mathcal{A}_0)$ and it is easy to check that $\mu(\mathcal{A}_0) > 0$ (because the loops that surround i have a finite radius so that $\sum_{j \leq 0} \mu(\mathcal{A}_j) \geq 1 > 0$). Hence, for all positive j ,

$$\mu(\mathcal{A}_j) \geq 4^j \mu(\mathcal{A}_0).$$

Recall that if ψ is a conformal map in \mathcal{S} from a simply connected subset H of \mathbb{H} that does contain i but not $2^{-j_0}i$ for some $j_0 \geq 1$, then

$$a(\psi) \geq C' 4^{-j_0}.$$

Furthermore, for each fixed j_0 , when ε is small enough, we can compare the number of loops in $\mathcal{A}_1, \dots, \mathcal{A}_{j_0}$ that have been discovered before $\gamma(i)$ via the chordal exploration mechanism with i.i.d. Poisson random variables N_1, \dots, N_{j_0} . Note also that when one composes conformal maps in \mathcal{S} , the derivatives at i get multiplied and the a 's therefore add up.

Hence, it follows immediately that if $\beta \geq 2$, then for each j_0 , with a probability that is bounded from below independently of j_0 , when ε is small enough,

$$a(\varphi_1 \circ \dots \circ \varphi_N) \geq \frac{C'}{2} \sum_{j=1}^{j_0} N_j 4^{-j}.$$

Hence, we conclude that there exists $c_2 > 0$ such that for each $M > 0$, if one chooses ε small enough, the probability that $a(\varphi_1 \circ \dots \circ \varphi_N) \geq M$ is at least c_2 . But this contradicts the fact that $\gamma(i)$ is at positive distance from i (for instance using Koebe's 1/4 Theorem). Hence, we conclude that β is indeed smaller than 2. \square

5 The two-point pinned probability measure

5.1 Restriction property of the pinned measure

We now investigate what sort of “restriction-type” property the pinned measure μ inherits from the CLE. Note that μ is an infinite measure on single pinned loops (rather than a probability measure on loop configurations), so the statement will necessarily be a bit different from the restriction property of CLE.

Suppose now that A is a closed bounded set such that $\mathbb{H} \setminus A$ is simply connected, and that $d(0, A) > 0$. Our goal is to find an alternative description of the infinite measure μ restricted to the set of loops γ that do not intersect A .

Suppose that a deterministic pinned (at zero) loop γ (in the upper half-plane) is given. Sample a CLE $\Gamma^\#$ in the upper half-plane. This defines a random $H^\#$ which is the connected component that has the origin on its boundary of the set obtained by removing from $\mathbb{H} \setminus A$ all loops of $\Gamma^\#$ that intersect A . Then, we define a conformal map $\psi^\#$ from \mathbb{H} onto $H^\#$ such that

$$\psi^\#(0) = 0 \text{ and } (\psi^\#)'(0) = 1.$$

In order to fix $\psi^\#$, another normalization is needed. We can for instance take $\psi^\#(\infty) = \infty$, but all of what follows would still hold if one replaced $\psi^\#$ by the map $G^\#$ such that $G^\#(z) = z + o(z^2)$ as $z \rightarrow 0$ (we will in fact also use this map in the coming sections). Finally, we define $\gamma^\# = \psi^\#(\gamma)$. Clearly, this is a pinned loop that stays in $H^\#$ and therefore avoids A almost surely.

Suppose now that we use the product measure $\mu \otimes P$ on pairs $(\gamma, \Gamma^\#)$ (where P is the law of the same CLE that was used to define the pinned measure μ). For each pair $(\gamma, \Gamma^\#)$ we define the loop $\gamma^\# = \gamma^\#(\gamma, \Gamma^\#) = \psi^\#(\gamma)$ as before, and we define μ_A to be the image measure of $\mu \otimes P$ via this map. This μ_A is an infinite measure on the set of loops that do not intersect A .

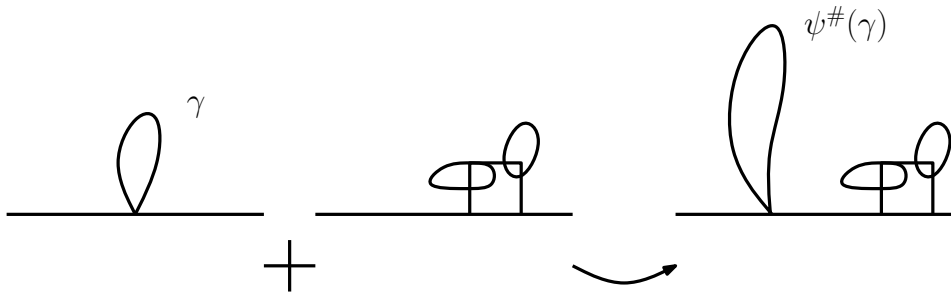

Figure 14: Construction of μ_A (sketch)

We are now ready to state the pinned measure’s restriction property:

Proposition 5.1 (Restriction property of μ). *The measure μ restricted to the set $\{\gamma \cap A = \emptyset\}$ is equal to μ_A .*

Recall that we constructed the pinned measure by “exploring” a CLE in \mathbb{U} until we discover γ_0 . If we started with a pinned loop — together with a CLE in the complement of the pinned loop — we might try to “explore” this configuration until we hit the pinned loop. This would be a way of constructing a natural measure on loops pinned at two points. We will essentially carry out such a procedure later on, and the above proposition will be relevant.

Proof. Let us now consider the set A and a CLE $\Gamma^\#$, and define $H^\#$ and the map $\psi^\#$ as before. For each ε , the event that no loop in $\Gamma^\#$ intersects both C_ε and A is identical to the event that $C_\varepsilon \subset H^\#$. Let us now condition on the set $H^\#$ (for a configuration where $C_\varepsilon \subset H^\#$); the restriction property of the CLE tells us that the conditional law of the CLE-loops that stay in $H^\#$ is exactly that of an “independent CLE” defined in this random set $H^\#$. Hence, we get an identity between the following two measures:

- The law of $\tilde{\gamma}(\varepsilon)$ in the CLE (the loop with largest radius that intersects C_ε), restricted to the event that no loop in the CLE intersects both C_ε and A .
- Sample first a CLE $\Gamma^\#$, define $H^\#$, restrict ourselves to the event where $C_\varepsilon \subset H^\#$, define $\psi^\#$, consider an independent CLE $\tilde{\Gamma}$ in the upper half-plane and its image $\psi^\#(\tilde{\Gamma})$, and look at the law of the loop with largest radius in this family that intersects C_ε .

Note that the total mass of these two measures is the probability that no loop in the CLE intersects both C_ε and A .

Now, we consider the vague limits when $\varepsilon \rightarrow 0$ of $1/u(\varepsilon)$ times these two measures. It follows readily from our previous considerations that:

- For the first construction, the limit is just μ restricted to the set of pinned loops that do not hit A .
- For the second construction, the limit is just μ_A (recall that $\psi^\#$ has been chosen in such a way that $(\psi^\#)'(0) = 1$, so that when ε is small $\psi^\#(C_\varepsilon)$ is very close to C_ε).

□

In fact, it will be useful to upgrade the previous result to the space of “pinned configurations”: We say that $(\bar{\gamma}, \bar{\Gamma})$ is a *pinned configuration* if $\bar{\gamma}$ is a pinned loop in the upper half-plane and if $\bar{\Gamma}$ is a loop-configuration in the unbounded connected component of $\mathbb{H} \setminus \bar{\gamma}$.

Let us define a first natural measure on the space of pinned configurations. Suppose that one is given a pinned loop γ and a loop-configuration Γ (that is not necessarily disjoint from γ). Define H_γ the unbounded connected component of the complement of γ , and ϕ_γ the conformal map from \mathbb{H} onto H_γ that is normalized at infinity ($\phi_\gamma(z) = z + o(1)$). Then $(\bar{\gamma}, \bar{\Gamma}) = (\gamma, \phi_\gamma(\Gamma))$ is clearly a pinned loop configuration. We now let $\bar{\mu}$

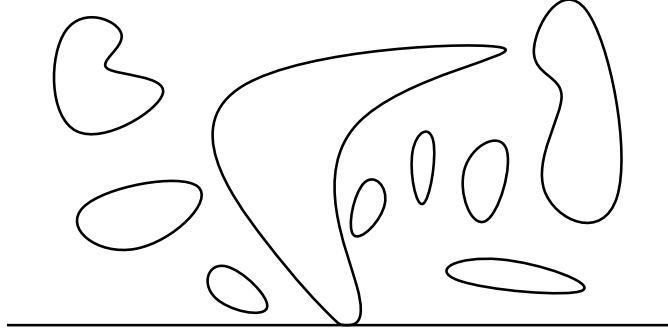

Figure 15: A pinned configuration (sketch)

denote the image of the product measure $\mu \otimes P$ under this map $(\gamma, \Gamma) \mapsto (\bar{\gamma}, \bar{\Gamma})$. We call it the pinned CLE configuration measure. Clearly, the marginal measure of $\bar{\gamma}$ (under $\bar{\mu}$) is μ (because P is a probability measure and $\bar{\gamma} = \gamma$).

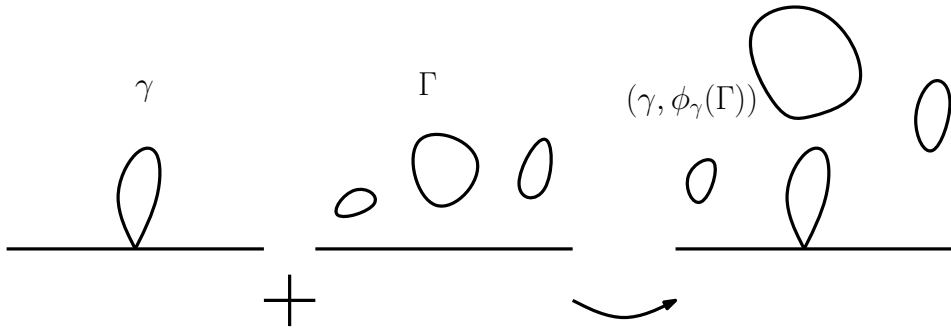

Figure 16: Construction of $(\bar{\gamma}, \bar{\Gamma})$ (sketch)

Suppose now that A is a set as before. If $(\bar{\gamma}, \bar{\Gamma})$ is a pinned configuration, then we define:

- $\tilde{\Gamma}_A$ to be the set of loops of $\bar{\Gamma}$ that intersect A .
- \bar{H}_A to be the unbounded connected component of $\mathbb{H} \setminus (\tilde{\Gamma}_A \cup A)$
- $\bar{\Gamma}_A$ to be the set of loops of $\bar{\Gamma}$ that stay in \bar{H}_A .

Hence, when $\bar{\gamma} \cap A = \emptyset$, we define a triplet $(\bar{\gamma}, \bar{\Gamma}_A, \tilde{\Gamma}_A)$. Let $\bar{\mu}_A$ denote the image of $\bar{\mu}$ (restricted to the set $\bar{\gamma} \cap A = \emptyset$) under this transformation.

We now construct another measure that will turn out to be identical to $\bar{\mu}_A$: Start on the one hand with a pinned measure configuration $(\bar{\gamma}, \bar{\Gamma})$ and on the other hand with a loop-configuration in \mathbb{H} that we denote by $\Gamma^\#$. We define $\psi^\#$ as before (using A and $\Gamma^\#$). We also let $\Gamma_A^\#$ denote the loops in $\Gamma^\#$ that intersect A . Then we consider the

triplet $(\psi^\#(\bar{\gamma}), \psi^\#(\bar{\Gamma}), \Gamma_A^\#)$. This triplet is a function of $((\bar{\gamma}, \bar{\Gamma}), \Gamma^\#)$. We now define $\mu_A^\#$ to be the image of the product measure $\bar{\mu} \otimes P$ under this mapping.

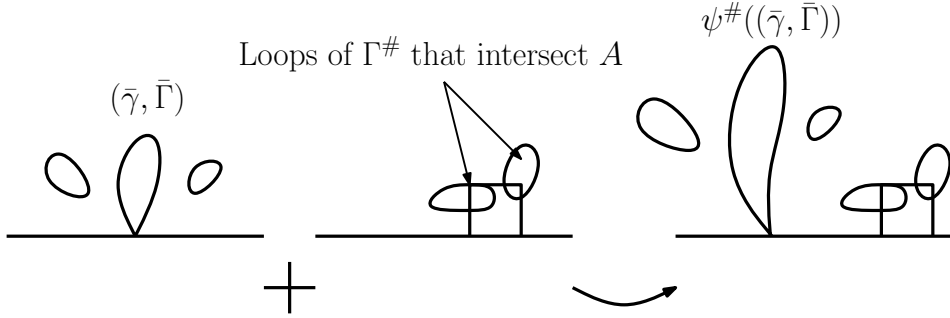

Figure 17: The measure $\mu_A^\#$ (sketch)

Proposition 5.2 (Restriction property for pinned configurations). *The two measures $\bar{\mu}_A$ and $\mu_A^\#$ are identical.*

If we consider the marginal measures on the pinned loops of $\bar{\mu}_A$ and $\mu_A^\#$, we recover Proposition 5.1. The proof is basically identical to that of Proposition 5.1: One just needs also to keep track of the remaining loops, and this is done on the one hand thanks to the CLE’s restriction property, and on the other hand (in the limiting procedure) thanks to the fact that loops are disjoint and at positive distance from the origin. In order to control the $\varepsilon \rightarrow 0$ limiting procedure applied to loop configurations, one can first derive the result for the law of finitely many loops in the loop configuration (for instance those that surround some given point).

5.2 Chordal explorations

As in the case of the CLE, we are going to progressively explore a pinned configuration, cutting out recursively small (images of) semi-circles, and trying to make use of the pinned measure’s restriction property in order to define a “two-point pinned measure”. However, some caution will be needed in handling ideas involving independence because $\bar{\mu}$ is not a probability measure.

Recall that $\bar{\mu}$ is a measure on configurations in a simply connected domain with one special marked boundary point (i.e., the origin, where the pinned loop touches the boundary of the domain). It will therefore be natural to work with chordal ε -admissible explorations instead of radial ones. This will be rather similar to the radial case, but it is nonetheless useful to describe it in some detail:

It is convenient to first consider the domain to be the upper half-plane and to take ∞ as the marked boundary point instead of the origin. Suppose that Γ is a loop configuration (with no pinned loop) in the upper half-plane \mathbb{H} and choose some bounded closed simply connected set $A \subset \overline{\mathbb{H}}$ such that

1. $\mathbb{H} \setminus A$ is simply connected,
2. A is the closure of the interior of A ,
3. the interior of A is connected, and
4. the length of $\partial A \cap \partial \mathbb{H}$ is positive.

Suppose furthermore that all γ_j 's in Γ that intersect ∂A also intersect the interior of A .

Here, when $x \in \mathbb{R}$, $D(x, \varepsilon)$ will denote the set of points in \mathbb{H} that are at distance less than ε from x . We choose some x_1 on the real line, such that $D(x_1, \varepsilon) \subset A$. Then, we define the set H_1 to be the unbounded connected component of the set obtained when removing from $\mathbb{H} \setminus D(x_1, \varepsilon)$ all loops of Γ that intersect $D(x_1, \varepsilon)$. We also define the conformal map g_1 from H_1 onto \mathbb{H} that is normalized at infinity ($g_1(z) = z + o(1)$ as $z \rightarrow \infty$), and we let $A_2 = g_1(H_1 \cap A)$.

Then, we proceed inductively: For each $n \geq 1$, we choose (when it is possible) x_{n+1} on the real line such that $D(x_n, \varepsilon) \subset A_n$. Then we consider the set H_{n+1} to be the unbounded connected component of the set obtained when removing from $\mathbb{H} \setminus D(x_n, \varepsilon)$ all loops of $g_n \circ \dots \circ g_1(\Gamma)$ that intersect $D(x_n, \varepsilon)$. We also define the conformal map g_{n+1} from H_{n+1} onto \mathbb{H} that is normalized at infinity ($g_{n+1}(z) = z + o(1)$ as $z \rightarrow \infty$), and we let $A_{n+1} = g_{n+1}(H_{n+1} \cap A_n)$.

This procedure necessarily has to stop at some step N , i.e., at this step N , it is not possible to find a point x such that $D(x, \varepsilon) \subset H_N$. This is just because of additivity of the half-plane capacity under composition of the conformal maps (and because the half-plane capacity of A is finite). We say that such an exploration is an ε -admissible (chordal) exploration of (Γ, A) rooted at infinity. The results of Subsection 3.2 and their proofs can be immediately adapted to the present setting. It is for instance easy to check that for any given Γ , for any given loop γ_j in Γ that intersects such a given A , there exists a positive $\varepsilon_0 = \varepsilon_0(\Gamma, A, \gamma_j)$ such that any ε -admissible chordal exploration of (Γ, A) necessarily discovers the loop γ_j as soon as $\varepsilon \leq \varepsilon_0$. Hence, after the last step N of this ε -exploration of (Γ, A) , for all positive α , when ε is chosen to be sufficiently small, one has necessarily discovered all loops of diameter greater than α of Γ that intersect A .

Let us now suppose that Γ is a loop configuration and A is a set satisfying the same conditions as before, except that we also assume that it is at positive distance of the origin. We can now define chordal ε -explorations of (Γ, A) that are rooted at 0: These are just the image under $z \mapsto -1/z$ of the previous explorations of $(-1/\Gamma, -1/A)$, where $-1/\Gamma$ denotes the loop configuration obtained when one considers the loops $(-1/\gamma_j)$. The difference between the exploration rooted at the origin and the exploration rooted at infinity in fact only lies in what we call $D(x, \varepsilon)$, and how one renormalizes the conformal maps g_n at each step. In the exploration rooted at the origin, $D(x, \varepsilon)$ would have to be replaced by the conformal image of $D(x, \varepsilon)$ under the conformal mapping from \mathbb{H} onto \mathbb{H} that fixes x , has derivative 1 at x and maps ∞ onto 0, and the conformal

map g_n^{-1} would have to be replaced by the conformal map G_n from \mathbb{H} onto H_n such that $G_n(z) = z + o(z^2)$ when $z \rightarrow 0$.

Let us describe more precisely an iteration step in this case: Let us define, for each $x \in \mathbb{R} \setminus \{0\}$ and each small ε , $C_\varepsilon(x)$ to be the image of C_ε under the Moebius transformation $I_x : z \mapsto -x/(xz - 1)$ of \mathbb{H} that maps 0 onto x and ∞ onto 0. Note that for all x and y in $\mathbb{R} \setminus \{0\}$, $I_x \circ I_y^{-1}(z) \sim z$ when $z \rightarrow 0$ and that $I_x \circ I_y^{-1}(C_\varepsilon(y)) = C_\varepsilon(x)$. When ε is very small, $C_\varepsilon(x)$ is very close to the semi-circle of radius $x^2\varepsilon$ around x (i.e., it is squeezed between to semi-circles of radii close to $x^2\varepsilon$) because $I'_x(0) = x^2$.

Suppose that H_n, G_n are already defined. The choice of x_n is then said to be ε -admissible if $C_\varepsilon(x_n) \subset G_n^{-1}(H_n \cap A)$. We then define H_{n+1} to be the unbounded connected component the domain by removing from $H_n \setminus G_n(C_\varepsilon(x_n))$ all the loops that intersect $G_n(C_\varepsilon(x_n))$.

Clearly, after the last step N of this exploration rooted at the origin (when no ε -admissible point can be found), we again have a set H_N that is in some sense close to H (which is the unbounded connected component of the domain obtained when removing from $\mathbb{H} \setminus A$ all loops that intersect A). One way to make this more precise is to use the Carathéodory topology “seen from the origin”. Even if the origin is a boundary point of the simply connected domains H_N and H , we can symmetrize these domains (by considering their union with their symmetric sets with respect to the real axis), and therefore view the conformal maps G_N and G as conformal maps normalized at the origin, which is now an inner point of the domain. We will implicitly use this topology for domains in the upper half-plane “viewed from the origin”. Then, just as in Subsection 3.2, we get that (for each given Γ and A) H_N converges to H , when $\varepsilon \rightarrow 0$, uniformly with respect to all possible ε -admissible explorations.

5.3 Definition of the two-point pinned measure

We know that the μ -mass of the set of pinned loops that intersect the segment $[1, 1+i]$ is positive and finite. By scaling, we can choose a in such a way that the μ -mass of the set of pinned loops that intersect $[a, a(1+i)]$ is equal to 1. On this set of configurations, μ can therefore be viewed as a probability measure. Similarly, the pinned configuration measure $\bar{\mu}$ restricted to the set

$$\mathcal{A} = \mathcal{A}([a, a+ia]) = \{(\bar{\gamma}, \bar{\Gamma}) : \bar{\gamma} \cap [a, a+ia] \neq \emptyset\}$$

is a probability measure that we will denote by $\tilde{P}_{[a, a+ia]}$.

Let us now consider a pinned configuration $(\bar{\gamma}, \bar{\Gamma})$ in \mathcal{A} . Define $u = \min\{y : a+iy \in \bar{\gamma}\}$ so that $a+iu$ is the lowest point of $\bar{\gamma} \cap [a, a+ia]$. Let ψ denote the conformal map from the unbounded connected component H_ψ of the set obtained by removing from $\mathbb{H} \setminus [0, a+iu]$ all the loops of $\bar{\Gamma}$ that intersect this segment back onto \mathbb{H} , normalized by $\psi(0) = 0$, $\psi'(0) = 1$ and $\psi(a+iu) = 1$. We then define \tilde{P} to be the distribution of $\tilde{\gamma} = \psi(\bar{\gamma})$, i.e. the image of the probability measure $\tilde{P}_{[a, a+ia]}$ under the transformation $(\bar{\gamma}, \bar{\Gamma}) \mapsto \psi(\bar{\gamma})$. A by-product of the coming arguments will be that in fact:

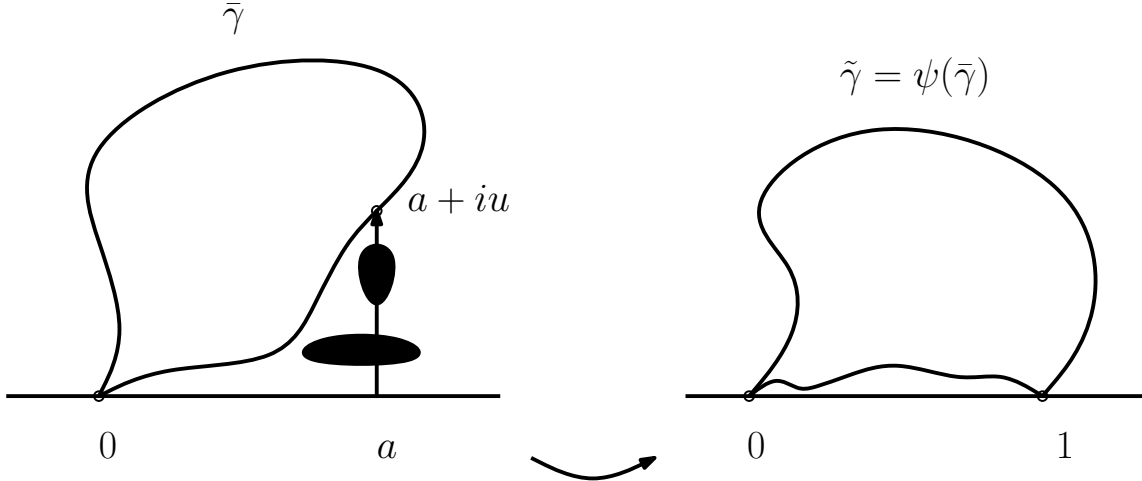

Figure 18: The construction of the two-point pinned loop (sketch)

Proposition 5.3. *Under $\tilde{P}_{[a, a+ia]}$, the loop $\tilde{\gamma}$ is independent of ψ .*

Define on the other hand the probability measure \tilde{P}_ε to be the measure μ restricted to the set of pinned loops that intersect $C_\varepsilon(1)$, and renormalized in order to be a probability measure. The main first goal of this subsection is to derive the following proposition (which we will later prove together with Proposition 5.3):

Proposition 5.4 (Definition of the two-point pinned measure \tilde{P}). *As $\varepsilon \rightarrow 0$, \tilde{P}_ε converges to \tilde{P} .*

As we have already indicated, the basic idea of the proof will be similar in spirit with the construction of the pinned measure itself: We will use discrete explorations of pinned configurations, and use the restriction property of the pinned measure in order to deduce some independence property between the already discovered loops and the yet-to-be-discovered ones along the exploration; this will enable us to conclude.

Suppose now that A is a set that is at positive distance from the origin, and that satisfies the conditions 1-4 described in the previous subsection. Clearly, if we define

$$\bar{\mathcal{A}}(A) = \{(\bar{\gamma}, \bar{\Gamma}) : \bar{\gamma} \cap A \neq \emptyset\},$$

then $\bar{\mu}(\bar{\mathcal{A}}(A))$ is finite and positive. We can therefore define \tilde{P}_A to be $\bar{\mu}$ restricted to this set, and renormalized in order to be a probability measure.

Suppose now that $H \subset \mathbb{H}$ is a simply connected domain with $d(0, \mathbb{H} \setminus H) > 0$. Define ϕ to be the conformal map from H onto \mathbb{H} such that $\phi(z) = z + o(z^2)$ when $z \rightarrow 0$, and suppose that $C \subset H$ is a set such that $A := \phi(C)$ satisfies the same conditions as before. We then define \tilde{P}_C^H to be the image of \tilde{P}_A under ϕ^{-1} . Basically, \tilde{P}_C^H is the “law” of a pinned configuration in H rooted at the origin and “conditioned” on the event that the pinned loop intersects C .

Suppose now that B is another set at positive distance of the origin that satisfies the four conditions described in the previous subsection and such that $A \subset B$. We are now going to define, for each such B and A , the measure $\bar{\mu}_{B,A}$ to be the measure $\bar{\mu}$ on pinned configurations $(\bar{\gamma}, \bar{\Gamma})$, restricted to the set $\bar{\mathcal{A}}(B, A) = \bar{\mathcal{A}}(B) \setminus \bar{\mathcal{A}}(A)$ of configurations such that $\bar{\gamma}$ intersects B but not A . When $\bar{\mu}(\bar{\mathcal{A}}(B)) > \bar{\mu}(\bar{\mathcal{A}}(A))$, we then define $\tilde{P}_{B,A}$ to be $\bar{\mu}_{B,A}$ normalized to be a probability measure.

Finally, when we are given $\bar{\Gamma}$ and A , we can define the set \bar{H}_A as before (i.e., the unbounded connected component of the set obtained by removing from $\mathbb{H} \setminus A$ all the loops of $\bar{\Gamma}$ that intersect A). Then, it follows immediately from the pinned measure's restriction property (Proposition 5.2) that:

Corollary 5.5. *Suppose that $(\bar{\gamma}, \bar{\Gamma})$ is sampled according to $\tilde{P}_{B,A}$. Then the conditional law of $\bar{\gamma}$ given $\tilde{\Gamma}_A$ (i.e., the loops of $\bar{\Gamma}$ that intersect A) is $\tilde{P}_{B \cap H}^H$ where $H = \bar{H}_A$.*

Suppose now that we are given a configuration $(\bar{\gamma}, \bar{\Gamma})$ that is sampled according to \tilde{P}_A . For each given ε , we can perform a ‘‘Markovian’’ ε -admissible exploration as before (Markovian can simply mean here that we have chosen some deterministic procedure to choose each x_n). When $\bar{\gamma}$ intersects A , this exploration procedure can discover $\bar{\gamma}$ at some (random) step that we call $\bar{N} + 1$, and we know that when $\varepsilon \rightarrow 0$, the probability that \bar{N} exists tends to 1.

Corollary 5.5 shows that conditionally on $\bar{N} = n$, on H_n and on x_n , the law of $\bar{\gamma}$ is $\tilde{P}_{G_n(C_\varepsilon(x_n))}^{H_n}$. This implies in particular that the conditional law of $I_1 \circ I_{x_{\bar{N}}}^{-1} \circ G_{\bar{N}}^{-1}(\bar{\gamma})$ is \tilde{P}_ε (recall that $\psi_{\bar{N}} := I_1 \circ I_{x_{\bar{N}}}^{-1} \circ G_{\bar{N}}^{-1}$ is just the conformal map from $H_{\bar{N}}$ onto \mathbb{H} that maps the origin onto itself, has derivative at the origin equal to 1, and that maps $G_{\bar{N}}(x_{\bar{N}})$ onto 1). Hence (on the event $\bar{N} < \infty$), $\psi_{\bar{N}}(\bar{\gamma})$ is in fact independent of \bar{N} and of $H_{\bar{N}}$.

It is worth stressing at this point that the law of \bar{N} is not geometric as in the CLE case, and that the iteration steps are not i.i.d. anymore, but this will not prevent us from now proving Propositions 5.4 and 5.3:

Proof. The arguments are again close in spirit to the definition of the pinned measure itself. Suppose that K is a large integer, that $\delta = 1/K$, and consider the rectangles $A_{\delta,k} = [a - \delta/2, a + \delta/2] \times [0, ak\delta]$ for $k = 1, \dots, K$. Note that because of scale-invariance and translation invariance, for each given δ , up to a set of configurations of zero measure, all the loops of $(\bar{\gamma}, \bar{\Gamma})$ that intersect some $A_{\delta,k}$ also intersect its interior (when δ is fixed). Furthermore, the probability measure $\tilde{P}_{A_{\delta,K}}$ converges to $\tilde{P}_{[a, a(1+i)]}$.

For each fixed $\delta = 1/K$, we can start to explore each $(\bar{\Gamma} \cup \{\bar{\gamma}\}, A_{\delta,1})$ by a Markovian chordal ε -admissible exploration rooted at 0, then continue exploring $(\bar{\Gamma} \cup \{\bar{\gamma}\}, A_{\delta,2})$ and so on until we either complete a chordal ε -admissible exploration of $A_{\delta,K} = [a - \delta, a + \delta] \times [0, a]$, or we have discovered $\bar{\gamma}$. When $(\bar{\gamma}, \bar{\Gamma})$ is sampled according to \tilde{P} , the probability to discover $\bar{\gamma}$ is going to 1 as $\varepsilon \rightarrow 0+$. Let us call (as before) $\bar{N} + 1$ the (random) step at which $\bar{\gamma}$ is discovered.

Furthermore, for each given δ , it is possible to choose ε small enough, so that the probability that the exploration processes misses no loop of $\bar{\Gamma}$ of diameter greater than 4δ that intersects $[a, a + ia]$ is as close to 1 as we want.

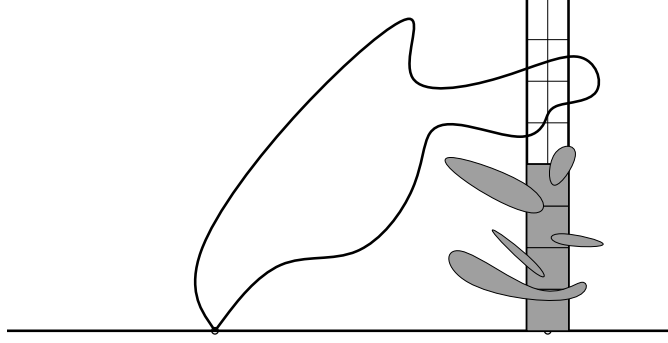

Figure 19: Exploration of the thin rectangle (sketch)

The very same arguments as in the proof of Proposition 3.4 then show that if $\varepsilon(\delta)$ is chosen to be sufficiently small, then the set $H_{\bar{N}}$ converges to H_ψ almost surely, and that $\psi_{\bar{N}}$ converges almost surely to ψ . We then conclude using the independence between $\psi_{\bar{N}}$ and $\psi_{\bar{N}}(\bar{\gamma})$. We safely leave the details to the reader. \square

A consequence of Proposition 5.4 is that the probability measure \tilde{P} is invariant under all Moebius transformations of \mathbb{H} onto itself that have 0 and 1 as fixed points. This follows immediately from the conformal covariance property of μ and the description of \tilde{P} as limits of \tilde{P}_ε given in the proposition.

In fact, our proof of Proposition 5.4 works also if we replace the straight segment $[a, a(1+i)]$ by any given other piecewise linear path starting at 1 such that the μ mass of the set of pinned loops that it intersects is finite (we can then just multiply μ by a constant to turn it into a probability measure on this set): Suppose that η is some finite piecewise linear path that starts on the real line, has no double points, and such that all of its segments are horizontal or vertical. We parametrize it “from the real axis to the tip”.

For each pinned configuration $(\bar{\gamma}, \bar{\Gamma})$ such that $\bar{\gamma} \cap \eta \neq \emptyset$, we can define the first meeting time T of η with $\bar{\gamma}$, i.e. $T = \min\{t : \eta(t) \in \bar{\gamma}\}$. Let us now consider $\tilde{\Gamma}_\eta$ to be the set of loops of $\bar{\Gamma}$ that intersect $\eta[0, T]$, and let ψ denote the conformal map as before (that maps the set obtained by removing from $\mathbb{H} \setminus \eta[0, T]$ all the loops of $\bar{\Gamma}$ that intersect $\eta[0, T]$ back onto \mathbb{H} , normalized by $\psi(0) = 0$, $\psi'(0) = 1$ and $\psi(\eta(T)) = 1$). Note that $\psi(\bar{\gamma})$ is a pinned loop (the map ψ is smooth near the origin). Note also that $\bar{\mu}(\bar{\gamma} \cap \eta \neq \emptyset)$ is positive and finite. Then:

Proposition 5.6. *If we consider the measure $\bar{\mu}$ on the event $\{\bar{\gamma} \cap \eta \neq \emptyset\}$ and if we renormalize it to be a probability measure, then under this probability measure, $\tilde{\gamma} = \psi(\bar{\gamma})$ is distributed according to the two-point pinned distribution \tilde{P} . Furthermore, $\tilde{\gamma}$ is independent of the conformal map ψ .*

5.4 Independence property of two-point pinned loops

We are now going to derive the key independence property of the two-point pinned measure. Suppose that $\tilde{\gamma}$ is a two-point pinned loop in \mathbb{H} that touches the real line at 0 and 1. We can define two simple paths γ^* and γ_* from 0 to 1 in \mathbb{H} in such a way that their union is $\tilde{\gamma}$ and that γ_* is “below” γ^* . We now define ψ_* to be the conformal map from the unbounded connected component H_* of $\mathbb{H} \setminus \gamma_*$ onto \mathbb{H} that fixes the three boundary points 0, 1 and ∞ , and finally, we define $U(\tilde{\gamma}) = \psi_*(\gamma^*)$.

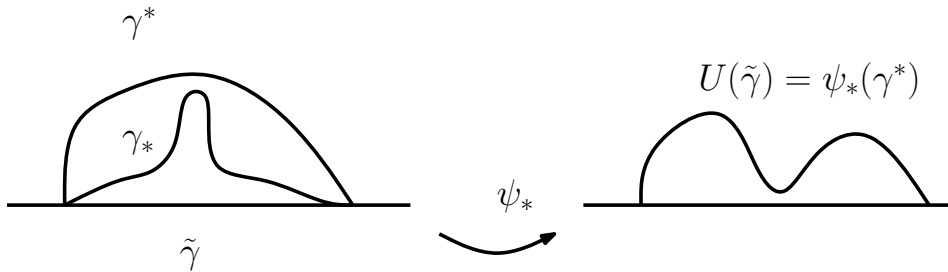

Figure 20: Construction of $U(\tilde{\gamma})$ (sketch)

Proposition 5.7. *If $\tilde{\gamma}$ is chosen according to the two-point pinned measure \tilde{P} , then $U(\tilde{\gamma})$ and γ_* are independent.*

Recall on the one hand that \tilde{P} is the limit of \tilde{P}_ε when $\varepsilon \rightarrow 0$. Let us now consider a hull $A \subset \overline{\mathbb{H}}$ that is attached to the interval $(0, 1)$ that satisfies the conditions 1-4 as before. Let $B = A \cup C_\varepsilon(1)$ where ε is sufficiently small, so that $C_\varepsilon(1) \cap A = \emptyset$. Let us now describe the law of $\tilde{\gamma}$ conditioned to avoid A , trying to use Corollary 5.5. Remark first that it is the limit when $\varepsilon \rightarrow 0$ of the pinned measure “renormalized in order to be a probability” on the event $\mathcal{A}(B, A)$ i.e. on the event where γ intersects $C_\varepsilon(1)$ but not A .

But this measure can be described using Corollary 5.5, and we could use this to prove Proposition 5.7 directly. Let us however describe first the “explicit restriction-type-property” for the law \tilde{P} of the two-point pinned loop $\tilde{\gamma}$. Suppose that A is such that $A \cap \mathbb{R} \subset (0, 1)$, and that $\mathbb{H} \setminus A$ is simply connected. We would like describe the conditional law of $\tilde{\gamma}$ given that it does not intersect A .

In order to do so, let us use a CLE $\Gamma^\#$ that is independent of $\tilde{\gamma}$. We will use \tilde{E} , $E^\#$ and $\tilde{E}^\#$ to denote the expectation with respect to $\tilde{\gamma}$, to $\Gamma^\#$ and to both. We define $H^\#$, the unbounded connected component of the set obtained by removing from $\mathbb{H} \setminus A$ all the loops of $\Gamma^\#$ that intersect A . Then, we define the conformal map $\varphi_\#$ from $H^\#$ onto \mathbb{H} such that $\varphi_\#(0) = 0$, $\varphi_\#(1) = 1$ and $\varphi'_\#(1) = 1$. It is easy to check that $\varphi'_\#(0) \leq 1$. The loop $\varphi_\#^{-1}(\tilde{\gamma})$ is clearly two-point pinned loop that avoids A almost surely.

Proposition 5.8. *The conditional law of $\tilde{\gamma}$ given $\tilde{\gamma} \cap A = \emptyset$ satisfies, for a bounded continuous function F on the set of loops,*

$$\tilde{E}(F(\tilde{\gamma})|\tilde{\gamma} \cap A = \emptyset) = \frac{\tilde{E}^\#(\varphi'_\#(0)^\beta F(\varphi_\#^{-1}(\tilde{\gamma})))}{E^\#((\varphi'_\#(0))^\beta)}.$$

Proof. Proposition 5.4 shows that

$$\tilde{E}(F(\tilde{\gamma})|\tilde{\gamma} \cap A = \emptyset) = \lim_{\varepsilon \rightarrow 0} \frac{\mu(F(\gamma)1_{\gamma \cap A = \emptyset}1_{\gamma \cap C_\varepsilon(1) \neq \emptyset})}{\mu(1_{\gamma \cap A = \emptyset}1_{\gamma \cap C_\varepsilon(1) \neq \emptyset})}.$$

The measure μ restricted to the set of loops that do not intersect A , is equal to μ_A by Proposition 5.1. Recall that in order to define μ_A , we use another CLE $\Gamma^\#$, that we consider the set $H^\#$ and the conformal map $\psi^\#$ from \mathbb{H} onto $H^\#$ such that $\psi^\#(0) = 0$, $(\psi^\#)'(0) = 1$ and $\psi^\#(\infty) = \infty$, and that μ_A is the image of the product measure $\mu \otimes P$ under the mapping $(\gamma, \Gamma^\#) \mapsto \psi^\#(\gamma)$. Hence,

$$\tilde{E}(F(\tilde{\gamma})|\tilde{\gamma} \cap A = \emptyset) = \lim_{\varepsilon \rightarrow 0} \frac{E^\#(\mu(F(\psi^\#(\gamma))1_{\psi^\#(\gamma) \cap C_\varepsilon(1) \neq \emptyset}))}{E^\#(\mu(1_{\psi^\#(\gamma) \cap C_\varepsilon(1) \neq \emptyset}))}.$$

But when ε is very small, the ε -neighborhood of 1 is not much distorted by $\varphi_\#$. Furthermore, $\psi^\# \circ \varphi_\#$ is a conformal mapping from the upper half-plane into itself, that depends on $\Gamma^\#$ only, that maps the origin onto itself and its derivative at the origin is equal to $\varphi'_\#(0)$. Recall also that μ satisfies conformal covariance with the exponent β . It follows easily by dominated convergence that

$$\begin{aligned} & \tilde{E}(F(\tilde{\gamma})|\tilde{\gamma} \cap A = \emptyset) \\ &= \lim_{\varepsilon \rightarrow 0} \frac{E^\#(\varphi'_\#(0)^\beta \mu(F(\varphi_\#^{-1}(\tilde{\gamma}))1_{\gamma \cap C_\varepsilon(1) \neq \emptyset}))}{E^\#(\varphi'_\#(0)^\beta \mu(1_{\gamma \cap C_\varepsilon(1) \neq \emptyset}))} \\ &= \lim_{\varepsilon \rightarrow 0} \left(\frac{E^\#(\varphi'_\#(0)^\beta \mu(F(\varphi_\#^{-1}(\tilde{\gamma}))1_{\gamma \cap C_\varepsilon(1) \neq \emptyset}))}{\mu(1_{\gamma \cap C_\varepsilon(1) \neq \emptyset})} \times \frac{\mu(1_{\gamma \cap C_\varepsilon(1) \neq \emptyset})}{E^\#(\varphi'_\#(0)^\beta \mu(1_{\gamma \cap C_\varepsilon(1) \neq \emptyset}))} \right) \\ &= \frac{E^\#(\varphi'_\#(0)^\beta \tilde{E}(F(\varphi_\#^{-1}(\tilde{\gamma})))}{E^\#(\varphi'_\#(0)^\beta)}. \end{aligned}$$

□

We now use this to derive Proposition 5.7:

Proof. Let us consider an independent CLE $\Gamma^\#$ as before, and for each A as before, such that $A \cap \mathbb{R} \subset (0, 1)$, define $\varphi_\#$. It is important to observe that if $\tilde{\gamma}$ is a two-point pinned loop, then $\varphi_\#^{-1}(\tilde{\gamma})$ is always a two-point pinned loop, and that $U(\varphi_\#^{-1}(\tilde{\gamma})) = U(\tilde{\gamma})$. Furthermore, note that the event $A \cap \tilde{\gamma} = \emptyset$ is identical to the event that $A \cap \gamma_* = \emptyset$.

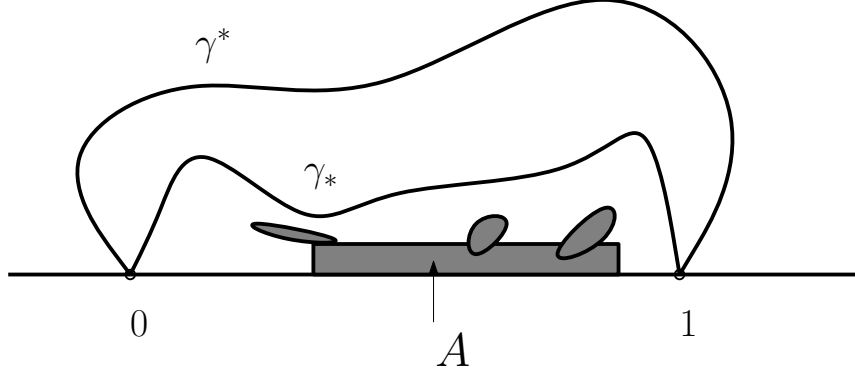

Figure 21: Proof of independence (sketch)

Hence, we get that for all continuous bounded function F on the space of loops (recall that γ and $\varphi_{\#}$ are independent)

$$\begin{aligned}
 \tilde{E}(F(U(\tilde{\gamma})) | \gamma_* \cap A = \emptyset) &= E^{\#}(\varphi'_{\#}(0)^{\beta})^{-1} \tilde{E}^{\#}(\varphi'_{\#}(0)^{\beta} F(U(\varphi_{\#}^{-1}(\tilde{\gamma})))) \\
 &= E^{\#}(\varphi'_{\#}(0)^{\beta})^{-1} \tilde{E}^{\#}(\varphi'_{\#}(0)^{\beta} F(U(\tilde{\gamma}))) \\
 &= E^{\#}(\varphi'_{\#}(0)^{\beta})^{-1} E^{\#}(\varphi'_{\#}(0)^{\beta}) \tilde{E}(F(U(\tilde{\gamma}))) \\
 &= \tilde{E}(F(U(\tilde{\gamma}))).
 \end{aligned}$$

Since this is true for all such A , it follows that $U(\tilde{\gamma})$ and γ_* are indeed independent. \square

In the sequel, we call P^* the law of $U(\tilde{\gamma})$. This is a probability measure on paths joining 1 to 0 in the upper half-plane. Note here that P^* is invariant under the Moebius transformations from \mathbb{H} onto itself that preserve 0 and 1. This follows easily from the corollary and from the fact that the same is true for the two-point pinned measure.

Let us define P^{**} to be the image of P^* under the conformal map $z \mapsto 1 - (1/z)$ of \mathbb{H} onto itself (that maps 1 to 0 and 0 to ∞). P^{**} is then a probability measure on simple paths in \mathbb{H} from 0 to infinity, that is scale-invariant (because the multiplications by positive constants are the Moebius transformations in \mathbb{H} that leave 0 and ∞ invariant).

6 Pinned loops and SLE excursions

6.1 Two-point pinned measure and SLE paths

The goal of this section is show that the pinned measure μ associated to a CLE is necessarily one of the ‘‘SLE excursion measures’’. Let us first combine the results of the previous section and reformulate them into a single tractable statement: Consider the pinned configuration measure $\bar{\mu}$ and some finite piecewise linear path η in \mathbb{H} that starts on the positive real half-line, has no double points, and such that all of its segments

are horizontal or vertical. We parametrize it “from the real axis to the tip”. We also suppose that

$$\mu(\{\gamma : \gamma \cap \eta \neq \emptyset\}) = 1.$$

so that we can view μ (and $\bar{\mu}$ on the corresponding set of configurations) as a probability measure.

For each pinned configuration $(\bar{\gamma}, \bar{\Gamma})$ such that $\bar{\gamma} \cap \eta \neq \emptyset$, we can define the first meeting time T of η with $\bar{\gamma}$, i.e. $T = \min\{t : \eta(t) \in \bar{\gamma}\}$. Let us now consider $\tilde{\Gamma}_\eta$ to be the set of loops of $\bar{\Gamma}$ that intersect $\eta[0, T]$. We also call γ_- the part of γ (when oriented counterclockwise) between 0 and $\eta(T)$, and γ^+ the other part. Let us now define the set H_- to be the unbounded connected component of the set obtained by removing from \mathbb{H} the union of γ_- , $\eta[0, T]$ and the loops of $\tilde{\Gamma}_\eta$. We let ψ_- denote the conformal map from H_- onto \mathbb{H} such that $\psi_-(0-) = 0$, $\psi_-(\eta(T)) = 1$ and $\psi_-(\infty) = \infty$.

Note that ψ_- , γ_- and $\tilde{\Gamma}_\eta$ are all deterministic functions of the triple $(\bar{\gamma}, \bar{\Gamma}, \eta)$. We will sometimes write $\psi_{-, \eta}$ and $\gamma_{-, \eta}$, $\gamma^{+, \eta}$ to indicate the dependence in η .

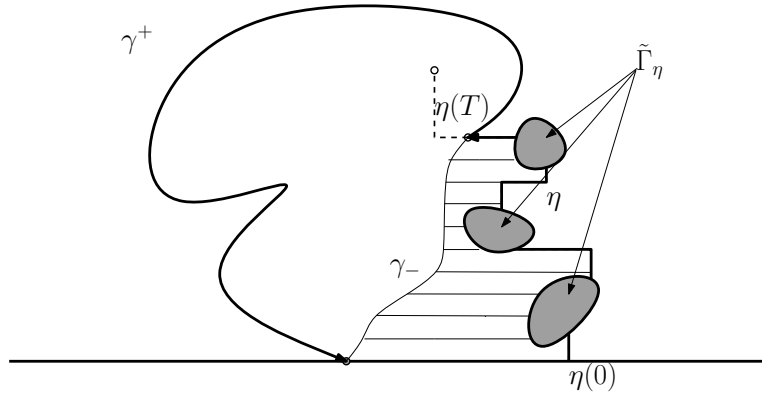

Figure 22: Use of independence (sketch)

Proposition 6.1. $\psi_-(\gamma^+)$ is independent of ψ_- and γ_- , and its law is P^* .

Proof. This is a direct combination of our previous results. Let ψ_η denote the conformal map from $\mathbb{H} \setminus (\eta[0, T] \cup \tilde{\Gamma}_\eta)$ onto \mathbb{H} with $\psi_\eta(0) = 0$, $\psi_\eta(\eta(T)) = 1$ and $\psi_\eta(\infty) = \infty$. Conformal invariance of \tilde{P} under the maps that preserve 0 and 1, and the definition of the two-point pinned measure shows that $\psi_\eta(\gamma)$ is independent of ψ_η and that its law is the two-point pinned measure \tilde{P} .

If we now define $\gamma_* = \psi_\eta(\gamma_-)$ and $\gamma^* = \psi_\eta(\gamma^+)$, and ψ_* (which depends on γ_* alone) as before, we know from Proposition 5.7 that $\psi_*(\gamma^*)$ is independent of γ_* , and its law is P^* . Hence, $\psi_*(\gamma^*)$ is independent of $(\gamma_*, \psi_*, \psi_\eta)$.

We can now conclude, noting that $\psi_*(\gamma^*) = \psi_-(\gamma^+)$ and that $\gamma_- = \psi_\eta^{-1}(\gamma_*)$. \square

Suppose now that $\eta : [0, l] \rightarrow \mathbb{H} \cup \eta(0)$ is a finite piecewise linear path as before, except that $\mu(\{\gamma : \gamma \cap \eta[0, l] \neq \emptyset\})$ is not equal to one. We can use scaling in order to

find some constant λ , in such a way that we can apply the previous statement to $\lambda\eta$, and it therefore follows that Proposition 6.1 still holds if we consider the measure μ on the event $\{\gamma : \gamma \cap \eta[0, l] \neq \emptyset\}$, and renormalized in order to be a probability measure on this event. Since this is true for all l , it also follows that:

Corollary 6.2. *The same statement holds if we consider the measure μ restricted to the event that γ intersects only the last segment of η (and not the previous ones), and if we renormalize the measure μ to be a probability measure on this event.*

We now want to deduce from this corollary that P^* is the law of some SLE_κ from 1 to 0 in \mathbb{H} i.e., that P^{**} is the law of some chordal SLE_κ in \mathbb{H} . We will use Oded Schramm's conformal Markov property characterization of SLE that we now briefly recall. Suppose that one is given a continuous simple curve ξ in $\mathbb{H} \cup \{0\}$ starting at 0. Let us parametrize ξ according to its half-plane capacity, i.e., in such a way that for each t , there exists a conformal map g_t from $H_t := \mathbb{H} \setminus \xi[0, t]$ onto \mathbb{H} such that $g_t(z) = z + 2t/z + o(1/z)$ as $z \rightarrow \infty$. Suppose that the half-plane capacity of ξ is not bounded (i.e., that ξ is defined for all $t \geq 0$), and define $f_t(z) = g_t(z) - g_t(\xi_t)$, i.e. the conformal map from H_t onto \mathbb{H} with $f_t(\xi_t) = 0$ and $f_t(z) \sim z$ at infinity. Then:

Lemma 6.3 (Schramm [35]). *If the law of ξ is scale-invariant in distribution (i.e., the law of $(\lambda^{-1}\xi_{\lambda^2 t}, t \geq 0)$ does not depend on λ), and if for all $t \geq 0$, the conditional law of $f_t(\xi[t, \infty))$ given $\xi[0, t]$ is identical to the initial law of ξ , then ξ is an SLE curve.*

Recall that this result can be easily understood using Loewner's theory of slit mappings that shows that the curve ξ is characterized by the function $t \mapsto W_t := g_t(\xi_t)$. Indeed, the previous conditions imply on the one hand that the random function $t \mapsto W_t$ has the Brownian scaling property (because ξ is scale-invariant in distribution) and on the other hand that it is a continuous process with independent increments. These two facts imply that W is a multiple of a standard Brownian motion (and one can call this multiplicative constant $\sqrt{\kappa}$). As the function W fully characterizes ξ , this determines the law of the path ξ (up to this one-parameter choice). Furthermore, SLE computations (see [35]) show that the fact that the curve is simple implies that $\kappa \leq 4$.

There are several natural ways that one can use in order to parametrize a pinned loop. We are going to choose one that is tailored for our purpose, i.e., to recognize SLE excursions. Let us first define r_0 in such a way that

$$\mu(R(\gamma) \geq r_0) = 1.$$

Then, the measure μ restricted to the set $\mathcal{Q} = \{\gamma : R(\gamma) \geq r_0\}$ is a probability measure that we will call Q in the present section. Until the rest of the present subsection, we will assume that γ is sampled from this probability measure.

Suppose now that $\gamma \in \mathcal{Q}$ and let us orient it "anti-clockwise", i.e., γ starts at 0, makes a simple anti-clockwise loop in \mathbb{H} and comes back to 0. On the way, there is the first intersection point z_0 of γ with $\{z : |z| = r_0\}$. We define $b_0 := b_0(\gamma)$ the

beginning part of the loop between 0 and z_0 (with the anti-clockwise orientation) and we call $e_0 := e_0(\gamma)$ the other (end-)part of the loop γ between z_0 and 0.

Let h_0 denote the conformal mapping from $\mathbb{H} \setminus b_0$ onto \mathbb{H} normalized by $h_0(z_0) = 0$, $h_0(\infty) = 1$ and $h_0(0-) = \infty$ (where $h_0(0-)$ denotes the image of the left-limit of 0 in $\mathbb{H} \setminus b_0$). The end-part $e_0 = e_0(\gamma)$ of the loop between z_0 and 0 is a continuous simple path from z_0 to $0-$ in $(H \setminus b_0) \cup \{z_0, 0-\}$. Hence, its image under h_0 is a simple path from 0 to infinity in the upper half-plane that we now call ξ . We parametrize ξ according to its half-plane capacity as before (and define the conformal maps g_t and f_t). This therefore defines (via the map h_0^{-1}) a parametrization of the path e_0 .

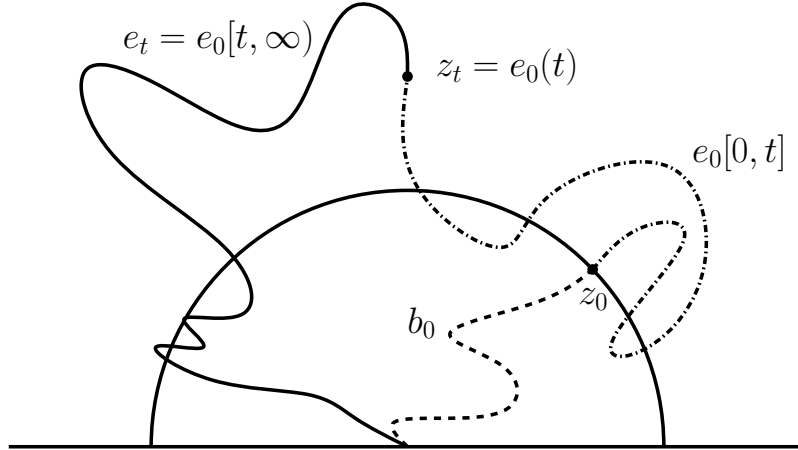

Figure 23: Definition of $e_t(\gamma)$ and $b_t(\gamma)$ (sketch)

For each $t \geq 0$, we now define $z_t = e_0(t)$,

$$b_t := b_t(\gamma) = b_0(\gamma) \cup e_0[0, t] \text{ and } e_t := e_t(\gamma) = e_0[t, \infty).$$

Let us insist on the fact that b_t and e_t are paths (and not points). h_t will denote the conformal map from $\mathbb{H} \setminus b_t(\gamma)$ with $h_t(z_t) = 0$, $h_t(0-) = \infty$ and $h_t(\infty) = 1$. We will now prove the following statement that we will then combine with Lemma 6.3:

Lemma 6.4. *Under the probability measure Q , for each given $t \geq 0$, $h_t(e_t(\gamma)) = f_t(\xi[t, \infty))$ is independent of $b_t(\gamma)$. Furthermore, its law is P^{**} .*

Proof. Let us fix $t \geq 0$. Define ψ_t the conformal map from $\mathbb{H} \setminus b_t(\gamma)$ on \mathbb{H} with $\psi_t(z_t) = 1$, $\psi_t(\infty) = \infty$, $\psi_t(0-) = 0$. Then, the lemma is clearly equivalent to the fact that $\psi_t(e_t)$ is independent of $b_t(\gamma)$, and that its law is P^* .

Define $b_t(\gamma)$ as before (when γ is defined under the probability measure Q). The proof will be based on the independence property of the two-point pinned measure. In order to use this, we will need to discover the pinned loop via some grid-based path that turns out to be close to b_t . Take $n \geq 1$. Let us try to associate to each $b = b_t(\gamma)$ a grid approximation of b_t “from the right side”, that we will call β_n .

First of all, let us note that the diameter of $b_{t+2/n} \setminus b_{t-1/n}$ goes to 0 almost surely when $n \rightarrow \infty$ and that we can find some sequence $\varepsilon_n \rightarrow 0$ such that

$$\lim_{n \rightarrow \infty} Q(d(b_{t-1/2n}, e_t) \geq \varepsilon_n) = 1$$

(this follows easily from the fact that γ is Q -almost surely a simple curve), where here d denotes the usual Euclidean distance. Then, when δ is a mesh-size, we try to define a particular grid-approximation of $b_{t-1/n}$ on the grid $(\delta\mathbb{N}) \times (\delta\mathbb{Z})$ as follows: Delete all the edges from the grid that are distance less than δ from $b_{t-1/n}$, and consider the unbounded connected component C of the graph that one obtains. Let f denote the first edge of C that γ hits (it is therefore after “time” $t - 1/n$). It is clearly on the “boundary of C seen from $b_{t-1/n}$ ”, and one can find the simple nearest-neighbor path from the positive real axis to f (where f is its last edge) on C that is “closest” to $b_{t-1/n}$. We call this path $\beta = \beta(b, t, n, \delta)$.

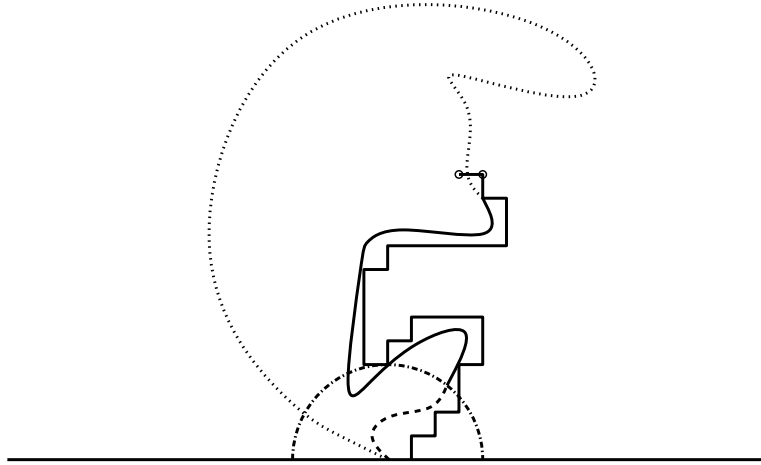

Figure 24: Grid-approximation of some $b_t(\gamma)$ (sketch)

Clearly, when t , n and b are fixed, then when $\delta \rightarrow 0$, the (Hausdorff) distance between β and b is going to 0. Hence, we can choose δ_n in such a way that

$$\lim_{n \rightarrow \infty} Q(d_H(\beta, b_{t-1/n}) \leq \varepsilon_n^2) = 1$$

(where d_H denotes the Hausdorff distance).

Once these sequences δ_n and ε_n are chosen, we denote for each given n , the grid approximation $\beta(b, t, n, \delta_n)$ by β_n . The previous estimates also ensure that

$$\lim_{n \rightarrow \infty} Q((\gamma \cap \beta_n) \subset b_{t+1/n} \setminus b_{t-1/n}) = 1.$$

Furthermore, we can observe that if we are given b_t and a finite grid-path η on $\delta_n\mathbb{Z} \times \delta_n\mathbb{N}$, it suffices to look at the path b_t only until the moment it hits η for the first time to check whether $\beta_n = \eta$ or not.

Suppose now that η is some given grid-path that has a positive probability to be equal to β_n . Let us consider a pinned configuration $(\gamma, \bar{\Gamma})$ such that γ intersects η_T , and let us define $\psi_- = \psi_{-, \eta}$, $\gamma_- = \gamma_{-, \eta}$ and $\gamma^+ = \gamma^{+, \eta}$ as before (recall that γ_- and γ^+ are the two parts of γ , before and after it hits $\eta(T)$, which is the first point of η that intersects γ , and that ψ_- corresponds to the domain where one from $\mathbb{H} \setminus \eta[0, T]$ the loops of $\bar{\Gamma}$ that intersect $\eta[0, T)$). Then, we know on the one hand that $\psi_-(\gamma^+)$ is independent of ψ_- and γ_- , and that its law is P^* . On the other hand, we have just argued that the event $\{\beta_n = \eta\}$ is measurable with respect to γ_- (this is because γ_- contains the part of γ up to the first time it hits η), so that the conditional law of $\psi_-(\gamma^+)$ given $\{\beta_n = \eta\}$ is also P^* .

When $\beta_n = \eta$, we define $\psi_{n,-}$ to be this map ψ_- , and we also define $\gamma^{n,+}$ and $\gamma_{n,-}$ to be these γ^+ and γ_- . Note that when n is very large, the probability that β_n intersects some macroscopic loop of $\bar{\Gamma}$ is very small (this is because they are all at positive distance of $\bar{\gamma}$, and that β_n is very close to γ). This, and our definition of β_n ensures readily that $\gamma_{n,-}$ converges (in Hausdorff topology) to b_t , and that $\psi_{n,-}(\gamma^{n,+})$ converges to $\psi_t(e_t)$.

We are now almost ready to conclude: For any continuous bounded functions F and G with respect to the Hausdorff topology, we get that:

$$\begin{aligned}
Q(F(b_t(\gamma))G(\psi_t(e_t))) &= \lim_{n \rightarrow \infty} Q(F(\gamma_{n,-})G(\psi_{n,-}(\gamma^{n,+}))) \\
&= \lim_{n \rightarrow \infty} \sum_{\eta} Q(1_{\{\beta_n = \eta\}} F(\gamma_{-, \eta}) G(\psi_{-, \eta}(\gamma^{+, \eta}))) \\
&= \lim_{n \rightarrow \infty} \sum_{\eta} Q(1_{\{\beta_n = \eta\}} F(\gamma_{-, \eta})) \times P^*(G) \\
&= \lim_{n \rightarrow \infty} P^*(G) \times Q(F(\gamma_{n,-})) \\
&= P^*(G) \times Q(F(b_t(\gamma)))
\end{aligned}$$

where we have use the independence property of Corollary 6.2 between the second and the third line. \square

This lemma has a number of consequences: It implies (taking $t = 0$) that the law of ξ itself is P^{**} . We know also that P^{**} is scale-invariant. Hence, we get that ξ is a continuous simple curve from 0 to infinity in the upper half-plane, that is scale-invariant in law, and such that for all t , the conditional law of $f_t(\xi[t, \infty))$ given $\xi[0, t]$ is the same as the law of ξ itself. The previous characterization of SLE therefore implies that:

Corollary 6.5. *The curve ξ is an SLE_{κ} for some $\kappa \in [0, 4]$. Furthermore, ξ is independent of $b_0(\gamma)$.*

The independence between $b_0(\gamma)$ and ξ shows that the probability measure Q can be constructed as follows: First sample $b_0(\gamma)$; this defines its tip z_0 . Then draw an SLE_{κ} (for some given value of κ) from z_0 to 0- in $H \setminus b_0$. Standard SLE computations (see [36]) show that the probability that an SLE_{κ} from 1 to 0 in \mathbb{H} hits the (semi-)circle

of radius $\rho > 1$ around the origin decays like $\rho^{-(8/\kappa)+1+o(1)}$ when $\rho \rightarrow \infty$. It follows immediately that if κ is the value associated to the pinned measure μ ,

$$\mu(\{\gamma : R(\gamma) \geq \rho\}) = Q(\{\gamma : R(\gamma) \geq \rho\}) = \rho^{-(8/\kappa)+1+o(1)}$$

as $\rho \rightarrow \infty$. If we compare this with the scaling property of μ , i.e., the fact that

$$\mu(\{\gamma : R(\gamma) \geq \rho\}) = \rho^{-\beta} \mu(\{\gamma : R(\gamma) \geq 1\}),$$

we get that:

Corollary 6.6. *One necessarily has $\kappa = 8/(1 + \beta)$, $\beta \in [1, 2)$ and $\kappa \in (8/3, 4]$.*

The last two statements in the corollary are just due to the fact that we know already that $\beta < 2$ (so that $\kappa > 8/3$) and also that $\kappa \leq 4$ (because γ does not touch the boundary elsewhere than at the origin), which implies that $\beta \geq 1$.

6.2 Pinned measure and SLE excursion measure

In order to show that Corollary 6.5 in fact characterizes the measure μ , let us first recall the following rather standard facts concerning SLE processes and excursions of Bessel processes:

Lemma 6.7. *Suppose that $\kappa \in (8/3, 4]$, and that P^ε denotes the law of an SLE_κ from ε to 0 in the upper half-plane. Then, the measures $\varepsilon^{1-(8/\kappa)}P^\varepsilon$ converge (vaguely) to an infinite measure ν on the set of pinned loops, that we call the SLE_κ excursion measure.*

Vague convergence here means that for all $r > 0$, when restricted on the set of paths with diameter greater than r , $\varepsilon^{1-(8/\kappa)}P^\varepsilon$ converges weakly (with respect to the Hausdorff topology for instance).

Proof. Let us fix a positive ε and consider an SLE_κ curve (for $\kappa \in (8/3, 4]$) from ε to 0 in \mathbb{H} . It is possible to parametrize this curve as a Loewner chain in the upper half-plane, with time measured via the half-plane capacity. If we use this parametrization, then the SLE path is defined up to some (random) time τ , and one can define for each $t \geq 0$, the conformal map g_t from $\mathbb{H} \setminus \gamma[0, t]$ normalized at infinity, and it satisfies Loewner's equation $\partial_t g_t(z) = 2/(g_t(z) - U_t)$ for all $t \leq \tau$ and $z \notin \gamma[0, t]$, where $U_t = g_t(\gamma_t)$. Note also that τ is the hitting time of 0 by $U_t - g_t(0)$ (because γ is almost surely a simple curve).

It is quite easy to argue that the process $X_t := U_t - g_t(0)$ is necessarily a Markov process with the same scaling property as Brownian motion, and therefore the multiple of some Bessel process. In fact, direct computations (see for instance [42]) shows that γ is a so-called $SLE(\kappa, \kappa - 6)$ process stopped at its first swallowing time of 0, i.e., that

$$dU_t = \sqrt{\kappa}dB_t + \frac{\kappa - 6}{U_t - g_t(0)}dt$$

and

$$dX_t = \sqrt{\kappa} dB_t + \frac{\kappa - 4}{X_t} dt$$

where B is a standard Brownian motion. Note that U can be recovered from X because

$$U_t - U_0 = X_t - X_0 + \int_0^t 2dt/X_t.$$

An important feature here is (and this follows immediately from Itô's formula) that for $\beta = 8/\kappa - 1$, $(X_t)^\beta$ is a local martingale up to its first hitting time of 0. For instance, when $X_0 = \varepsilon$, then the probability that X hits $\varepsilon' > \varepsilon$ before hitting 0 is $(\varepsilon/\varepsilon')^\beta$. This makes it possible (in the standard procedure to define Bessel excursions, see for instance [32]) to define a measure ν on the space of one-dimensional excursions $(Y_t, t \leq \tau)$ (i.e., such that $Y_0 = Y_\tau = 0$ and $Y(0, \tau) \subset (0, \infty)$) in such a way that the ν -mass of the set of paths that reach level ε (at some time τ_ε) is $\varepsilon^{-\beta}$, and that the $(\varepsilon^\beta \nu)$ -law of $(Y_{t+\tau_\varepsilon}, t \in [0, \tau - \tau_\varepsilon])$ is the law of X as before started from level ε and stopped at its first hitting of 0. Furthermore, one can check (for instance via scaling considerations) that for ν -almost all Y , $\int_0^\tau dt/Y_t < \infty$.

Each such excursion Y clearly defines (via Loewner's equation, replacing X by Y and using the fact that $\int_0^\tau dt/Y_t$ is finite) a two-dimensional pinned loop γ . So, we can view the measure ν as a measure on the set of loops, and it satisfies the following two statement:

- The ν -mass of the set of pinned loops γ such that Y hits ε is $\varepsilon^{-\beta}$.
- On this set, the measure $\nu^\varepsilon = \varepsilon^\beta \nu$ is a probability measure, and one can sample γ by first sampling $\gamma[0, \tau_\varepsilon]$, and then finishing the curve by an SLE_κ in $\mathbb{H} \setminus \gamma[0, \tau_\varepsilon]$ from $\gamma(\tau_\varepsilon)$ to 0.

It follows that the difference between the two probability measures ν^ε and P^ε is just due to the mapping by the random conformal mapping normalized at infinity from $\mathbb{H} \setminus \gamma[0, \tau_\varepsilon]$ onto \mathbb{H} . But, when $\varepsilon \rightarrow 0$, this mapping clearly converges to the identity away from the origin, which proves the claim. \square

Proposition 6.8. *The pinned measure μ is the multiple of the SLE_κ -excursion measure ν for $\kappa = 8/(1 + \beta)$ (where β is the “exponent” associated to μ), that is normalized in such a way that $\mu(\gamma \text{ surrounds } i) = 1$.*

A consequence of this proposition is that two CLE's with the same exponent β have the same pinned measure.

Proof. Recall that we have the following description of μ (this is just the combination of the scaling property of μ and of the definition of r_0): For each $\varepsilon \geq 0$, the μ -mass of the set of loops with radius at least εr_0 is $\varepsilon^{-\beta}$. If we restrict ourselves to this set of loops, and renormalize μ so that it is a probability measure on this set, we can first

sample the part of γ up to the point at which it reaches the circle of radius ε , and then complete it with an SLE_κ back to the origin in the remaining domain.

We can note that for some absolute constant K_0 , if we consider a loop that does not reach the circle of radius r_0 , then the corresponding Loewner-type function Y as before does not reach K_0 . Let us now sample the beginning of the loop γ as before up to the first hitting point of the circle of radius εr_0 . Then continue the SLE up to the first time (if it exists) at which the function Y associated to the loop reaches $K_0\varepsilon$. A fixed positive fraction K_1 (independent of ε because of scale-invariance) of these SLEs succeed in doing so. Then, after this point, we still are continuing with an SLE_κ in the remaining domain, so that γ is close to a sample of P^ε .

Hence, we conclude readily that μ is a constant multiple of ν (where the constant is given in terms of K_0 , K_1 and β). Another way to describe this constant is to recall that $\mu(\gamma \text{ surrounds } i) = 1$. \square

Let us now make the following comment: Suppose that a CLE in \mathbb{H} is given. This defines a random collection of loops (γ_j) . If we now define the symmetry S with respect to the imaginary axis (i.e. the map $z \mapsto -\bar{z}$), then it is clear from our CLE axioms that the family $(S(\gamma_j))$ is also a CLE in \mathbb{H} . We have just seen that each CLE defines a pinned measure μ that happens to be the (multiple of an) SLE_κ excursion measure. But, by construction, the pinned measure associated to the CLE $(S(\gamma_j))$ is simply the image of μ by the map S . Therefore (noting that both these CLEs correspond to the same exponent β), the CLEs $(S(\gamma_j))$ and (γ_j) correspond to the same SLE excursion measure. Hence:

Corollary 6.9. *If the pinned measure of a CLE is the SLE_κ excursion measure for some κ , then it implies that the law of the corresponding SLE_κ bubble (as defined in the introduction) is reversible: The trace of SLE_κ bubble traced clockwise has the same law as that of an SLE_κ bubble traced anti-clockwise.*

It has been proved by Dapeng Zhan that SLE_κ for $\kappa \leq 4$ is indeed reversible (see [55]), which in fact implies this last statement. The present set-up therefore provides an alternative approach to reversibility of SLE paths for these values of κ .

7 Reconstructing a CLE from the pinned measure

The goal of the present section is to show that if one knows μ , then one can recover the law of the initial CLE. This will conclude the proof of Theorem 1.3.

The rough idea is to use the radial exploration and to use the same idea as in the proof of the fact that $\beta < 2$, but “backwards”: The fact that $\beta < 2$ will ensure that this exploration (described in Section 4.4) can be approximated by keeping only those steps that discover “large” loops, because the cumulative contribution of the small ones vanish. Furthermore, these large loops can be described using a Poisson point process of intensity μ . This will lead to the description of a “continuous exploration mechanism” that we will relate to $SLE(\kappa, \kappa - 6)$ processes in the next section.

7.1 The law of $\gamma(i)$

It is useful to first show how one can recover the law of the loop in the CLE that contains i . Recall that the set-up is the following: We suppose that we are given the law P of a CLE. The previous sections enable us to define its pinned measure μ and we have seen that it is necessarily equal (up to a multiplicative constant) to the SLE_κ excursion measure for some κ in $(8/3, 4]$.

Lemma 7.1. *The pinned measure μ characterizes the law of $\gamma(i)$ under P . In other words, if two (laws of) CLEs define the same pinned measure, then $\gamma(i)$ is distributed in the same way for both CLEs.*

Proof. Let us use on the one hand the radial exploration mechanism in \mathbb{H} . This defines (for each ε) the geometric number N of exploration steps, the conformal maps $\varphi_1^\varepsilon, \dots, \varphi_N^\varepsilon$ that are normalized at i (i.e., $\varphi_n^\varepsilon(i) = i$ and the derivative at i is positive). We also define for all $n \leq N$,

$$\Phi_n^\varepsilon = \varphi_n^\varepsilon \circ \dots \circ \varphi_1^\varepsilon$$

and $\Phi^\varepsilon = \Phi_N^\varepsilon$. Recall that:

- The random variable N is geometric with mean $1/u(\varepsilon)$.
- Conditionally on the value of N , the maps $\varphi_1^\varepsilon, \dots, \varphi_N^\varepsilon$ are i.i.d. (and their law does not depend on N — these are the maps corresponding to the CLE exploration conditioned on the fact that $\gamma(i)$ does not intersect C_ε).
- What one “discovers” at the $(N+1)$ -th step is independent of the value of N and of the maps $\varphi_1^\varepsilon, \dots, \varphi_N^\varepsilon$. It is just a CLE conditioned by the event that the loop surrounding i intersects C_ε .

On the other hand, define a Poisson point process of pinned loops $(\bar{\gamma}_t, t \geq 0)$ with intensity μ , and let T be the first time at which one $\bar{\gamma}_t$ surrounds i . The μ -mass of the set of loops that surround i is equal to 1, so that T is an exponential random variable of parameter 1 (see for instance [33] for background on Poisson point processes). For each of the countably many t in $(0, T)$ such that $\bar{\gamma}_t$ exists, we denote by f_t the conformal map normalized at i by $f_t(i) = i$ and $f_t'(i) > 0$, from the unbounded connected component of $\mathbb{H} \setminus \bar{\gamma}_t$ onto \mathbb{H} . The fact that $\beta < 2$ shows that

$$\begin{aligned} E \left(\sum_{t < T} a(f_t) 1_{R(\bar{\gamma}_t) < 1/2} \right) &\leq E(T) \mu(a(f) 1_{R(\gamma) < 1/2}) \\ &\leq C \mu(R(\gamma)^2 1_{R(\gamma) < 1/2}) \leq C' \int_0^{1/2} \frac{x^2 dx}{x^{1+\beta}} < \infty. \end{aligned}$$

Since $\mu(R(\gamma) \geq 1/2) < \infty$, the number of times t before T at which $R(\bar{\gamma}_t) \geq 1/2$ is almost surely finite, so that almost surely, $\sum_{t < T} a(f_t)$ is finite (here and in this section,

we shall re-use notations and arguments that have been presented in the “stability of Loewner chains” paragraph of Section 4.3). Hence, if for each $r > 0$, we define the iteration Ψ^r of the finitely many f_t 's for $t < T$ (in their order of appearance, let us call the corresponding times $t_1(r), \dots, t_k(r)$) that correspond to pinned loops $\bar{\gamma}_{t_j}$'s of radius greater than r , we get that as $r \rightarrow 0+$, the maps Ψ^r converge (in Carathéodory topology, with respect to the marked point i) to some conformal map Ψ that can be interpreted as the iteration of all the conformal maps $(f_t, t < T)$ in their order of appearance. Note that Ψ maps some open set onto the upper half-plane, but that we have no information at this point on the regularity of the boundary of this open set (whether it is a curve or not, etc.).

Our goal now is to prove that when ε is small, then Ψ and Φ^ε are very close (in law – with respect to the Carathéodory topology from i). This will ensure that the law of $\gamma(i)$ in the CLE is identical to that of $\Psi^{-1}(\bar{\gamma}_T)$, i.e. the image under Ψ^{-1} of an independent sample of μ^i . In order to do so, we are going to introduce the cut-off Ψ^r as before. For each $r > 0$, we define $n_1(r), \dots, n_k(r)$ the steps before N at which one discovers a loop intersecting C_r (note that this number of steps k and the values of the n_j 's are random, and depend on ε as well). The description of μ shows that for each fixed $r > 0$, the joint law of $(\varphi_{n_1(r)}^\varepsilon, \dots, \varphi_{n_k(r)}^\varepsilon)$ converges precisely to that of the corresponding $(f_{t_1(r)}, \dots, f_{t_k(r)})$; the law of their composition $\varphi_{n_k(r)}^\varepsilon \circ \dots \circ \varphi_{n_1(r)}^\varepsilon$ therefore converges to that of Ψ^r .

It now just remains to control

$$\sum_{n \leq N} 1_{n \notin \{n_1(r), \dots, n_k(r)\}} a(\varphi_n^\varepsilon)$$

as $r \rightarrow 0$, uniformly with respect to ε . We will bound the expected value of this quantity. Recall that $\beta < 2$, that the half-plane capacity of a set contained in a disc of radius smaller than r around the origin is bounded by a constant C times r^2 , that N follows a geometric random variable of mean $1/u(\varepsilon)$, and that conditionally on N , the maps $\varphi_1^\varepsilon, \dots, \varphi_N^\varepsilon$ are i.i.d. It follows that

$$E\left(\sum_{n \leq N} 1_{n \notin \{n_1(r), \dots, n_k(r)\}} a(\varphi_n^\varepsilon)\right) \leq E(N)E(a(\varphi_1^\varepsilon)1_{n_1(r) \neq 1})$$

and that

$$E(a(\varphi_1^\varepsilon)1_{n_1(r) \neq 1}) \leq C \times E(R(\tilde{\gamma}(\varepsilon))^2 1_{R(\tilde{\gamma}(\varepsilon)) \leq r}).$$

This last expectation will be controlled thanks to the bound $\beta < 2$: Let us first fix $\delta = 1/2$ and choose some $a \in (0, (2 - \beta)/2)$, for instance $a = (2 - \beta)/4$. We know that

$$\lim_{\eta \rightarrow 0} \frac{v(\delta\eta)}{v(\eta)} \geq \delta^{2-2a}.$$

In particular, for some $\eta_0 > 0$, we get that for all $\eta < \eta_0$,

$$\frac{v(\delta\eta)}{v(\eta)} \geq \delta^{2-a}.$$

Hence, there exists a constant C' such that for all $m \geq n \geq 1$

$$\frac{v(\delta^m)}{v(\delta^n)} \geq C'(\delta^{m-n})^{2-a}.$$

Hence, if $\delta^{n_0+1} \leq \varepsilon \leq \delta^{n_0} \leq \delta^{n_1+1} \leq r \leq \delta^{n_1}$, we get that

$$\begin{aligned} & E\left(\sum_{n \leq N} 1_{n \notin \{n_1(r), \dots, n_k(r)\}} a(\varphi_n^\varepsilon)\right) \\ & \leq E(N) \times E(R(\tilde{\gamma}(\varepsilon))^2) 1_{R(\tilde{\gamma}(\varepsilon))^2 \leq r} \\ & \leq \frac{C}{u(\delta^{n_0})} \sum_{j \in [n_1, n_0]} \delta^{2j} P(R(\tilde{\gamma}(\delta^{n_0})) \geq \delta^{j+1}) \\ & \leq C'' \sum_{j \in [n_1, n_0]} \delta^{2j} \frac{v(\delta^{n_0-j-1})}{u(\delta^{n_0})} \\ & \leq C''' \sum_{j \geq n_1} \delta^{2j} (\delta^j)^{-2+a} \\ & \leq C''' r^a \end{aligned}$$

where all the constants do not depend on r and ε , so that this quantity converges to 0 as $r \rightarrow 0+$ independently of ε ; this completes the proof of the fact that the law of Φ^ε converges to Ψ (in Carathéodory topology).

Recall that for each $\varepsilon > 0$, the law of $\gamma(i)$ is described as follows: We consider on the one hand a sample of the conformal map $\Phi^\varepsilon = \Phi_N^\varepsilon$, and on the other hand, an independent sample of the loop $\tilde{\gamma}^\varepsilon$ that surrounds i in a CLE in \mathbb{H} conditioned to intersect C_ε . Then, $\gamma(i)$ is distributed exactly as $(\Phi^\varepsilon)^{-1}(\tilde{\gamma}^\varepsilon)$.

We have just seen that Φ^ε converges in law to Ψ and we have also proved that the (conditional) law of $\tilde{\gamma}^\varepsilon$ converges to μ^i . It follows therefore that the law of $\gamma(i)$ is described as the image under Ψ^{-1} of an independent sample of μ^i . This description is based solely on the measure μ , so that the law of $\gamma(i)$ can indeed be fully recovered from μ . \square

We may observe that the previous proof also shows that if (z_1, \dots, z_m) are other points in \mathbb{H} , if we restrict ourselves to the event where all these m other points are surrounded by some macroscopic loops that one discovered in this radial exploration mechanism before (or at) the N -th step, the joint distribution of these m loops (some of which may be the same if some loops surround several of these points) in the $\varepsilon \rightarrow 0$ limit is also described via the Poisson point process of pinned loops i.e. via μ .

7.2 Several points

We now want to prove the more general result:

Proposition 7.2. *Two CLE probability measures that define the same pinned measure μ are necessarily equal.*

In other words, the pinned measure μ characterizes the law of the corresponding CLE. This clearly implies Theorem 1.3.

Proof. Note that the law of the CLE is characterized by its “finite-dimensional marginals”, i.e., by the joint distribution of

$$(\gamma(i), \gamma(z_1), \gamma(z_2), \dots, \gamma(z_m))$$

for any finite set of points z_1, \dots, z_m in \mathbb{H} (if we consider the CLE defined in the upper half-plane).

Let us first focus on the law of $(\gamma(i), \gamma(z))$ for some given $z \in \mathbb{H}$ (the general case will be very similar). In order to motivate what follows, let us informally describe what could happen if we simply try to use exactly the same procedure as in the previous subsection. That is, we consider the conformal maps $\varphi_n^\varepsilon, \Phi_n^\varepsilon$ for $n \leq N$ as before. Let K denote the largest $k \leq N$ such that $z \in (\Phi_k^\varepsilon)^{-1}(\mathbb{H})$ (and write $K = N$ if z is not swallowed during the first N steps). We want to keep track of what happens to z , so we define $a_k = \Phi_k^\varepsilon(z)$ (which will be defined up to $k \leq K$). Let us now fix some small positive δ and consider $\varepsilon < \delta$.

We will also introduce another step $K' \leq K$, which is the first step k at which either $|a_k| \leq \delta$ or $k = K$. Note that if $K' < K$, this means that after the K' -th step, neither $\gamma(z)$ nor $\gamma(i)$ have been discovered, but that the points z and i are “conformally” quite far away from each other in the domain $H_{K'} = (\Phi_{K'}^\varepsilon)^{-1}(\mathbb{H})$ (i.e., the Green’s function $G_{H_{K'}}(z, i)$ is small — recall that δ is small). This can happen if the exploration gets close to one of the two points i or z in \mathbb{H} , or if it almost disconnects one from the other in \mathbb{H} (and this is in fact a scenario that might really occur with positive probability, even in the $\delta \rightarrow 0$ limit).

We can subdivide the case $K' = K$ into three possibilities: The loop $\gamma(z)$ has been discovered before the N -th step (in other words: $K < N$), the loop $\gamma(z)$ is discovered at the N -th step (then with high probability $\gamma(i) = \gamma(z)$ when $\varepsilon \rightarrow 0$), or it has still to be discovered after then N -th step. In all these three cases, the arguments of the previous subsection allow us to conclude that the joint law of $(\gamma(i), \gamma(z))$ on the event that $K' = K$ can be described via the Poisson point process of pinned loops, i.e. thanks to the knowledge of μ .

When $K' < K$, we could just try to continue the exploration process after K' , but at some later step k , it could happen that the exploration procedure captures z because $|a_k| \leq \varepsilon$. Or more generally, the loop $\gamma(z)$ could be discovered in the discrete exploration process at some step k via some loop that intersects C_ε and that has a very small radius (this does not necessarily contradict the fact the $\gamma(z)$ is at positive distance of z). In such a case, the previous argument will clearly not work, as the exploration step corresponding to the discovery of $\gamma(z)$ would not be apparent in the limiting Poisson point process of “macroscopic” pinned loops.

Here is a simple way of fixing this: At the step K' , instead of doing an exploration using the semi-circle C_ε , we use the semi-circle $C_{\sqrt{\delta}}$ of radius $\sqrt{\delta}$. Note that we are only exploring the loops that hit the semicircle (not all the loops hitting the semi-disc) and that $|a_{K'}| \leq \delta$. The harmonic measure of this semi-circle in \mathbb{H} seen from $a_{K'}$ or from i is small (if δ is small). After this K' -th step, z and i are then in two different domains. Furthermore, the probability to discover a loop that intersects also $C_{\delta^{3/4}}$ or $C_{\delta^{1/4}}$ at this K' -th step is very small.

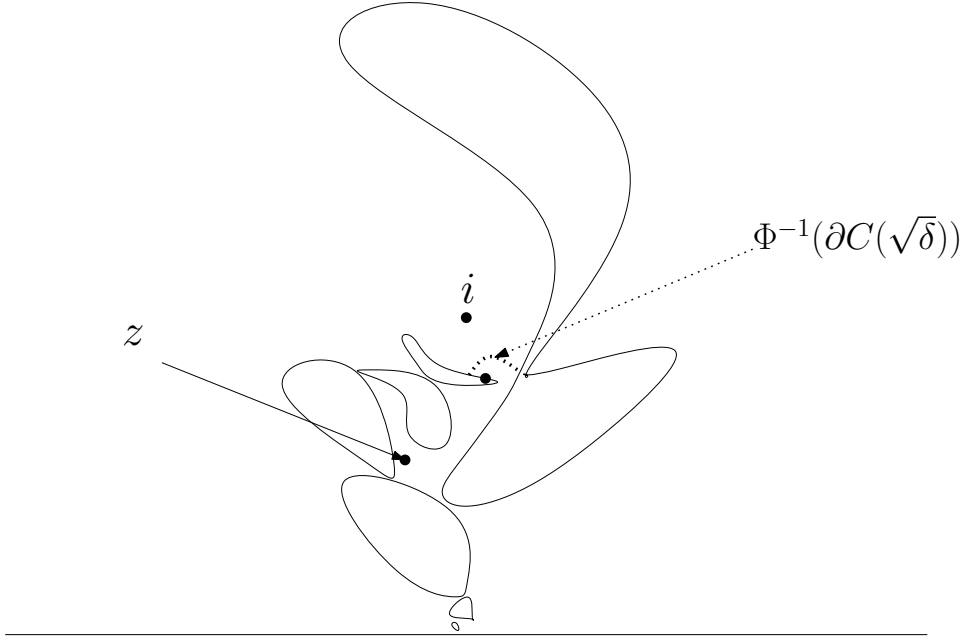

Figure 25: Near separation of z from i (sketch).

The same arguments as above show convergence (as $\varepsilon \rightarrow 0$) of the laws of the $\Phi_{K'}^\varepsilon$ (in the Carathéodory sense, with normalization at i). With high probability, the K' -th exploration step changes the log conformal radius viewed from either z or i by a fraction that goes to 0 when $\delta \rightarrow 0$. If we keep in mind that the restriction property still holds for non-simply connected subsets of \mathbb{H} (this is the final observation of Section 2), we see that we can then continue the discrete radial exploration (aiming towards i) with ε -semi-circles in the connected component containing i after the K' -th step, and independently another discrete radial exploration (aiming at z) in the domain containing z . In both cases, we continue until we discover $\gamma(i)$ and $\gamma(z)$, and the same arguments as above allow to approximate the laws of these two loops in the two respective domains via two Poisson point processes of loops.

We can therefore conclude that up to an error that tends to 0 with δ , the joint law of $(\gamma(i), \gamma(z))$ on the event where $K' < K$ is also fully described via a procedure that is based on the knowledge of μ only. Hence, the joint law of $(\gamma(i), \gamma(z))$ is fully determined by the pinned measure μ .

Let us now consider the case where there is more than one additional point, i.e., when we look at the joint law of $(\gamma(i), \gamma(z_1), \dots, \gamma(z_m))$. We then use the same argument as above, stopping at the first time that *at least one* of the images of the other points gets to a distance less than δ from the origin, i.e., at the step

$$K' = \min\{k : \min(|a_k^1|, \dots, |a_k^m|) \leq \delta\},$$

where $a_k^j = \Phi_k^\varepsilon(z_j)$. Note that at this step, it could happen that several $|a_k^j|$ are in fact quite small simultaneously. If we would explore as before by cutting out the semi-circle $C_{\sqrt{\delta}}$, we might be unlucky and have some a_k^j that lies very close to this semi-circle. However, it is clear that for at least one semi-circle $C_{\delta^{1/j}}$ out of the m semi-circles, $C_{\delta^{1/2}}, C_{\delta^{1/3}}, \dots, C_{\delta^{1/m+1}}$, the harmonic measure of $C_{\delta^{1/j}}$ in \mathbb{H} seen from *any* of the m points a_k^1, \dots, a_k^m is very small (i.e., tends uniformly to 0 when $\delta \rightarrow 0$). We therefore choose to use this particular semi-circle for the $(K' + 1)$ -th exploration step. This reduces the problem to two independent explorations in two new domains as before, and each of the two domains contains strictly less than $m + 1$ points. We can then inductively continue the discrete exploration procedure.

For each fixed δ , this shows that up to a small error (that vanishes when $\delta \rightarrow 0$), the $\varepsilon \rightarrow 0$ limit of this exploration procedure is well-approximated via Poisson point processes with intensity μ . This enables to conclude that the joint law of the loops $(\gamma(i), \gamma(z_1), \dots, \gamma(z_m))$ can be fully described in terms of μ . \square

8 Relation to CLE_κ 's

It now remains to make the connection with the CLE_κ families defined in [43] via $\text{SLE}(\kappa, \kappa - 6)$ branching trees. This will prove of Theorem 1.4.

8.1 Background about $\text{SLE}(\kappa, \kappa - 6)$ processes

We first briefly review some of the properties of $\text{SLE}(\kappa, \kappa - 6)$, in the case where $\kappa \leq 4$ that we are focusing on in the present paper. We refer to [43] for the more precise statements and their proofs. We have already encountered the $\text{SLE}(\kappa, \kappa - 6)$ process in Section 6.2. Recall that a process $(X_t, t \geq 0)$ started from $X_0 = x \neq 0$ is called a Bessel process of dimension $\delta \geq 0$ if it is the solution to the ordinary differential equation

$$dX_t = dB_t + \frac{\delta - 1}{2X_t} dt \tag{3}$$

and that this process is well-defined up to its first hitting time of the origin (which is almost surely finite if $\delta < 2$). When $\delta > 0$, it is possible to define it (uniquely) also after it hits the origin, in such a way that $X_t \geq 0$ when $t \geq 0$ and that the Lebesgue measure of the time spent by X at the origin is 0. This is the “instantaneously reflected Bessel process”, that can also be defined by concatenating a Poisson point process $(e_\ell)_{\ell \geq 0}$ of

Bessel excursions (see for instance [33] for background on Bessel processes). We will also use a variation of this process obtained when tossing a fair coin for each excursion of the Bessel process in order to decide if it is positive or negative (this process is therefore defined on a larger probability space than the Brownian motion B), which is the “symmetrized Bessel process”.

To each excursion e of the Bessel process of dimension δ , we associate $J(e)$ the integral of $dt/e(t)$ on this excursion. Recall that $(X_t)^\beta$ is a local martingale as long as X_t stays away from the origin (for $\beta = 2 - \delta$); it follows from a simple scaling argument that the $J(e)$ ’s are finite and that the intensity of the Poisson point process $(J(e_\ell), \ell \geq 0)$ is a multiple of $dx/x^{1+\beta/2}$.

It is already apparent in Section 6.2 that it will be essential to try to make sense of a quantity like $\int_0^t ds/X_s$ when X is a Bessel process. In fact, we will need to focus on the case where $\delta = 3 - 8/\kappa \in (0, 1]$ and $\beta \in [1, 2)$, where this integral is infinite as soon as X starts touching the origin (this is because $\int_0 dx/x^{1+(\beta/2)}$ diverges so that almost surely, $\sum_{\ell \leq 1} J(e_\ell) = \infty$). There are two ways around it this problem. The first one involves the notion of “principal values” and is described in [43]. The other one, which works for all $\delta \in (0, 1]$, is simply to consider the symmetrized Bessel process that chooses its signs at random according to independent fair coin tosses on each excursion. In this case, the integral $\int_0^t ds/X_s$ is not absolutely convergent, but the process $t \mapsto I_t := \int_0^t ds/X_s$ can be nevertheless easily defined (this corresponds exactly to the existence of symmetric α -stable processes for $\alpha \in [1, 2)$, even if α -stable subordinators do not exist when $\alpha \geq 1$). We refer to [43] for a more detailed description of the possible options. What we will need here is that in all these cases, one defines a continuous Markov process $(X_t, I_t)_{t \geq 0}$ such that:

- X is a solution to the SDE (3) when it is away from the origin.
- The Lebesgue measure spent by X at the origin is 0.
- On the set of times where X_t is away from the origin, $t \mapsto I_t$ is differentiable and its derivative is $1/X_t$.
- $(X_t, I_t)_{t \geq 0}$ satisfies the Brownian scaling property.

The way to define an SLE($\kappa, \kappa - 6$) process out of this couple $(X_t, I_t)_{t \geq 0}$ goes as follows: Define for all $t \geq 0$, the continuous process

$$U_t = \sqrt{\kappa}X_t + 2I_t/\sqrt{\kappa}$$

and construct the chordal Loewner chain driven by this function, i.e., solve the Loewner differential equation for all $z \in \mathbb{H}$

$$\partial g_t(z) = 2/(g_t(z) - U_t)$$

started from $g_0(z) = z$ in order to define a random Loewner chain. If we define $O_t = I_t/\sqrt{\kappa}$, then when X_t is away from the origin, i.e., when $U_t \neq O_t$, one has $\partial_t O_t =$

$2/(O_t - U_t)$, i.e., O_t follows the image of some boundary point under the Loewner flow. Hence, putting our various equations together (definitions of X_t , I_t , O_t , and the relation between κ and δ), we get that on the set of times where $O_t \neq U_t$,

$$dU_t = \sqrt{\kappa}dB_t + (\kappa - 6)\frac{dt}{O_t - U_t} \text{ and } dO_t = \frac{2dt}{O_t - U_t}.$$

This continuous driving function $t \mapsto U_t$ defines a Loewner chain, but it is not clear whether this chain is almost surely generated by a path. However, on those time-intervals where $X_t \neq 0$, the law of $t \mapsto U_t/\sqrt{\kappa}$ is (locally) absolutely continuous to that of a standard Brownian motion, and the Loewner chain is therefore tracing stretches of simple paths during these intervals. In fact, each of these intervals correspond to a *simple loop* traced by the $\text{SLE}(\kappa, \kappa - 6)$ Loewner chain. We can say that the positive excursions of X correspond to anti-clockwise loops while the negative ones correspond to clockwise loops.

We have already mentioned that such chordal $\text{SLE}(\kappa, \kappa - 6)$ chains are of particular interest because of the following properties [42]: They are target-independent, and if $X_t > 0$, then the process locally continues exactly as an SLE_κ targeting $g_t^{-1}(O_t)$. This makes it possible (see [43]) to construct a branching $\text{SLE}(\kappa, \kappa - 6)$ process whose law is invariant under conformal automorphisms of \mathbb{H} that fix the origin. In fact, it is also possible to define a radial version of the $\text{SLE}(\kappa, \kappa - 6)$ process (see [42, 43]) in order to also explore the connected components that are “cut out” without having a point on the boundary of \mathbb{H} . This can be either defined using a “radial-chordal” equivalence (like that of $\text{SLE}(6)$) or viewed as a rather direct consequence of the target-independence of the (chordal) $\text{SLE}(\kappa, \kappa - 6)$ (just interpreting the past of the SLE as new boundary points). The obtained set is then dense in the upper half-plane, and it is therefore possible to define the family of all loops that are traced in this way: these are exactly the CLE_κ defined in [43]. In particular, for any given choice of the root (say at the origin i.e., the $\text{SLE}(\kappa, \kappa - 6)$ is started from $(0, 0)$), any given z in the upper half-plane is almost surely surrounded by an (outermost) loop in this CLE_κ , and we will denote it by $\hat{\gamma}(z)$.

Let us make the following simple observation that will be useful later on: Suppose that z_1 and z_2 are two points in the upper half-plane, and that the (random) time τ at which this (branching) $\text{SLE}(\kappa, \kappa - 6)$ process separates z_1 from z_2 is finite. Then, there are two possible ways in which this can happen:

- Either τ is the end-time of an excursion of X , where the SLE traced a closed loop that surrounds one of the two points but not the other.
- Or the SLE has not yet traced a closed loop that surrounds one of the two points and not the other, but the Loewner chain traced by the paths nevertheless separates the two points from one another. This can for instance happen if the $\text{SLE}(\kappa, \kappa - 6)$ touches the boundary of the domain at a limit time that occurs after the tracing of infinitely many small loops (recall that the $\text{SLE}(\kappa, \kappa - 6)$ is not a simple path).

8.2 SLE($\kappa, \kappa - 6$) and Poisson point process of pinned loops

The definition of SLE($\kappa, \kappa - 6$) clearly shows that it is possible to reconstruct the process $(X_t, t \geq 0)$ starting from a Poisson point process of (positive) Bessel excursions $(e_\ell)_{\ell \geq 0}$ of the corresponding dimension. More precisely (for the symmetrized Bessel process), one defines also an i.i.d. family $(\varepsilon_\ell)_{\ell \geq 0}$ (with $P(\varepsilon_\ell = 1) = P(\varepsilon_\ell = -1) = 1/2$) of “random signs” and then defines X by concatenating the excursions $(\varepsilon_\ell e_\ell, \ell \geq 0)$. Each individual excursion corresponds to a pinned loop $\bar{\gamma}_\ell$ in the upper-half plane. In fact, this pinned loop is an SLE excursion, and one has tossed the fair coin in order to decide whether to trace it clockwise or anti-clockwise. Hence, an SLE($\kappa, \kappa - 6$) defines the same Poisson point process of pinned loops $(\bar{\gamma}_\ell)_{\ell \geq 0}$ with intensity μ as in Section 7.1.

But there is a difference in the way this Poisson point process is used in order to construct the “composition” of the corresponding conformal maps f_ℓ . Here, one does not compose the conformal maps f_ℓ that are normalized to have real derivative at i . Instead, one keeps track of the previous location of the tip of the curve and continues growing from there. More precisely, suppose that a pinned loop $\bar{\gamma}$ is given, and that one decides to trace it clockwise. Consider the unbounded connected component H of its complement in \mathbb{H} and let $0+$ denote the boundary point of H defined as “the origin seen from the right”. Define the conformal map \tilde{f} from H onto \mathbb{H} such that $\tilde{f}(0+) = 0$ and $\tilde{f}(i) = i$. If the loop was traced counterclockwise, just replace $0+$ by $0-$ in this definition of \tilde{f} .

Then, if one focuses on the radial SLE($\kappa, \kappa - 6$) only at those times t at which $X_t = 0$ and before it draws a loop surrounding i , we have exactly the iteration of the conformal maps \tilde{f}_ℓ .

In other words, let us define $c_\ell \in (-\pi, \pi]$ in such a way that $\tilde{f}'_\ell(i) = e^{ic_\ell}$; then the difference between the radial SLE exploration procedure and the continuous iteration of maps (f_ℓ) described in Section 7.1 is this “Moebius rotation” at the end of each discovered loop. More precisely, let θ_c denote the Moebius transformation of \mathbb{H} onto itself with $\theta_c(i) = i$ and $\theta'_c(i) = e^{ic}$; then $\tilde{f}_\ell = \theta_{c_\ell} \circ f_\ell$.

This gives a motivation to modify the discrete radial exploration mechanism of a CLE that we used in Lemma 7.1 as follows: After each step, instead of normalizing the maps φ_n^ε at i by $\varphi_n^\varepsilon(i) = i$ and $(\varphi_n^\varepsilon)'(i) > 0$, we use the modified map $\tilde{\varphi}_n^\varepsilon$ defined by $\tilde{\varphi}_n^\varepsilon(i) = i$ and by tossing a fair coin in order to decide whether $\tilde{\varphi}_n^\varepsilon(-\varepsilon) = 0$ or $\tilde{\varphi}_n^\varepsilon(\varepsilon) = 0$. Because the law of a CLE in \mathbb{H} is invariant under Moebius transformations, this does not change the fact that the $(\tilde{\varphi}_n^\varepsilon)$'s are i.i.d., that N is a geometric random variable with mean $1/u(\varepsilon)$, and that what one discovers at the $(N + 1)$ -th step is independent of the value of N and of the maps $\tilde{\varphi}_1^\varepsilon, \dots, \tilde{\varphi}_N^\varepsilon$.

We would now like to see that this discrete exploration mechanism converges (as $\varepsilon \rightarrow 0$) exactly to the radial SLE($\kappa, \kappa - 6$) procedure described before. We already know from the proof of Lemma 7.1 that if we focus on the discovered pinned loops of radius larger than r (for each fixed r), then the corresponding discovered loops converge in law to the corresponding SLE loops (and that the laws of the corresponding conformal maps therefore converge too). The point is therefore only to check that the effect of all these

additional “Moebius rotations” remains under control (in other words, that it tends to 0 when $r \rightarrow 0$, uniformly with respect to ε). But as we shall now see, this follows from the same arguments that allow us to define symmetrized Bessel processes (respectively symmetric α -stable processes) as almost sure limits of processes obtained by the cut-off of all Bessel excursions of small height or length (resp. the cut-off of all jumps of small size) i.e., it is a straightforward consequence of the fact that $\beta < 2$: For each $n \leq N$, we define φ_n^ε and $\tilde{\varphi}_n^\varepsilon$ as before, and choose c_n^ε in such a way that $\tilde{\varphi}_n^\varepsilon = \theta_{c_n^\varepsilon} \circ \varphi_n^\varepsilon$.

Note that there exists a universal constant such that as soon as $R(\tilde{\gamma}(\varepsilon)) \leq 1/2$, the corresponding c^ε satisfies $|c^\varepsilon| \leq C \times R(\tilde{\gamma}(\varepsilon))$ (because harmonic measure scales like the diameter). It follows, using the independence between the exploration steps, and the symmetry (i.e., the fact that c_1^ε and $-c_1^\varepsilon$ have the same law) that

$$E\left(\left(\sum_{n \leq N} 1_{n \notin \{n_1(r), \dots, n_k(r)\}} c_n^\varepsilon\right)^2\right) = E(N)E((c_1^\varepsilon)^2 1_{1 \neq n_1(r)}) \leq \frac{C}{u(\varepsilon)} E(R(\tilde{\gamma}(\varepsilon))^2 1_{R(\tilde{\gamma}(\varepsilon)) < r}).$$

We have already shown in the proof of Lemma 7.1 that this last quantity goes to 0 as $r \rightarrow 0$, uniformly with respect to ε . Note also that $m \mapsto \sum_{n \leq \min(m, N)} 1_{n \notin \{n_1(r), \dots, n_k(r)\}} c_n^\varepsilon$ is a martingale. Hence, Doob’s inequality ensures that uniformly with respect to ε ,

$$\lim_{r \rightarrow 0^+} E\left(\sup_{m \leq N} \left(\sum_{n \leq m} 1_{n \notin \{n_1(r), \dots, n_k(r)\}} c_n^\varepsilon\right)^2\right) \rightarrow 0.$$

From this, it follows that forgetting or adding these “rotations” to the exploration procedure does not affect it much (in Carathéodory sense, seen from i); one can for instance use the Loewner chain interpretation of this exploration procedures, and the above bound on the supremum of the cumulative rotations implies that the radial Loewner driving functions (with or without these rotations) are very close.

8.3 CLE and the SLE $(\kappa, \kappa - 6)$ exploration “tree”

In this section, we finally complete the proof of Theorem 1.4 by showing that indeed the loops in CLE necessarily have the same law as the set of loops generated by an SLE $(\kappa, \kappa - 6)$ (as constructed in [43]). As before, it is enough to prove that for every finite set $\{z_1, \dots, z_m\}$ of points in \mathbb{H} , the joint law of the $\gamma(z_j)$ is the same for the CLE as for the CLE $_\kappa$ loops (more precisely, as the outermost loops surrounding these points in the CLE $_\kappa$).

Fix the points $\{z_1, \dots, z_m\}$ in \mathbb{H} and consider a radial SLE $(\kappa, \kappa - 6)$ targeting z_1 , say. We do not know whether SLE $(\kappa, \kappa - 6)$ is a continuous curve, but we recall that it is continuous at times in the interior of the loop-tracing intervals (during the excursions of the Bessel process). For each $t > 0$, the hull of the process $K_t \subset \mathbb{H}$ is compact and its complement $H_t = \mathbb{H} \setminus K_t$ contains z_1 . The chain (K_t) also traces loops as explained before. We define τ to be the first time at which at least one of the points z_2, \dots, z_m is “swallowed” by K_t , i.e. separated from z_1 . We will use K_{t-} to denote $\cup_{s < t} K_s$. Note

that by the target invariance property, the law of $(K_t, t < \tau)$ does not depend on the fact that we singled out z_1 i.e., τ is just the first time at which K_{t-} separates the set of m points into at least two parts. As mentioned earlier, the time τ can occur in two different ways: either the SLE has traced a loop surrounding some z_j or it has simply disconnected the domain into two parts.

Lemma 8.1. *Consider the following method of generating a random loop $\tilde{\gamma}(z_j)$ surrounding each z_j .*

1. *For each j , if z_j is surrounded by one of the loops traced by $(K_t, t \leq \tau)$, then we let $\tilde{\gamma}(z_j)$ be that loop.*
2. *In each component of $\mathbb{H} \setminus K_{\tau-}$ that is not surrounded by a loop traced by $(K_t, t \leq \tau)$, we then construct an independent copy of the CLE (conformally mapped to that ensemble), and for each z_j in that component, we let $\tilde{\gamma}(z_j)$ be the loop that surrounds z_j in this CLE.*

Then the set $\{\tilde{\gamma}(z_1), \tilde{\gamma}(z_2), \dots, \tilde{\gamma}(z_m)\}$ agrees in law with $\{\gamma(z_1), \gamma(z_2), \dots, \gamma(z_m)\}$.

Given this lemma, Theorem 1.4 follows immediately by induction. Indeed, suppose that the collections $\{\hat{\gamma}(z'_j), j \leq m-1\}$ and $\{\gamma(z'_j), j \leq m-1\}$ agree in law for all collections of $(z'_j, j \leq m-1)$. By construction, each component of $\mathbb{H} \setminus K_{\tau-}$ has fewer than m points; moreover, conditioned on $(K_t, t \leq \tau)$, the remainder of the branching radial SLE $(\kappa, \kappa-6)$ consists of an independent radial SLE $(\kappa, \kappa-6)$ in each component of $\mathbb{H} \setminus K_{\tau-}$ not surrounded by a loop—by inductive hypothesis, the loops traced by such a process agree in law with the $\tilde{\gamma}(z_j)$.

We now proceed to prove Lemma 8.1.

Proof. First, we claim that it is enough to prove (for each given $\delta > 0$) the statement of Lemma 8.1 where the time τ is replaced by τ_δ defined as follows. Let first σ_δ denote the first time at which at least one of the images of the z_j gets within distance δ of U_t . Note that typically, at time σ_δ , the Bessel process X will be in the middle of some excursion away from 0. Then, let τ_δ be the first time t at which either:

1. The SLE $(\kappa, \kappa-6)$ completes a loop that surrounds some z_j .
2. The SLE completes the loop it is tracing at σ_δ (i.e., $t \geq \sigma_\delta$ and $X_t = 0$).

Indeed, we know that each of the loops $\gamma(z_j)$ is at finite distance from the z_j . Hence, almost surely, the conformal radius of $H_{\tau_\delta-}$ from each of the z_j 's remains bounded as $\delta \rightarrow 0$; thus, in the Carathéodory sense seen from z_j , the domain surrounding $H_{\tau_\delta-}$ tends to a limit as $\delta \rightarrow 0$ almost surely (note that the τ_δ increase as δ decreases). It is therefore clear that the law of the $\tilde{\gamma}$'s (conditioned on $K_{\tau_\delta-}$) tends to a limit as $\delta \rightarrow 0$ and also that (by the arguments of Section 7.2) this limit is indeed that of an independent CLE in each of the component of $H_{\tau_\delta-}$.

Now it remains only to prove the claim for these τ_δ . To do this, it suffices to return to the modified radial ϵ -exploration scheme (the one including the c_n^ϵ “rotations”) that we have just defined and studied, and use the fact that for each fixed δ , up to τ_δ , it approximates the continuous mechanism corresponding to the $\text{SLE}(\kappa, \kappa - 6)$ excursions. \square

Part two: construction via loop-soups

9 Loop-soup percolation

We now begin the second part of the paper, focusing on properties of clusters of Brownian loops. The next three sections are structured as follows. We first study some properties of the Brownian loop-soup and of the clusters it defines. The main result of the present section is that when c is not too large (i.e. is subcritical), the outer boundaries of outermost Brownian loop-soup clusters form a random collection of disjoint simple loops that does indeed satisfy the conformal restriction axioms. By the main result of the first part, this implies that they are CLE_κ ensembles for some κ . In Section 10, we compare how loop-soups and SLE_κ curves behave when one changes the domain that they are defined in, and we deduce from this the relation between κ and c in this subcritical phase. In Section 11, we show that if the size of the clusters in a Brownian loop-soup satisfy a certain decay rate property, then the corresponding c is necessary *strictly* subcritical. This enables to show that the loop-soup corresponding to $\kappa = 4$ is the only possible critical one, and completes the identification of all CLE_κ 's for $\kappa \in (8/3, 4]$ as loop-soup cluster boundaries.

We will in fact directly use SLE results on only three distinct occasions: we use the standard SLE restriction properties from [21] and the description of CLE in terms of SLE excursions in Section 10, and we use an estimate about the size of an SLE_κ excursions in Section 11.

Recall that we consider a Brownian loop-soup \mathcal{L} in \mathbb{U} with intensity c (which is in fact a random countable collection of simple loops because we take the outer boundaries of Brownian loops). Note that almost surely, for any two loops in the loop-soup, either the two loops are disjoint or their interiors are not disjoint. We say that two loops l and l' in \mathcal{L} are in the same cluster of loops if one can find a finite chain of loops l_0, \dots, l_n in \mathcal{L} such that $l_0 = l$, $l_n = l'$ and $l_j \cap l_{j-1} \neq \emptyset$ for all $j \in \{1, \dots, n\}$. We then define $\overline{\mathcal{C}}$ to be the family of all closures of loop-clusters. Finally, we let Γ denote the family of all outer boundaries of outermost elements of $\overline{\mathcal{C}}$ (i.e. elements of $\overline{\mathcal{C}}$ that are surrounded by no other element of $\overline{\mathcal{C}}$).

The goal of this section is to prove the following proposition:

Proposition 9.1. *There exists a positive constant c_0 such that for all c in $(0, c_0)$, the set Γ satisfies the conformal restriction axioms, whereas when c is (strictly) greater than c_0 , \mathcal{L} has only one cluster almost surely.*

Throughout this section, we will use neither SLE-type results nor results derived earlier in the paper. We will focus on properties of the collection $\overline{\mathcal{C}}$ of (closures of) the clusters defined by the loop-soup \mathcal{L} . The proposition will follow immediately from a sequence of six lemmas that we now state and prove.

It is easy to see (and we will justify this in a moment) that when c is very large, there almost surely exists just one cluster, and that this cluster is dense in \mathbb{U} , i.e., that almost surely, $\overline{\mathcal{C}} = \{\overline{\mathbb{U}}\}$.

Lemma 9.2. *Suppose that $\mathbb{P}_c(\overline{\mathcal{C}} = \{\overline{\mathbb{U}}\}) < 1$. Let $U \subset \mathbb{U}$ denote some open subset of \mathbb{U} , and define U^* to be the set obtained by removing from U all the (closures of) loop-soup clusters \overline{C} that do not stay in U . Then, conditionally on U^* (with $U^* \neq \emptyset$), the set of loops of \mathcal{L} that do stay in U^* is distributed like a Brownian loop-soup in U^* .*

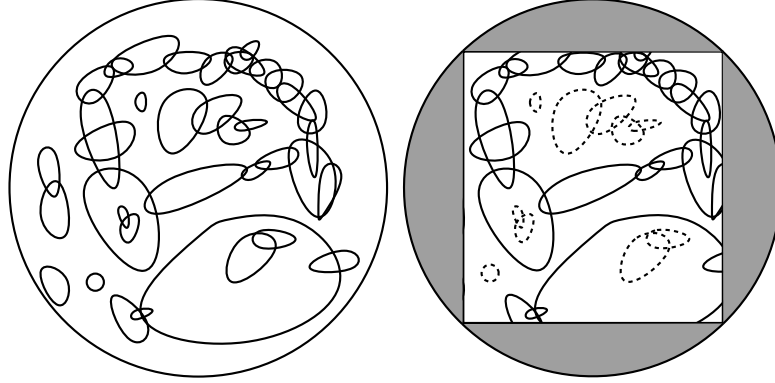

Figure 26: Loop-soup clusters that stay in the rectangle U are dashed (sketch)

Note that we have not yet proved at this point that in this case, Γ is a locally finite collection of disjoint simple loops (this fact will be proved later in this section).

Proof. Let us define for any $n \geq 1$, the set $U_n^* = U_n^*(U^*)$ to be the largest union of dyadic squares of side-lengths 2^{-n} that is contained in U^* (note that this is a deterministic function of U^*). For each $n \geq 1$, and for each union V_n of such dyadic squares the loop-soup restricted to V_n is independent of the event $\{U_n^* = V_n\}$. It implies immediately that conditionally on U^* , the set of loops that do stay in U_n^* is distributed like a Brownian loop-soup in U_n^* . Since this holds for all n , the statement of the lemma follows. \square

Lemma 9.3. *Suppose that $\mathbb{P}_c(\overline{\mathcal{C}} = \{\overline{\mathbb{U}}\}) < 1$ and that there is a \mathbb{P}_c positive probability that $\overline{\mathcal{C}}$ contains an element intersecting the boundary of \mathbb{U} . Then for all positive c' , $\mathbb{P}_{c+c'}(\overline{\mathcal{C}} = \{\overline{\mathbb{U}}\}) = 1$.*

Proof. Assume the hypotheses of the lemma, and let A_1 be the union of all elements of $\overline{\mathcal{C}}$ that intersect some prescribed boundary arc ∂ of \mathbb{U} of positive length. By invariance under rotation, $\mathbb{P}_c(A_1 \neq \emptyset) > 0$. Using the same argument as in the previous lemma, we get that if U is a fixed open set such that $\overline{U} \subset \mathbb{U}$, then conditioned on the event $\overline{U} \cap \overline{A_1} = \emptyset$, the law of the set of loops in \mathcal{L} that are contained in U is the same as its original law (since changing the set of loops within U has no effect on A_1). Since this holds for any U , conformal invariance of the loop soup implies that conditioned on A_1 ,

the law of the elements of \mathcal{L} that do not intersect $\overline{A_1}$ is that of independent copies of \mathcal{L} conformally mapped to each component of $\mathbb{U} \setminus \overline{A_1}$. Note that this in fact implies that the event that A_1 is empty is independent of \mathcal{L} , and hence has probability zero or one (but we will not really need this).

The conformal radius ρ_1 of $\mathbb{U} \setminus \overline{A_1}$ seen from 0 has a strictly positive probability to be smaller than one. We now iterate the previous procedure: We let U_2 denote the connected component of $\mathbb{U} \setminus \overline{A}$ that contains the origin. Note that the harmonic measure of $\partial_2 := \partial \cup A_1$ at 0 in U_1 is clearly not smaller than the harmonic measure of ∂ in \mathbb{U} at 0 (a Brownian motion started at the origin that exits \mathbb{U} in ∂ with necessarily exit U_1 through ∂_2). We now consider the loop-soup in this domain U_2 , and we let A_2 denote the union of all loop-soup clusters that touch ∂_2 . We then iterate the procedure, and note that the conformal radius of U_n (from 0) is dominated by a product of i.i.d. copies of ρ_1 .

This shows that for any positive δ one can almost surely find in Γ a finite sequence of clusters $\overline{C_1}, \dots, \overline{C_k}$, such that $d(C_j, C_{j+1}) = 0$ for all $j < k$, such that C_1 touches ∂ and $d(C_k, 0) \leq \delta$. By conformal invariance, it is easy to check that the same is true if we replace the origin by any fixed point z . Hence, the statement holds almost surely, simultaneously for all points z with rational coordinates, for all rational δ , and all boundary arcs of $\partial\mathbb{U}$ of positive length.

Note that almost surely, each loop of the loop soup surrounds some point with rational coordinates. We can therefore conclude (see Figure 27) that almost surely, any two clusters in $\overline{\mathcal{C}}$ are “connected” via a finite sequence of adjacent clusters in $\overline{\mathcal{C}}$.



Figure 27: The dark solid loop is part of a crossing of (light solid) loops from the left boundary segment to the right boundary segment. The dark dotted loop is part of a crossing of loops from the lower boundary segment to the upper boundary segment.

If we now augment \mathcal{L} by adding an independent Brownian loop-soup \mathcal{L}' of intensity c' for any given positive c' , the new loops will almost surely join together any two adjacent

clusters of $\overline{\mathcal{C}}$ into a single cluster (this is just because any given point $z' \in \mathbb{U}$ – for instance one chosen contact point between two adjacent clusters of $\overline{\mathcal{C}}$ – will almost surely be surrounded by infinitely many small loops of \mathcal{L}'). Furthermore, for an analogous reason, almost surely, any loop of \mathcal{L}' intersects some loop of \mathcal{L} . It follows that for all $c' > 0$, $\mathbb{P}_{c+c'}$ almost surely, there exists just one single cluster, i.e., $\overline{\mathcal{C}} = \{\overline{\mathbb{U}}\}$. \square

Lemma 9.4. *There is a critical constant $c_0 \in [0, \infty]$ such that*

1. *If $c > c_0$, then $\mathbb{P}_c(\overline{\mathcal{C}} = \{\overline{\mathbb{U}}\}) = 1$.*
2. *If $c \in (0, c_0)$, then \mathbb{P}_c almost surely*
 - (a) *$\overline{\mathcal{C}}$ has infinitely many elements.*
 - (b) *No element of $\overline{\mathcal{C}}$ intersects the boundary of \mathbb{U} .*
 - (c) *No two elements of $\overline{\mathcal{C}}$ intersect each other.*

Proof. Suppose that $\mathbb{P}_c(\overline{\mathcal{C}} = \{\overline{\mathbb{U}}\}) < 1$; if there is a \mathbb{P}_c positive probability that two elements of $\overline{\mathcal{C}}$ intersect each other, then (applying Lemma 9.2 to some U that contains one but not the other with positive probability) we find that there is a positive probability that an element of $\overline{\mathcal{C}}$ intersects $\partial\mathbb{U}$.

Also, if $c > 0$ and $\overline{\mathcal{C}}$ has only finitely many elements with positive probability, then (with the same probability) at least one of these elements must intersect $\partial\mathbb{U}$ (since the loops of \mathcal{L} are dense in \mathbb{U} a.s.).

Thus, Lemma 9.3 implies that if c_0 is the supremum of c for which (a), (b), and (c) hold almost surely, then \mathcal{L} has only one cluster \mathbb{P}_c almost surely whenever $c > c_0$. \square

We say c is *subcritical* if the (a), (b), and (c) of Lemma 9.4 hold \mathbb{P}_c almost surely. We will later show that c_0 is subcritical, but we have not established that yet. We remark that the proof of Lemma 9.4 shows that in order to prove that some c is subcritical, it suffices to check (b).

Lemma 9.5. *The c_0 of Lemma 9.4 lies in $(0, \infty)$. Moreover, when $c > 0$ is small enough, there are \mathbb{P}_c almost surely continuous paths and loops in D that intersect no element of \mathcal{L} .*

Proof. We first prove the latter statement: for small $c > 0$ there exist almost surely simple paths crossing \mathbb{U} that intersect no element of \mathcal{L} . This will also imply $c_0 > 0$. To this end we will couple the loop-soup with a well-known fractal percolation model. The argument is similar in spirit to the one for multi-scale Poisson percolation in [26], Chapter 8.

Consider the unit square $D = (0, 1)^2$ instead of \mathbb{U} . For each n , we will divide it into 4^n (closed) dyadic squares of side-length 2^{-n} . To each such square C , associate a Bernoulli random variable $X(C)$ equal to one with probability p . We assume that the $X(C)$ are independent. Then, define

$$M = [0, 1]^2 \setminus \bigcup_{C : X(C)=0} C. \quad (4)$$

This is the fractal percolation model introduced by Mandelbrot in [25] (see also the book [26]). It is very easy to see that the area of M is almost surely zero as soon as $p < 1$. Chayes, Chayes and Durrett [6] have shown that this model exhibits a phase transition: There exists a p_c , such that for all $p \geq p_c$, M connects the left and right sides of the unit square with positive probability, whereas for all $p < p_c$, this is a.s. not the case (note that in fact, if $p \leq 1/4$, then M is almost surely empty by a standard martingale argument). Here, we will only use the fact that for p large enough (but less than one), M connects the two opposite sides of the unit square with positive probability. We remark that the proof in [6] actually gives (for large p) a positive probability that there exists a continuous path from the left to right side of the unit square in M that can be parameterized as $t \rightarrow (x(t), y(t))$ where $t \in [0, 1]$ and $x(t)$ is non-decreasing. It also shows (modulo a straightforward FKG-type argument) that M contains loops with positive probability.

Now, let us consider a loop-soup with intensity c in the unit square. For each loop l , let $d(l) \in (0, 1)$ denote its L^1 -diameter (i.e., the maximal variation of the x -coordinate or of the y -coordinate), and define $n(l) \geq 0$ in such a way that $d(l) \in [2^{-n-1}, 2^{-n})$. Note that l can intersect at most 4 different dyadic squares with side-length 2^{-n} . We can therefore associate in a deterministic (scale-invariant and translation-invariant) manner to each loop $l \subset (0, 1)^2$, a dyadic site $s = (j2^{-n(l)}, j'2^{-n(l)}) \in (0, 1)^2$ such that l is contained in the square S_l with side-length $2 \times 2^{-n(l)}$ and bottom-left corner at s . Note that $S_l \subset (0, 2)^2$.

We are first going to replace all loops l in the loop-soup by the squares S_l . This clearly enlarges the obtained clusters. By the scale-invariance and the Poissonian character of the loop-soup, for each fixed square

$$S = [j2^{-m}, (j+2)2^{-m}] \times [j'2^{-m}, (j'+2)2^{-m}] \subset [0, 2]^2, \quad (5)$$

the probability that there exists no loop l in the loop-soup such that $S_l = S$ is (at least) equal to $\exp(-bc)$ for some positive constant b (that is independent of m). Furthermore, all these events (when one lets S vary) are independent.

Hence, we see that the loop-soup percolation process is dominated by a variant of Mandelbrot's fractal percolation model: let \tilde{X} denote an independent percolation on squares of type (5), with each $\tilde{X}(S)$ equal to 1 with probability $\tilde{p} = \exp(-bc)$ and define the random compact set

$$\tilde{M} = [0, 2]^2 \setminus \bigcup_{S : \tilde{X}(S)=0} S. \quad (6)$$

Note that in the coupling between the loop-soup and \tilde{M} described above, the distance between \tilde{M} and each fixed loop in the loop-soup is (strictly) positive almost surely. In particular, \tilde{M} is contained in the complement of the union of the all the loops (and their interiors).

We now claim that this variant of the percolation model is dominated by Mandelbrot's original percolation model with a larger (but still less than 1) value of $p = p(\tilde{p})$

that we will choose in a moment. To see this, let \hat{X} be a \hat{p} -percolation (with $\hat{p} = p^{1/4}$) on the set of (C, S) pairs with C a dyadic square and S a square comprised of C and three of its neighbors. Take

$$X(C) = \min_{S: C \subset S} \hat{X}(C, S) \text{ and } \tilde{X}(S) = \max_{C: C \subset S} \hat{X}(C, S).$$

Clearly $X(C)$ is a Bernoulli percolation with parameter $p = \hat{p}^4$ and $\tilde{X}(S)$ is a Bernoulli percolation with parameter $1 - (1 - \hat{p})^4$. Let us now choose p in such a way that $\tilde{p} = 1 - (1 - \hat{p})^4$. Note that p tends monotonically to 1 as \tilde{p} tends to 1. Hence, by taking \tilde{p} sufficiently close to 1, i.e. c sufficiently small, we can ensure that p is as close to 1 as we want (so that M contains paths and loops with positive probability). But in our coupling, by construction we have

$$X(C) \leq \min_{C \subset S} \tilde{X}(S),$$

and thus $M \subset \tilde{M}$.

We have now shown that $c_0 > 0$, but we still have to show that $c_0 < \infty$. We use a similar coupling with the fractal percolation model. For any dyadic square that does not touch the boundary of $[0, 1]^2$, we let $X(C)$ be 0 if C is surrounded by a loop in \mathcal{L} that is contained in the set of eight neighboring dyadic squares to C (of the same size). The $X(C)$ are i.i.d. (for all C whose eight neighbors are contained in D), and have a small probability (say smaller than $1/4$) of being 1 when c is taken sufficiently large. We now use the fact, mentioned above, that if $p \leq 1/4$, then M is almost surely empty; from this we conclude easily that almost surely, for each C (whose incident neighbors are in D) every point in C is surrounded by a loop in \mathcal{L} almost surely. It follows immediately that almost surely, every point in D is surrounded by a loop in \mathcal{L} . This implies that almost surely all loops of \mathcal{L} belong to the same cluster (since otherwise there would be a point on the boundary of a cluster that was not surrounded by a loop). \square

Lemma 9.6. *If c is sub-critical, the probability that there are k disjoint chains of loops in $\bar{\mathcal{C}}$ crossing from the inside to the outside of a fixed annulus decays exponentially in k .*

Proof. We know that c is subcritical, so that for all $r < 1$, the probability that there exists a crossing of the annulus $\{z : r < |z| < 1 - 1/n\}$ by a chain of loops goes to 0 as $n \rightarrow \infty$. Hence, there exists $r_1 \in (r, 1)$ such that the probability that there is a single crossing of $\{z : r < |z| < r_1\}$ is strictly smaller than one. Hence, it follows easily that if we consider any given annulus, $\{z : r < |z - z_0| < r'\} \subset \mathbb{U}$, there exists a positive probability that no cluster of the loop-soup crosses the annulus (just consider the two independent events of positive probability that the loop-soup restricted to $\{z : |z - z_0| < r'/r_1\}$ contains no crossing of the annulus, and that no loop intersects both the circles of radius r' and r'/r_1 around z_0). In other words, the probability that there exists a crossing of the annulus is strictly smaller than one. The result then follows from the BK inequality for Poisson point processes (see for instance [3] and the references therein). \square

As a consequence (letting $k \rightarrow \infty$), we see that for each fixed annulus, the probability that it is crossed by infinitely many disjoint chains of loops is zero. We are now ready to state and prove the final lemma of this section:

Lemma 9.7. *If c is sub-critical, the set $\overline{\mathcal{C}}$ is almost surely locally finite. Moreover, when c is sub-critical, then almost surely, all elements of Γ are continuous simple loops.*

Proof. If the set $\overline{\mathcal{C}}$ is not locally finite (i.e. if there exists some ϵ such that there are infinitely many clusters of diameter at least ϵ), then for some positive ϵ there exists a point $z \in \overline{\mathbb{U}}$ and a sequence $\overline{\mathcal{C}}_n$ of elements of $\overline{\mathcal{C}}$ of size greater than ϵ such that $d(z, \mathcal{C}_n) \rightarrow 0$ as $n \rightarrow \infty$. Hence any annulus with outer radius less than $\epsilon/2$ that surrounds z will have infinitely many crossings by disjoint chains of loops. By Lemma 9.6, the probability that such a point exists is zero (this result just follows from the lemma by considering a countable collection of annuli such that each point in \mathbb{U} is surrounded by arbitrarily small annuli from this collection).

Note that by construction, no element of $\overline{\mathcal{C}}$ can have a cut point (recall that almost surely no two loops of \mathcal{L} intersect at only a single point – and that the elements of \mathcal{L} are all simple loops).

It therefore remains only to check that the outer boundary of a cluster is a continuous loop. Several approaches are possible to justify this. Let us first show that the outer boundary of a cluster can be viewed as the outer boundary of a single continuous (non-simple) loop. Let (η_k) be any given countable collection of simple loops in \mathbb{U} such that the graph whose vertices are the loops (with two loops connected if they intersect) is connected. Assume that there are at most finitely many loops above any given diameter, and at most finitely many disjoint crossings by chains of loops of any given annulus (note that all this holds almost surely when (η_k) is the family of loops in a given sub-critical loop-soup cluster). We would like to define a single continuous loop that traces exactly through all of the points on the closure of the union of the η_k . It is not so surprising that this is possible, but requires some justification:

Let T be a spanning tree of the adjacency graph on the η_k and fix a root vertex. Now, relabeling appropriately if necessary (for instance by choosing η_1 to be the root loop and then inductively choose η_k to be the largest child in T of $\eta_1, \dots, \eta_{k-1}$), assume that η_1, η_2, \dots are enumerated in such a way that for every $k > 1$, the loop η_k has one of $\eta_1, \eta_2, \dots, \eta_{k-1}$ as a parent in T . We can inductively define a parameterization of each of the η_k , starting and ending at a point x_k on η_k and taking 2^{-k} time, as follows. Pick a point on η_1 and traverse the loop in time 2^{-1} starting and ending at an arbitrary point x_1 on the loop. Given the parameterizations up to $k-1$, let x_k be the location of the first place that the parameterization of the parent loop of η_k hits η_k . Then choose an arbitrary parameterization of η_k starting and ending at x_k and taking 2^{-k} time.

Now we can define a single loop L that traverses all of the η_j in a total time $1 = \sum_{j=1}^{\infty} 2^{-j}$: We define a sequence of loops L_i converging to L uniformly. First L_1 is the loop that traverses η_1 in order except that each time it hits a point which is an x_k for some $k > 1$ it waits at that point for a time equal to the sum of all the lengths

of η_k and all of its descendants. Thus L_1 traverses η_1 in unit time. We define L_2 the same way except that at each one of the x_k that the L_1 loop paused at we actually traverse the loop η_k (pausing at each x_ℓ on that loop for an amount of time equal to the sum of the lengths of η_ℓ and all of its descendants). Inductively we similarly define L_k , which traverses all loops η_1, \dots, η_k , and note that the finite diameter and finite number of annulus crossing conditions imply that L_1, L_2, \dots converge uniformly to a limiting continuous loop L whose range contains the range of each of L_1, L_2, \dots , hence each η_j . The range of L is therefore exactly the closure of $\cup_k \eta_k$.

Now, it is easy to see that the outer boundary of a continuous loop in the plane is necessarily a continuous loop (this is for instance explained and used the proof of Theorem 1.5(ii) in [4], page 1003). In the case of our loop-soup clusters, we know that this loop is almost surely simple because the cluster has no cut-point. \square

Proposition 9.1 now follows from the results proved in this section: Lemma 9.5 gives the existence of c_0 , Lemma 9.7 implies that the loops are simple and locally finite a.s. (which in particular also implies the existence of outermost clusters), and Lemma 9.2 yields the restriction property.

10 Relation between c and κ

The main result of our Markovian characterization, combined with Proposition 9.1 now implies the following:

Corollary 10.1. *If c is sub-critical, then the set Γ is a CLE_κ for some $\kappa \in (8/3, 4]$. In other words, for such c , the Γ is equivalent in law to the loop ensemble constructed in [43] via branching $SLE(\kappa, \kappa - 6)$.*

We will now identify κ in terms of c .

Proposition 10.2. *For all subcritical c , the set Γ is in fact a CLE_κ with $c = (3\kappa - 8)(6 - \kappa)/2\kappa$.*

Note that in our proof, we will not really use the description of CLE_κ via branching $SLE(\kappa, \kappa - 6)$. We will only use the description of the conformal loop-ensemble via its pinned loop measure, as described in the earlier sections: Suppose that Γ is a random loop ensemble that satisfies the conformal restriction axioms. Consider its version in the upper half-plane \mathbb{H} , and consider the loop $\gamma(i)$ of Γ that surrounds i . Let us now consider the law of $\gamma(i)$ conditioned on the event $\{d(0, \gamma(i)) \leq \varepsilon\}$. We have seen that this law converges when $\varepsilon \rightarrow 0$ to some limit P^i , and furthermore that for some $\kappa \in (8/3, 4]$, P^i is equal to an SLE-excursion law $P^{i, \kappa}$ that we will describe in the next paragraph. Furthermore, when this is the case, it turns out that the entire family Γ is a CLE_κ for this value of κ .

Consider an SLE_κ in the upper half-plane, started from the point $\varepsilon > 0$ on the real axis to the point 0 (on the real axis as well). Such an SLE path will typically be very

small when ε is small. However, one can show that the limit when $\varepsilon \rightarrow 0$ of (the law of) this SLE, conditioned on disconnecting i from ∞ in the upper half-plane exists. This limit (i.e., its law) is what we call $P^{i,\kappa}$.

Conformal invariance of SLE_κ enables to define an analogous measure in other simply connected domains. Suppose for instance that $H = \{z \in \mathbb{H} : |z| < 3\}$. We can again consider the limit of the law of SLE_κ in H from ε to 0, and conditioned to disconnect i from $3i$. This limit is a probability measure $P_H^{i,\kappa}$ that can also be viewed as the image of $P^{i,\kappa}$ under the conformal map Φ from \mathbb{H} onto H that keeps the points 0 and i invariant. Note that the same argument holds for other choices of H , but choosing this particular one will be enough H to identify the relationship between c and κ .

One can use SLE techniques to compare “directly” the laws of an SLE γ from ε to 0 in \mathbb{H} and of an SLE γ' also from ε to 0 in H . More precisely, the SLE martingale derived in [21] show that the Radon-Nikodym of the former with respect to the latter is a multiple of

$$\exp(-cL(\gamma, \mathbb{H} \setminus H; \mathbb{H}))$$

on the set of loops γ that stay in H (recall that $L(A, A'; D)$ denotes the μ -mass of the set of Brownian loops in D that intersect both A and A'), where

$$c = c(\kappa) = \frac{(3\kappa - 8)(6 - \kappa)}{2\kappa}.$$

This absolute continuity relation is valid for all ε , and it therefore follows that it still holds after passing to the previous limit $\varepsilon \rightarrow 0$, i.e., for the two probability measures $P^{i,\kappa}$ and $P_H^{i,\kappa}$. This can be viewed as a property of $P^{i,\kappa}$ itself because $P_H^{i,\kappa}$ is the conformal image of $P^{i,\kappa}$ under Φ .

Note that the function $\kappa \mapsto c(\kappa)$ is strictly increasing on the interval $(8/3, 4]$. Only one value of κ corresponds to each value of $c \in (0, 1]$. Hence, in order to identify the value κ associated to a family Γ of loops satisfying the conformal restriction axioms, it suffices to check that the probability measure P^i satisfies the corresponding absolute continuity relation for the corresponding value of c .

Proof. Suppose that c is subcritical, that \mathcal{L} is a loop-soup with intensity c in \mathbb{H} , and that Γ is the corresponding family of disjoint loops (i.e., of outer boundaries of outermost clusters of loops of \mathcal{L}). For the semi-circle H defined above, we denote by \mathcal{L}' the loops of \mathcal{L} that stay in H , and we denote by Γ' the corresponding family of disjoint loops (i.e. outermost boundaries of outermost clusters). Note that \mathcal{L}' is a loopsoup in H . Let $\gamma(i)$ denote the loop in Γ that surrounds i , and let $\gamma'(i)$ denote the loop in Γ' that surrounds i . Note that if $\gamma(i) \neq \gamma'(i)$, then necessarily $\gamma(i) \notin H$. Furthermore, in order for $\gamma(i)$ and $\gamma'(i)$ to be equal it suffices that:

- $\mathcal{L} \setminus \mathcal{L}'$ contains no loop that intersects $\gamma'(i)$ (note that the probability of this event – conditionally on $\gamma'(i)$ – is $\exp(-cL(\gamma'(i), \mathbb{H} \setminus H; \mathbb{H}))$).

- One did not create another disjoint cluster that goes “around” $\gamma'(i)$ by adding to \mathcal{L}' the loops of \mathcal{L} that do not stay in H . When $\gamma'(i)$ already intersects the disk of radius ε , the conditional probability that one creates such an additional cluster goes to 0 as $\varepsilon \rightarrow 0$ (using the BK inequality for Poisson point processes, as in the proof of Lemma 9.6).

If we now condition on the event that $\gamma'(i)$ intersects the disk of radius ε and let $\varepsilon \rightarrow 0$, it follows that under the limiting law P^i satisfies the absolute continuity relation that we are after: On the set of curves γ that stay in H , the Radon-Nikodym derivative of P^i with respect to the measure defined directly in H instead of \mathbb{H} is $\exp(-cL(\gamma, \mathbb{H} \setminus H; \mathbb{H}))$. Hence, one necessarily has $P^i = P^{i,\kappa}$ for $c = c(\kappa)$. \square

This identification allows us to give a short proof of the following fact, which will be instrumental in the next section:

Proposition 10.3. *c_0 is subcritical.*

Note that the standard arguments developed in the context of Mandelbrot percolation (see [26, 6]) can be easily adapted to the present setting in order to prove that c_0 is subcritical, but not in the sense we have defined it. It shows for instance easily that at c_0 , there exist paths and loops that intersect no loop in the loop-soup, but non-trivial additional work would then be required in order to deduce that no cluster touches the boundary of the domain. Since we have this identification via SLE_κ loops at our disposal, it is natural to prove this result in the following way:

Proof. Let C_c be the outermost cluster surrounding i if the loop-soup (in \mathbb{H}) has intensity c . If we take the usual coupled Poisson point of view in which the set $\mathcal{L} = \mathcal{L}(c)$ is increasing in c (with loops “appearing” at random times up to time c) then we have by definition that almost surely $C_{c_0} = \cup_{c < c_0} C_c$ (this is simply because, almost surely, no loop appears exactly at time c_0). Let $d(c)$ denote the Euclidean distance between \overline{C}_c and the segment $[1, 2]$. Clearly $d(c) > 0$ almost surely for each $c < c_0$ and $d(c_0) = \lim_{c \rightarrow c_0^-} d(c)$.

By the remark after Lemma 9.4, we know that in order to prove that c_0 is subcritical, it suffices to show that $d(c_0) > 0$ almost surely (by Moebius invariance, this will imply that almost surely, no cluster touches the boundary of \mathbb{H}). Note that d is a non-increasing function of the loop-soup configuration (i.e., adding more loops to a configuration can not increase the corresponding distance d). Similarly, the event E_ε that the outermost cluster surrounding i does intersect the ε -neighborhood of the origin is an increasing event (i.e., adding more loops to a configuration can only help this event to hold). Hence it follows that for each ε , the random variable $d(c)$ is negatively correlated with the event E_ε . Letting $\varepsilon \rightarrow 0$, we get that (for subcritical c), the law of $d(c)$ is “bounded from below” by the law of the distance between the curve γ (defined under the probability measure $P^{i,\kappa}$) and $[1, 2]$, in the sense that for any positive x ,

$$P(d(c) \geq x) \geq P^{i,\kappa}(d(\gamma, [1, 2]) \geq x).$$

But we also know that $c_0 \leq 1$, so that $\kappa_0 := \lim_{c \rightarrow c_0^-} \kappa(c) \leq 4$. It follows readily that for all $c < c_0$ and for all x ,

$$\lim_{c \rightarrow c_0^-} P(d(c) \geq x) \geq \lim_{\kappa \rightarrow \kappa_0^-} P^{i,\kappa}(d(\gamma, [1, 2]) \geq x) \geq P^{i,\kappa_0}(d(\gamma, [1, 2]) \geq 2x).$$

But we know that for any $\kappa \leq 4$, the SLE excursion γ stays almost surely away from $[1, 2]$. Putting the pieces together, we get indeed that

$$\begin{aligned} P(d(c_0) > 0) &= \lim_{x \rightarrow 0^+} P(d(c_0) \geq x) \geq \lim_{x \rightarrow 0^+} \lim_{c \rightarrow c_0^-} P(d(c) \geq x) \\ &\geq \lim_{x \rightarrow 0^+} P^{i,\kappa_0}(d(\gamma, [1, 2]) \geq 2x) \geq P^{i,\kappa_0}(d(\gamma, [1, 2]) > 0) = 1. \end{aligned}$$

□

11 Identifying the critical intensity c_0

11.1 Statement and comments

The statements of our main results on Brownian loop-soup cluster, Theorems 1.5 and 1.6, are mostly contained in the results of the previous section: Corollary 10.1, Proposition 10.2, Proposition 10.3. It remains only to prove the following statement:

Proposition 11.1. *The critical constant of Lemma 9.4 is $c_0 = 1$ (which corresponds to $\kappa = 4$, by Proposition 10.2).*

Propositions 9.1, 10.2 and our Markovian characterization results already imply that we cannot have $c_0 > 1$, since in this case the Γ corresponding to $c \in (1, c_0)$ would give additional random loop collections satisfying the conformal axioms (beyond the CLE_κ with $\kappa \in (8/3, 4]$), which was ruled out in the first part of the paper. It remains only to rule out the possibility that $c_0 < 1$.

The proof of this fact is not straightforward, and it requires some new notation and several additional lemmas. Let us first outline the very rough idea. Suppose that $c_0 < 1$. This means that at c_0 , the loop-soup cluster boundaries are described with SLE_κ -type loops for $\kappa = \kappa(c_0) < 4$. Certain estimates on SLE show that SLE curves for $\kappa < 4$ have a probability to get ϵ close to a boundary arc of the domain that decays quickly in ϵ , and that this fails to hold for SLE_4 . In fact, we will use Corollary 4.5 roughly shows that the probability that the diameter of the set of loops intersecting a small ball on the boundary of \mathbb{H} is large, decays quickly with the size of this ball when $\kappa < 4$. Hence, one can intuitively guess that when $\kappa < 4$, two big clusters will be unlikely to be very close, i.e., in some sense, there is “some space” between the clusters. Therefore, adding a loop-soup with a very small intensity c' on top of the loop-soup with intensity c_0 might not be sufficient to make all clusters percolate, and this would contradict the fact that c_0 is critical.

We find it convenient in this section to work with a loop-soup in the upper half plane \mathbb{H} instead of the unit disk. To show that there are distinct clusters in such a union of two CLEs Γ and Γ' , we will start with the semi-disk A_1 of radius 1 centered at the origin. We then add all the loops in Γ that hit A_1 , add the loops in Γ' that hit those loops, add the loops in Γ that hit those loops, etc. and try to show that in some sense the size of this growing set remains bounded almost surely. The key to the proof is to find the right way to describe this “size”, as the usual quantities such as harmonic measure or capacity turn out not to be well-suited here.

11.2 An intermediate way to measure the size of sets

We will now define a generalization of the usual half-plane capacity. Suppose that $\alpha \in (0, 1]$, and that A is a bounded closed subset of the upper half-plane \mathbb{H} . We define

$$M(A) = M_\alpha(A) := \lim_{s \rightarrow \infty} s \mathbf{E}((\text{Im } B_{\tau(A)}^{is})^\alpha), \quad (7)$$

where B^{is} is a Brownian motion started at is stopped at the first time $\tau(A)$ that it hits $A \cup \mathbb{R}$. Note that $M_1 = \text{hcap}$ is just the usual half-plane capacity used in the context of chordal Loewner chains, whereas $\lim_{\alpha \rightarrow 0+} M_\alpha(A)$ is the harmonic measure of $A \cap \mathbb{H}$ “viewed from infinity”. Recall that standard properties of planar Brownian motion imply that the limit in (7) necessarily exists, that it is finite, and that for some universal constant C_0 and for any r such that A is a subset of the disk of radius r centered at the origin, the limit is equal to $C_0 r^{-1} \times \mathbf{E}((\text{Im } B_{\tau(A)})^\alpha)$ where the Brownian motion B starts at a random point $re^{i\theta}$, where θ distributed according to the density $\sin(\theta)d\theta/2$ on $[0, \pi]$.

A *hull* is defined to be a bounded closed subset of \mathbb{H} whose complement in \mathbb{H} is simply connected. The union of two hulls A and A' is not necessarily a hull, but we denote by $A \underline{\cup} A'$ the hull whose complement is the unbounded component of $\mathbb{H} \setminus (A \cup A')$.

When A is a hull, let us denote by $\Phi_A : \mathbb{H} \setminus A \rightarrow \mathbb{H}$ the conformal map normalized at infinity by $\lim_{z \rightarrow \infty} \Phi_A(z) - z = 0$. Recall that for all $z \in \mathbb{H} \setminus A$, $\text{Im}(\Phi_A(z)) \leq \text{Im}(z)$. Then, when A' is another hull, the set $\Phi_A(A' \cap (\mathbb{H} \setminus A))$ is not necessarily a hull. But we can still define the unbounded connected component of its complement in the upper half-plane, and take its complement. We call it $\Phi_A(A')$ (by a slight abuse of notation).

It is well-known and follows immediately from the definition of half-plane capacity that for any bounded closed A and any positive a , $\text{hcap}(aA) = a^2 \text{hcap}(A)$. Similarly, for any two A and A' , $\text{hcap}(A \underline{\cup} A') \leq \text{hcap}(A) + \text{hcap}(A')$. Furthermore hcap is increasing with respect to A , and behaves additively with respect to composition of conformal maps for hulls.

We will now collect easy generalizations of some of these four facts. Observe first that for any positive a we have

$$M(aA) = a^{\alpha+1} M(A). \quad (8)$$

Similarly, we have that for any two (bounded closed) A and A' ,

$$M(A \cup A') \leq M(A) + M(A'). \quad (9)$$

This follows from the definition (7) and the fact that for each sample of the Brownian motion we have

$$(\text{Im } B_{\tau(A \cup A')})^\alpha = (\text{Im } B_{\tau(A) \wedge \tau(A')})^\alpha \leq (\text{Im } B_{\tau(A)})^\alpha + (\text{Im } B_{\tau(A')})^\alpha.$$

Applying the optional stopping time theorem to the local supermartingale $(\text{Im } B_t)^\alpha$, we know that

$$A \subset A' \text{ implies } M(A) \leq M(A'), \quad (10)$$

since

$$\mathbf{E}((\text{Im } B_{\tau(A)})^\alpha | B_{\tau(A')}) \leq (\text{Im } B_{\tau(A')})^\alpha.$$

We next claim that for any three given hulls A' , A_1 and A_2 , we have

$$M(\Phi_{A_1 \sqcup A_2}(A')) \leq M(\Phi_{A_1}(A')). \quad (11)$$

To verify the claim, note first that for $A_3 = \Phi_{A_1}(A_2)$, we have $\Phi_{A_3} \circ \Phi_{A_1} = \Phi_{A_1 \sqcup A_2}$. Recall that $\text{Im } \Phi_{A_3}(z) \leq \text{Im}(z)$ for all $z \in \mathbb{H}$, so that in particular, $\text{Im}(\Phi_{A_3}(B_\sigma)) \leq \text{Im}(B_\sigma)$ where σ is the first hitting time of $\Phi_{A_1}(A')$ by the Brownian motion. We let the starting point of the Brownian motion tend to infinity as before, and the claim follows.

It will be useful to compare $M(A)$ with some quantities involving dyadic squares and rectangles that A intersects. (This is similar in spirit to the estimates for half-plane capacity in terms of hyperbolic geometry given in [14].) We will consider the usual hyperbolic tiling of \mathbb{H} by squares of the form $[a2^j, (a+1)2^j] \times [2^j, 2^{j+1}]$, for integers a, j . Let \mathcal{S} be the set of all such squares. For each hull A , we define $\mathcal{S}(A)$ to be the set of squares in \mathcal{S} that A intersects, and we let \hat{A} be the union of these squares, i.e.

$$\hat{A} = \cup_{S \in \mathcal{S}(A)} S.$$

Lemma 11.2. *There exists a universal positive constant C such that for any hull A ,*

$$CM(\hat{A}) \leq M(A) \leq M(\hat{A}).$$

Proof. Clearly, $M(\hat{A}) \geq M(A)$ by (10) since $A \subset \hat{A}$. On the other hand, if we stop a Brownian motion at the first time it hits \hat{A} i.e. a square S of $\mathcal{S}(A)$, then it has a bounded probability of later hitting A at a point of about the same height, up to constant factor: This can be seen, for example, by bounding below the probability that (after this hitting time of \hat{A}) the Brownian motion makes a loop around S before it hits any square of \mathcal{S} that is not adjacent to S , which would in particular imply that it hits A during that time. This probability is universal, and the lemma follows. \square

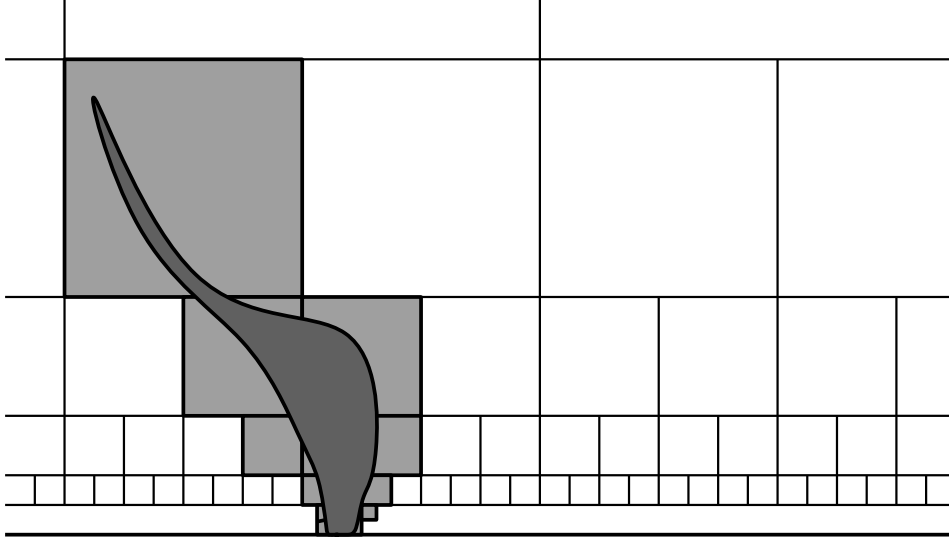

Figure 28: A hull A and its corresponding \hat{A}

Lemma 11.3. *There exists a universal positive constant C' such that for any hull A ,*

$$C' \sum_{S \in \mathcal{S}(A)} M(S) \leq M(A) \leq \sum_{S \in \mathcal{S}(A)} M(S).$$

Proof. The right-hand inequality is obvious by (9) and Lemma 11.2. By Lemma 11.2, it is sufficient to prove the result in the case where $A = \hat{A}$ is the union of squares in \mathcal{S} .

For each j in \mathbb{Z} , we will call \mathcal{S}_j the set of squares that are at height between 2^j and 2^{j+1} . We will say that a square $S = [a2^j, (a+1)2^j] \times [2^j, 2^{j+1}]$ in \mathcal{S}_j is even (respectively odd) if a is even (resp. odd). We know that

$$\sum_{S \in \mathcal{S}(A)} M(S) \leq \lim_{s \rightarrow \infty} s \mathbf{E} \left(\sum_{S \in \mathcal{S}(A)} (\text{Im } B_{\tau(S)}^{is})^\alpha \right). \quad (12)$$

To bound this expectation, we note that for each $j \in \mathbb{Z}$, for each even square $S \in \mathcal{S}_j$, and for each $z \in S$, the probability that a Brownian motion started from z hits the real line before hitting any other even square in \mathcal{S}_j is bounded from below independently from z , j and S . Hence, the strong Markov property implies that the total number of even squares in \mathcal{S}_j hit by a Brownian motion before hitting the real line is stochastically dominated by a geometric random variable with finite universal mean (independently of the starting point of the Brownian motion) that we call $K/2$. The same is true for odd squares.

Note also that if the starting point z of B^z is in $S \in \mathcal{S}_j$ and if $k \geq 1$, then the probability that the imaginary part of B reaches 2^{j+1+k} before B hits the real line is

not larger than 2^{-k} . It follows from the strong Markov property that the expected number of squares in \mathcal{S}_{j+k+1} that B visits before exiting \mathbb{H} is bounded by $K \times 2^{-k}$. It follows that for a Brownian motion started from z with $2^j \leq \text{Im}(z) \leq 2^{j+1}$

$$\mathbf{E} \left(\sum_{S \in \mathcal{S}} (\text{Im } B_{\tau(S)}^z)^\alpha \right) \leq \sum_{k \leq 1} K(2^{j+k+1})^\alpha + \sum_{k \geq 2} K2^{-k}(2^{j+k+1})^\alpha \leq C2^{j\alpha} \leq C(\text{Im } z)^\alpha$$

for some universal constant C (bear in mind that $\alpha < 1$ and that for $S \in \mathcal{S}_{j+k}$, $(\text{Im } B_{\tau(S)}^x) \leq 2^{(j+k+1)}$). If we now apply this statement to the Brownian motion B^{is} after its first hitting time $\tau(A)$ of $A \cup \mathbb{R} = \hat{A} \cup \mathbb{R}$, we get that for all large s and for some universal positive constant C' ,

$$\mathbf{E} \left((\text{Im } B_{\tau(A)}^{is})^\alpha \right) \geq C' \mathbf{E} \left(\sum_{S \in \mathcal{S}(A)} (\text{Im } B_{\tau(S)}^{is})^\alpha \right).$$

Combining this with (12) concludes the proof. \square

For each square $S = [a2^j, (a+1)2^j] \times [2^j, 2^{j+1}]$ of \mathcal{S} , we can define the union $R(S)$ of S with all the squares of \mathcal{S} that lie strictly *under* S , i.e. $R(S) = [a2^j, (a+1)2^j] \times [0, 2^{j+1}]$. Note that that scaling shows immediately that for some universal constant C'' and for all $S \in \mathcal{S}$,

$$M(R(S)) = C''M(S). \tag{13}$$

11.3 Estimates for loop-soup clusters

Let us now use these quantities to study our random loop-ensembles. Suppose that Γ is the conformal loop ensemble corresponding to any given $c \in (0, c_0]$. Given a hull A we denote by $\tilde{A} = \tilde{A}(A, \Gamma)$ the random hull whose complement is the unbounded component of the set obtained by removing from $\mathbb{H} \setminus A$ all the loops of Γ that intersect A . Local finiteness implies that \tilde{A} is itself a hull almost surely.

Now define

$$N(A) = N_\kappa(A) := \mathbf{E}(M(\Phi_A(\tilde{A}))).$$

Recall that if $c < 1$ and $c \leq c_0$ then \mathbb{P}_c defines a CLE_κ with $\kappa < 4$. We can therefore reformulate Corollary 4.5 in terms of c as follows (this corresponds intuitively to the statement that SLE is unlikely to be very close to a boundary arc when $\kappa < 4$):

Proposition 11.4. *If $c < 1$ and $c \leq c_0$, then there is an $\alpha(c) \in (0, 1)$ such that, if we denote by $\text{diam}(A)$ the diameter of A , then we have $\mathbf{E}(\text{diam}(\tilde{A})^{1+\alpha}) < \infty$ for all hulls A .*

Throughout the remainder of this subsection, we will suppose that $c_1 < 1$ and $c_1 \leq c_0$, and that this c_1 is fixed. We then choose $\alpha = \alpha(c_1)$, and we define M and N

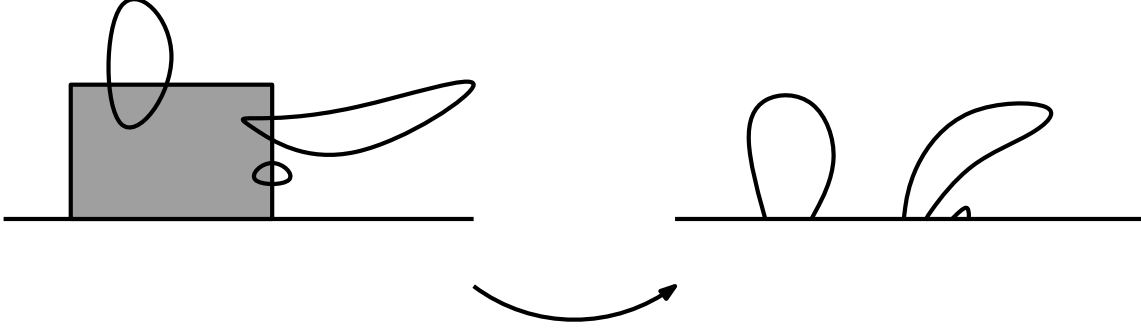

Figure 29: Construction of $\Phi_A(\tilde{A})$ (sketch)

using this value of α . We will then let c vary in $[0, c_1]$. It follows from the previous proposition that for all $c \leq c_1$,

$$N(A) = \mathbf{E}(M(\Phi_A(\tilde{A}))) \leq \mathbf{E}(M(\tilde{A})) \leq \mathbf{E}(\text{diam}(\tilde{A})^{1+\alpha}) < \infty.$$

Here is a more elaborate consequence of the previous proposition:

Corollary 11.5. *Consider $c \leq c_1$ and $\alpha = \alpha(c_1)$ fixed as above. For any hull A and any $S \in \mathcal{S}$, if $A_S = A \cap S$, then*

$$\mathbf{E}(M(\Phi_A(\tilde{A}_S))) \leq C(c)M(S),$$

for some constant $C(c)$ depending only on c and tending to zero as $c \rightarrow 0$.

Proof. By scaling, it suffices to consider the case where $S = [0, 1] \times [1, 2]$ and hence $R = R(S)$ is the rectangle $[0, 1] \times [0, 2]$. Proposition 11.4 then implies that

$$\mathbf{E}(M(\Phi_A(\tilde{A}_S))) \leq \mathbf{E}(M(\tilde{A}_S)) \leq \mathbf{E}(M(\tilde{R})) \leq \mathbf{E}(\text{diam}(\tilde{R})^{1+\alpha}) < \infty.$$

We want to prove that $\mathbf{E}(M(\Phi_A(\tilde{A}_S)))$ tends to zero uniformly with respect to A as $c \rightarrow 0$. Let $E(c)$ denote the event that some loop-soup cluster (in the loop-soup of intensity c) intersecting the rectangle R has radius more than ϵ^2 . When $E(c)$ does not hold, then standard distortion estimates yield an ϵ bound on the height of (i.e., the largest imaginary part of an element of) $\Phi_A(\tilde{A}_S)$. But we then also know that \tilde{A}_S is a subset of $[-1, 3] \times [0, 3]$, so that a Brownian motion started from is will hit \tilde{A}_S before hitting $A \cup \mathbb{R}$ with a probability bounded by s^{-1} times some universal constant C . Hence, unless $E(c)$ holds, we have $M(\Phi_A(\tilde{A}_S)) \leq C\epsilon^\alpha$.

Summing up, we get that

$$\mathbf{E}(M(\Phi_A(\tilde{A}_S))) \leq C\epsilon^\alpha + \mathbf{E}(1_{E(c)}M(\tilde{A}_S)) \leq C\epsilon^\alpha + \mathbf{E}(1_{E(c)}\text{diam}(\tilde{R}^{c_1})^{1+\alpha}),$$

where \tilde{R}^{c_1} denotes the \tilde{R} corresponding to a larger loop-soup of intensity c_1 that we couple to the loop-soup of intensity c . But $\mathbf{P}(E(c)) \rightarrow 0$ as $c \rightarrow 0$ and $\mathbf{E}(\text{diam}(\tilde{R}^{c_1})^{1+\alpha}) < \infty$, so that if we take c sufficiently small,

$$\mathbf{E}(M(\Phi_A(\tilde{A}_S))) \leq 2C\epsilon^\alpha$$

for all hulls A . This completes our proof. \square

We are now ready to prove our final Lemma:

Lemma 11.6. *For $c \leq c_1$, there exists a finite constant $C_1 = C_1(c)$ such that for all hulls A , $N(A) \leq C_1(c)M(A)$. Furthermore, we can take $C_1(c)$ in such a way that $C_1(c)$ tends to zero as $c \rightarrow 0$.*

Proof. Putting together the estimates in Lemma 11.3 and Corollary 11.5 we have

$$\begin{aligned}
N(A) &= \mathbf{E}(M(\Phi_A(\tilde{A}))) \\
&= \mathbf{E}(M(\Phi_A(\bigsqcup_{S \in \mathcal{S}(A)} \tilde{A}_S))) \\
&= \mathbf{E}(M(\bigsqcup_{S \in \mathcal{S}(A)} \Phi_A(\tilde{A}_S))) \\
&\leq \mathbf{E}\left(\sum_{S \in \mathcal{S}(A)} M(\Phi_A(\tilde{A}_S))\right) \\
&\leq \sum_{S \in \mathcal{S}(A)} C(c)M(S) \\
&\leq C(c)(C')^{-1}M(A)
\end{aligned}$$

and $C(c) \rightarrow 0$ when $c \rightarrow 0+$, whereas C' does not depend on c . \square

As we will now see, this property implies that for $c = c_0$, N is necessarily infinite for all positive α (i.e. it shows that the size of clusters at the critical point can not decay too fast), and this will enable us to conclude the proof of Proposition 11.1 in the manner outlined after its statement:

Proof. Suppose that $c_0 < 1$. We choose $c_1 = c_0$ (and $\alpha = \alpha(c_1)$). We take c' to be positive but small enough so that the product of the corresponding constants $C_1(c_0)$ and $C_1(c')$ in Lemma 11.6 is less than 1. We will view the loop-soup \mathcal{L} with intensity $c_0 + c'$ as the superposition of a loop-soup \mathcal{L}_0 with intensity c_0 and an independent loop-soup \mathcal{L}' with intensity c' i.e. we will construct Γ via the loop-soup cluster boundaries in Γ_0 and Γ' .

Now let us begin with a given hull A (say the semi-disk of radius 1 around the origin). Suppose that \mathcal{L} contains a chain of loops that join A to the line $L_R = \{z \in \mathbb{H} : \text{Im}(z) = R\}$. This implies that one can find a finite chain $\bar{\gamma}_1, \dots, \bar{\gamma}_n$ (chain means that two consecutive loops intersect) of loops in $\Gamma_0 \cup \Gamma'$ with $\bar{\gamma}_1 \cap A \neq \emptyset$ and $\bar{\gamma}_n \cap L_R \neq \emptyset$. Since the loops in Γ_0 (resp. Γ') are disjoint, it follows that the loops $\bar{\gamma}_1, \dots, \bar{\gamma}_n$ alternatively belong to Γ_0 and Γ' .

Consider the loops of Γ_0 that intersect A . Let us consider A_1 the hull generated by the union of A with these loops (this is the \tilde{A} associated to the loop-soup \mathcal{L}_0). Recall that the expected value of $M(A_1)$ is finite because $\alpha = \alpha(c_1)$. Then add to A_1 , the loops of Γ' that intersect A_1 . This generates a hull B_2 (which is the \tilde{A}_1 associated to the loop-soup \mathcal{L}'). Then, add to B_2 the loops of Γ_0 that intersect B_2 . Note that

in fact, one basically adds only the loops of Γ_0 that intersect $A_1 \setminus A$ (the other ones were already in A_1) in order to define a new hull B_3 , and continue iteratively. Let F be the limiting set obtained. We can also describe this sort of exploration by writing for all $n \geq 1$, $A_{n+1} = \Phi_{A_n}(\tilde{A}_n)$, where \tilde{A}_n is alternately constructed from A_n using a loop-soup with intensity c_0 or c' as n is even or odd. The expected value of $M(A_n)$ decays exponentially, which implies (Borel-Cantelli) that $M(A_n)$ almost surely decays eventually faster than some exponential sequence.

We note that if A is a hull such that for all $z \in A$, $\text{Im}(z) \leq 1$, we clearly have $\text{hcap}(A) \leq M(A)$. On the other hand, we know that if A is a hull such that there exists $z \in A$ with $\text{Im}(z) \geq 1$, then $M(A) \geq c$ for some absolute constant c . Hence, we see that almost surely, for all large enough n , $\text{hcap}(A_n) \leq M(A_n)$, which implies that almost surely $\sum_n \text{hcap}(A_n) < \infty$. But the half-plane capacity behaves additively under conformal iterations, so that in fact $\text{hcap}(F) = \sum_{n \geq 0} \text{hcap}(A_n)$. Hence, for large enough R , the probability that F does not intersect \bar{L}_R is positive, and there is a positive probability that no chain of loops in \mathcal{L} joins A to L_R . It follows that $\mathbb{P}_{c_0+c'}(\bar{\mathcal{C}} = \{\overline{\mathbb{H}}\}) < 1$ and Proposition 9.1 would then imply that $c_0 + c' \leq c_0$ which is impossible. This therefore implies that $c_0 \geq 1$. As explained after the proposition statement, we also know that c_0 can not be strictly larger than 1, so that we can finally conclude that $c_0 = 1$. \square

As explained at the beginning of this section, this completes the proof of Theorems 1.5 and 1.6.

12 An open problem

When $\kappa \in (4, 8)$, the CLE_κ described in [43] are random collections of non-simple loops. However, the outer boundaries of the sets of points traversed by the outermost loops should be simple loops. We expect (though this was not established in [43], in part because of the CLE_κ construction was not shown there to be starting-point independent) that these random loop collections will satisfy all of the axioms we used to characterize CLE except that they will a.s. contain loops intersecting one another and the boundary of the domain. Are these the only random loop collections for which this is the case?

This is an apparently difficult type of question. We expect that the constructions of one-point and two-point pinned measures in the present paper will have analogs in this non-disjoint setting; however the pinned loop will intersect the boundary at other points as well, and our argument for establishing the connection with SLE does not appear to extend to this setting in a straightforward way. Moreover, we have no direct analog of the loop-soup construction of CLEs in the case where $\kappa \in (4, 8)$.

References

- [1] V. Beffara (2008), The Hausdorff dimension of SLE curves, *Ann. Probab.* **36**, 1421-1452.
- [2] A.A. Belavin, A.M. Polyakov, A.B. Zamolodchikov (1984), Infinite conformal symmetry in two-dimensional quantum field theory. *Nuclear Phys. B* **241**, 333-380.
- [3] J. van den Berg (1996), A note on disjoint-occurrences inequalities for marked Poisson point processes, *J. Appl. Prob.* **33**, 420-426.
- [4] K. Burdzy, G.F. Lawler (1990), Nonintersection Exponents for Brownian Paths. II. Estimates and Applications to a Random Fractal, *Ann. Probab.* **18**, 981-1009.
- [5] F. Camia, C. Newman (2006), Two-dimensional critical percolation: The full scaling limit, *Comm. Math. Phys.* **268**, 1-38.
- [6] J. T. Chayes, L. Chayes, and R. Durrett. Connectivity properties of Mandelbrot's percolation process. *Probab. Theory Related Fields*, 77(3):307-324, 1988.
- [7] D. Chelkak, S. Smirnov (2010), Conformal invariance of the Ising model at criticality, preprint.
- [8] B. Doyon (2009), Conformal loop ensembles and the stress-energy tensor. I. Fundamental notions of CLE, preprint.
- [9] B. Doyon (2009), Conformal loop ensembles and the stress-energy tensor. II. Construction of the stress-energy tensor, preprint.
- [10] J. Dubédat (2009), SLE and the Free Field: Partition functions and couplings, *J. Amer. Math. Soc.* **22**, 995-1054.
- [11] B. Duplantier, S. Sheffield (2008), Liouville Quantum Gravity and KPZ, preprint.
- [12] A. Kemppainen (2009), On Random Planar Curves and Their Scaling Limits., Ph.D. thesis, University of Helsinki.
- [13] W. Kager, B. Nienhuis (2004), A guide to stochastic Löwner evolution and its applications, *J. Stat. Phys.* **115**, 1149-1229
- [14] S. Lalley, G. F. Lawler, and H. Narayanan. Geometric Interpretation of Half-Plane Capacity. *Electronic Communications in Probability*, **14**, 566-571, 2009.
- [15] G.F. Lawler, *Conformally invariant processes in the plane*, Math. Surveys and Monographs, AMS, 2005.

- [16] G.F. Lawler (2009), Schramm-Loewner evolution, in Statistical Mechanics, S. Sheffield and T. Spencer, ed., IAS/Park City Mathematical Series, AMS , 231-295.
- [17] G. F. Lawler, O. Schramm, and W. Werner. The dimension of the planar Brownian frontier is $4/3$. *Math. Res. Lett.*, **8**, 401-411, 2001.
- [18] G.F. Lawler, O. Schramm, W. Werner (2001), Values of Brownian intersection exponents I: Half-plane exponents, *Acta Mathematica* **187**, 237-273.
- [19] G.F. Lawler, O. Schramm, W. Werner (2001), Values of Brownian intersection exponents II: Plane exponents, *Acta Mathematica* **187**, 275-308.
- [20] G.F. Lawler, O. Schramm, W. Werner (2003), Conformal invariance of planar loop-erased random walks and uniform spanning trees, *Ann. Probab.* **92**, 939-995.
- [21] G.F. Lawler, O. Schramm, W. Werner (2003), Conformal restriction properties. The chordal case, *J. Amer. Math. Soc.* **16**, 917-955.
- [22] G.F. Lawler, J.A. Trujillo-Ferreras Random walk loop-soup, *Trans. A.M.S.* **359**, 767-787, 2007.
- [23] G.F. Lawler, W. Werner (2004), The Brownian loop-soup, *Probab. Th. Rel. Fields* **128**, 565-588.
- [24] J.-F. Le Gall, G. Miermont (2009), Scaling limits of random planar maps with large faces. *Ann. Probab.*, to appear
- [25] B. B. Mandelbrot. *The fractal geometry of nature*. W. H. Freeman and Co., San Francisco, Calif., 1982.
- [26] R. Meester and R. Roy. *Continuum percolation*, volume 119 of *Cambridge Tracts in Mathematics*. Cambridge University Press, Cambridge, 1996.
- [27] J. Miller (2010), Fluctuations for the Ginzburg-Landau $\nabla\phi$ Interface Model on a Bounded Domain, preprint.
- [28] J. Miller (2010), Universality for SLE(4), preprint.
- [29] S. Nacu and W. Werner. Random soups, carpets and dimensions, *J. London Math. Soc.*, to appear.
- [30] B. Nienhuis (1982), Exact critical exponents for the $O(n)$ models in two dimensions, *Phys. Rev. Lett.* **49**, 1062-1065.
- [31] Ch. Pommerenke, Boundary behavior of conformal maps, Springer, Berlin, 1992.

- [32] J. Pitman and M. Yor (1982), A decomposition of Bessel bridges, *Z. Wahrscheinlichkeitstheorie verw. Gebiete* **59**, 425-457
- [33] D. Revuz, M. Yor, *Continuous martingales and Brownian motion*, Springer, 1991.
- [34] S. Rohde, O. Schramm (2005), Basic properties of SLE, *Ann. Math.* **161**, 879-920.
- [35] O. Schramm (2000), Scaling limits of loop-erased random walks and uniform spanning trees, *Israel J. Math.* **118**, 221-288.
- [36] O. Schramm (2001), A Percolation formula, *Electr. Comm. Probab.* **6**, paper no. 12.
- [37] O. Schramm, S. Sheffield (2005), Harmonic explorer and its convergence to SLE₄, *Ann. Probab.* **33**, 2127-2148.
- [38] O. Schramm, S. Sheffield (2009), Contour lines of the two-dimensional discrete Gaussian Free Field, *Acta Math.* **202**, 21-137.
- [39] O. Schramm, S. Sheffield, A contour line of the continuum Gaussian Free Field, preprint, 2010.
- [40] O. Schramm, S. Sheffield, D.B. Wilson (2009), Conformal radii in conformal loop ensembles, *Comm. Math. Phys.* **288**, 43-53.
- [41] O. Schramm, S. Smirnov (2010), On the scaling limits of planar percolation, preprint.
- [42] O. Schramm, D.B. Wilson (2005), SLE coordinate changes, *New York J. Math.* **11**, 659-669.
- [43] S. Sheffield (2009), Exploration trees and conformal loop ensembles, *Duke Math. J.* **147**, 79-129.
- [44] S. Sheffield and N. Sun (2010), Strong path convergence from Loewner driving convergence, preprint.
- [45] S. Smirnov (2001), Critical percolation in the plane: conformal invariance, Cardy's formula, scaling limits, *C. R. Acad. Sci. Paris Sér. I Math.* **333**, 239-244.
- [46] S. Smirnov (2007), Towards conformal invariance of 2D lattice models, *Proc. ICM 2006*, vol. 2, 1421-1451.
- [47] S. Smirnov (2010), Conformal invariance in random cluster models. I. Holomorphic fermions in the Ising model, *Ann. Math.* **172**, to appear.
- [48] N. Sun (2010), Conformally invariant scaling limits in planar critical percolation, preprint.

- [49] W. Werner (2004), Random planar curves and Schramm-Loewner Evolutions, in 2002 St-Flour summer school, L.N. Math. **1840**, 107-195.
- [50] W. Werner (2003), SLEs as boundaries of clusters of Brownian loops, C.R. Acad. Sci. Paris, Ser. I Math. **337**, 481-486.
- [51] W. Werner (2005), Conformal restriction and related questions, Probability Surveys **2**, 145-190.
- [52] W. Werner (2006), Some recent aspects of random conformally invariant systems, in Les Houches Summer School, Session LXXXIII, Mathematical statistical mechanics, 57-99, Elsevier.
- [53] W. Werner (2008), The conformally invariant measure on self-avoiding loops, J. Amer. Math. Soc. **21**, 137-169.
- [54] W. Werner. Conformal restriction properties, Proc. ICM 2006, vol. 3, 641-660, 2007.
- [55] D. Zhan (2008), Reversibility of chordal SLE, Ann. Probab. **36**, 1472-1494.

Department of Mathematics MIT, 2-180
77 Massachusetts Avenue
Cambridge, MA 02139-4307
 sheffield@math.mit.edu

Laboratoire de Mathématiques
Université Paris-Sud 11, bâtiment 425
91405 Orsay Cedex, France
 wendelin.werner@math.u-psud.fr