

**Eye and Arm Movement-related Activity in Dorsomedial Frontal Cortex of Monkey**

I-han Chou

A.B., Psychology Harvard-Radcliffe Colleges, 1992

Submitted to the Department of Brain and Cognitive Sciences in partial fulfillment of the requirements for the degree of Doctor of Philosophy in Systems Neuroscience

Massachusetts Institute of Technology

February, 1999

© Massachusetts Institute of Technology 1999

All rights reserved

MIT LIBRARIES  
WITHDRAWN  
JUN 20 2000  
FROM  
MIT LIBRARIES  
SCHERING

Signature of Author: \_\_\_\_\_

Department of Brain & Cognitive Sciences  
January 20, 1999

*I-han Chou*

Certified by: \_\_\_\_\_

Peter H. Schiller  
Dorothy Poitras Professor of Medical Physiology  
Thesis supervisor

*Peter H. Schiller*

Accepted by: \_\_\_\_\_

Gerald E. Schneider  
Professor of Neuroscience  
Chairman, Department Graduate Committee

MASSACHUSETTS INSTITUTE  
OF TECHNOLOGY  
WITHDRAWN  
FROM  
MIT LIBRARIES

SCHERING PLOUGH

## Acknowledgements

First and foremost I need to thank my advisor Peter Schiller for having made this all possible. I am deeply indebted to him for having shared his wisdom and experience with me over the years and remain inspired by his energy and commitment. I would also like to thank the other members of my committee: Emilio Bizzi, Earl Miller, and Jeff Schall, for providing invaluable scientific advice and mentoring. Thanks to all members, past and present, of the Schiller lab for five and a half always interesting years. In particular, I must thank Marc Sommer and Ed Tehovnik, two very special colleagues who got me interested in the study of eye movements in the first place. I have benefited enormously not just from their expertise and invaluable technical assistance, but also their enthusiasm for science. Thanks also to all the other scientists who have encouraged and advised me throughout the years, as well as being wonderful friends: Matt Tresch, Jamie Mazer, Ray Li and Martin Paré.

My eternal gratitude goes to those who have provided technical support over the years. In particular, Wan-ying Chee, CJ Doane and Jennifer Colby all ungrudgingly spent many an hour with me taking care of the practical details of training and surgery. Each of them gave me not only superb assistance, but also great company. Thanks also to Sylvester Sczeganowski, who created wonders in the machine shop. Many thanks also to Bob Marini and all the workers in the Division of Comparative Medicine who performed the grueling and thankless task of caring for the monkeys' daily needs with such diligence and compassion.

Finally, my very deepest gratitude goes to my parents and to all my friends outside of neuroscience and MIT. Despite not comprehending a word about my research, they stood by and supported me with compassion (and sometimes amusement) as I somehow made it through, and they were always there to remind me of the life outside of the walls of the laboratory.

## Abstract

The dorsomedial frontal cortex (DMFC) of the monkey is made up of several anatomically distinct subareas, with an eye movement related area in the rostral region, and arm movement related areas lying medial and caudal to it. However, the functional boundaries between the eye and arm movement areas are unclear. Most studies investigating arm movement functions have tested visually-guided arm movements. Thus activity that appears related to arm movements might actually be related to the accompanying eye movements. Most studies of the eye-movement region have not investigated the possibility of arm movement-related activity. In this thesis, I investigated whether neurons in DMFC that were active during visually-guided reaching were actually responding to individual components of the movement (i.e. saccades or reaching), or to both. A task was used that would dissociate saccade-related from reach-related responses. Over half of the movement-related neurons located within the eye movement representation (as revealed by microstimulation) were responsive to either eye or arm movements. Many neurons in DMFC showed anticipatory activity beginning after the start of fixation, and ending at the time of movement initiation. This discharge seemed to be related to preparation or expectation of the upcoming movement. Monkeys were run on series of trials in which the target predictably occurred or did not occur. The anticipatory activity was attenuated or absent during the block of trials in which the target was not presented and no movement was required. Thus many neurons in DMFC seem to participate in the preparation of movement, regardless of the effector.

**ABSTRACT ..... 3**

**INTRODUCTION: ..... 6**

**Historical overview of organization of motor areas in the frontal lobes. .... 6**  
**Eye movement areas in the frontal lobe: ..... 7**  
**Comparison of SEF to FEF ..... 8**  
1). Stimulation ..... 8  
2). Anatomy ..... 13  
Subcortical Efferents: ..... 13  
Intracortical connections: ..... 15  
3). Single cell recording ..... 18  
4). Lesions (reversible and permanent) ..... 23  
Frontal eye field: ..... 23  
SEF lesions: ..... 26  
5). Human FEF and SEF: lesions and functional imaging ..... 27  
Lesions: ..... 27  
Functional Imaging: ..... 29  
Saccades vs. Smooth pursuit ..... 29  
Summary: ..... 30  
**Functional analogies to arm movement-related areas in DMFC: ..... 31**  
Stimulation: ..... 32  
Single-cell recording: ..... 32  
Lesions: ..... 33  
**References: ..... 34**

**CHAPTER 2: SINGLE-CELL RESPONSES TO EYE AND ARM MOVEMENTS IN THE DORSOMEDIAL FRONTAL CORTEX..... 50**

**Introduction: ..... 50**  
**Methods: ..... 54**  
**Results ..... 60**  
**Discussion: ..... 70**  
**References: ..... 79**

**CHAPTER 3: MODULATION OF THE PRE-MOVEMENT BUILD UP ACTIVITY. .... 94**

**Introduction: ..... 94**  
**Methods: ..... 98**  
**Results: ..... 100**  
**Discussion: ..... 105**  
**References: ..... 112**

**SUMMARY AND CONCLUSIONS ..... 123**

**References: ..... 126**

**APPENDIX: STIMULATION MAPPING IN MONKEY J ..... 128**

**References: ..... 134**

## **Introduction:**

### **Historical overview of organization of motor areas in the frontal lobes.**

In an early pioneering study, Penfield reported two motor representations in the human frontal lobe revealed by electrical stimulation of the cortical surface (Penfield & Welch, 1951). The first lay in what is now called primary motor cortex, on the precentral gyrus. The second representation lay rostral to the first, on the dorsal surface of the brain and extending medially down the convexity to the cingulate sulcus. Higher currents were required to evoke movements than from primary motor cortex, and he noted that the evoked movements tended to be more complex, often involving multiple muscle groups or joints. He named this area the “supplementary motor area” (SMA), as he considered it to be secondary to the primary motor area, MI, a view which has been both challenged and elaborated upon since. In addition, Penfield observed that the second motor area appeared to contain a complete body representation, with arm, leg, trunk, and head movements represented. He also noted that stimulation of the most rostral portion resulted in eye movements.

Recording evoked potentials, Woolsey (1958) also demonstrated two orderly motor representations in monkey that seemed to correspond to primary motor cortex and supplementary motor area (Figure 1A). Woolsey’s maps are now known to be incorrect; it is now believed that there exist not just two, but multiple motor areas in the frontal lobe. Several “premotor” areas have been identified, each with its own independent monosynaptic projections to the spinal cord (Dum & Strick, 1991; He, Dum & Strick,

1995). The term “supplementary motor area (SMA)” now refers to a restricted area of cortex on the medial surface, with “pre-supplementary motor area (pre-SMA)” immediately rostral to it. Primary motor cortex is confined to the pre-central gyrus, with two premotor areas, “dorsal premotor (PMd) and ventral premotor (PMv) lying rostral to it. In addition, several areas have been identified within the cingulate gyrus. In addition to having distinct anatomical projections, the areas differ from each other cytologically (Vogt & Vogt, 1919; Barbas & Pandya, 1987; Matelli et al., 1991), although the distinctions between areas are not as clear as those between extrastriate visual areas, for example. The areas are also distinguishable by differences in neurochemical properties (Roland & Zilles, 1996). Figure 1B, 1C and 1D show the boundaries of the current subdivisions based on cytoarchitectonic (Figs 1B & C) and anatomical (Fig 1D) data. At the moment, there is no widely accepted nomenclature for the different subregions; Table 1 shows the terms used by different researchers. There is also increasing evidence that homologous subdivisions exist in humans (reviewed in Picard & Strick, 1996; Roland & Zilles, 1996).

Insert Figure 1 & Table 1 about here

### **Eye movement areas in the frontal lobe:**

David Ferrier first noted in the latter part of the last century that eye movements could be evoked by electrical stimulation of various regions of the cortex, including certain regions of the frontal lobe (Ferrier, 1875). Ferrier described a single eye field in the frontal lobe; subsequent to this, a number of studies have led to the establishment of two eye movement areas in the frontal lobe (see Schall, 1998 for a review). The frontal

eye fields (FEF) lie in the rostral bank of the arcuate sulcus, including areas 8Ac and 45 (reviewed in Schall, 1998). Lying medial to the FEF, within dorsomedial frontal cortex (DMFC) lie the supplementary eye fields (SEF). The SEF lie rostral to the supplementary motor area (SMA) on the dorsal surface of the brain, within area F7 according to the terminology adapted by Rizzolatti & colleagues (Luppino et al., 1991; Matelli et al., 1991) (Figures 1C & D).

The goal of this dissertation is to shed light on the functions of the dorsomedial frontal cortex around and including the SEF, of which relatively little is understood at this point. That SEF differs from FEF is becoming increasingly clear. To summarize what is known about its role in eye movement generation, I will discuss it in the context of the more-intensively studied frontal eye fields. By comparing and contrasting the effects of stimulation, recording and lesions of the two areas, their relative roles in eye movement control can be determined.

## **Comparison of SEF to FEF**

### **1). Stimulation**

Following Ferrier's early observations, a number of researchers also evoked eye movements by stimulation of the cortex in and around the arcuate sulcus (see Schall, 1998 for a review). Robinson & Fuchs, (1969) were the first to study the FEF using modern microstimulation techniques along with technology that allowed accurate monitoring of eye position. They reported that saccades could be evoked just from the



rostral bank of the arcuate sulcus. Furthermore, the direction and amplitude of the evoked saccades did not depend on initial starting position of the eyes, but on the location of the electrode penetration (Robinson & Fuchs, 1969). These results were subsequently confirmed by Bruce et al., (1985), who showed that the amplitude of the evoked eye movements are organized topographically, with short saccades represented ventrolaterally and large saccades dorsomedially. The vector of the saccade is not affected by changing the initial fixation position. Regardless of the starting position of the eyes, a saccade of the same amplitude and direction is always evoked (e.g. Robinson & Fuchs, 1969; Bruce et al., 1985; Schall, 1991b; Russo & Bruce, 1993; Tehovnik & Lee, 1993).

In contrast, stimulation of the SEF yields saccades of a different nature. Schlag & Schlag-Rey (1987) reported that saccades can be evoked using low currents ( $<50\mu\text{A}$ ) from the SEF, but that regardless of the initial position of the eyes in orbit, stimulation always drives the eyes to the same final orbital position. This finding has been replicated several times (Mitz & Godschalk, 1987; Mann et al., 1988; Luppino et al., 1991; Schall, 1991b; Tehovnik & Lee, 1993). Schlag & Schlag-Rey proposed that the FEF encoded *fixed-vector* saccades whereas the SEF encoded *goal-directed*, or *convergent* saccades. Thus FEF encoded the metrics of a saccade, whereas the SEF encoded the final desired eye position. Whereas saccadic amplitude is organized topographically in the FEF (Bruce & Goldberg, 1985; Bruce et al., 1985), it is the final craniotopic eye position that is organized topographically in SEF (Tehovnik & Lee, 1993; Lee & Tehovnik, 1995).

This distinction in coding schemes has been the subject of some debate; specifically, some researchers have been unable to evoke convergent saccades

consistently from the SEF (Russo & Bruce, 1993; Fujii et al., 1995). Some of these differences may be a consequence of different behavioral paradigms and stimulation parameters used by the different research groups. For example, Russo and Bruce, (1993) found few sites where there was a statistical differences in the direction or amplitude of saccade evoked from different starting positions. However, the saccades evoked at these sites tended to be have relatively short amplitudes (~5 degrees) for the most part. Tehovnik & Lee, (1993) on the other hand, demonstrated convergence at many sites, particularly those with much larger (>20 degree) saccades, as did Schlag & Schlag-Rey (1987). Russo & Bruce (1993) reported that there was a correlation between saccade amplitude and the degree of convergence, so differences in sampling between the studies may have led to different conclusions about the prevalence of convergent sites. The stimulation parameters chosen by the research groups may also have affected the size of the saccade. Large amplitude saccades are sometimes truncated by short train durations such as those used by Russo & Bruce (Tehovnik & Sommer, 1997).

Most of the studies do agree, however, that even at sites where clear convergence is not demonstrated, saccades are more readily elicited if the eyes are initially in the hemifield ipsilateral to the hemisphere being stimulated. Often saccades are not evoked when the eyes are in the contralateral hemifield (Tehovnik & Lee, 1993; Russo & Bruce, 1993). Thus in some cases, it could be argued that the *vector* of stimulation-evoked saccades from a given site in SEF is not affected by the initial eye position, but the *probability* is. This is not the case in frontal eye fields, where initial eye position affects neither the probability nor the vector of saccades being evoked.

As mentioned above, train duration can affect the amplitude of saccades evoked from SEF; at some sites, the amplitude of the saccades increases with train duration, up to 200 msec (Tehovnik & Sommer, 1997). If even longer trains are applied, then another distinction between FEF and SEF is revealed. Prolonged stimulation in FEF yields " a succession of saccades of the same direction and amplitude (Robinson & Fuchs, 1969), as does stimulation of the superior colliculus (Schiller & Stryker, 1972). Prolonged stimulation of the SEF, however, drives the eyes to a specific position where they remain throughout the duration of the stimulation train (Schall, 1991b). If the eye is initially in that specific eye position (termed "termination zone" by Tehovnik & Lee, 1993), stimulation keeps the eyes fixed in that position, and voluntary saccades moving the eyes elsewhere are inhibited until the stimulation is removed (Tehovnik & Lee, 1993).

In fact, a major difference between FEF and SEF seems to be the efficacy of volition in overriding or interacting with stimulation-evoked effects. It has been demonstrated repeatedly that current thresholds vary with the behavioral state of the animal. For example, lower currents are required to evoke an eye movement when the animal is free to make scanning eye movements than when the animal is actively maintaining fixation. This is true in the superior colliculus (Sparks & Mays, 1983), frontal eye fields (Robinson & Fuchs, 1969; Goldberg et al., 1986), and supplementary eye fields (Schlag & Schlag-Rey, 1987). However, the degree to which behavior affects the probability of evoking a saccade is different in each area. Tehovnik et al., (1998) applied stimulation at different current levels and at different times relative to the beginning of fixation to sites in FEF and SEF in the same monkey. They found that more current was required to elicit eye movements at the beginning of the fixation period than

at the end. This was true both of FEF and SEF, but whereas the current threshold was only tripled in FEF, it was raised 16 times in SEF. Fixation, or inhibition of saccades, is one form of voluntary behavior that can interact with stimulation effects. There is also evidence that the saccade evoked by SEF stimulation is affected by planning. If stimulation is applied during the delay period of a delayed-saccade paradigm, the resulting saccade reflects the saccade plan generated by the animal (Fujii et al., 1995). In FEF, several studies have investigated the interactions between stimulation-evoked and visually-guided saccades, but unlike in SEF, the vector of the stimulation-evoked saccade is only affected if stimulation is applied after the saccade is initiated, as in the colliding saccade paradigm (e.g. Schlag & Schlag-Rey, 1990). The strong interaction between volitional behavior and stimulation in SEF may explain why some researchers reported that high current levels are required to evoke eye movements, and why movements sometimes can only be evoked from certain eye positions.

To summarize, electrical stimulation of FEF and SEF yield saccades that seem to be encoded in different frames of reference. One clear distinction between SEF and FEF in terms of stimulation appears to be that SEF stimulation is more affected by behavioral context than FEF stimulation. One reason for this may lie in differences in the strength of their projections to the saccade generators downstream. The behavioral data would suggest that FEF makes a larger, or more robust projection to output than does SEF. The anatomical evidence will be presented next.

## 2). Anatomy

### **Subcortical Efferents:**

Both FEF and SEF make monosynaptic projections to oculomotor nuclei in the mesencephalon and pons which contain saccade-related and omnipause neurons, such as the paramedian pontine reticular formation, medial reticular formation, and nucleus raphe interpositus (Stanton et al., 1988b; Leichnetz et al., 1984a,b; Segraves, 1992; Shook et al., 1988,1990). Both areas also project to oculomotor nuclei in the thalamus such as MD, and X (Huerta & Kaas, 1990; Shook et al., 1991) and to dorsolateral and dorsomedial parvocellular red nucleus, which project in turn to the inferior olive (Leichnetz et al., 1984; Stanton et al., 1988a; Shook et al., 1990). They also project to the superior colliculus, both directly, (Fries, 1984; Segraves & Goldberg, 1987; Stanton et al., 1988a; Huerta et al., 1986; Huerta & Kaas, 1990) and indirectly via the basal ganglia (Stanton et al., 1988a; Shook et al., 1991; Parthasarthy et al., 1992).

In general, the two areas project to the same structures, although the terminal fields tend not to overlap. Differences exist, however, in the organization of the projections. FEF projects to the superior colliculus in a highly systematic fashion. Antidromic activation experiments have shown that FEF neurons make excitatory projections to SC neurons with similar movement fields, and inhibitory to those with movement fields farther away from its own (Schlag-Rey et al., 1992; Segraves & Goldberg, 1987). The result is an orderly topography in the projection, with each region of the FEF projecting to those parts of the SC with corresponding movement fields (see Figure 17 in Schall, 1998).

Such experiments in functional connections and projection topography have not been performed to date with SEF. However, it has been reported that the SEF projections to the colliculus (Fries, 1984; Huerta & Kaas, 1990; Shook, 1990) and to the striatum (Parthasarathy et al., 1992) are more diffuse than those from the FEF. Furthermore, it has been reported that SEF makes extensive bilateral projections to the superior colliculus (Fries, 1984; Shook et al., 1990), whereas FEF makes almost exclusively ipsilateral connections. This difference in specificity in projection may reflect how the fixed-vector and convergent saccades evoked from FEF and SEF respectively could be implemented. The saccade vector represented in FEF is transmitted faithfully to the superior colliculus by virtue of the correspondence between the two maps. Bringing the eye to a final position, however, requires saccades of different amplitudes and directions, which are accomplished by virtue of a diffuse bilateral projection. A recent study has shown that FEF also receives visual and saccade-related input from the SC (Sommer & Wurtz, 1998). It is proposed that this projection might serve to reinforce and synchronize visual signals in the two areas. Whether such reciprocal connections exist with SEF is not known.

Although the anatomical data shows that both SEF and FEF have access to oculomotor areas downstream, there is evidence that the efficacy of the FEF projection is greater than the SEF projection. If either the FEF or SEF are removed surgically, monkeys are still able to make fairly accurate saccades for the most part. Specific deficits will be discussed in a later section. Saccades can also be evoked from SEF by electrical stimulation after FEF is ablated (Tehovnik et al., 1994) as long as the superior

colliculus is intact. If both FEF and SC are ablated, however, eye movements are abolished, and do not recover (Schiller et al., 1980). It is not known whether stimulation of SEF after combined FEF-SC ablation would still be effective in eliciting eye movements, but activity in the SEF projection to the brainstem by itself is not sufficient for generating eye movements.

There are also reports that the density or size of the projections originating from SEF and FEF differ, however, such observations are highly dependent on the size and location of the tracer injections. It would be desirable to have some functional measure of the efficacy of the projections from SEF and FEF to areas such as the superior colliculus. Differences in the frequency of neurons activated, or the current threshold required to antidromically activate neurons might provide a direct measure of the strength of the connection.

### **Intracortical connections:**

Both FEF and SEF make projections with a large number of cortical areas, including visual, association, and motor cortices. For both FEF and SEF, one of the heaviest intracortical projections is the interconnection between the two areas themselves (Huerta & Kaas, 1990; Schall et al., 1993). The two areas do not project to each other in an orderly point-to-point fashion, but rather there is divergence and convergence. The region of FEF encoding intermediate amplitude saccades receives input from a larger extent of SEF than do the small or large-amplitude regions. Given that there seems to be a map of orbital position in SEF (Tehovnik & Lee, 1993; Lee & Tehovnik, 1995) and a retinotopic map in FEF, this pattern of divergent and convergent connectivity may

represent how the different coding schemes for saccades are accomplished (Schall et al., 1993).

Comparing the sensory input into each area, FEF receives inputs from more visual areas than SEF. There are two pathways by which visual information reaches the frontal lobe. The segregation begins at the level of the retina and the two streams are thought to enhance visual processing in different domains. One pathway includes areas MT, MST, and parietal areas such as LIP. It is thought to be involved in localizing stimuli, being specialized in motion processing and the integration of eye position. The other stream includes areas V4 and areas in inferotemporal cortex. It is thought to contribute to object recognition, the neurons having complex visual tuning properties. FEF receives input from visual areas in both streams, with projections from V4, MT, MST, AIT, TEO, the caudal portion of TE, and a weak projection from V2 and V3, whereas SEF only receives projections from a limited number of visual areas in the dorsal stream (MT, MST) (Huerta & Kaas, 1990; Schall et al. 1995).

Besides visual information from extrastriate areas, both SEF and FEF also receive auditory and somatosensory input. Both areas also receive projections from the superior temporal polysensory area (STP), which contains neurons with multimodal receptive fields (Schall et al., 1995). Several areas have been identified in the parietal lobes such as LIP and area 5 that are related to the planning of eye and arm movement generation. The most prominent parietal - FEF projection originates in lateral intraparietal area (LIP). In addition to LIP, SEF also receives input from areas related to arm movements, such as area 5 (Dum & Strick, 1991). SEF is also interconnected with arm-movement related



areas in the frontal lobe, such as SMA (F3) and premotor cortex (F2). In addition, both the FEF and SEF are connected with areas related to learning. It receives a large input from dorsolateral pre-frontal cortex areas 46 and 9 (Huerta & Kaas, 1990), which are related to working memory (Funahashi et al., 1988; Miller et al., 1996). There exist in the forebrain dopaminergic neurons that are related to the encoding of reward contingency (reviewed in Schultz, 1998). The primary projection field of these neurons is to the frontal cortex. SEF receives input from these areas indirectly via pre-frontal cortex, but dorsomedial frontal cortex itself also contains a high density of dopaminergic terminals (Williams & Goldman-Rakic, 1993).

Insert Figure 2 about here

In summary, the anatomical evidence shows that SEF & FEF both make projections to oculomotor structures in the midbrain and brainstem but the FEF projection is more dense and the projections are more orderly. The primary sensory input to FEF is visual, and it receives inputs from many more areas than SEF, notably, from temporal lobe areas implicated in form recognition. This lends further support for the notion that FEF is primarily involved in saccade generation only, whereas with its multimodal sensory input, and connections with higher-order association areas involved in working memory and reward, SEF may play a more modulatory role in saccade generation. SEF also is connected with areas involved in skeletomotor movement, suggesting that it may be implicated in movements other than saccades.

### 3). Single cell recording

Both SEF and FEF contain neurons associated with eye movements that display a variety of sensory and movement responses. Neurons in each area can be categorized based on presence of sensory or motor responses, and by the temporal profile of their firing. Cells that are commonly encountered in both areas include: visual cells, which discharge either phasically or tonically in response to a stimulus, visuo-movement cells, which discharge both for the stimulus and then for the ensuing movement, and movement cells, which discharge near the time of the movement onset (Bruce & Goldberg, 1985; Schall, 1991b). Movement cells can either be pre or post-saccadic (Bizzi, 1969), depending on whether the burst occurs before or after initiation of the saccade. Neurons with sensory or motor responses are common to both areas, but postsaccadic neurons are more common in FEF than in SEF (Schall, 1991b). In addition, there are several cell classes that are more common in SEF than in FEF. These include a class of neurons whose properties only become obvious when a delay is imposed before the monkey is permitted to make the saccade. These neurons discharge throughout the delay period, shutting off when the movement is made. These neurons, described in Schlag & Schlag-Rey, (1985, 1987), were termed "preparatory set" cells by Schall, and are found with greater frequency in SEF than in FEF (Schall, 1991b). The term "preparatory set" was first used to describe the firing profile of certain neurons in supplementary motor area and motor cortex while monkeys waited to make arm movements (e.g. Okano & Tanji, 1987; Alexander & Crutcher, 1990). In SEF, some neurons display an analogous response, but in this case the effectors of the movement are the eyes rather than the arms.

Another class of neurons that are present in SEF but not in FEF are those modulated by eye position. FEF neurons are tuned to saccade of specific amplitudes and directions, and their responses are not modulated by initial starting position of the eyes (Russo & Bruce, 1996). In SEF their firing rate is related to orbital position (Schlag & Schlag-Rey, 1987; Schall 1991a ; Lee & Tehovnik, 1995; Bon & Luchetti, 1992). Some neurons discharge for certain endpoints of saccades, or when the eye passes through a certain orbital position during tracking, or attentive fixation (Mann, Thau & Schiller, 1988; Schall, 1991a; Lee & Tehovnik, 1995; Bon & Luchetti, 1992). One exceptional result should be noted, however; Russo & Bruce (1996) found almost no variation in receptive field or preferred movement direction with changes in initial eye position in 224 presaccadic SEF neurons, which would suggest that the coding is retinotopic, similar to that in FEF.

Insert Table 2 about here

Another research group has proposed that the coding scheme in SEF may be neither retinotopic nor head-centered, but object centered. Olson & Gettner, (1995) trained monkeys to perform a task in which they made saccades to one end or another of a horizontal bar. Some SEF neurons discharged preferentially when the saccade was made to one end of the bar and not the other, regardless of the location of the bar.

One prominent difference between movement neurons in FEF and SEF is the time course of the neural activity. The latency of activity in sensory neurons to visual stimuli tend to be longer in SEF than in FEF (Schall, 1991b). Also, the visual responses in SEF can be modified by the behavioral context. When monkeys were tested on a GO-NOGO

paradigm, the activity in response to the stimulus ceases after the NOGO cue is given, even though the stimulus is still present. In FEF, on the other hand, visual tonic neurons only cease firing when the stimulus is removed (Schall, 1991b). Some neurons are also NOGO specific in SEF, firing only when the cue is given to withhold a saccade (Mann et al., 1988; Schall, 1991a); these neurons have not been observed in FEF (Schall, 1991b).

Differences in timing also exist in the movement-related neurons, with regard to when they occur relative to movement onset and how tightly coupled the neural activity and behavior are to each other. As mentioned above, the majority of movement-related neurons in SEF begin firing well before rather than after movement initiation. Hanes et al., (1995) showed that the firing of many SEF "preparatory set" neurons terminated well before saccade initiation. FEF neurons, on the other hand, tend to start discharging just before (within 150 msec (Segraves & Park, 1993)) or after the beginning of the saccade. Hanes & Schall, (1996) investigated the relationship between the level of activity of FEF neurons and when a voluntary saccade was initiated. They showed that saccades were initiated when the activity rose above a certain fixed threshold, such that the rate of increase in pre-saccadic activity in FEF neurons was reliably related to saccadic latency. Furthermore, saccades were only initiated on trials where FEF activity rose above this threshold. In a task where monkeys were occasionally instructed to inhibit the saccades, the probability of saccade initiation on a given trial was directly related to the level of neural activity in that trial (Hanes et al., 1998). Applying the same analysis to SEF neurons, the researchers discovered that the neuronal activity was less predictive of saccade occurrence (Patterson & Schall, 1997).

There is evidence that the activity of some SEF neurons changes with learning. Chen & Wise (1995a, 1995b) compared the activity of SEF and FEF neurons while monkeys learned associations between visual stimuli and saccade directions. Monkeys were trained to make saccades in one of four directions in response to complex visual stimuli. They recorded from neurons when the monkeys made saccades in response to familiar stimuli, and when the monkeys were learning new associations. They found that the activity of some SEF neurons was elevated during trials in which the monkeys were learning the associations, but the discharge returned to baseline after the association was well learned and the monkeys made few errors. Another population of neurons shows little activity until an association was learned. More than 40% of SEF neurons showed some changes in activity with learning, whereas relatively few (11%) FEF neurons showed such modulation (Chen & Wise, 1995b).

Another way in which SEF activity is distinct from FEF may be the dependency of neural activity on behavioral context. One feature of FEF movement neurons is that many discharge only in relation to task-related saccades. Less than 10% of neurons appeared to be saccade-related when monkeys made scanning saccades in the dark (Bizzi, 1969; Bizzi & Schiller, 1970), whereas about 50% were responsive when monkeys made visually-guided saccades for reward (e.g. Bruce & Goldberg, 1985; Schall, 1991b). Some studies have reported that SEF neurons do discharge to spontaneously generated saccades (Schlag & Schlag-Rey, 1985,1987), although another failed to report such an observation using a different reward contingency (Schall, 1991a). One difference between spontaneous and task-related saccades in this case may have been the presence versus lack of visual guidance for the saccades. Schlag-Rey et al, (1997) compared

visually versus self-guided saccades by using an antisaccade task. In this task, monkeys are presented with a peripheral target but are instructed either to make a saccade to it, or to make an "antisaccade", and to make a saccade away from it. To execute these antisaccades, monkeys must first inhibit the visually-guided saccade towards the target and then generate a saccade in the opposite direction without any visual cues. SEF neurons show elevated activity before initiation of antisaccades, compared to visually-guided saccades of the same amplitude and direction (Schlag-Rey, et al., 1997).

In summary, based on the single-cell evidence presented so far, many FEF neurons discharge with short latencies to visual stimuli, or with a consistent, predictable relationship to the saccade onset. In contrast, a higher proportion of SEF movement-related neurons discharge in an anticipatory fashion and their activity is not predictive of saccade occurrence. FEF neurons also tend to be unimodal, showing only visual or auditory responses, whereas SEF neurons have multimodal responses. FEF neurons are well-tuned for contraversive saccades of certain retinotopic vectors. Some SEF neurons on the other hand, are modulated by eye position, and by behavioral context. Their responses can change with experience, and some neurons discharge at a higher rate when the saccade is internally generated.

#### **4). Lesions (reversible and permanent)**

##### **Frontal eye field:**

It has long been reported that following frontal lobe lesions, both humans and monkeys show varying degrees of visual neglect, a syndrome in which they ignore objects in the hemifield contralateral to the lesions. In its most severe form, monkeys seem unaware of stimuli presented in the lesioned hemifield (Kennard & Ectors, 1938; Rizzolatti et al., 1983). In a milder form of neglect, there is no deficit in detecting or tracking single objects, even in the lesioned hemifield, but if both hemifields are stimulated simultaneously, animals ignore the stimulus in the lesioned hemifield. When monkeys were presented either two appetitive stimuli such as peanuts or two aversive stimuli, they showed extinction, ignoring the stimulus in the hemifield contralateral to the lesion. (Crowne et al. 1981; Van der Steene et al., 1984; Latto & Cowey, 1971a). Monkeys also tend to circle repetitively (e.g. Kennard & Ectors 1938; Latto & Cowey, 1971a) and there are several reports of ipsilateral conjugate deviation of the eyes (Latto & Cowey 1971b). These deficits tend to be short-lived and generally recover within a few days to a week from the time of surgery.

More controlled studies revealed only small deficits in perception and in eye movement generation. Latto & Cowey (1971a) reported a mild deficit in detecting dim visual stimuli in the periphery (>20 degrees), although it should be noted that this study was not performed with an eye coil, nor with calibrated visual displays. Only small deficits have been reported in saccadic eye movements, generally an increase in latency and a tendency for the saccades to be hypermetric (e.g. Schiller et al., 1980), which recover within a few weeks. It appears that there are multiple brain areas sufficient for

generating saccades, and that loss of FEF function are compensated by other areas, such as the superior colliculus. Major impairments in saccadic eye movements are observed only after combined ablation of both frontal eye fields and superior colliculus (Schiller et al., 1980). Saccades made to briefly flashed targets are affected for a longer time course (Schiller & Sandell, 1983) and Deng et al., (1986) reported a specific deficit in learning to make memory-guided saccades. With reversible inactivation, similar effects are seen as with chronic ablation. Single, visually-guided saccades are generally unaffected; memory-guided and saccades made to extinguished targets are impaired (Sommer & Tehovnik, 1997; Dias et al., 1995). Thus the most consistently observed deficits following FEF lesions are a failure to attend to stimuli in the contralesional hemifield and an impaired ability to detect transient stimuli.

We used the following task, described in Schiller & Chou, (1998) to investigate these two deficits. Monkeys were presented with two targets, located symmetrically across the vertical meridian, with an angular separation of 90 degrees. The targets were presented with a range of stimulus onset asynchronies (SOA's) ranging from zero (simultaneous presentation) to one of the stimuli appearing 300 msec before the other. The monkeys were rewarded for making a saccade to either target.

When presented simultaneously with identical targets, intact monkeys generally made saccades to each of the targets with almost equal probability. When the two targets were presented with a temporal offset, monkeys made more saccades to whichever stimulus had appeared first. As the SOA was increased, monkeys made an increasingly high proportion of saccades to the first target. Immediately following lesions of frontal eye fields, monkeys made saccades exclusively to the stimulus in the ipsilesional



hemifield when the targets were presented simultaneously. However, if the stimulus appearing in the contralesional hemifield was presented a sufficient amount of time before the ipsilesional one, the monkeys could be induced to make saccades to it. When a range of SOA's was tested, it was revealed that the monkeys still showed a similar relationship between SOA and the relative proportion of saccades contra and ipsiversive to the lesion as intact monkeys, but the entire function had shifted. Two weeks after the lesion, ipsi and contraversive saccades were made with equal probability when the contralesional target appeared 116 milliseconds prior to the ipsilesional target.

We hypothesized that damage to the FEFs led to a delay in the process of transforming a visual stimulus into the target of a saccade. Changes in the relative timing or strength of signals arriving at the superior colliculi or brainstem from the two hemispheres should have consequences for the computation of the final saccade vector.

Thus extinction perhaps can be conceived of as a quantifiable *delay* between the left and right hemispheres that can be compensated for by introducing a temporal offset in stimulus onset. This is consistent with reports that visually-evoked potentials have a longer latency in human patients with neglect (e.g. Spinelli et al., 1994). It should be noted that the bias towards stimuli in the intact hemifield *can* be compensated by increasing the contrast of the stimulus in the contralesional hemifield, which would seem consistent with loss of detection sensitivity. However, decreasing the salience of stimuli also introduces delays in their processing. As luminance is decreased, the transmission time already through the retina increases. Thus the underlying reason why lower luminance stimuli are less salient may not be by virtue of lower perceptual contrast per se, but by virtue of the temporal lag that results from increased transmission time.

We have additional evidence supporting the notion that it is the temporal information that is degraded following FEF lesions. We have directly tested the monkey's ability to discriminate between stimuli based on their onset time and to indicate which stimulus they saw as appearing first. We presented eight identical targets, one of which appeared at a randomly determined amount of time before the other seven. The monkeys' task was to detect the earliest appearing target. Following frontal lesions, the monkeys were severely impaired in detecting the target when it was presented in the contralesional hemifield (Schiller & Chou, 1998).

Thus we propose that the neglect commonly observed after unilateral frontal lobe damage may in part be due to an increase in the time required to select and process the visual stimuli and to translate that information into a motor output. The increased time required for such processing may account for commonly-reported symptoms such as circling behavior, deviation of the eyes toward the side of the lesion, and the paucity of scanning saccades made contraversive to the lesion.

### **SEF lesions:**

Far fewer studies have investigated the effects of SEF lesions than FEF. In contrast to FEF inactivation, reversible inactivation of SEF with lidocaine does not affect single saccades, regardless of whether the target is extinguished or not (Sommer & Tehovnik, 1998). When dorsomedial frontal cortex encompassing the SEF was ablated, monkeys showed extinction similar to that observed following FEF lesions (Luchetti, Lui & Bon, 1998; Schiller & Chou, 1998). As with the FEF lesions, the extinction could be offset by presenting the contralesional stimulus before the ipsilesional one. However,

smaller onset asynchronies were required to compensate for changes in target choice following SEF lesions than FEF (Schiller & Chou, 1998).

One theory about dorsomedial frontal cortex is that it is involved in the acquisition and performance of coordinated movements or sequences. Lesions that include the SEF lead to impairments in the execution of sequences of saccades (Schiller & Chou, 1998; Sommer & Tehovnik, 1998). However, the deficit in sequence execution is even greater following FEF lesions (Schiller & Chou, 1998; Sommer & Tehovnik, 1998). It remains to be tested in monkeys whether SEF lesions lead to deficits in tasks such as those employed in single cell recording studies which preferentially activate SEF. For example, SEF lesions may lead to specific learning deficits or in the generation of antisaccades. To some degree, such results have already been observed in studies of human subjects.

##### **5). Human FEF and SEF: lesions and functional imaging.**

###### **Lesions:**

Studies of humans with frontal eye field lesions are generally consistent with the monkey studies. Patients usually are able to make contraversive saccades to visually-guided targets, albeit sometimes with a decreased amplitude gain (Guitton, Buchtel, & Douglas, 1985; Braun et al., 1992; Rivaud et al., 1994), but are impaired in more difficult tasks. One such task is the antisaccade task, in which subjects were instructed to look *away* from a visual target. Patients had difficulty in suppressing reflexive saccades towards the target (Guitton et al., 1985), although in this study, some of the lesions

included large portions of the frontal lobes. A study with more restricted lesions revealed that it may have been pre-frontal damage that was more responsible for the deficit (Pierrot-Deseilligny et al., 1991a). Other studies also with more restricted lesions revealed that memory-guided saccades are also impaired (Pierrot-Deseilligny et al., 1991b, 1993; Rivaud et al., 1994.) Visual pursuit and predictive tracking are also affected following focal frontal eye field lesions (Rivaud et al., 1994).

The effects of SEF lesions in humans have also been investigated. One study reports that whereas FEF lesions affect memory-guided saccades where the location of the target has to be memorized based on visual information, SEF lesions affect the ability to memorize target location based on vestibular information. (Pierrot-Deseilligny et al., 1993).

Other studies reported that patients with damage to DMFC are specifically impaired at generating sequences of saccades (Gaymard et al., 1990, 1993) or arm movements (Dick et al., 1986).

It should be noted that SEF lesions in humans are rarely focal, and generally encompass large portions of dorsomedial cortex (e.g. Gaymard et al., 1990). Generally, lesions in this area are either labelled as being in the SMA or SEF without any qualification or explanation as to which area is affected (e.g. compare Gaymard et al., 1990; Pierrot-Deseilligny et al., 1991 to Pierrot-Deseilligny et al., 1993).

## **Functional Imaging:**

Functional imaging studies investigating selective increases in regional blood flow have shown selective activation of two regions within the frontal lobe in response to eye movements (Melamed & Larsen, 1987; Orgogozo & Larsen, 1979; Fox et al., 1985), but their anatomical locations do not correspond exactly to those in monkey. FEF lies in area 6, between the pre-central and the central gyri, not in area 8 (reviewed in Paus, 1996; Luna et al., 1998). The location of SEF in humans also differs from monkeys: it is located more medially, on the medial wall of the intracerebral fissure (Anderson, 1994; Fox et al., 1985; Luna et al., 1998), rather than on the dorsal surface.

Nonetheless, the two areas correspond fairly well in terms of function to their counterparts in monkey. Both FEF and SEF are activated by visually-guided saccades (e.g. Anderson, 1994; Sweeney et al., 1996; Luna et al., 1998) and FEF is also activated by smooth pursuit, although the peak of activation lies slightly lateral to that obtained by saccades (Petit et al., 1997). Both FEF and SEF show greater activation during complicated tasks such as the antisaccade task (O'Driscoll et al., 1995; Sweeney et al., 1996; Doricchi et al., 1997) as compared to target-directed saccades. SEF but not FEF is selectively activated by memory-guided saccades (Anderson et al., 1994). It has also been shown that the activity in SEF is enhanced when subjects perform sequences of saccades as opposed to single ones (Petit et al., 1996).

## **Saccades vs. Smooth pursuit**

Saccades are not the only type of eye movement processed by FEF and SEF. Saccadic and smooth pursuit eye movements are controlled by two separate systems with

different neural circuitry. Both FEF and SEF contain subregions with neurons that are responsive to each. In the FEF, saccade-related neurons are located in the anterior bank of the arcuate sulcus. There is a separate region, deep in the fundus and in the posterior bank of the arcuate that contains neurons responsive to smooth pursuit. Electrical stimulation of this area elicits smooth rather than saccadic eye movements (Gottlieb, MacAvoy & Bruce, 1993). Consistent with these findings, lesions of FEF that do not include the fundus or posterior bank generally do not disrupt pursuit, or yield only small, temporary deficits. Large consistent deficits in pursuit are observed following unilateral lesions that include the fundus; both initial acceleration and peak velocity of pursuit are decreased (MacAvoy, Gottlieb & Bruce, 1991; Keating, 1991,1993; Keating et al., 1996; Lynch, 1987; Shi, Friedman & Bruce, 1998). The magnitude of the deficit seems to correspond to the extent to which the fundus is damaged (Keating, 1991,1993; MacAvoy et al., 1991).

The SEF also contain a separate region devoted to pursuit as opposed to saccades, at least in Cebus monkeys (Tian & Lynch, 1997). Stimulation of the SEF can inhibit or slow pursuit and pursuit-related neurons are found in SEF (Heinen, 1995). The responses of these neurons can be modulated by expectation, as they discharge at a higher rate when the direction and velocity of the target is predictable (Heinen & Liu, 1997).

### **Summary:**

There are two distinct oculomotor regions in frontal cortex. Both are connected to subcortical oculomotor areas such as the superior colliculus, and oculomotor nuclei in the mesencephalon and pons, but the FEF projections are systematic and topographic and the

SEF projection more diffuse. Both receive sensory information from several areas, but the FEF receives primarily visual input, including many extrastriate areas. The SEF receives input from a limited number of extrastriate areas, but also makes connections with somatosensory, prefrontal association and multimodal sensory areas. Both FEF and SEF contain neurons that discharge in relation to eye movements. Microstimulation of the two areas suggests that the FEF encode saccades in a retinotopic manner and that the SEF neurons encode eye movements in head-centered space, but this hypothesis is not borne out convincingly using other techniques such as single-cell recording or lesions. FEF neurons discharge consistently and with short latency to visual stimuli, whereas SEF neurons have multimodal receptive fields, which is consistent with their diverse afferents. The activity of FEF movement-related neurons is consistently and predictably related to the time of saccade initiation, but the activity of SEF neurons is temporally less well coupled and many neurons show activity that precedes movement onset. Furthermore, many SEF neurons is modulated by behavioral context and experience. Reversible and permanent lesion studies have shown that in general, FEF lesions yield more significant and persistent deficits on eye movements than do SEF lesions.

### **Functional analogies to arm movement-related areas in DMFC:**

When considering the contribution of SEF to eye movement generation, it is useful to think of it in terms of adjacent areas involved in aspects of arm movement control, SMA and pre-SMA. Often, analogies can be drawn between observations made in SMA or pre-SMA with regard to arm movement control and those made in SEF with regard to

eye movements. Specifically, there are several similarities in the relationship that each has with other motor areas; SEF to FEF, and SMA to MI.

### **Stimulation:**

Penfield first showed that stimulation of SMA required higher currents to evoke arm movements than in MI, and that the movements tended to be more complex (Penfield & Welch, 1951). This has been borne out by later studies showing slow multijoint movements being evoked from rostral areas compared to fast muscle twitches in MI (Luppino et al., 1990). SEF stimulation can require higher thresholds than FEF stimulation, and the direction of the eye movements evoked are dependent upon the initial position of the eye (e.g. Schlag & Schlag-Rey, 1987; Schall, 1991b; Tehovnik & Lee, 1993), and can reflect an interaction with the voluntary saccade being prepared (Fujii et al., 1995).

### **Single-cell recording:**

A striking similarity between SEF and SMA is the observation that preparatory set neurons, which discharge very early before movement are common in both (e.g., Tanji & Evarts, 1978; Alexander & Crutcher, 1990; Schlag & Schlag-Rey, 1987; Schall, 1991b). Both areas contain neurons that are more responsive when movements are internally generated, as opposed to being reactions to external stimuli (e.g. Okano & Tanji, 1987; Schlag et al., 1997). Neurons have been discovered in both areas whose discharges are modulated by experience. In SEF, neurons show changes during the learning of a conditional association (Chen & Wise, 1995). In SMA and pre-SMA, there



are neurons that discharge during the learning of complex sequences (Nakamura et al., 1998).

**Lesions:**

Lesion studies in monkeys show preliminary evidence, at least, that SEF may be involved in generating sequences of saccades (Schiller & Chou, 1998; Sommer & Tehovnik, 1998). Neurons have been reported in pre-SMA and SMA that are responsive to specific linkages of movement or before particular sequences (Matsuzaka et al., 1985; Mushiake et al., 1990; Tanji & Shima, 1994; Nakamura et al., 1998). Lesions of these areas lead to deficits in the acquisition and the execution of complex sequences of arm movements (Miyashita et al., 1996).

These similarities in function suggest that perhaps the entire dorsomedial frontal cortex participates in movement preparation or acquisition of new movements, and that differences exist only in the effector of the movement. This will be the focus of the study described in the next chapter.

## References:

- Alexander, G.E., & Crutcher, M.D. (1990). Preparation for movement: Neural representations of intended direction in three motor areas of the monkey. *Journal of Neurophysiology*, 64, 133-150.
- Anderson, T.J., Jenkins, I.H., Hawken, M.B., Frackowiak, R.S. & Kennard, C. (1994). Cortical control of saccades and fixation in man: A PET study. *Brain*, 117, 1073-1084.
- Barbas, H. & Pandya, D.N. (1987) Architecture and frontal cortical connections of the premotor cortex (area 6) in the rhesus monkey. *Journal of comparative neurology*, 256, 211-228.
- Bizzi, E (1969). Discharge of frontal eye field neurons during saccadic and following eye movements in unanesthetized monkeys during eye and head movement. *Experimental Brain Research*, 10, 151-158.
- Bizzi, E. & Schiller, P.H. (1970) Single unit activity in the frontal eye fields of unanesthetized monkeys during eye and head movement. *Experimental Brain Research*, 10, 151-158.
- Bon. L & Luchetti, C. (1992) The dorsomedial frontal cortex of the macaca monkey: fixation and saccade-related activity. *Experimental Brain Research*, 89, 571-580.
- Braun, D., Weber, H., Mergner, T. & Schulte-Mönting, J. (1992). Saccadic reaction times in patients with frontal and parietal lesions. *Brain*, 115, 1359-1386.
- Bruce, C.J. & Goldberg, M.E. (1985). Primate frontal eye fields. I. Single neurons discharging before saccades. *Journal of Neurophysiology*, 54,714-734.
- Bruce, C.J., Goldberg, M.E., Bushnell, M.C. & Stanton, G.B. (1985). Primate frontal eye fields. II. Physiological and anatomic correlates of electrically evoked eye movements. *Journal of Neurophysiology*, 54, 714-734.

- Chen, L.L. & Wise, S.P. (1995a) Neuronal activity in the supplementary eye field during acquisition of conditional oculomotor associations. *Journal of Neurophysiology*, 73, 1101-1121.
- Chen, L.L. & Wise, S.P. (1995b) Supplementary eye field contrasted with frontal eye field during acquisition of conditional oculomotor associations. *Journal of Neurophysiology*, 73, 1122-1134.
- Crowne, D.P., Yeo, C.H. & Russell, I.S. (1981). The effects of unilateral frontal eye field lesions in the monkey: visual-motor guidance and avoidance behavior. *Behavioural Brain Research*, 2, 165-187
- Deng, S.-Y., Goldberg, M.E., Segraves, M.A., Ungerleider, L.G. & Mishkin, M. (1986) The effect of unilateral ablation of the frontal eye fields on saccadic performance in the monkey. In: *Adaptive processes in the visual and oculomotor systems*, E.Keller & D.S. Zee (Eds). Oxford, UK: Pergamon, 201-208.
- Dias, E.C., Kiesau, M. & Segraves, M.A. (1995). Acute activation and inactivation of macaque frontal eye field with GABA-related drugs. *Journal of Neurophysiology*, 74, 2744-2748.
- Dick, J.P.R., Benecke, R., Rothwell, J.C., Day, B.L., & Marsden, C.D. (1986) Simple and complex movements in a patient with infarction of the right supplementary motor cortex. *Movement Disorders*, 1, 255-266.
- Doricchi, F., Perani, D., Incoccia, C., Grassi, F., Cappa, S.F., Bettinardi, V., Galati, G., Pizzamiglio, L. & Fazio, F. (1997). Neural control of fast-regular saccades and antisaccade: an investigation using positron emission tomography. *Experimental Brain Research*, 116, 50-62.
- Dum, R.P. & Strick, P.L. (1991). The origin of corticospinal projections from the premotor areas in the frontal lobe. *Journal of Neuroscience*, 11, 667-689.
- Ferrier, D (1875). Experiments on the brain of monkeys. *Proceedings of the Royal Society of London*, 23, 409-432.

- Fox, P.T., Fox, J.M., Raichle, M.E. & Burde, R.M. (1985) The role of cerebral cortex in the generation of voluntary saccades: a positron emission tomographic study. *Journal of Neurophysiology*, 54, 348-369.
- Fries, W. (1984). Cortical projections to the superior colliculus in the macaque monkey: A retrograde study using horseradish peroxidase. *Journal of Comparative Neurology*, 230, 55-76.
- Fujii, N., Mushiake, H., Tamai, M. & Tanji, J. (1995) Microstimulation of the supplementary eye field during saccade preparation. *Neuroreport*, 6, 2565-2568.
- Funahashi, S., Bruce, C.J. & Goldman-Rakic, P.S. (1993). Dorsolateral prefrontal lesions and oculomotor delayed-response performance: evidence for mnemonic "scotomas" *Journal of Neuroscience*, 13, 1479-1497.
- Gaymard, B., Pierrot-Deseilligny, C., & Rivaud, S. (1990) Impairment of Sequences of memory-guided saccades after supplementary motor area lesions. *Annals of Neurology*, 28, 622-626.
- Gaymard, B., Rivaud, S., & Pierrot-Deseilligny, C. (1993) Role of the left and right supplementary motor areas in memory-guided saccade sequences. *Annals of Neurology*, 34, 404-406.
- Goldberg, M.E., Bushnell, M.C., & Bruce, C.J. (1986) The effect of attentive fixation on eye movements evoked by electrical stimulation of the frontal eye fields. *Experimental Brain Research*, 61, 579-584.
- Gottlieb, J.P., MacAvoy, M.G., & Bruce, C.J. (1994). Neural responses related to smooth-pursuit eye movements and their correspondence with electrically-elicited smooth eye movements in the primate frontal eye field. *Journal of Neurophysiology*, 72, 1634-1653.
- Guioton, D., Buchtel, D.A., & Douglas, R.M. (1985) Frontal lobe lesions in man cause difficulties in suppressing reflexive glances and in generating goal-directed saccades. *Experimental Brain Research*, 58, 455-472.

- Hanes, D.P., Patterson, W.F. & Schall, J.D. (1998). Role of frontal eye fields in countermanding saccades: visual, movement, and fixation activity. *Journal of Neurophysiology*, 79,817-834.
- Hanes, D.P., Thompson, K.G. & Schall, J.D. (1995) Relationship of presaccadic activity in frontal eye field and supplementary eye field to saccade initiation in macaque: Poisson spike train analysis. *Experimental Brain Research*, 103, 85-96.
- He, S-Q, Dum, R.P., & Strick, P.L. (1995). Topographic organization of corticospinal projections from the frontal lobe: Motor areas on the medial surface of the hemisphere. *Journal of Neuroscience*, 15, 3284-3306.
- Heinen, S.J. & Liu, M. (1997). Single-neuron activity in the dorsomedial frontal cortex during smooth-pursuit movements to predictable target motion. *Visual Neuroscience*, 14, 853-865
- Heinen, S.J. (1995). Single neuron activity in the dorsomedial frontal cortex during smooth pursuit eye movements. *Experimental Brain Research*, 104, 357-361.
- Huerta, M.F, Krubitzer, L.A. & Kaas, J.H. (1986). Frontal eye field as defined by intracortical microstimulation in squirrel monkeys, owl monkeys and macaque monkeys: I. Subcortical connections. *Journal of Comparative Neurology*, 253,415-439.
- Huerta, M.F. & Kaas, J.H. (1986). Supplementary eye field as defined by intracortical microstimulation. *Journal of Comparative Neurology*, 293,299-330.
- Keating, E.G. (1991). Frontal eye field lesions impair predictive and visually-guided pursuit eye movements. *Experimental Brain Research*, 86, 311-323.
- Keating, E.G. (1993). Lesions of the frontal eye field impair pursuit eye movements but preserve the predictions driving them. *Behavioral Brain Research*, 53, 91-104.
- Keating, E.G., Pierre, A. & Chopra, S. (1996) Ablation of the pursuit area in the frontal cortex of the primate degrades foveal but not optokinetic smooth eye movements. *Journal of Neurophysiology* 76, 637-641.

- Kennard & Ectors (1938) Forced circling in monkeys following lesions of the frontal lobes. *Journal of Neurophysiology*, 1,45-54.
- Latto, R.A. & Cowey, A. ( 1971a). Visual field defects after frontal eye field lesions. *Brain Research*, 30,1-24
- Latto, R.A. & Cowey, A. (1971b) Fixation changes after frontal eye field lesions in monkey. *Brain Research*, 30, 25-36.
- Lee, K-M., & Tehovnik, E.J. (1995). Topographic distribution of fixation-related units in the dorsomedial frontal cortex of the rhesus monkey. *European Journal of Neuroscience*, 7, 1005-1011.
- Leichnetz, G.R., Smith, & Spencer, R.F. (1984a) Cortical projections to the paramedian tegmental and basilar pons in the monkey. *Journal of Comparative Neurology*, 228,388-408.
- Leichnetz, G.R., Spencer, R.F. & Smith, D.J. (1984b) Cortical projections to nuclei adjacent to the oculomotor complex in the medial dien-mesencephalic tegmentum in the monkey. *Journal of Comparative Neurology*, 228,359-387.
- Lucchetti, C., Lui, F. & Bon, L. (1998). Neglect syndromw for aversive stimuli in a macaque monkey with dorsomedial frontal cortex lesion. *Neuropsychologia*, 36, 251-7.
- Luna, B., Thulborn, K.R., Strojwas, M.H., McCurtain, B.J., Berman, R.A., Genovese, C.R. & Sweeney, J.A. (1998). Dorsal cortical regions subserving visually guided saccades in humans: an fMRI study. *Cerebral Cortex*, 8, 40-47.
- Luppino, G., Matelli, M., Camarda, R.M., Gallese, V. & Rizzolatti, G. (1991) Multiple representations of body movements in mesial area 6 and the adjacent cingulate cortex: An intracortical microstimulation study in the macaque. *Journal of Comparative Neurology*, 311, 463-482.
- Lynch, J.C. (1987). Frontal eye field lesions in monkeys disrupt visual pursuit. *Experimental Brain Research*, 68, 437-441.

- MacAvoy, M., Gottlieb, J.P. & Bruce, C.J. (1991). Smooth-pursuit eye movement representation in the primate frontal eye field. *Cerebral Cortex*, 1, 95-102.
- Mann, S.E., Thau, R. & Schiller, P.H. (1988) Conditional task-related responses in monkey dorsomedial frontal cortex. *Experimental Brain Research*, 69, 460-468.
- Matelli, M., Luppino, G. & Rizzolatti, G (1991). Architecture of superior and mesial area 6 and the adjacent cingulate cortex in the macaque monkey. *Journal of Comparative Neurology*, 311,445-462.
- Melamed, E. & Larsen, B. (1979). Cortical activation pattern during saccadic eye movements in humans: Localization by focal cerebral blood flow increases. *Annals of Neurology*, 5, 593-605.
- Miller, E.K., Erickson, C.A., Desimone, R. (1996). Neural mechanisms of visual working memory in prefrontal cortex of the macaque. *Journal of Neuroscience*, 16,5154-5167.
- Mitz, A.R. & Godschalk, M. (1989). Eye-movement representation in the frontal lobe of rhesus monkeys. *Neuroscience Letters*, 106, 157-162.
- Miyashita, K., Sakai, K. & Hikosaka, O. (1996) Effects of SMA and pre-SMA inactivation on learning of sequential movements in monkey. *Society for Neuroscience Abstracts*, 22, 1862.
- Mushiake, H., Inase, M. & Tanji, J. (1990). Selective coding of motor sequence in the supplementary motor area of the monkey cerebral cortex. *Experimental Brain Research*, 82, 208-210.
- Nakamura, K., Sakai, K. & Hikosaka, O. (1998). Neuronal activity in medial frontal cortex during learning of sequential procedures. *Journal of Neurophysiology*, 80,2671-2687.
- O'Driscoll, G.A., Alpert, N.M., Matthyse, S.W., Levy, D.S., Rauch, S.L. & Holzman, P.S. (1995). Functional neuroanatomy of antisaccade eye movements investigated with positron emission tomography. *PNAS*, 92, 925-929.

- Okano, K. & Tanji, J. (1987) Neuronal activities in the primate motor fields of the agranular frontal cortex preceding visually triggered and self-paced movement. *Experimental Brain Research*, 66, 155-166.
- Olson, C.R. & Gettner, S.N. (1995) Object-centered direction selectivity in the macaque supplementary eye field. *Science*, 269, 985-988.
- Orgogozo, J.M., & Larsen, B. (1979). Activation of the supplementary motor area during voluntary movement in man suggests it works as a supramotor area. *Science*, 206, 847-850.
- Parthasarathy, H.B., Schall, J.D. & Graybiel, A.M. (1992). Distributed, but convergent, ordering of corticostriatal projections: Analysis of the frontal eye field and the supplementary eye field in the macaque monkey. *Journal of Neuroscience*, 12, 4468-4488.
- Pattersen, W.F. & Schall, J.D. (1997). Supplementary eye field studied with the countermanding paradigm. *Society for Neuroscience Abstracts*.
- Paus, T. (1996). Location and function of the human frontal eye field: a selective review. *Neuropsychologia*, 34, 475-483.
- Penfield, W. & Welch, (1951). The supplementary motor area of the cerebral cortex: A clinical and experimental study. *Archives of Neurological Psychiatry*, 66, 289-317.
- Petit, L., Clark, V.P., Ingeholm, J. & Haxby, J.V. (1997). Dissociation of saccade-related and pursuit-related activation in human frontal eye fields as revealed by fMRI. *Journal of Neurophysiology*, 77, 3386-3390.
- Petit, L., Orssaud, C., Tzourio, N., Crivello, F., Berthoz, A. & Mazoyer, B. (1996). Functional anatomy of a prelearned sequence of horizontal saccades in humans. *Journal of Neuroscience*, 16,3714-3728.
- Picard, N. & Strick, P.L. (1996). Motor areas of the medial wall: a review of their location and functional activation. *Cerebral Cortex*, 6, 342-353.



- Pierrot-Deseilligny, C., Israël, I., Berthoz, A., Rivaud, S., Gaymard (1993) Role of the difference frontal lobe areas in the control of the horizontal component of memory-guided saccades in man. *Experimental Brain Research*, 83, 607-617.
- Pierrot-Deseilligny, C., Rivaud, S., Gaymard, & Agid, Y. (1991a) Cortical control of memory-guided saccades in man. *Experimental Brain Research*, 83, 607-617.
- Pierrot-Deseilligny, C., Rivaud, S., Gaymard, B., & Agid, Y. (1991b) Cortical Control of Reflexive Visually-Guided Saccades. *Brain*, 114, 1473-1485.
- Rivaud, S., Müri, R.M., Gaymard, B., Vermersch, A.I., Pierrot-Deseilligny, C. (1994). Eye Movement Disorders after Frontal Eye Field Lesions in Humans. *Experimental Brain Research*, 102, 110-120.
- Rizzolatti, G., Matelli, M. & Pavesi, G. (1983). Deficits in attention and movement following the removal of postarcuate (area 6) and pre-arcuate (area 8) cortex in macaque monkeys. *Brain*, 106, 655-673.
- Robinson, D.A. & Fuchs, A.F. (1969) Eye movements evoked by stimulation of frontal eye fields. *Journal of Neurophysiology*, 32, 637-648.
- Roland, P.E. & Zilles, K. (1996). Functions and structures of the motor cortices in humans. *Current Opinion in Neurobiology*, 6, 773-781.
- Russo, G.S. & Bruce, C.J. (1996). Neurons in the supplementary eye field of rhesus monkeys code visual targets and saccadic eye movements in an oculocentric coordinate system. *Journal of Neurophysiology*, 76, 825-848.
- Russo, G.S., & Bruce, C.J. (1993) Effect of eye position with the orbit on electrically elicited saccadic eye movements: A comparison of the macaque monkey's frontal and supplementary eye field. *Journal of Neurophysiology*, 69, 800-818.
- Schall, J.D. (1991a) Neuronal activity related to visually guided saccadic eye movements in the supplementary motor area of rhesus monkeys. *Journal of Neurophysiology*, 66, 530-558.

- Schall, J.D. (1991b) Neuronal activity related to visually guided saccades in the frontal eye fields of rhesus monkeys: Comparison with supplementary eye fields. *Journal of Neurophysiology*, 66:559-579.
- Schall, J.D. (1998) Frontal Visuomotor Areas. In: *Cerebral Cortex, Vol. 12: Extrastriate Cortex of Primates*, K.S. Rockland, A. Peters & J.H. Kaas (Eds). Elsevier, Amsterdam.
- Schall, J.D., Morel, A., & Kaas, J.H. (1993) Topography of supplementary eye field afferents to frontal eye field in macaque: Implications for mapping between saccade coordinate systems.
- Schall, J.D., Morel, A., King, D.J., Bullier, J. (1995) Topography of visual cortical afferents to frontal eye field in macaque: functional convergence and segregation of processing streams. *Journal of Neuroscience*, 15, 4464-4487.
- Schiller, P.H. & Chou, I. (1998) The effects of frontal eye field and dorsomedial frontal cortex lesions on visually guided eye movements. *Nature Neuroscience*, 1,248-253.
- Schiller, P.H. & Chou, I. (1998) The effects of frontal eye field and dorsomedial frontal cortex lesions on visually guided eye movements. *Nature Neuroscience*, 1,248-253.
- Schiller, P.H. & Stryker, M. (1972). Single-unit recording and stimulation in superior colliculus of the alert rhesus monkey. *Journal of Neurophysiology*, 35, 915-924.
- Schiller, P.H., True, S.D. & Conway, J.L. Deficits in eye movements following frontal eye field and superior colliculus ablations. (1980) *Journal of Neurophysiology*, 44, 1175-1189.
- Schlag, J. & Schlag-Rey, M. (1985). Unit activity related to spontaneous saccades in frontal dorsomedial cortex of monkey. *Experimental Brain Research*, 58,208-211.
- Schlag, J. & Schlag-Rey, M. (1990). Colliding saccades may reveal the secrets of their marching orders. *Trends in Neuroscience*, 13,410-415.

- Schlag, J., & Schlag-Rey, M. (1987) Evidence for a supplementary eye field. *Journal of Neurophysiology*, 57, 179-200.
- Schlag-Rey, M., Amador, N., Sanchez, H. & Schlag, J. (1997). Antisaccade performance predicted by neuronal activity in the supplementary eye field. *Nature*, 390, 398-400.
- Schlag-Rey, M., Schlag, J. & Dassonville, P. (1992). How the frontal eye field can impose a saccade goal on superior colliculus neurons. *Journal of Neurophysiology*, 67, 1003-1005.
- Schultz, W. (1998). Predictive reward signal of dopamine neurons. *Journal of Neurophysiology*, 80, 1-27.
- Segraves, M.A. & Goldberg, M.E. (1987). Functional properties of corticotectal fields. *Journal of Neurophysiology*, 58, 1387-1419.
- Segraves, M.A. & Park, K (1993). The relationship of monkey frontal eye field activity to saccade dynamics. *Journal of Neurophysiology*, 69, 1880-1889.
- Segraves, M.A. (1992). Activity of monkey frontal eye field neurons projecting to oculomotor regions of the pons. *Journal of Neurophysiology*, 68, 1967-1985.
- Shi, D., Friedman, H.R. & Bruce, C.J. (1998). Deficits in Smooth-pursuit eye movements after muscimol inactivation within the primate's frontal eye field. *Journal of Neurophysiology*, 80, 458-464.
- Shook, B.L., Schlag-Rey, M. & Schlag, J. (1990). Primate supplementary eye field I. Comparative aspects of mesencephalic and pontine connections. *Journal of Comparative Neurology*, 301, 618-642..
- Shook, B.L., Schlag-Rey, M. & Schlag, J. (1991). Primate supplementary eye field II. Comparative aspects of connections with the thalamus, corpus striatum and related forebrain nuclei. *Journal of Comparative Neurology*, 307, 562-583.
- Shook, B.L., Schlag-Rey, M. & Schlag, J. (1988). Direct projection from the supplementary eye field to the nucleus raphe interpositus. *Experimental Brain Research*, 73,215-218.

- Sommer, M.A. & Tehovnik, E.J. (1997). Reversible inactivation of macaque frontal eye field. *Experimental Brain Research*, 116, 229-249.
- Sommer, M.A. & Tehovnik, E.J. (1998). Reversible inactivation of macaque dorsomedial frontal cortex. *Experimental Brain Research*, in press.
- Sommer, M.A. & Wurtz, R.H. (1998). Frontal eye field neurons orthodromically activated from the superior colliculus. *Journal of Neurophysiology*, 80, 3331-3333.
- Sparks, D.L. & Mays, L.E. (1983). Spatial localization of saccade targets. I. Compensation for stimulation-induced perturbations in eye position. *Journal of Neurophysiology*, 49, 45-63.
- Spinelli, D., Burr, D.C. & Morrone, C. (1994). Spatial neglect is associated with increased latencies of visual evoked potentials. *Visual Neuroscience*, 11, 909-918.
- Spinelli, D., Burr, D.C. & Morrone, C. (1994). Spatial neglect is associated with increased latencies of visual evoked potentials. *Visual Neuroscience*, 11, 909-918.
- Stanton, G.B., Goldberg, M.E. & Bruce, C.J. (1988a) Frontal eye field efferents in the macaque monkey: I. Subcortical pathways and topography of striatal and thalamic terminal fields. *Journal of Comparative Neurology*, 271,473-492.
- Stanton, G.B., Goldberg, M.E. & Bruce, C.J. (1988b). Frontal eye field efferents in the macaque monkey: II. Topography of terminal fields in midbrain and pons. *Journal of Comparative Neurology*, 282, 415-427.
- Sweeney, J.A., Mintun, M.A., Kwee, S., Wiseman, M.B., Brown, D.L., Rosenberg, D.R., & Carl, J.R. (1996). Positron emission tomography study of voluntary saccadic eye movements and spatial working memory. *Journal of Neurophysiology*, 75, 454-468.
- Tanji, J. & Shima, K.(1994). Role for supplementary motor area cells in planning several movements ahead. *Nature*, 371b, 413-416.
- Tanji, J., Okano, K. & Sato, K.C. (1988) Neuronal activity in cortical motor areas related to ipsilateral, contralateral and bilateral digit movements of the monkey. *Journal of Neurophysiology*, 60, 325-343.

- Tehovnik, E.J. & Lee, K-M. (1993) The dorsomedial frontal cortex of the rhesus monkey: topographic representation of saccades evoked by electrical stimulation. *Experimental Brain Research*, 96, 430-442.
- Tehovnik, E.J. & Sommer, M.A. (1997). Electrically evoked saccades from the dorsomedial frontal cortex and frontal eye fields: a parametric evaluation reveals differences between areas, *Experimental Brain Research*, 117, 368-378.
- Tehovnik, E.J., Lee, K-M. & Schiller, P.H. (1994). Stimulation-evoked saccades from the dorsomedial frontal cortex of the rhesus monkey following lesions of the frontal eye fields and superior colliculus. *Experimental Brain Research*, 98, 179-190.
- Tehovnik, E.J., Slocum, W.M., & Schiller, P.H. (1998). Behavioral conditions affect saccadic eye movements elicited electrically from the dorsomedial frontal cortex. *Society for Neuroscience Abstracts*.
- Tian, J.R. & Lynch, J.C. (1996). Functionally defined smooth and saccadic eye movement subregions in the frontal eye field of Cebus monkeys. *Journal of Neurophysiology*, 76, 2740-53.
- Van der Steen, J., Russell, I.S., & James, G.O. (1986). Effects of Unilateral Frontal Eye Field Lesions on Eye-Head Coordination in Monkey. *Journal of Neurophysiology*, 55, 696-714.
- Welch, K. & Stuteville, P. (1958). Experimental production of unilateral neglect in monkeys, *Brain*, 81, 341-347.
- Williams, S.M. & Goldman-Rakic, P.S. (1993). Characterization of the dopaminergic innervation of the primate frontal cortex using a dopamine-specific antibody. *Cerebral Cortex*, 3, 199-222.

**Table 1: Nomenclature for divisions of frontal motor cortex**

<b>Functional term</b>	<b>Matelli et al., 1991</b>	<b>Brodman</b>	<b>Vogt &amp; Vogt(1919)</b>
Primary motor cortex (MI)	F1	4	4a, 4b
Dorsal pre-motor area (PMd)	F2	6	6a $\alpha$
Ventral pre-motor area (PMv)	F4 & F5	"	4c
Pre-supplementary motor area (pre-SMA)	F6	"	6a $\beta$
Supplementary motor area (SMA)	F3	"	6a $\alpha$
Supplementary eye fields (SEF)	F7	"	6a $\beta$

**Table 2: Percentages of cell types in FEF & SEF**

<b>Cell class</b>	<b>FEF</b>	<b>SEF</b>
Sensory	17%	16%
Sensory Movement	41%	28%
Pre-saccadic	22%	17%
Post-saccadic	13%	2%
Eye position	0	<1%
Preparatory set	5%	12%
Forelimb	0	7%
Other	6%	18%

from Schall, (1991a,1991b)

Figure 1

A



Woolsey 1958

B

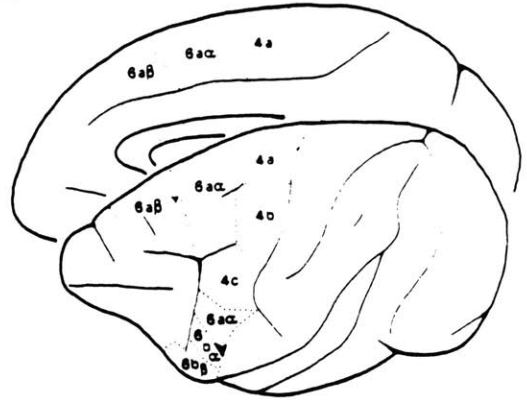

Vogt & Vogt 1919

C

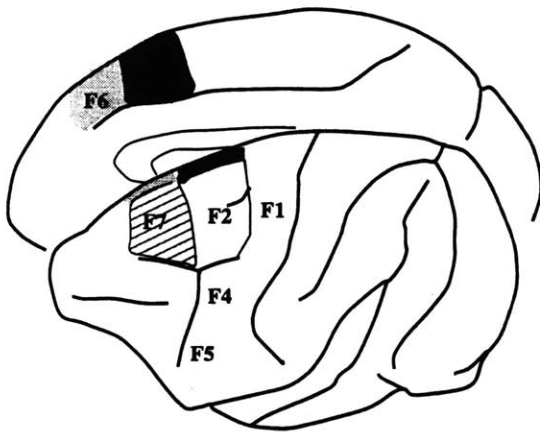

Matelli, Luppino & Rizzolatti, 1991

D

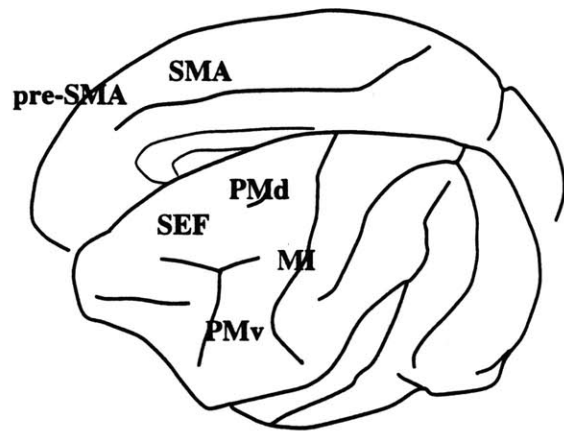
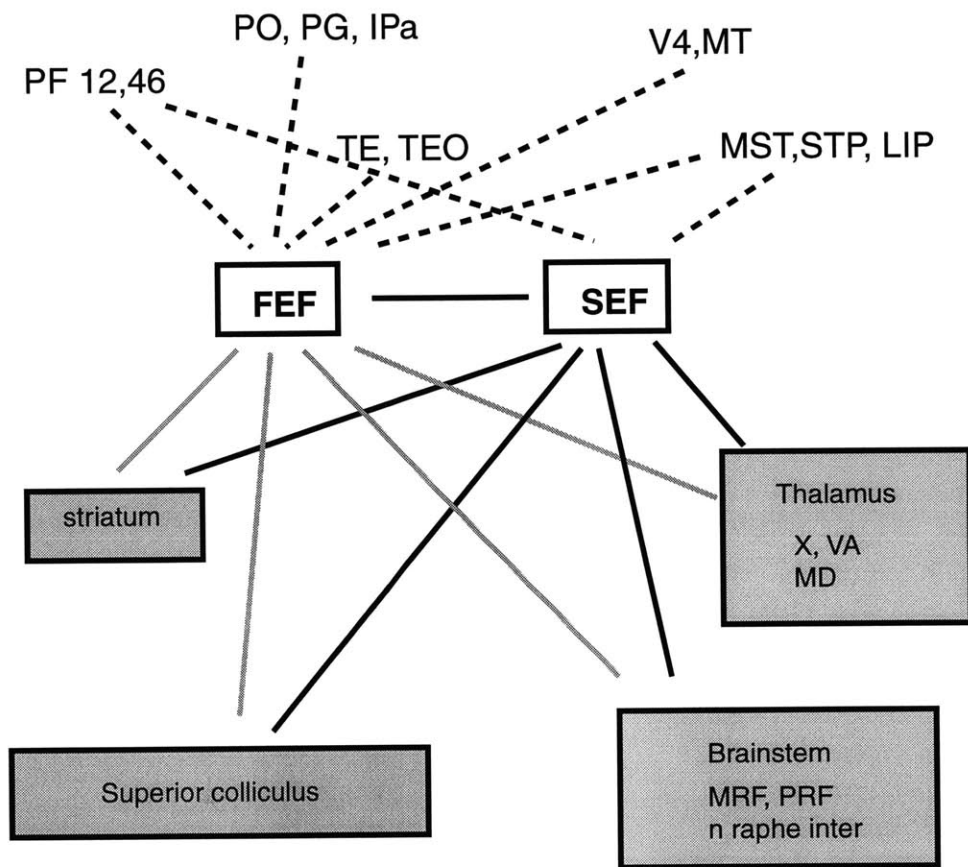



Figure 2



## **Chapter 2: Single-cell responses to eye and arm movements in the dorsomedial frontal cortex**

### **Introduction:**

In the previous chapter, the relative roles of SEF and FEF in eye movement generation were discussed. It seems clear that FEF is more intimately involved in specifying the parameters of eye movements than is SEF, and that SEF plays a more modulatory role in eye movement generation. Although the role of SEF is still unclear, the relationship between SEF and FEF is similar to the relationship between SMA and MI, particularly with respect to the temporal relationship between neural activity and movement onset. In this chapter, I explore the similarities between SEF and the adjacent areas in dorsomedial frontal cortex and explore their relative roles in the control of both eye and arm movements.

The dorsomedial frontal cortex is thought to be made up of multiple anatomically and cytoarchitecturally distinct areas (Dum & Strick, 1992; He, Dum & Strick, 1995; Luppino et al., 1990; Matelli et al., 1990). The SEF lie within area F7, according to the scheme of Rizzolatti and colleagues. It is traditionally considered to be involved primarily in eye movement control, whereas the areas rostral and lateral to pre-SMA (F6) and SMA (F3) are thought to be involved in certain aspects of skeleto-motor movement. However, the functional boundaries of SEF are somewhat ambiguous. Anatomically, only a restricted region of F7 projects to FEF and within this region, eye movements can be evoked from an anesthetized animal with low currents (Huerta & Kaas, 1990). Schlag & Schlag-Rey, (1987) defined SEF as that area of cortex from which eye movements can

be evoked at low threshold ( $<50\mu\text{A}$ ) in an awake, behaving animal. However, there is some variability between research groups with regard to the extent of the area from which eye movements, and neurons responsive to eye movements are recorded from an even greater area (see Tehovnik, 1995 for a review). Potential sources for this variability may be differences between animals, the different stimulation parameters chosen, or the experimental paradigms employed.

The functional boundary between adjacent pre-SMA and SMA is also unclear. Both contain neurons responsive to arm, in particular to the learning and generation of arm movement sequences (e.g. Tanji & Shima, 1994; Mushiake et al., 1990; Nakamura et al., 1998). It has been proposed that pre-SMA is more involved in the acquisition of sequences and SMA more involved in the execution (Nakamura et al., 1996). This is based on differences in frequency of a certain cell type or type of response along a continuum, as opposed to discrete functional distinctions.

Another source of ambiguity in determining the functional boundaries between eye and arm movement areas lies in the type of task typically employed. Studies that have reported only arm-movement responses observed in SMA or pre-motor cortex generally use tasks where the reaching is visually guided. Thus saccades are always being made in conjunction with the arm movements; any saccade related neural activity may have been inappropriately attributed to arm movement control. Similarly, few studies have tested SEF for arm movement responses. Of the few exceptions, two studies did report arm movement responses (Mann et al., 1988; Schall, 1991), and another reported that neurons in SEF discharge before saccades, but only when the saccades

precede arm movements (Mushiake et al., 1996). Therefore the question remains as to whether eye movement responses do exist outside of SEF but have been attributed to arm movements, and whether neurons in SEF are involved in arm movement control, but have been overlooked. Also, the eye and arm movement areas are interconnected (Huerta & Kaas, 1990); these connections may have functional consequences.

The first goal of this experiment was to characterize the eye and arm movement-related responses of neurons in a large region of dorsomedial frontal cortex to determine the functional boundary between eye and arm movement areas. A task was used that would dissociate arm and eye movement-related responses. The goal was to determine whether there is a strict segregation into an eye or an arm field, as is suggested by the anatomy, or if single neurons can encode both eye and arm movements. The second goal of this experiment was to determine the nature of directional tuning of the neurons.

Visually guided reaching is a sequence of coupled movements: first a saccade is made in order to foveate the target of the reach, and then the arm movement is made towards the target. How this precise temporal coupling between eye and arm movements is achieved by is unknown. There are two possible schema: either the two movements are planned and generated separately, or alternately, the coordinated movement is generated by a common control mechanism. Psychophysical studies in humans suggest that the latter may be the case. Biguer & colleagues examined the onset of EMG activity in the eyes, neck and shoulder when subjects made visually guided reaches. In this case, subjects first shifted gaze with a coordinated eye and head movement, and then reached to point to a target. As the direction or amplitude of the reach were varied, the latencies of the eye, neck and arm muscle onset covaried such that the differences between the

three latencies remained constant (Biguer et al., 1982). This lack of variability in relative latency suggests that the three movements are planned together, and are initiated with one single trigger signal as opposed to three separate ones. If a joint gaze-shift and arm movement is encoded by a single neuron, then one should expect similar directional tuning for both eye and arm movements.

## **Methods:**

### **Subjects and surgery**

Two adult rhesus monkeys (*Macaca mulatta*), weighing approximately 12 kg each served as subjects in this study. Each animal was habituated to sitting quietly in a primate chair, facing a black panel upon which 25 equally-spaced buttons were mounted. Each button was 2.5 cm in radius and the buttons were mounted with their center of each one mounted 6 cm (12.5 degrees visual angle) away from its neighbors. The board was placed 28cm away from the monkey. The central portion of each of the buttons could be illuminated by a tri-color LED and the buttons themselves could also be depressed. The monkeys were first trained to press the buttons when they were illuminated, and were rewarded with drops of apple juice. On days when the animals were being trained, they were deprived of water until after they had completed their training, upon which they were allowed to drink to satiation. On any given day, the monkeys were given at least the amount of fluid that they consumed per day on average ad libitum. Monkeys had free access to food in the vivarium at all times. After the monkeys were accustomed to the bask task, surgery was performed to implant a head restraint and an eye coil. To restrain the head, stainless steel straps were shaped to the skull and attached using stainless steel screws (Synthes). Dental cement was placed around the junction of the straps and a head bolt designed to fit into a matching restraint on the primate chair was cemented in place. An eye coil made teflon-coated platinum wire was implanted underneath the conjunctiva to monitor eye movements (Robinson, 1963; Judge, 1980).

After the animals were fully recovered from surgery, they received further training until they were proficient at performing the tasks described below. At this point, another surgical procedure was performed to prepare the animals for chronic recording. Circular craniotomies were made over the midline to expose dorsomedial frontal cortex, and a cylindrical recording chamber was attached to the skull with screws and dental cement. In one animal, the craniotomy was placed at stereotaxic coordinates 27.5mm AP, which corresponds to published locations of the SEF (e.g., Sommer & Tehovnik, 1998). However, this proved to be too far posterior for this monkey, based on recording and stimulation mapping. The recording chamber was removed and the craniotomy partially closed with gelfoam and a silicone sheet. The anterior portion of craniotomy was enlarged such that it allowed placement of a new well centered at 35mm AP. The well was centered in the second monkey at 32mm AP.

All surgery was performed under sterile conditions under nembutal anesthesia with ketamine hydrochloride used for induction. The monkeys were given antibiotics to prevent infection and analgesics (buprenex hydrochloride) to minimize post-surgical pain. All surgical and experimental protocols conformed with MIT and NIH guidelines for animal care.

**Task:**

The monkeys initiated each trial by pressing a lever mounted to the front of their chair. Following this, one of the buttons was illuminated to indicate that it was the fixation target. The color of the LED within the button instructed the monkeys as to which of three possible task conditions the monkey was to perform. The task conditions are depicted in Figure 1.

If the fixation LED was red, the monkey had to both fixate the fixation target and depress the button. After the monkey had maintained fixation for a certain period of time (on some days this was fixed at 300 msec, on others it could vary from 200-500 msec) another button was illuminated in the periphery, also in red. The monkey had to maintain fixation on the first LED, but reach to depress the peripheral target button (Figure 1 top row). This task condition was termed the "Reach Only" condition.

When the fixation target LED was illuminated green, the monkey had to maintain his hand on the start lever, and fixate the LED with his eyes throughout the fixation period. A green peripheral target LED was then illuminated and the monkey had to make a saccade to it, while keeping the start lever depressed throughout the duration of the trial. This was termed the "Saccade Only" condition (Figure 1 middle row).

When the fixation target was yellow, the monkey had to both fixate and depress the fixation target button throughout the fixation period, similar to the Reach Only condition. However, when a yellow peripheral target LED was illuminated, the monkey had to both make a saccade and reach to the button. This condition was termed the "Reach and Saccade" condition (Figure 1 bottom row).

Insert Figure 1 about here

Only Monkey J was able to be trained to perform all three task conditions intermixed within a block of trials (Figure 2). Data was collected from Monkey P on two of the task conditions: Saccade Only and Reach and Saccade. In a given block of trials, one button was used as the fixation target, and the four buttons arranged in a square around it were used as the targets. Within a block, task condition and direction of movement was



pseudo-randomly determined. In some cases, all eight buttons surrounding the fixation button were used as the targets to probe the directional tuning properties of the neurons in greater detail. Monkeys generally performed 600-1200 trials per day.

Insert Figure 2 about here

### **Recording and Data analysis details**

Single cell recordings were made by introducing glass-coated, platinum-iridium electrodes (0.5-2 M $\Omega$  impedance measured at 1kHz) through the dura. The potentials from single neurons were amplified (Bak electronics), passed through a bandpass filter (Krohnkite). Neurons with task-related activity were targeted by having the monkey perform the task, and changes in activity during the trial were identified by ear. The potentials from single neurons were then isolated with a window discriminator (Bak) and isolation was confirmed by playing back the waveform on an oscilloscope.

Once a task-related neuron was isolated, the monkey ran the task until there were at least 8 trials per condition in each direction of movement. After the monkey had run the task as described above, the neurons were tested for sensory responses if isolation was still acceptable. Neurons were tested for visual responses, by having the animal fixate steadily while spots of light were flashed or moved in the periphery with a laser pointer. Neurons were also tested for somatosensory responses by touching or stroking the face and arms with a cotton swab.

Stimuli were presented and trial sequences were controlled by a PDP-11 and PC-based computer system. Spike times, eye movements and button presses, and other trial events were collected and stored on the PDP and analyzed off-line.

### **Off-line analysis of behavioral and neural events.**

Start and end times of saccades were determined off-line by detecting when the velocity of the first eye movement made after target presentation crossed a 50 degree/sec threshold. Start and end times of arm movements were determined by the times of button releases or presses, respectively.

Neurons were considered task-related if they showed significantly different changes in firing during any 500 msec period of the trial than the average firing rate during a 500 msec intertrial period. Sign tests ( $p < 0.05$ ) comparing the firing during intertrial to firing during the trial determined whether a neuron showed task-related activity. To be considered movement-related, the neurons had to meet an additional criterion. The maximum rate of neural activity had to occur between the start of fixation and acquisition of the target. Once a neuron had been identified as being movement-related in at least one task condition, two way analysis of variance was performed to investigate the effects of task condition and of direction of movement. Post-hoc paired comparisons (Mann-Whitney) were used to identify which, if any, was the optimal task condition or preferred direction of the neuron.

The time of onset of neural activity was calculated by determining for each trial the time at which the firing rate rose above the average firing rate during the intertrial period. To do so, the firing rate over a 500 msec period during intertrial was averaged over all trials. On every trial, instantaneous firing rate was calculated for each individual spike by averaging the inverses of the interspike intervals immediately preceding and

following that spike. Neural onset in each trial was taken to be the time at which the instantaneous rate rose higher than 2 standard deviations above the mean rate during intertrial. The time of maximal neural activity in each trial was determined by the time at which the maximum instantaneous firing rate occurred. For displaying neural activity, histograms were generated with a binwidth of 20 msec and in some cases, spike density functions were generated by convolving the histograms with a gaussian function,  $\sigma=10$  msec. Following completion of recording, the dorsomedial frontal cortex of Monkey J was mapped using microstimulation, to place the recording locations with respect to the somatotopic map revealed by stimulation. Details of the mapping are presented in the appendix.

## Results

A total of 460 neurons were isolated in both hemispheres in Monkey J and the right hemisphere of Monkey P. Of these 460 neurons, 120 were identified as having task-related activity and were tested in the three task conditions. Of these 120 neurons, 61 showed significant changes in activity that occurred during the movement period (sign test,  $p < 0.01$ ), furthermore, maximal neural activity occurred between acquisition of fixation and end of the movement. These movement-related neurons fell into three major categories:

### Reach or Saccade Neurons

The first and largest class of neurons discharged for either eye or arm movements. Figure 3 shows an example of such a neuron, which comprised 61% (N=37) of all movement-related neurons. The neurons discharged regardless of whether the movement made to acquire the target was made with the eyes or arm and discharged in all three task conditions. Many of these neurons showed no significant differences in peak firing rate across the three conditions, showing similar levels of activity for eye and/or arm movements, as in the neuron shown in Figure 3.

Insert Figure 3 about here

For each Reach or Saccade neuron, a modulation index was calculated to quantify the relative level of activity in response to eye and arm movements. The modulation index was defined as the difference between mean firing rate in the Saccade Only and Reach Only conditions divided by the sum of the mean firing rate in the two conditions

$(MF_{sac} - MF_{rea}) / (MF_{sac} + MF_{rea})$ . A modulation index of 0 signifies equal mean firing rate in the two conditions, whereas an index of 0.5 or -0.5 signifies three times greater firing in one condition than the other. Figure 4 shows the distribution of modulation ratios for all Reach or Saccade neurons. Most neurons did show almost equal levels of peak activity in the Saccade Only and Reach Only conditions, as shown by the predominance of neurons that had ratios close to 0 and all had indices of less than 0.5. The distribution of modulation indices was not significantly different than a normal distribution centered around 0 with a standard deviation of 0.17 (Kolmogorov-Smirnov,  $p=0.294$ ).

Insert Figure 4 about here

These Reach or Saccade neurons were subjected to further analysis to determine whether the activity in the Reach & Saccade condition was better aligned to reach or saccade. If the activity of a neuron were related to one of the movements, it should be expected that there would be a consistent relationship between the time that the neural activity reached a certain threshold and the time of the movement initiation (Hanes & Schall, 1996). There were not enough trials in this experiment to determine the trigger threshold. However, if the rate of activity were related to one movement and not the other, there should also be a smaller variance in the time that peak neural activity occurred relative to that movement. The variances in neural peak activity time were compared by first aligning neural activity to the saccade onset and then the reach onset (determined by when the monkey released the fixation button). For both sets of aligned

spikes, the time of peak neural activity relative to the time of movement onset was determined for each trial. The variance in the time of peak neural activity was calculated for both cases, and the F-test performed to compare the variances. This analysis revealed that for 34/37 (92%) of the Reach or Saccade neurons, there was no significant difference in variance of peak neural activity time relative to saccade or reach onset (F-test,  $p > 0.05$ ). Of the 3 neurons that did show significant differences in variance, all had greater variance when the spikes were aligned to reach onset ( $F_{(30,30)} > 1.84$ ,  $p < 0.05$ ).

### **Reach Only Neurons**

A second class of neurons discharged exclusively in response to arm movements. These neurons constituted 28% of movement-related neurons ( $N=17$ ). An example of the second class of neuron is shown in Figure 5. These neurons showed no significant discharge before or during the execution of the saccade to the target, as can be seen by the lack of activity in the middle panel, whereas they discharged for arm movements both those made with and without saccades (top and bottom panel). Sometimes, as in the one shown in Figure 5, these neurons discharged not only for the reaching movement to the target, but also for the reach to acquire the fixation button, or to the lever press that initiated the trial. 5 of these neurons were tested for sensory responses and it was found that none had visual responses, but 3 of them responded to cutaneous stimulation. However, it was difficult to determine whether these were true somatosensory responses as the monkey invariably reacted by moving in response to the stimulus.

Insert Figure 5 about here

### **Saccade Only neurons**

The third class of neurons responded only to eye movements, and not to arm movements. These neurons constituted 11% (N=7) of the movement-related neurons. An example of such a neuron is shown in Figure 6. These neurons discharged only in the Saccade Only condition. The particular neuron shown in this figure did not discharge during when an arm movement was made, neither when accompanied by a saccade (bottom panel) nor in absence of an accompanying saccade (top panel).

Insert Figure 6 about here

These neurons seemed to discharge only for task-related saccades, as they did not discharge in response to the voluntary saccade made at the end of the Reach Only trials after the monkey had been rewarded. Figure 7 shows the activity of one of these neurons where the activity is aligned to the task-related saccades versus when it is related to the spontaneous saccade made at the end of the trial.

Insert Figure 7 about here

To summarize, Reach or Saccade neurons constituted 37/61 (60%) of the movement-related neurons observed, Saccade only neurons 7/61 17% and Reach Only

neurons 17/61 32%. Figure 8 shows the relative frequency of the different classes of neurons and their relative frequency with respect to all neurons encountered.

Insert Figure 8 about here

### **Neural activity in combined reach and saccade condition compared to reach only or saccade only:**

For all neurons, the effects on neural activity of combining reach and saccades relative to making the movements in isolation were considered. Figure 9 shows the mean firing in the condition when isolated arm or eye movements were made relative to when the combined movement was made. On the ordinate, the mean firing rates during the reach and saccade condition were plotted. For the reach or saccade neurons, the mean firing rates in the reach only task were plotted on the abscissa. For the reach only and saccade only neurons, the abscissa represented the mean firing rates during the reach only and saccade only conditions, respectively. Most Reach or Saccade neurons had similar mean firing rates in the single and combined conditions, as can be seen by the fact that most points fall close to the equality line. On the other hand, the majority of Saccade Only neurons had lower levels of firing when the saccade was combined with a reach, whereas most Reach Only neurons had higher levels of firing when the reach was combined with a saccade than when the reach was performed in isolation. However, these differences were not significant across the population (Wilcoxon signed rank,  $p > 0.05$ ).



## **Directional Tuning:**

For all neurons, two way analysis of variance was performed on the mean firing rates during the movement period to investigate the effects of task condition and movement direction on neural activity. 25/61 (41%) of neurons showed significant effects of movement direction when activity throughout the entire movement period was considered. However, this often included activity that occurred before target presentation. Many of the neurons had high levels of activity before the target presentation, which will be discussed in the next section. Directional tuning was recalculated by considering the neural activity that occurred between 40 msec after target onset (so as to take into account the visual latency of the neurons) and the end of the movement (either the end of the saccade or the time of the target button press). One way analysis of variance (Kruskall-Wallis) was used to compare the activity of the neurons when movements were made in different directions. Using this more restricted window of time, 33/61 (54%) of the neurons showed directional tuning in at least one task condition when tested in 4 directions of movement. In addition, 8 of the neurons were tested on 8 directions: analyzing tuning with additional directions did not change the outcome of analysis of variance.

When each class of neurons was considered individually, it was found that 54% of Reach or Saccade neurons, 47% of Reach Only and 57% of Saccade Only neurons were directionally tuned. Some of the Reach or Saccade neurons were tuned for one movement effector but not the other. For those Reach or Saccade neurons that did show directional tuning for both eye and arm movements, the preferred direction for eye and arm movements were compared. 7/9 of them had the same preferred direction for both eye and arm movements. An example of such a neuron is shown in Figure 10. The polar plots in the left hand column shows the mean activity for movements in different directions. In the right hand column, the spike density functions for trials with movements made to the best and worst directions are superimposed on each other. This neuron shows directional tuning after the target is presented, but also shows a robust pre-target discharge.

Insert Figure 10 about here

## Neural Onset time

The preponderance of untuned neurons was partially explained by the time in the trial that these neurons discharged. Many neurons corresponded to the “preparatory set” neurons reported by Schall, 1991a; Hanes et al., 1995, beginning to discharge during the wait period (in this case, the fixation period) and increasing in activity until the movement was initiated. In this study, many of the neurons began to discharge as soon as the monkey had attained fixation or depressed the fixation button. The neurons increased their activity steadily throughout the fixation period while the monkey was waiting for the target to appear, and clipped as soon as the movement was initiated. This pattern of activity could be considered consistent with a fixation cell, which have been reported before in SEF (e.g. Lee & Tehovnik, 1995), or a neuron with a foveal visual receptive field. However, Reach or Saccade neurons showed a similar temporal profile of activity in all three task conditions. Figure 11 shows a Reach or Saccade neuron, with the spike density functions from all three task conditions superimposed on each other in each panel. Thus no matter what the effector of the movement, the neuron still began building up as soon as the monkey was waiting for the target to appear, peaked around the time of target onset, and declined on movement onset. In the three task conditions, the movements made differ – in the Reach Only condition, the animal continues fixating while the arm reaches to the target, whereas in the Saccade Only and Reach & Saccade conditions, the eyes leave the fixation button. This pattern of activity is neither consistent with a purely visual response nor a fixation response is best explained as being related to the movement, regardless of the effector or direction of the movement.

Insert Figure 11 about here

Figure 12 shows the distribution of neural onset times (determined by averaging over trials the time at which neural activity rose higher than 2 standard deviations above baseline firing, determined by the average firing rate in intertrial) for the different classes of neurons. The distribution is bimodal, with the majority of neurons begin discharging as early as 500 msec before target presentation, and the others discharging after target presentation. There was no difference in frequency of directionally tuned neurons the two modes of the distribution. In some cases, the neurons seemed to show multiple phases of activity, building up their activity before target onset and then showing a tuned movement burst, such as the neuron shown in Figure 10.

Insert Figure 12 about here

### **Other neurons:**

59 neurons exhibiting other types of task-related activity were also encountered in the penetrations. These included neurons which discharged only in response to the conjoint Reach and Saccade condition (N=2). Neurons that discharged in when the reward was delivered were also observed (N=3). These neurons discharged at the end of the trial when the monkey was rewarded, but not when the monkey was arbitrarily delivered a drop of juice, and therefore were not related to mouth movements or swallowing. Other neurons were related to the lever press, or to the saccade that brought the eyes to the fixation LED. Some neurons had a high discharge during intertrial, but

paused throughout the trial, or had higher activity throughout the trial that could not be characterized to any particular trial event.

### **Location of neurons:**

Comparing the location of the recording penetrations to the stimulation maps, it appears in one monkey at least, as though most of the task-related neurons were located within the eye movement representation of dorsomedial frontal cortex (see Appendix for stimulation map). Most neurons were recorded in the same region of cortex from which eye movements were elicited with microstimulation. Few task-related neurons were observed caudal to the eye movement representation. The top panel of Figure 13 shows the location of the movement-related neurons in one hemisphere of Monkey J. The bottom panel shows the locations of recording penetrations (filled symbols) as well as the locations from which eye, head or arm movements were elicited by microstimulation (open symbols) (see Figure 2 of appendix for the map of stimulation penetrations alone). Most of the filled symbols fell within the region from which saccadic eye movements could be elicited. There was no obvious clustering in the distribution of the different classes of neurons and there was no correlation between neuronal preference (modulation index shown in Figure 4) and rostro-caudal location (Pearson product correlation  $R=-0.05$ ,  $p=0.45$ ). If the neurons were segregated into a distinct eye and arm subregion it might be expected that there would be a relationship between eye or arm preference and location. There was a weak correlation between time of neural onset and rostro-caudal location; neurons which discharged earlier tended to be located more

rostrally than those which began discharging later, however, this effect was also not statistically significant (Pearson product  $R=-0.27$ ,  $p=0.12$ ).

Insert Figure 13 about here

## **Discussion:**

### **Summary of findings:**

- 1). About one quarter of all neurons encountered had task-related responses and of these about one half showed activity during the movement phase of the task. Of these neurons, 60% were responsive to either eye or arm movements, 39% to arm movements only and 17% to eye movements only. Those neurons that discharged for either eye or arm movements tended to discharge equally to either.
- 2). Most of the movement-related neurons, regardless of their effector preference were not directionally tuned. Thus in the limited number of neurons for which directional tuning was observed for both eye and arm, they did coincide. This would be consistent with this area playing a role in specifying a general direction, or goal for both eye and arm movements. However, the sparseness of directionally tuned neurons and the weak degree of tuning observed suggest that this may not be the key characteristic of this area.
- 3). The low percentage of directionally tuned neurons was partially explained by the preponderance of neurons that discharged well before target onset, sometimes ending their discharge before the movement began.
- 4). Most of the task related neurons were observed in the low-threshold eye movement representation, and there was no discernible clustering of neurons in terms of their preference for eye or arm movements.

Thus, neurons in this area tended to discharge early with respect to the target onset, before the direction of movement is specified and many discharge regardless of the effector of the upcoming movement. This would suggest that the neurons in this area

provide a generalized movement preparation signal, or anticipatory discharge to the target that will guide both eye and arm movements. Pre-movement activity has been demonstrated using single cell recording in monkey before both eye movements (Schlag & Schlag-Rey, 1987; Schall, 1991) as well as before arm movements (e.g. Tanji & Evarts, 1978). In this experiment, it was shown that the pre-movement activity could precede movements of either the eyes or the arm.

There are possible reasons the activity is not related to eye and arm movements: the preparatory activity is covert preparatory activity for the saccade that is made eventually at the end of the trial. This has been proposed to explain delay-period activity seen in LIP during a similar task. However, the activity of Reach or Saccade neurons is generally well-aligned to execution of the arm movement, despite the fact that the eyes are immobile. Also, the monkey generally did not make saccades to the target immediately after the reward was delivered; generally he maintained fixation at least 200 msec after the fixation LED was extinguished at the end of the trial, and then made a large amplitude saccade away from the workspace.

Another possible explanation for the activity seen before both eye and arm movement is that it is related to activity of some other muscle, that is active during both eye and arm movements, perhaps in the back or neck. While this cannot be ruled out, it is difficult to conceive of a muscle that is activated equally by a reach and a saccadic eye movement.

### **Comparison to neurons reported in other studies of SEF.**

The frequency of neurons that showed saccade-related responses observed in this experiment (which both includes Saccade only and Reach or Saccade neurons) is consistent with previous studies (e.g., Schall, 1991a). The frequency of neurons with early discharge is also consistent with previous studies (e.g. Schlag & Schlag-Rey, 1987; Schall, 1991). A lower percentage of tuned neurons was observed in this experiment compared to other studies such as Schlag & Schlag-Rey, 1987; Schall, 1991. This is partially explained by the preponderance of neurons that discharge before target onset observed in this study. There are also other reasons why strong tuning was not observed. It has been shown that directional tuning can change, or neural responses may not be obviously apparent until there is some meaningful conditional association between stimulus and response (Chen & Wise, 1995). Olson & Gettner, 1995 suggested that SEF neurons encode eye movements with object-centered tuning. If this is correct, it is likely that movements made to the center of a button might not be the optimal movement for these neurons. Only a restricted part of the workspace was tested, given the constraint of tested neurons on the different task conditions, and given the constraint of working with fixed buttons that were placed at arm's reach. The possibility exists that we did not test the amplitude of eye movements, or correct part of the workspace for finding preferred eye movement or eye position. With respect to arm movements, the possibility also exists that the right part of the workspace for uncovering the directional tuning was not tested, or that the arm movements were not varied in the right plane of motion.

Nonetheless, even those neurons that did show tuned activity often also displayed a pre-movement buildup, such as the neuron shown in Figure 10. If this buildup is in fact



a preparation to move, or anticipation of the target being presented, it may only occur in situations where the monkey can predict the time of occurrence of the target, or movement. In the next chapter I explore the ways in which the pre-movement signal can be manipulated.

## Figure legends:

**Figure 1:** Sequence of events in a trial for each task condition. In all three, the trial was initiated by the monkey pressing a lever. Top row: Reach only. When the fixation LED was illuminated, the monkey had to both press the button and fixate the LED. When the peripheral LED was illuminated, the monkey had to reach and press the peripheral button, while maintaining fixation on the fixation LED. Middle row: Saccade Only. When the fixation LED was illuminated, the monkey had to fixate it, keeping the start lever depressed. When the peripheral LED was illuminated, the monkey had to make a saccade to it, while keeping the start lever depressed throughout. Bottom row: Reach and Saccade. When the fixation LED was illuminated, the monkey had to both fixate the LED and depress the button, as in the Reach Only condition. When the peripheral target was illuminated, the monkey had to both make a saccade to the LED and depress the button.

**Figure 2:** Representative eye traces and times of button presses during the three task conditions.

**Figure 3:** Reach or Saccade neuron. This neuron discharges in all three task conditions. The activity in each task condition is shown separately in the three panels. In each case, rasters and histograms are aligned to movement onset. Top panel: Reach Only trials. Activity is aligned to the start of the reach to the target button. In each panel, the tick marks immediately to the left of zero represent the time of target presentation. In each

trial, the first two tick marks represent the time that fixation is acquired, and lever press (trial initiation). The tick marks to the right of zero represent the time of the end of the reach (i.e. time that the target button is depressed). Middle panel: Saccade Only trials. Activity is aligned to the start of the saccade. Tick marks represent the same events as in the top panel, except that the last set represent the end of the saccade. Bottom panel: Reach and Saccade trials. Activity is aligned to the start of the reach.

**Figure 4:** Relative firing rate of Reach or Saccade neurons for eye and arm movements. For each neuron, a modulation index was calculated to compare activity in Reach Only vs Saccade Only trials. Modulation ratio was defined as the difference in mean activity between Saccade Only and Reach Only trials divided by the sum of the mean activity ( $MF_{sac} - MF_{rea} / MF_{sac} + MF_{rea}$ ). A modulation ratio of zero signifies equal activity in the two conditions; a ratio of 0.5 or -0.5 signifies 3 times greater activity in one condition than the other.

**Figure 5:** Reach Only neuron. These neurons discharge preferentially in the Reach Only and Reach & Saccade conditions. Rasters and histograms are aligned on reach onset, as in Figure 3. Tick marks follow the convention of Figure 3.

**Figure 6:** Saccade Only neuron. Rasters and histograms are aligned to movement onset (saccade), as in Figure 3.

**Figure 7:** Activity of Saccade Only neuron in response to spontaneous vs. task-related saccades. Top panel: activity of this neuron during Reach Only trials, aligned to the spontaneous saccade made after the end of the trial and the animal had been rewarded. Bottom panel: activity is aligned to rewarded task-related saccade during Saccade Only trials.

**Figure 8:** Left: Relative proportions of non-modulated and task-related, and movement-related neurons observed. Right: Within movement-related neurons, relative proportions of Reach or Saccade, Reach Only, and Saccade Only neurons observed.

**Figure 9:** Effects of combining saccade and reach on mean firing rate as compared to isolated movements. Mean firing rate in Reach Only or Saccade Only condition is plotted against mean firing rate in Reach and Saccade condition for all neurons. The line shows  $x=y$ ; points that lie on or close to this line have similar firing rates in the two conditions. For Reach or Saccade neurons, activity in the Reach Only condition is plotted against activity in the Reach and Saccade condition.

Filled circles = Reach or Saccade neurons, crosses = Reach Only neurons, asterisks = Saccade Only neurons.

**Figure 10:** Directional tuning of a Reach or Saccade neuron. Left hand column: Mean firing rate during a period 40 msec after target onset and continuing until the end of the movement is shown for each direction on the polar plots. The three plots show the tuning in each of the three task conditions. This neuron had the same preferred direction for all

three task conditions. Right-hand column: Temporal characteristics of tuned response. For each task condition, two spike density functions are shown. Solid line represents for trials when movements were made in the neurons best direction. Dashed line represents trials when the movement was made in the worst direction. Spike density functions were generated by convolving the spike histograms with a gaussian function with  $\sigma = 5\text{msec}$ .

**Figure 11:** Neural activity relative to three different trial events. Each graph shows the spike density functions of activity aligned to a different trial event. Top graph: Spikes are aligned to the start of the trial (Lever press). Middle graph: Spikes are aligned to start of fixation. Bottom graph: Spikes are aligned to target onset. In the case of the Reach Only and Reach and Saccade conditions, fixation is taken to be the time when the monkey has both acquired the fixation LED and has also depressed the button. Therefore, the time when the eyes actually enter the fixation window occurs shortly before.

**Figure 12:** Distribution of neural onset times relative to target presentation. For each neuron, neural onset time was determined by averaging over all trials the time at which neural activity rose 2 standard deviations above baseline (determined by averaging over a 500 msec interval during intertrial). For Reach or Saccade neurons, neural onset time in the Reach Only condition is plotted.

**Figure 13:** Top panel: Location of electrode penetrations containing movement-related neurons in right hemisphere of Monkey J. Bottom panel: Recording locations are shown as well as locations of sites where movements were evoked by stimulation (see Appendix

for details). Filled symbols = recording penetration locations, open symbols = stimulation penetration locations. Note that for both panels, abscissa and ordinate have different scales.

## References:

- Biguer, B., Jeannerod, M. & Prablanc, C. (1982). The coordination of eye, head, and arm movements during reaching at a single visual target. *Experimental Brain Research*, 46, 3031-304.
- Chen, L.L & Wise, S.P. (1995) Neuronal activity in the supplementary eye field during acquisition of conditional oculomotor associations. *Journal of Neurophysiology*, 73, 1101-1121.
- Clower, W.T. & Alexander, G.E. (1998). Movement sequence-related activity reflecting numerical order of components. *Journal of Neurophysiology*, 80, 1562-1566.
- Dum, R.P. & Strick, P.L. (1991). The origin of corticospinal projections from the premotor areas in the frontal lobe. *Journal of Neuroscience*, 11, 667-689.
- He, S-Q, Dum, R.P., & Strick, P.L. (1995). Topographic organization of corticospinal projections from the frontal lobe: Motor areas on the medial surface of the hemisphere. *Journal of Neuroscience*, 15, 3284-3306.
- Huerta, M.F., & Kaas, J.H. (1990) Supplementary eye field as defined by intracortical microstimulation: Connections in macaques. *Journal of Comparative Neurology*, 293, 299-330.
- Judge, S.J., Richmond, B.J. & Chu, F.C. (1980). Implantation of magnetic search coils for measurement of eye position: an improved method. *Vision Research*, 20, 535-538.
- Luppino, G., Matelli, M., Camarda, R.M., Gallese, V. & Rizzolatti, G. (1991) Multiple representations of body movements in mesial area 6 and the adjacent cingulate cortex: An intracortical microstimulation study in the macaque. *Journal of Comparative Neurology*, 311, 463-482.
- Mann, S.E., Thau, R. & Schiller, P.H. (1988) Conditional task-related responses in monkey dorsomedial frontal cortex. *Experimental Brain Research*, 69, 460-468.
- Matelli, M., Luppino, G. & Rizzolatti, G (1991). Architecture of superior and mesial area 6 and the adjacent cingulate cortex in the macaque monkey. *Journal of Comparative Neurology*, 311,445-462.

- Miyashita, K., Sakai, K. & Hikosaka, O. (1996) Effects of SMA and pre-SMA inactivation on learning of sequential movements in monkey. *Society for Neuroscience Abstracts*, 22, 1862.
- Mushiake, H., Fujii, N. & Tanji, J. (1996). Visually guided saccade versus eye-hand reach: contrasting neuronal activity in the cortical supplementary and frontal eye fields. *Journal of Neurophysiology*, 75,2187-2191.
- Mushiake, H., Inase, M. & Tanji, J. (1990). Selective coding of motor sequence in the supplementary motor area of the monkey cerebral cortex. *Experimental Brain Research*, 82, 208-210.
- Nakamura, K., Sakai, K. & Hikosaka, O. (1998). Neuronal activity in medial frontal cortex during learning of sequential procedures. *Journal of Neurophysiology*, 80,2671-2687.
- Olson, C.R. & Gettner, S.N. (1995) Object-centered direction selectivity in the macaque supplementary eye field. *Science*, 269, 985-988.
- Robinson, D.A. (1963). A method of measuring eye movement using a scleral search coil in a magnetic field. *IEEE Transactions on Biomedical Engineering*, 10, 137-145.
- Schall, J.D. (1991) Neuronal activity related to visually guided saccades in the frontal eye fields of rhesus monkeys: Comparison with supplementary eye fields. *Journal of Neurophysiology*, 66:559-579.
- Schlag, J. & Schlag-Rey, M. (1985). Unit activity related to spontaneous saccades in frontal dorsomedial cortex of monkey. *Experimental Brain Research*, 58,208-211.
- Schlag, J., & Schlag-Rey, M. (1987) Evidence for a supplementary eye field. *Journal of Neurophysiology*, 57, 179-200.
- Tanji, J. & Shima, K.(1994). Role for supplementary motor area cells in planning several movements ahead. *Nature*, 371, 413-416.
- Tehovnik, E.J. (1995) The dorsomedial frontal cortex: eye and forelimb fields. *Behavioral Brain Research*, 67:147-163.



Figure 1

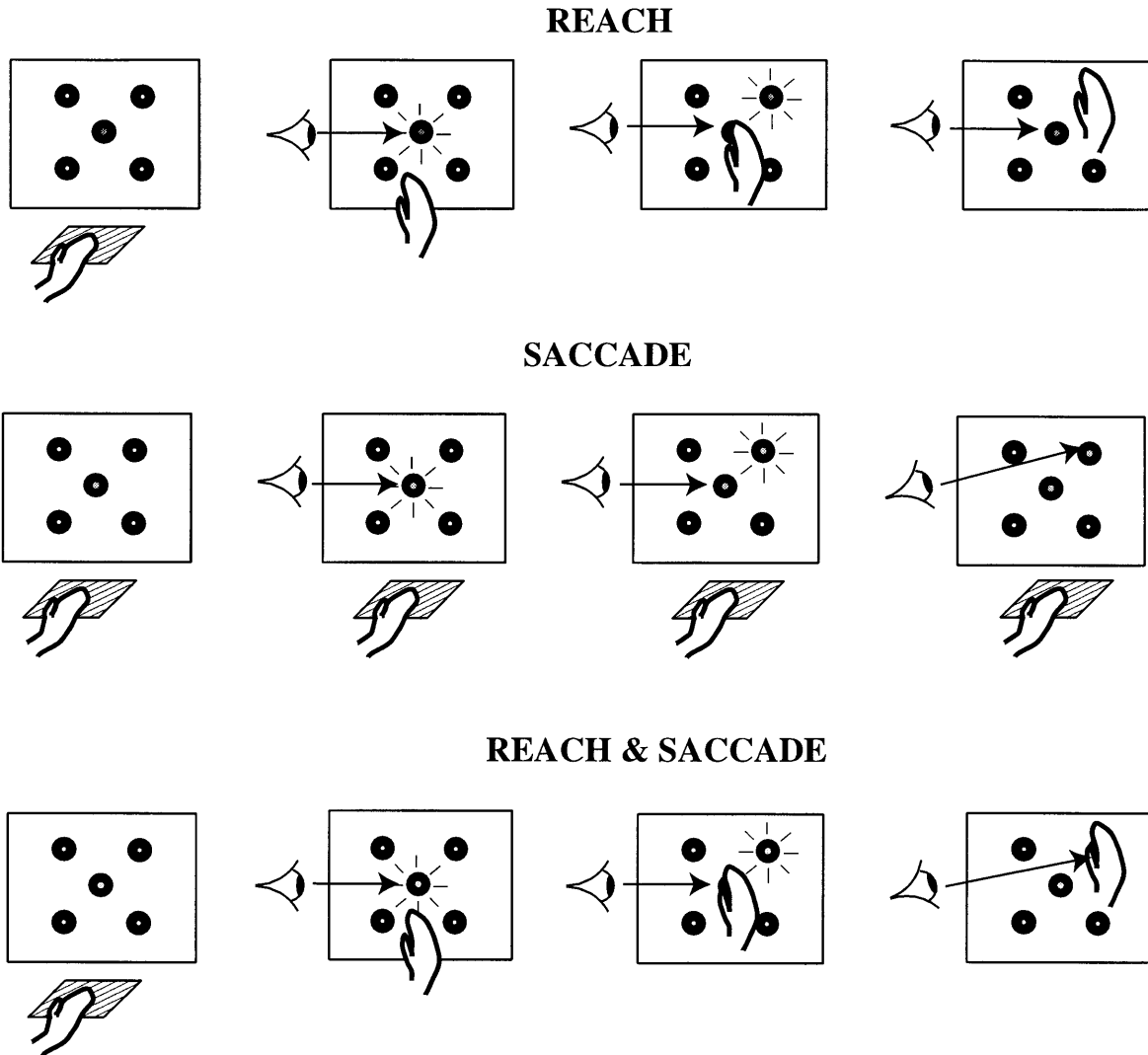

Figure 2

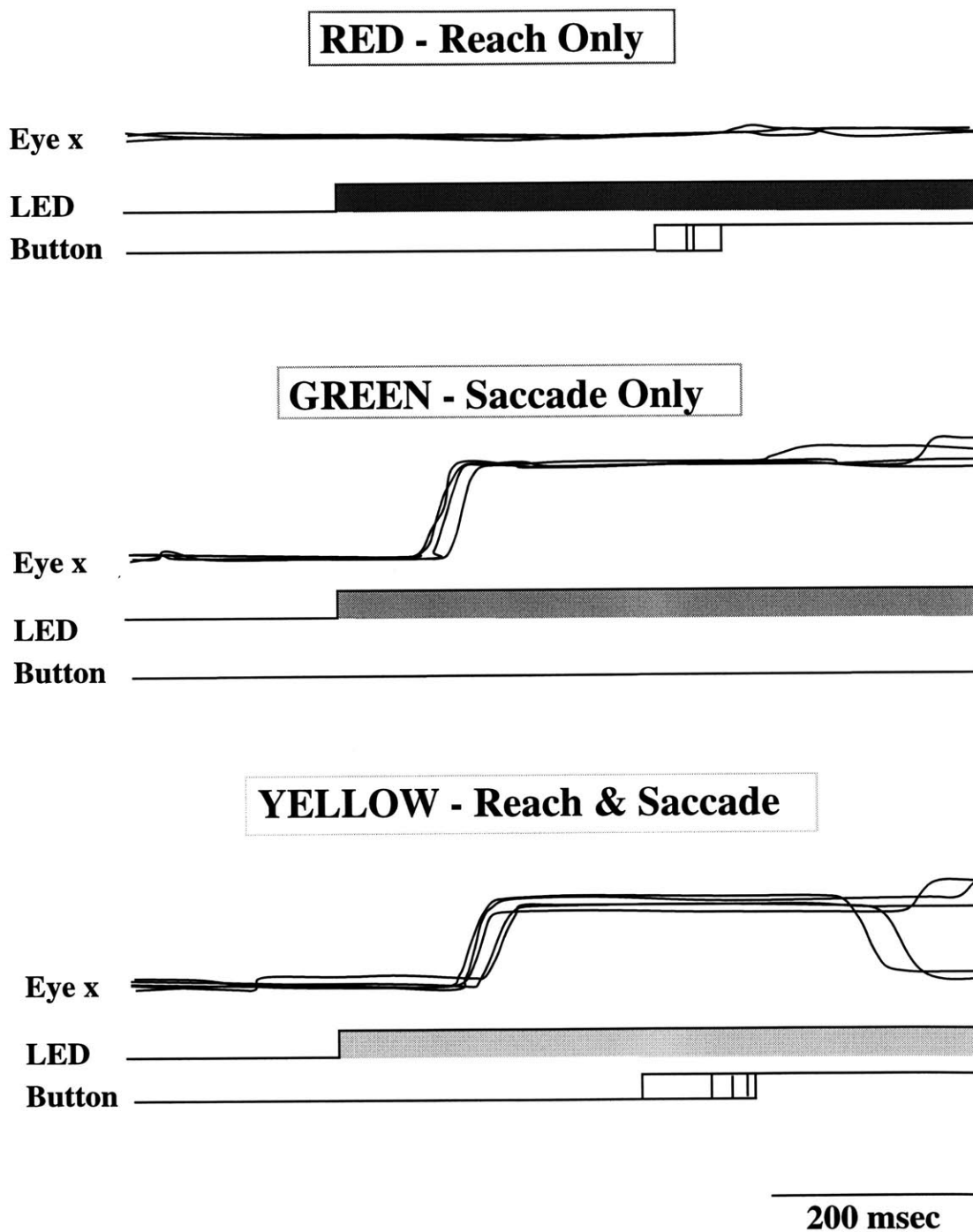
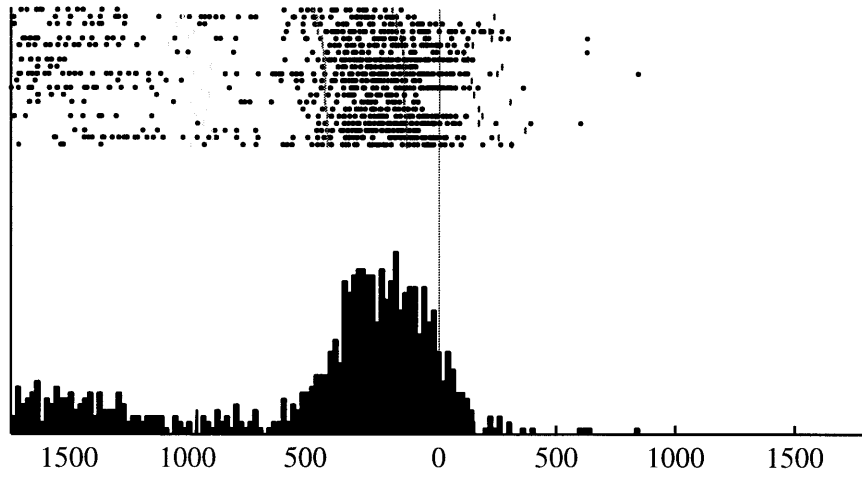
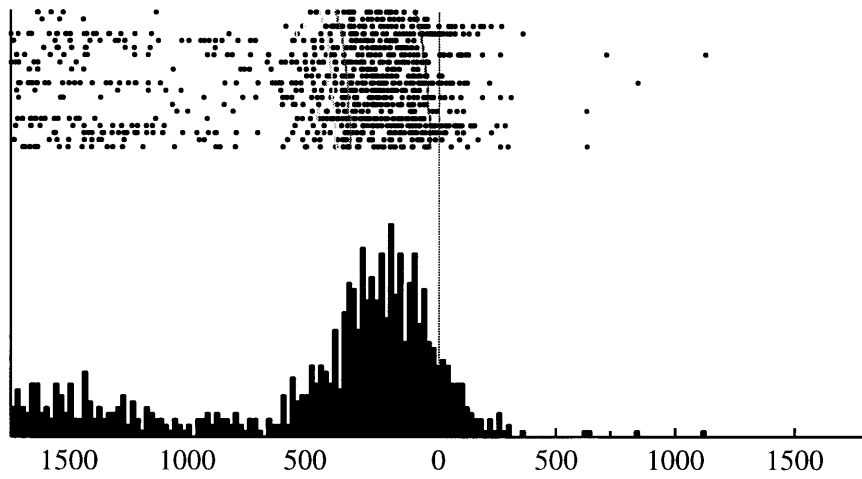

Figure 3

### REACH ONLY



### SACCADE ONLY



### REACH AND SACCADE

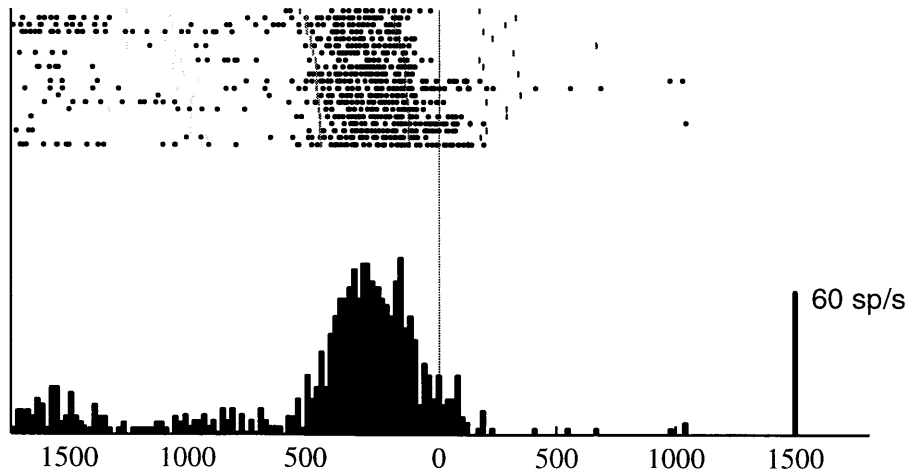

Figure 4

**Ratio of mean firing rate in Reach only to Saccade Only condition**

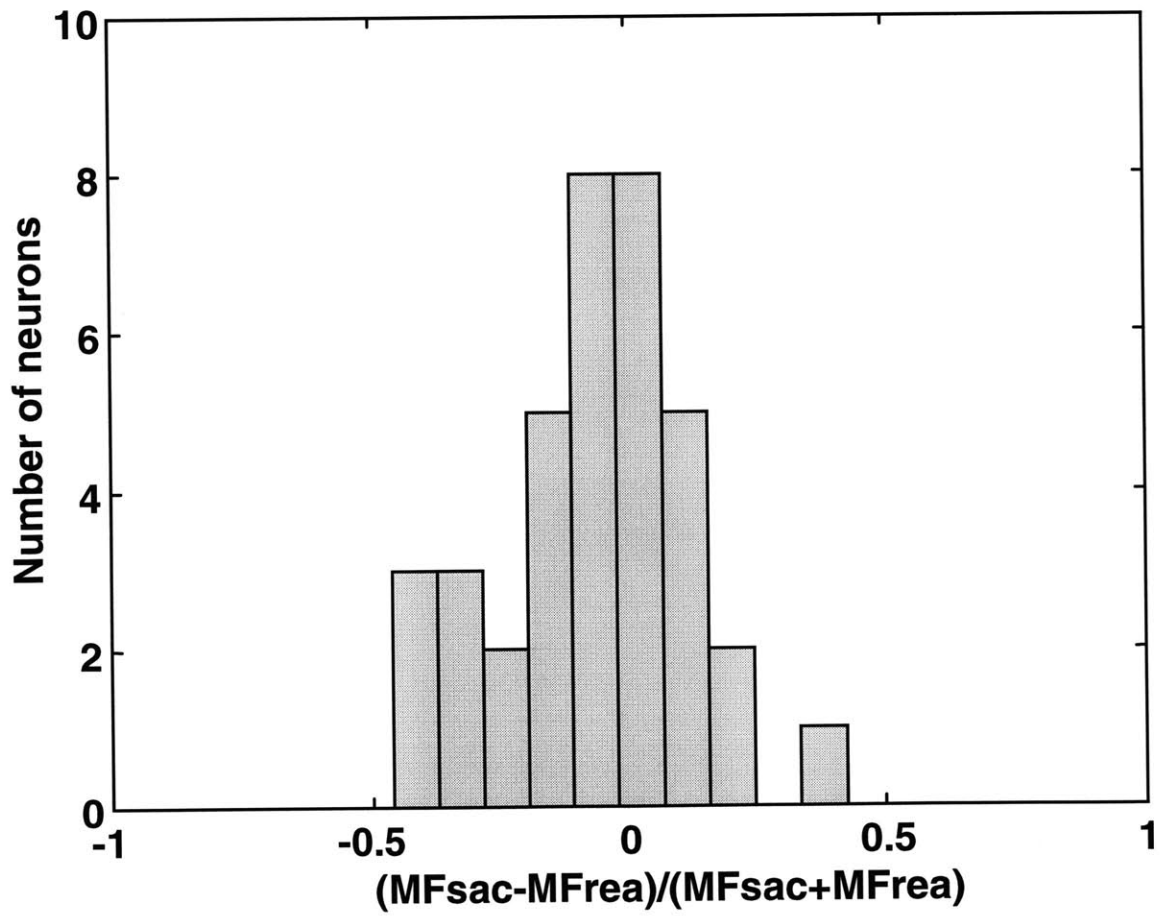

Figure 5

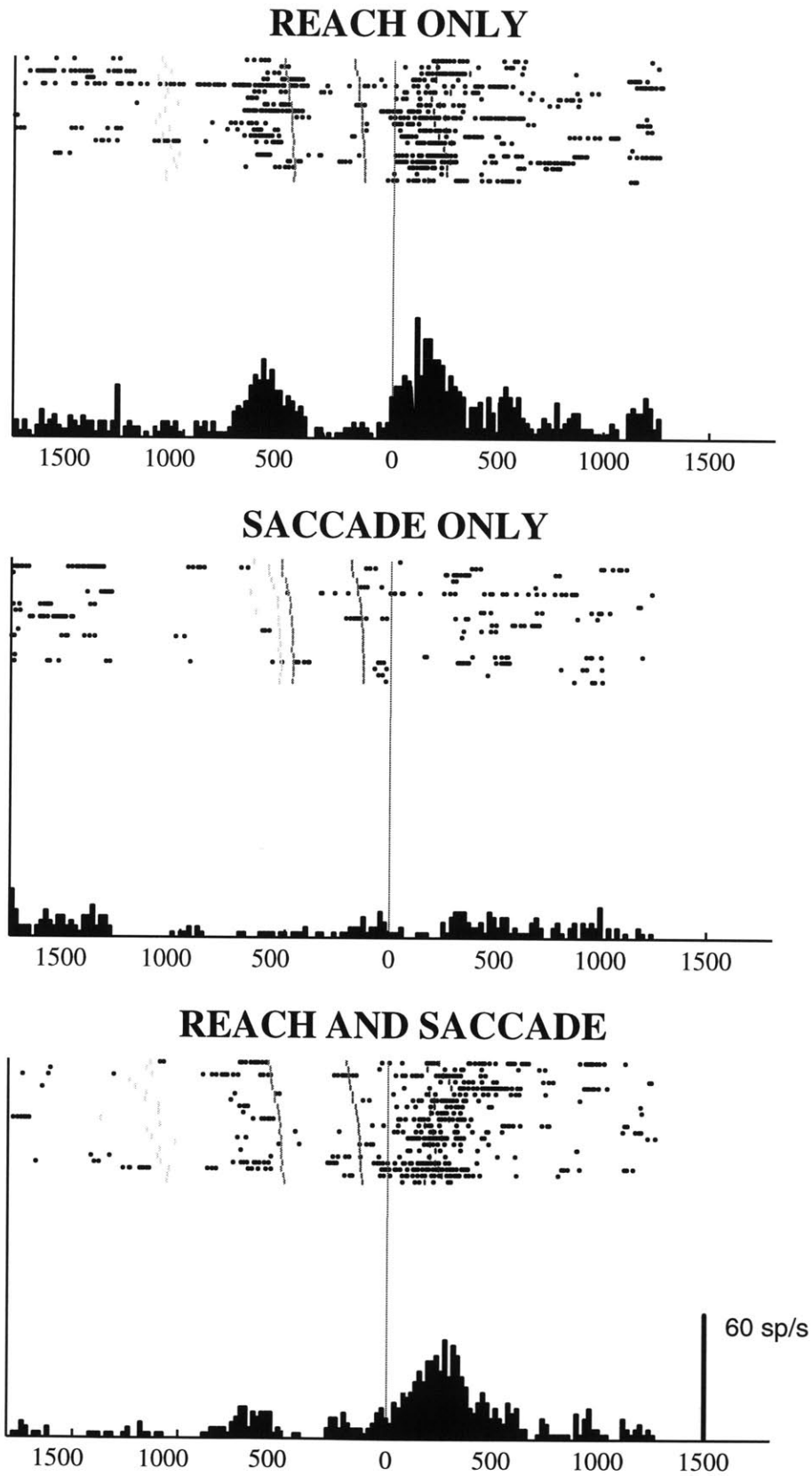
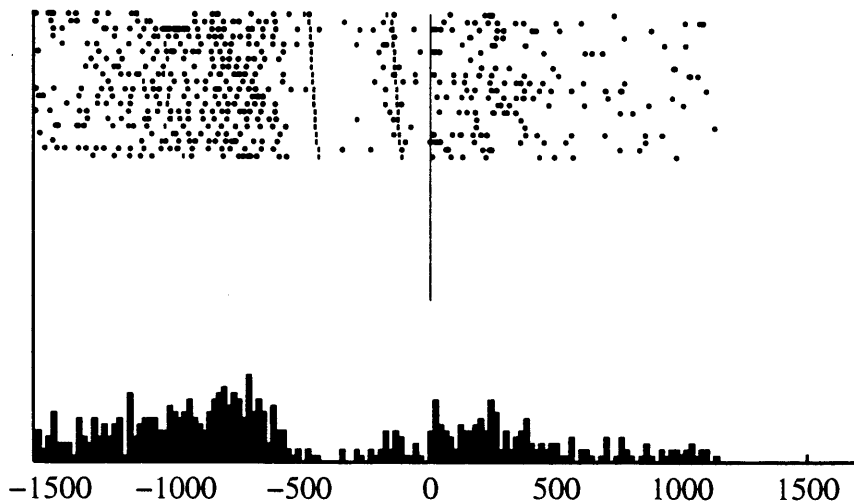
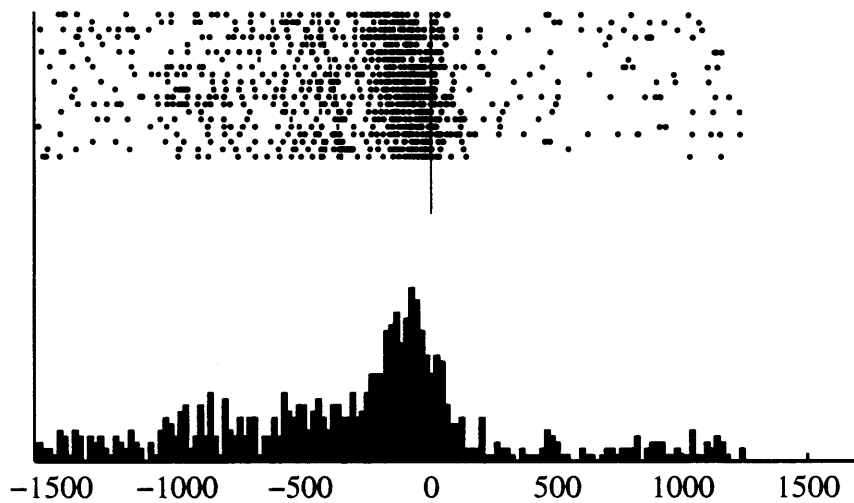

Figure 6

### REACH ONLY



### SACCADE ONLY



### REACH AND SACCADE

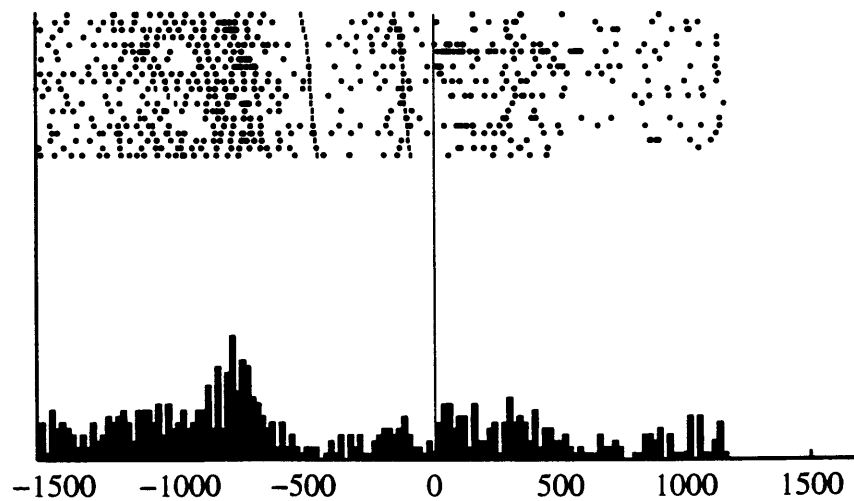

Figure 7

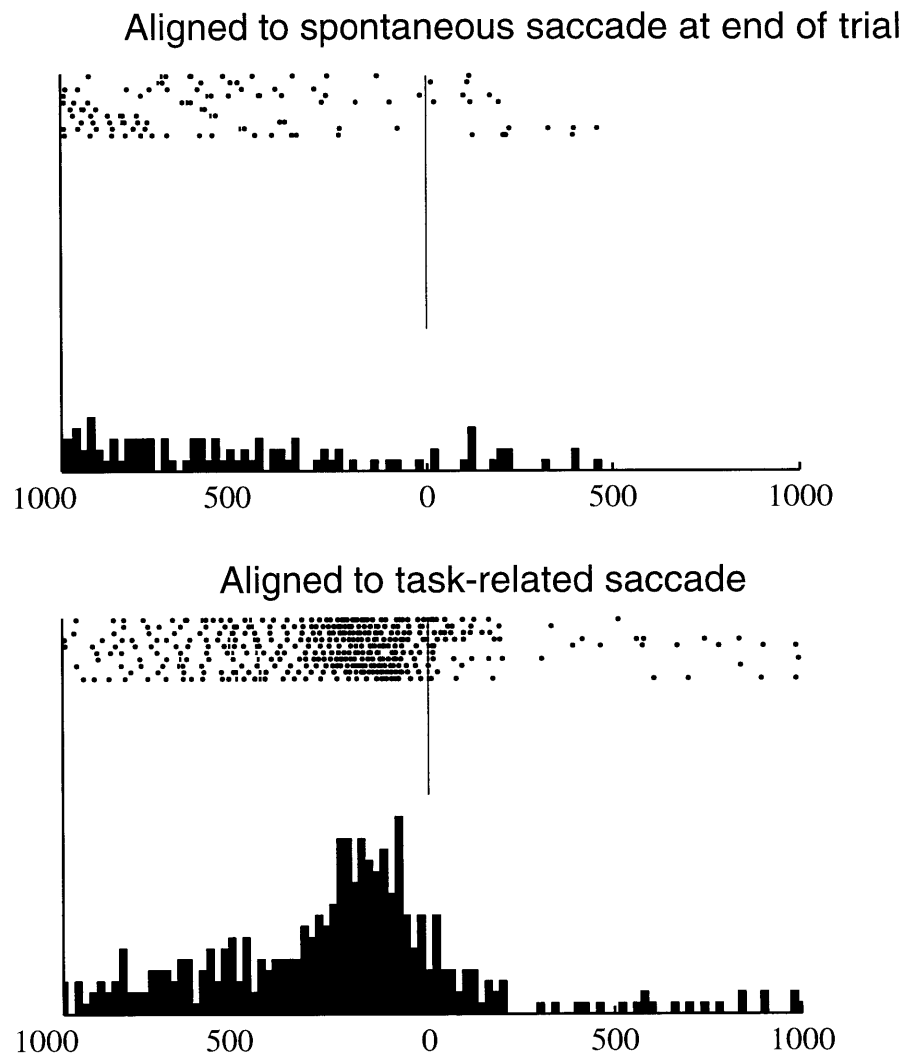

Figure 8

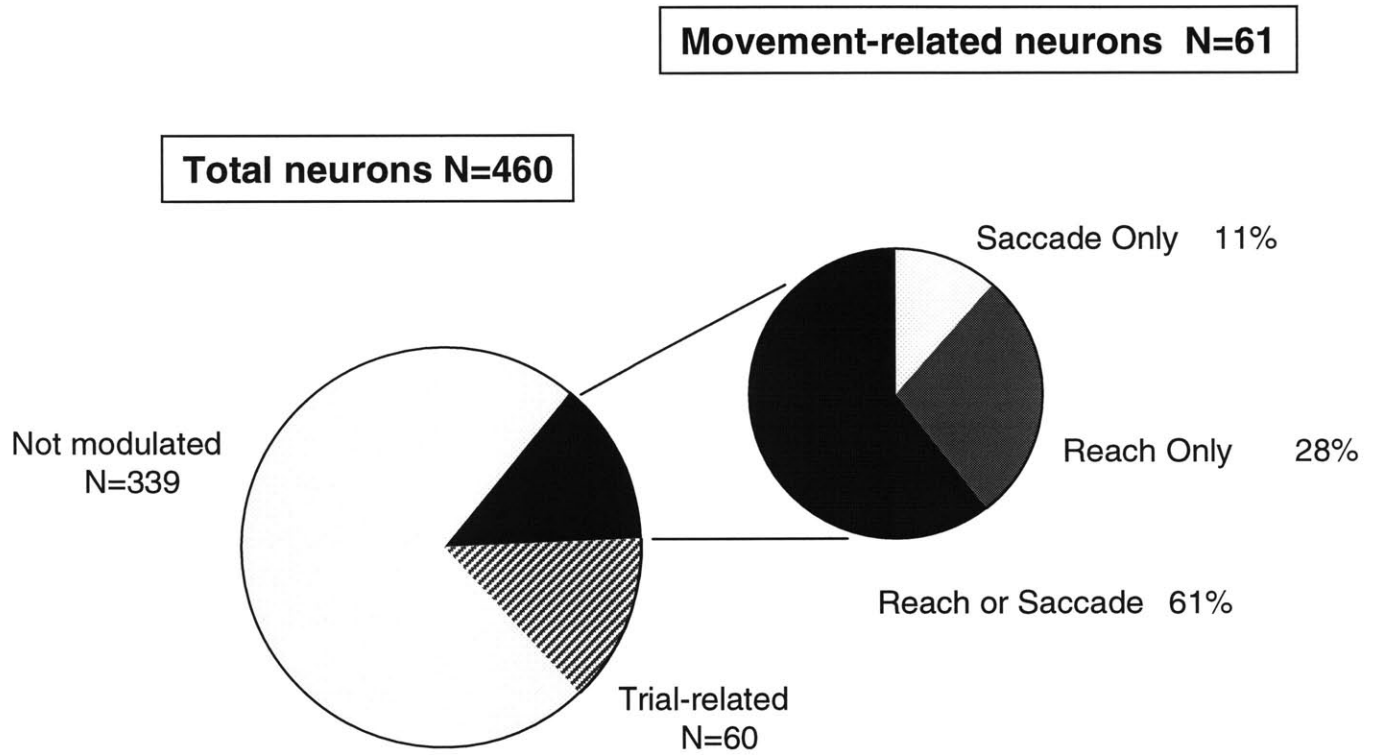



Figure 9

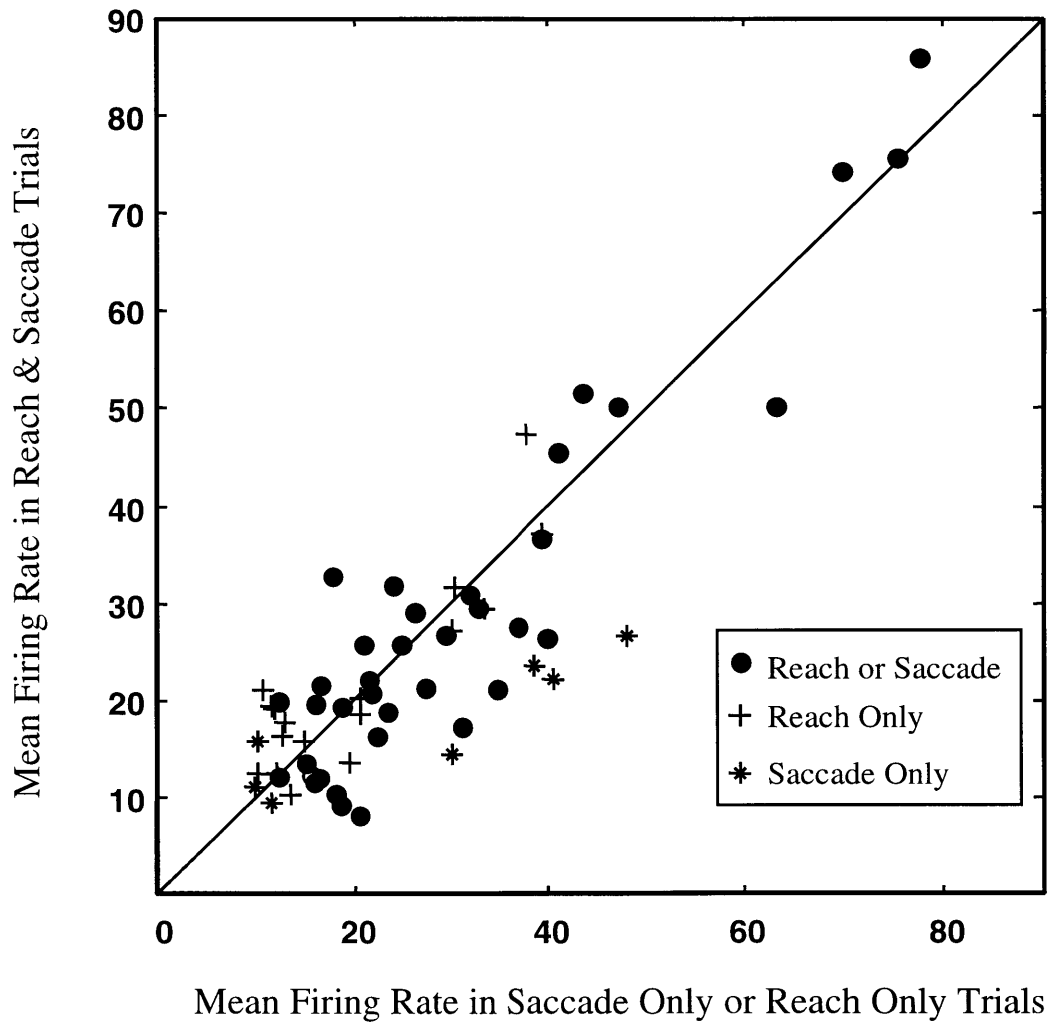
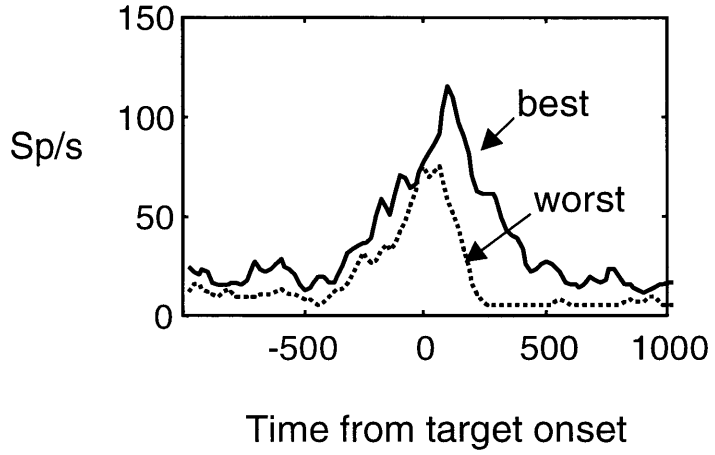
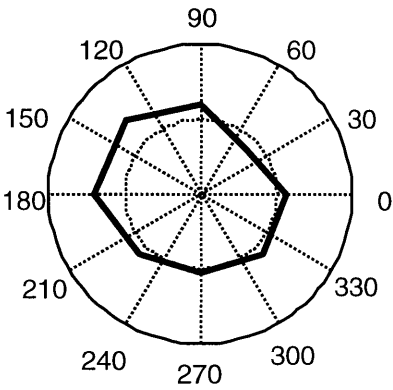
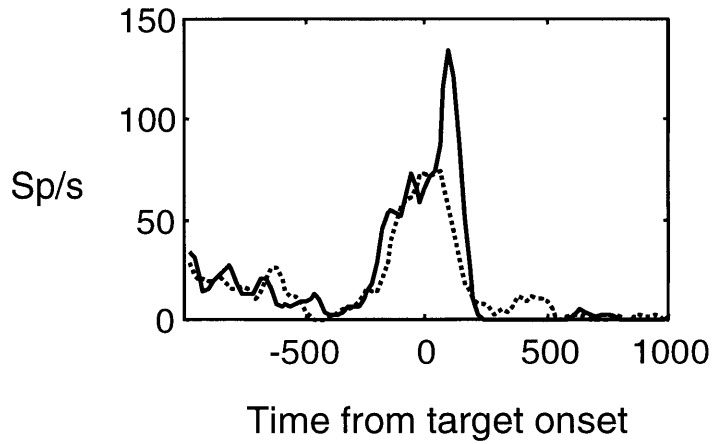
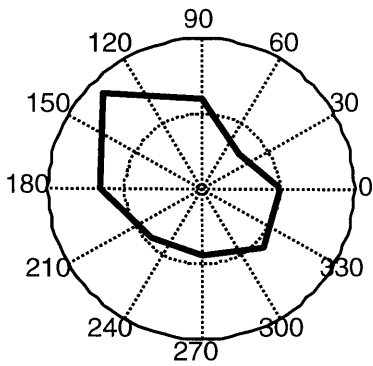

Figure 10

**REACH ONLY**



**SACCADE ONLY**



**REACH & SACCADE**

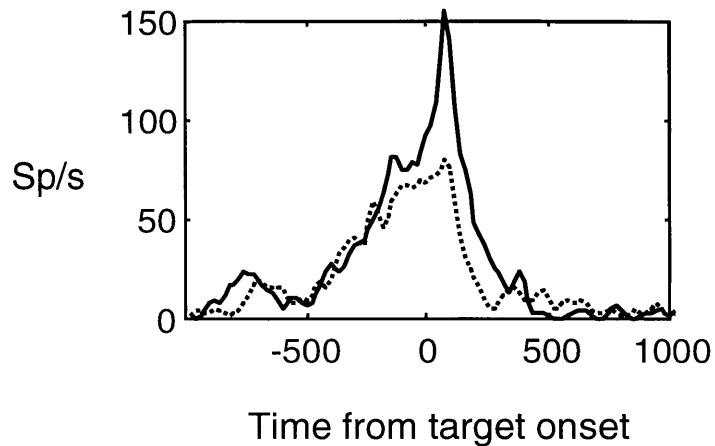
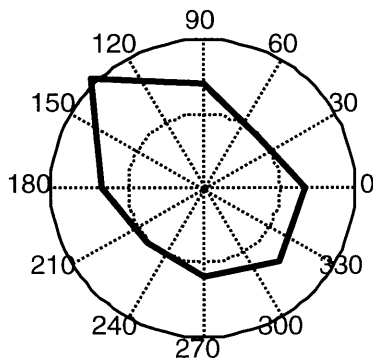

Figure 11

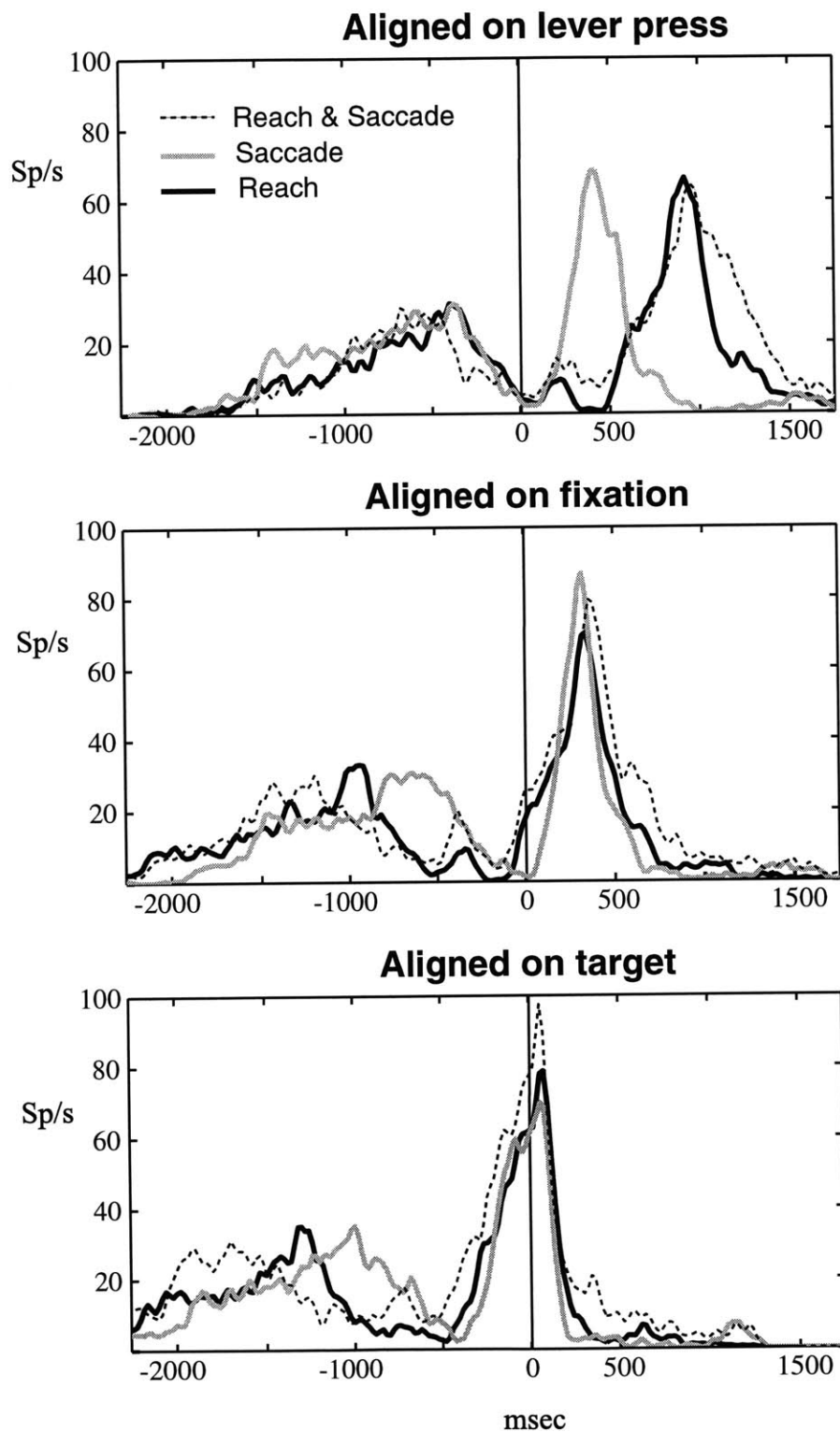

Figure 12

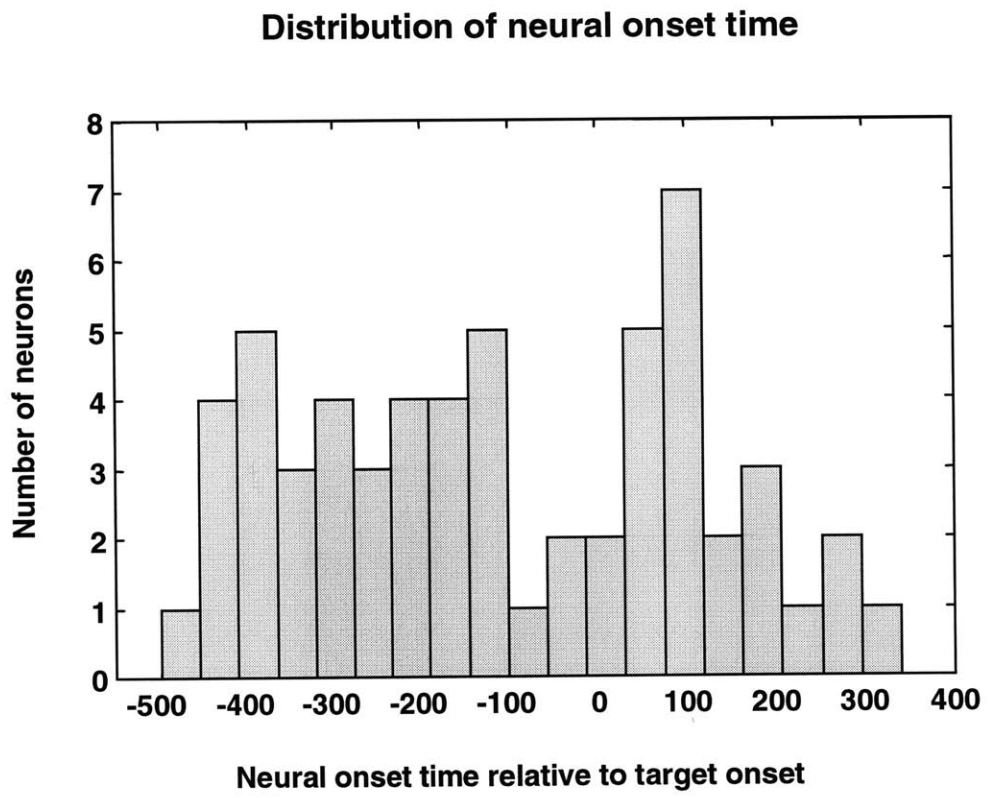
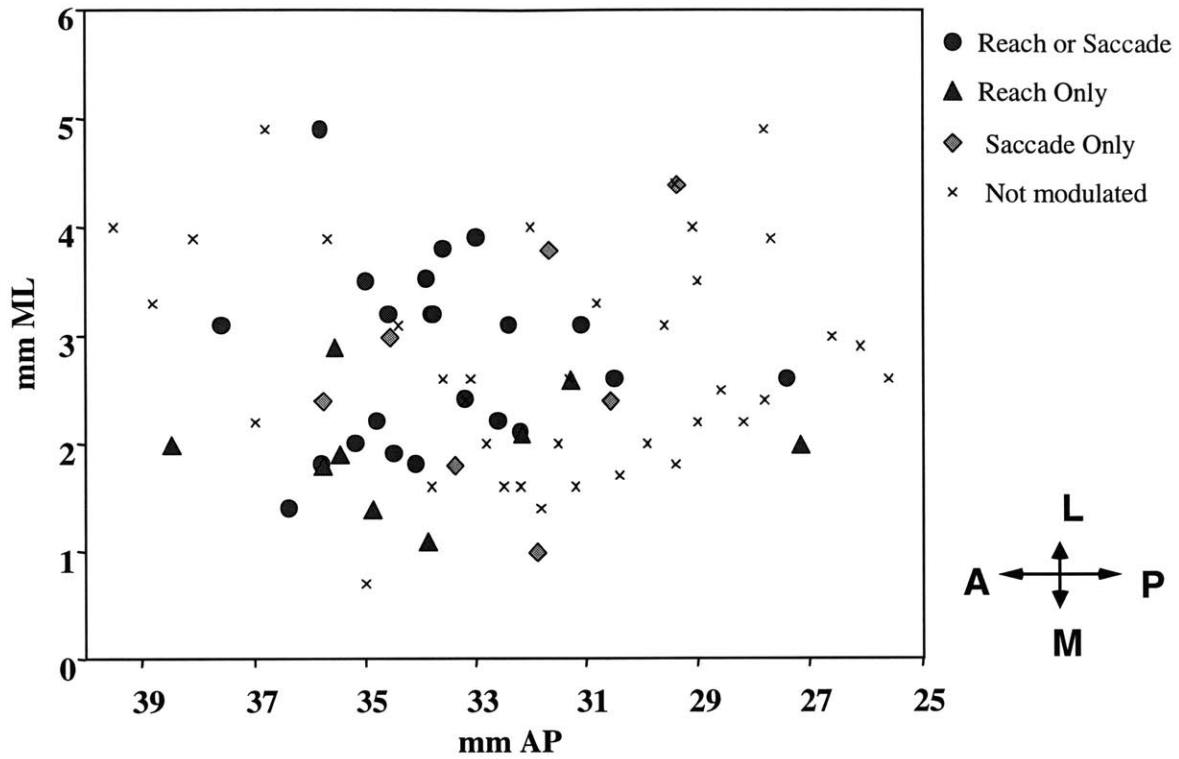
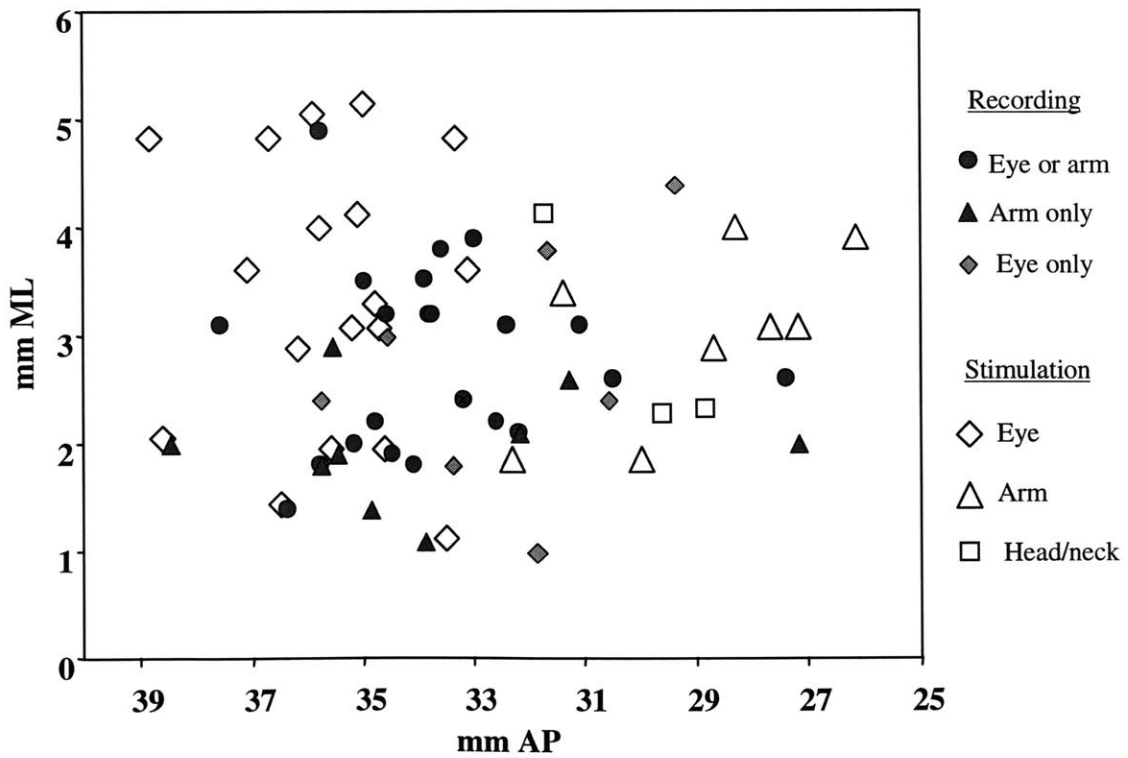

Figure 13

Location of recording penetrations



Location of recording & stimulation penetrations



### **Chapter 3: Modulation of the pre-movement build up activity.**

#### **Introduction:**

In the previous chapter I characterized the movement properties of dorsomedial frontal cortex neurons. One observation was that many neurons discharge well in advance of movement onset, even before the target is presented. Pre-movement build up activity, termed “preparatory set activity” has been observed throughout frontal motor areas before monkeys make arm movements, but is particularly prevalent in dorsomedial areas such as supplementary motor area and premotor cortex (Tanji & Evarts, 1976; Kurata & Wise; 1988; Okano & Tanji, 1987; Alexander & Crutcher, 1990). It has been proposed that this activity reflects voluntary preparation to generate movements. The activity tends to be specific to a particular direction of movement, and is observed when the monkey is directed as to where to move, but is required to wait for an instruction cue until moving. When the monkey is required to move to a different location than the target (the arm movement analogy of the antisaccade task), the majority of neurons in supplementary motor area and in premotor cortex encode the direction of the instruction target rather than the direction of the movement (Alexander & Crutcher, 1990; Shen & Alexander, 1997).

Early activity has also been observed before eye movements, either before initiation of a voluntary saccade (Schlag & Schlag-Rey, 1987) or during the hold period of a delayed-saccade paradigm (Schall, 1991b). In both cases, this early activity, seems to be dependent on the monkey being able to internally generate a plan to make a movement to a certain location.

Lesions of the supplementary motor area, where preparatory set activity lead to a specific deficit in voluntarily initiating movements. Monkeys were trained to lift their arm to break an invisible infrared beam in order to receive reward. Immediately following bilateral SMA lesions, monkeys were reluctant to initiate the arm movements on their own and made few correct trials. However, if they were provided with an external cue, a tone, they would readily perform the task in response to the tone. The tone itself had no actual effect on the reward contingency, as the monkey was always free to break the beam for reward, but the monkeys were unable to initiate the movements on their own (Chen et al., 1995). An analogous deficit has not been observed for saccadic eye movements. Reversible and permanent lesions do not yield any discernible deficits on spontaneous scanning eye movements even immediately after surgery (Sommer & Tehovnik, 1998; Schiller & Chou, 1998).

In humans, early movement-related activity has also been observed. A negative DC shift in scalp potential, termed the readiness potential, is seen in humans when they prepare to make finger movements (Kornhuber & Deecke, 1965). This potential has several components. There is a slow buildup that begins up to 2000 msec before movement initiation and then there is an additional increase in negativity just before the movement actually begins (Deecke & Kornhuber, 1969; Shibasaki et al., 1990). It has been proposed that the readiness potential reflects volitional motor preparation processes, and it is greater before difficult movements (Lang et al., 1990; Niemann et al., 1991) or those which require extra planning, such as sequence generation. The early component of the readiness potential is thought to originate bilaterally from SMA in both hemispheres whereas the later component originates from the contraversive primary

motor cortex (reviewed in Deecke & Lang, 1996). This has been disputed somewhat, as some researchers have failed to confirm the existence of early SMA activity using other techniques such as magnetoencephalography (e.g. Bötzel et al., 1985) or subdural electrodes (Neshige et al., 1988).

In the previous chapter, it was shown that the pre-movement signal can be observed before both eye and arm movements in the same neuron. Whether this is true of humans is not clear. The readiness potential is not exclusive to arm movements, even though the vast majority of studies have tested arm movements. The readiness potential is seen before eye movements as well (Becker, 1972; Evdokimidis et al., 1992; Klostermann et al., 1994; Kurtzberg & Vaughn, 1994). Whether this potential originates from the same locus as the potential seen before arm movements is unknown, as the spatial resolution of scalp potentials is not adequate.

If this early build up activity does reflect a general movement preparation signal or anticipation of the target light, then it should be modulated by the predictability of when or where the upcoming target or movement will be. Indeed, such an observation has been made in dorsomedial frontal cortex neurons when monkeys are engaged in smooth pursuit eye movements. When monkeys were tested on a step-ramp pursuit task in which the target was presented at the same velocity and direction over many trials, smooth-pursuit related neurons showed a facilitation of their response (Heinen & Liu, 1997). In the superior colliculus, early activity can be modulated by probability that the upcoming movement will be made in the direction that coincides with that neuron's preferred direction (Basso & Wurtz, 1997; Dorris & Munoz, 1998). That is unlikely to be



the case in dorsomedial frontal cortex, as the build up occurs before the direction of the upcoming movement is specified. Also, many neurons that do not show directional tuning, or weak tuning. The anticipation may be better related to the predictability of the movement, rather than its parameters.

In this chapter, the effects of an experimental manipulation that changed the expectation of movement occurrence on the build up activity in these neurons is discussed. Neurons that showed build up activity before both saccades and reaches were tested, as well as those that discharged exclusively before one or the other.

## Methods:

Subjects and equipment for running trials, collecting and analyzing data were the same as in the previous chapter. Recording procedure was also the same, except that in this experiment, only neurons with robust buildup activity were tested. Neurons were classified in terms of their preference for eye or arm movements as in the first experiment, but in this experiment I only analyzed those neurons with pre-movement buildup discharges. Regardless of which type of movement the neurons preferred, all the neurons included in this analysis began discharging after the monkey had acquired fixation, increased in discharge throughout the hold period and declined at the time of movement initiation. A total of 21 neurons were tested, 10 of which were Reach or Saccade, 7 were Reach Only and 4 were Saccade Only.

Once a build up neuron was identified by visual inspection of the rasters, and its movement preference characterized, its activity was monitored through a sequence of trials, as shown in Figure 1. The monkey first ran 10 blocks of trials in which he made a movement to the fixation, held fixation for 300 msec and then to the target, which could appear in one of four locations, as in the first experiment (Figure 1, top row). The color of the LED's was not randomized, as in the first experiment, but remained constant throughout the block. The monkey then ran for 10 blocks in which the target was not presented, but the monkey had to hold fixation for a pseudo-randomly determined amount of time, after which he was rewarded (Figure 1, middle row). The monkey then ran for 10 blocks where the target was once again presented, and he had to perform the complete task in order to be rewarded (bottom row). For neurons that were identified to have both eye and arm movement responses, the experiment was run for both eye and

arm movements but the trials were not intermixed. Thus the full 30 block sequence would be run with exclusively Reach Only trials, and then the sequence would be run with Saccade Only, or vice versa. Reach Only and Saccade Only neurons were tested with blocks of Reach Only and Saccade Only trials, respectively. For each trial, the mean firing rate over the first 300 msec after fixation onset was calculated. In the target conditions, this encompassed the entire fixation period. In the no-target condition, the monkey was also fixating during this period.

Insert Figure 1 about here

Analysis of variance was used to examine the effects of task condition (First target block, No-target block, Second target block) on the level of build up activity. Post-hoc pairwise comparisons (Scheffé) was used to determine the direction and significance of differences in firing rate between the conditions. For 8 of the Reach or Saccade neurons, both Reach Only and Saccade Only sequences were tested. For these neurons, ANOVAs were calculated separately for each sequence.

**Results:**

In 26/29 ANOVA tests, there was a significant effect of task condition ( $p < 0.05$ ) on level of build up activity. Post-hoc analysis (Scheffé) revealed that of the 26 tests with significant differences between task conditions, 16 of them (62%) had the lowest level of build up activity in the no-target block of trials. Thus for these neurons, activity was higher during the fixation period if a movement was to be made at the end of the period. Examination of the behavior revealed that during the no-target blocks, the monkeys did not make unrewarded movements to a peripheral LED at the end of the fixation period. They generally held fixation in the case of Saccade Only trials, or kept the fixation button depressed in the case of Reach Only trials for 200-300 msec after being rewarded.

Figures 2 and 3 shows the response of a Reach or Saccade neuron in Reach Only and Saccade Only tasks. This neuron discharges before both eye and arm movements, with the activity building up from start of fixation, peaking at the time of target presentation and declining at the point of movement initiation. Figure 2 shows the build up activity of this same neuron during successive blocks of Reach Only trials. In the first block of trials, the target was presented on every trial, and the monkey had to reach to the target while maintaining fixation on the first LED to be rewarded. The neuron shows a strong buildup response in this condition. The second histogram shows the activity for the second block of trials, in which no target was presented, and the monkey was rewarded for maintain fixation and holding the fixation button. In this block of trials, the buildup activity on average is much lower than that observed in the first block. The third histogram shows the activity for the final block, in which the target was once

again presented, and the monkey had to reach to the target again. The buildup activity in this block reverts to the level of the first block. The panel on the bottom shows the progression of neural activity throughout this sequence. Each point shows the mean firing rate during the 300 msec period after the start of fixation for each trial.

Insert Figure 2 about here

This particular neuron also showed buildup activity during Saccade Only trials. Figure 3 shows the activity of the same neuron during a sequential blocks of Saccade Only trials. As in Figure 2, the first histogram shows activity in the first block of trials, in which the monkey had to first fixate, and then acquire the target (in this case, by making a saccade). There is distinct build up activity in this block of trials. In the second block of trials, the monkey had only to fixate for a randomly determined amount of time before being rewarded. In this block, the neuron shows almost no activity while the monkey is fixating. As with the Reach Only condition, the activity resumed when the monkey was required to make a saccade to the target for reward.

Insert Figure 3 about here

Figure 4 shows the mean buildup activity in the different conditions plotted against each other for all of the neurons. The top two panels of Figure 4 show the mean activity during target blocks plotted against activity during the no-target block. The top panel (Figure 4A) shows mean activity in the first target block plotted on the ordinate

against the mean activity vs no-target block on the abscissa. Most of the points lie above the line  $x=y$ , meaning that for most of the neurons tested, the mean activity in target trials was higher than that in no-target trials. This effect was statistically significant across the population (Wilcoxon Z-score 3.89,  $p<0.0001$ ). Figure 4B shows the mean activity in the second target block plotted against mean activity in the no-target block. Again, most of the points lie above the line  $x=y$ , and this effect was also statistically significant (Wilcoxon Z-score 2.09,  $p=0.036$ ). Figure 4C shows the mean activity in the first target block plotted against the mean activity in the second target block. There was also a significant difference in mean firing rate in the second target block than in the first (Z-score , 3.13,  $p=0.002$ ).

Insert Figure 4 about here

Examination of the transition in activity between the blocks for those neurons that did show significantly lower firing rates in the no-target block revealed that in general, the activity did not drop immediately when the no-target block was begun. Figure 5 shows the progression of neural activity averaged across all neurons that showed significantly lower activity during the no-target block. The x-axis represents trial number. For each neuron, the activity for all trials was normalized to the mean firing rate in the first target block. The solid line shows the mean scaled activity for the population and the dotted lines show the standard deviation. The mean activity decreased exponentially in the no target block, and did not settle down to the lower rate of firing until approximately ten

trials into the block. When the second target block began, the activity rose almost immediately.

Insert Figures 5 & 6 about here

Figure 6 shows the progression of mean activity in the no-target block (top panel) and second target block (bottom panel). The decrease of activity in the no-target block was fit with an exponential function ( $y=0.93 * e^{-0.01x}$ ,  $R^2 = 0.973$ ) by the Gauss-Newton method of non-linear regression. The activity in the second target block, however, rises immediately following the first trial. In addition, there is an increase in firing rate throughout the trial that is fit by a linear function ( $y=0.006x + 1.02$ ,  $p < 0.01$ ,  $R^2 = 0.267$ ).

Figure 7 shows the activity during the trials just before and after each transition between the blocks. Each set of points with the same value on the x-axis shows the normalized firing rates of all neurons on one trial. The first section shows the activity in the last seven trials of the first target block. It can be seen that the activity is fairly constant. The second section, shaded in gray, shows the activity in the first seven trials of the no-target block. While some neurons show lower activity within the first few trials of the no-target block, others fire at a much higher rate than in the previous block. The third shows the activity in the last five trials in the no-target block, and it can be seen that by this portion of the block, the activity of most neurons has stabilized at a lower level. Across the population, there was a statistically significant difference between normalized firing rate during the first seven trials of the no-target block and the last seven trials (Wilcoxon Z-score  $-3.290$ ,  $p < 0.001$ ). The final section of the graph (shade section)

shows the first seven trials in the second target block. Most of the neurons increase their firing rate even on the first trial, and some discharge at a high rate, as in the start of the no-target block.

Examination of the behavior of the monkeys revealed that no discernable movements, such as a saccade to one of the LEDs that had been a target in previous trials, were made during these trials. The heavy line shows the mean normalized activity for all neurons and the dashed line shows the standard deviation. It can be seen that the variance in the trials immediately after the transition is higher than in the final trials, mostly due to high levels of activity shown by some neurons.

Insert Figure 7 about here



## **Discussion:**

In this experiment, it was shown that the anticipatory build up activity during fixation in DMFC could be manipulated for most neurons by expectation. During blocks of trials in which the monkey can predict that a target for movement will occur at the end of the fixation period, the build up activity is high. For the majority of neurons, this anticipatory activity is attenuated when a succession of trials is run on which the target (and therefore the movement) does not occur. This build up activity resumes once the original reward contingency is restored and the monkey is required to move once again. Thus occurrence of the build up activity is contingent upon the monkey being able to predict whether the target will occur.

A trivial explanation for this build up activity might be that it reflects anticipatory muscle activity, as the monkey prepares to initiate a movement. During the block of trials in which no target is presented, the monkey may relax those muscles as he realizes that the target is unlikely to appear (and therefore no movement will be required). This explanation is plausible for Reach Only neurons, and EMG analysis would be desirable to investigate any changes in tonic muscle activity between the different conditions. However, this seems less likely to be the case for saccade-related neurons, as the eyes are controlled primarily by fast twitch muscles, which do not exhibit this pattern of pre-movement build up. Perhaps the most compelling evidence against this explanation lies in the fact that some Reach or Saccade neurons, such as the one shown in Figures 2 and 3 show the same attenuation of build up activity regardless of whether the movement is a saccade or a reach. The two movements use very different muscle groups, and in either case either the eyes or the arm must remain immobile while the other makes a movement

to the target. It is difficult to conceive of a muscle group that would be equally used in both tasks such that it would show the same attenuation in activity level when the movement is not made, although the possibility cannot be ruled out.

Increased build up activity has been observed in other brain areas such as superior colliculus (Basso & Wurtz, 1997; Dorris & Munoz, 1998), frontal eye fields (Bruce & Goldberg, 1985) and premotor cortex (Mauritz & Wise, 1987). In these areas, the anticipatory activity is modulated by the probability that the upcoming movement will be made in the preferred direction of the neuron. This is also not a likely explanation for the activity observed in the neurons tested in this experiment, as the build up occurs even when there is an equal probability that the target will occur in any of several locations, and it is only modulated by whether or not the target will occur. In addition, most of these neurons did not show directional tuning, as described in the first experiment.

The question remains as to the purpose of a spatially non-specific anticipatory build up signal such as that observed in this experiment. One possibility is that it decreases latency, perhaps by facilitating the build up of movement-related activity. The SEF make projections to both the frontal eye fields and to the superior colliculus, where it has been shown that there is a consistent relationship between the time at which neurons reach a certain level of activity and the time at which saccades are initiated. (Hanes & Schall, 1996; Dorris et al., 1997). This suggests that movements are triggered when a certain threshold of neural activity is crossed, and the rate at which neurons increase their activity determines latency. Under predictable target conditions, saccadic latency is reduced (Paré & Munoz, 1996) and rate of activity in build up neurons in the superior colliculus is increased (Basso & Wurtz, 1997; Dorris & Munoz, 1998). A similar finding

has been observed in motor cortex (Riehle & Requin, 1993). In both cases, signals from dorsomedial frontal cortex might facilitate the increase in rate via excitatory connections or through reduction of inhibition via projections through basal ganglia.

Another possible role for build up activity is prediction or timing of sensory events rather than facilitating movement. In dopaminergic regions of the forebrain, neurons seem to encode the reward contingency of a sensory stimulus or upcoming movement. Thus they discharge not in anticipation of the sensory stimulus or movement per se if it is closely associated with a reward that the monkey receives at the completion of the movement. Initially, these neurons discharge in response to the reward, but if a contingency is set to the reward delivery, then the neurons will shift their activity temporally such that they discharge in response to the stimulus that predicts reward delivery (reviewed in Schultz, 1998). Similar activity has been reported recently in parts of the striatum (Tremblay et al., 1998; Hollerman et al., 1998; Shidara et al. paper, 1998), where neuronal activity is modulated by the predictability of the trial events leading to reward delivery.

The anticipatory discharge observed in DMFC neurons is more similar to this, although they did not seem to be encoding reward contingency per se. If the DMFC neurons observed here were encoding reward contingency, then it would be expected that the anticipatory activity would shift to occur before the rewarded movement, namely the movement bringing the eyes to fixation or the reach to the fixation button. This was not observed, suggesting that it was the target and not reward occurrence that was predicted.

In the task reported here, the anticipatory activity did not drop immediately after the no-target block began. Many of the neurons actually increased their discharge for a few trials, although no movement was made. This increase in activity in the first trials may reflect another function common to areas in dorsomedial frontal cortex, which is to signal that a change is required in motor strategy. Some neurons in SEF are only active while a monkey is learning the appropriate association between a stimulus and direction of movement, but not when the movements are over-learned (Chen & Wise, 1995). A similar finding has been observed when monkeys learn new sequences of arm movements in pre-SMA (Nakamura et al., 1998). Thus SEF/SMA may be active during the "switching" of motor programs, or in the learning of a new one. The high rate of discharge during learning, or during a switch in task, as in this experiment, may serve as an error signal, indicating a difference between the actual and predicted contingency.

## **Figure legends**

### **Figure 1:**

Events in a sequence of trials. First, 10 blocks of TARGET trials were run where the target was presented at the end of the fixation period. The monkey was required to make a movement, whose type was determined by the color of the LED, to the target to receive reward. Second, 10 blocks of NO-TARGET trials were run in which the target was not presented, but the monkey was rewarded for maintaining fixation for a randomly determined amount of time. Third, 10 blocks of TARGET trials, identical to the first set were run.

### **Figure 2:**

Anticipatory activity in a Reach or Saccade neuron during a sequence of Reach Only trials. Each graph in the top row shows the rasters and histograms in different target conditions. All rasters and histograms are aligned to the start of fixation. The first set of tick marks before zero represent the start of the trial and the two sets after zero represent the start and end times of the reach. The graph on the bottom shows the mean firing rate for each trial.

### **Figure 3:**

Activity of the same neurons as in Figure 2, but during a sequence of Saccade Only trials. Rasters and histograms are aligned to start of fixation, as in Figure 2, except that the tick

marks after zero represent start and end of the saccade. The mean firing rate on each trial is plotted in the bottom graph.

**Figure 4:**

Mean firing rates during different target blocks for each neuron. 4A: mean activity in first target block is plotted against the activity in the no-target block. 4B: mean activity in the second target block against the activity in the no-target block. 4C: mean activity in the first target block against mean activity in the second target block. Some neurons were tested both on a sequence of reach only and a sequence of saccade only blocks; for those cases, the results from both sequences are plotted. Thus 29 comparisons are plotted here, which are derived from 21 neurons.

**Figure 5:**

Scaled activity averaged across all neurons that showed significantly lower activity during the no target block. For each neuron, firing rate on a given trial was normalized to the mean firing rate of that neuron during the target 1 block. Solid line = mean activity of the population. Dashed line = one standard deviation.

**Figure 6:**

Regression of mean scaled neural activity during no target (top panel) and target 2 (lower panel) blocks.

**Figure 7:**

Neural activity during the transitions between blocks plotted on a trial-by-trial basis. For each neuron, firing rate on a given trial was normalized to the mean firing rate of that neuron during the target 1 block. Scaled firing rates for the individual neurons are shown as asterisks. Solid line = mean activity of the population. Dashed line = standard error of

the mean. The first seven points show the activity in the last seven trials of the first target block. The second seven points (shaded section) show the first seven trials of the no-target block. The next seven (unshaded) shows the last seven trials of the no target block (these trials did not follow immediately after the trials plotted before), and the last seven points (shaded) show the activity in the first seven trials of the target 2 block.

## References:

- Alexander, G.E. & Crutcher, M.D. (1990) Preparation for movement: neural representation of intended direction in three motor areas of the monkey. *Journal of Neurophysiology*, 64, 133-150.
- Basso, M.A. & Wurtz, R.H. (1979). Modulation of neuronal activity by target uncertainty. *Nature*, 389,66-69.
- Becker, W., Hoehne, O., Iwase, K. (1972). Bereitschaftspotential, prämotorische Positivierung und andere Hirnpotentiale bei sakkadischen Augenbewegungen. *Vision Research*, 12, 421-436.
- Bötzel, k., Plendl, H., Paulus, W. & Scherg, M. (1993). Bereitschaftspotential: is there a contribution of the supplementary motor area? *Electroencephalogr. Clin. Neurophysiol.*, 89, 187-196.
- Bruce, C.J. & Goldberg, M.E. (1985). Primate frontal eye fields. I. Single neurons discharging before saccades. *Journal of Neurophysiology*, 54,714-734.
- Chen, L.L & Wise, S.P. (1995) Neuronal activity in the supplementary eye field during acquisition of conditional oculomotor associations. *Journal of Neurophysiology*, 73, 1101-1121.
- Chen, Y-C, Thaler, D. Nixon, P.D., Stern, C.E. & Passingham, R.E. (1995) The functions of the medial premotor cortex. II. The timing and selection of learned movements. *Experimental Brain Research*, 102, 461-473.
- Deecke, L. & Lang, W. (1996). Generation of movement-related potentials and fields in the supplementary sensorimotor area and the primary motor area. In: *advances in neurology*, vol 70: Supplementary Sensorimotor area. H.O. Luders (Ed) Lippincott-Raven, Amsterdam.
- Deecke, L., Scheid, P. & Kornhuber, H.H. (1969) Distribution of readiness potential, pre-motion positivity and motor potential of the human cerebral cortex preceding voluntary finger movements. *Experimental Brain Research*, 7, 158-168.



- Dorris, M.C. & Munoz, D.P. (1998). Saccadic probability influences motor preparation signals and time to saccadic initiation. *Journal of Neuroscience*, 18, 7015-7026.
- Dorris, M.C., Paré, M. & Munoz, D.P. (1997). Neuronal activity in monkey superior colliculus related to the initiation of saccadic eye movements. *Journal of Neuroscience*, 17, 8566-8579.
- Evdokimidis, I., Mergner, T. & Lucking, C.H. (1992) Dependence of presaccadic cortical potentials on the type of saccadic eye movement. *Electroencephalography and clinical neuropsychology*, 83, 179-191.
- Hanes, D.P., Schall, J.D. (1996) Neural control of voluntary movement initiation. *Science*, 274, 427-430.
- Heinen, S.J. & Liu, M. (1997). Single-neuron activity in the dorsomedial frontal cortex during smooth-pursuit movements to predictable target motion. *Visual Neuroscience*, 14, 853-865.
- Hikosaka, O., Sakai, K., Miyachi, S., Takino, R., Sasaki, Y. & Pütz, B. (1996). Activation of human presupplementary motor area in learning of sequential procedures: a functional MRI study. *Journal of Neurophysiology*, 76, 617-621.
- Hollerman, J.R., Tremblay, L. & Shultz, W. (1998). Influence of reward expectation on behavior-related neuronal activity in primate striatum. *Journal of Neurophysiology*, 80, 947-963.
- Klostermann, W., Klompf, D., Heide, W., Verleger, R., Wauschkuhn, & Seyfert, T. (1994). The presaccadic cortical negativity prior to self-paced saccades with and without visual guidance. *Electroencephalography and clinical neuropsychology*, 91, 219-228.
- Kornhuber, H.H., & Deecke, L. (1965). Hirnpotentialänderungen bei Willkürbewegungen und passiven Bewegungen des Menschen: Bereitschaftspotential und reafferente Potentiale. *Pflügers Archiv für die Gesamte Physiologie*, 284, 1-17.
- Kurata, K. & Wise, S.P. (1988). Premotor cortex of rhesus monkeys: set-related activity during two conditional motor tasks. *Experimental Brain Research*, 69, 327-343.

- Kurtzberg, D. & Vaughan, H.G. (1982). Topographic analysis of human cortical potentials preceding self-initiated and visually-triggered saccades. *Brain Research*, 243, 1-9.
- Lang, W., Obrig, H., Lindinger, G., Cheyne, D. & Deecke, L. (1990). Supplementary motor area activation while tapping bimanually different rhythms in musicians. *Experimental Brain Research*, 79, 506-514.
- Mauritz, K-H., & Wise, S.P. (1986). Premotor cortex of the rhesus monkey: neuronal activity in anticipation of predictable environmental events. *Experimental Brain Research*, 61, 229-244.
- Mushiake, H., Inase, M. & Tanji, J. (1991) Neuronal activity in the primate premotor supplementary and precentral motor cortex during visually guided and internally determined sequential movements. *Journal of Neurophysiology*, 66, 705-718.
- Nakamura, K., Sakai, K. & Hikosaka, O. (1998). Neuronal activity in medial frontal cortex during learning of sequential procedures. *Journal of Neurophysiology*, 80,2671-2687.
- Neshige, R., Lüders, H., & Shibasaki, H. (1988) Recording of movement-related potentials scalp and cortex in man. *Brain*, 111, 719-736.
- Niemann, J., Winker, T., Gerling, J., Landwehrmeyer, B. & Jung, R. (1991) Changes of slow cortical negative DC-potentials during the acquisition of a complex finger motor task. *Experimental Brain Research*, 85, 417-422.
- Okano, K. & Tanji, J. (1987) Neuronal activities in the primate motor fields of the agranular frontal cortex preceding visually triggered and self-paced movement. *Experimental Brain Research*, 66, 155-166.
- Paré, M. & Munoz, D.P. (1996) Saccadic reaction time in the monkey: advanced preparation of oculomotor programs is primarily responsible for express saccade occurrence. *Journal of Neurophysiology*, 76,3666-3681.
- Riehle, A., Requin, J. (1993). The predictive value for performance speed of preparatory changes in neuronal activity of the monkey motor and premotor cortex. *Behavioral Brain Research*, 53, 35-49.

- Schall, J.D. (1991) Neuronal activity related to visually guided saccades in the frontal eye fields of rhesus monkeys: Comparison with supplementary eye fields. *Journal of Neurophysiology*, 66:559-579.
- Schiller, P.H. & Chou, I. (1998) The effects of frontal eye field and dorsomedial frontal cortex lesions on visually guided eye movements. *Nature Neuroscience*, 1,248-253.
- Schlag, J., & Schlag-Rey, M. (1987) Evidence for a supplementary eye field. *Journal of Neurophysiology*, 57, 179-200.
- Schultz, W. (1998). Predictive reward signal of dopamine neurons. *Journal of Neurophysiology*, 80, 1-27.
- Shen, L. & Alexander, G.E. (1997). Preferential representation of instructed target location versus limb trajectory in dorsal premotor area. *Journal of Neurophysiology*, 77,1195-1212.
- Shibasaki, H., Barrett, G., Halliday, E. & Halliday, A.M. (1980) Components of the movement-related cortical potential and their scalp topography. *Electroencephalography and clinical neurophysiology*, 49, 213-226.
- Shidara, M., Aigner, T.G. & Richmond, B.J. (1998). Neuronal signals in the monkey ventral striatum related to progress through a predictable series of trials. *Journal of Neuroscience*, 18,2613-2625.
- Sommer, M.A. & Tehovnik, E.J. (1998). Reversible inactivation of macaque dorsomedial frontal cortex. *Experimental Brain Research*, in press.
- Tanji, J. & Evarts, E.V. (1976). Anticipatory activity of motor cortex neurons in relation to direction of an intended movement. *Journal of Neurophysiology*, 39,1062-1068.
- Tremblay, L., Hollerman, J.R. & Schultz, W. (1998). Modifications of reward expectation-related neuronal activity during learning in primate striatum. *Journal of Neurophysiology*, 80, 964-977.

Figure 1

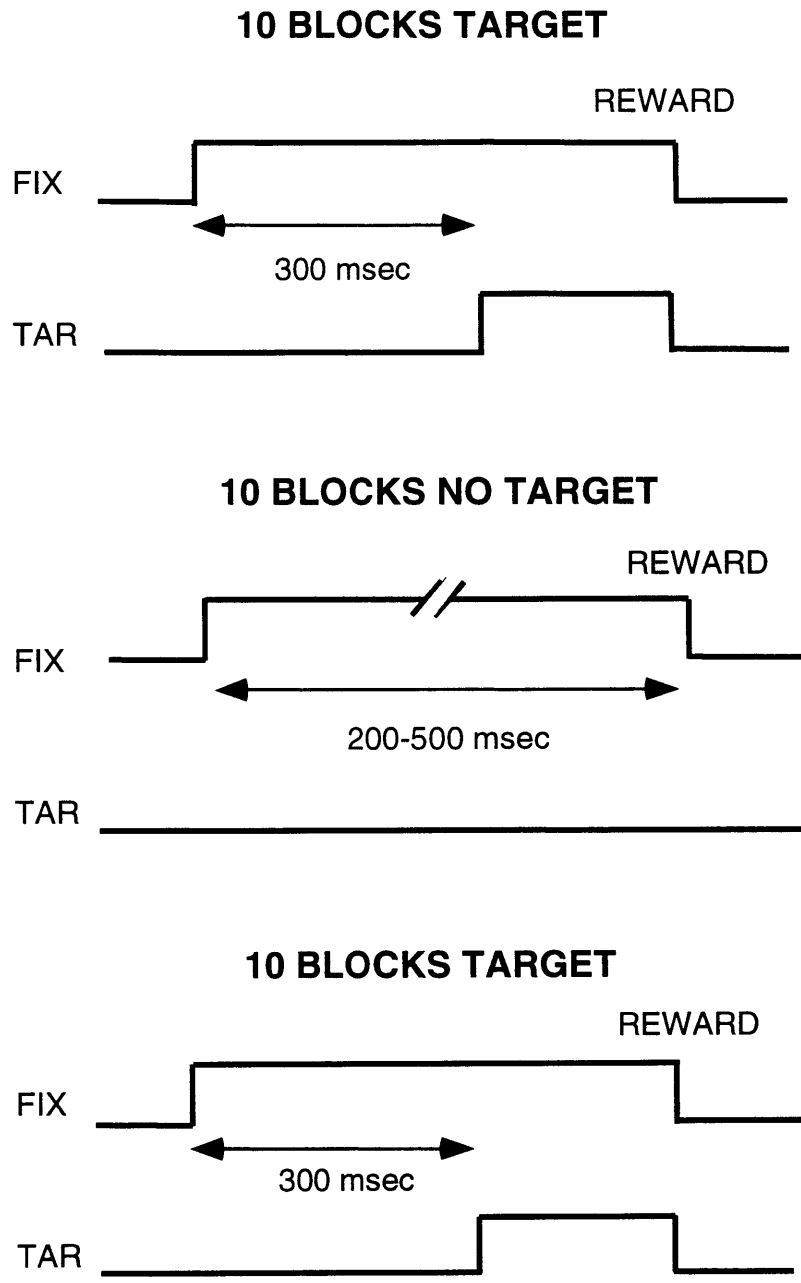

Figure 2

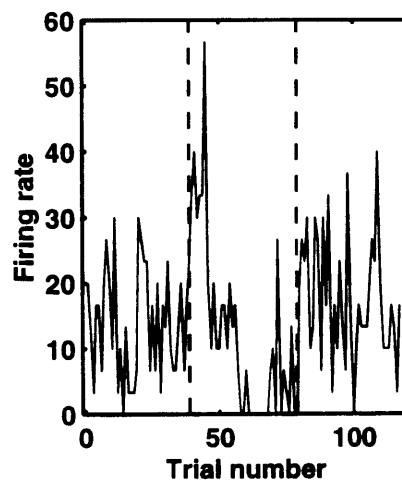
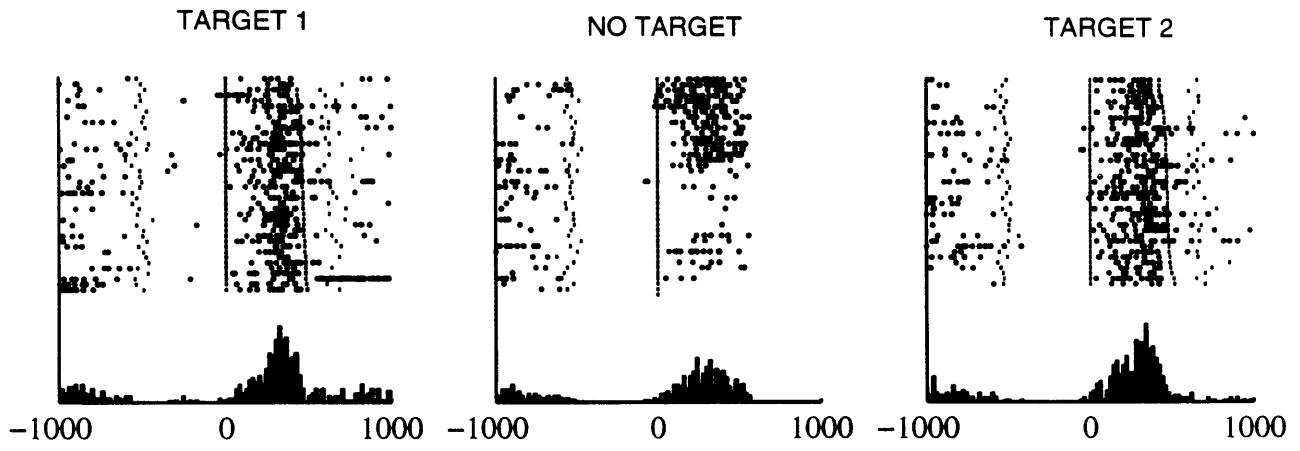

Figure 3

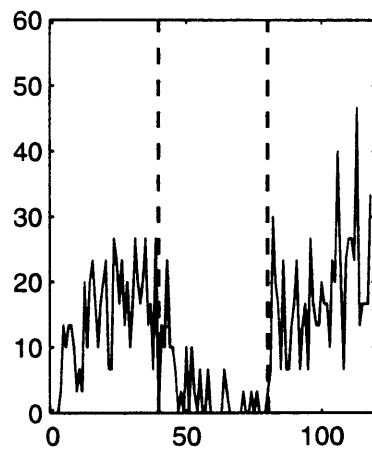
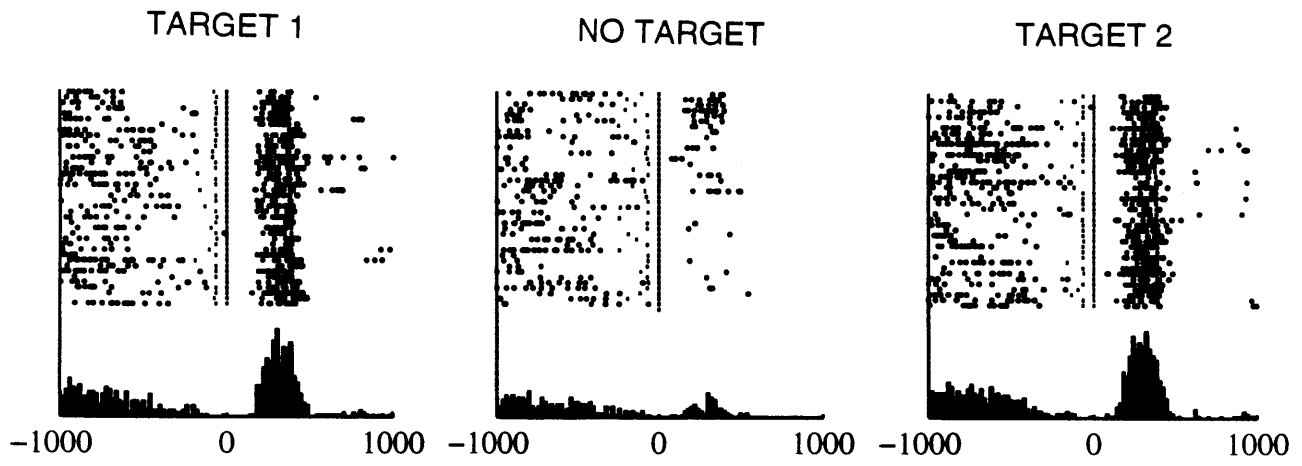
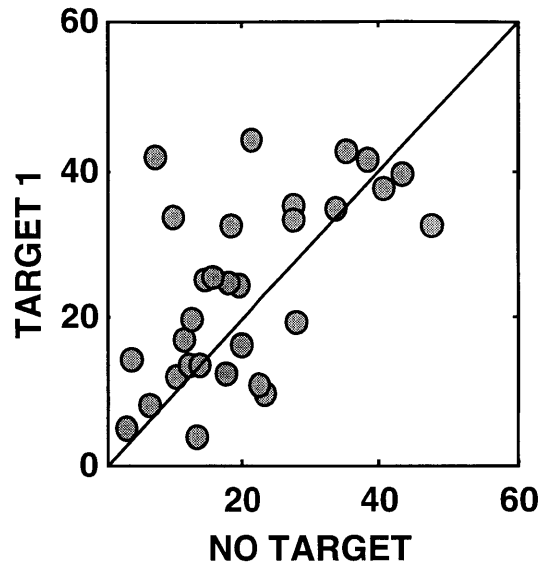
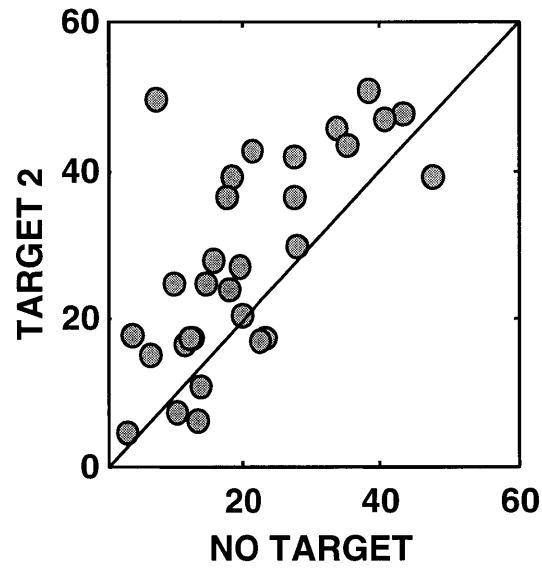

Figure 4

A



B



C

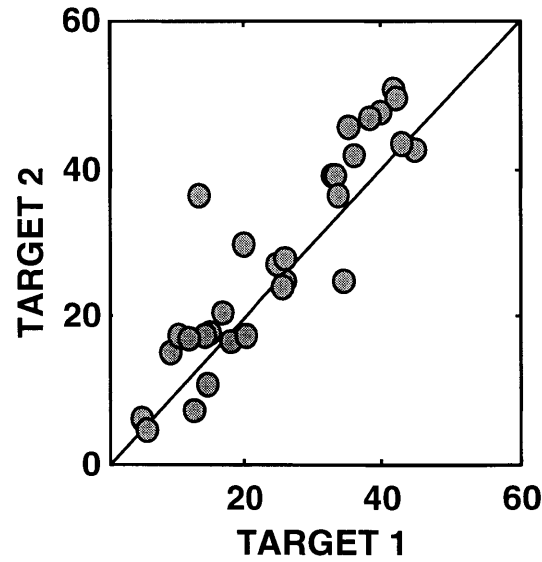

Figure 5

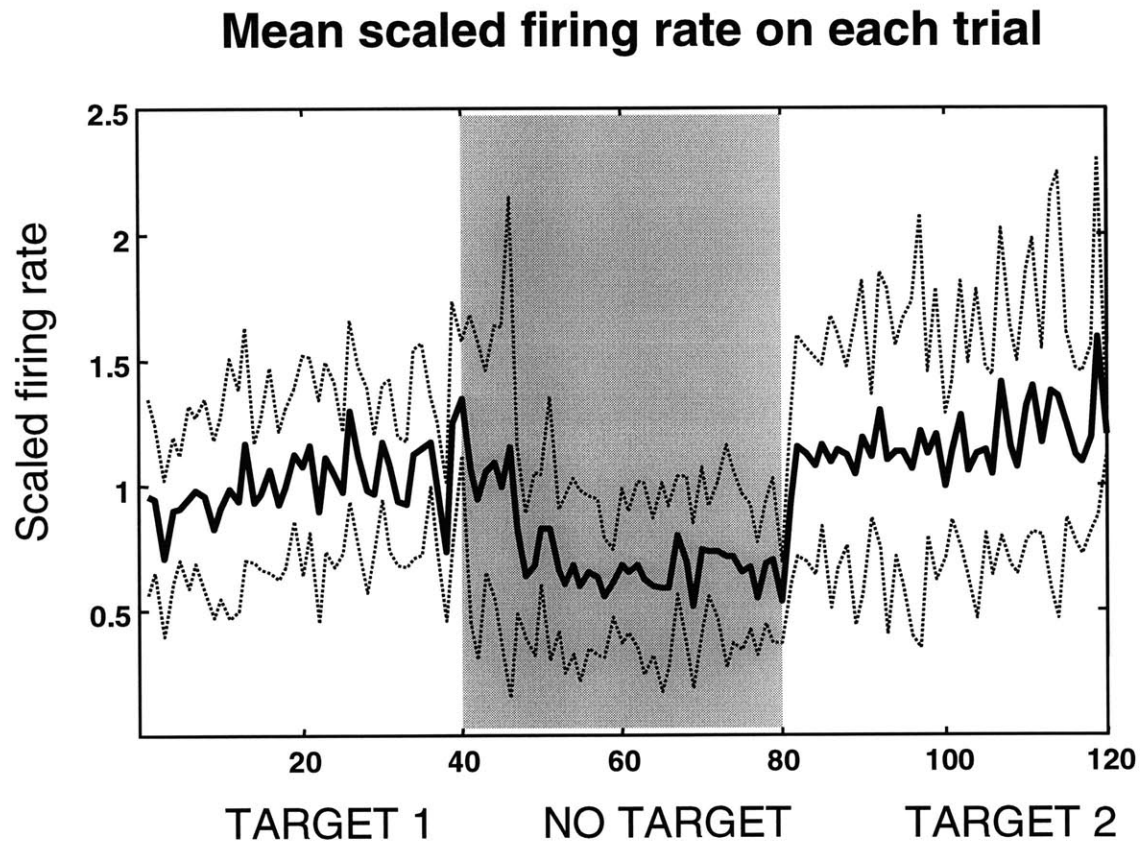
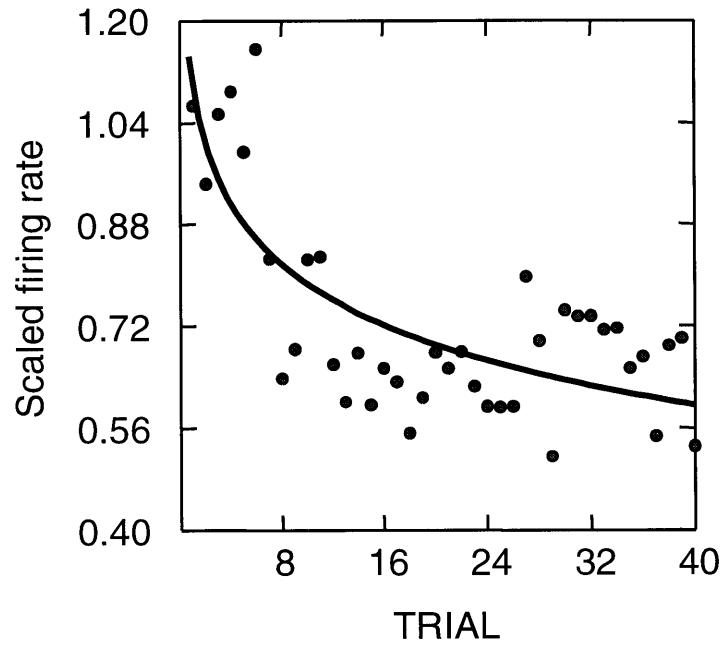



Figure 6

### NO TARGET



### TARGET 2

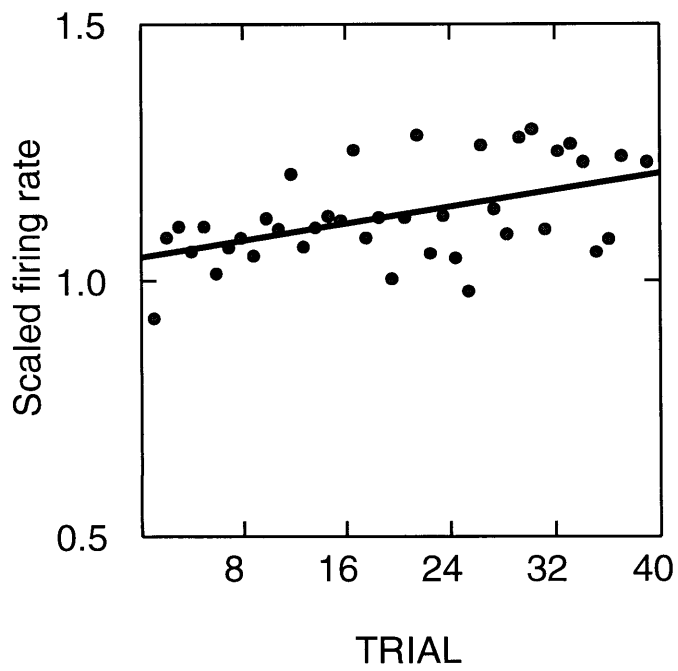
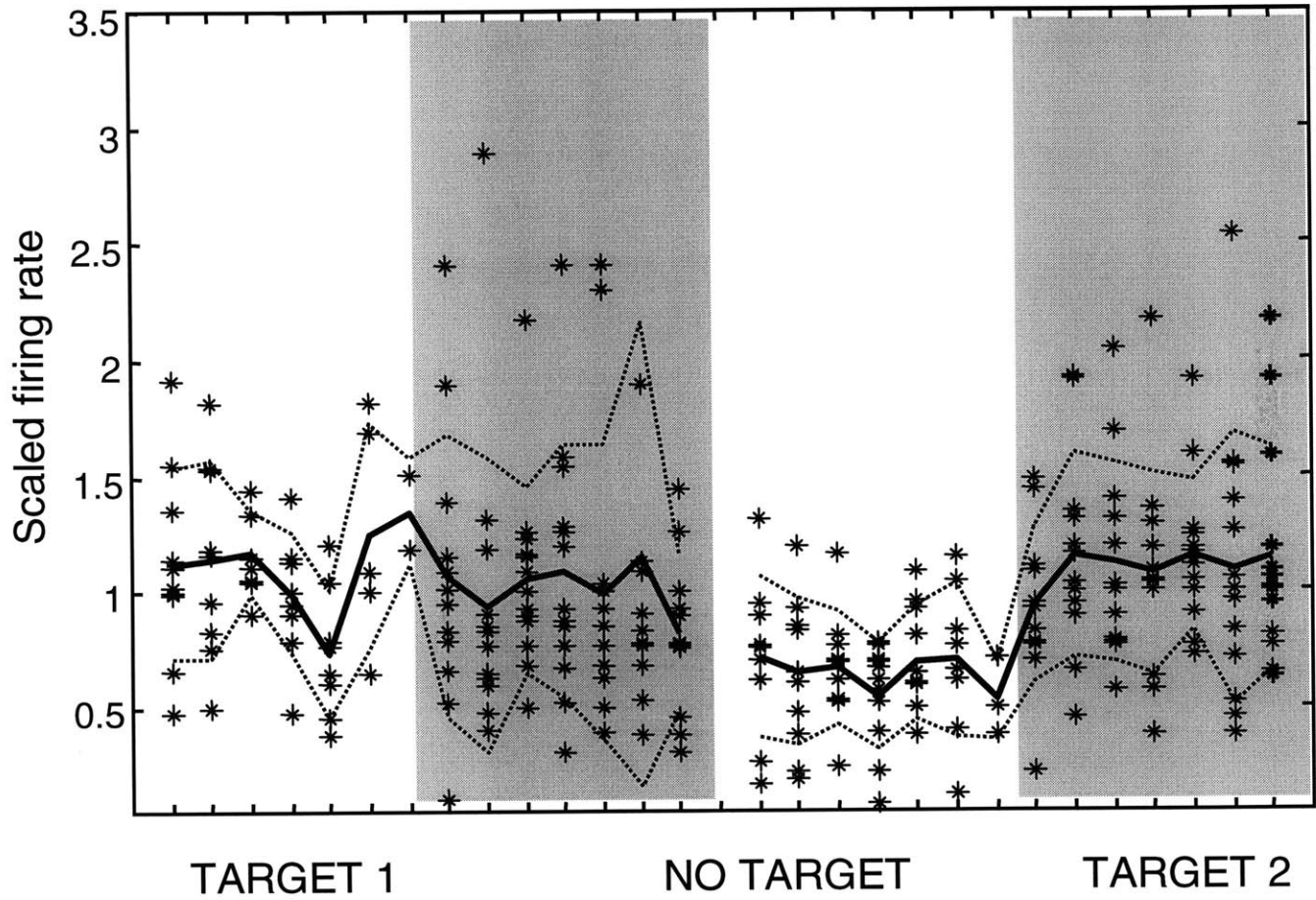

Figure 7

### Transition of mean firing rate



## Summary and conclusions

In this thesis, the properties of neurons in dorsomedial frontal cortex were examined with respect to eye and arm movement control. Three major contributions were made towards our understanding of the functional organization of this area.

First, it was revealed that over half of movement-related neurons were responsive to both eye and arm movements, with the others preferring either eye or arm movements. Many neurons were not directionally tuned, but those that were did tend to show the same preferred direction for both, suggesting that this may represent a common encoding for movements by either effector. Examination of the temporal properties of the neurons showed that, consistent with other studies, many neurons began to discharge early before movement initiation. In this study, neurons were observed which began discharging well before the target was presented, thus the direction of the upcoming movement was not specified. Some neurons showed an anticipatory build up before either eye or arm movements, suggesting that this signal may be related to anticipation of movement regardless of the effector.

Second, there was no clear segregation in terms of location of the different kinds of neurons; rather, the different neurons were intermingled. When the recording locations were compared to the somatotopy as revealed by microstimulation, it was found that most of the neurons were located in the rostral dorsomedial frontal cortex, within the region from which eye movements were evoked. This is a clear demonstration that arm-movement responses are present within the area traditionally considered to be related to saccades. Task-related neurons were rarely observed in the area from which arm movements were evoked.

Third, the anticipatory activity observed in many neurons was found to be related to the expectation that the movement was to occur. Monkeys were run on a series of trials in which the target occurred at a predictable time, and then on a block where the target was not presented. For the majority of neurons, the anticipatory activity was attenuated, or even absent during the block of trials when no target was presented. When another block of trials was run in which the target was once again presented, the anticipatory activity resumed. Many of the neurons showed higher levels of activity during the first few trials after the transition from one block to the other. This suggests that in addition to signalling the monkeys expectation to move, these neurons signal a change in movement strategy, or perhaps are encoding an error signal between the expected and observed trial events.

Thus many neurons in the eye movement representation of DMFC participate in the generation of both eye and arm movements, rather than being specific for one or the other. Interaction between eye position and arm movements has been reported in a variety of areas, such as ventral premotor cortex (Stuphorn et al., 1996; Mushiake et al., 1997), superior colliculus (Stuphorn et al., 1996), and parietal cortex (Ferraina et al., 1997). In each of these areas, the interaction was best characterized by a modulation of arm-movement response by gaze angle, suggesting that these areas are directly involved in computation of movement parameters in a coordinate frame that combines eye and arm position signals. The relative lack of directionally tuned neurons observed in DMFC neurons suggests that it may play a different role. The preponderance of anticipatory

activity suggests that it may be more related to the temporal initiation of movement rather than specification of parameters.

A relatively small percentage of neurons encountered in the course of recording were found to be modulated by the tasks employed in these experiments. This may have been a consequence of the complexity and training experience of the animals. There is an increasing body of literature suggesting that activity in the dorsomedial frontal cortex is modulated by learning. Human imaging and recording studies have revealed greater activation during the learning of difficult tasks (e.g. Lang et al., 1983; Niemann et al., 1991; Kawashima et al., 1998; Hikosaka et al., 1996), and it has been shown that the organization and representation of movements is dynamic and subject to experience (Pascual-Leone et al., 1994; Karni et al., 1995). During learning, the area of activated cortex within DMFC increases. Studies in monkeys also have reported that field potentials are greater during learning (Sasaki & Gemba, 1982) and that many neurons are active only during the learning of a task or skill (e.g. Aizawa et al., 1991; Chen & Wise, 1995; Nakamura et al., 1998). Given that the monkeys in this study were well trained on the tasks before recording began, this may be one explanation for seeing relatively few modulated neurons.

In conclusion, most movement-related neurons in DMFC participate in the generation of both eye and arm movements. Rather than specifying the direction of the movement, many neurons seem more involved in anticipating the movement, and their activity is modulated by expectation. Some neurons respond to a change in task conditions by discharging at a higher rate, which may be indicative of the role this area plays in motor learning.

## References:

- Aizawa, H., Inase, M., Mushiake, H., Shima, K. & Tanji, J. (1991). Reorganization of activity in the supplementary motor area associated with motor learning and functional recovery. *Experimental Brain Research*, 84, 668-671.
- Chen, L.L & Wise, S.P. (1995) Neuronal activity in the supplementary eye field during acquisition of conditional oculomotor associations. *Journal of Neurophysiology*, 73, 1101-1121.
- Ferraina, S., Johnson, P.B., Garasto, M.R., Battaglia-Mayer, A., Ercolani, L., Bianchi, L., Lacquaniti, F. & Caminiti, R. (1997). Combination of hand and gaze signals during reaching: activity in parietal area 7m of the monkey.
- Hikosaka, O., Sakai, K., Miyachi, S., Takino, R., Sasaki, Y. & Pütz, B. (1996). Activation of human presupplementary motor area in learning of sequential procedures: a functional MRI study. *Journal of Neurophysiology*, 76, 617-621.
- Karni, A., Meyer, G., Jezzard, P., Adams, M.M., Turner, R., & Ungerleider, L.G. (1995). Functional MRI evidence for adult motor cortex plasticity during motor skill learning. *Nature*, 377:6545, 155-8.
- Kawashima, R., Tanji, J., Okada, K., Sugiura M., Sato, K., Kinomura, S., Inoue, K., Ogawa, A., & Fukuda, H. (1998). Oculomotor sequence learning: a positron emission tomography study. *Experimental Brain Research*, 122, 1-8.
- Lang, M., Kornhuber, A., Deecke, L. & Kornhuber, H.H. (1983). Human cerebral potentials and visuomotor learning. *European Journal of Physiology*, 399, 342-344.
- Mushiake, H., Tanatsugu, Y. & Tanji, J. (1997). Neuronal reach activity in the ventral part of premotor cortex during target-reach movement is modulated by direction of gaze. *Journal of Neurophysiology*, 78,567-571.
- Nakamura, K., Sakai, K. & Hikosaka, O. (1998). Neuronal activity in medial frontal cortex during learning of sequential procedures. *Journal of Neurophysiology*, 80,2671-2687.
- Niemann, J., Winker, T., Gerling, J., Landwehrmeyer, B. & Jung, R. (1991) Changes of slow cortical negative DC-potentials during the acquisition of a complex finger motor task. *Experimental Brain Research*, 85, 417-422.

- Pascual Leone, A., Grafman, J., & Hallett, M. (1994). Modulation of cortical motor output maps during development of implicit and explicit knowledge. *Science*, 263:5151, 1287-9
- Sasaki, K. & Gemba, H. (1982). Development and change of cortical field potentials during learning processes of visually initiated hand movements in monkey, *Experimental Brain Research*, 48, 429-437.
- Stuphorn, V., Bauswein, E. & Hoffman, K-P. (1996). Cortico-collicular control of arm movements. In: *Neural Bases of Motor Behaviour*, F.Lacquaniti & P. Viviani (Eds), 185-204. Kluwer Academic Publishers: Netherlands.

## **Appendix: Stimulation mapping in Monkey J**

### **Methods:**

Electrode penetrations were made at 1 mm intervals into a 12 x 4 mm area of dorsomedial frontal cortex. The area sampled not only encompassed the recording sites but also extended several millimeters in each direction beyond the region where modulated units were found. . At each site, the effects of low current microstimulation were examined. Trains of 0.2 msec biphasic pulses at a frequency of 250 Hz were applied through glass-coated platinum-iridium electrodes (0.5-2.0M $\Omega$  impedance measured at 1kHz). Current level was kept constant at 50  $\mu$ A and train duration was varied from 50-200msec. The same stimulation parameters were applied throughout the cortex.

Microstimulation was performed both while the animal was sitting quietly in the dark between trials, and also when the monkey was actively performing a fixation task. Eye movements were monitored for stimulation-evoked effects and the monkey was also observed for skeletomotor movements. Eye traces in both stimulation and control trials were saved for off-line analysis. In cases where skeletomotor movements were evoked, the locus of stimulation-evoked movement was confirmed by palpating the recruited muscles. Also, the monkey was observed and the locus of the movement confirmed by a second observer, when possible. Because it has been reported that active fixation can raise the current threshold required to elicit eye movements from oculomotor structures (Tehovnik et al., 1998; Sparks & Mays, 1983; Goldberg & Bruce, 1985; Schlag & Schlag-Rey, 1987) we used a behavioral paradigm that was both permissive for eliciting stimulation-evoked eye movements and also maintained control over starting eye position. The monkey was required to fixate an LED for 200 msec to receive a juice



reward, and the stimulation train was applied immediately after the fixation light was extinguished, during the presentation of the juice reward. Examination of the intersaccadic intervals for spontaneous eye movements made in non-stimulation trials revealed that the animal generally did not make spontaneous saccades during the time window in which stimulation would be applied. Therefore, we stimulated during a period of time when the monkey's eyes were reliably within the fixation window, but the animal was not actively suppressing saccades. Once a site had been identified to have eye-movement-related properties, we also tested the effects of initial eye position on the evoked saccade by having varying the location of the fixation LED.

For both skeletomotor and eye movements, site was considered to have stimulation-evoked properties if movements could be evoked >50% of the time using the stimulation parameters described above.

## **Results:**

Movements were evoked with the microstimulation parameters described above in 31/50 penetrations.

Figure 1 shows the locations of microstimulation electrode penetrations and the type of movements evoked at those sites. At some sites, the locus of the evoked movement appeared to change slightly with the depth of the stimulating electrode; for the purposes of creating Figure 1, I took the movement evoked from 1-1.5 mm below the first encountered unit in along the penetration, corresponding roughly to the depth from which most task-related units were recorded.

There appeared to exist a rough somatotopy comparable to that observed in numerous other studies (e.g. Luppino et al., 1990, Mitz & Wise, 1987; Schall, 1991) and also similar to that seen in human subjects (Lim et al., 1994). At the caudal extreme of the region of cortex we tested, trunk and hindlimb movements were evoked. At the other end, the most rostral extent we tested, most of the responses we observed were eye movements. At intermediate penetrations, proximal forelimb and head (neck or pinna) movements were evoked. At all sites where skeletomotor movements were evoked, movements in the form of muscle twitches could be observed at the shortest train duration used (50 msec). At some sites, prolonged stimulation seemed to increase only the duration of the muscle contraction. At other sites, it appeared that more muscles were being recruited with prolonged stimulation. For example, stimulation at a site might elicit a muscle twitch in the deltoid with a 50 msec train but with a 100 or 200 msec train, other arm muscles such as the triceps appeared to be recruited as well, leading to a lifting of the entire arm. It has been postulated that prolonged stimulation at these parameters may lead to transynaptic spread of current. Therefore these differences in muscle recruitment with long train duration may reflect differences in projection patterns to cortical and motoneuronal pools at these sites.

Stimulation of a 5x3 mm area in the rostral medial frontal cortex yielded almost exclusively saccadic eye movements. This area corresponds roughly both in size and relative location to the description of the supplementary eye fields as given by Schlag & Schlag-Rey, (1987).

Insert Figure 1 about here

Figure 2 shows typical eye movements evoked from different starting positions from one site. The probability of evoking an eye movement was greater when the eye was initially in the contralateral visual hemifield, consistent with other studies (Tehovnik & Lee, 1992; Russo & Bruce, 1993). It can also be seen that the direction and amplitude of the saccades vary with starting eye position. It has been shown by several researchers that converging, or goal-directed saccades are evoked by microstimulation of SEF (Schlag & Schlag-Rey 1987; Mann et al., 1988; Schall, 1991a; Tehovnik & Lee, 1993; Sommer & Tehovnik, 1998), while other research groups have failed to make this observation (Russo & Bruce, 1993). It has been proposed that the degree of convergence depends on the amplitude of the saccades (reviewed in Schall, 1998) and amplitude can be related the train duration (Tehovnik & Sommer, 1997). I did not systematically test the effects of long versus short trains on amplitude or degree of convergence, but I did observe that long stimulation trains resulted in the eyes remaining at the endpoint of the evoked saccade. This was the case in the majority (20/21) of sites from which eye movements were evoked. This effect has been reported consistently and appears to be a distinguishing feature of SEF stimulation (Schall, 1991; Tehovnik & Lee, 1993) At one site, staircase saccades (i.e. a sequence of saccades of the same vector) were evoked with long train duration, comparable to those observed during frontal eye field (Robinson & Fuchs, 1969) or superior colliculus (Schiller & Stryker, 1970). However, the amplitudes of each evoked saccade in this case (approximately 2 degrees) were much smaller than that observed from the majority of the sites.

I did not observe smooth eye movements elicited from any of the sites tested. It has been reported that pursuit movements can be altered or disrupted by electrical

stimulation of SEF (Heinen, 1996) However, in that study, the monkeys were always performing smooth pursuit tasks during stimulation. Thus the pursuit system was already engaged before stimulation, which may be a necessary condition for revealing the involvement of this cortical area with stimulation.

Insert Figure 2 about here

## Figure legends

### Figure 1:

Map of location of penetrations where stimulation was evoked. X's show sites where no movements were evoked.

### Figure 2:

Representative eye movement traces showing stimulation-evoked saccades from one site in Monkey J. Stimulation was applied during trials randomly intermixed among control trials. 15 different starting eye positions were tested at this site; the results from only 9 are shown here for clarity. Empty squares show starting positions from which stimulation-evoked eye movements were not evoked.

## References:

- Bruce, C.J., Goldberg, M.E., Bushnell, M.C. & Stanton, G.B. (1985). Primate frontal eye fields. II. Physiological and anatomic correlates of electrically evoked eye movements. *Journal of Neurophysiology*, 54, 714-734.
- Goldberg, M.E., Bushnell, M.C., & Bruce, C.J. (1986) The effect of attentive fixation on eye movements evoked by electrical stimulation of the frontal eye fields. *Experimental Brain Research*, 61, 579-584
- Schiller, P.H. & Stryker, M. (1972). Single-unit recording and stimulation in superior colliculus of the alert rhesus monkey. *Journal of Neurophysiology*, 35, 915-924.
- Heinen, S. J (1996). Microstimulation in dorsomedial frontal cortex affects smooth pursuit movements. *Society for Neuroscience Abstracts*.
- Lim, S.H., Diner, D.S., Pillay, P.K., Lüders, H., Morris, H.H., Klem, G., Wyllie & Awad, I.A. (1994). Functional anatomy of the human supplementary sensorimotor area: results of extraoperative electrical stimulation. *Electroencephalography and clinical Neurophysiology*, 91, 179-193.
- Luppino, G., Matelli, M., Camarda, R.M., Gallese, V. & Rizzolatti, G. (1991) Multiple representations of body movements in mesial area 6 and the adjacent cingulate cortex: An intracortical microstimulation study in the macaque. *Journal of Comparative Neurology*, 311, 463-482.
- Mann, S.E., Thau, R. & Schiller, P.H. (1988) Conditional task-related responses in monkey dorsomedial frontal cortex. *Experimental Brain Research*, 69, 460-468.
- Mitz, A.R. & Wise, S.P. (1987), The somatotopic organization of the supplementary motor area: intracortical microstimulation mapping. *Journal of Neuroscience*, 7, 1010-21.
- Robinson, D.A. & Fuchs, A.F. (1969) Eye movements evoked by stimulation of frontal eye fields. *Journal of Neurophysiology*, 32, 637-648.

- Russo, G.S., & Bruce, C.J. (1993) Effect of eye position with the orbit on electrically elicited saccadic eye movements: A comparison of the macaque monkey's frontal and supplementary eye field. *Journal of Neurophysiology*, 69, 800-818.
- Schall, J.D. (1991b) Neuronal activity related to visually guided saccades in the frontal eye fields of rhesus monkeys: Comparison with supplementary eye fields. *Journal of Neurophysiology*, 66:559-579.
- Schlag, J. & Schlag-Rey, M. (1987) Evidence for a supplementary eye field. *Journal of Neurophysiology*, 57, 179-200.
- Sommer, M.A. & Tehovnik, E.J. (1998). Reversible inactivation of macaque dorsomedial frontal cortex. *Experimental Brain Research*, in press.
- Sparks, D.L. & Mays, L.E. (1983). Spatial localization of saccade targets. I. Compensation for stimulation-induced perturbations in eye position. *Journal of Neurophysiology*, 49, 45-63.
- Tehovnik, E.J. & Lee, K-M. (1993) The dorsomedial frontal cortex of the rhesus monkey: topographic representation of saccades evoked by electrical stimulation. *Experimental Brain Research*, 96, 430-442.
- Tehovnik, E.J. & Sommer, M.A. (1997). Electrically evoked saccades from the dorsomedial frontal cortex and frontal eye fields: a parametric evaluation reveals differences between areas, *Experimental Brain Research*, 117, 368-378.
- Tehovnik, E.J., Slocum, W.M. & Schiller, P.H. (1998). Behavioral conditions affect saccadic eye movements elicited from the dorsomedial frontal cortex and frontal eye fields. *Society for Neuroscience Abstract*

Figure 1

### Location of stimulation penetrations

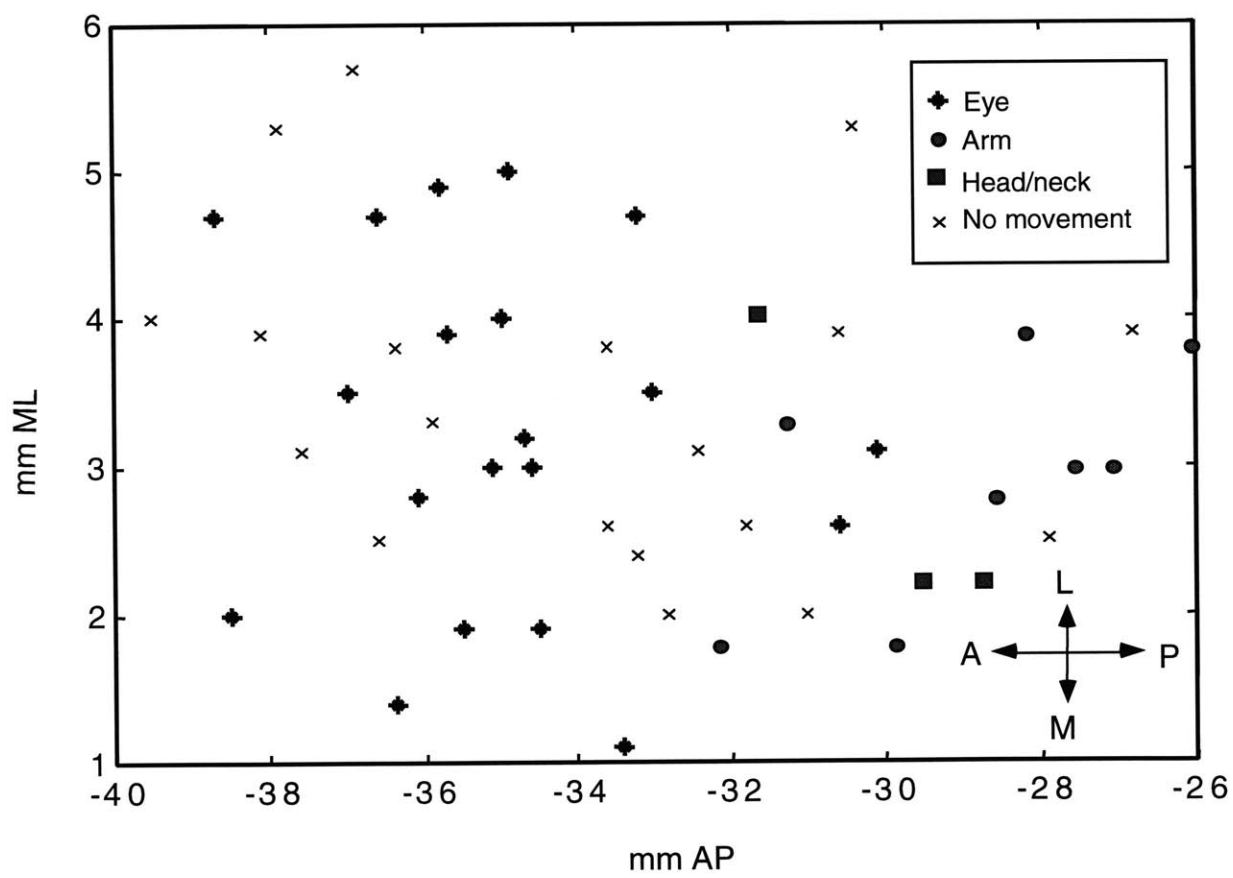



Figure 2

