

A Cost-Effective Portable Telemedicine Kit for Use in Developing Countries

by

Ari T. Adler

B.S., Physics
Brandeis University, 1996

Submitted to the Department of Mechanical Engineering
In Partial Fulfillment of the Requirements for the Degree of
Master of Science in Mechanical Engineering

at the
Massachusetts Institute of Technology

May 2000

June 2000

© 2000 Massachusetts Institute of Technology
All rights reserved

Signature of Author.....
Department of Mechanical Engineering
May 19, 2000

Certified by.....
Joseph A. Paradiso
Principal Research Scientist, Media Laboratory
Thesis Supervisor

Certified by.....
Woodie C. Flowers
Professor, Department of Mechanical Engineering
Thesis Reader

Accepted by.....
Ain A. Sonin
Chairman, Department Committee on Graduate Students

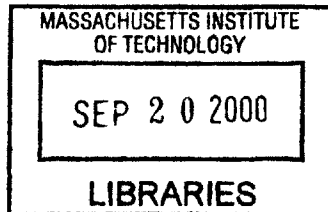

ENG



A Cost-Effective Portable Telemedicine Kit for Use in Developing Countries

by

Ari T. Adler

Submitted to the Department of Mechanical Engineering on May 19, 2000, in partial fulfillment of the requirements for the Degree of Master of Science in Mechanical Engineering

Abstract

Telemedicine is currently being used to bridge the physical distance between patients in remote areas and medical specialists around the world. Developing countries have had little experience or success with telemedicine, in part because of the prohibitively expensive equipment and connectivity costs involved. Developing countries require low-cost, sustainable telemedicine solutions for the local delivery of primary healthcare and efficient access to medical expertise when needed. A low-cost (approximately \$8,000 in small quantities) portable telemedicine kit was designed and built to address these needs. The kit was developed as part of the Little Intelligent Communities (LINCOS) project, which is bringing satellite telecommunications, education and telemedicine services to underserved areas of Latin America and the Caribbean. This is accomplished through the use of modified ISO shipping containers that become 'digital town centers.'

The telemedicine kit consists of a durable case that houses a portable computer and several medical peripherals: a digital stethoscope, an ECG recorder and a medical imaging system. The kit allows a health practitioner in a remote area to capture patient data in the form of audio, video, and images in an asynchronous fashion and forward them over the Internet to a doctor for a diagnosis.

This document addresses various aspects related to the implementation of a low cost telemedicine kit. It also explores some of the technologies that will enable the creation of new types of telemedicine devices in the future, not only for remote diagnostic applications, but also for home health monitoring. A wireless transceiver board was also designed and built so that it could be embedded into consumer medical and electronic devices in a general fashion. It allows the devices to communicate wirelessly with a base station either for home health monitoring applications, or for a cordless version of the portable telemedicine kit.

Thesis Supervisor: Joseph A. Paradiso

Title: Principal Research Scientist, MIT Media Laboratory

Acknowledgements

First, I would like to thank my advisor **Joe Paradiso**, who in addition to offering me a great amount of help, encouragement and advice over the past two years has also been a great person to work for.

I would also like to thank **Woodie Flowers**, my departmental thesis reader, for spending the time advising me and always giving me interesting things to think about.

I would like to acknowledge and thank **Nisha Checka**, who worked endless hours with me on this project as a UROP. She has made significant contributions to the research described in this thesis.

I would like to thank **Leslie Regan** in the M.E. department for all of her help and administrative advice over the past two years.

I would also like to thank **Sandy Pentland** and **José María Figueres** for promoting my involvement, and always keeping me enthusiastic about the LINCOS project.

I thank **Glenn Vonk** at Becton-Dickinson and **Jim Sheats** at Hewlett-Packard for providing medical devices and computing equipment for my research.

I would like to thank **David Boor** and **IBM** for sponsoring me through the IBM Media Lab fellowship.

I thank **Juan Barrios**, director of the LINCOS project for all of his help, advice and friendship over the past two years. It has been a pleasure working with him.

I would like to acknowledge **Alejandro Valerio**, **Don Armando Bonilla**, **Franklin Hernandez** and **students** from the TEC for the many contributions that they made to this project including the software, electronics and graphical design for the telemedicine kit.

I would like to thank my office-mates **Ari Benbasat** and **Ara Knaian** for their company, and their expert help and advice about pretty much anything. I have tremendous respect for both of them.

I also thank the other members of the **Responsive Environments Group**, and my friends and colleagues at the **Media Lab** and **MIT** for making my experience stimulating and rewarding.

Finally, I would like to thank **Melissa** for her encouragement and understanding, and my **family** for all of their love and support.

Contents

Abstract	3
Acknowledgements	5
Contents	7
List of Figures	9
Glossary of Terms and Acronyms	11
Overview	13
1. Introduction	15
1.1 Definition of Telemedicine.....	15
1.2 Telemedicine Systems in the Industrialized World.....	16
1.3 Telemedicine in Developing Countries.....	19
1.4 The LINCOS Project	20
2. The Design of the LINCOS Units	21
2.1 The Physical Construction of the LINCOS Units.....	22
2.2 Internet Connectivity for the LINCOS Units.....	25
2.3 The Computer Laboratory.....	27
2.4 The Information Center	28
2.5 The Telemedicine Center.....	29
3. The Prototype Telemedicine Kit	31
3.1 Specifications of the Telemedicine Kit	33
3.2 The Peripheral Medical Devices	34
3.3 Electronics and Power for the Telemedicine System.....	41
3.4 Software Interface for the Telemedicine System	41
4. Important Factors in the Development of the Telemedicine System	45
4.1 Quality of the Data Captured	45
4.2 Real-Time Vs. Store-and-Forward Methods of Telemedicine	47
4.3 Medical Approval for Peripheral Devices	51
5. Telemedicine in the Future	53
5.1 Technological Advances	54
5.2 Home Health Monitoring	60
5.3 Wireless Transduction from Medical Devices	61

6. Conclusions	67
6.1 Summary	67
6.2 The Future	69
Appendix A: Telemedicine Kit Electronics	71
A.1 Signal Diagram	71
A.2 Power Diagram	72
A.3 Stethoscope Amplifier Circuit	72
Appendix B: Telemedicine Kit Software	73
Appendix C: Wireless Board Electronics	75
C.1 Schematic	75
C.2 PCB Front	76
C.3 PCB Back	77
Appendix D: Wireless Telemedicine Software	79
D.1 Transmitter PIC Code	79
D.2 Receiver PIC Code	83
D.3 Base Station C Code	85
Appendix E: Component Specifications	87
E.1 AMD 2500 General Examination Camera	87
Related Internet Links	93
Telemedicine	93
Commercial	93
Research	93
Bibliography	95

List of Figures

Figure 1: High-End Telemedicine System	17
Figure 2: NASA Telemedicine Kit	18
Figure 3: LINCOS Digital Town Center.....	21
Figure 4: LINCOS Container Layout.....	22
Figure 5: LIINCOS Container Plan View.....	23
Figure 6: ISO Container Being Transported	24
Figure 7: Canopy Model	25
Figure 8: LINCOS Computer Laboratory	27
Figure 9: LINCOS Information Center	28
Figure 10: Remote Weather Probe.....	29
Figure 11: LINCOS Water Testing Kit.....	30
Figure 12: Telemedicine Kit.....	31
Figure 13: Telemedicine Kit Control Panel	34
Figure 14: Telemedicine Kit Stethoscope	35
Figure 15: Stethos Frequency Response Chart.....	36
Figure 16: ECG Recorder.....	37
Figure 17: Sample ECG Data File	38
Figure 18: Polarized Image of the Eye Taken with Imaging System.....	39
Figure 19: <i>Star Trek</i> Tricorder	56
Figure 20: Wireless Telemedicine Concept.....	61
Figure 21: Wireless Transceiver Board	62
Figure 22: Transceiver Board in Scale	63
Figure 23: Wireless Scale.....	64

Glossary of Terms and Acronyms

AGC	Automatic Gain Control
CAD	Computer Aided Design
CCD	Charge Coupled Device
CMOS	Complementary Metal Oxide Semiconductor
CODEC	Coder-Decoder
CPR	Computerized Patient Record
CT	Computed Tomography
DSL	Digital Subscriber Line
E3	Everest Extreme Expedition
EMR	Electronic Medical Record
FDA	Food and Drug Administration
Frame Relay	A high-speed packet-switching protocol
I/O	Input/Output
IP	Internet Protocol
IR	Infrared
ISDN	Integrated Services Digital Network
ISO	International Organization for Standardization
ISP	Internet Service Provider
JPEG	Joint Photographic Experts Group
LCD	Liquid Crystal Display
MODEM	Modulator-Demodulator
MPEG	Moving Picture Experts Group
NASA	National Aeronautics and Space Administration
PCMCIA	Personal Computer Memory Card International Association
PDA	Personal Digital Assistant
PIC	Programmable Integrated Circuit
POTS	Plain Old Telephone Service
RF	Radio Frequency
RS-232	Interface Between Data Terminal Equipment and Data Communications Equipment Employing Serial Binary Data Interchange.
TLA	Three Letter Acronym
USB	Universal Serial Bus
VR	Virtual Reality
VSAT	Very Small Aperture Terminal

Overview

This master's thesis describes the research that I did at the MIT Media Laboratory to develop a low cost telemedicine kit for the Little Intelligent Communities (LINCOS) project, which consists of deploying information technology infrastructure into remote areas of developing countries by using recycled ISO shipping containers. Although the kit can be used as a general solution for bringing affordable telemedicine to developing countries, it will be described in this document primarily in the context of LINCOS because the telemedicine architecture was designed to work within the LINCOS framework. Additionally, I have been heavily involved with LINCOS since its launch in December of 1998 and was responsible for many of the decisions that created the framework for the telemedicine applications. In the course of this thesis, I will be addressing various aspects of diagnostic telemedicine, mostly related to the underlying technologies and their future possibilities rather than to the infrastructure, implementation and costing structure (which are all things that need to be addressed thoroughly in order for a telemedicine effort to have a chance of succeeding). This document was written assuming no prior familiarity with telemedicine and in general, technical terms are explicitly defined. I have also included a glossary of terms and acronyms at the beginning of this document for reference.

Below is a description of the major issues that each chapter addresses:

Chapter 1 introduces the concept of telemedicine and gives a background of some historical telemedicine projects in the developed world as well as a discussion of some of the efforts to create effective telemedicine programs in developing countries. The LINCOS project is also introduced as a partial solution to many of the problems that developing countries face today.

Chapter 2 explains the design of the LINCOS units in order to set a framework for the telemedicine application. The physical construction of the LINCOS units, their connectivity and each of the physical spaces (and their applications) are described in detail.

Chapter 3 describes four aspects of the development of the prototype telemedicine kit: specification selection, integrating the peripheral medical devices, building the electronics and power system and defining the software requirements.

Chapter 4 addresses some of the important factors considered during the development of the telemedicine system. Factors such as acceptable sound, image and video quality are investigated and a comparison is given between the store-and-forward and real-time method of telemedicine. The last section discusses the issues of FDA approval for medical devices and its implications for device use in developing countries.

Chapter 5 looks at telemedicine of the future in the context of the technologies that will enable the creation of a *TeleCorder*, which is a low cost, multi-diagnostic telemedicine and personal communications device that is inspired by the futuristic Tricorder from *Star Trek*. Relevant advances in the fields of computing, artificial intelligence, electronic medical records (EMRs), data compression, wireless communications and sensor technologies are discussed in this chapter. Also addressed is home telemedicine, which is recognized as one of the most effective ways of delivering health services to patients. The last section in this chapter describes a wireless application that was developed to demonstrate the feasibility of monitoring health at home in a pervasive and non-invasive manner.

Chapter 6 offers a summary and concluding remarks about the research that was done and the applications that were developed. Some issues that were not addressed in this thesis are described here in the context of future work.

1

Introduction

New technologies in sensing, medical imaging and wireless data communications are allowing telemedicine—the practice of healthcare at a distance—to be done at a much lower cost than in the past, enabling the development of new widespread remote medicine initiatives. These advances in technology have the potential to transform the way healthcare is provided throughout the world.

This chapter introduces the concept of telemedicine and gives a background of some historical telemedicine projects. We also introduce the LINCOS project, which will be described in detail throughout this document.

1.1 Definition of Telemedicine

Telemedicine means literally *medicine at a distance*. The concept has been described in many ways and in different contexts, but there has yet to be a universally accepted definition. The World Health Organization (WHO) for example, describes telemedicine as:

...the practice of medical care using interactive audiovisual and data communications including medical care delivery, diagnosis, consultation and treatment, as well as education and the transfer of medical data¹.

Another, future-oriented definition offered by Bauer and Ringel:

Telemedicine is the combined use of telecommunications and computer technologies to improve the efficiency and effectiveness of health care service by liberating caregivers from traditional constraints of place and time and by empowering consumers to make informed choices in a competitive marketplace [Bauer99, 8].

Many definitions such as the ones above have described this field, but it seems difficult—if not impossible—to adhere to any one of them because of the rapid

¹ Advisor on Informatics of the World Health Organization (WHO), 1997.

rate at which telemedicine is evolving. For the purposes of this document, we will use the general definition offered by Bashshur, Sanders and Shannon:

Broadly, telemedicine involves the use of modern information technology, especially two-way interactive audio and video telecommunications, computers and telemetry, to deliver health services to remote patients and to facilitate information exchange between primary care physicians and specialists at some distances from each other [Bashshur97, 9].

1.2 Telemedicine Systems in the Industrialized World

The industrialized countries of North America, Europe, Japan and Australia have a considerable amount of experience with telemedicine; it has been practiced in these countries to some degree for over 50 years. The Nebraska Psychiatric Institute for example, in 1959 was one of the first in the world to use a closed-circuit television link with the Norfolk Hospital 112 miles away. The link was used by doctors who consulted with each other on patient cases and also gave psychiatric consultations to patients on the other end of the link. Another significant early implementation of telemedicine was a microwave video link set up in April of 1968 between the Massachusetts General Hospital (MGH) and Boston's Logan airport. The link was established to provide immediate health services to airport employees and passengers. It eliminated the need to have physicians permanently assigned to the clinical facilities at the Airport, while avoiding the delays associated with patient transportation. Examinations at Logan included radiology, dermatology and cardiology [Bashshur75].

Telemedicine has advanced significantly in the developed world since then; it is now used in a wide variety of settings ranging from simple doctor-patient telephone and email consultations, to sophisticated Virtual Reality (VR) enhanced telesurgery. It is used in remote areas, correctional institutions, in the military and in space. The most common use of telemedicine is in areas where there are shortages of doctors and specialists that can diagnose specific medical conditions. For example, the patient in *Figure 1* is getting an ear examination by a general practice doctor and his assistant, while a live video stream of her inner ear is transmitted to a specialist across the country. Since it is inconvenient for

both the patient and the doctor to travel the distances required to see each other in person, videoconferencing technology is used to bridge the physical distance that exists between them.



Figure 1: High-End Telemedicine System

The National Aeronautics and Space Administration (NASA) has also been doing remote medical monitoring since the early manned missions and is currently developing advanced life support systems for the International Space Station [Studer99]. Because of the obvious shortage of medical specialists in space, NASA's Earth-based doctors rely heavily on the use of telemedicine to monitor astronaut's vital signs. The astronaut's telemetry can provide critical information to doctors on Earth in the event of a medical emergency in space. One of NASA's telemedicine instrumentation Packs (TIPs) is shown in *Figure 2 and is described below.*

Extended stays in orbit, such as those anticipated onboard the international space station, require a more sophisticated system for rapid diagnosis of illness. NASA has developed a suitcase-sized package, called the telemedicine instrumentation pack. It contains an endoscope, ophthalmoscope, dermatology macro-imaging lens, ECG, automatic blood pressure sensor, electronic stethoscope, pulse oximeter, and a computer with a two-way voice and video control. [Freiherr97].

Because of the time delay associated with communication between Earth and a manned mission to Mars for example, NASA has real challenges to develop intelligent telemedicine systems that can help astronauts make life saving decisions when they are millions of miles from the nearest doctor.

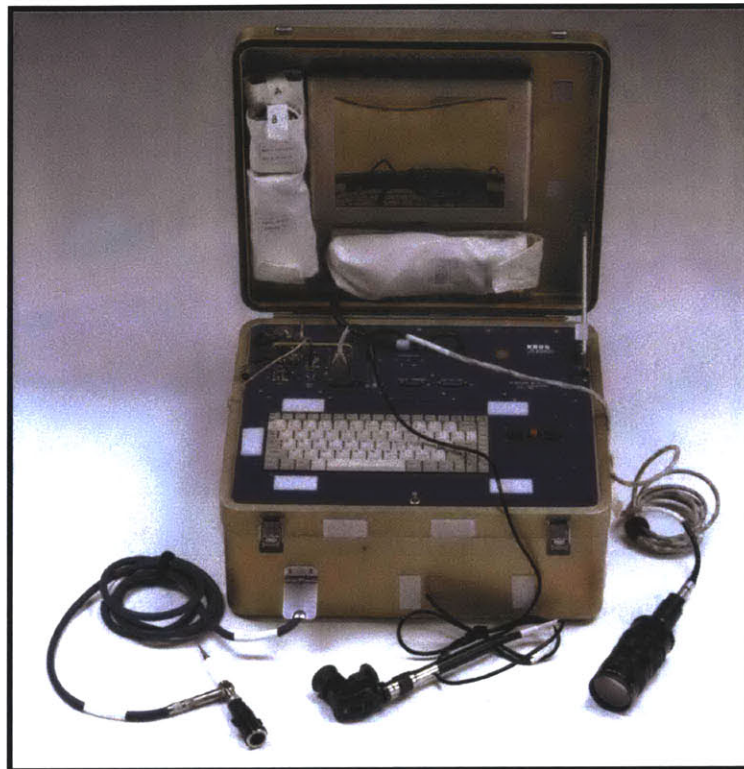

Figure 2: NASA Telemedicine Kit

Another groundbreaking use of telemedicine (in a completely different setting) occurred in 1998, when a team of researchers from Yale and MIT collaborated with several of their research sponsors on the *Everest Extreme Expedition* (E3) to monitor climber's physiological and performance parameters using 'bio-packs' as they scaled the highest mountain on Earth [Lau98]. The system used on Mount Everest provided audio and video communications to a medical unit at the base camp via satellite and to experts at MIT, Yale Medical and Walter Reed Army Hospital.

In the Industrialized world, doctor-to-doctor consults using telemedicine are becoming increasingly common, as are electronic consultations between doctors and patients by email and videoconference.

In general, the outlook for telemedicine in industrialized countries is good. There are hundreds of successful programs already in place, and many more pilot programs in development that have the potential to revolutionize the way healthcare is delivered, not only in remote areas, but also in the home. Home healthcare will be discussed further in *Chapter 5* which addresses the future of telemedicine.

1.3 Telemedicine in Developing Countries

The developing world has had relatively little experience or success with telemedicine. This is in part because of the high costs associated with Internet connectivity, high-end videoconferencing systems and sophisticated peripheral medical devices. Expensive technologies are simply out of the reach of health organizations in developing countries, which may have more immediate priorities (such as providing nutrition, sanitation and vaccinations to the population). To make things worse, developing countries have very high patients-per-doctor ratios, which are a general indicator of the amount of healthcare—or lack thereof—that exists in a region. As a point of comparison, industrialized countries such as the US have one doctor for every 200 to 500 people, while developing countries In East Africa have as little as one doctor for every 40,000 people [Wright97, 10]. “The state of health of a population is a direct determinant of its development, and investment in health is a prerequisite to economic and social progress [Wright97, 6].” Developing countries need low cost, sustainable solutions for the local delivery of primary healthcare and efficient access to medical expertise when needed.

Pilot programs in recent years have proposed introducing telemedicine technologies into rural communities at a much lower cost (and complexity) scale than has been attempted in the past, in order to deliver high quality medical care

to patients in rural areas of developing countries at affordable costs. The Little Intelligent Communities (LINCOS) project, which is described in the next section, is one effort that is attempting to accomplish this goal.

1.4 The LINCOS Project

The MIT Media Laboratory has been working with the Costa Rica Foundation for Sustainable Development and other educational institutions on the LINCOS project. The project's general goal is to quickly and efficiently bring high quality Internet connectivity, telecommunications, education, and telemedicine services into rural communities of developing countries: "The goals of the LINCOS project are to empower people and promote their well-being through the application of cost effective and available technologies within a framework of sustainable development²."

The Media Laboratory became involved in this project because of the opportunities to use it as a 'test bed' for many ongoing research projects that explore breakthroughs in communications, design, epistemology and learning, health, e-development and new technologies in general.

The services provided to the communities (public telephones, fax machines, access to the Internet, distance education and telemedicine) will share a common data connection to the outside world. By 'bundling up' the data in this fashion, the costs of connectivity can be shared, providing substantial savings over the alternatives³. These services are provided by introducing 'digital town centers' into the communities. The design and capabilities of these centers will be discussed further in the next chapter.

² José Maria Figueres (former President of Costa Rica), Things That Think consortia presentation at the MIT Media Lab, March 1999.

³ The alternative, more costly solution is for each service to be run independently from different locations with its own data link.

2

The Design of the LINCOS Units



Figure 3: LINCOS Digital Town Center

The LINCOS project is accomplishing its goals by introducing 'digital town centers' initially into rural areas of the Dominican Republic and Costa Rica, then expanding into other developing regions. These centers (referred to as the LINCOS units) are constructed from modified ISO shipping containers covered by a tensile structure. They house a computer lab, an information center and a telemedicine laboratory. This chapter will discuss the overall design of the LINCOS units in order to explain the framework in which the telemedicine and health services are provided to the communities. *Figure 3* shows one of the first prototype LINCOS units constructed in Costa Rica.

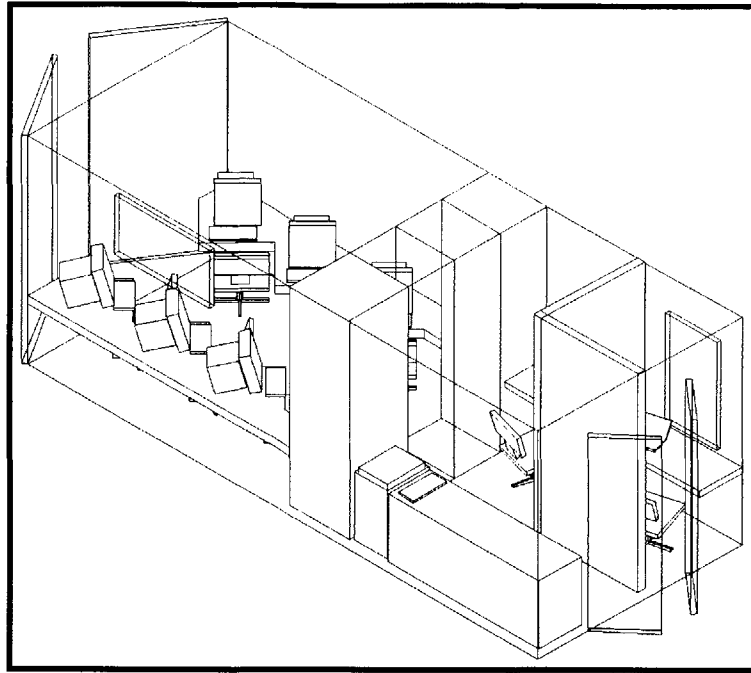

Figure 4: LINCOS Container Layout

2.1 The Physical Construction of the LINCOS Units

Shipping containers were chosen for the construction of the LINCOS units because they offer many benefits: standardization, security, structural integrity and low cost (because there is a large recycled after-market for them). Also, there already exists a widespread infrastructure for their transportation—they can be carried from their construction site to their final destination by boat, train, truck or helicopter. *Figure 6* shows a 20-foot long container being transported by truck to a site outside of San Jose, Costa Rica where will be modified and turned into a LINCOS town center.

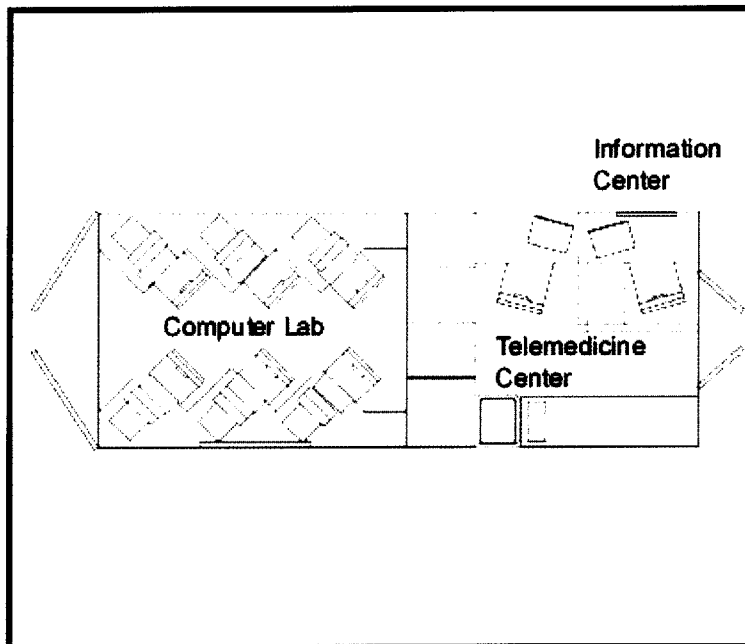

Figure 5: LIINCOS Container Plan View

The structural modifications to the containers are relatively simple: first they are opened in several places in order to create doors for a second entrance, vents for cooling purposes and windows. Next, walls and furniture are installed to create the spaces for a computer lab, an information center and a telemedicine laboratory. *Figures 4 and 5* show the container layout in its most common configuration.

The LINCOS unit is covered by a tensile structure that provides a covered area for hosting community events while protecting the container and its contents from exposure to direct sun and rain. It is important to keep the container from reaching extreme temperatures because of the possibility of equipment malfunction and discomfort to the users inside. Air conditioning or heating can be used when necessary, but are costly to sustain, particularly in areas where there

is limited or no electrical connectivity⁴. For this reason, the tensile structure, or canopy, was also designed to promote passive ventilation of the container when used in hot or humid areas.



Figure 6: ISO Container Being Transported

By properly orienting the LINCOS unit, winds are directed over the container causing a pressure difference between the outside and the inside through four vents on the ceiling. Another set of twelve vents located near the floor of the container permit the flow of cool air in through the bottom. In this fashion, passive air circulation is achieved, reducing or eliminating the need for air conditioning, thus providing substantial energy savings. One of the early models of the canopy is shown in *Figure 7*.

⁴ In the cases of no electrical connectivity, the container will have alternate sources of energy such as gasoline or wind generators, solar panels, or a hybrid solution that combines several of these technologies.

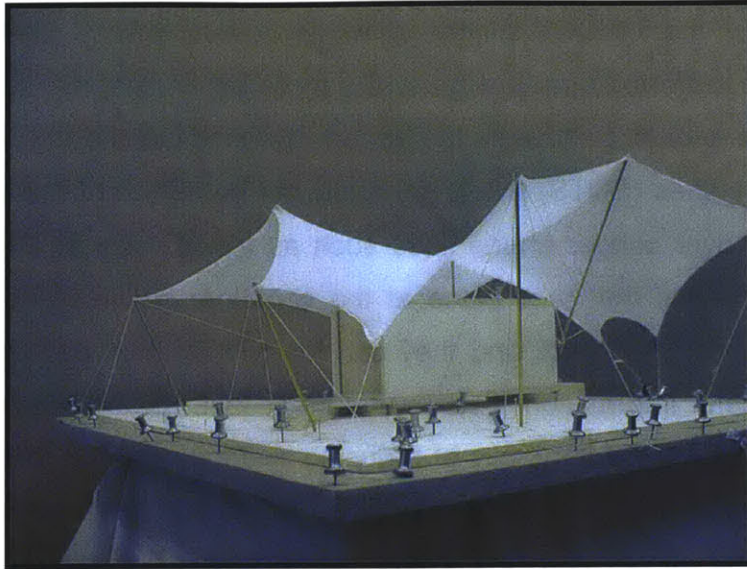

Figure 7: Canopy Model

2.2 Internet Connectivity for the LINCOS Units

A VSAT (Very Small Array Terminal) antenna provides direct voice and data satellite connectivity to the LINCOS container when it is located in an area without phone lines or a broadband Internet connection. This satellite connection sustains the various activities that take place at the container. Economical connectivity can be obtained from companies such as Tachyon (based in San Diego, CA) that purchase unused bandwidth from existing geo-stationary satellites and then resell it at discounted rates to end-users through their partner Internet Service Providers (ISPs). Currently they can offer almost immediate 2 Mbps connectivity to most areas in the US, Canada and Mexico. By 2001 Tachyon expects to be able to offer such connectivity to virtually any area of the world⁵. In addition to providing telecommunications at the LINCOS site, the satellite link extends connections to telephones and computers in the nearby schools, offices and homes. This can be accomplished with wired lines, or short-range microwave links (operating above 800Mhz) that can extend the connection

⁵ Source: Tachyon website www.tachyon.net/main.html

capabilities of the LINCOS center to within several miles⁶. When they exist, landlines are preferred over the (generally more expensive) satellite link, as long as they have enough bandwidth to support the needs of the LINCOS unit. Plain old telephone lines (POTS) would generally not be sufficient, but other services that operate over copper phone lines such as frame relay or DSL would work well. The activities that take place at the container can also be planned with bandwidth savings in mind, and they can be prioritized in such a way that the most important information gets transferred first. In addition, web-caching schemes can be used as a way of reducing redundant network traffic while still providing ample Internet functionality. It is becoming feasible for example, to purchase disk drives with hundreds of Gigabytes of storage capacity at increasingly lower costs (see *Section 5.1.1* on advances in computing). These drives could cache millions of commonly accessed web pages for offline viewing, updating them only when their content has changed.

⁶ One disadvantage of the microwave link setup is that it requires line-of-sight between antennas in order to operate without interference, a requirement that is not always easy to satisfy in highly mountainous regions.

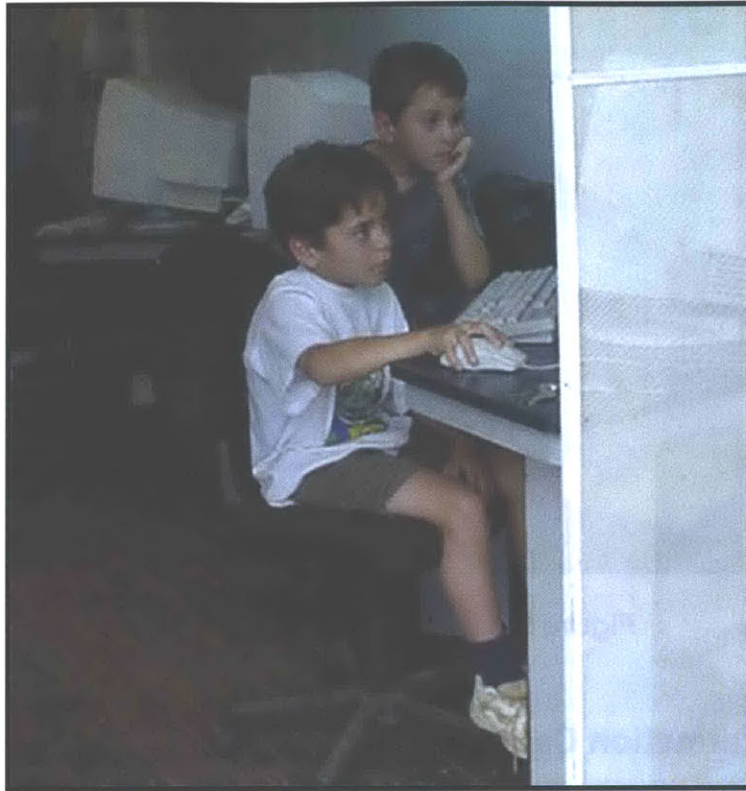

Figure 8: LINCOS Computer Laboratory

2.3 The Computer Laboratory

The LINCOS computer laboratory provides members of the community with access to the Internet and to a variety of software applications for education, finance, commerce and entertainment. The lab houses six multimedia PCs with peripherals for scanning, printing and recording video or images. Typically, computer classes would be offered to school children and to adults during part of the day and the rest of the time the computer lab would be open for general use. The lab provides tools for learning new skills and for gaining access to information technology. The intention is to help the communities “participate as equals in the global economy⁷.” *Figure 8* shows the computer lab in use by school children in San Marcos de Tarrazú, Costa Rica, the site of the first full LINCOS installation.

⁷ Sandy Pentland, Professor and Academic Head of the Media Lab, March 1999.



Figure 9: LINCOS Information Center

2.4 The Information Center

Figure 9 shows the information center at the LINCOS container. It is a multi-service booth that provides information and services to community members on everything from agriculture techniques and weather forecasts to government and social security forms. The attendant working at the info-center is equipped with a computer that has access to various information sources, both on the Internet and on local servers. The attendant also serves as the administrator for the public telephones, fax machines, copiers and computers at the LINCOS center. In addition he or she can run an email post office and messaging center that would allow community members to stay in touch with their friends and family abroad without needing to know how to use a computer.



Figure 10: Remote Weather Probe

2.5 The Telemedicine Center

The telemedicine center provides the space and tools for a health practitioner to perform telemedical consultations. In addition, it houses a small environmental testing and monitoring lab. The telemedicine room consists of a small private space within the container that contains an examination table, a mobile sink, a desk and cabinet space for storing medical instruments and supplies. A portable telemedicine kit was designed to be used primarily at the telemedicine center in order to take advantage of the connectivity at the LINCOS container. The kit consists of a laptop computer and several medical peripherals that allow the health practitioner to capture a patient's medical data in the form of text, graphics, video, audio and data files. This information is subsequently forwarded over the Internet to a doctor for diagnosis. The telemedicine kit will be discussed further in *Chapter 3*.



Figure 11: LINCOS Water Testing Kit

The telemedicine center also has an area that can be used as an environmental testing lab. Environmental testing is considered important in this context because of the effects of the state of the environment on the health of the population. Pollution, hazardous waste and other environmental problems create major health threats to communities around the world, a condition that is especially critical in developing countries because of the lack of awareness and enforcement of environmental regulations. Local water and soil parameters—such as pH, hardness and Chloride concentrations in water, and the levels of Nitrogen, Phosphorus, Potassium and pH in soil—are measured with test strips and solutions in the health lab (*Figure 11* shows the LINCOS water testing kit). The results from these environmental tests along with meteorological data that is collected from sensors such as the environmental probe shown in *Figure 10* can be sent from the lab to environmental and meteorological institutions for analysis and monitoring⁸. The results of these soil and water tests can also be valuable to local farmers, who can monitor and treat crops when necessary.

⁸ The weather probe shown in the figure was developed by Media Lab students Rich Fletcher and Matt Reynolds. They were originally used on Mt. Everest, and then in Antarctica to transmit local

3

The Prototype Telemedicine Kit



Figure 12: Telemedicine Kit

A portable telemedicine kit was designed and built to address the remote diagnostic needs of patients in rural communities of Cost Rica and the Dominican

readings of temperature, pressure, sunlight and wind speed from the remote areas directly to a satellite, which then posts the information to a publicly accessible website.

Republic. The kit is intended to be used primarily at the LINCOS town centers, however, because of its portability it can also be taken to the local clinics, or to patient's homes⁹. The kit is shown in *Figure 12*: it consists of a durable plastic case that houses a portable computer running custom telemedicine software and has several integrated medical peripherals for capturing patient's diagnostic information. The total cost of the components in the first kit that was built cost around \$8,000 (this is the cost of the prototype, i.e., everything was purchased in quantities of one). It is expected that the cost per unit could be reduced significantly by manufacturing several of them and also by evaluating alternatives for some of the more expensive components. *Section 4.3* further addresses some of the cost issues for medical devices.

The research that was done to develop this prototype system can be categorized into four general areas:

1. Defining the appropriate specifications for the telemedicine system.
2. Integrating the peripheral medical devices into the system in a user-friendly fashion.
3. Designing and building the electronics hardware for the system.
4. Defining the software requirements for the system¹⁰.

The following sections contain a more detailed description of the work that was done in these four areas.

⁹ A GPS unit (like the DeLorme EarthMate™ for \$90) can be easily attached to the telemedicine kit and used to record the exact location of the consultation. This information can be useful for research on the spread of diseases in rural areas.

¹⁰ Although I was involved in defining the specifications for the custom software, the actual development was carried out by a group of professors and students at the Instituto Tecnológico de Costa Rica (TEC).

3.1 Specifications of the Telemedicine Kit

The specifications of the first telemedicine prototype kit are based on studies that were conducted to determine the most common medical needs in rural communities of Costa Rica and the Dominican Republic. Medical needs have been found to vary significantly between countries and even between regions within the same country [Wright97]. In Costa Rica for Example, the Ministry of Health carried out an exhaustive national study in 1996 to assess the medical needs of the population. This study also looked to determine the feasibility of implementing a widespread telemedicine program in Costa Rica, a country that has had no prior experience in this area [Barrios96].

In 1999, a medical research team from the Center for Future Health at the University of Rochester carried out a *Rapid Assessment Procedure (RAP)* in Costa Rica and the Dominican Republic in order to quickly and efficiently assess the actual needs of the population that would be served by the LINCOS units.

The RAP process in public health program planning and evaluation is equivalent to the market research process in new product development, which ensures that devices, systems and concepts are relevant and comfortable to consumers prior to implementation. [Dye98].

Although the medical needs of different communities varied, it was determined through these studies that the telemedicine kit should provide the following five general capabilities:

1. Recording high quality audio from a patient's heart and lungs with a digital stethoscope.
2. Capturing a 12-Lead Electrocardiogram.
3. Capturing high-resolution external images and video of the eyes, ears, nose, throat and skin.
4. Recording a patient's blood pressure, pulse, body temperature and weight.

5. Uploading and downloading files to a networked database of electronic medical records that are also accessible by the consulting physicians.

3.2 The Peripheral Medical Devices

Several peripheral devices interface with a portable computer¹¹ in order to capture medical data in the form of text, graphics, audio and video. When they are not being used, these peripheral devices get stored inside the case along with the computer and the power source (in this case, a rechargeable battery or a regulator for plugging directly into a wall socket). The peripheral devices interface with the computer through an access panel on the inside of the case. This is done in order to make the kit simple to set up and to eliminate any uncertainty about how the devices should be connected (in other words, all of the intricate connections are done internally). *Figure 13* shows the access panel, which has a series of standard internationally recognizable icons indicating where and how the various peripherals should be plugged-in.



Figure 13: Telemedicine Kit Control Panel

¹¹ For the prototype unit we used a 300Mhz Toshiba Satellite 2595CDS running Windows™ 98.

Most of the peripheral devices in this kit are not extremely expensive telemedicine devices, but rather moderately priced standard medical devices that were integrated in such a way that they could be used in this application. All of the modifications that were done to the devices are in accordance with Food and Drug Administration (FDA) regulations in order to maintain safety and quality of the patients' data. *Section 4.3* covers the important issues concerning FDA approval for modifications to medical devices used in the US and elsewhere. The various peripheral devices are described in more detail in the following sections.



Figure 14: Telemedicine Kit Stethoscope

3.2.1 Electronic Stethoscope

The telemedicine unit has an electronic stethoscope to capture sounds from a patient's heart and lungs. Electronic stethoscopes are becoming widely used, especially in educational settings (so that medical students can all hear the heart of a patient that is being examined by their instructor). Electronic stethoscopes, which have an audio pickup at the diaphragm coupled to a headset, have several advantages over the standard acoustic versions: elimination of sound loss and resonance effects, the ability to set different levels of amplification, active noise filtering and the ability to isolate sounds within a given frequency range. For this

application, the Stethos¹² digital stethoscope was chosen because of its relatively low cost and its high performance in these areas. A frequency response chart comparing the Stethos with a standard acoustic stethoscope is shown in *Figure 15*. From the chart it can be seen that at different volume levels, the Stethos does its job of amplifying the preferred low frequency sounds while reducing the undesirable high frequency ambient noise. Since the electronic stethoscope is made for listening—not recording, a minor modification was made to the cable of the device in order to direct the audio signal into the input of the computer instead of going to a standard earphone set (this can be seen in *Figure 14*). In addition, the signal from the stethoscope was amplified to the proper levels in order to obtain a high quality recording on the computer and to allow the practitioner to simultaneously listen to the stethoscope output on a set of headphones plugged into the main access panel¹³. *Appendix A* contains more details on the stethoscope amplification circuitry.

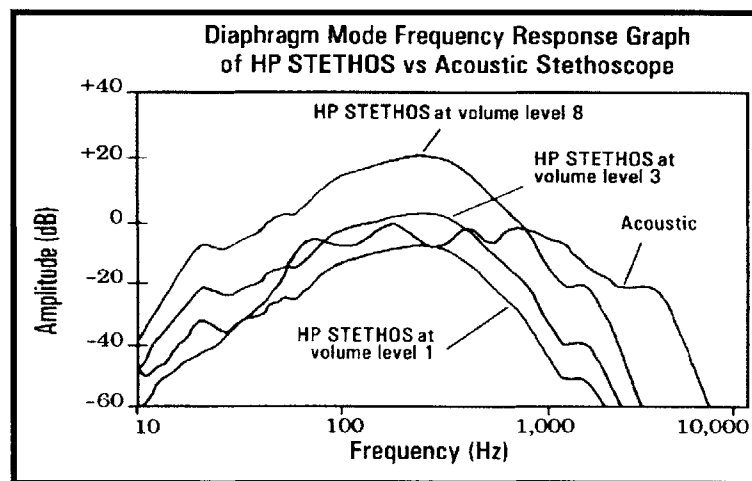

Figure 15: Stethos Frequency Response Chart

¹²The Stethos™ is manufactured by Agilent Technologies and costs approximately \$300 in small quantities.

¹³ In order to reproduce frequencies that are below about 100Hz accurately the listener must wear earphones that completely enclose the ear, forming an airtight seal. [Bashshur97, 89].



Figure 16: ECG Recorder

3.2.2 Electrocardiogram Recorder

Heart conditions are a common cause of death throughout the world and they are often not diagnosed early enough. Electrocardiogram (ECG) recorders are used to monitor the electrical activity of the heart and can detect abnormal heart rhythms, inadequate blood and oxygen supply to the heart and an excessive thickening of heart muscle (which can result from high blood pressure). It is only until recently that portable, PC based ECG systems have become available in the \$2000 range. Standard ECG systems were generally large in size, costly and usually could only print their traces to paper, making it difficult to share the information electronically without a scanner. In order to provide electrocardiography diagnostic capabilities, the telemedicine kit was equipped with a 12 lead PC based ECG unit (manufactured by Brentwood Medical of Torrence, CA). The device allows a health practitioner to capture and forward a full patient electrocardiogram to a cardiologist for diagnosis. One of the major advantages of this system over others of its kind is that it is interpretive: the software gives feedback on the signals that it receives. This means that if the patient has a recognizable heart problem, it is brought to the practitioner's attention immediately, allowing them to take appropriate action without having to wait for a reply from the cardiologist. The software for the ECG unit is integrated

with the telemedicine software that will be described later on in this chapter. The ECG is shown being used in *Figure 16* and a sample data output file is shown in *Figure 17*.



Figure 17: Sample ECG Data File

3.2.3 Medical Imaging System

A medical imaging system is used in the telemedicine kit for capturing images and video of a patient's skin (and can also be used for external examination of the eyes, ears, nose and throat). Skin conditions are common in the developing world, often showing up as symptoms of other diseases. The practice of teledermatology requires high resolution and properly illuminated color images and video.

The telemedicine prototype contains a high-resolution (410,000 pixel) medical ¼ inch CCD camera with an integrated uniform illuminator. This general examination camera (distributed by American Medical Development in Lowell, MA) is the single most expensive item in kit (it costs about \$4,000 in small quantities). It is expensive relative to the other peripheral devices because it is a highly specialized FDA approved medical device, and has several features that

can not be found on a standard video camera: automatic gain control (AGC), polarization that eliminates reflections off of the surface being examined, 1-200x zoom range, white balancing and freeze-frame. One of the most important features of the AMD general exam camera is that it has a built in uniform illumination source, which is especially useful in mobile applications where lighting conditions may not be easily controlled. Surprisingly, stand-alone medical illumination sources are extremely expensive, as they are usually high quality fiber optic units costing several thousand dollars. *Appendix E* contains more information on the camera's technical specifications.

Figure 18 shows a polarized image of the eye taken with the AMD general examination camera.

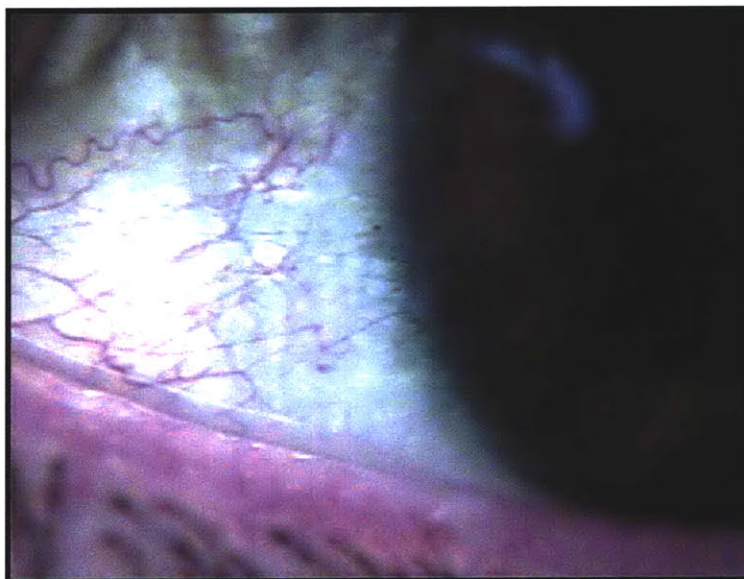

Figure 18: Polarized Image of the Eye Taken with Imaging System

CCD and CMOS imager chips have advanced a great deal in the last few years; today USB video cameras (or web cams used for internet conferencing) can be purchased for as little as \$50¹⁴. Also, consumer digital cameras capable of

¹⁴ For example, Creative's Video Blaster® Webcam 3 for US\$50 (www.creative.com).

producing Mega pixel resolutions are becoming available in the \$500 range, making them viable alternatives for teledermatology in the store-and-forward mode. *Sections 4.1* addresses the issues of image quality for remote diagnosis of skin conditions and *Section 4.2* compares the store-and-forward and real-time methods of telemedicine.

3.2.4 Blood Pressure, Temperature and Other Measurements

A portable blood pressure meter allows the health practitioner to take an accurate and quick reading of a patient's systolic and diastolic blood pressure as well as their pulse rate. The blood pressure monitor used in the telemedicine kit consists of a small portable device (manufactured by Becton-Dickinson) that costs approximately \$50 and is extremely simple to use: the cuff is inflated automatically by pressing a single button and within 30 seconds the device outputs an accurate reading to its LCD screen.

Also included in the kit is a digital thermometer, which is placed in the inner ear for a temperature reading accurate to 0.5 °F. This device uses an optical method of determining temperature by looking directly at the infrared (IR) energy radiated by the eardrum (which is one of the most stable, effective and non-intrusive ways of measuring body temperature¹⁵).

In addition to the blood pressure meter and thermometer, there are other 'unconnected' digital devices in the telemedicine kit such as a scale, an ear fluid monitor and a blood glucose meter. In regions with different diagnostic needs, these devices could be replaced with more appropriate equipment, medications or tests.

In the short term, the practitioner will manually enter the readouts from these devices into the patient database on the portable computer. In the future, this

¹⁵ Source: Becton Dickinson Assure™ Ear thermometer specification sheet.

information could be wirelessly transmitted to the computer by embedding small, low power transceivers into the devices. *Chapter 5* describes this wireless concept in much more detail.

3.3 Electronics and Power for the Telemedicine System

Electricity and rechargeable batteries power the prototype telemedicine kit, but alternate forms of energy are considered for areas with little or no electrical connectivity. Systems such as fuel cells, hand-cranked and solar power could become efficient and sustainable ways to power the unit in the future. Ideally the peripheral devices themselves could be equipped with rechargeable batteries and could get charged when they are 'docked' into the case.

In addition to the electronics for powering the unit, there is custom circuitry in the kit to amplify the stethoscope signal before it is recorded on the computer. *Appendix A* contains details on the electronics that provide power to the system and charge the rechargeable battery, as well as a schematic of the amplification circuitry for the stethoscope.

3.4 Software Interface for the Telemedicine System

Software running on the computer in the telemedicine kit aids the facilitating practitioner in creating, viewing, capturing and forwarding patient medical information. The software was developed primarily by the TEC and it was designed to be intuitive, graphic, fast and user friendly. Its primary users are the local health practitioners in the communities and the consulting physicians at the other end. The telemedicine program requires that all users have individual accounts set up by a central administrator in order to control access to the records and preserve patient confidentiality. The four basic components of the program are explained in the sections below.

3.4.1 Database Management

The practitioner can either create new entries, or search the networked database for existing patient records. They can base the search on a number of different criteria and access patient information that was created or modified at any location. *Section 3.4.4* discusses the networking and database interface capabilities of the software program.

3.4.2 Text Entry of Patient Data and Measurements

The practitioner enters or updates patient history information (name, age, sex, address, social security number, family history, previous and current symptoms, medications, etc.) They also take measurements with the appropriate peripheral devices (e.g. blood pressure meter, thermometer and scale) and update the patient records.

3.4.3 Capture of the Telemedical Data

The practitioner is given a choice of what data to capture: either audio with the digital stethoscope, an electrocardiograph file with the ECG recorder, or images/video with the general examination camera. In each of these cases, the telemedicine software interfaces with the appropriate programs to capture the files that are created.

3.4.4 Network Communications

Once the capture session is complete and the practitioner is satisfied with the changes that they have made to the patient record, they access the network and incorporate the patient files back into the central database. This network connection can be established in the telemedicine room at the LINCOS unit, or from any telephone jack. At this time the practitioners also notify the consulting physician that the records are ready for review by email or telephone¹⁶. From the

¹⁶ In future versions of the software, the consulting physicians will be notified automatically by email.

other end, the consulting physician (equipped with the same telemedicine software on a desktop PC) downloads the record and performs an evaluation, entering text in the diagnosis area. When they are done, they establish a network connection and upload the file to the central database, notifying the practitioner that the diagnosis is complete. Last, the practitioner downloads and opens the patient record, reads the doctor's diagnosis and can then take appropriate action.

Appendix B includes screen shots of the various program modes of the telemedicine software.

4

Important Factors in the Development of the Telemedicine System

Several important issues were considered when developing the telemedicine kit such as sound, image and video capture quality, the tradeoffs of choosing store-and-forward vs. real-time telemedicine and the regulations for FDA approval of new or modified medical devices in countries outside of the US. Each of these issues are considered in the sections below.

4.1 Quality of the Data Captured

There are cost trade-offs associated with the quality of data that is captured, stored and transmitted over networks such as the Internet. Higher quality data usually equates to larger file sizes, which in turn means longer network transfer times. Choosing appropriate audio, image and video quality for telemedicine is important to ensure accurate diagnoses on the part of the doctors, while keeping network traffic down. Advances in data compression techniques as well as the rapid growth of bandwidth available for network communications (see *Section 5.1*) makes many of the limitations encountered today become less of an issue in the near future. The effects of quality on the diagnostics are briefly discussed below for each type of data file.

4.1.1 Quality of Audio Recordings

The dynamic range of the heart and lungs is 20Hz to 2KHz [Bashshur97, 89]. In order to preserve sound quality during recording, sampling should be done at a rate that is at least twice the highest frequency of interest (2kHz in the case of the heart and lungs). This is known as the *Nyquist sampling rate*—the rate at which no aliasing occurs [Proakis94, 109]. Of course it is better to sample at a rate higher than 4kHz, for improved sound quality. As a point of comparison, a 10 second uncompressed (16 bits per sample) mono audio file sampled at 8kHz

produces a file that is approximately 83 kilobytes, while the same recording at 44.1 kHz takes up approximately 390 kilobytes of memory¹⁷. Subsequent compression of these files can reduce their sizes by significant factors (*Section 5.1.3* treats data compression in more detail.)

Considering that the audio files of the heart and lungs are likely to be short (on the order of several seconds) and that the network connections available at the LINCOS container will be reasonably fast (on the order of 128 kbps or higher), then high quality recordings can be transferred quickly over the Internet in the store-and forward fashion. Real time audio (to accompany video in most cases) can be digitized at 128 kbps (8kHz for 16 bit mono), which is sufficient to reproduce the full human auditory frequency spectrum from 20Hz to 20Khz [Bashshur97, 89].

4.1.2 Quality of Still Images and Video

Images and video need to have certain quality characteristics in order to be acceptable for remote diagnostics. The quality required is highly dependant on the application: for example an image taken to show the general region of a rash on a patient's hand can be of very low quality (i.e., 200 x 200 pixels, 8 bits, grayscale intensity resolution) and still serve it's purpose. Similarly, modern digital Computed Tomography (CT) scans can be processed so that images that are only 256 x 256 pixels and 8 bit grayscale can be transmitted for effective diagnoses [Bashshur97, 87]. However, a digitized chest x-ray for example, needs to be of a much higher quality (2000 x 2000 pixels with a 12 bit dynamic range) in order to be useful for remote diagnoses. Krupinski and researchers at the University of Arizona conducted a study to evaluate the effectiveness of digital photography for dermatological diagnoses by comparing them with in-person visits. They found that there was 83% concordance between in-person visits and

¹⁷ These recordings were tested using the sound recorder in Windows 98™, which is also what the telemedicine kit uses.

the teledermatology diagnoses (using a Cannon PowerShot600 digital camera at 832 x 608 pixels and 24 bit color resolution). [Krupinski99]. Unfortunately, the study did not measure the effects that reducing the image size and dynamic range would have on the specialists' diagnostic capabilities.

There seem to be no general formulas; image quality needs to be matched to the application in which it is used and addressed on a case-by-case basis [Argy99, 3].

The same guidelines apply to live or store-and-forward video: the appropriate frame rates and image sizes depend highly on the application. Telepsychiatry for example, doesn't require the highest image quality, but needs high frame rates (15-30 fps) for a consultation to be effective. Other applications (such as teledermatology) must use higher resolution images, but do not necessarily require such high frame rates.

4.2 Real-Time Vs. Store-and-Forward Methods of Telemedicine

The telemedicine unit for LINCOS was designed primarily to use the store-and-forward (asynchronous) method of telemedicine and despite some disadvantages, this modality has the potential for substantial time and cost savings compared to the real-time (synchronous) method.

The store-and-forward modality of telemedicine typically consists of a local health practitioner capturing patient data independently (images, audio, data files, patient symptoms in a text file, etc.) and then sending them over the Internet to a specialist who can asynchronously perform a diagnosis. In the real-time mode, the specialist is 'present' during the capture process, usually by means of a videoconferencing system. In the US for example, dermatology (which represents the largest overall volume of telemedicine cases—roughly 30%) is the

most common type of store-and-forward application¹⁸ while psychiatry (the second largest in overall volume—roughly 20%) is the most common mode for real-time consultations [Webster99, 267].

There are significant time efficiency and cost differences between the store-and-forward and real-time methods of telemedicine. The specialists offering the consultation almost always have constrained and costly time schedules. An asynchronous method (such as store-and-forward) fits in better with their schedules; they wouldn't need to coordinate the exact times at which they will give their consultations and they would have virtually no set-up time [Robinson88, 40]. There is also a good amount of time spent on the social formalities between doctors and practitioners or patients in real-time communications and although this contact is valuable for educational for interpersonal reasons, it is still time consuming. During a real-time consultation, patients also tend to ask questions that are not directly related to their current condition, a phenomenon that is rarely seen in the store-and-forward method [Bashshur97, 230].

Another important consideration is turn-around time: the length of time that it takes patients to receive a diagnosis from the time that they first schedule the appointment with the referring practitioner. Studies by Krupinski, et al. at the University of Arizona suggest that the major difference between real-time and store-and-forward cases is in the time between the contact of a consulting clinician and the actual consultation [Webster99, 269]. This is because real-time sessions require coordinating the schedules of the patient, the referring clinician, the specialist and any other relevant support staff. Real-time sessions typically take 10 to 20 minutes, while store-and-forward sessions tend to take less—5 to 10 minutes [Bashshur97, 232]. But once the real-time session is scheduled and

¹⁸ Other applications that commonly use the store-and-forward technology include ophthalmology, pathology and radiology [Argy99].

does take place, the recommendations to the patient (diagnosis) are almost immediate, while there is a delay associated with store-and-forward diagnoses.(in the University of Arizona study, this delay was on average approximately 12 hours). The results of the study showed that the majority (67%) of the store-and-forward cases observed had a total turn-around time of less than 72 hours, while the majority of real-time cases (72%) had a total turn around time of more than 72 hours. On average, real time cases took 180 hours more than their store-and-forward counterparts [Webster99, 267].

There are also cost savings associated with using the store-and-forward instead of the real-time method. The savings come from not needing costly video-conferencing equipment or a high bandwidth line to support it. This is an important issue, especially in developing countries, where the costs of high bandwidth Internet connections are very high¹⁹. Also, not needing to recover the investment on expensive equipment for real-time communications means that consultations can be offered at affordable prices to community members.

An advantage of the store-and-forward method in terms of functionality is that the telemedicine kit can be transported to locations that do not need to have Internet connections. This is an important capability in rural areas, because it allows the health practitioners to make visits to patients' homes or to give consultations at a nearby health center and forward the information to a specialist for diagnosis at a later time.

Despite the advantages in terms of time and money saved, there are also disadvantages of using the store-and-forward method. For instance, the consulting doctor may require more than one forwarding session from the practitioner (this can occur when the practitioner fails to provide enough information for them to successfully diagnose the condition). After examining a

¹⁹ In Costa Rica for example, a 1.5Mbit satellite connection costs around \$800/month.

patient's record asynchronously, a dermatologist, could request that the practitioner capture a more specific view of a region on the patient's skin for example, or a cardiologist could request a stethoscope recording with less noise. In most cases these issues could be avoided with a real-time session because the consulting doctor could instruct the referring on how to best capture the data. During a real time session the doctors also have the opportunity to interview the patients personally, many times obtaining non-obvious, but relevant information about the them. Another disadvantage of the store-and-forward method is that it does not promote the same doctor-practitioner and doctor-patient interaction that occurs with real-time diagnoses. "The picture of the doctor is important, even at low bandwidths [Bashshur97, 403]." This real-time interaction is beneficial to all parties involved: it is beneficial to the patient because they get direct, expedient, advice from a specialist that can address their health concerns. For the practitioners, the interaction with the specialists can be an opportunity to further their education and knowledge, and to keep abreast of new techniques and developments in various medical fields [Bashshur97, 244]. Last, the interaction is beneficial for the doctors because they are able to extend their practice to previously inaccessible areas and gain experience treating different kinds of patients.

A major limitation of today's telemedicine (for both real-time and store-and-forward modalities of operation) is the inability to convey the sense of touch. In dermatology for example, it is important to be able to "palpate skin lesions directly to determine the surface characteristics, e.g., smooth, scaling; or it's texture, i.e., whether it is soft, firm, or fluctuant; and the amount of pain or discomfort that light or firm palpation elicits [Bashshur97, 230]." This situation is slightly better in the real-time case because the doctor can at least see and hear how the patient reacts when the practitioner palpates the lesion and can hear the description of the surface characteristics from the practitioner's comments. In the near future, remote force and tactile devices, also known as *haptic* interfaces [Chen98] could help remove this limitation by allowing the doctor to control a

simple surgical procedure such as a biopsy, or to 'touch' a patient's skin in order to 'feel' its surface characteristics.

In summary, despite some disadvantages, the store-and-forward mode of operation was chosen for the LINCOS telemedicine activities because it can be a cost-effective and efficient way of treating patients in remote areas of developing countries.

4.3 Medical Approval for Peripheral Devices

A very important aspect of telemedicine is being able to log and transfer data automatically from the peripheral devices to a computer. When choosing the peripheral devices for the telemedicine kit, it was found that those that could be purchased with data output ports were significantly more expensive than similar devices without ports. It appears that the cost difference comes from the fact that the output-enabled devices fall into a different category than their 'consumer grade' counterparts. A good example of this is the digital scale/body fat monitor: consumer versions of the scale (such as the Tanita TBF-611) are reasonably priced at around \$75, but do not come with a data output port. The professional version of this scale on the other hand (the Tanita model TBF-105) comes with a RS-232 output (and several other advanced features) but costs \$4900. This substantial difference in price comes in part, from the fact that the TBF-105 will typically be used in a clinical setting where the high cost of the device can be justified and recovered over time. This is the case not only with the scales, but also with thermometers, stethoscopes, blood pressure monitors, ECG recorders and medical imaging systems used for telemedicine.

Medical device manufacturers make substantial investments in maintaining quality control for their products. In the US, medical devices are regulated by the Food and Drug Administration (FDA), which requires manufacturers to follow strict safety guidelines when designing, manufacturing, packaging and labeling their products for medical use. Approved medical devices are classified by the

FDA into three types (I, II, III) based on the level of control necessary to assure the safety and effectiveness of the device. A tongue depressor for example, would be a class I device, while a pacemaker would belong in class III.

An important question arises when considering telemedicine options for developing countries: since typical telemedicine devices are simply too costly for widespread use, could more cost-effective 'consumer grade' devices be modified to output data and be used as an alternative? Admittedly this is a difficult question to answer. From the technical point of view, the modifications could be done easily: minor changes to the electronics boards and to the embedded code in the microprocessors during the manufacturing process would allow a standard medical device to output its data to a computer. From a cost-benefit analysis point of view, it seems like using these 'consumer grade' devices could be advantageous as long as they lower costs, improve health and maintain safety. Since the FDA does not regulate the use of medical devices outside of the US, it is up to the countries themselves to adopt policies concerning their use of medical devices and to consider these issues carefully.

Since the telemedicine kit that was developed for LINCOS is a prototype and will soon be tried with patients in Costa Rica and the Dominican Republic, we did not make any non-agency-approved modifications to the devices in order to ensure the safety of the patients. All of the peripherals used in the telemedicine kit are class I or II devices and modifications made to them did not require re-submitting for FDA approval²⁰. It is, however, interesting to look at alternative, less expensive devices and technologies that could be used for future telemedicine in developing countries. The next chapter discusses some of these technologies.

²⁰ This process was determined using the Food and Drug Administration's *Guide for Deciding When to Submit a 510(k) for a Change to an Existing Device [FDA 510(k) Memorandum #K97-1]*

5

Telemedicine in the Future

The rapid technological advances in the fields of computing, artificial intelligence, data storage and compression and high speed wireless communications coupled with the development of new non-invasive biological and medical sensors [Gibbs97], are creating new possibilities for remote medical sensing in the future. It may be only a short time before it is possible to create a 'TeleCorder', a hand-held medical device inspired by the futuristic 'Tricorder' from *Star Trek* (shown in *Figure 19*). The TeleCorder does non-invasive telemedical sensing, computing and wireless communications all in one compact, portable form factor. Health practitioners, or even patients themselves could use a TeleCorder to perform accurate and rapid on-site diagnoses of various diseases and medical conditions and to communicate the information to specialists anywhere in the world. *Section 5.1* will look at some of the technologies that are likely to enable the development of such a multi-diagnostic device.

Also, there is increasing recognition that the home is one of the best places to deliver healthcare—it allows patients to actively participate in maintaining optimum health, while reducing their need to visit hospitals. In the future, dozens of unobtrusive sensors embedded into the home could wirelessly transmit medical telemetry to a personal computer and periodically update a secure database that is controlled by the patient and accessible by their doctors. For home health monitoring to work in this fashion, the relevant household items need to be equipped with the technology to sense and transmit physiological parameters seamlessly to a base station computer. Home health monitoring is discussed further in *Section 5.2*.

As a step towards the futuristic home health scenario described above, a small, low power transceiver board that was designed and built to demonstrate the

feasibility of inexpensively enabling existing home healthcare devices to communicate wirelessly. This board was designed in such a way that it could be used in almost any type of low bit-rate medical or consumer electronic device. The electronics hardware and software that was developed are described below in *Section 5.3*.

5.1 Technological Advances

Advances in several fields of technology and telecommunications help enable the creation of a multi-diagnostic device such as the TeleCorder described above. In order for a device to be used in a widespread fashion throughout the world, it needs to be low cost (hundreds, not thousands of dollars), highly functional, accurate, adaptable to multiple languages and customizable to address vastly different medical needs. It would literally be a convergence of sensing, computing and communications and would have artificial intelligence capabilities to complement and enhance the user's diagnostic capabilities.

The sections below contain brief descriptions of some of the technologies that will make the creation of a TeleCorder possible in the future.

5.1.1 Computing

Moore's Law predicts that the amount of processing power and memory storage of computers will double roughly every 18 to 24 months. This means that the computing power and memory that today is only available in the processors of large personal computers will be available next year sometime in microchips that are half the size. Personal Digital Assistant (PDA) devices such as the Palm Computing Palm Pilot™ or the Handspring Visor™ are already capable of tasks that were simply not possible in such small form factors just a few years ago. These systems are likely to continue to develop and decrease in cost, offering consumers access to information and communications anytime, anywhere. In conjunction with the development of these devices, there have been advances in the peripherals that interface with them and extend their capabilities. For

example, there are several companies developing expansion peripherals for the Visor™ such as digital cameras, audio recorders and players, data acquisition modules, GPS units, wireless modems, etc. Simple medical attachments are also starting to appear on the market as Visor peripherals.

As these trends progress, processing power and memory should not be a limiting factor in the development of a device such as the TeleCorder.

5.1.2 Artificial Intelligence

Expert Systems for clinical decision support are commonplace in many areas of medicine [Bashshur97, 395]. Mycin, one of the most famous expert systems, was developed in the mid 1970's by Edward H. Shortliffe at Stanford University. It was designed to be an intelligent medical diagnostic tool that could help identify medical conditions. In 1979, the Journal of American Medical Association recognized that Mycin was "as good as medical experts." [Buchanan84]. Development in software agents and intelligent systems has continued since then at an accelerated pace, becoming more powerful as computing capabilities have increased. NASA, for example, has successfully employed modern complex expert systems of this type in manned missions in order to offer immediate decision-making support to astronauts with medical emergencies in space.

A TeleCorder would require intelligent software that can perform expedient analysis of large amounts of data, giving immediate results and recommendations to patients or practitioners regarding their most probable condition based on the collective experience of many experts and aided by the computational power of the embedded processor (and any larger databases to which it is wirelessly connected).

5.1.3 Data Compression and Transmission

Along with increasing computer power and memory storage has come the ability to compress images, video and sound more efficiently. Compression is typically

expressed as the fraction of uncompressed to compressed data. While *lossless* compression can achieve at best a ratio of 2:1, *lossy* compression algorithms can achieve ratios that are much higher (up to 10:1, but since it produces an irreversible loss of information, it needs to be done at a level that does not eliminate critical medical information) [Bashshur97 82]. Major savings are achieved by compressing video, because in many applications, images change very little from one frame to the next (primarily the backgrounds and relatively stationary objects). Further savings can be achieved within frames by abbreviating the code required to represent uniformly colored areas [Bauer99, 142]. Great progress has also been made in audio compression, especially because of the music market for digital audio files. For a more detailed treatment of image, video and sound quality, see *Section 4.1*.

Data compression ultimately allows information to be transferred to and from the capture device faster and more efficiently. A TeleCorder would also take advantage of the advances in data compression techniques for high-speed transduction and storage of data.



Figure 19: Star Trek Tricorder

5.1.4 Wireless Communications

In recent years there has been a trend towards wireless communications throughout the world. This was first seen with the extension of cellular systems for telephony, which have tremendous advantages, especially for providing telecommunications to areas that have no landline infrastructure. Today, an even greater change is taking place, with enterprises offering full wireless connectivity not only for communications, but also for access to multimedia information through the use of web-enabled devices such as PDA's, cell phones and two-way pagers. There also companies like Teledesic, that are deploying systems of low-orbit satellites that will offer high speed data communications using smaller antennas with shorter time delays than the existing geo-stationary satellites²¹. The costs for satellite connectivity are decreasing, as there is more competition and a larger number of customers. "Bandwidth is declining as a bottleneck in the growth of telemedicine [Bauer99, 142]."

Along with increased connectivity to the outside world, there are protocols being developed for high speed, short-range wireless communications between devices. Bluetooth™, for example, is a wireless protocol that operates at 2.5 Ghz and allows a 1 Mbps wireless link between devices in an *ad hoc* fashion [Haartsen00]. A cell phone, PDA and a laptop for example, could all share data as long as they are within 10 meters of each other. Another example of an emerging wireless protocol is HomeRF, which offers a slightly higher 1.6 Mbps peak data rate and longer range (approximately 50 meters which would be appropriate for many home and office settings). [Negus00].

There also seems to be a real need for members of the medical community to communicate with each other and with their patients efficiently. Currently, doctors use cell phones, wired phones, pagers, email, voice mail and regular mail to communicate. All of this could change with the integrated personal

²¹ See <http://www.teledesic.com> for more information.

communications capabilities of a TeleCorder. Doctors could use it for virtually all of their communications needs as well as taking advantage of the computing, database and sensing capabilities (possible sensors will be described in the next section). In the near future, there are expected to be several wireless data infrastructures to support the general communication needs of the TeleCorder both for long and short-range connectivity.

5.1.5 Medical Sensors

The TeleCorder would be capable of non-invasive sensing of multiple types of human physiological parameters. There have been recent advances in sensing technologies, like the development of the GlucoWatch® Biographer (made by Cygnus, Inc. in Redwood City, CA). The GlucoWatch is watch-sized blood glucose monitoring system that provides painless and automatic measurement of blood sugar levels for diabetics²².

Also, there has been rapid development in the field of biosensors, which are electronic devices that convert biologic inputs (such as blood pressure, joint position, or brain waves) into electrical signals [Bauer99, 205]. Biosensors integrated into the TeleCorder and its wireless protocol could allow rapid, on-site diagnoses of a wide variety of human diseases and medical conditions.

Up until recently, smell has been difficult to digitize accurately, but portable products for doing this are now starting to appear on the market [Nagle98]. For example, Cyrano Sciences (in Pasadena, CA) has recently introduced a product called the Cyranose™, a hand-held electronic nose that is capable of digitizing smell. Applications of sensing smell could include obtaining objective information on the identity of certain chemical compounds in exhaled air and excreted urine or body fluids (related to specific metabolic conditions) and certain skin diseases

²² See www.cygn.com for more information on the GlucoWatch® Biographer.

or bacterial infections (such as those common to leg or burn wounds²³). A sensor of this type in the TeleCorder could provide practitioners with a tool for performing quick and accurate diagnoses in remote areas.

Sensors could be used on the TeleCorder not only for medical applications, but also for environmental sensing. This could allow the capture of environmental and meteorological data in remote as well as highly populated areas of the world. A GPS chip would allow precise locations to be recorded with all of the measurements taken for visualization and statistical analysis purposes.

5.1.6 Medical Records

A TeleCorder needs to be capable of rapidly accessing a wide variety of electronic medical records (EMRs) for research, education and medical practice. The uses of EMRs are ever increasing and they have obvious advantages over paper-based records. However, the true potential of EMRs is currently limited because of the lack of universal standards and because patients are prevented from accessing and controlling their own records [Bauer99, 91]. The future of EMRs is universal, integrated, patient-controlled records that can be accessed from any point by patients and selected practitioners when and where they are needed [Bauer99, 91]. A useful application involving medical records would be to have the results of telemedicine consultations throughout the world tied to a publicly accessible database (all personal information would get stripped out of the records to maintain patient confidentiality). This database could be an invaluable reference source for practitioners, doctors, researchers and patients. Answers to commonly asked questions could be archived along with images, audio and video of common (or uncommon) conditions.

²³ See www.cyranosciences.com for more information on the capabilities of the Cyranose™.

A TeleCorder would be capable of handling an Internet-based system of medical records so that appropriate information could be accessed at any time by the patient and by the practitioners that they choose.

5.2 Home Health Monitoring

There are a growing number of people with access to the Internet at home²⁴ and a large percentage of these people schedule regular visits to see their doctors in person. Many of the visits are check-ups or follow-ups from previous treatments that could be done more efficiently with a 10-minute real-time or store-and-forward telemedicine consultation. Traveling to see a doctor regularly is inconvenient, especially for people with medical conditions in remote areas. A home solution could reduce the number of unnecessary physical visits to the hospital, letting doctors decide when patients should be seen in person. In order for a home solution to work, medical devices need to be instrumented to output their data to a computer with an Internet connection. An alternative solution could be to IP-enable the medical devices themselves by using a chip such as the Filament²⁵. A wireless home application however, could provide the freedom and ease of use necessary to make home health monitoring widespread in developed and developing countries alike. Why wireless? Because wires are cumbersome: they become tangled, they are often not long enough, they restrict mobility, and they leave the possibility of being connected incorrectly. Wires simply do not fit in well with the way that people live. A wireless system could be set up throughout the home to sense many physiological parameters such as blood pressure, blood oxygen levels, weight, etc. A toilette for example, could be instrumented with sensors to look for signs of colon cancer or renal failure, miniature blood glucose

²⁴ As of November 1999 there were an estimated 110 million Internet users in the U.S. and 259 million worldwide (Source: The Computer Industry Almanac, 2000).

²⁵ The Filament is an Ethernet device that can be used to connect a wide variety of devices directly to the Internet without the need for a computer. It was developed by Pehr Anderson and Mathew Hancher in the Physics and Media Group at the Media Lab. More information can be found at <http://www.media.mit.edu/~pehr/thesis/html/>

sensors could be embedded in the telephone and an ultrasound could be part of the everyday shower [Bashshur97, 405]. One could think of many ways in which home monitoring can help people take control of their health and live longer and healthier lives. As homes become increasingly networked with wired or wireless infrastructures [Dutta99], it will become easier to introduce telemedicine devices into the home.

Section 5.3 below describes a wireless telemedicine system that was designed for home health monitoring.

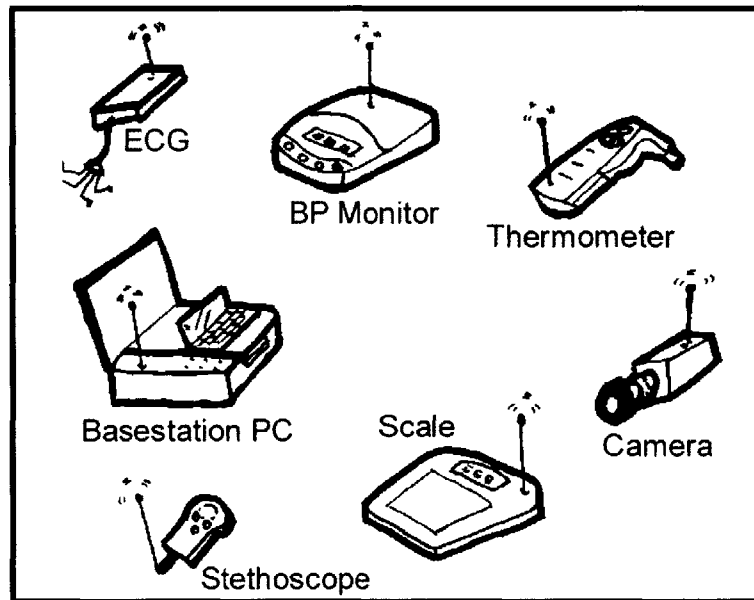

Figure 20: Wireless Telemedicine Concept

5.3 Wireless Transduction from Medical Devices

A small transceiver board was designed and built in order to demonstrate the capability of transmitting low bit-rate information wirelessly from various consumer home medical devices to a central base station (usually a personal computer). *Figure 20* illustrates this concept with multiple devices—a blood pressure monitor, a scale, a video camera, a stethoscope, an ECG recorder and

thermometer are depicted communicating wirelessly with a base station computer.

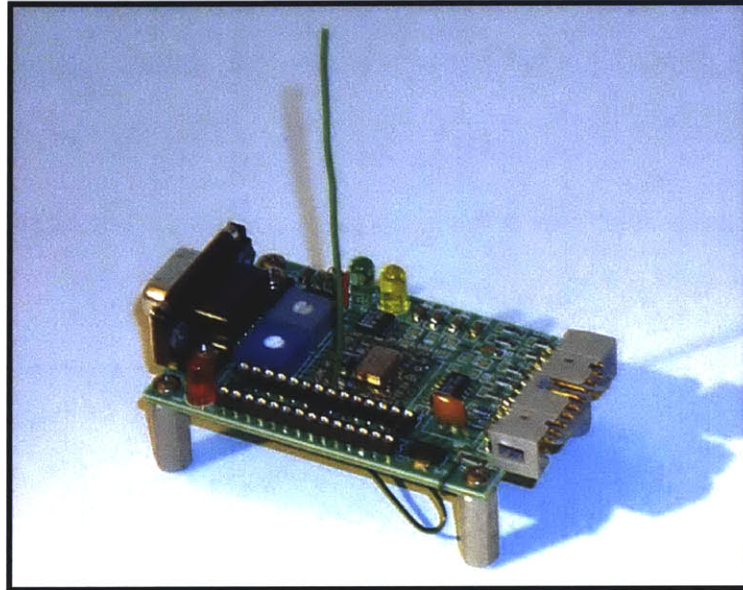

Figure 21: Wireless Transceiver Board

This transceiver board (see *Figure 21*) can be embedded into the devices, making their presence 'transparent' to the user. While the patients use the devices, the base station logs the telemetry to a file and periodically uploads it to a network for their doctors to review. The printed circuit that was designed for this purpose contains a programmable integrated chip (the Microchip PIC16F873) connected to an 868 Mhz RF transceiver chip (the DR3001 from R.F. Monolithics). Twelve digital I/O channels on the PIC capture data from the device and transfer it serially to the transceiver, which then transmits the data to the base station at 19.2 kbps. The board also has an RS-232 serial line driver (the MAX233 from Maxim Integrated Circuits) so that the same circuit board that transmits from the devices can also be used as a receiving base station and communicate with a PC across the room. In most cases, the transceiver electronics can be powered directly off of the batteries in the devices, or in the case of the base station, it could be powered off of the RS-232 connector or an

external supply. Schematics and a PCB layout of the transceiver circuit can be found in *Appendix C*. Also, refer to *Appendix D* for the embedded C code that was developed specifically for this application.

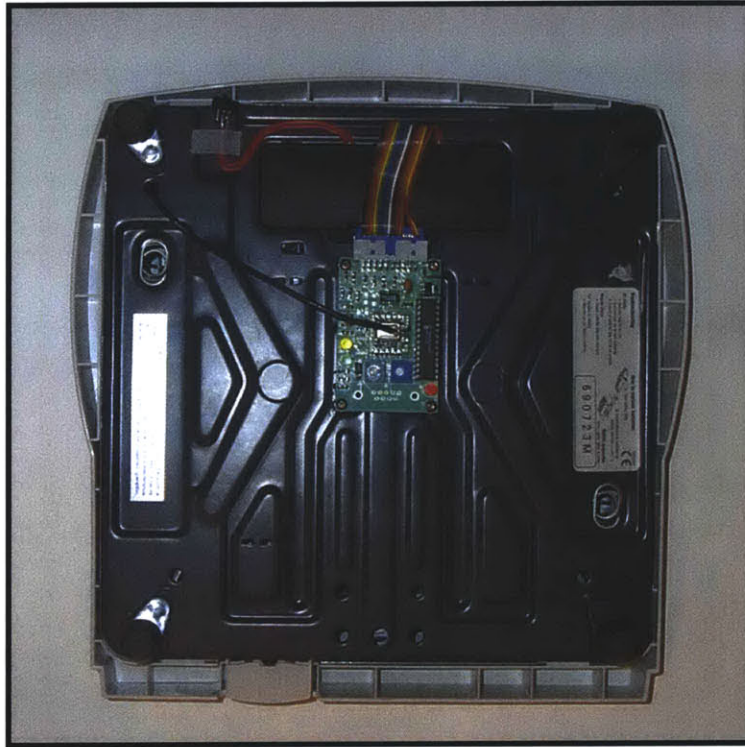

Figure 22: Transceiver Board in Scale

Since the boards have the ability to receive and to transmit data, a simple communications scheme was implemented so that each of the active devices can get their information to the base station without interfering with each other. The base station listens for devices within range every few seconds and all of devices that have data ready to be sent (e.g., a person has taken their weight) transmit their unique IDs. The base station chooses an ID to receive data from (for example device 1) and tells all of the others to stop transmitting until further notice. Once the base station has successfully received data from device 1, it sends a receipt acknowledgment instructing the device to stop sending data and to shut down until it is used again. At this time, the base station sends a signal to the remaining active devices (on and waiting to send data) to transmit their IDs

restarting the cycle. This process is complete when all of the devices have successfully sent their data and are powered down. This scheme was tested with a digital scale and body fat monitor (see *Figures 22 and 23*) by taking the signals coming from the LCD display and decoding them with embedded software running in the PIC²⁶. The data from these devices is subsequently collected by a simple software program (a Java Applet) that posts the information to a secure password-protected website that can be viewed remotely.

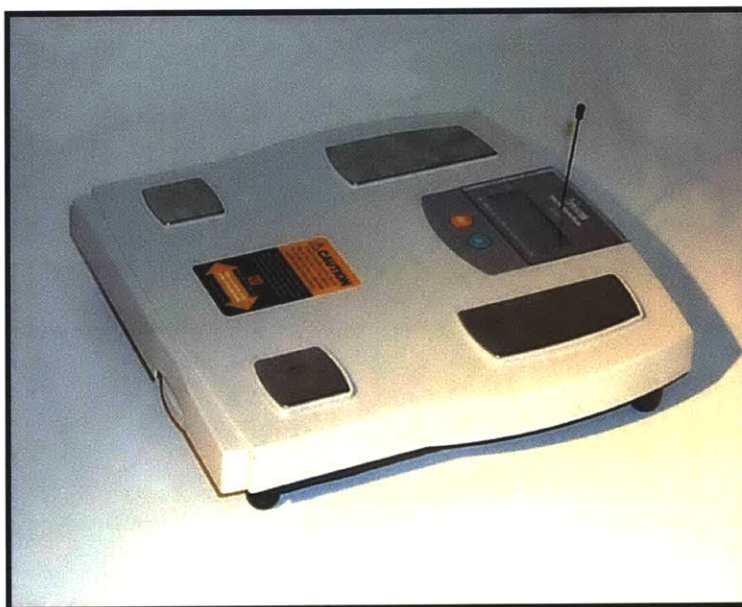

Figure 23: Wireless Scale

For applications like streaming audio from a stethoscope or even images or video from a camera, a higher bandwidth wireless protocol such as Bluetooth™ would allow seamless networking between medical devices²⁷. The Bluetooth protocol

²⁶ This is not the ideal way to capture data, but it works for illustration purposes. Ideally the device would be manufactured with RS-232 or USB output so that it could communicate seamlessly with a PC.

²⁷ Bluetooth™ is a wireless communications specification intended to provide small form factor, low-cost, short-range radio links between mobile PCs, mobile phones and other portable devices. See www.bluetooth.com for more information.

has built in serial, USB and audio interfaces, which would make it easy to adapt medical and other home devices in close proximity so that they could communicate with each other. Bluetooth was not used in our initial prototypes because of the limited availability of development kits at the time and because it interferes with other spread spectrum wireless communications (e.g., 802.11) at the Media Lab.

6

Conclusions

6.1 Summary

A multi-functional, portable telemedicine kit was designed and constructed primarily for use in the developing world. The kit is low-cost (approximately \$8,000) compared to the alternatives that exist today and offers much of the same basic functionality. The kit was designed to the specifications determined by studies of the most common medical diagnostic needs of patients in rural communities of Costa Rica and the Dominican Republic. The kit will be used in conjunction with the LINCOS project, which is bringing first class telecommunications, education and health services into remote areas of developing countries.

The telemedicine kit is not meant to be an optimal solution to all of the health problems of the developing world, but rather an intermediate step towards improving the quality of the primary healthcare delivered in remote areas.

The first telemedicine units that were constructed were prototypes and (almost by definition) will require changes in the future: the hardware and software will be adapted to best fit the end users' needs, the available technologies, the human resources and the communications infrastructure at the locations where they will be used.

Unfortunately, timing was such that we were not able to get much feedback from the telemedicine kits in actual use. As of this time, the telemedicine infrastructure (i.e., the doctors on the other end) in Costa Rica and the Dominican Republic is not finalized. Hopefully this will resolve over the next few months and the first telemedicine consultations will be a success. We did however, get very good

initial feedback and enthusiasm from the practitioners in Costa Rica that will be using the kit to incorporate telemedicine into their consultations in the near future.

Some Important trade-offs were also addressed in relation to the design of the telemedicine system:

1. We concluded that sound, image and video resolution need to be matched carefully to the applications that they will be used for, and that increases in bandwidth and compression capabilities are making this less of an issue.
2. By looking at studies of store-and-forward vs. real-time modes of telemedicine, it was concluded that the store-and-forward method, despite some disadvantages, can be a more cost-effective solution, especially in developing countries.
3. Approval for medical devices was addressed and important (albeit mostly unanswered) questions were raised about the use of non-agency approved devices for medical purposes in developing countries.

Home health monitoring was also addressed by the implementation of a wireless 'pervasive' system for integration into the home. We built a wireless transceiver circuit in order to demonstrate the capability of transmitting low bit-rate medical data from inexpensive home devices to a base station or personal computer that is network-accessible by a doctor. The hardware developed for this purpose was not intended to become a product, but rather to demonstrate the technical feasibility of practicing home telemedicine at a low additional cost. Ideally, all home medical devices will evolve data output ports (RS-232 or USB) so that they can be used for telemedicine in an affordable fashion, or better yet, they will have built-in wireless communications capabilities through a common protocol such as Bluetooth.

Our wireless transceiver hardware was developed in a general fashion in order to be useful for other applications (either other projects in our research group, or in other projects around the Media Lab).

6.2 The Future

The LINCOS project is gaining momentum and is likely to expand its reach in the near future, not only throughout Latin America and the Caribbean, but also to Africa, India and Asia.

If technological advances in the areas of sensing, computation and wireless communications continue at their current rates, then it will not be long before a hand-held medical device like the futuristic 'Tricorder' from Star Trek (which does non-invasive telemedical sensing, computing and wireless communications) could be used for telemedicine and related applications throughout the world. This is an interesting area of future research, as it brings together many different fields and has the potential to help billions of people.

“Telemedicine is changing so fast that it takes [experts in the field] an incredible amount of time just to stay confused [Bauer99, 146].” Because of the rapid rate of technological change, the form that telemedicine will take in the future is uncertain. What is certain, however, is that with cost-effective and appropriate technologies, telemedicine has a huge potential to revolutionize the way healthcare is delivered throughout the entire world.

Appendix A: Telemedicine Kit Electronics

A.1 Signal Diagram

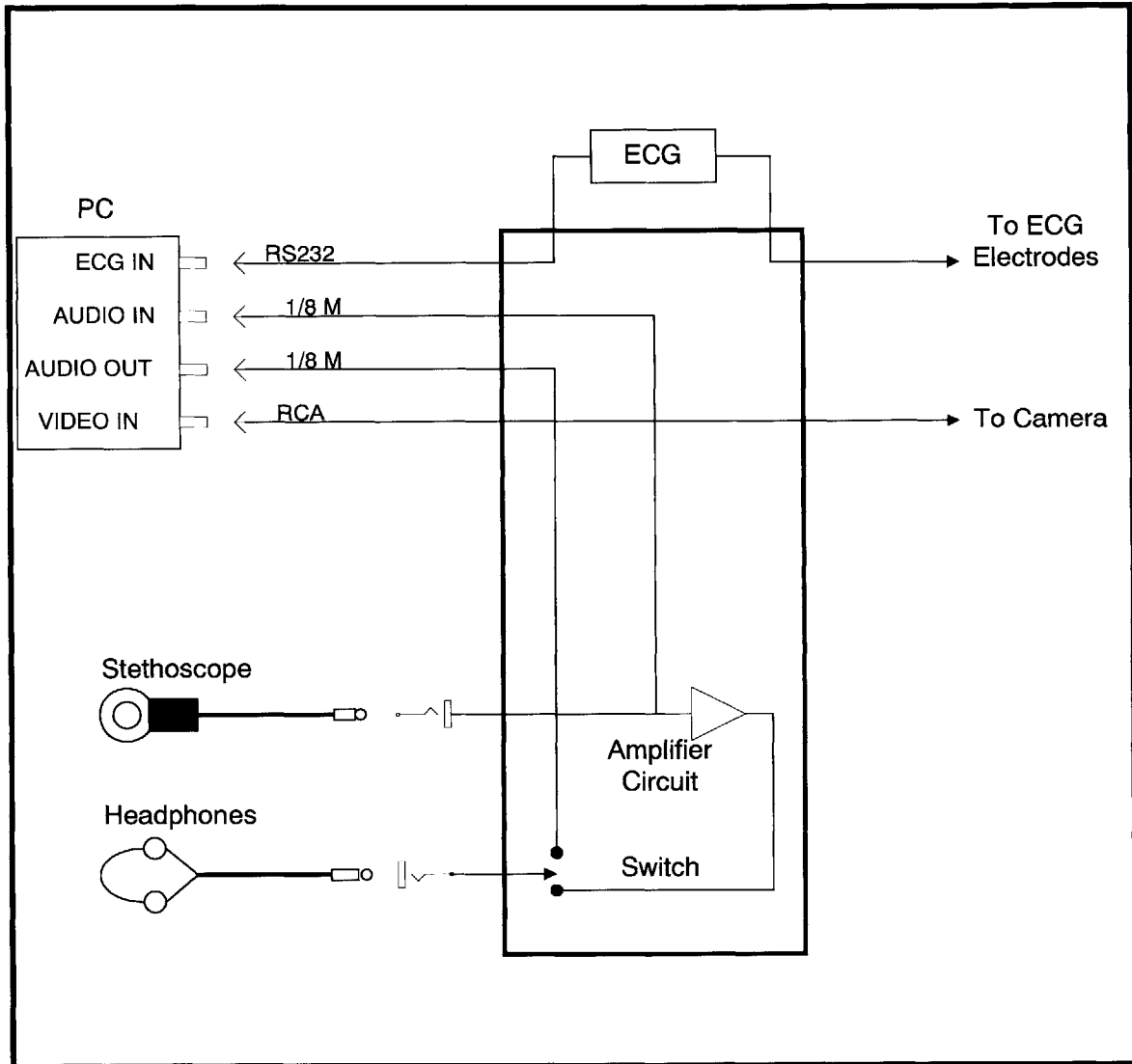

A.2 Power Diagram

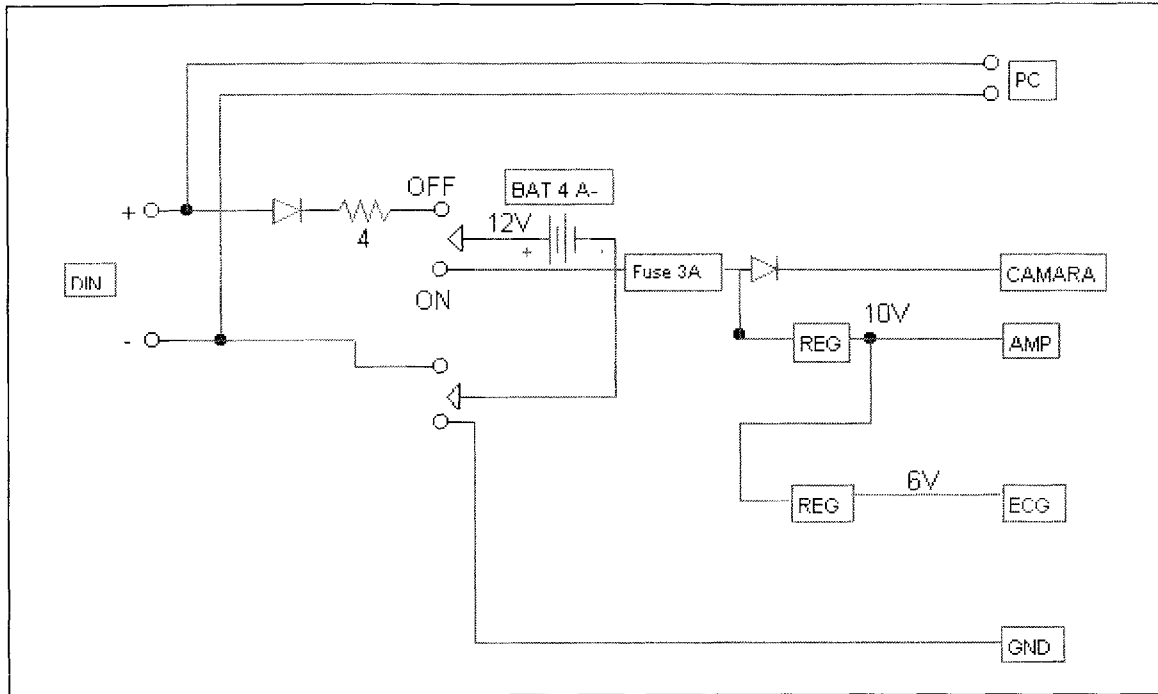

A.3 Stethoscope Amplifier Circuit

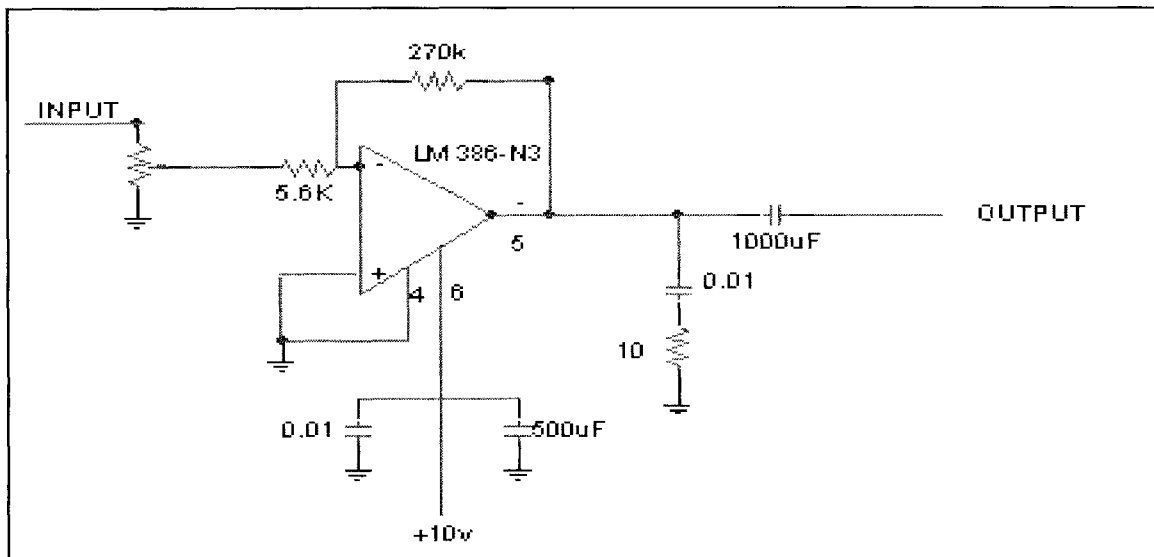

Appendix B: Telemedicine Kit Software

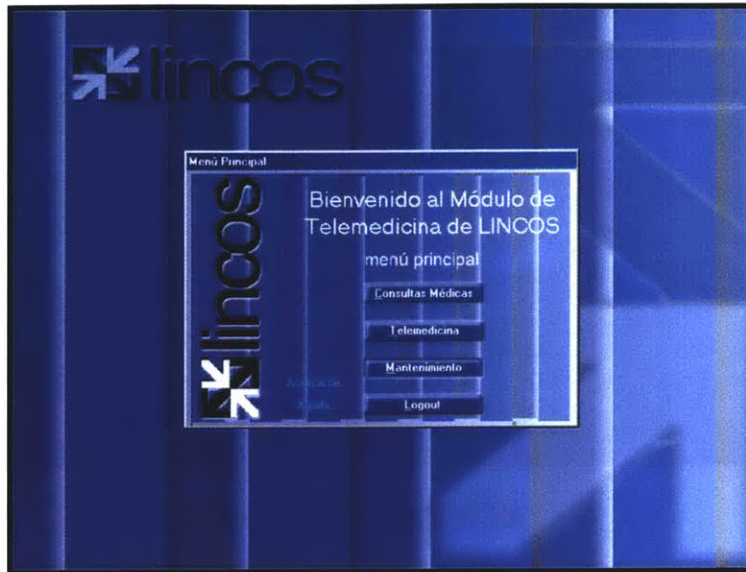

Top Level Choices

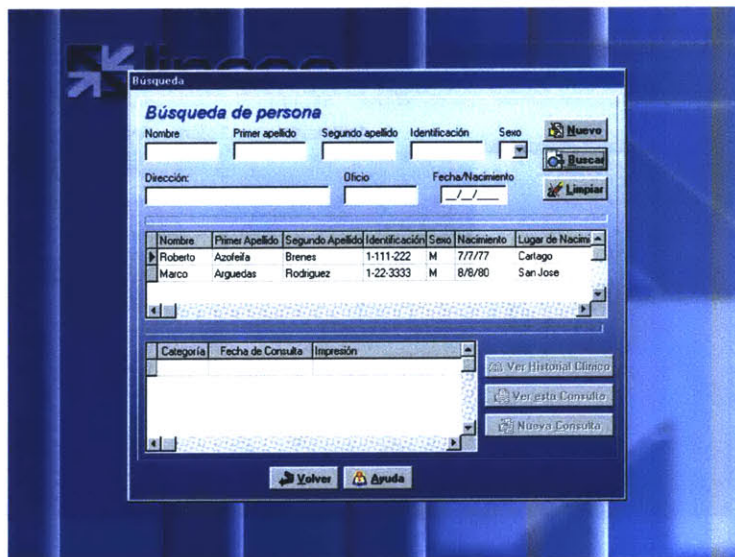

Patient Record Search

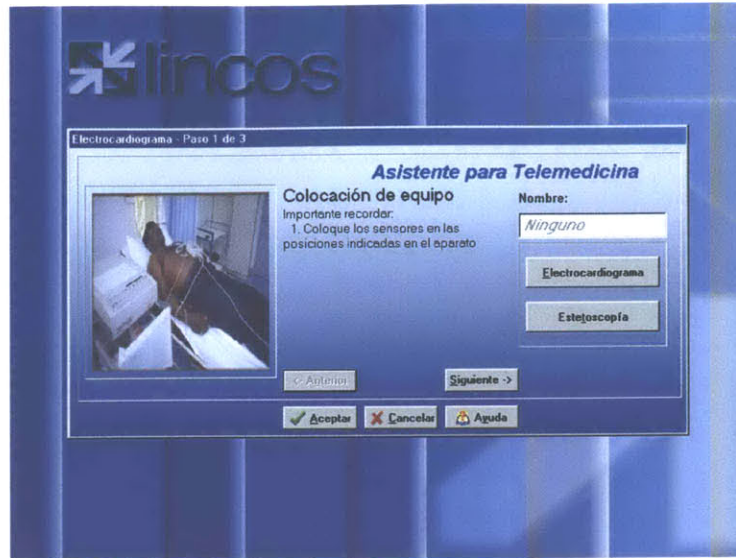

ECG Capture Wizard

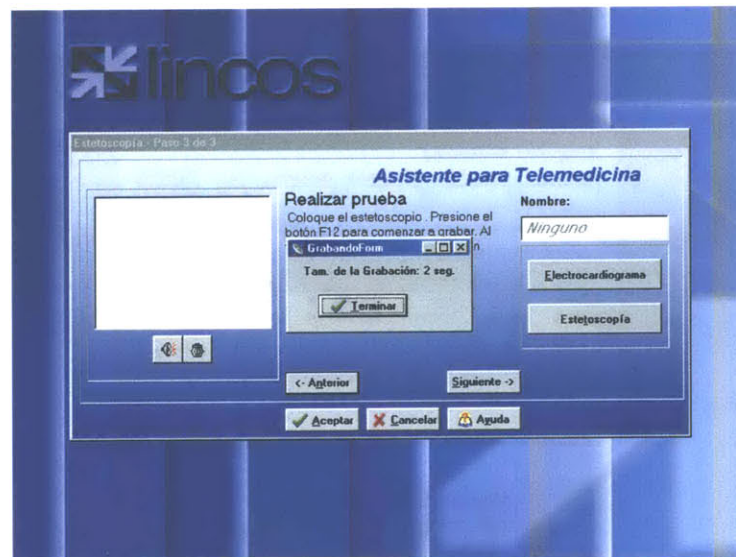

Stethoscope Capture Wizard

Appendix C: Wireless Board Electronics

C.1 Schematic

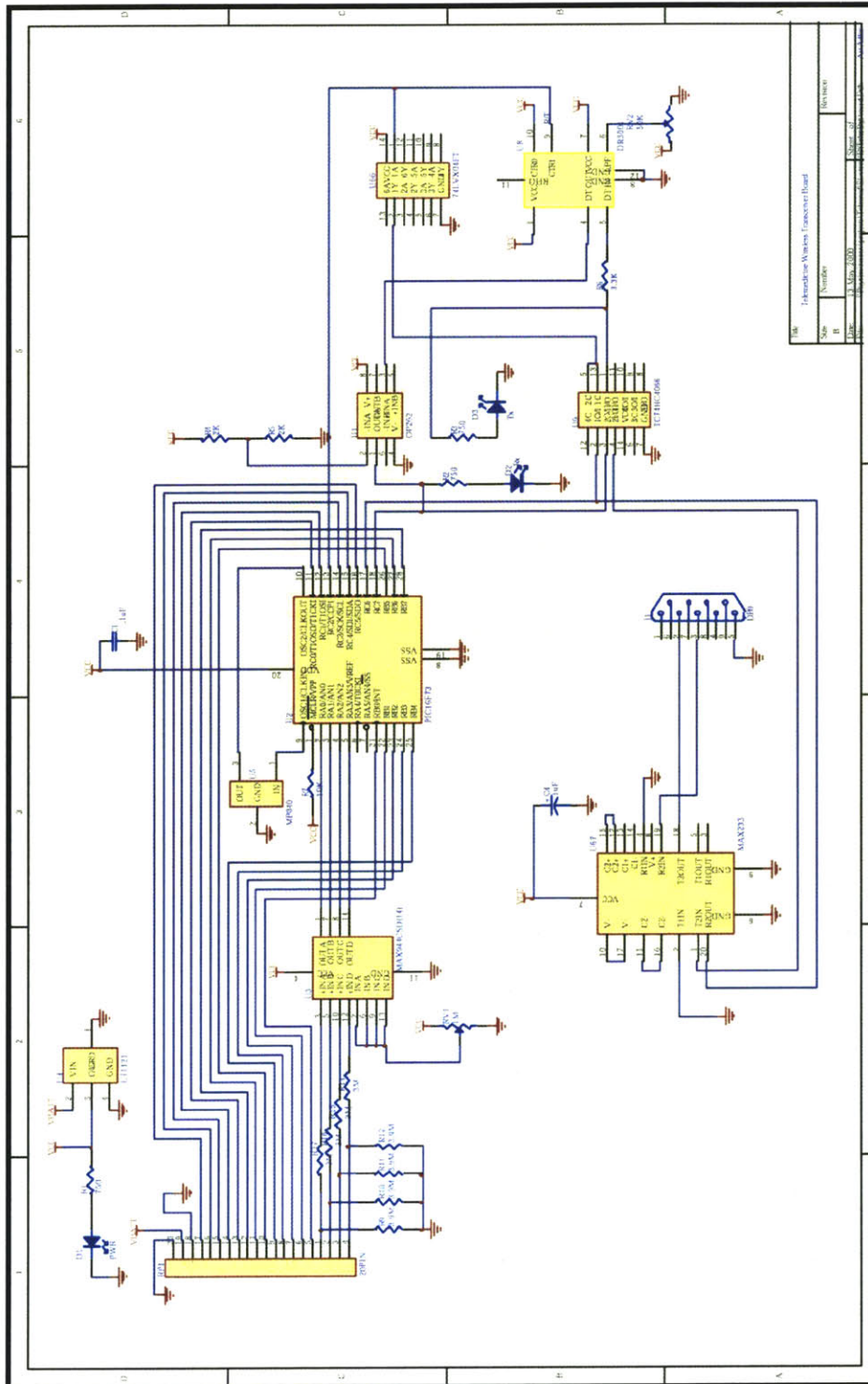

C.2 PCB Front

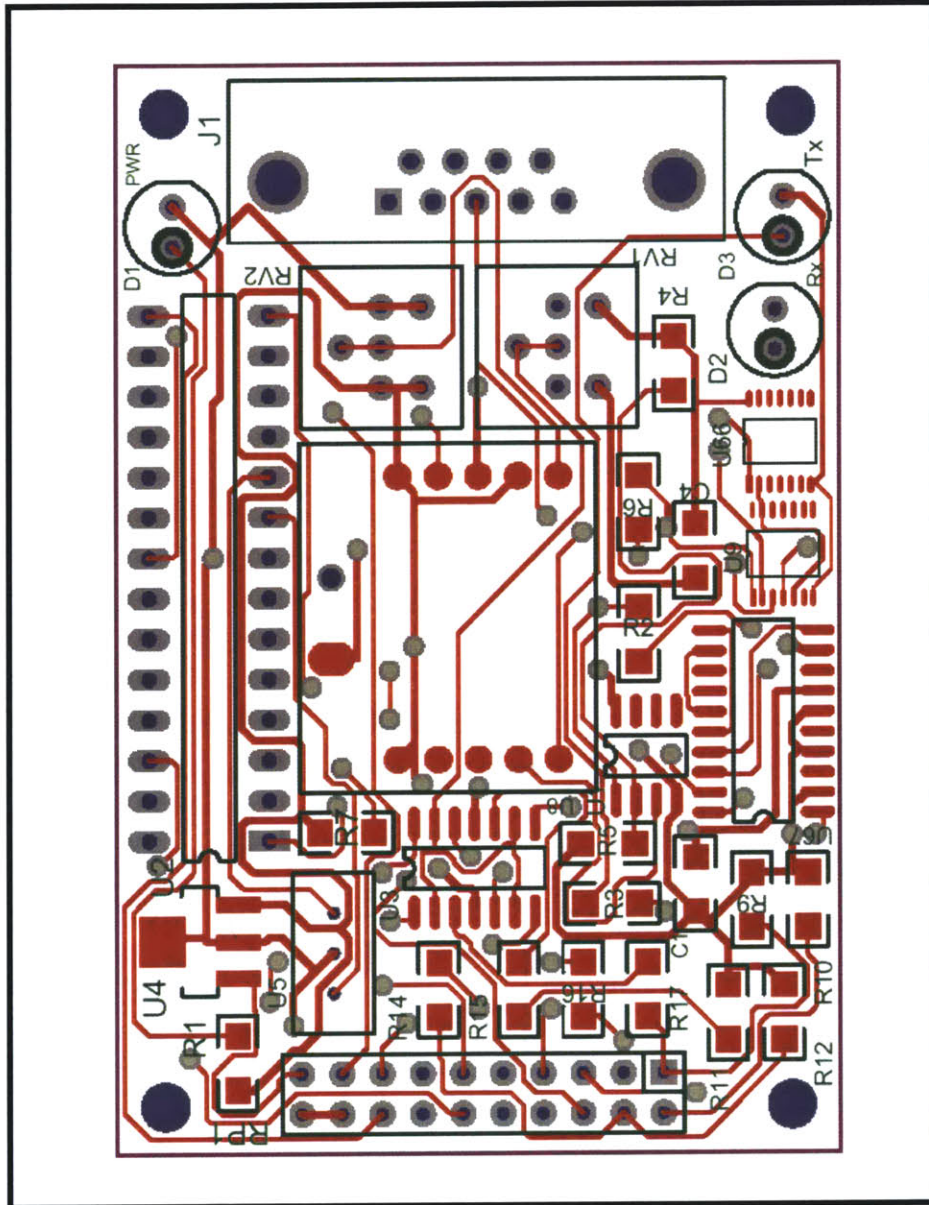

C.3 PCB Back

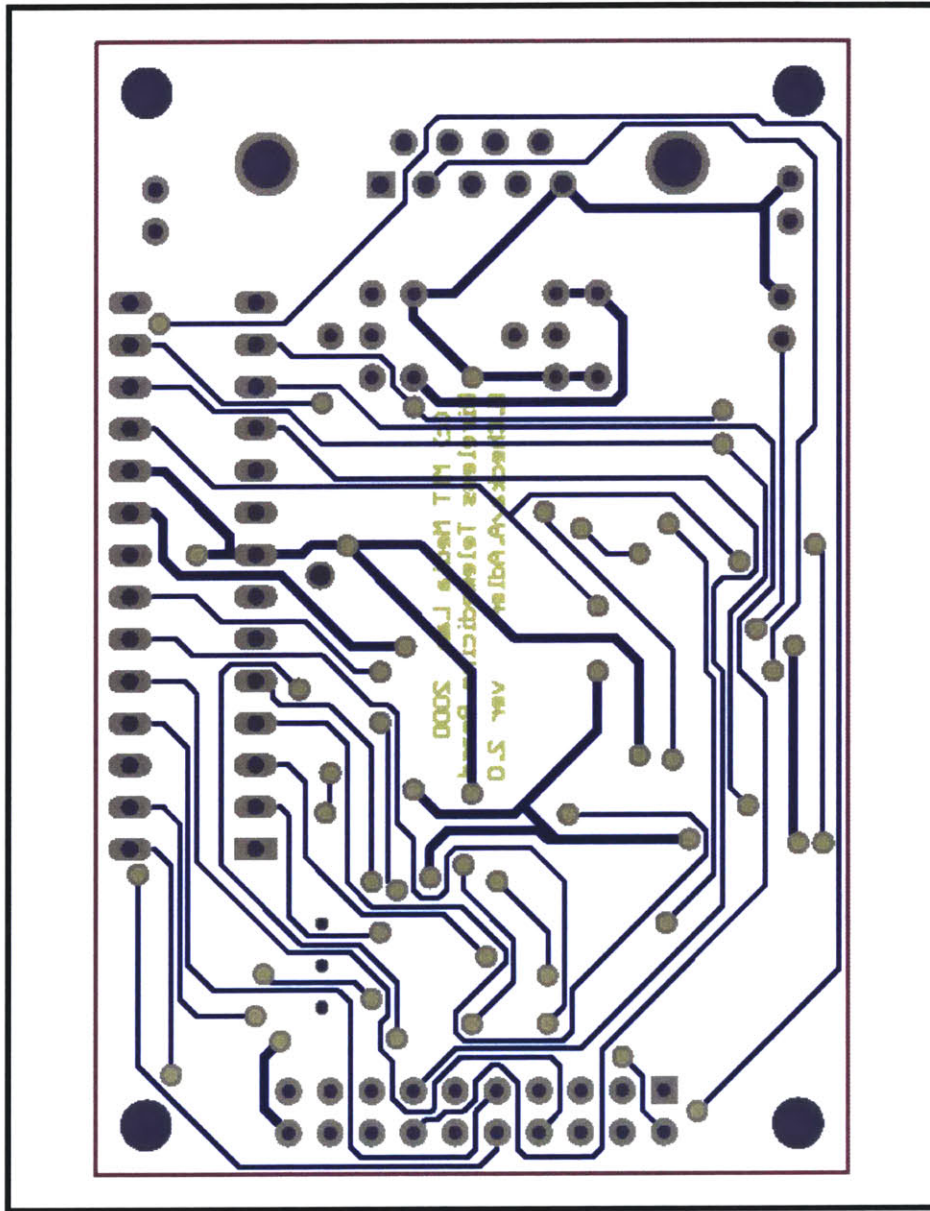

Appendix D: Wireless Telemedicine Software

D.1 Transmitter PIC Code

```
// File: transmit.c
// PIC Transmitter code for digital scale
// Telemedicine Project
// Ari Adler / Nisha Checka
// MIT Media Laboratory
// 4/24/00

#include <16F873.H>

/* Configure PIC to use: HS clock, no Watchdog Timer,
no code protection, enable Power Up Timer
*/

#fuses HS,NOWDT,NOPROTECT,PUT,NOLVP

/* Tell compiler clock is 8MHz. This is required for delay_ms()
and for all serial I/O (such as printf(...)). These functions
use software delay loops, so the compiler needs to know the
processor speed.
*/

#use DELAY(clock=8000000)

/* Declare that we'll manually establish the data direction of
each I/O pin on port B.
*/

#use faction(B)

/* Standard definitions */

#define LCD_EN_0 input(PIN_A0) // (input)
#define LCD_EN_1 input(PIN_A1) // (input)
#define LCD_EN_2 input(PIN_A2) // (input)
#define LCD_EN_3 input(PIN_A3) // (input)

#define LCD_SEG_4 input(PIN_B0) // (input)
#define LCD_SEG_5 input(PIN_B1) // (input)
#define LCD_SEG_6 input(PIN_B2) // (input)
#define LCD_SEG_7 input(PIN_B3) // (input)
#define LCD_SEG_8 input(PIN_B4) // (input)
#define LCD_SEG_9 input(PIN_B5) // (input)
#define LCD_SEG_10 input(PIN_B6) // (input)
#define LCD_SEG_11 input(PIN_B7) // (input)

#define LCD_SEG_12 input(PIN_C0) // (input)
#define LCD_SEG_13 input(PIN_C1) // (input)
#define MODE PIN_C2 // (output)
```

```

#define RS232_XMT    PIN_C6  // (output) RS232 serial transmit
#define RS232_RCV    PIN_C7  // (input)  RS232 serial receive

//Define the ports
#define PORT_A = 5
#define PORT_B = 6
#define PORT_C = 7

//Default tri-state port direction bits:
#define PORT_A_TRIS 0b00111111
#define PORT_B_TRIS 0b11111111
#define PORT_C_TRIS 0b10000011

#define DATA_A (PORT_A & 0b00001111)
#define DATA_B (PORT_B & 0b11111111)
#define DATA_C (PORT_C & 0b00000011)

#define BUFFER 4
#define MAX 27

//    Inform printf() and friends of the desired baud rate
//    and which pins to use for serial I/O.

#define rs232(baud=2400, emit=RS232_XMT, rave=RS232_RCV)

into search[28]={0b00000000, 0b00000001, 0b00000010, 0b11011110,
0b00010100, 0b01111010, 0b01110110, 0b10110100, 0b11100110,
0b11101110,0b01010100, 0b11111110, 0b11110100, 0b11011111, 0b00111111,
0b01111011, 0b01110111, 0b10110101, 0b11100111, 0b11101111, 0b01010101,
0b11111111, 0b11110101,0b11010100,0b11110110, ,0b11010101,0b11110111};

into
match[28]={0,0,5,0,1,2,3,4,5,6,7,8,9,0,1,2,3,4,5,6,7,8,9,7,9,1,7,9};

into construct code(into values[4]);
into lookup(into code);

void main()
{
    float height, weight;
    Boolean en_0, en_1, en_3, b_00, b_01, b_1;
    Boolean finished = FALSE, height done = FALSE, ready = FALSE,
    printing=FALSE, dashon = FALSE, weightdone=FALSE;
    unsigned into i, block_a, block_b, block_c, block_d, bodyfat,
    zero= 0;
    unsigned into block_b_code, block_c_code, block_d_code;
    unsigned into data_a_values[BUFFER], data_b_values[BUFFER];
    unsigned into first_digit_vals[BUFFER],
second_digit_vals[BUFFER],
    third_digit_vals[BUFFER], fourth_digit_vals[BUFFER];

    //since we've declared #use faction(B) (above), we MUST
    //include a call to set_tris_b() at startup.

    SETUP_PORT_A (NO_ANALOGS);
    set_tris_a(PORT_A_TRIS);
    set_tris_b(PORT_B_TRIS);

```



```

set_tris_c(PORT_C_TRIS);

OUTPUT_LOW(MODE); // transmit mode
while (!finished)
{
    // printf("UUUUProcessing\0\r"); //For Debugging
    while (DATA_A!=8) {delay_ms(1);} //wait for start
    for (i=0;i<BUFFER;i++)
    {
        data_a_values[i]=DATA_A;
        data_b_values[i]=~DATA_B;
        first_digit_vals[i] =((~DATA_B&0b00000110)>>1);
        second_digit_vals[i]=((~DATA_B&0b00001100)>>2);
        third_digit_vals[i] =((~DATA_B&0b00110000)>>4);
        fourth_digit_vals[i]=((~DATA_B&0b11000000)>>6);
        delay_us(4200);
    } // end for loop

    en_0 = data_a_values[3];
    en_1 = data_a_values[2];
    en_3 = data_a_values[0];
    b_00 = (data_b_values[3]&0b00000001);
    b_01 = (data_b_values[2]&0b00000001);
    b_1 = (data_b_values[0]&0b00000010);

    // dash is being displayed
    block_b_code = construct_code(second_digit_vals);

    if (block_b_code == 0b00100000) {
        dashon = TRUE;
        bodyfat=0;
        //printf("dash");
    }

else if ((en_0 && b_00) || (en_1 && b_01) || (en_3 && b_1)) {
    // block_a is either 0 or 5:
    block_a = lookup(first_digit_vals[3]);
    block_b_code = construct_code(second_digit_vals);
    block_c_code = construct_code(third_digit_vals);
    block_d_code = construct_code(fourth_digit_vals);

    block_b = lookup(block_b_code);
    block_c = lookup(block_c_code);
    block_d = lookup(block_d_code);

    if (en_0 && b_00) {
        height = 12*block_d + 10*block_c +
            block_b + 0.1*block_a;
        height done = TRUE;
    }
else if ((en_1 && b_01 && ready)||
(en_1 && b_01 && dashon))
{
weight = 100*block_d + 10*block_c + block_b +
0.1*block_a;
finished = height done;
weightdone = TRUE;
}
}

```

```

    }
    else if (en_3 && b_1)
{
        bodyfat = 10*block_c + block_b;
        if (bodyfat < 50)
            ready = TRUE;
        else {
            bodyfat = 0;
            ready = FALSE;
        }
    }
} // end if

i = 0;
zero = 0;

if (finished || (dashon && weightdone))
{
    printf("UUUUhh=%1.1f inches      UUUUw=%1.1f lbs      UUUUbf=%u%%\0\r",
height, weight, bodyfat);
        delay_ms(1000);
    }
} // end while finished

} // end main

unsigned into construct code(into values)
{
    return (values[0]<<6)+(values[1]<<4)+ (values[2]<<2) + values[3];
}

into lookup(into code) {
    into i = 0;
    Boolean done = FALSE;
    while (!done) {
        done = (code == search[i]);
        if (done) {
            return match[i];
        } else if (i == MAX) {
            //printf("\rUNRECOGNIZED CODE\r");
            return 99;
        }
        else i++;
    } // end while
    return 99;
} // end look_up

```

D.2 Receiver PIC Code

```
// File: receive.c
// PIC Receiver code
// Telemedicine Project
// Ari Adler / Nisha Checka
// MIT Media Laboratory
// 4/24/00

#include <16F873.H>

/* Configure PIC to use: HS clock, no Watchdog Timer,
   no code protection, enable Power Up Timer */

#fuses HS,NOWDT,NOPROTECT,PUT,NOLVP

/* Tell compiler clock is 4MHz. This is required for delay_ms()
   and for all serial I/O (such as printf(...)). These functions
   use software delay loops, so the compiler needs to know the
   processor speed. */

#use DELAY(clock=8000000)

/* Declare that we'll manually establish the data direction of
   each I/O pin on port B. */

#use faction(B)

/* Standard definitions */

#define RS232_XMT PIN_C6 // (output) RS232 serial transmit
#define RS232_RCV PIN_C7 // (input) RS232 serial receive

//Define the ports
#byte PORT_A = 5
#byte PORT_B = 6
#byte PORT_C = 7

//Default tri-state port direction bits:
#define PORT_A_TRIS 0b00111111
#define PORT_B_TRIS 0b11111111
#define PORT_C_TRIS 0b10000011

#define DATA_A (PORT_A & 0b00001111)
#define DATA_B (PORT_B & 0b11111111)
#define DATA_C (PORT_C & 0b00000011)

#define BUFFER 4

// Inform printf() and friends of the desired baud rate
// and which pins to use for serial I/O.

#use rs232(baud=2400, emit=RS232_XMT, rave=RS232_RCV)
void main()
{
    char word[50];
```

```
char character;

//since we've declared #use faction(B) (above), we MUST
//include a call to set_tris_b() at startup.

SETUP_PORT_A (NO_ANALOGS);
set_tris_a(PORT_A_TRIS);
set_tris_b(PORT_B_TRIS);
set_tris_c(PORT_C_TRIS);

OUTPUT_HIGH(MODE);

while (true)
{
    if(kbhit()){
        character=getchar();
        putchar(character);
    }
} // end while true
} // end main
```

D.3 Base Station C Code

```
// File: station.c
// Base station file used to read data from serial port
// Telemedicine Project
// Ari Adler / Nisha Checka
// MIT Media Laboratory
// 4/24/00

#include <windows.H>
#include <stdio.h>
#include <string.h>

HANDLE hPort;

// Forward declerations
HANDLE PortInitialize(LPTSTR lpszPortName);
BOOL PortClose(HANDLE hCommPort);
into ReadBytes(HANDLE port,BYTE* buff,DWORD toRead,DWORD maxreads);

into main(into argc, char ** argv)
{
    char buff[50];
    Boolean done = FALSE;
    char name[40];
    char cont;
    into retval;
    char* location;
    char data[50];
    into diff =0;
    float h,w;
    into bf;

    hPort = PortInitialize("COM3:");
    if(hPort != NULL)
    {
        printf("COM3 opened\n");
    }

    while(!done)
    {
        retval = ReadBytes(hPort,buff,54,1000);
        if(retval>=1)
        {
            buff[54] = '\0';
            location=strstr(buff,"h=");

            if(location!=NULL)
            {
                diff=retval-(location-buff);
                strcpy(data,location);
                ReadBytes(hPort,data+diff,45-diff,0);
                data[49]='\0';
                sscanf(data,"h=%f inches    UUUUw=%f lbs    UUUUbf=%i%%",&h,&w,&bf);
            }
        }
        else continue;
    }
}
```

```

        printf("Height= %.1f inches\n",h);
        printf("Weight= %.0f lbs\n",w);
        printf("Body Fat= %i%%\n",bf);

printf("Would you like to continue [y/n]\n?");
cont = getchar();

        if (cont == 'n')
        {
            done = TRUE;
            printf("done");
            PortClose(hPort);
            break;
        }
        else
{
    done = FALSE;
        printf("waiting for data...");
    }

        }
        else
        {
            //printf("Read nothing\n");
        }
    }

    PortClose(hPort);

    return 0;
}

```

Appendix E: Component Specifications

E.1 AMD 2500 General Examination Camera

AMD-2500 General Examination Camera

The multi-specialty camera with built-in freeze-frame & polarization

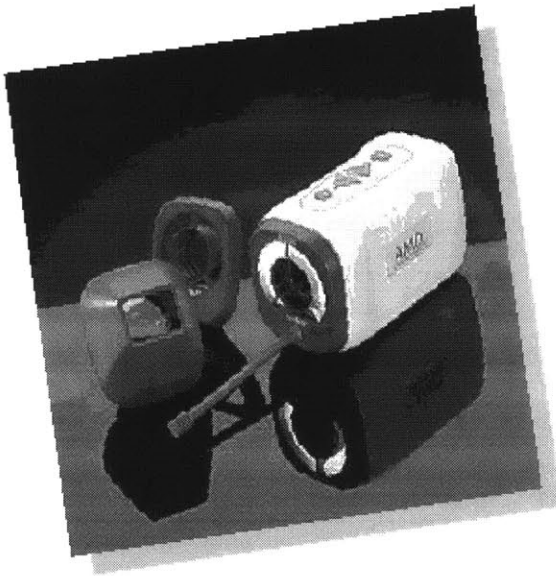

The AMD-2500 video imaging system is the first camera to combine power zoom, auto focus, frame capture and electronic image polarization in one device.

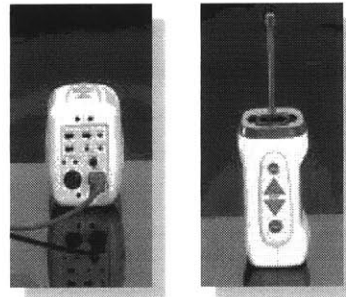

POWER ZOOM

Push-button 1-50x zoom allows both close focus and wide angle images.

AUTO FOCUS

The camera automatically stays in focus for ease of use.

FREEZE FRAME

Freeze frame delivers the clearest possible image, making it ideal for both low and high bandwidth solutions. The integrated freeze frame button on the camera instantly captures an image without the use of a keyboard or mouse.

ACCURATE COLORS

One-button white balance sets highly accurate colors quickly and easily.

POLARIZATION

Elimination of surface skin reflection allows camera to see further into epidermal layers.

TOUCH AND VIEW

The AMD-2500 includes manual or automatic iris control to maximize image brightness.

AMD

AMERICAN MEDICAL DEVELOPMENT

Premier Telemedicine Products and Services

AMD-2500 General Examination Camera

The multi-specialty camera with built-in freeze-frame & polarization

Options

- Contact 200x polarized lens
- Tripod
- Camera stand
- PAL converter

*Actual images taken with the
AMD-2500 General Examination Camera.*

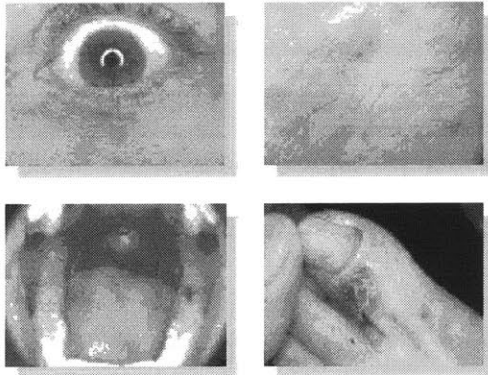

Specifications

Magnification: Auto-zoom from 1-50X.

Polarization: Push-button

Zoom: Push-button

Pixels: 410,000 from a 1/4" CCD

Horizontal Resolution: Greater than 430 lines

Signal to noise ratio: Greater than 48dB

Output Signal: Composite and S-Video

Output Format: NTSC

Integrated freeze-frame: Push-button

Color Adjustments: Auto white balance

AGC: Full iris control

Lighting: Fluorescent

Operating Temperature Range: 0°C-40°C

Operating Humidity: Less than 90%

Power Consumption: 5W

Voltage Range: 110/220VAC \pm 10%, 50/60 Hz,
or 12VDC

Dimensions: 2.2" W x 3.7" D x 2.9" H

Weight: .5 lbs.

Lens: General purpose lens close focus 50x
polarized lens

AMD

AMERICAN MEDICAL DEVELOPMENT

Premier Telemedicine Products and Services

67 Middle Street, Lowell, MA 01852 USA
800-742-1674 • 978-937-9021

Fax: 978-937-5249 • Video: 978-454-8409
info@americanmeddev.com • www.americameddev.com

E.2 Agilent Stethos

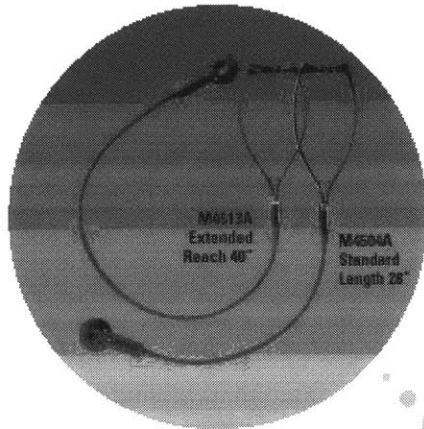

Agilent Stethos Fully Electronic Stethoscopes

Up to 14 times Amplification of Conventional Acoustic Stethoscopes

Extending the Reach of Care

The Agilent Stethos (Part Numbers M4504A and M4513A) is a fully electronic stethoscope which amplifies heart and other biological sounds up to 14 times that of acoustic stethoscopes.

Through its microelectronic design, the Agilent Stethos eliminates sound loss and resonance effects associated with acoustic stethoscopes.

Available in a standard version (28" length) and a long version (40" length), Stethos offers the user added versatility to accommodate various clinical demands without compromising high quality sound and clarity.

Programmable Amplification Level allows clinicians to set the amplification level best suited to their hearing.

Impact Muting feature also protects the clinician's hearing by muting high intensity impact noises.

With the push of a button, the Agilent Stethos allows mode changes without interrupting auscultation.

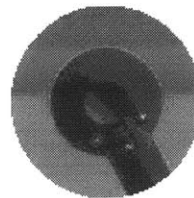
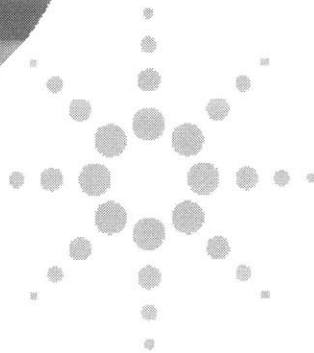

Eight levels of sound amplification with three modes of operation, allows the user to select frequency response from:

- *Ball mode* for low frequency associated with various cardiac sounds;
- *Diaphragm mode* for midrange frequencies associated with lung sounds and other low amplitude sounds;
- *Extended Diaphragm mode* for higher frequency sounds often associated with mechanical valve prosthesis.

Agilent Stethos uses three standard 357 batteries. Auto Shutoff helps to conserve battery life. The Agilent Stethos has a built-in low battery warning system which indicates when batteries need replacement, approximately one year battery life under normal use.

Patented Adjustment Ring and ergonomically designed earpieces seal out external sounds for optimum sound transmission. Soft or firm earpieces in two sizes provided for clinician comfort.

Non-chill Ring on flat Diaphragm improves patient comfort.



Agilent Technologies
Innovating the HP Way

Agilent Stethos

Technical Specifications

Features:

Auto Shut off	2 minutes
Anti-tremor filter	40Hz
Auto Mute	120 dB S.P.L
Low Battery Detector	When Agilent Stethos is powered on, if both red and green LED's blink 3 times, indicates a low battery condition
Volume Levels	8
Default Volume	Configurable

Mode:

Diaphragm	100Hz-360Hz
Bell	45Hz-230Hz
Extended	150Hz-200Hz

Mechanical:

	M4504A	M4513A
Weight	165g.	185g.
Length*	28"/71.12cm	40"/102cm

* Length = total length from ear tips to and including chestpiece

Power:

Energy Source	Battery
Consumption	Approx. 1 Year*

* Normal usage is considered to be twenty auscultations of 2 minutes per workday.

Environmental:

Operating Temperature	-5°C to 60°C
Operating Humidity	20 to 95% RH
Operating Altitude	up to 4550m
Storage Temperature	-40°C to 70°C
Storage Humidity	15 to 95%RH
Storage Altitude	up to 4550m

Regulatory:

Safety	EN 60601-1
EMC	EN 60601-1-2
Biocompatibility	EN 30993
CSA	C22.2no601.1-M90
UL	2501-1

Replacement Parts:

+M4504-60050	Replacement 357 Batteries
+M4504-60000	Ear tips soft 12.7mm
+M4504-60010	Ear tips firm, 13.3 mm
+M4504-60020	Diaphragm
+M4504-60030	Non-chill ring
+M4504-60040	Battery cover
+M4504-91000	User's manual

For more information visit
www.agilent.com/healthcare/stethos

North America

United States Headquarters:
Agilent Technologies
Healthcare Solutions Group
3000 Minuteman Road
Andover, MA 01810
Agilent Medical Supplies
1-800-225-0230
M-F, 8am-7pm EST

Canada:

Agilent Technologies (Canada) Ltd.
5150 Spectrum Way
Mississauga, Ontario L4W 5G1
1-800-387-3154 (Canada-wide)
(905) 206-4747 (Toronto)
M-F, 8am-6pm EST

Latin America:

Agilent Technologies
5200 Blue Lagoon Drive, Suite 950
Miami, FL 33126
(305) 267-4220

Asia Pacific:

Agilent Technologies Asia Pacific Ltd.
17-21/F Shell Tower, Times Square
1 Matheson Street, Causeway Bay
Hong Kong
(+852) 2569 7777

Europe

Agilent Medical Supplies Inquires
Agilent Technologies GmbH
Herrenberger Strasse 110-140
71034 Böblingen, Germany
(+49) 7031 14-5151
(FAX) (+49) 7031 14-2346

European Headquarters:

Agilent Technologies S.A.
150 Route du Nant - d'Avril
CH-1217 Meyrin 2
Geneva - Switzerland

Copyright © 2000 Agilent Technologies
Printed in USA 2/00
A-M4504-91050-1 Rev. 2
♻️ Printed on recycled paper
5928-69250

 Latex-Free

 No PVC

 This product complies with the requirements of the Council Directive 93/42/EEC of 14 June 1993 (Medical Device Directive)

 Complies with CAN/CSA-C22.2no 601-1-M90 and UL 2501-1 standards

 Type BF: Degree of protection against electric shock



Agilent Technologies
Innovating the HP Way

E.3 AMD-3875 ECG



Dimensions: 7.10" x 5" x 1.3"

Weight: 0.84 lbs. (.038kg)

Power / Electrical: 4 AA alkaline batteries

Intended Use: Resting Electrocardiogram

Anatomical Sites: Non-invasive device,
12-lead electrocardiogram

Safety Characteristics:

Patient electrically isolated from mains.

Patient leakage current $<10\mu\text{A}$

Ground leakage current $<50\mu\text{A}$

ECG Acquisition: Simultaneous 12-lead

Patient Connection: 10-lead patient cable
with RFI filter, defibrillator protection and
patient isolation.

Input Impedance: $>100\text{ M}\Omega$

Frequency response: 0.05-110 Hz

Sensitivity: 5, 10, 20mm/mV

ADC resolution: 2.44 μV /bit

Analysis & Measurement:

Telemedicine Electrocardiogram

Related Internet Links

Telemedicine

American Telemedicine Association
FDA Medical Devices
NASA Telemedicine Gateway
Telehealth Magazine
Telemedicine Information Exchange
Telemedicine Today Magazine

www.atmeda.org
www.fda.gov/cdrh
www.nttc.edu/telemed.html
www.telemedmag.com
www.tie.org
www.telemedtoday.com

Commercial

Agilent
American Medical Development
American Medical Development
Bluetooth SIG
Brentwood Medical
Cygnus
Cyrano Sciences Website
DeLorme
Handspring
Maxim
Nogatech
Palm Computing
Pelican Cases
RF Monolithics

www.agilent.com
www.americanmeddev.com
www.americanmeddev.com
www.bluetooth.com
www.brentwoodmed.com
www.cygn.com
www.cyranosciences.com
www.delorme.com
www.handspring.com
www.maxim-ic.com
www.nogatech.com
www.palm.com
www.pelican.com
www.rfm.com

Research

Author's homepage
LINCOS Project
Media Laboratory
MIT
Responsive Environments Group

www.media.mit.edu/~aadler
www.lincos.net
www.media.mit.edu
www.mit.edu
www.media.mit.edu/resenv

Bibliography

- [Allen96] Ace Allen and Glenn Wacheter. *Peripheral Devices*. Telemedicine Research Center, Telemedicine Today, 1996.
- [Argy99] Odysseus Argy and Michael P. Caputo, Jr. *The Global Application of Video Conferencing in Health Care*. American Telemedicine Association, January 1999.
- [Bashshur75] R.L. Bashshur, *et al.* *Telemedicine: Explorations in the use of telecommunications in health care*, 1975. Springfield, IL: Charles C. Thomas.
- [Bashshur97] R.L. Bashshur, J.H. Sanders, G.W. Shannon. *Telemedicine: Theory and Practice*. 1997. Charles C. Thomas Publishers.
- [Bauer99] Jeffrey Bauer and Marc Ringel. *Telemedicine and the Reinvention of Healthcare*. 1999. McGraw-Hill.
- [Buchanan84] B. G. Buchanan and H. Shortliffe. *Rule-Based Expert Systems: The MYCIN Experiments of the Stanford Heuristic Programming Project*. Addison-Wesley, Reading, MA, 1984.
- [Chen98] Elaine Chen and Beth Marcus. *Force Feedback for Surgical Simulation*. IEEE Proceedings, 86(3), March 1998, pp. 524-530.
- [Dakins98] Deborah Dakins and Kathy Kincade. *The Best in the US: Programs of Excellence*. Telemedicine Magazine, December, 1997.
- [Dutta99] A. Dutta-Roy. *Networks for Homes*. IEEE Spectrum , Volume: 36 Issue: 12 , Dec. 1999, pp 26 –33.
- [Dye98] Timothy Dye, *et al.* *LINCOS Costa Rica: Rapid Assessment Process*, December 1999.
- [Dye99] Timothy Dye, *et al.* *LINCOS Dominican Republic: Training in Rapid Assessment Procedures*. LINCOS project Document, University of Rochester, March 1999.
- [Fletcher98] Rich Fletcher. *Health Care Initiatives for the Costa Rican Foundation for Sustainable Development*. LINCOS project document. January 1998.

- [Freiherr97] Greg Freiherr. *Telemedicine: Seeking to Prove Itself in Niche Markets*. Medical Device & Diagnostic Industry Magazine, 1997.
- [Gibbs97] W. Wayt Gibbs. *Critters on a Chip*. Scientific American Explorations. July, 1997.
www.sciam.com/explorations/072897biosens/gibbs.html
- [Haartsen00] J.C. Haartsen. *Bluetooth Radio System*. IEEE Personal Communications, Vol. 7, No. 1, February 2000, pp. 28-36.
- [Kirkman99] Geoffrey Kirkman. *It's More Than Just Being Connected: A Discussion of Some Issues of Information Technology and International Development*. Center For International Development, Harvard University. August 1999.
- [Krupinski99] Elizabeth A. Krupinski, et al. *Diagnostic Accuracy and Image Quality Using a Digital Camera for Teledermatology*. Telemedicine Journal, 1999; 3: pp.257-263.
- [Lau98] Matthew Lau. *GeoPak: Monitoring Climbers and Climate on Mount Everest*. Masters of Engineering Thesis, MIT Department of Electrical Engineering and Computer Science, 1998. Cambridge, MA
- [Nagle88] H.T. Nagle, et al. *The How and Why of Electronic Noses*. IEEE Spectrum, vol.35, no.9, Sept. 1998, pp.22-31.
- [Negus00] Kevin J. Negus, et al. *Home RF: Wireless Networking for the Connected Home*. IEEE Personal Communications. Feb 2000; 20-27.
- [Proakis94] John G. Proakis and Masoud Salehi. *Communication Systems Engineering*, 1994. New Jersey: Prentice Hall.
- [Studer99] Mary Ann Studer. *The Evolution of Telemedicine in Celestial and Terrestrial Realms*, 1999.
www.space.edu/public/publications/abstracts/jensen/studer.html
- [Webster99] Phyllis Webster, et al. *Efficiency Analysis of a Multi-Specialty Telemedicine Service*. Telemedicine Journal, 1999; 3: pp.265-271.
- [Wright97] David Wright. *Telemedicine and Developing Countries: A report of Study Group of the ITU Development Sector*, December 1997.