

PFC/RR-87-9

UC20E

CONSEQUENCES OF A LITHIUM SPILL INSIDE  
THE CONTAINMENT AND VACUUM TORUS OF  
A FUSION REACTOR\*

Sean Barnett and Mujid S. Kazimi

June 15, 1987

Plasma Fusion Center  
Massachusetts Institute of Technology  
Cambridge, Massachusetts 02139 USA

\*This work was supported by EC&G Idaho, Inc. and the  
U.S. Department of Energy, Idaho Operations Office  
under DOE Contract No. DE-AC07-76ID01570

Reproduction, translation, publication, use and disposal,  
in whole or in part, by or for the United States  
government is permitted.

## Abstract

*A parametric study of the temperature and gas pressure profiles inside a fusion reactor containment during a lithium fire was performed using the LITFIRE code. LITFIRE is a one dimensional heat transfer code developed at MIT to model lithium fires in reactor containments. The parameters varied in the study to determine their effects on the temperature and pressure histories were: initial lithium temperature, mass of lithium spilled, area of lithium pool, and containment building volume. It was found that the mass of lithium spilled had the greatest effect on the temperature and pressure histories of the containment. As the amount spilled was increased from 10,100 kg to 43,900 kg, the maximum containment wall temperature went from just over 250 C to over 550 C and the maximum gas pressure increased from approximately 150 kPa to just under 250 kPa. Thus it would be highly desirable to limit the amount of lithium spilled in the event of an accident.*

*A study was also performed of the consequences of a lithium spill and fire inside the vacuum torus of a fusion reactor. It was assumed that the reactor blanket had been punctured through from the containment to the plasma chamber and that lithium had spilled into the torus and caught fire. In that study it was necessary to modify LITFIRE to account for the large heat capacities of the unspilled lithium and the blanket and shield structure. The parameter varied during the study was the crack size between the containment and the vacuum torus. It was found that the consequences of such a fire were not catastrophic regardless of crack size, and that cracks under 10 cm<sup>2</sup> in area tended to suppress the fire by limiting its supply of air.*

## Table of Contents

	<u>Page No.</u>
Abstract	2
Table of Contents	3
I Introduction	4
II Spill and Fire inside the Containment Building	5
II.1 Range of Study	5
II.2 Results	9
II.2.1 Lithium Spill Temperature	9
II.2.2 Lithium Spill Size	9
II.2.3 Containment Volume	21
II.2.4 Lithium Spill Area	26
II.3 Conclusions	31
III Lithium Spill and Fire inside a Vacuum Torus	31
III.1 Changes made to LITFIRE	32
III.2 Reactor Parameters and Initial Conditions	36
III.3 Results	37
III.4 Conclusions	47

## CONSEQUENCES OF A LITHIUM SPILL INSIDE THE CONTAINMENT AND VACUUM TORUS OF A FUSION REACTOR

### I. Introduction

The study of the effects of a lithium fire on the components and containment of a fusion reactor is of interest because of the advantages of lithium as a tritium breeder and blanket coolant in D-T fusion reactors. Lithium, however, reacts with nitrogen (196 J/mole at 25 C to form  $\text{Li}_3\text{N}$ ) and oxygen (589 J/mole at 25 C to form  $\text{Li}_2\text{O}$  and 627 J/mole to form  $\text{Li}_2\text{O}_2$ ) [1]. Thus a lithium spill would lead to a fire within the containment building if the building did not contain an inert atmosphere. Such a fire could potentially damage reactor components through overpressurization of compartments and melting or even vaporization of the structure near the fire.

The LITFIRE code was developed at MIT to model the effects of a lithium spill and fire on the containment of a fusion reactor. LITFIRE was originally a modification of SPOOL-FIRE, a code used to model sodium fires in fast breeder reactors. SPOOL-FIRE was modified to include nitrogen and water vapor reactions, and a combustion zone into which the gases and lithium vapor diffuse and burn. The effects of containment aerosols on radiative heat transfer were also taken into account [2].

LITFIRE is a one dimensional heat transfer code that models heat transfer between nodes representing various components in the containment building. the heat source is the combustion of the lithium, and the heat sink is the atmosphere. Heat transfer by

conduction, convection and radiation is modeled as follows:

$$\text{conduction: } \frac{dq}{dt} = k.A \frac{dT}{dx}$$

$$\text{convection: } \frac{dq}{dt} = h.A(T_{n+1} - T_n)$$

$$\text{radiation: } \frac{dq}{dt} = \sigma.A(T_{n+1}^4 - T_n^4)$$

where  $n$  and  $n + 1$  indicate adjacent heat transfer nodes.

Each node has a heat capacity and an average temperature. The thermal resistances between nodes are calculated by the code from the physical properties and geometry input by the user. The heat transfer paths for one and two cell LITFIRE are shown in Figures 1 and 2 [3].

LITFIRE also models the mass flow between the lithium pool, combustion zone and primary gas cell, and between primary and secondary gas cells in the two cell version. Mass flows are shown in Figure 3 [3].

Temperature and pressure histories are determined by a set of coupled, simultaneous differential equations. The integrations in LITFIRE are performed by using Simpson's Rule or a fourth order Runge-Kutta method. Each integration is done for each node every time step. Numerical stability is determined each step by the largest rate of change of a temperature or pressure, but instability problems have still been encountered when using the two cell version of LITFIRE. These will be discussed later on in this report [2].

This work consists of two major sections: a report of a parametric sensitivity study performed using the one cell version of LITFIRE to model the consequences of a spill in a reactor containment building, and a report of a study performed using the two cell version of LITFIRE to model the consequences of a lithium spill and fire inside a tokamak.

## II Spill and Fire inside the Containment Building

### II.1 Range of Study

This study was performed to determine the sensitivity of the temperature and pressure profiles of the containment building to changes in containment geometry, the amount of

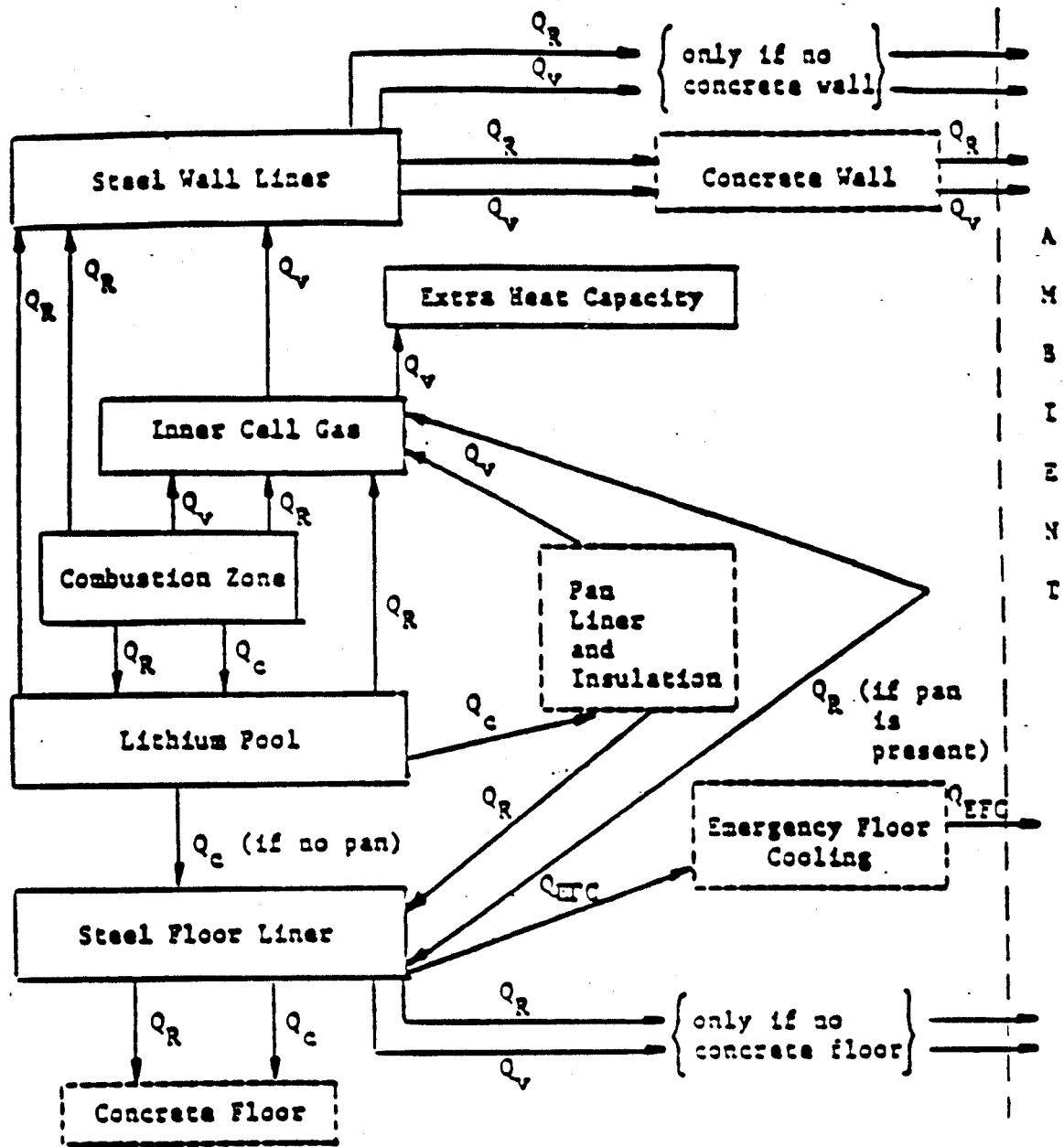

dashed lines indicate optional node

$Q_R$  = radiative heat transfer

$Q_V$  = convective heat transfer

$Q_C$  = conductive heat transfer

Figure 1 Energy flow in single cell LITFIRE

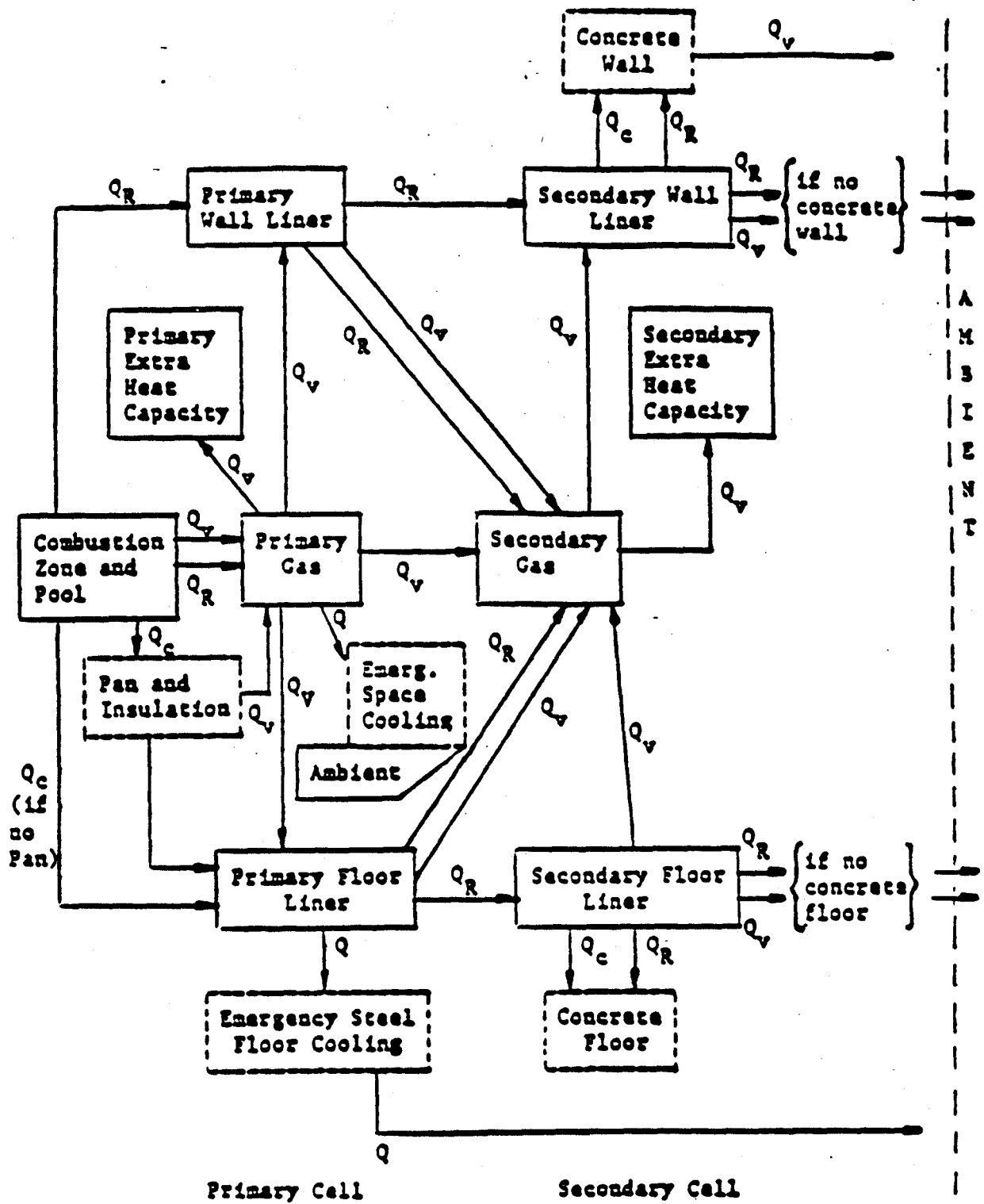

Figure 2 Energy flow in two-cell LITFIRE

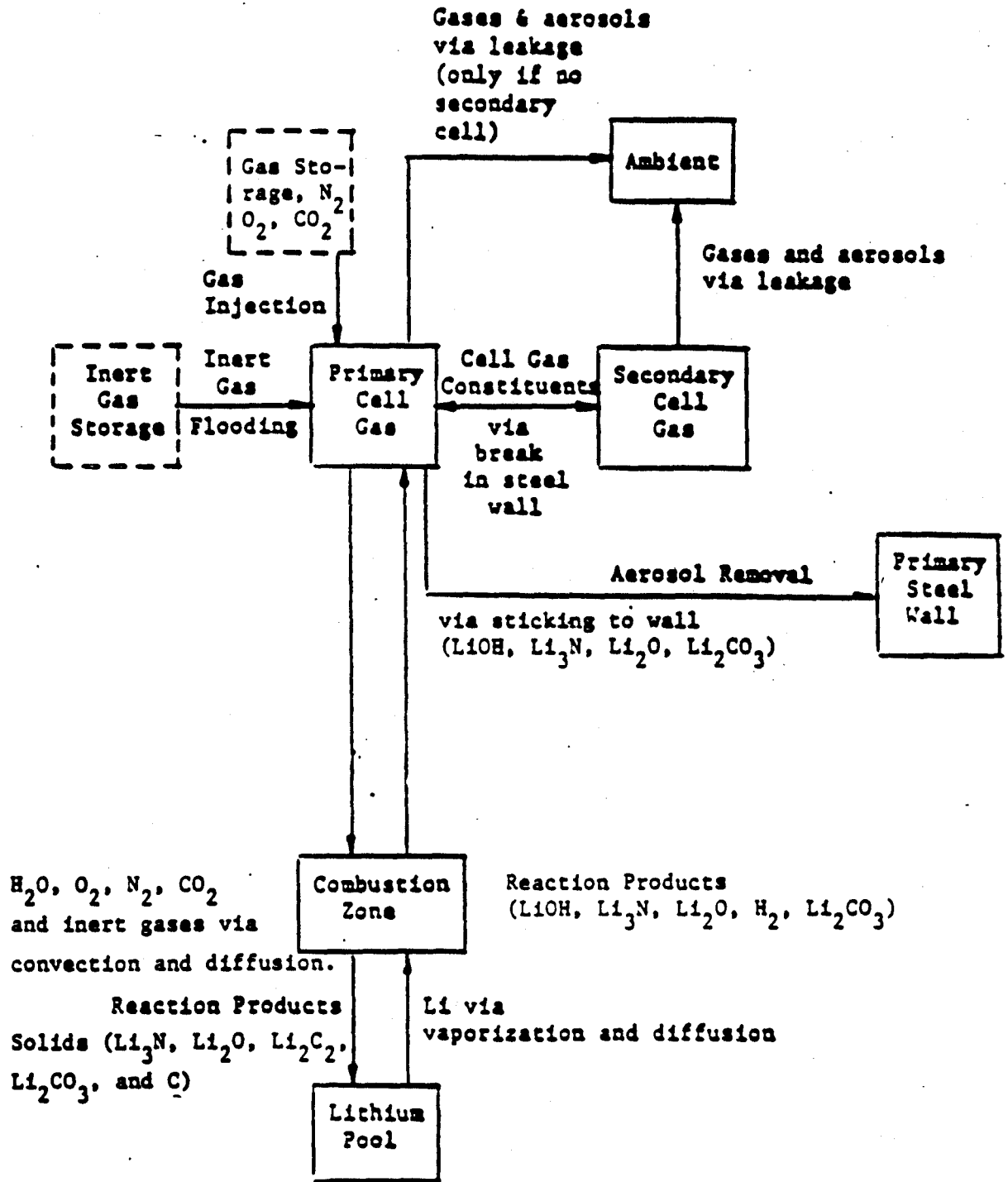

Figure 3 Mass flow in LITFIRE



lithium spilled, spill area, and initial spill temperature. A base case run was performed to which subsequent runs were compared. Values for the containment and lithium properties and geometries were taken from the "LITFIRE User's Guide" [3]. The values in the User's Guide are those for a hypothetical spill of one section of the lithium loop from the UWMAK-III tokamak (see Table 1).

The lithium pool initial temperature was taken to be 500 C. The base case and subsequent values of the parameters varied are shown in Table 2.

During each subsequent run, one of the parameters was changed while the others were held at the base case values.

## **II.2 Results**

### **II.2.1 Lithium Spill Temperature**

The effects of varying the lithium spill temperature are shown in Figures 4-7. The effects were small—the only difference between the cases was the amount of thermal energy initially present in the lithium. This had a very minor effect on the maximum temperatures and pressure reached during the accident. The reaction proceeded slightly more quickly with the hotter lithium because the reaction rate of lithium with air increases with temperature. Thus blanket operating temperature, from the point of view of lithium spill temperature, should not be of great concern when considering the consequences of an accident.

### **II.2.2 Lithium Spill Size**

The effects of varying the amount of lithium spilled in an accident are shown in Figures 8-11. Varying the size of the spill produced the widest range of temperature and pressure responses in the containment building. The amount of lithium spilled controlled the amount of energy released in the containment. Since heat transfer out of the containment was very slow, the large amount of energy released during the large spills did not have time to escape before high temperatures were reached. The maximum temperatures and

Table 1 Containment Geometry and Initial Conditions

Floor area:	5485 m <sup>2</sup>
Containment Volume:	250,800 m <sup>3</sup>
Wall area:	17,480 m <sup>2</sup>
Lithium mass spilled:	22,000 kg
Ambient temperature:	25.5 C
Gas pressure:	101.4 kPa
Steel liner thickness:	0.63 cm

Table 2 Parameters Varied

Parameter	Base Case	Subsequent Runs			
Initial Temp. (C)	500	250	400	600	700
Spill size (kg)	22,000	10,100	13,420	32,900	43,900
Spill area (m <sup>2</sup> )	965	485	645	1445	1930
Containment Vol. (m <sup>3</sup> )	250,800	125,400	167,200	376,200	501,600

# Wall Temp. vs. time

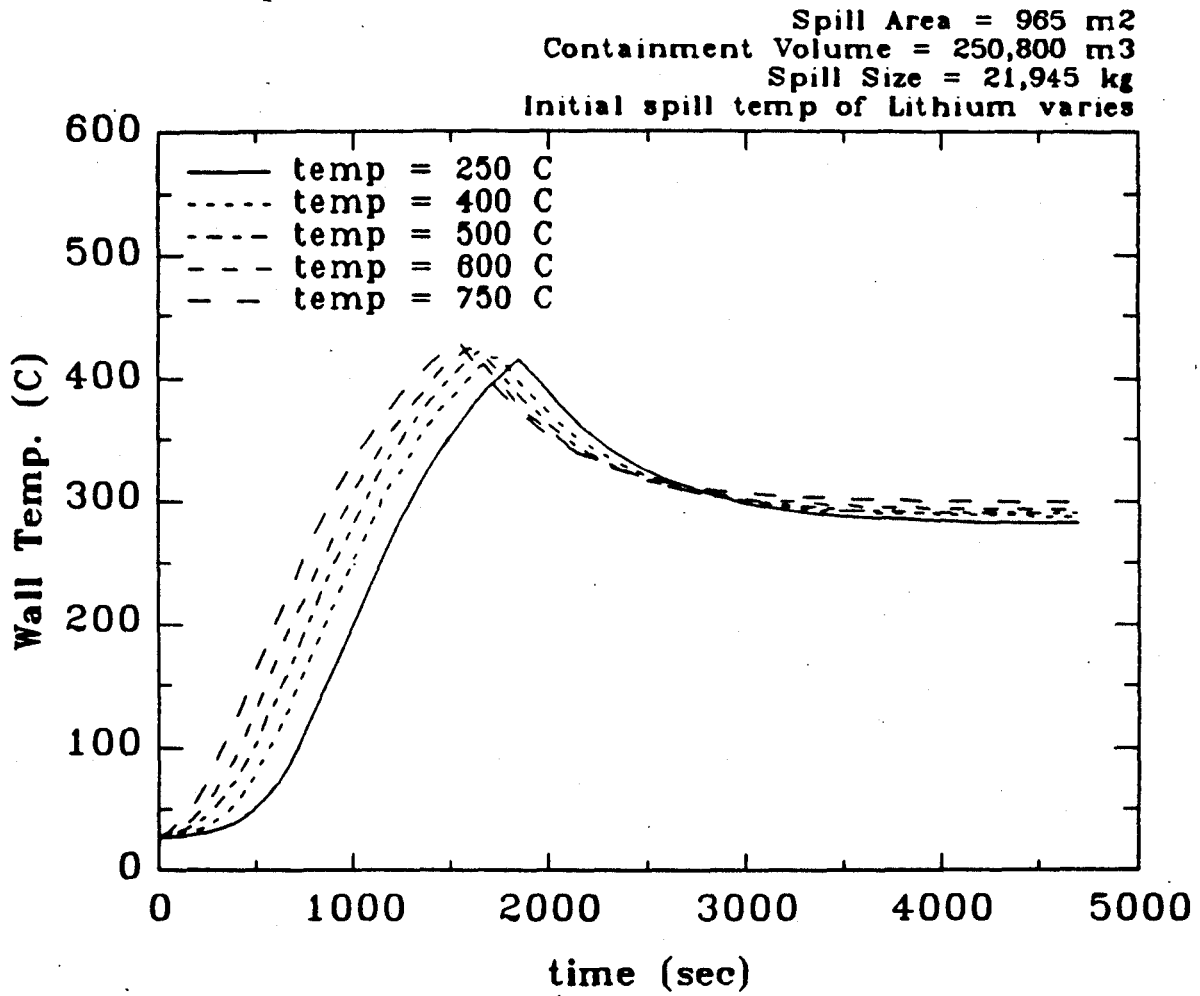

Figure 4 Containment wall temperature vs. time with varying initial lithium temperature

# Gas Pressure vs. Time

Spill Area = 965 m<sup>2</sup>  
Containment Volume = 250,800 m<sup>3</sup>  
Spill Size = 21,945 kg  
Initial spill temp of Lithium varies

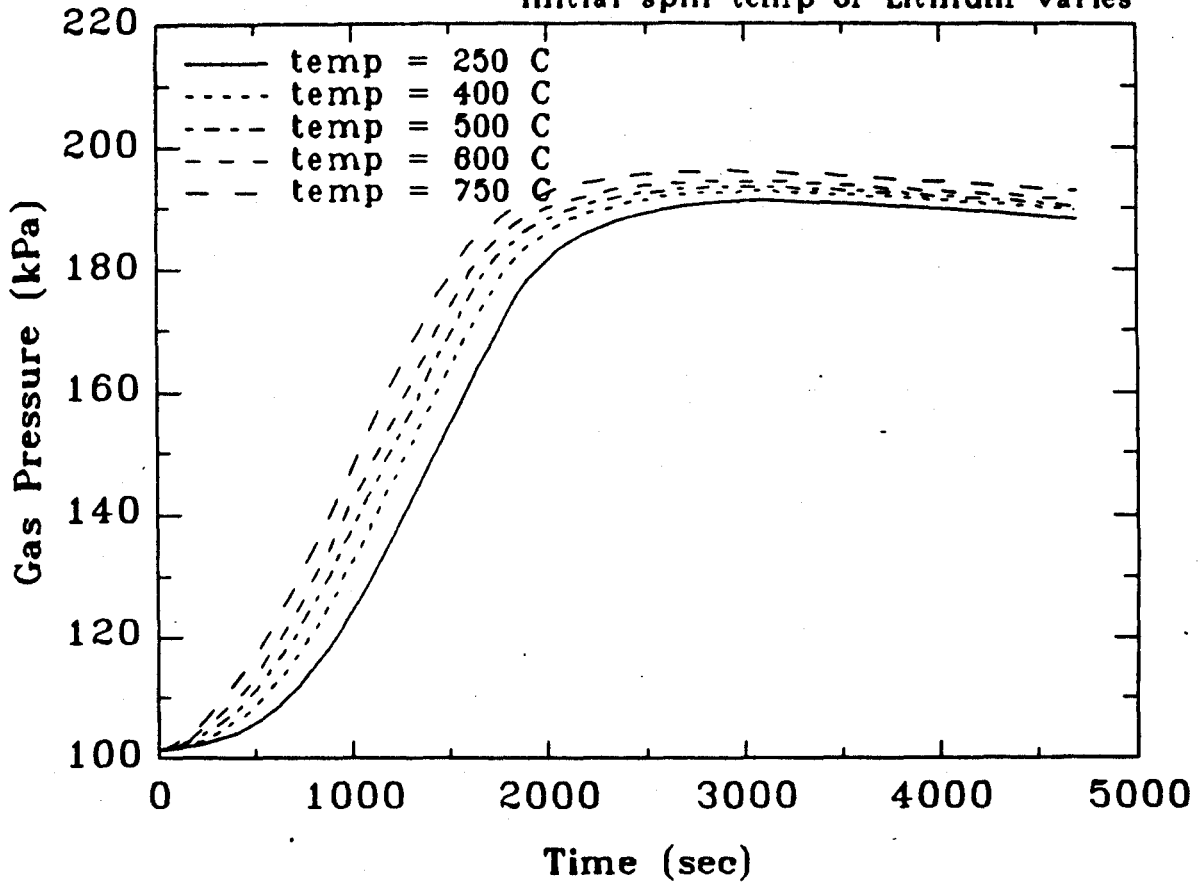

Figure 5 Containment gas pressure vs. time with varying initial lithium temperature

# Gas Temp. vs. time

Spill Area = 965 m<sup>2</sup>  
Containment Volume = 250,800 m<sup>3</sup>  
Spill Size = 21,945 kg  
Initial spill temp of Lithium varies

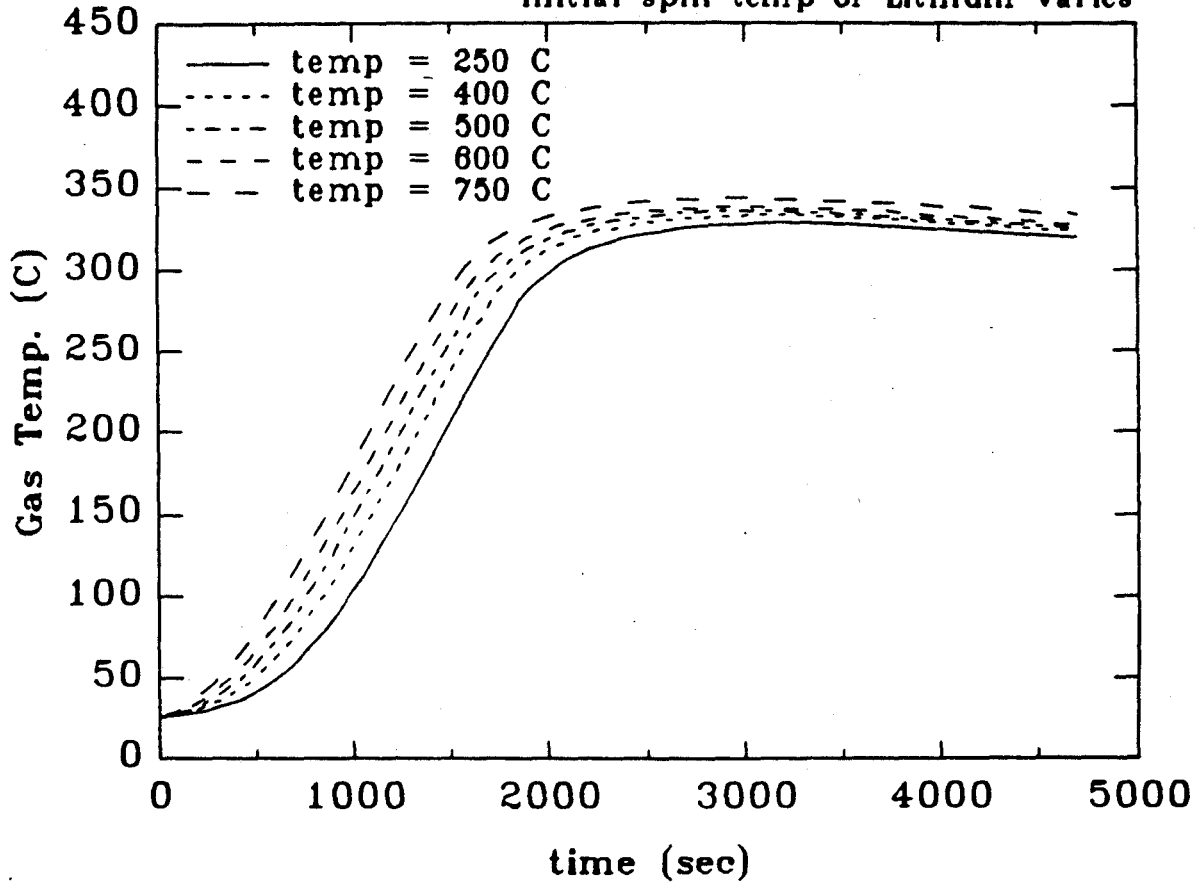

Figure 6 Containment gas temperature vs. time with varying initial lithium temperature

# Floor Temp. vs. time

Spill Area = 965 m<sup>2</sup>  
Containment Volume = 250,800 m<sup>3</sup>  
Spill Size = 21,945 kg  
Initial spill temp of Lithium varies

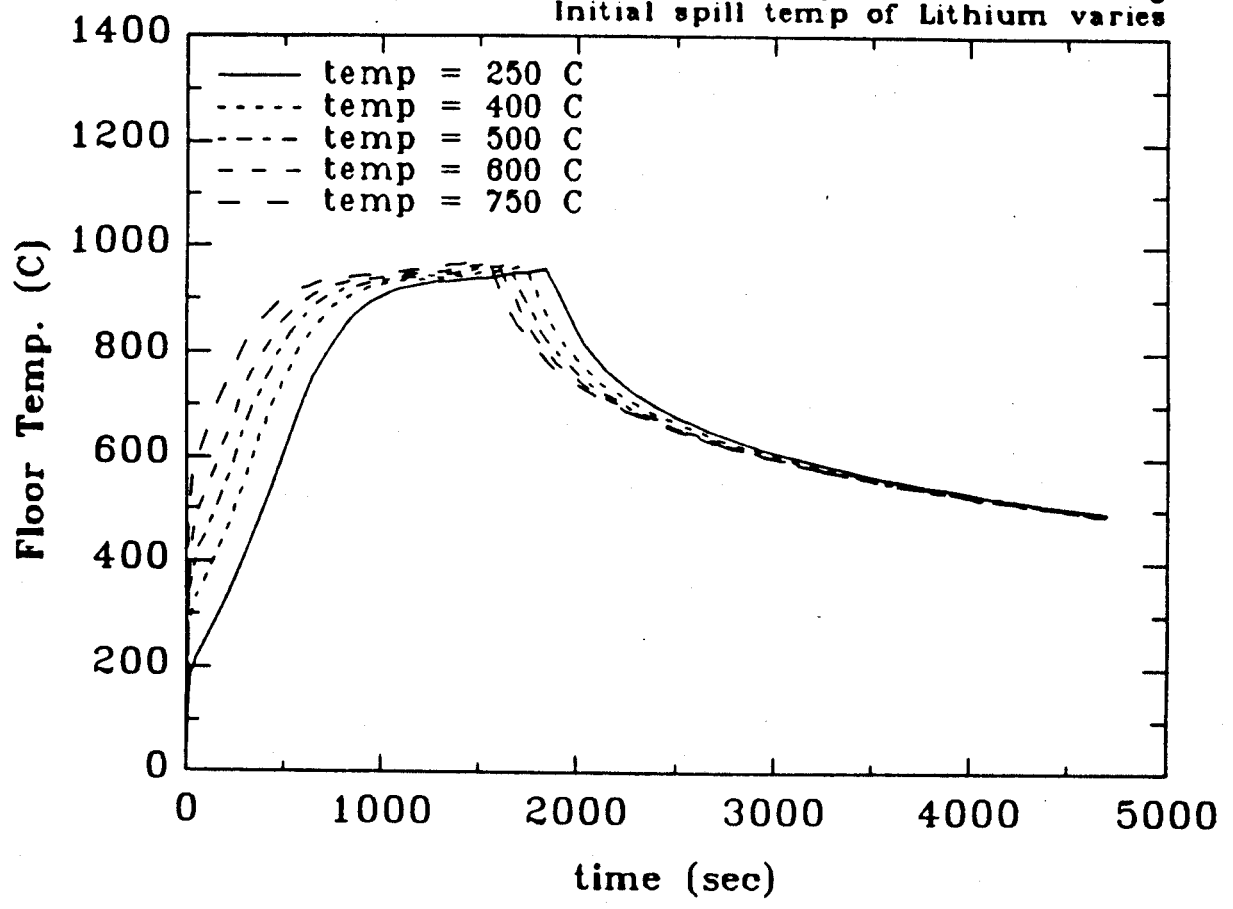

Figure 7 Containment floor temperature vs. time with varying initial lithium temperature

# Wall Temp. vs. time

Spill Area = 965 m<sup>2</sup>  
Containment Volume = 250,800 m<sup>3</sup>  
Initial Li Temp. = 500 C  
Initial spill size of Lithium varies

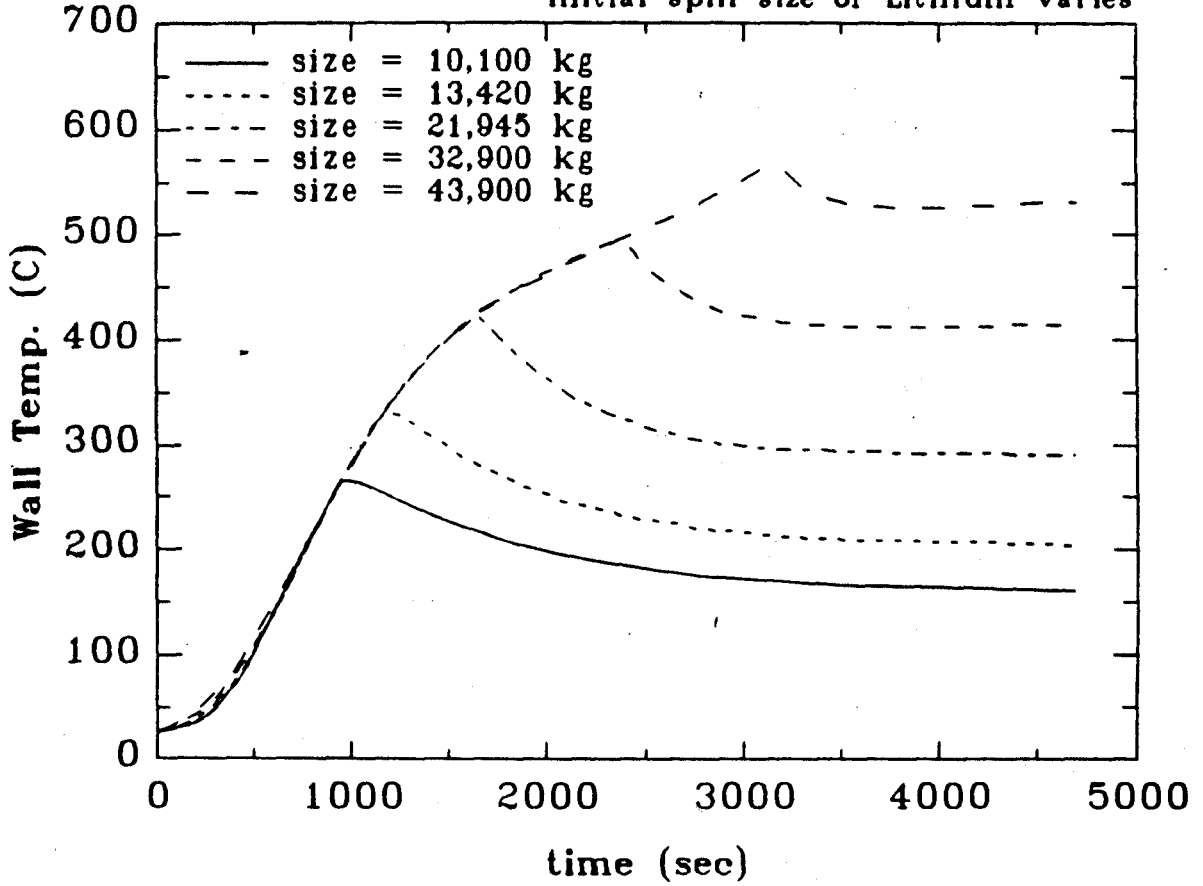

Figure 8 Containment wall temperature vs. time with varying mass of lithium spilled



## Gas Pressure vs. time

Spill Area = 965 m<sup>2</sup>  
Containment Volume = 250,800 m<sup>3</sup>  
Initial Li Temp. = 500 C  
Initial spill size of Lithium varies

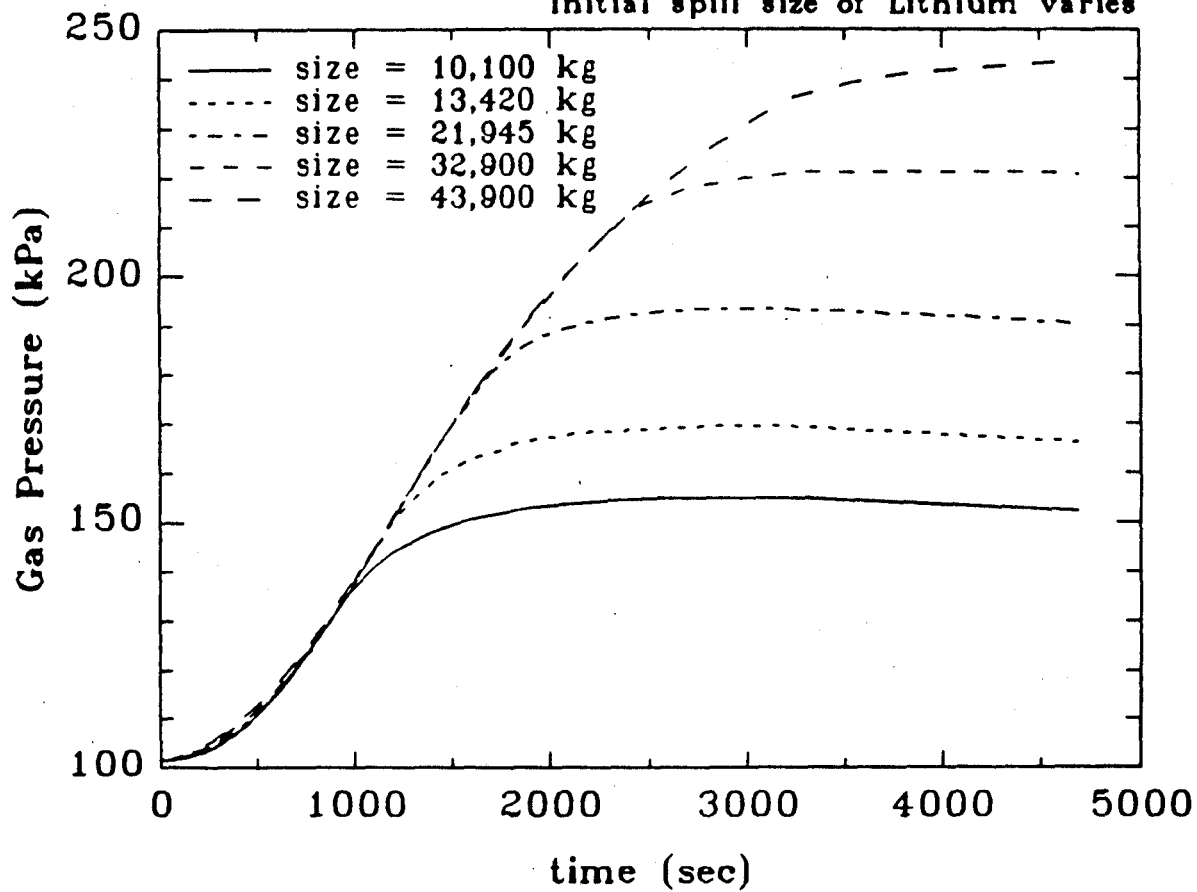

Figure 9 Containment gas pressure vs. time with varying mass of lithium spilled

# Gas Temp. vs. time

Spill Area = 965 m<sup>2</sup>  
Containment Volume = 250,800 m<sup>3</sup>  
Initial Li Temp. = 500 C  
Initial spill size of Lithium varies

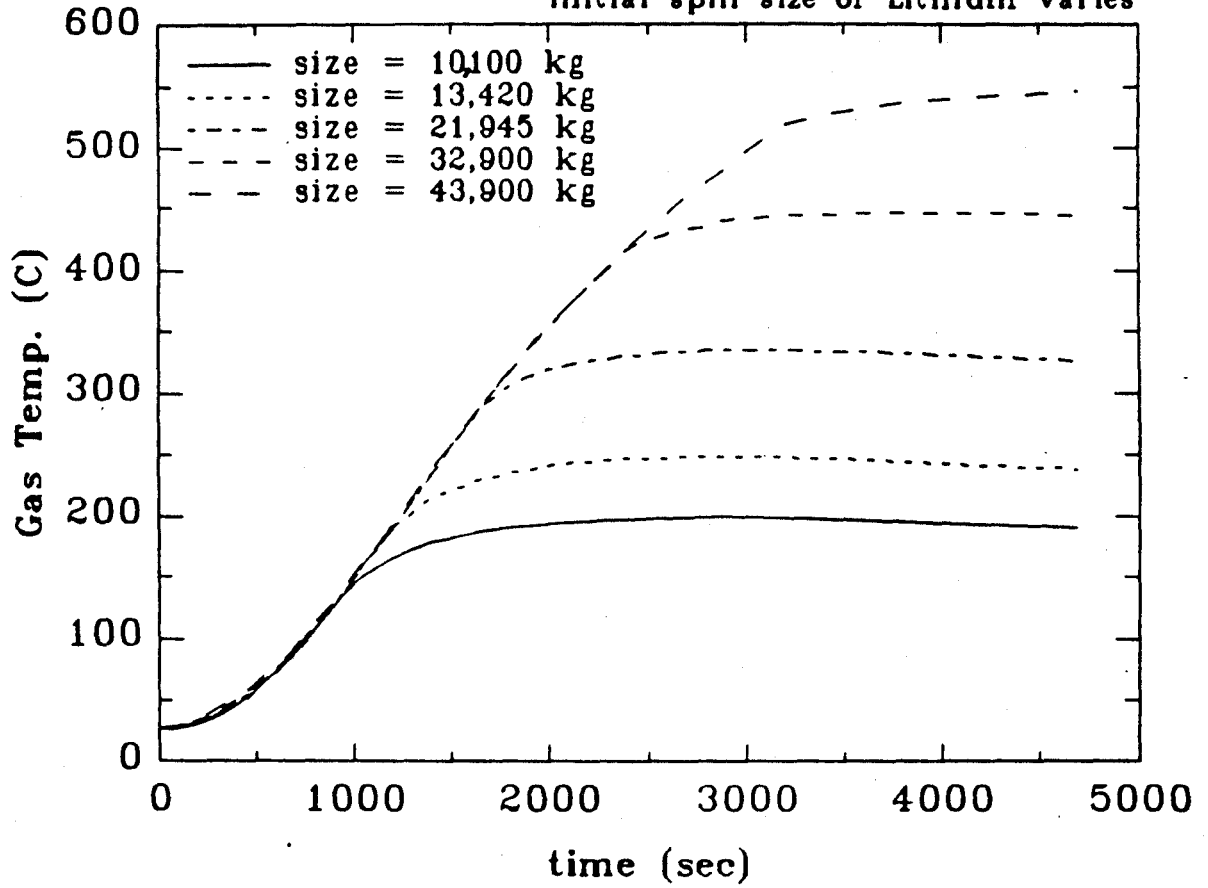

Figure 10 Containment gas temperature vs. time with varying mass of lithium spilled

# Floor Temp. vs. time

Spill Area = 965 m<sup>2</sup>  
Containment Volume = 250,800 m<sup>3</sup>  
Initial Li Temp. = 500 C  
Initial spill size of Lithium varies

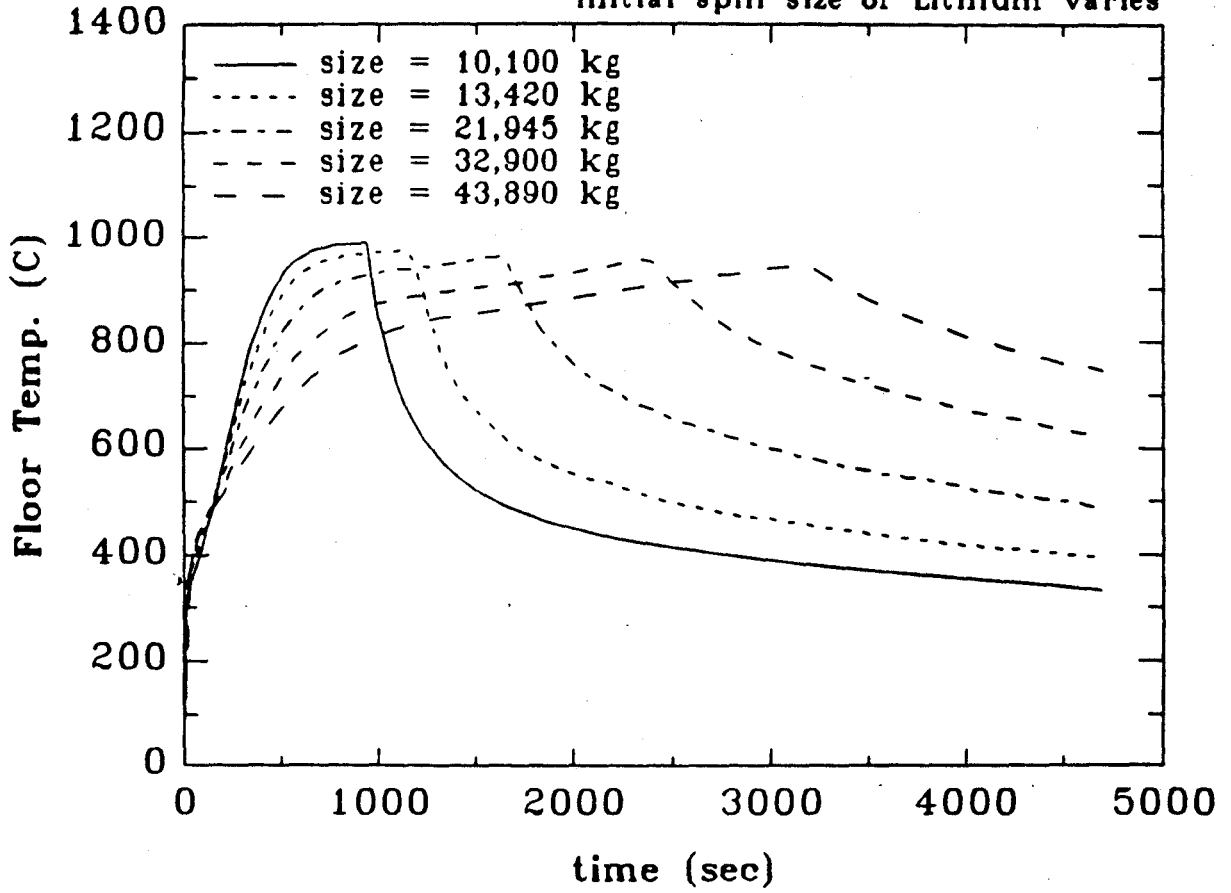

Figure 11 Containment floor temperature vs. time with varying mass of lithium spilled

pressures reached increased roughly linearly with the amount of lithium spilled, although the temperature and pressure responses over time followed the same path for every case, i.e. as the size of the spill increased, the time to reach maximum temperature and pressure also increased.

Maximum temperatures of the containment wall ranged from about 260 C, for a spill size of 10,100 kg, to about 560 C for a spill size of 43,900 kg. Such a difference in maximum temperature could be significant regarding damage to reactor or containment building components.

The containment gas pressure varied from about 175 kPa to about 245 kPa. This is a significant difference when one considers the overpressurization design strength of the containment building. The smallest spill resulted in about 0.75 atmospheres overpressurization, while the largest spill resulted in about 1.5 atmospheres overpressurization—a factor of two in containment building stress.

The response of floor temperature to the change in the size of the lithium spill was different from that of the gas and wall temperatures. The maximum floor temperature was approximately 950 C in all cases. This was due to the fact that the floor temperature depended on the amount of heat conducted from the combustion zone through the lithium pool to the floor. In each case the lithium combustion zone was at a temperature of about 1250 C, so the temperature of the floor was much lower due to the greater heat capacity of the pool. The maximum temperature of the floor was somewhat lower and was also reached much later in the cases of the larger spills because lithium has a large specific heat, so it took longer for the heat to reach the floor.

Clearly it is of the utmost importance to limit the amount of lithium spilled in an accident. The fire caused by a large spill could damage reactor components or require stronger reactor containments to withstand overpressurization or thermal attack. The amount of lithium spilled could be limited by using safety shut off valves between blanket sections to cut off the flow of lithium between sections in the event of an accident. In addition the blanket could be divided into smaller sections. The base case considered the

UWMAK-III tokamak design, which was subdivided into 18 sections, one of which was assumed to have been drained during the accident. Smaller blanket sections with safety shut off valves should limit the size of a spill during an accident to a manageable level.

### II.2.3 Containment Volume

The results of varying the containment building volume are shown in Figures 12-15. Containment size had the greatest effect on gas temperature and pressure. Since the amount of lithium spilled and burned was held constant, the temperature of the gas in the smaller containments was higher because there was less gas present to absorb the heat. LITFIRE uses the ideal gas law to relate gas temperatures and pressures, so the increase in gas pressure was directly proportional to the increase in gas temperature. Gas pressure ranged from 165 to 225 kPa or from about 0.65 to 1.25 atmospheres overpressure, thus a small containment building would have to be considerably stronger than a larger one. Containment design considerations would involve a trade off between the cost of a small, thick walled structure or a larger, thinner walled one.

The gas temperature affected the wall temperature in the containment as well. The wall temperature ranged from about 310 C to about 525 C. This was due to the fact that the hot gas could not carry away the heat that was radiated to the wall as well as the cooler gas could. The difference in maximum wall temperature between the largest and smallest containment structures was significant enough to be of concern when considering possible damage to reactor structures.

Floor temperature was almost unaffected by the variation in containment size; the only difference being that it decayed away more quickly with the larger containments.

From the comparison of containment wall temperature plots one can see that a larger containment building would tend to mitigate the consequences of a lithium fire. When designing the containment building, a maximum allowable temperature must be decided upon and then the minimum size of the building can be determined from that. This would involve a cost benefit analysis of the protection of the reactor components and the cost of

# Wall Temp. vs. time

Spill Area = 965 m<sup>2</sup>  
Spill Size = 21,945 kg  
Initial Li Temp = 500 C  
Containment Volume varies

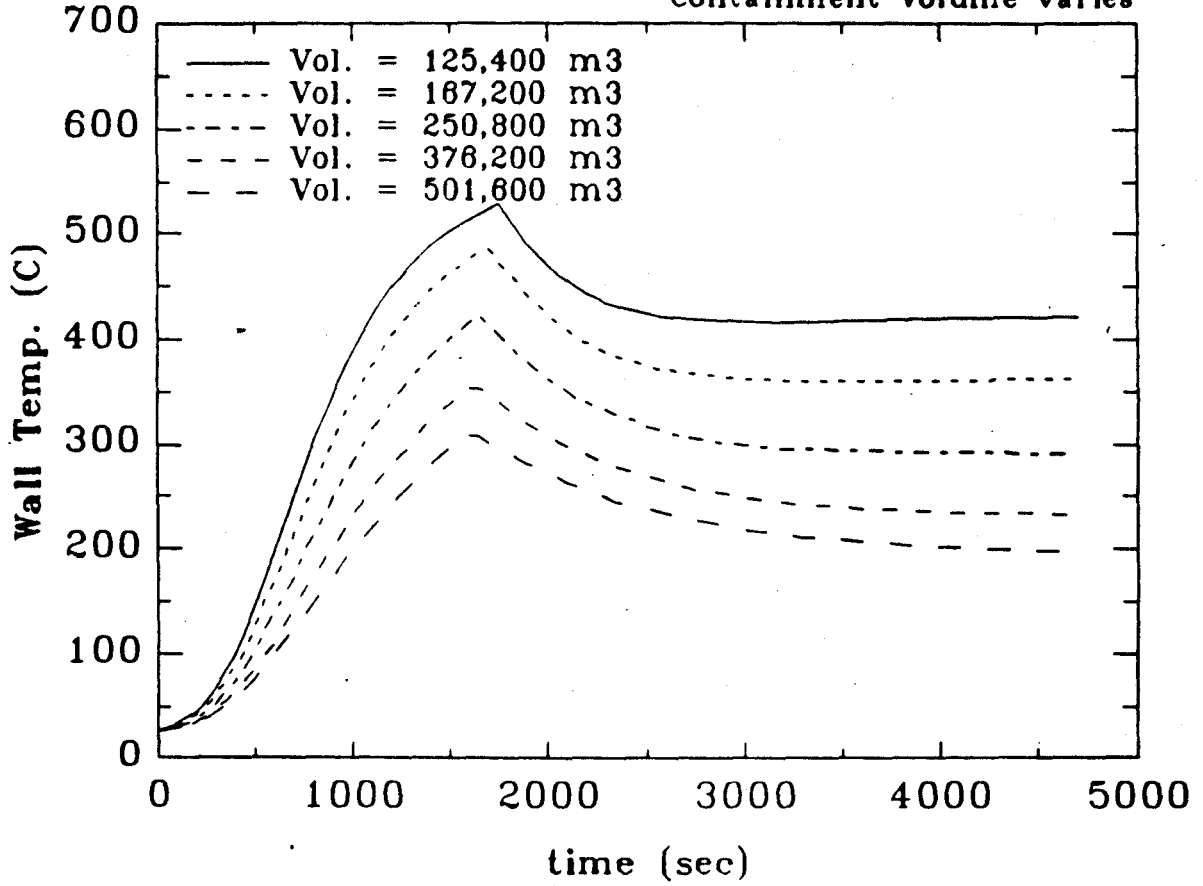

Figure 12 Containment wall temperature vs. time with varying containment building volume

# Gas Pressure vs. time

Spill Area = 965 m<sup>2</sup>  
Spill Size = 21,945 kg  
Initial Li Temp = 500 C  
Containment Volume varies

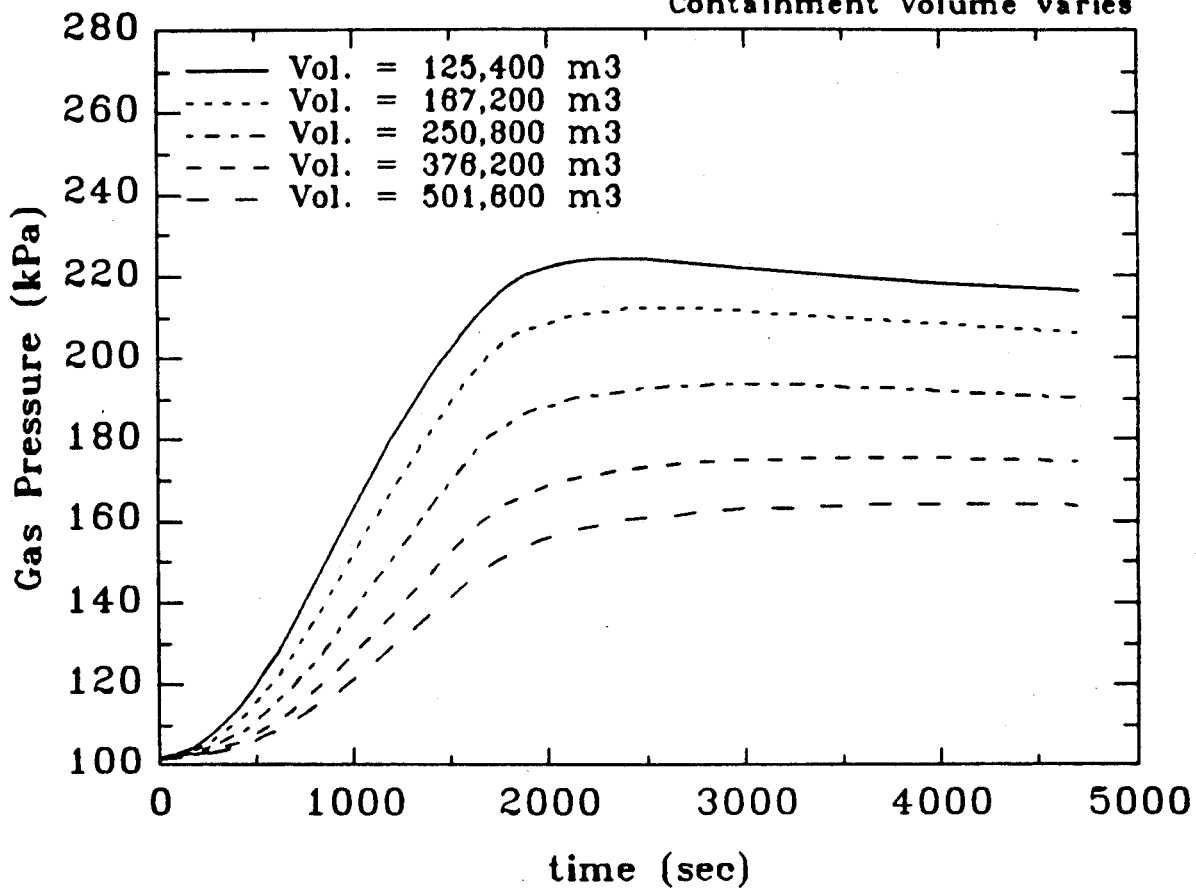

Figure 13 Containment gas pressure vs. time with varying containment building volume

# Gas Temp. vs. time

Spill Area = 965 m<sup>2</sup>  
Spill Size = 21,945 kg  
Initial Li Temp = 500 C  
Containment Volume varies

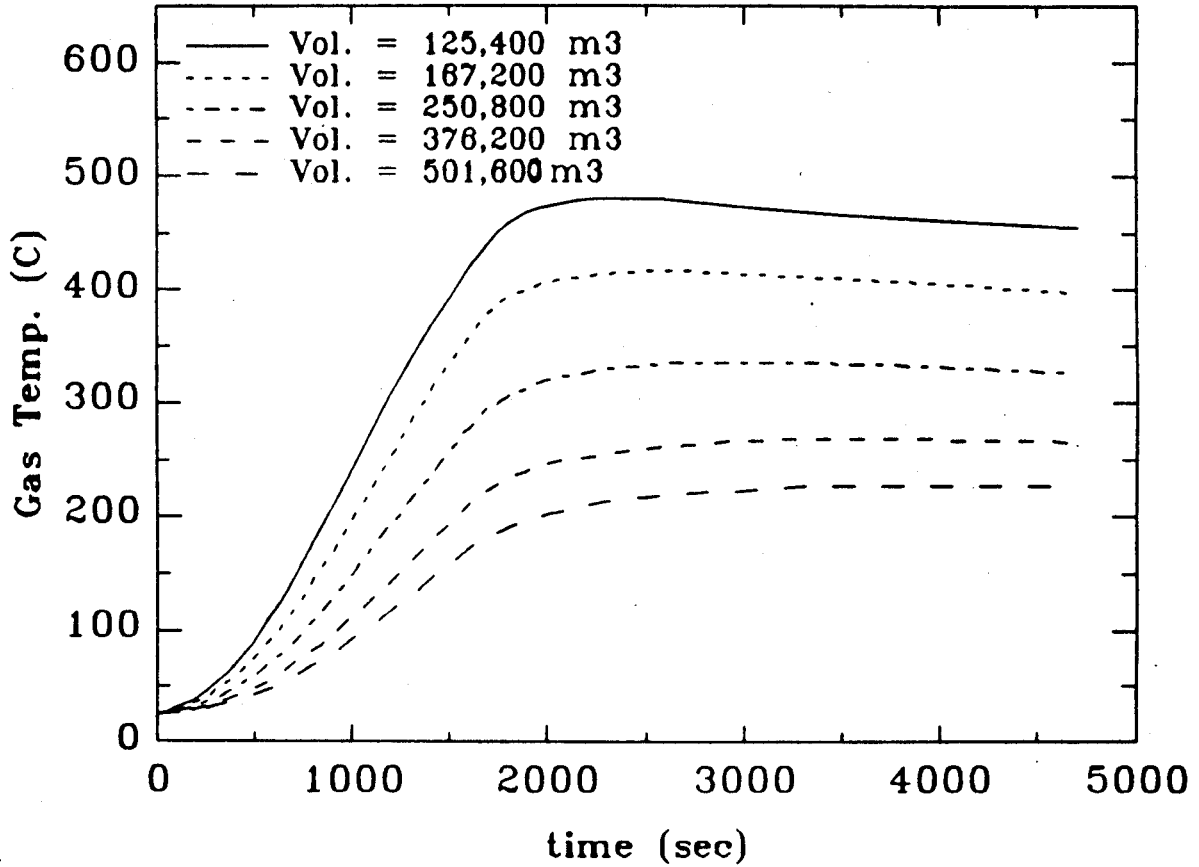

Figure 14 Containment gas temperature vs. time with varying containment building volume



# Floor Temp. vs. time

Spill Area = 965 m<sup>2</sup>  
Spill Size = 21,945 kg  
Initial Li Temp = 500 C  
Containment Volume varies

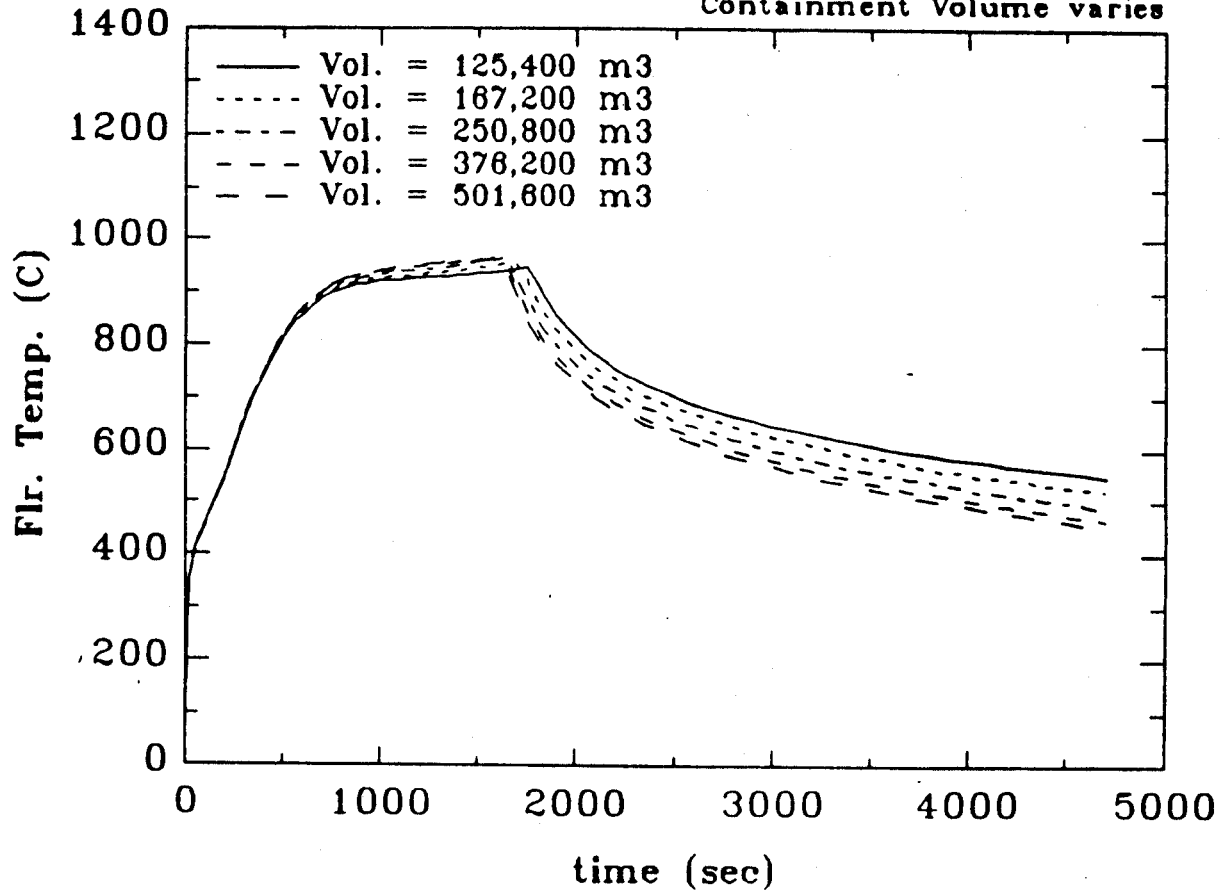

Figure 15 Containment floor temperature vs. time with varying containment building volume

the containment structure.

## II.2.4 Lithium Spill Area

The results of varying the surface area of the lithium pool are shown in Figures 16–19. This was assumed to have been done through the use of catch wells of various diameters that were deep enough to hold the spilled lithium, the amount of which was held constant throughout the trials.

The reaction rate of the lithium was directly proportional to the surface area of the pool, so the area controlled the rate of heat release to the containment. The radiation of heat from the pool to the containment wall was also directly proportional to pool area, so the pool area had great effects on the time histories of the accident.

Containment wall temperature was highest in the case of the large pool, as the heat was quickly radiated to the wall and had no time to be conducted or convected away. With the smaller pool sizes the temperature was lower as the containment gas had time to carry away some heat from the wall. The range of maximum wall temperature was from about 375 to 440 C—a relatively narrow range; the time maximum temperature was reached ranged from 950 seconds into the accident for the largest pool area to 3000 seconds into the accident for the smallest pool size. The histories of the gas temperatures also illustrate this. The range of maximum gas temperature was from 315 C in the case with the largest pool area to about 340 C with the smallest. The times of maximum temperature varied from 2000 seconds for the large pool to 3700 seconds for the smallest one. Thus it can be seen that in the cases with the smaller pools the temperatures of the gas and wall had time to equalize while in the case of the larger pools, the heat was radiated from the pool to the wall much more quickly than it was being convected away by the gas.

The pressure histories follow the same paths as the gas temperature histories—the greatest overpressurization occurred in the case with the smallest pool area. However the difference between the maximum overpressurization (0.95 atm.) and the minimum overpressurization (0.87 atm.) was small. Thus pool area would not have a great impact

# Wall Temp. vs. time

Containment Volume = 250,800 m<sup>3</sup>  
Spill size = 21,945 kg  
Initial Li Temp. = 500 C  
Spill area of Lithium varies

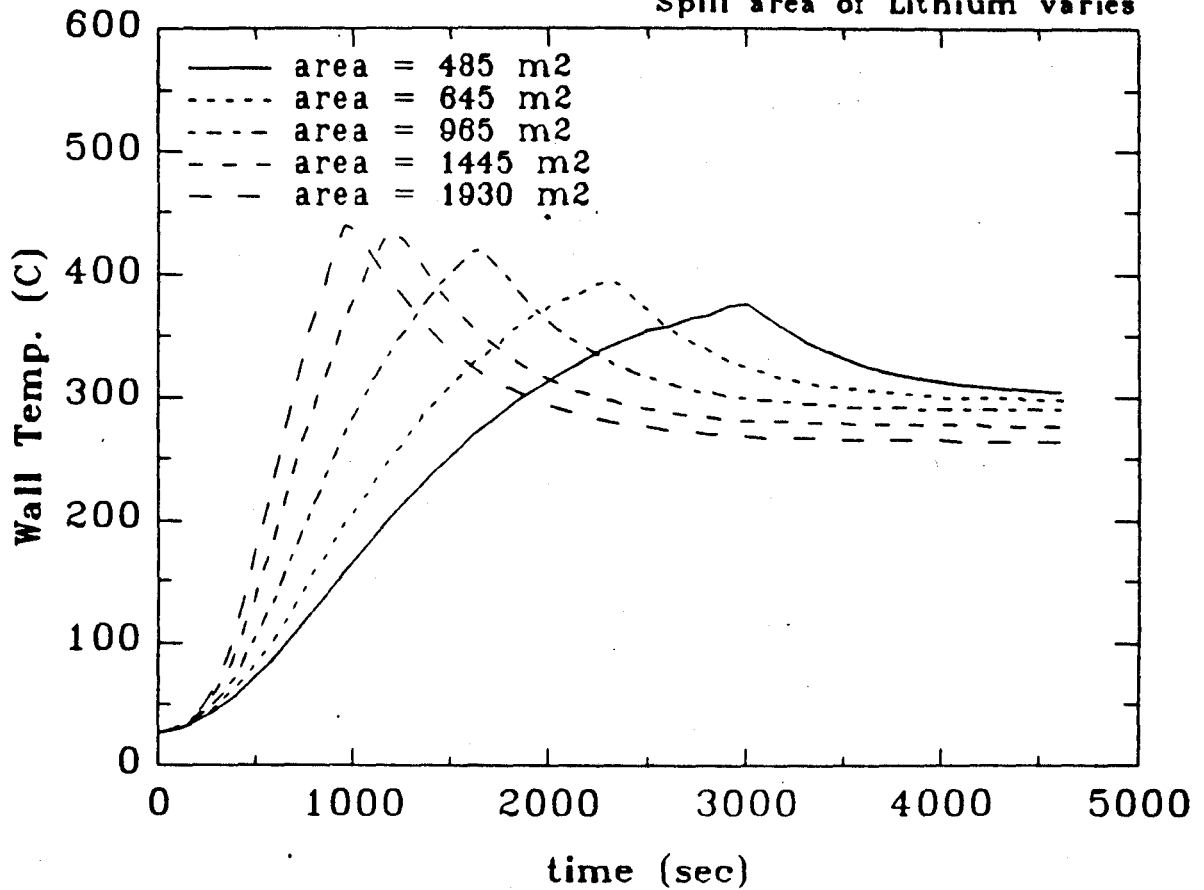

Figure 16 Containment wall temperature vs. time with varying lithium pool area

# Gas Pressure vs. time

Containment Volume = 250,800 m<sup>3</sup>

Spill size = 21,945 kg

Initial Li Temp. = 500 C

Spill area of Lithium varies

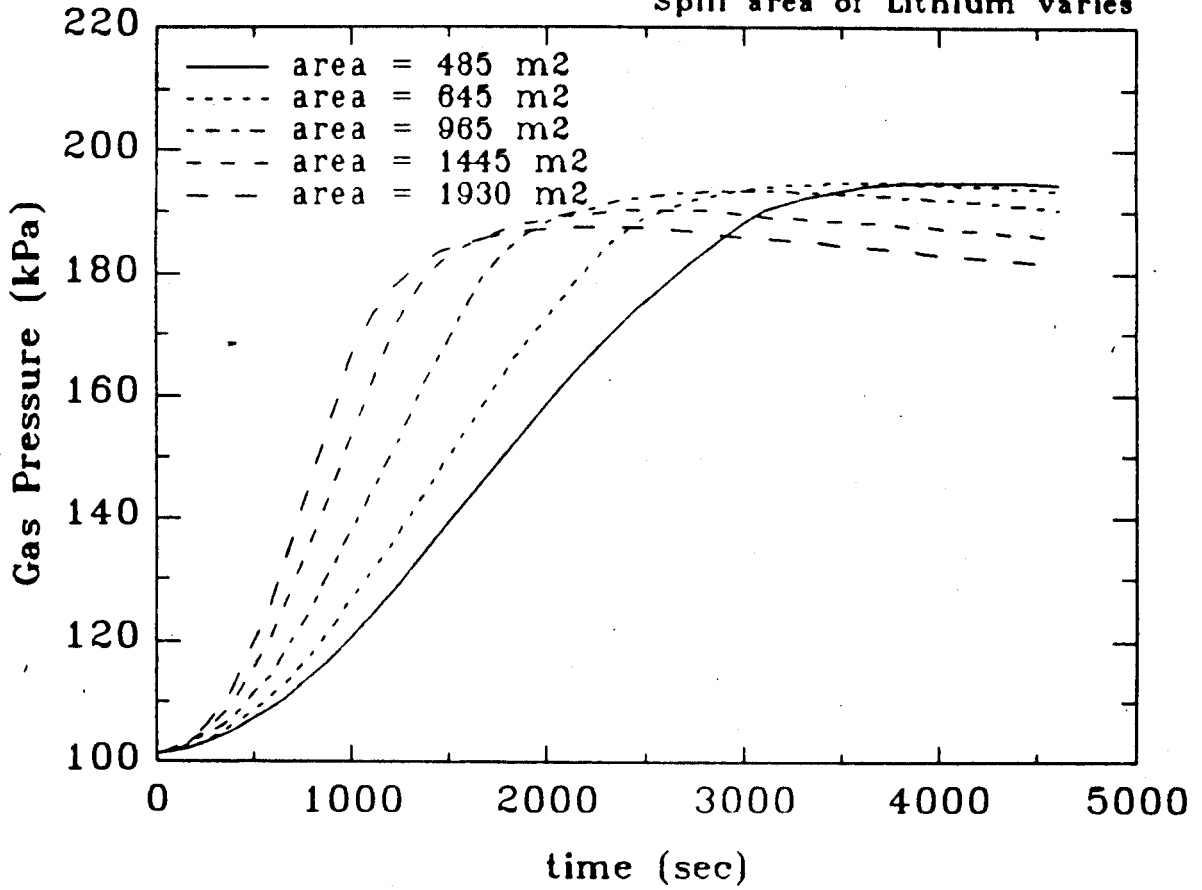

Figure 17 Containment gas pressure vs. time with varying lithium pool area

# Gas Temp. vs. time

Containment Volume = 250,800 m<sup>3</sup>

Spill size = 21,945 kg

Initial Li Temp. = 500 C

Spill area of Lithium varies

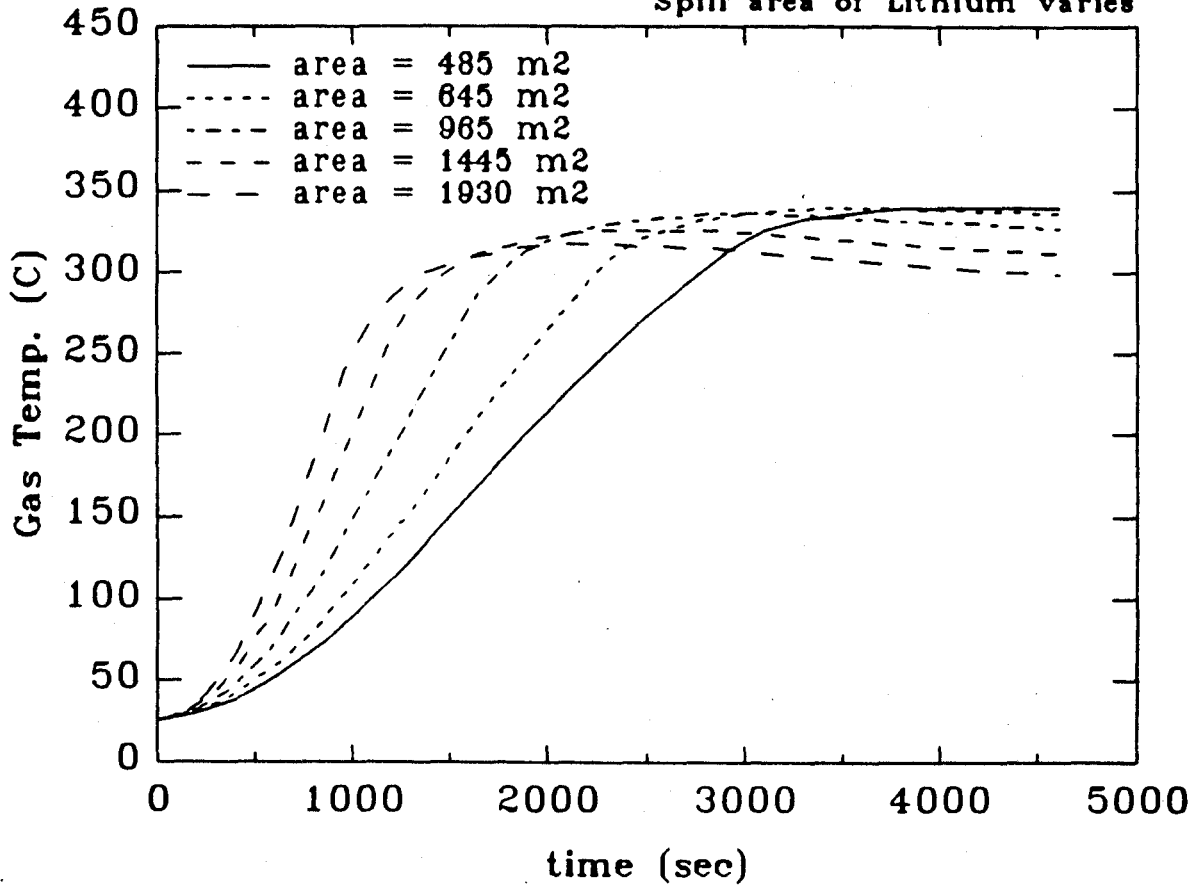

Figure 18 Containment gas temperature vs. time with varying lithium pool area

## Floor Temp. vs. time

Containment Volume = 250,800 m<sup>3</sup>

Spill size = 21,945 kg

Initial Li Temp. = 500 C

Spill area of Lithium varies

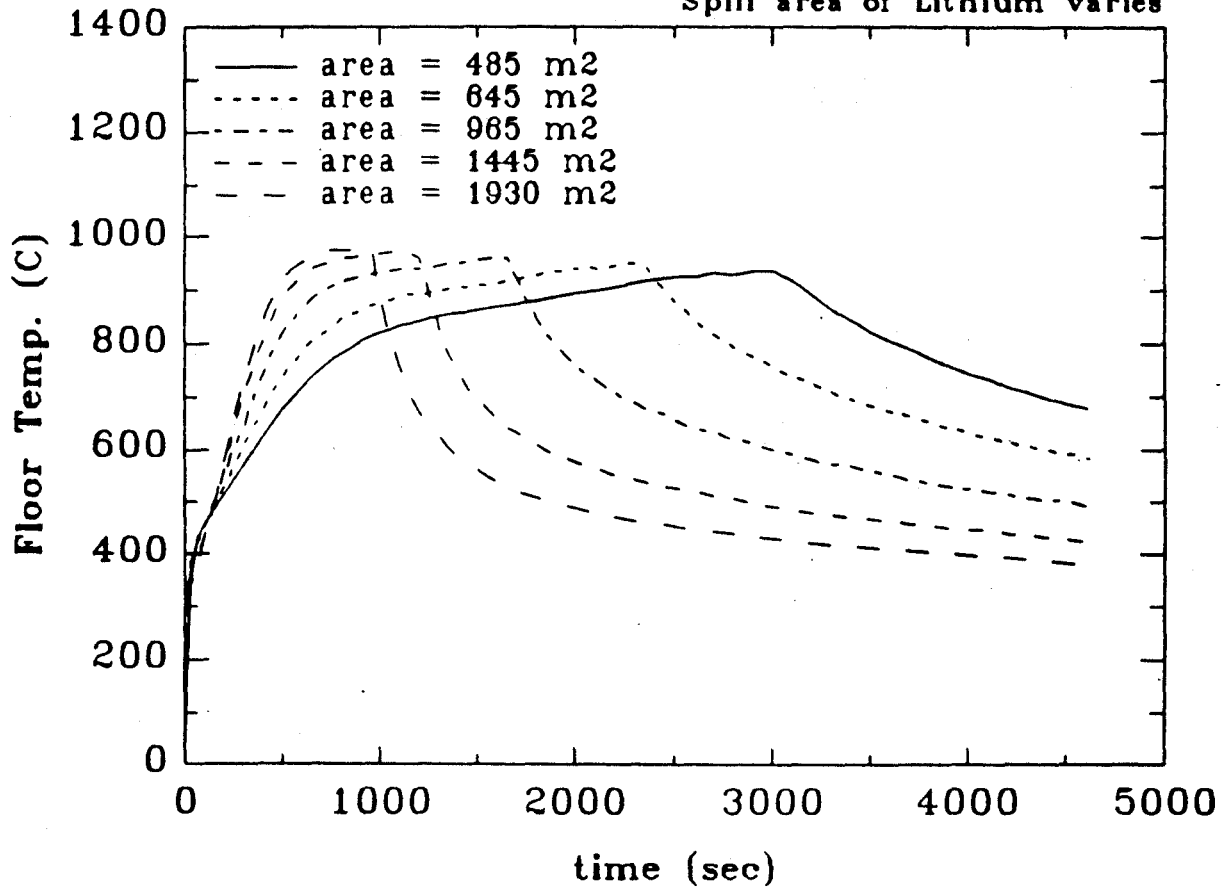

Figure 19 Containment floor temperature vs. time with varying lithium pool area

on containment design strength.

Maximum floor temperature was almost unaffected as in all previous cases, but the time of maximum temperature ranged from less than 1000 seconds for the largest pool to 3000 seconds for the smallest one. The floor also cooled much more quickly in the case of the largest pool with a temperature of about 450 C 1000 seconds after combustion stopped. In the case of the smallest pool, the floor temperature was over 700 C 1000 seconds after combustion stopped. This again was due to the fact that the temperatures had had time to equalize in the case of the smaller pools and that reduced the effectiveness of the heat transfer from the floor.

Overall, lithium pool area does not seem to be critical in controlling the consequences of a lithium spill although it would be desirable to slow the combustion of the lithium if emergency cooling systems were present. The slower rate of combustion and heat generation would give the emergency systems time to affect containment temperature and overpressurization. As stated earlier this could be accomplished through the use of catch wells in the containment floor where lithium spills would be most likely to occur.

### **II.3 Conclusions**

The consequences of a lithium spill in a fusion reactor containment building could be mitigated through the use of blanket sections with safety valves between them to limit a spill to one section and also through the use of a large containment building to minimize overpressurization and thermal damage to reactor components. Both methods would be limited by the cost of the system, especially the containment building size. The number of blanket sections would be limited in that it is desirable to minimize the amount of structural material in the blanket from a neutronics point of view. Nevertheless, both methods could be employed to some extent to lessen the effects of a lithium spill and fire.

### **III Lithium Spill and Fire inside a Vacuum Torus**

This study was done to determine the effects of a lithium spill caused by a puncture of a

reactor blanket because of which lithium flowed into the torus, which was previously under a vacuum. A similar study was performed by Gilberti [2], but the large heat capacities of both the reactor blanket (including unspilled lithium) and the blanket shield, along with the heat transfer paths present therein, were not included in that work. The two cell option for LITFIRE did not include nodes for the reactor blanket or blanket shield (see Figure 2), so the code had to be changed to account for them.

### III.1 Changes made to LITFIRE

The changes made to enable LITFIRE to model a fire inside a tokamak were the addition of nodes for the reactor blanket and shield, and the addition or subtraction of heat transfer pathways to and from the various nodes. The new nodes were necessary to account for the very large heat capacities of the blanket and shield. Two nodes were necessary since the only heat transfer path from the blanket to the shield was radiative, so there would be a considerable difference in temperatures between the two. Since the blanket contained mostly lithium, which has a very high thermal conductivity, one node was deemed sufficient for it. Since the blanket was taken as one node, it radiated heat evenly to the shield which was also modeled as one node although the conductivity of the steel and water in the shield was not nearly as high as that of the lithium in the blanket.

Heat transfer pathways were changed to account for the actual reactor components represented by the various nodes. The changes made, with the new nodes, are shown in Figure 20; the extra options available in the old two cell LITFIRE are not included. The heat transfer pathways in the new two cell LITFIRE are shown in Figure 21. The primary cell was considered to be the torus formed by the reactor first wall (inclusive). The primary floor was defined as the area of the first wall covered by the spilled lithium. The spill area was calculated from the volume of the spilled lithium and the geometry of the tokamak, as shown in Figure 22. The cross section of the tokamak was approximated as a circle for ease of calculation. The actual cross section is "D" shaped but the error introduced by the approximation was small.



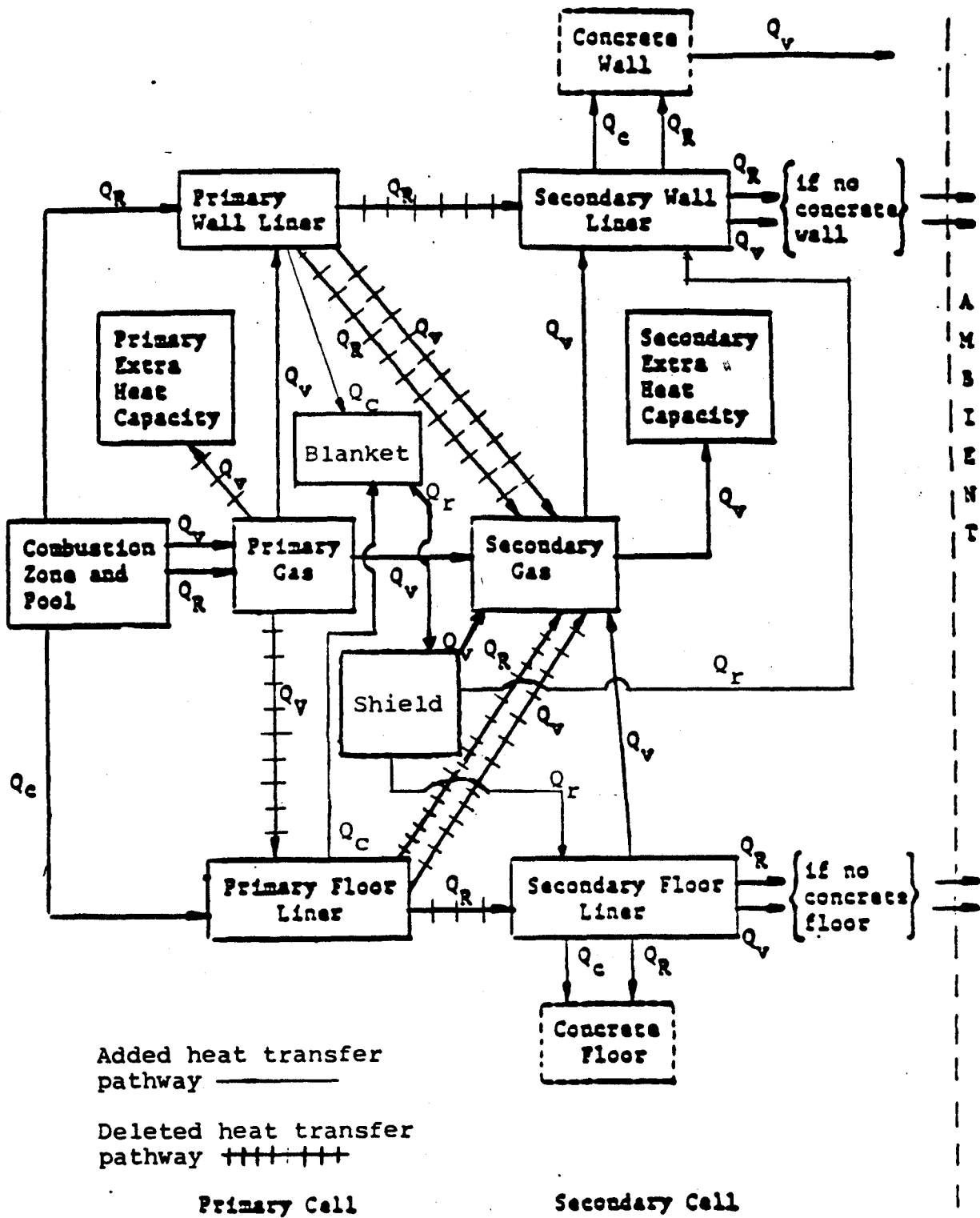
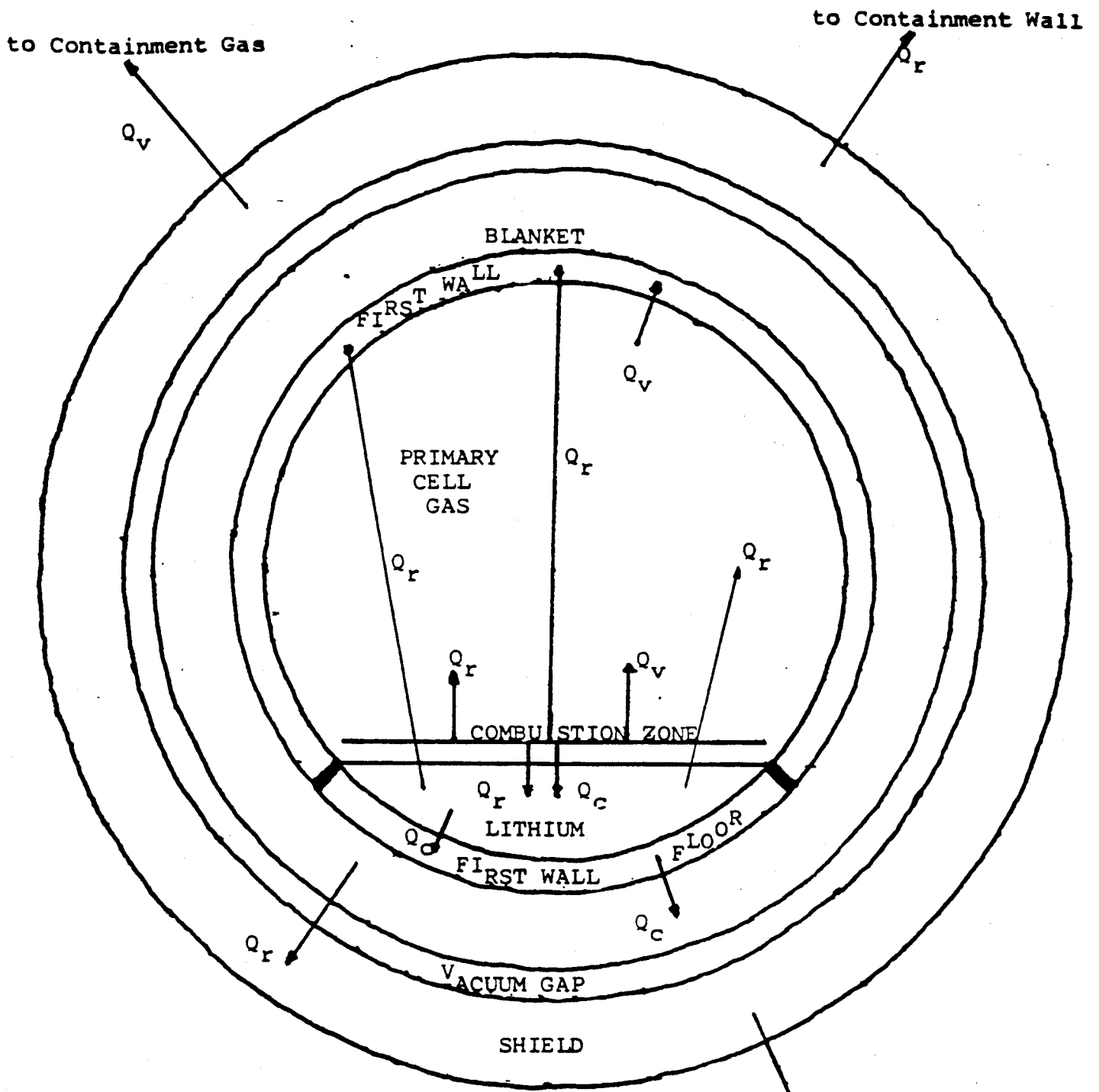

Figure 20 Energy flow in modified two-cell LITFIRE



$Q_c$  = heat conduction  
 $Q_r$  = heat radiation  
 $Q_v$  = heat convection

to Containment Floor

Figure 21 Heat transfer pathways in modified two-cell LITFIRE

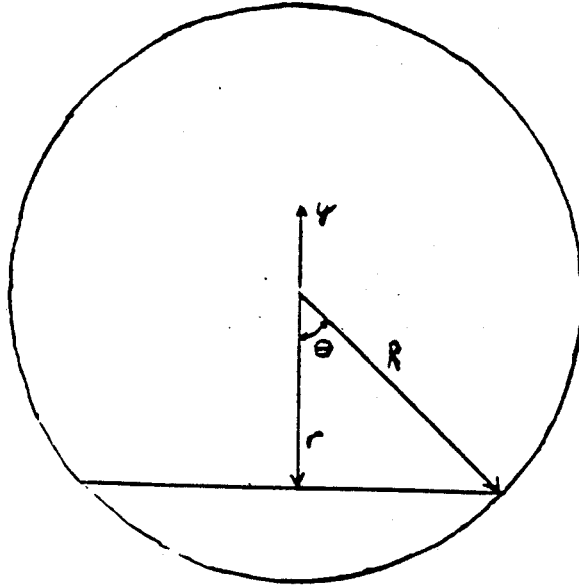

Figure 22

$$V = \int_{-R}^{-r} 2L\sqrt{R^2 - y^2} dy, \text{ where } L = 2\pi(\text{major radius}),$$

$$V = LR^2\left(\theta - \frac{\sin 2\theta}{2}\right)$$

The spill area is given by:  $A_{Li} = 4\pi LR \sin \theta$ , and the floor area is given by:  $A_f = 4\pi LR\theta$ .

Thus there was no convection between the floor and primary cell gas. Heat was conducted from the primary wall and floor to the blanket from which it was radiated to the shield. Heat was transferred from the shield to the secondary cell gas by convection and to the secondary wall and floor by radiation. The secondary cell in this case was the containment building. Thus the thermal properties of the blanket and shield were very important in that most of the heat from the reaction had to pass through them enroute to the reactor containment. Some heat was transferred through the crack in the blanket via the cell gases. The modeling of this process was not changed.

It should be noted that the changes made to LITFIRE did not include the addition of decay heat generation in the structural material of the reactor. Since a lithium fire would

also result in a loss of flow or loss of coolant accident, the contribution of the decay heat to the damaging of reactor components could be considerable.

### III.2 Reactor Parameters and Initial Conditions

The reactor chosen for use in the study was the STARFIRE tokamak with the lithium coolant/lithium breeder/vanadium alloy structure blanket from the Blanket Comparison and Selection Study [4]. The geometry of the reactor and some thermal properties are given in Table 3.

Table 3 Reactor Geometry and Selected Thermal Properties

Vacuum torus volume:	872 m <sup>3</sup>
Wall area:	572 m <sup>2</sup>
Floor area:	105 m <sup>2</sup>
Wall and floor thickness:	5 mm
Blanket thickness:	64 cm
Blanket outer area:	902 m <sup>2</sup>
Shield thickness:	62 cm
Shield outer area:	1125 m <sup>2</sup>
Wall and Floor	
Thermal Conductivity:	31 W/mK
Wall Heat Capacity:	8.69·10 <sup>6</sup> J/K
Floor Heat Capacity:	1.59·10 <sup>6</sup> J/K
Blanket Conductivity:	45.5 W/mK
Blanket Heat Capacity:	2.23·10 <sup>9</sup> J/K
Shield Conductivity:	24.6 W/mK
Shield Heat Capacity:	1.26·10 <sup>9</sup> J/K

The containment building was the same one that was used for the base case of the first study. Dimensions are given in Table 1. The initial temperatures of the reactor components were taken from the BCSS and are shown below [4]:

Lithium spill:	500 C
First wall:	690 C
First wall floor:	690 C
Reactor blanket:	550 C
Blanket shield:	100 C

The amount of lithium spilled was set at 10,000 kg—it was assumed that the entire lithium inventory of the punctured section would not spill out because of the geometry of the reactor. The size of the crack in the blanket was varied during the study to determine its effects on the fire. Crack sizes were taken to be 1,10 and 100 cm<sup>2</sup>.

### III.3 Results

The results of the study are shown in Figures 23–29. The figures are plots of the most critical temperatures and the two cell gas pressures versus time for each crack size.

The temperatures of greatest importance are the first wall and first wall floor temperature as the reactor could be damaged by extremely high temperatures in these areas. From the figures it can be seen that the maximum first wall and floor temperatures in all cases were the initial operating temperatures of 690 C. Just after the start of the accident the temperature of the first wall dropped to that of the blanket, 550 C, as the heat capacity of the first wall was three orders of magnitude lower than that of the blanket. The first wall floor temperature dropped even farther—to about 520 C because the initial spill temperature was 500 C, and lithium also has a large heat capacity.

In the case of the smallest crack both temperatures converged slowly on 540 C as the blanket radiated heat to the shield and conducted heat from the first wall and to the first wall floor. Lithium ignition occurred at about 7500 seconds into the accident as evidenced by the jump in combustion zone temperature. The fire burned slowly as the small crack limited the amount of air available for combustion. From the plots of torus gas pressure and combustion zone temperature one can see that the fire was slowly burning itself out.

# First Wall Temperature

Initial spill temp.= 500 C  
Spill size= 10,000 kg

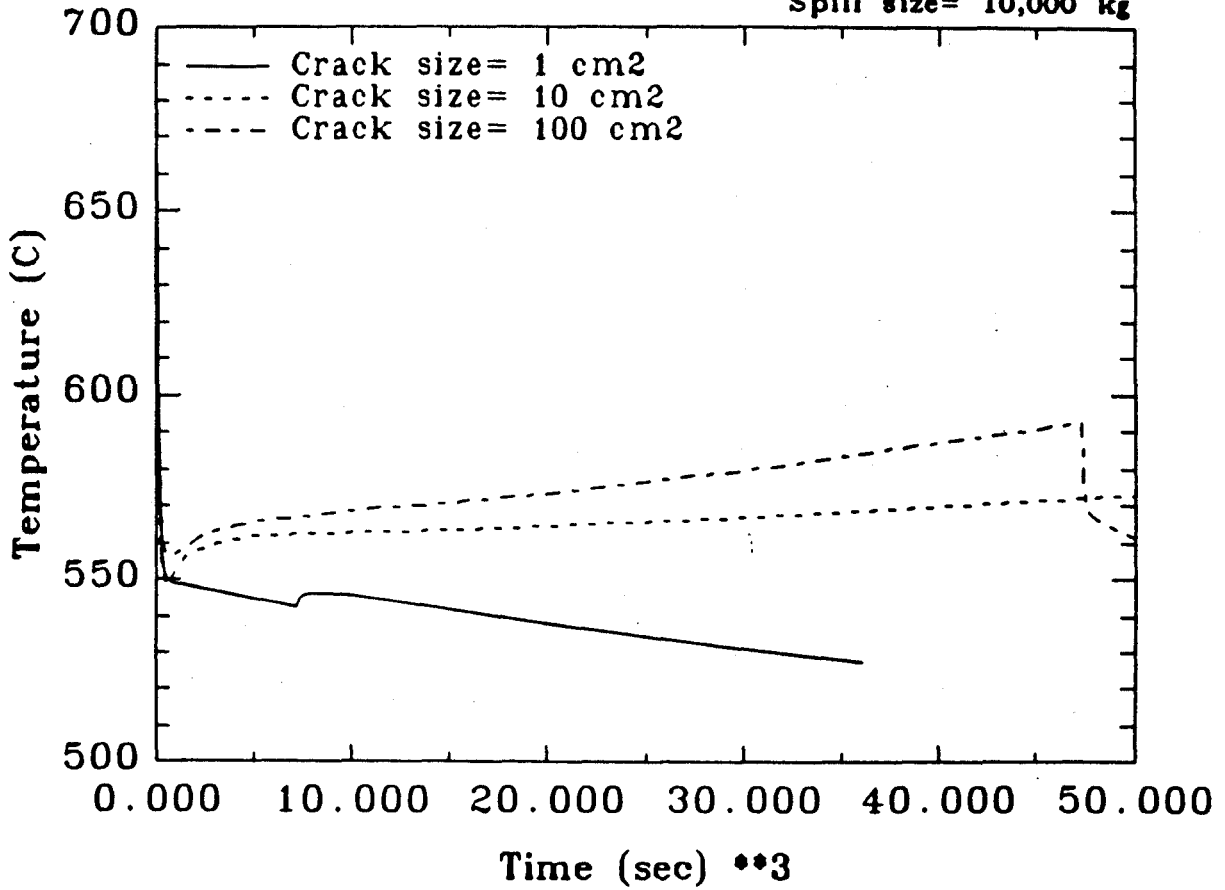

Figure 23 (Exposed) first wall temperature vs. time with varying crack size to containment

## First Wall Floor Temperature

Initial spill temp.= 500 C  
Spill size= 10,000 kg

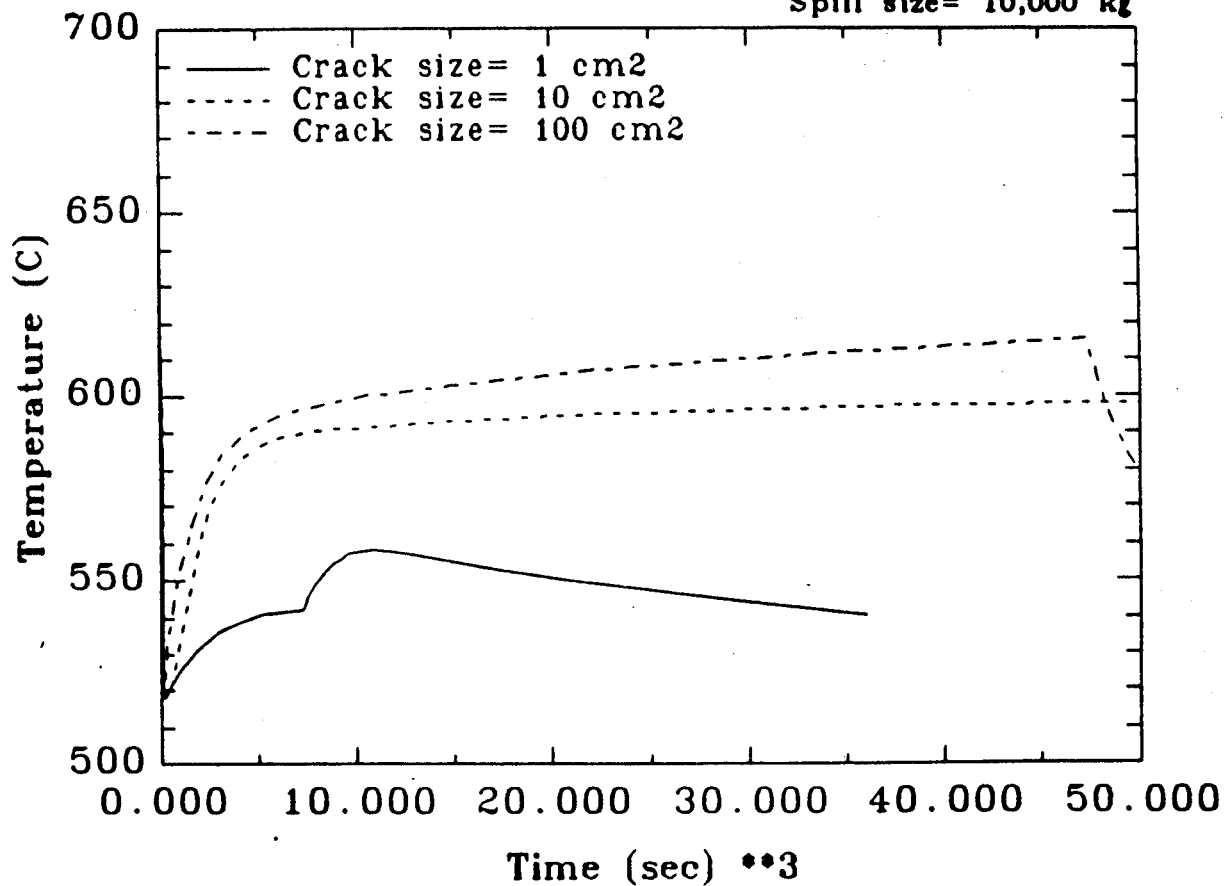

Figure 24 (Covered first wall) Floor temperature vs. time with varying crack size to containment

# Torus Gas Pressure

Initial spill temp. = 500 C  
Spill size = 10,000 kg

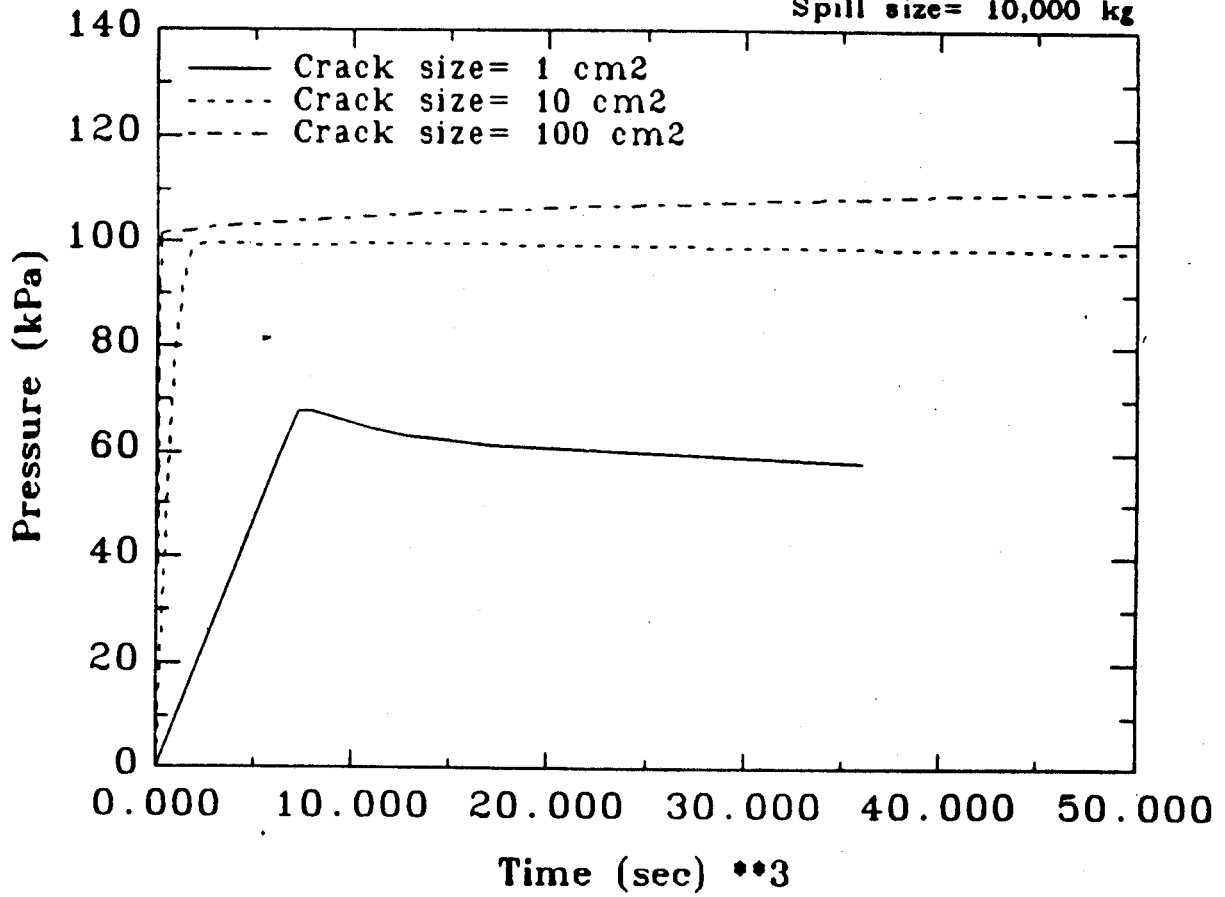

Figure 25 Torus gas pressure vs. time with varying crack size to containment



# Torus Gas Temperature

Initial spill temp. = 500 C  
Spill size = 10,000 kg

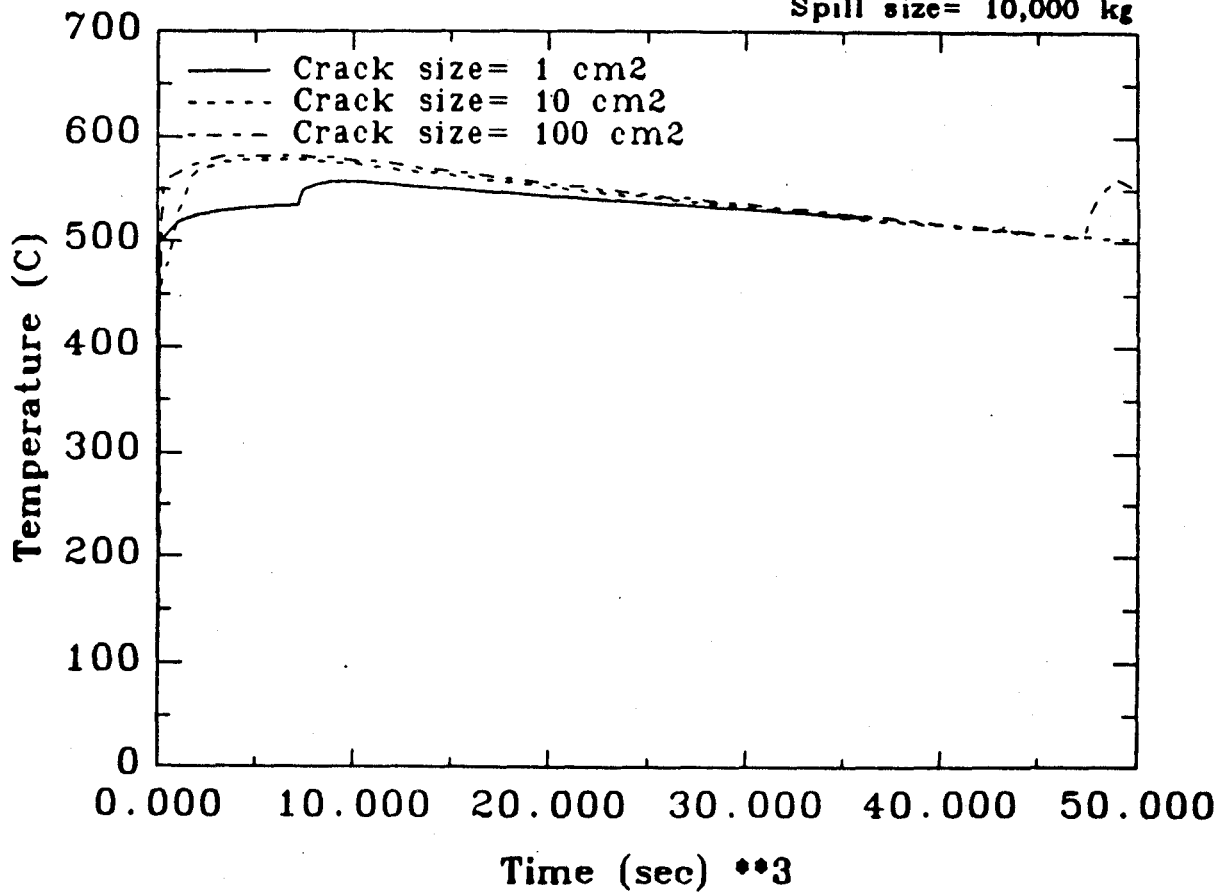

Figure 26 Torus gas temperature vs. time with varying crack size to containment

# Containment Gas Pressure

Initial spill temp.= 500 C  
Spill size= 10,000 kg

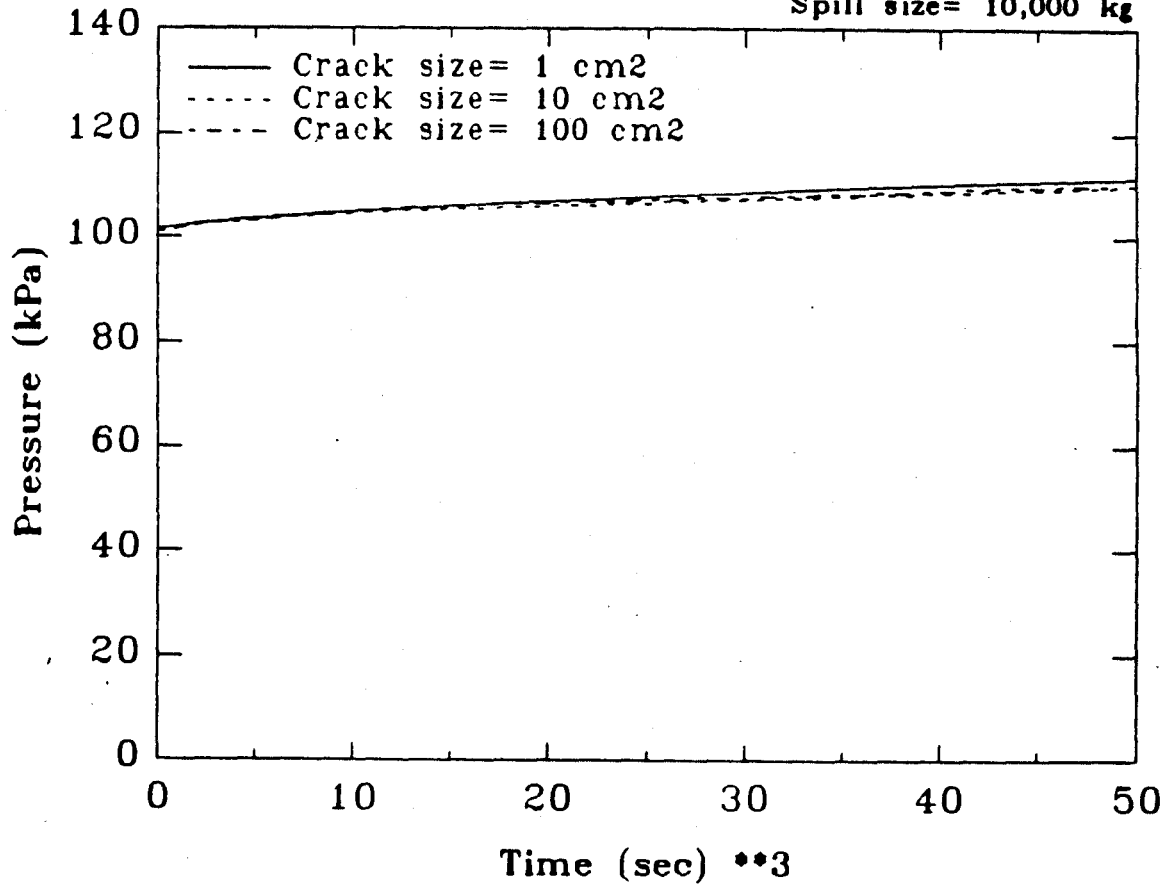

Figure 27 Containment gas pressure vs. time with varying crack size to containment

## Containment Wall Temperature

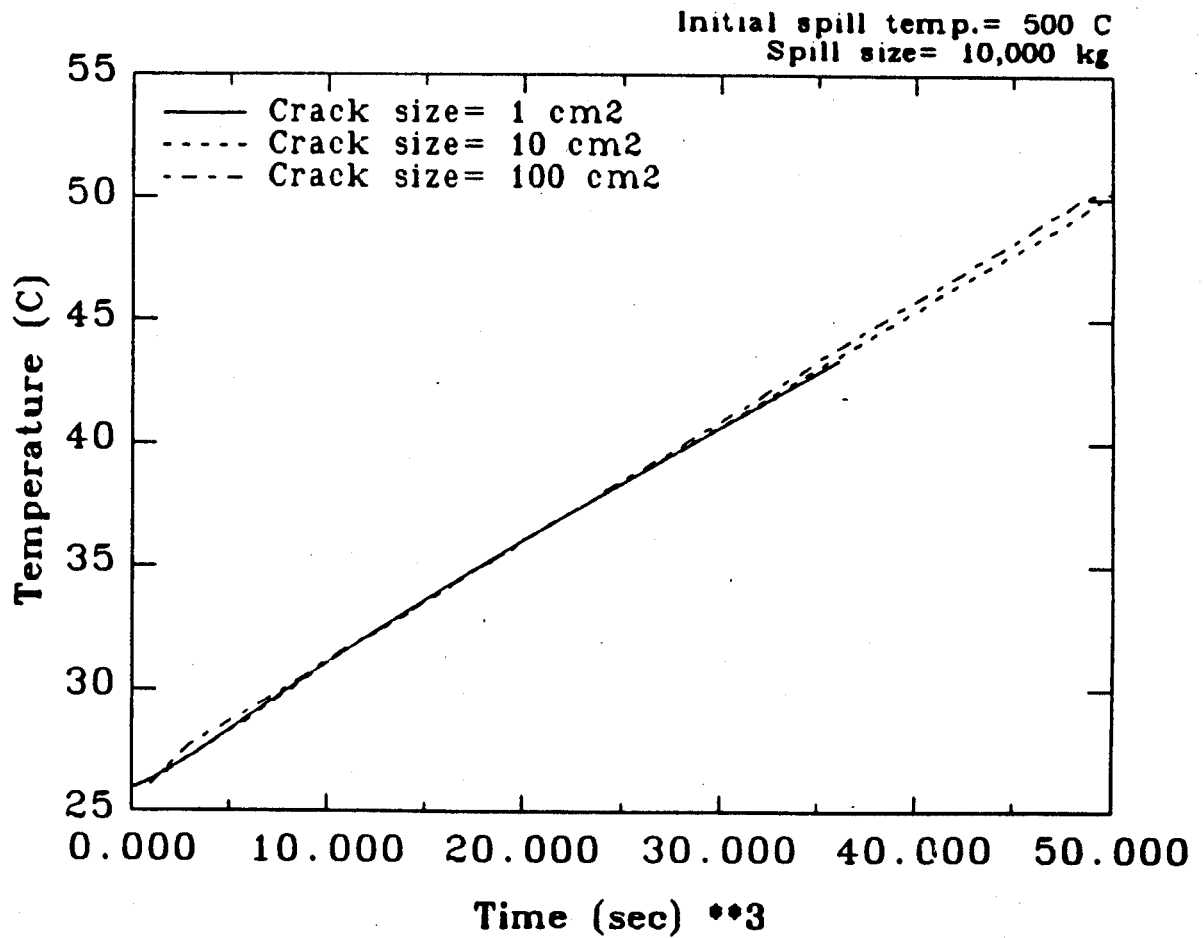

Figure 28 Containment wall temperature vs. time with varying crack size to containment

# Combustion Zone Temperature

Initial spill temp. = 500 C  
Spill size = 10,000 kg

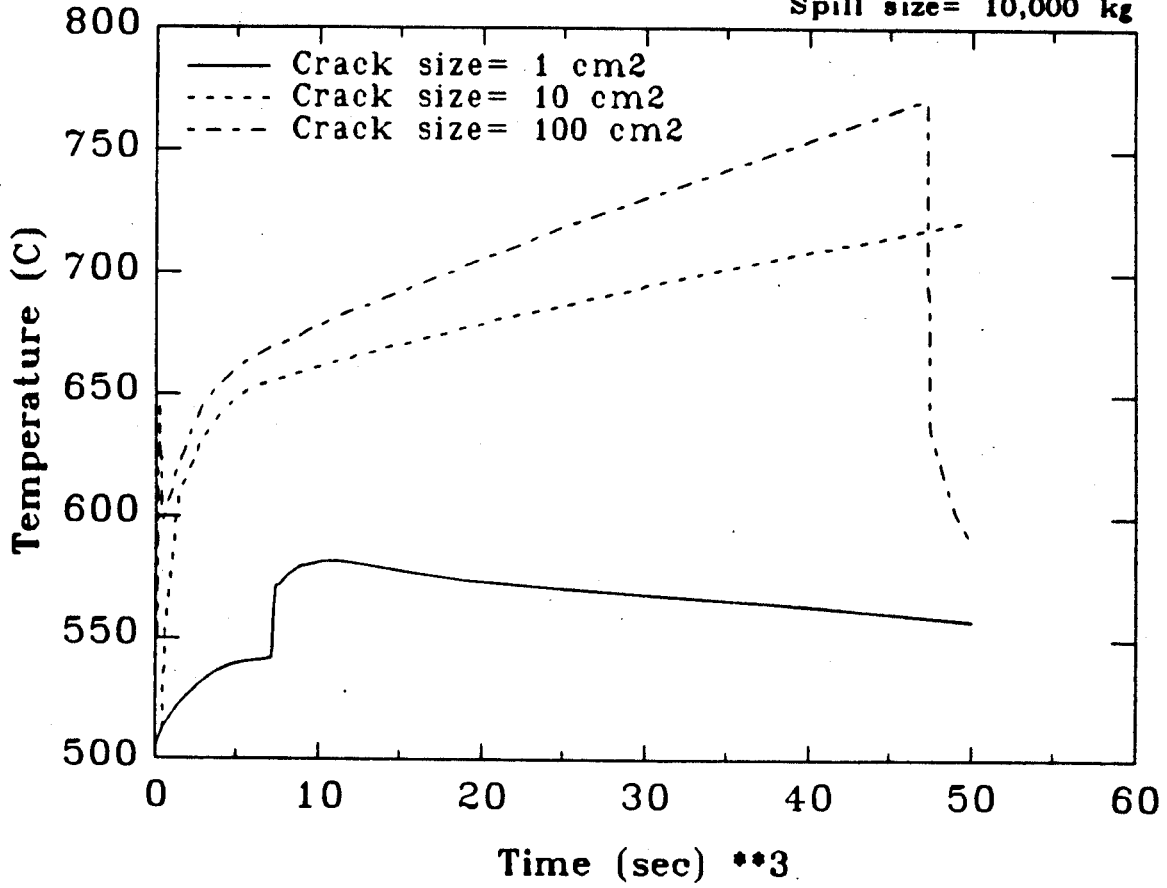

Figure 29 Lithium combustion zone temperature vs. time with varying crack size to containment

An examination of the primary cell gas contents (not shown here) indicated that the oxygen in the air was being consumed faster than the nitrogen. This was due to the fact that in air at 550 C the lithium-oxygen reaction consumes lithium at about the same rate as the lithium-nitrogen reaction. Thus the oxygen forming  $\text{Li}_2\text{O}$  was consumed about 1.5 times faster than the nitrogen forming  $\text{Li}_3\text{N}$  [5]. Because of this, the fraction of oxygen in the primary cell was decreasing along with the total gas pressure. The first wall and torus gas temperatures decreased slowly until the end of the run as did torus gas pressure.

These slow rates of change caused problems with the code's time step control device which bases the time step size on  $X/\frac{dX}{dt}$ , where  $X$  is the quantity changing. The time steps calculated were very large and produced non-physical results. A user specified time step limit was added to the code to correct this problem. It was mostly successful, although the beginning of a time step instability can be seen in the plot of combustion zone temperature at a time of 200 seconds into the accident.

In the cases of the 10 and 100  $\text{cm}^2$  cracks, lithium combustion started almost immediately. The first wall and first wall floor temperature in both cases rose quickly until about 4000 seconds into the accident when they leveled off and rose very slowly. In the case of the 100  $\text{cm}^2$  crack the lithium was completely consumed about 47,000 seconds into the accident and the first wall began to cool. Lithium combustion had not stopped after 50,000 seconds in the 10  $\text{cm}^2$  case and first wall temperature was still rising very slowly at that point.

The long burn times were caused by the relatively small pool area and the temperature dependence of the lithium-air reaction. It can be seen from the plots of first wall floor temperatures that the adjacent lithium did not get nearly as hot as in the case of the containment building spill. This was due to the good heat conductivity of the first wall and the blanket, and the very high heat capacity of the blanket. Since the lithium vaporized and diffused up into the combustion zone, the cooling of the lithium by the first wall and blanket did not allow the combustion zone temperature to rise to a point where the reaction proceeded more quickly. This is shown in Figure 29. In the case of the containment

spill, the containment floor lost heat slowly through the concrete. this allowed the heat of combustion to heat the lithium, which in turn increased the reaction rate, creating a positive feedback loop that raised the floor temperature to about 950 C and the combustion zone temperature to about 1250 C. The lithium-air reaction rate is about 15 times slower at a pool temperature of 600 C than at a pool temperature of 950 C [5]. In the case of the fire in the tokamak, the feedback loop was broken by the high thermal conductivity and heat capacity of the blanket.

An examination of the cell gas pressure and temperature plots shows that in the cases of the 10 cm<sup>2</sup> crack, the two pressures never quite equalized, although torus gas pressure leveled off at about 100 kPa. That suggests that the air flow rate was in equilibrium with the air consumption rate and that a crack size of more than 10 cm<sup>2</sup> would not affect the lithium combustion very much, as containment gas pressure was initially 101.4 kPa. A smaller crack would suppress the fire by limiting the air supply in the torus. This was confirmed by the 1 and 100 cm<sup>2</sup> runs. As discussed previously, the fire burned itself out in the 1 cm<sup>2</sup> case. The results of the 100 cm<sup>2</sup> crack run were not much different from those of the 10 cm<sup>2</sup> run. In that run, torus gas pressure quickly increased to that of the containment and stayed there until the end of the run. Thus in the large crack run the two cells acted as one as far as gas pressure was concerned. This result was predicted by Gilberti [2]. Larger cracks would not have had a significant effect on the consequences of the fire.

The other most important concerns when considering the consequences of an accident are the effects of the fire on the containment. From the temperature and pressure plots, one can see that overpressurization was minimal in all cases. this was due to the slow lithium combustion rate. Most of the gas heating was caused by the cooling of the blanket shield. Radiation from the shield also caused the containment wall temperature to increase to 50 C at 50,000 seconds into the accident, at which point it began to level off. Because of the design of LITFIRE, hot gas could not diffuse out of the primary cell. Gas transport, and heat transfer from the primary cell gas to the secondary cell gas occurred only by mass flow from one cell to another. Thus the secondary cell gas heating was caused by the

hot shield. In any case, damage to the containment would be unlikely to be caused by the temperatures or pressure reached during the accident.

### III.4 Conclusions

Overall, the effects of a lithium fire inside a tokamak would not be catastrophic from the point of view of the temperatures or pressures reached during the accident. This is due primarily to the very large heat capacities of both the reactor blanket and blanket shield which absorb most of the heat conducted through the lithium pool and first wall. In addition the small pool area and temperature dependence of the lithium-air reaction limits the heat generation rate such that the first wall floor temperature does not exceed the blanket operating temperature. The consequences of a lithium spill outside the reactor, as shown by the earlier sections, could be much more severe than the consequences of a spill inside a tokamak.

## References

- [1] D.A. Dube and M.S. Kazimi, "Analysis of Design Strategies for Mitigating the Consequences of Lithium Fire Within Containment of Controlled Thermonuclear Reactors", MITNE-219, July, 1978.
- [2] V.J. Gilberti and M.S. Kazimi, "Modeling of Lithium and Lithium-Lead Reactions in Air Using LITFIRE", MIT PFC/RR-83-08, January, 1983.
- [3] E. Yachimiak, et al., "LITFIRE User's Guide", MIT PFC/RR-83-11, June 1983.
- [4] D. Smith et al., "Blanket Comparison and Selection Study", ANL/FPP-84-1, January, 1984.
- [5] T.K. Gil and M.S. Kazimi, "The Kinetics of Liquid Lithium Reaction With Oxygen-Nitrogen Mixtures", MIT PFC/RR-86-1, January, 1986.