

Contingency Munitions Logistics Planning and Control: A Framework for Analysis

by

Andrew E. Coop

B.S., Operations Research, United States Air Force Academy (1996)

Submitted to the Sloan School of Management
in Partial Fulfillment of the Requirements
of the Degree of

MASTER OF SCIENCE IN OPERATIONS RESEARCH

at the

Massachusetts Institute of Technology

June 1998

©Andrew E. Coop 1998. All Rights Reserved.

The author hereby grants to MIT
permission to reproduce, to
distribute publicly, and to
create electronic copies of this thesis
document in whole or in part.

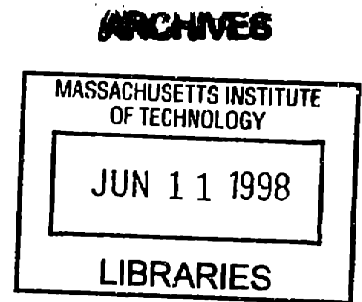

Signature of Author: _____

Sloan School of Management
Interdepartmental Program in Operations Research

Approved by: _____

Stephan E. Kolitz
The Charles Stark Draper Laboratory, Inc.
Technical Supervisor

Certified by: _____

Cynthia Barnhart
Associate Professor of Civil and Environmental Engineering
Thesis Advisor

Accepted by: _____

Robert M. Freund
Seley Professor of Operations Research, Sloan School of Management
Codirector, Operations Research Center

A. 0.0.0.

0.0.0.

Contingency Munitions Logistics Planning and Control: A Framework for Analysis

by

Andrew E. Coop

B.S., Operations Research, United States Air Force Academy (1996)

Submitted to the Sloan School of Management
in Partial Fulfillment of the Requirements
of the Degree of Master of Science in Operations Research

Abstract

The importance of efficient logistics operations in military applications was made clear by the lessons of the Persian Gulf War. Although force application against Iraqi forces was deemed an overwhelming success, a lack of planning capability and real-time visibility over deploying cargo led to poor distribution control of sustainment assets and massive congestion at terminal facilities. Evolutions in force posture today dictate the need to support global power projection into austere theaters with minimal planning horizons. This research explores planning and control for US Army intermodal logistics operations, specifically the mobilization of containerized sustainment munitions. To provide necessary background, a high level description of CONUS transshipment operations and network infrastructure is given, along with a review of automated information systems being developed to provide real-time total asset visibility.

Little work has been done to automate plan generation for decision support in this area. A hierarchical framework for deployment planning is presented, and a multicommodity network flow model is formulated to generate munitions mobilization plans. Some extensions to the model are proposed, and performance is demonstrated through an initial implementation and scenario analysis. Requirements for operational use are discussed.

Thesis Advisor: Professor Cynthia Barnhart
Title: Associate Professor of Civil and Environmental Engineering

Technical Supervisor: Dr. Stephan E. Kolitz
The Charles Stark Draper Laboratory, Inc.

Acknowledgments

There are many to whom I owe thanks for their contributions to my thesis research and my experience at MIT.

I am grateful to the United States Air Force and the USAF Academy for allowing this incredible educational opportunity, and to the Charles Stark Draper Laboratory for its commitment to education and for funding my tuition at MIT. The Operations Research Center is a fantastic place to learn.

I am indebted to the gentlemen who have gone before me: Captain Andy Armacost of the Department of Management and Captain Jonathan Robinson of the Department of Computer Science at USAFA. It was their mentorship that opened the doors. I also owe thanks to Colonel Daniel Litwhiler, Major Mat Durchholz, and Major Ralph Boedigheimer of USAFA for their generous support.

Most importantly, I thank Dr. Stephan Kolitz of Draper Laboratory for his technical vision and guidance throughout the project. Equally invaluable was the assistance I received from Professor Cynthia Barnhart of MIT; in spite of her schedule, she was always committed to her students and to teaching. It was honor to work with professionals of such caliber in applied research for two years.

A salute to Steve Nelson of Draper, whose coding wizardry sparked the framework for MLAST, and to Chien Ma and Mike Hutchins for picking up where I left off.

A big thanks to Lary Marler of MTMC, Roger Straight of MTMCTEA, Ed Jamieson at IOC, and to Terry Snyder at LMI for their help in deciphering an incredibly complex system. Owing no allegiance to my efforts, they found time to dig up reports, regulations, and other obscurities I needed. I must also recognize David Oaks for his groundbreaking doctoral research at RAND on this problem.

I am grateful to my friends at Draper and in Boston who made an effort to make my stay more enjoyable: Mike Jamoom, Birgit Sauer, Chris Dever, Antonio Giustino, Chad Tilbury, Gordon Maahs, Carla Haroz, Cora Stubbs-Dame, Nina Erlich, Naresh Shah, Jeff Barchers, Varun Puri, Mandy Birch, Kerri McDonough, Beau Lintereur, and Rudy Boehmer.

My mother, Rose, and father, Gary, deserve the utmost recognition for their enduring love and support. Through the good times and the bad, no sacrifice was too great for their sons.

Finally, I would like to thank my fiancée, Barbara, for persevering with me.

Assignment

Draper Laboratory Report Number T-1308.

This thesis was prepared at The Charles Stark Draper Laboratory under CSR C601 (DFY 1997 and 1998, "Advanced Transportation and Logistics"). Publication of this thesis does not constitute approval by Draper or the Massachusetts Institute of Technology of the findings or conclusions contained herein. It is published solely for the exchange and stimulation of ideas.

Permission is hereby granted by the author to the Massachusetts Institute of Technology to reproduce any or all of this thesis.



Andrew E. Coop
2nd Lieutenant, USAF
8 May 1998

Table of Contents

1. Introduction.....	11
1.1. Research Scope	15
1.2. Thesis Objective and Content	18
2. CONUS Munitions Transshipment Operations.....	21
2.1. General Non-Unit Deployment.....	22
2.2. Munitions Deployment Coordination.....	22
2.3. Depot Operations.....	25
2.3.1. Stockpile Assessment.....	26
2.3.2. The Tier Depot Concept.....	28
2.3.3. Munitions Outloading.....	31
2.3.4. Challenges to Depot Operations.....	32
2.3.4.1. Inventory Growth.....	32
2.3.4.2. Outdated Infrastructure & Technology.....	32
2.3.4.3. Demilitarization Backlogs	33
2.3.4.4. Suboptimal Stock Distribution.....	33
2.3.4.5. Lack of Funding for Essential Support Functions.....	34
2.4. Port and Sealift Operations	34
2.4.1. The Ports.....	35
2.4.2. Port Architecture.....	38
2.4.3. General Deployment Procedures and MHE	39
2.4.4. Munitions Sealift: Vessel Operations in Port.....	44
2.4.4.1. Containerships	44
2.4.4.2. Barge Carrying Ships	45
2.4.4.2.1. Lighter Aboard Ship (LASH) Class	45
2.4.4.2.2. SEABEE Class.....	45
2.4.4.3. RoRo Ships	46
2.4.4.4. Principles of Vessel Stowage	47
2.4.4.4.1. Stowage Location Terminology.....	47
2.4.4.4.2. Stow Planning and Execution.....	49
2.5. Chapter Summary.....	51
3. DoD Logistics Information Management and Total Asset Visibility (TAV)	53
3.1. Introduction and TAV Concept Overview	54
3.2. Munitions Requisition Tracking.....	56
3.3. Material Business Area: In-Storage and In-Process Visibility	58
3.4. Transportation Business Area: In-Transit Visibility	59
3.4.1. The Core ITV System: GTN	64

3.5. The Foundation for Real Time Information: Automatic Identification Technology (AIT)	66
3.6. Chapter Summary: TAV Within a Command and Control Perspective.....	69
4. Munitions Deployment Planning.....	73
4.1. Deployment Planning Taxonomy	75
4.1.1. Resource (Strategic) Deployment Planning.....	75
4.1.2. Deliberate (Tactical) Deployment Planning	76
4.1.3. Crisis Action (Operational) Deployment Planning.....	77
4.1.4. Spatial Network Decomposition	78
4.2. A Hierarchy for Munitions Deployment Planning	80
4.3. Mathematical Problem Formulation.....	85
4.3.1. Multicommodity, Multimode, Capacitated Minimum Cost Flows.....	88
4.3.2. Toward a Dynamic Plan: Integrating the Temporal-Spatial Network...90	
4.3.3. Integrating Internal Capacity Constraints.....	93
4.3.3.1. Intraport Flows	93
4.3.3.2. Intradepot Flows.....	97
4.3.4. Other Potential Model Details	99
4.3.4.1. Minimization of Pipeline Inventory	100
4.3.4.2. Activating Excess Capacity: Outload at Lower Tier Facilities ..100	
4.3.4.3. Relaxing Late Deliveries.....	102
4.3.5. Summary	104
4.4. Model Implementation.....	105
4.4.1. Problem Test Case.....	105
4.4.2. Scenario Analysis for Resource (Strategic) Planning.....	110
4.4.2.1. Base Scenario.....	113
4.4.2.2. Shortfalls in Depot Containerization Capacity.....	117
4.4.2.3. Port Conveyance Throughput Levels.....	118
4.4.2.4. Other Port Infrastructure Issues	119
4.4.2.5. Lead Time Reduction.....	121
4.5. Chapter Summary: Model Applicability.....	123
5. Summary and Future Work.....	125
5.1. Research Summary.....	125
5.2. Future Work	127
5.2.1. Planning.....	127
5.2.2. Simulation	128
Appendix A - Scenario Analysis Response Charts.....	133
Glossary of Acronyms	151
References	157

List of Figures and Tables

Figure 1.1: Munitions within Defense Contingency Logistics Classification.....	15
Figure 2.1: General Logistics Flows for Contingency Operations	21
Figure 2.2: Sustainment Munitions Transportation Coordination.....	23
Figure 2.3: Key Nodes in the Munitions Logistics Network.....	24
Figure 2.4: CONUS Munitions Stockpile Composition.....	26
Figure 2.5: Final Planned Munitions Stock Composition by Tier.....	29
Figure 2.6 Port Rail-to-Truck Container Transfer Pad Layout.....	42
Figure 2.7 Port Container Storage/Holding Pad Layout	43
Figure 2.8 Container Stowage Addressing System	49
Figure 3.1: TAV Operating Concept.....	55
Figure 3.2: Processing Material Requisitions	57
Figure 3.3: ITV Operating Concept for Non-Unit Cargo	61
Figure 3.4: Concept of Operation for AIT Application.....	69
Figure 3.5: TAV/ITV AIS Capability Summary.....	71
Figure 4.1: Deployment Pipeline with Suspenses – Fort to Foxhole	79
Figure 4.2: Hierarchical Decomposition Principles.....	80
Figure 4.3: Hierarchical Decomposition for Munitions Deployment Planning.....	81
Figure 4.4: C ² Internal and Hierarchical Functions.....	84
Figure 4.5: Daily Follow-On Sustainment Munitions Shipments	86
Figure 4.6: Time-Space Network Flows.....	92
Figure 4.7 Intraport Flows at Port <i>j</i>	94
Figure 4.8: Late Container Flows	103
Figure 4.9: Notional Container Distribution by NEW in Short Tons	107
Figure 4.10: Notional Container NEWs and Shipping Weights in Short Tons	107
Figure 4.11: Sustainment Munitions Stock Distribution Used	108
Figure 4.12: Base Case Supply-Demand Assignments.....	114
Figure 4.13: Base Case Depot Average Utilization Levels.....	115
Figure 4.14: Base Case Depot NEW Levels.....	116
Figure 4.15: Base Case Port Demurrage Levels.....	116
Figure 4.16: Base Case Port NEW Levels	117
Figure 5.1: MLAST Simulation Graphical User Interface (Web Browser).....	129
Figure 5.2: Plan Testbed Architecture.....	131
Table 2-1: Tier I/II Installation Summary.....	30
Table 3-1: Selected AIT Summary Data.....	67
Table 4-1: Scenario Analysis Summary: Significant Changes.....	122

1. Introduction

“Logistics is traditionally an unglamorous and underappreciated activity. To generalize, when the battle is going well, the strategist and tactician are lionized; it is only when the tanks run out of gas that people go head-hunting for the logisticians.”

- Lt. General William G. Pagonis, US Army, Ret.

Logistics support, providing the right equipment to the soldier at the right place and the right time, has always been fundamental to successful warfare. Warfare has become increasingly more mobile and driven by technology during the 20th century, and today U.S. forces face a more uncertain post Cold War world that demands rapid global power projection into austere theaters with minimal planning horizons. As defense spending continues to dwindle and support organizations are reduced in force or eliminated altogether in the late 1990s, it is clear that 21st century conflicts will require the support of lean logistics structures and efficient planning and control systems.

The importance of logistics planning and control was made clear by the lessons of Operations Desert Shield and Desert Storm. The sheer magnitude of the support delivered between August 1990 and August 1991 to the U.S. Armed Forces in Southwest Asia is staggering: 122 million meals served, 1.3 billion gallons of fuel

consumed, 31,800 tons of mail delivered, and 52 million miles driven in theater; an effort that has been compared to relocating the city of Richmond, Virginia [45]. The allied victory over Iraq was deemed a overwhelming success, but there were many potential problems that did not impact US forces because Saddam Hussein allowed a prolonged force build-up unopposed for months.

First, the lack of real-time visibility over both cargo and personnel was severe, resulting in poor distribution management. Out of the approximately 40,000 containers of equipment that arrived in theater, half had to be opened, inventoried, resealed, and reinserted back into the transportation system [61]. In addition, commanders who were experiencing delays in equipment delivery or who were otherwise distrustful of the logistics system, placed thousands of duplicate orders. Many tons of unneeded material were sent to the operating theater, increasing demand on transportation resources, and compounding congestion at shipping and receiving facilities. Extensive manual operations were the norm. This resulted in US forces not receiving critical equipment and supplies in a timely manner, and the Department of Defense (DoD) paid an estimated \$150 million in unnecessary demurrage and detention fees for containers [21]. Even medical patient support was a calamity: sixty percent of evacuated personnel ended up at a wrong destination.

Delivery of sustainment logistics by sealift was slow. It took over two months to get the first sealift shipments from the continental United States (CONUS) to the theater of operations [43]. Deployed units who lacked container capable materials handling equipment relied excessively on break-bulk operations, imposing further delays.

The need for logistics planning and control systems today is further motivated by the lack of capacity throughout the CONUS supply network infrastructure. After the DoD established a need for the capability to engage in two simultaneous major regional conflicts (MRCs), a mobility requirements study was conducted. Within the arena of ordnance transportation (the focus of this thesis), the study found that in the event of two MRCs, the DoD's supply network would need to support the shipment of 1,440 containers of ammunition out of CONUS each day, split evenly into 720 containers out of the east and west coast munitions terminals each day [25, 33]. These requirements came to be collectively known as the Mobility Requirements Study

Bottom-Up Review (MRS BURU). This is a significant challenge when both munitions terminals on the west coast, which up until the time of this writing have been used primarily for the resupply of the U.S. Navy's Pacific Fleet, are not operating at full capacity for container operations. Additional challenges include the following:

- Storage and outloading capacity have been depleted by post Cold War Army depot consolidations and closures. During Operation Desert Storm, there were 23 supply installations supporting munitions outloading. When the mobility requirements study was completed, the number of facilities had been reduced to 16 [3]. Additional consolidations have led to a tiering system which will provide for only eight fully container capable installations [24]. These facilities also face many internal challenges such as inventory growth, outdated infrastructure, demilitarization backlogs, suboptimal stock distribution, and shortfalls in funding for essential support functions.
- Reduced manpower and peacetime operational tempo have weakened workloads at all key logistics facilities, possibly jeopardizing readiness for mobilization.
- Commercial trucking availability is falling; ten years ago there were twenty five trucking companies certified for interstate hazardous cargo transport, in 1995 there were only ten [43]. This has become an increasingly unattractive business for trucking companies because the DoD requires higher liability coverage, trucks equipped with satellite tracking instruments, and provision of two drivers holding security clearances per truck.
- The availability of railroad transportation is also a concern. Downsizing and consolidation of rail shippers along with new technologies that are unsuitable for ammunition transportation (e.g., double container flatcars) have reduced capacity.
- Although some munitions shipments are made in breakbulk, the great majority are moved under the Containerized Ammunition Distribution System (CADS). Containers are large standard steel boxes that are the foundation of intermodal

logistics as their homogeneity allows for rapid transfer between container capable truck chassis, railcars, and marine vessels with the use of specialized handling equipment. Most of the world containership fleet is configured to handle forty foot long containers, but due to weight and safety restrictions, munitions are shipped in specialized twenty foot containers. Only about 23 percent of US containerships regularly carry support twenty foot containers. A limited resource, there are 12,000 containers in the CADS system and approximately 5,350 ammunition grade containers available for lease [11].

To address some of these issues, the Military Transportation Management Command (MTMC), the U.S. Army's component of the DoD's unified United States Transportation Command (USTRANSCOM), launched the Integrated Munitions Management Project (IMMP). IMMP is the original impetus for this research. As presented at the initial IMMP Scoping Workshop in November, 1996, IMMP began as "an integration effort to optimize a water port's management processes to improve munitions throughput by streamlining, improving, and integrating existing and new state of the art technologies" [25]. Originally aimed at the Concord Naval Weapons Station marine terminal in California, the scope has since taken a world-wide perspective. The first objective of the effort is to streamline logistics management processes primarily through business process re-engineering. The second objective is to integrate the redundant network of stovepipe legacy munitions management systems and databases into a modern information environment.

However, MTMC only has authority over some marine terminal operations in support of Army munitions transportation. Some west coast munitions terminal operations are under the authority of the Naval Ordnance Center. Although closely tied to MTMC under the authority of USTRANSCOM, the Military Sealift Command (MSC) controls all marine transportation assets. Furthermore, production, inventory, and in-CONUS transportation of munitions is controlled by the Industrial Operations Command (IOC), under the US Army's Material Command. The hierarchy of authorities involved in the process is very complex, and it is clear that extensive coordination will be required for implementation of any efforts to improve the logistics pipeline.

1.1. Research Scope

The logistics structures in the DoD are very complex and different supply networks exist to support the delivery of both cargo and personnel. Cargo delivery mechanisms can be classified by unit, non-unit, personal property, and redeployment and retrograde subcomponents. Personnel support can be divided into unit, non-unit, medical patients, and redeployment subcomponents. The focus of this research is to explore deployment operations and planning for one well defined subdivision of non-unit cargo: follow-on sustainment munitions. This logistics classification with our emphasis on munitions is displayed in Figure 1.1:

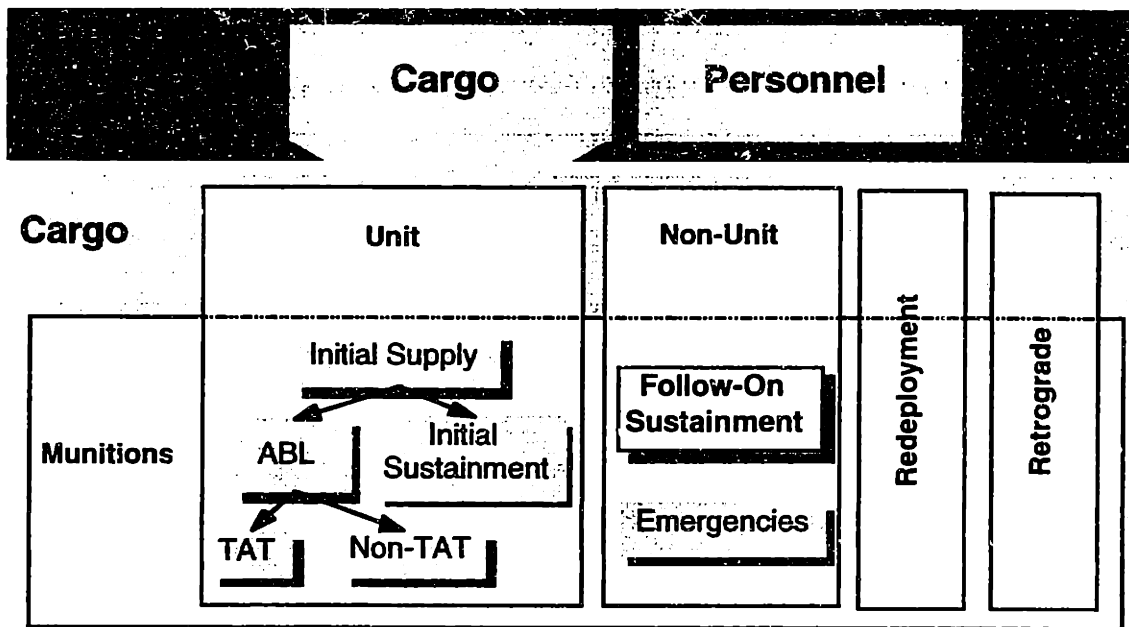

Figure 1.1: Munitions within Defense Contingency Logistics Classification

A definition of the relevant cargo classifications is necessary to direct the emphasis of this thesis. *Unit cargo* basically includes all unit equipment, accompanying supplies, and prepositioned materials under the ownership of a specific operational organization. *Non-unit cargo*, on the other hand, is all sustainment material in CONUS, prepositioned overseas, or afloat, maintained by supporting logistics organizations. *Redeployment* and *retrograde* cargo are classifications based on destination. Redeployment cargo is any material in theater destined for another theater. Retrograde cargo is any material bound for CONUS for maintenance, disposal, or reconstitution.

Unless otherwise specified, all cargo shipment discussions in this thesis are assumed to be exports from a CONUS origin to a theater destination (i.e., *deployment cargo*).

Within the munitions cargo subcategory (also known as Class V cargo), there are also unit and non-unit categories, designated *initial supply* and *follow-on sustainment*, respectively. The munitions categories in Figure 1.1 are defined as follows [43]:

- **Initial Supply:** Munitions shipped to the theater of operations with the deploying units or immediately thereafter in quantities and mixes to support limited, mainly defensive missions early in a contingency. Initial supply munitions consist of two types: ABL and Initial Sustainment.
 - **Ammunition Basic Load (ABL):** These are munitions assigned to specific units at the outset of operations, with quantities calculated on a per-soldier-per-weapons-system basis. Here again there are two subcategories: TAT and Non-TAT.
 - **Munitions to Accompany Troops (TAT):** As the name suggests, these are ammunition supplies strictly organic to the combat unit; carried by individual soldiers, uploaded on deploying combat vehicles, or otherwise carried onboard unit vehicles.
 - **Non-TAT:** Although not carried by the unit they are under immediate ownership and are typically shipped to the port of embarkation along with unit equipment or shipped to arrive immediately following the unit at the theater port of debarkation.
 - **Initial Sustainment:** These munitions originate from forward deployed stocks (which still exist in some quantities in Germany, Korea, and Kuwait), Army War Reserve-3 (AWR3) Afloat Prepositioning Ships (APSs); and other quantities beyond ABL that are released immediately.

Initial sustainment inventories may be minimal in today's austere contingency environments.

- **Follow-on Sustainment:** Types and amount of munitions sufficient to support additional operations beyond those required for deterrence and defense of a lodgment, providing the ability to mount an offensive or otherwise bring closure to the operation. These munitions are drawn from three critical inventories: first from remaining in-theater stocks and APSs, and then primarily from CONUS storage depots. They are also delivered directly from production if necessary. The vast majority of these munitions are containerized at their supply origins, shipped via commercial truck and rail transportation to marine terminals, and then delivered to the theater by sealift. This munitions stock is also commonly referred to as *war reserve* when in storage. This classification is also broken down by inventory location: AWR1 - CONUS, AWR2 - Europe, AWR3 - Afloat, AWR4 - Pacific Theater, and AWR5 - Southwest Asia [5]. This category is the focus of this thesis. More specifically, we will focus our attention on the deployment of AWR1 stocks since they constitute the great majority of follow-on sustainment.
- **Emergency Requests:** These munitions are shipped during the follow-on sustainment phase. However, unlike the previous categories which are pre-planned for contingency scenarios, these munitions deliveries are unforeseen needs that arise due to high expenditure combat, unanticipated threats, the need for high-technology rounds, mechanical problems, or combinations of these. Sourced from the same CONUS depots as follow-on sustainment material, they are instead palletized, trucked to US Air Force aerial ports of embarkation, and delivered via airlift. These requests receive immediate priority for outloading in the distribution network.

Follow-on sustainment munitions logistics management within this subnetwork of the overall contingency logistics system is a particularly attractive and potentially fruitful area for research and development for several reasons. Uncertainties in the nature of

tomorrow's conflicts puts additional emphasis on the capabilities of this network. Deployed US forces will be unable to rely on the presence of forward deployed munitions stocks and the mix of armament aboard the APS fleet is less likely to contain the necessary weaponry for the conflict at hand. Limited home station ammunition supply and tightly constrained deployment carrying capacity put additional demand on the CONUS depot system to cover the initial flow of follow-on sustainment material.

Munitions logistics shares many of the problems with managing logistics of other material classes, but due to net explosive weight (NEW) and hazardous cargo handling restrictions, the distribution network used to handle munitions is a well-defined disjoint subset of the entire defense logistics system (e.g., involving the use of specialized marine terminals and depots). Furthermore, unlike other logistics channels, the containerized ammunition pipeline is controlled extensively by the DoD (other commodities, such as personal property, are almost entirely controlled by commercial carriers and agencies). The problem is complex, tackling an entire arm of global power projection, yet sufficiently limited (e.g., three munitions ports in CONUS) to be tractable.

Finally, a system wide or network level perspective is necessary for any meaningful analysis because there are multiple process owners in the system. Due to interdependencies among elements of the logistics pipeline; myopically introducing changes for efficiency at a port or other location alone could possibly create a bottleneck or other coordination problem at another node. For any modification to the system, we require the ability to evaluate the impact on all major components.

1.2. Thesis Objective and Content

The research presented in this thesis is intended to set the stage for future research into the development and application of operations research models to military intermodal logistics and deployment problems. Although this work focuses on a very specific commodity class, many of the principles are applicable to other facets of the DoD's complex supply chain. The are three essential contributions of this thesis.

First, Chapter 2 provides an introductory discussion of current operations, infrastructure, and coordinating organizations in the CONUS munitions transshipment network. The emphasis is on the Army depots that manage munitions inventory and the specialized ports that facilitate transfer to sealift. This chapter is required background to understand the sustainment munitions mobilization problem. Important terminology and classifications are provided throughout.

Second, Chapter 3 reviews information protocols that are used to coordinate transshipment and the automated information systems architecture being developed by the DoD to provide real-time "Total Asset Visibility" (TAV). The discussion, while thorough, is high-level: issues such as data formats and technical specifications are neglected. A general understanding of these information flows and systems is also necessary operational knowledge. Real-time information is required for effective planning and control over the logistics/deployment pipelines.

Finally, Chapter 4 discusses deployment planning as it is done in practice in the DoD to establish a framework for hierarchical planning. Using this framework to decompose the problem for sustainment munitions, a network flow model is formulated to generate tactical (or deliberate) level plans. This development is progressive to allow the reader without a solid background in optimization or network theory to understand the underlying principles of how the model is built. The chapter concludes with a discussion of a test-case implementation of the model and a scenario analysis that demonstrates the strategic value of the model.

Chapter 5 summarizes the thesis and proposes areas for future work that would extend this research. This document integrates concepts from intermodal transportation, marine terminal operations, command and control, force deployment, hierarchical decomposition and planning, and optimization. For more detail, the reader is encouraged to consult the references provided at the end of this thesis that have contributed to many of the ideas herein. As with most other material describing complex DoD systems, a glossary of acronyms is also provided.

2. CONUS Munitions Transshipment Operations

Figure 2.1 provides a functional illustration of the deployment legs of *any* DoD cargo from a CONUS origin to an overseas theater. The logistics pipeline is divided into three segments: CONUS, intertheater, and theater. The last node in the CONUS network is the port of embarkation (POE), while the first node in the theater of operations is the port of debarkation (POD).

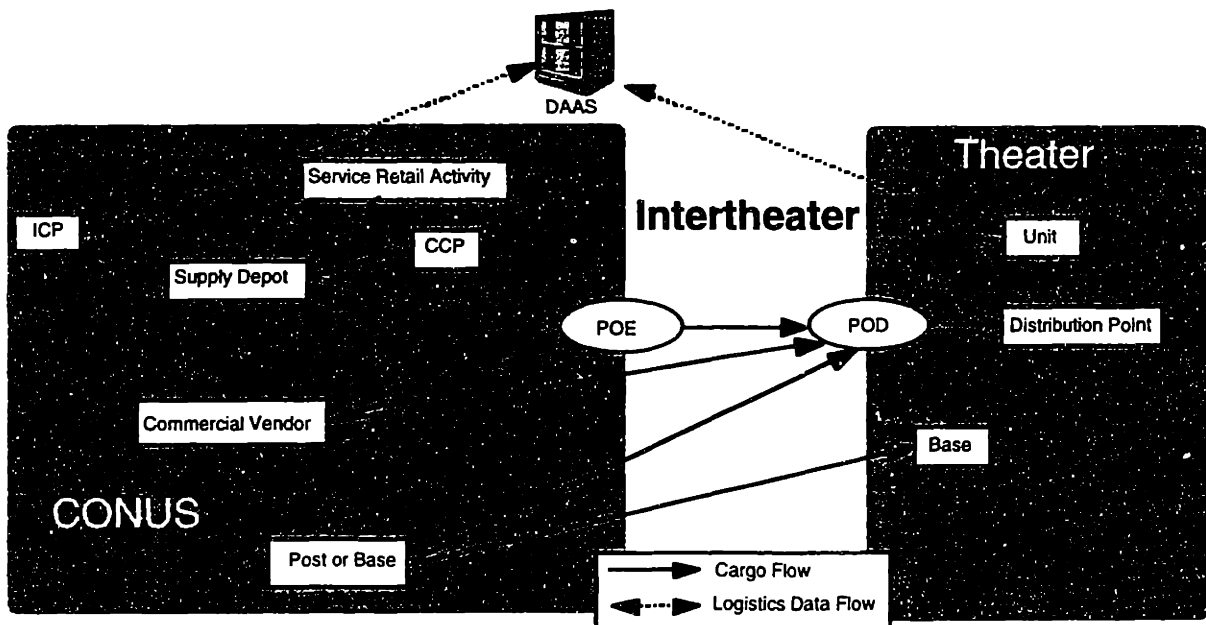

Figure 2.1: General Logistics Flows for Contingency Operations

2.1. General Non-Unit Deployment

The CONUS segment involves the majority of the DoD's supply and transportation network. Typically, in a non-unit movement, a request for cargo is sent electronically from the theater to the Defense Automatic Addressing System (DAAS), which then routes the requisition to the inventory control point (ICP) responsible for managing the item. ICP is a generic term for any DoD activity or agency assigned wholesale responsibilities for cataloging, requirements determination, procurement, distribution, overhaul, repair or disposal of equipment. After processing, the ICP creates a movement request and sends it to the CONUS supply or maintenance depot that maintains the item. The depot then ships the item by either commercial rail or truck transportation to either a container consolidation point (CCP) or directly to the port of embarkation (POE). The ICP may also authorize direct shipment from the commercial vendor to the POE, POD, or even the final destination. In fact, approximately one-third of all shipments are direct from vendor [61].

Upon arrival at the POE, equipment enters the intertheater segment of the pipeline. There are two types of POEs: air (operated by the US Air Force's Air Mobility Command, AMC), and surface or marine terminals (generally operated by the Military Traffic Management Command, MTMC). A POE operating system creates a manifest for the equipment and then coordinates its loading on an AMC cargo plane, commercial aircraft, Military Sealift Command (MSC) ship, or commercial ship for delivery to the POD. MTMC, MSC, and AMC are the three component commands of the unified US Transportation Command (USTRANSCOM). After a shipment is delivered and unloaded at the POD, it is sent to either a distribution point, base, or unit tactical assembly area.

2.2. Munitions Deployment Coordination

Figure 2.2 presents the coordination that occurs among the key authorities involved in sustainment munitions transportation:

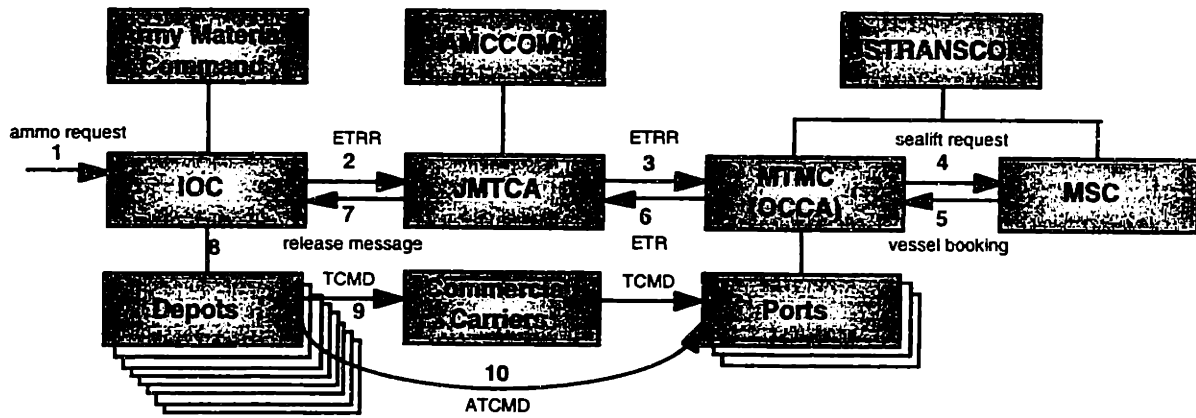

Figure 2.2: Sustainment Munitions Transportation Coordination

The U.S. Army's Industrial Operations Command (IOC) headquartered at Rock Island Arsenal, Illinois, serves as the national ICP for conventional munitions and as the Single Manager for Conventional Ammunition (SMCA) for the entire DoD. Upon receiving an ammunition requisition (1), IOC generates an export traffic release request (ETRR) (2), which is sent to the Joint Munitions Transportation Coordinating Activity (JMTCA), a component of the US Army Armament Munitions and Chemical Command (AMCCOM). JMTCA then coordinates sealift requirements with MTMC by sending this ETRR to the Ocean Cargo Clearance Authority (OCCA) (3), a subcomponent of MTMC, who approves the shipment and secures a booking (4, 5) on a Military Sealift Command (MSC) vessel. Follow-on sustainment munitions are shipped almost exclusively by sealift. The OCCA returns an export traffic release (ETR) to JMTCA (6) with established in-port date/windows, who then develops a munitions movement plan to ensure shipment of munitions in the most cost effective and timely manner. JMTCA provides ammunition release messages (7) to the applicable IOC supply installations and destination ports to direct the transportation process. Since commercial munitions vendors are not under the control of the IOC, it is unclear what role they play in the coordination process. For this reason and to keep the scope of the problem manageable, although vendor shipments will clearly have an impact on POE performance, we do not consider them in our analysis.

Following coordination with JMTCA, IOC directs the assigned source depot for a munitions shipment (8) to containerize cargo and release it to commercial carriers. Ammunition release messages to the depots alert shippers to special instructions such

as lot integrity and composition, maintenance, and appropriate port suspenses. Transportation documentation is governed by Military Standard Transportation and Movement Procedures (MILSTAMP) standards [61]. MILSTAMP requires documentation of containers in-transit with Transportation Control and Movement Documents (TCMDs) (9) and the submission of Advance TCMDs (ATCMDs) (10) to the receiving ports for advance planning. Transportation information management is covered in detail in Chapter 3.

Figure 2.3 depicts the location of key CONUS facilities in the munitions logistics network. Active supply points under the authority of the IOC include the Tier I and Tier II ammunition depots that appear as rectangles in the interior of the map. Ellipses represent Tier III, inactive, or supplementary sites that provide excess capacity should the need for them arise. These installations and the tiering system are discussed in Section 2.3. There are three munitions terminals that serve as the final steps in the CONUS network, two of which are located on the west coast, and one on the east coast. Operations at these facilities are reviewed in Section 2.4.

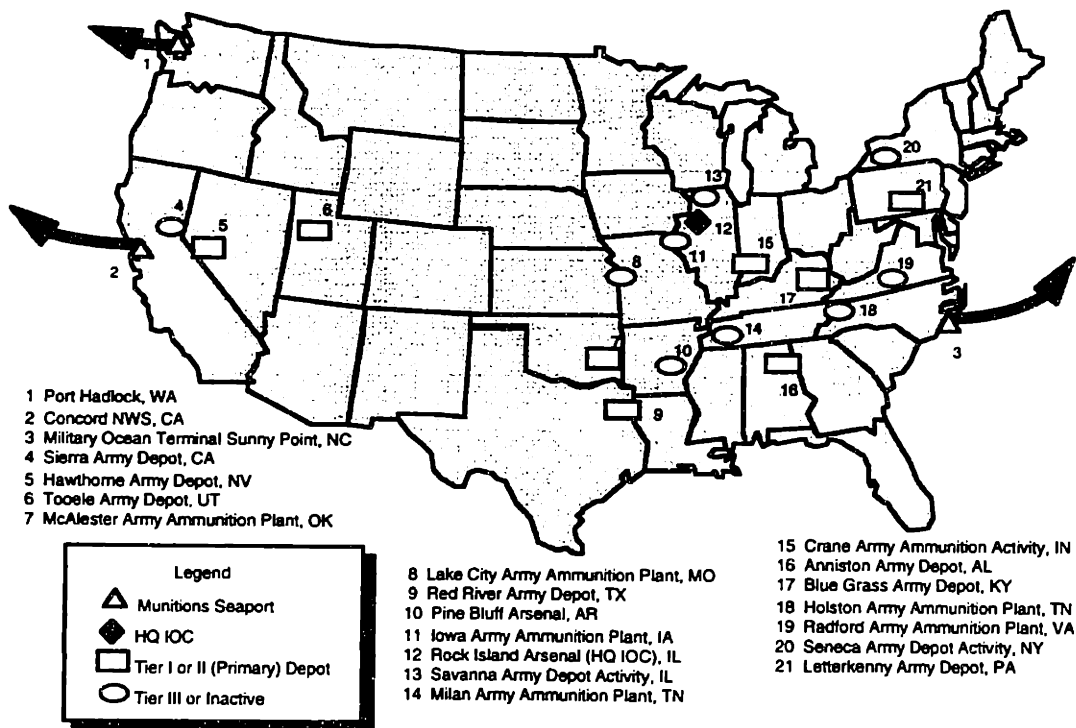

Figure 2.3: Key Nodes in the Munitions Logistics Network

Almost all interfacility munitions transportation is handled by commercial railroads and trucking companies. Due to public sensitivity and the hazardous nature of munitions cargoes, these shipments are closely monitored and highly regulated under DoD contracts. Federal law prohibits the intermodal transfer of ammunition containers off of a specialized munitions installation. Railroad and motor carrier operations are complex subjects in themselves; they are not explored at any length in this thesis except where relevant to receipt and delivery at munitions facilities.

Quantities and mixes of follow-on sustainment munitions, along with transportation schedules, are planned in advance beginning with an iterative process between combatant Commander In Chiefs (CINCs) and USTRANSCOM. This planning is performed every two years using an array of conflict scenarios. Only corrections or emergency requests by the theater CINC's support command are made through DAAS and handled on a real time basis by IOC. The planning process for munitions deployment is discussed in Chapter 4.

Although this distribution network will be committed to shipping large quantities of munitions to an overseas theater during a major regional conflict, the flow of containers during peacetime is much more complicated. Munitions transportation demand is created by direct support of operations, training, facility tiering system balances, demilitarization (i.e., deactivation and disposal of ordnance), base re-alignment and closure (BRAC) moves, maintenance, and retrograde shipments. Again, our attention is restricted to a deployment scenario.

We begin an introduction to munitions logistics operations by providing a high level description of the key facilities in the CONUS transshipment network, starting with the distribution centers for sustainment munitions stock, the IOC depots.

2.3. Depot Operations

The Single Manager for Conventional Ammunition (SMCA) mission was assigned to the US Army in 1977 by the Secretary of Defense, governed by Directive 5160.65. With this direction, the Army assumed oversight of wholesale ammunition assets of all services including forward deployed stocks and stocks aboard Army Prepositioned Afloat vessels. The Industrial Operations Command, as the largest subordinate

element of the Army Material Command and steward of the SMCA mission, has three core competencies [5]: *Power Projection* - providing the Army with a “logistics springboard”; *Industrial Operations* - overhaul, upgrade, and repair of nearly all ground equipment and helicopters for the Army and other armed services; and *Munitions Logistics* - covering the full life cycle of ammunition - from production and procurement, to storage and transportation, to maintenance and disposal (or demilitarization). The combined missions of power projection and munitions logistics and the corresponding network of CONUS installations used to support them are the focus of this section. These facilities exist under various formal names such as ammunition activities, ammunition plants, depot activities, and arsenals. Although often similar, each is unique in mission, inventory, and capabilities. In this thesis we will only be concerned with installations (which we will refer to in general as *depots*) that support the storage, maintenance, and delivery of follow-on sustainment or CONUS *war reserve* (AWR1) ammunition.

2.3.1. Stockpile Assessment

The IOC manages ammunition ranging from 9 millimeter rounds to large Air Force and Navy bombs, totaling approximately 3 million short tons in the CONUS wholesale storage base [24]. Only approximately 44 percent of the total stockpile are active Army munitions, the remaining 42 percent of active stocks belong to the other services (See Figure 2.4).

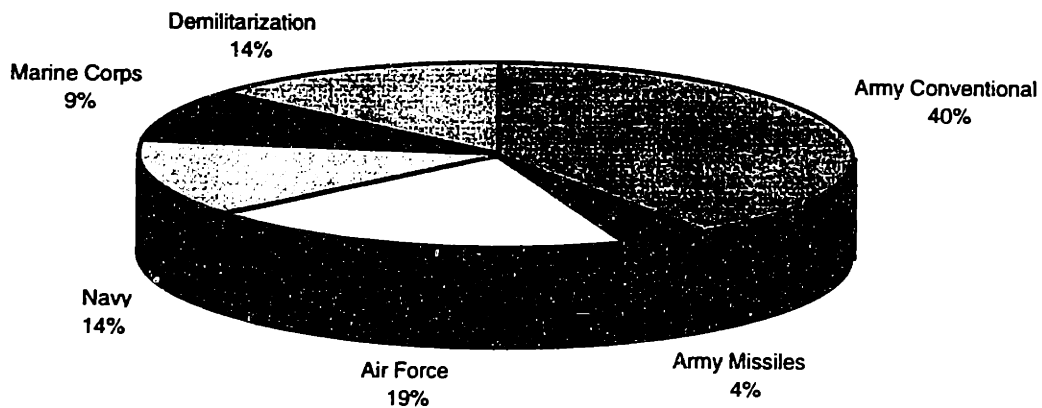

Figure 2.4: CONUS Munitions Stockpile Composition

A classification of stockpiled munitions at IOC installations based on requirements for which the stocks are designated is necessary to understanding inventory mix and missions under the Tier Depot Concept (Section 2.3.2). The following definitions are given in the 1994 Integrated Ammunition Stockpile Management Plan [24]:

- **Required Stocks:** That portion of the stockpile that has an identifiable requirement. This includes all stocks in storage that have a requirement for:
 - **War Reserve:** Termed follow-on sustainment in time of deployment, these stocks are required from CONUS to meet service requirements for major contingencies or conflicts.
 - **< C+30:** These are war reserve stocks needed for immediate (the first 30 days) of a contingency to support operations. Level of activity required is minimal during peacetime, but intensive during the first 30 days of a conflict.
 - **> C+30:** War reserve stocks consumed after the first 30 days of a conflict.
 - **Training:** Peacetime utilization stocks. Level of activity is steady during peacetime.
 - **Production Offset:** A safety inventory, these stocks are over and above established requirement levels but are retained under the provisions of the Office of Secretary of Defense (OSD) stockpile retention policy. An example is contingency retention stocks wherein stocks of older items are held to meet the shortfalls of newer, technologically advanced items. Stocks in this category are normally long lead time production items, that in the event of a consumption of war reserve stocks during wartime,

could readily be transitioned for war reserve replenishment as directed in DoD planning guidance. Level of activity is considered minimal with a static stock storage configuration: it is primarily inventory, surveillance, maintenance, and includes a moderate receipt and issue workload.

- **Non-Required Stocks:** That portion of the stockpile that has no identifiable requirements. Included in this segment are stocks located within the demilitarization account and excess stocks awaiting final disposition. Level of activity includes primarily deactivation operations (i.e., incineration, solvent recovery, washout, or detonation).

2.3.2. The Tier Depot Concept

With the demise of the Cold War, the U.S. no longer had a need for large, costly conventional munitions stockpiles. In October 1993 the Chief of Staff of the Army (CSA) directed the Army to establish a smaller, safer ammunition stockpile with fewer installations using less manpower. The "Tier Depot Concept" was established in response to the CSA objectives [24]. During Operations Desert Shield/Desert Storm, there were 23 supply installations supporting munitions outloading. When the mobility requirements study was released, the number of facilities had been reduced to 16. Additional consolidations and closures have led to a system which will essentially provide for eight fully container capable installations. Thus there is now a outloading capacity problem at the depots as well as the west coast ports [3].

The depot tiering system works under the following classifications: Tier I, or *active core* facilities primarily store conventional ammunition for training and the first thirty days of follow-on sustainment ammunition (< C+30). These depots will also maintain > C+30 stocks to augment lower tier depot outload capabilities. Non-required stocks are minimal. They are fully staffed and work full daily schedules in peacetime. The Tier I depots are Bluegrass Army Depot (BGAD), Crane Army Ammunition Activity (CAAA), McAlester Army Ammunition Plant (MCAD), and Tooele Army Depot (TEAD).

Tier II, or *cadre* depots primarily store war reserve ammunition to be used after the first thirty days of a conflict (> C+30) and production offset stocks. They are

partially staffed in peacetime, but may increase manpower when needed. Daily activity for receipts and issues is minimal while workload is primarily focused on maintenance, surveillance, inventory and demilitarization. The Tier II depots are Anniston Army Depot (ANAD), Letterkenny Army Depot (LEAD), Red River Army Depot (RRAD), and Hawthorne Army Depot (HWAD). Anniston, Letterkenny and Red River also serve as Tier I facilities for missile logistics.

Finally, Tier III, or *caretaker* facilities are those that maintain ammunition in excess of the DoD's needs. Tier III and other inactive or supplemental sites that operated at some level of capacity before the tiering plan began are depicted as ellipses on the map in Figure 2.3. These installations are maintained under the Armament Retooling and Manufacturing Support (ARMS) Initiative [5], a prototype defense reuse program which encourages private firms to use government owned ammunition manufacturing plants for commercial business (e.g., the manufacture of stonewashed jeans). This effort is meant to preserve the defense industrial base at minimum cost to the taxpayer and reduce the impact of downsizing on surrounding communities. Figure 2.5 shows the final planned total stock compositions in thousands of short tons for each tier:

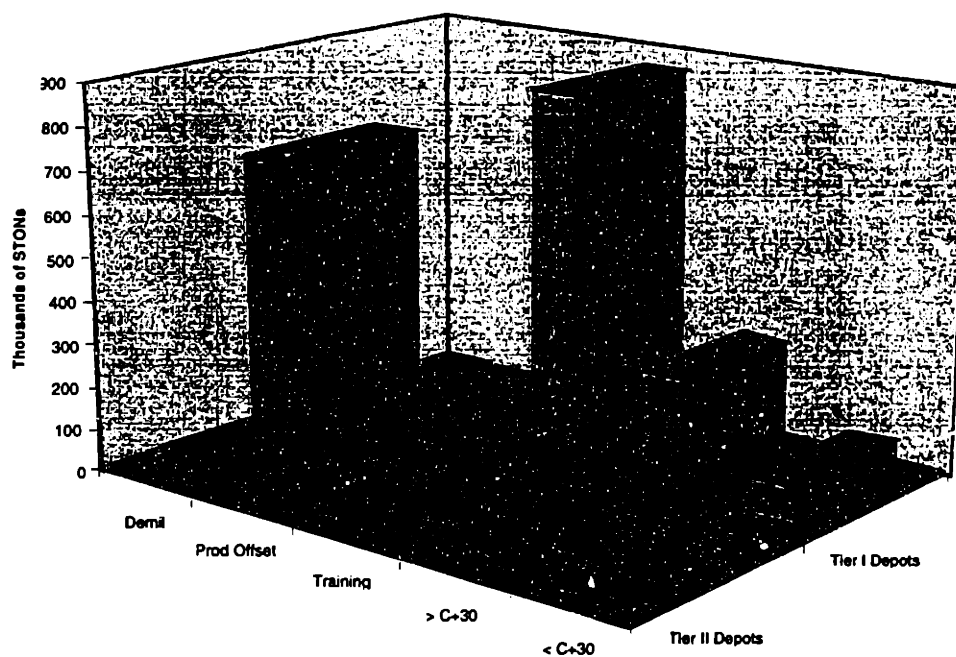

Figure 2.5: Final Planned Munitions Stock Composition by Tier

Given today's projected requirements, approximately 90,000 short tons of war reserve would be stratified across Tier I installations to support the first thirty days of a dual MRC contingency. War reserve assets required beyond the first thirty days for the same scenario equate to 470,000 short tons. Total training stock is estimated at 870,000 short tons. Some of the 780,000 short tons of production offset stocks at Tier II depots may be transitioned into demilitarization accounts. The objective for demilitarization stocks is to reduce the backlog to 100,000 short tons equally distributed among Tier I and II depots [24].

Since the major peacetime use of conventional ammunition is for training at locations throughout CONUS, the tiering plan divides CONUS into east, central, and west regions. Regional distribution fully supports area training requirements and provides an active installation within the proximity of the three munitions POEs for supporting MRC power projection requirements. Each region received a Tier I depot to reduce transportation costs. Due to the density of units in the eastern US, that region has two depots per tier. Full implementation of the tiering plan is expected to be complete in 2001, when the BRAC-95 closures will be complete [24]. Table 2-1 provides summary statistics for all of the IOC Tier I and Tier II depots current as of 31 October 1997. Listed in the table are explosive storage capacities, maximum daily container outload rate under provisions of the Army Strategic Mobility Plan (ASMP); these quantities are estimated to support the MRS BURU worst case output of 1,440 containers each day from CONUS) [43], and storage capacity currently in use. Almost all of the work force at these depots are civilian, while a small cadre of military officers provide administration.

Table 2-1: Tier I/II Installation Summary

• Tier I Installations:

Facility	Location	Region	Exp Cap (K sq ft)	ASMP Outload	Capacity In Use
BGAD	Richmond, KY	East	1,477	300	89 %
CAAA	Crane, IN	East	3,537	310	83 %
MCAD	McAlester, OK	Central	4,298	400	70 %
TEAD	Tooele, UT	West	1,951	310	66 %

- Tier II Installations:

Facility	Location	Region	Exp Cap (K-sq ft)	ASMP Outload	Capacity In Use
ANAD	Anniston, AL	East	1,658	120	85 %
LEAD	Chambersburg, PA	East	1,528	N/A	79 %
RRAD	Texarkana, TX	Central	1,250	N/A	87 %
HWAD	Hawthorne, NV	West	5,691	N/A	74 %

Source: www.ioc.army.mil, Summer 1997

2.3.3. Munitions Outloading

Generally, depots maintain munitions in hardened shelters (also called *igloos* or *magazines*) interspersed over many acres to limit the possibility of mass sympathetic detonation. Ammunition stocks in storage are recorded by grid location within a storage structure. Work crews pull munitions from these magazines using specialized materials handling equipment (e.g., electric powered forklifts) and travel as far as two to five miles to transshipment pads where these munitions are stuffed into containers and loaded on commercial conveyances. Secure pad space is always limited, restricting the ability to store pre-stuffed containers.

Traditionally, equipment has been loaded into containers with wood dunnage for blocking and bracing. Empty spaces were secured with scrap wood nailed together in specified configurations for different ammunition loads. The work was time consuming and labor intensive and resulted in large amounts of wood waste. Two new developments being introduced at the time of this writing promise to make containerized munitions logistics even more efficient [1].

The first of these is the use of strategic configured loads (SCLs). These loads are designed such that containers will be loaded with a bundle of ammunition to support a specific weapons system (e.g., a container has a week's worth of ammunition for an M1-A1 Abrams tank). Since cargoes are more specific they are more immediately identifiable. This innovation will lend efficiency to reception of equipment in the theater of operations.

Next is the use of container roll-in-roll-out platforms (CROPs). CROPs are pre-configured loading frames that stabilize a shipment of ammunition within a container without the use of dunnage. These are fully loaded outside the container and then the

entire assembly is slid into the container with specialized equipment. It will significantly reduce loading times and the amount of wood wasted to fabricate complicated dunnage structures. However, it is anticipated that the amount of space taken at container handling facilities within depots where containers are stuffed and loaded on commercial conveyances will increase to support operations with these systems.

Completed containers are assigned an *NEW class* which specifies handling procedures and compatibility restrictions with other containers. Container *NEW* and weight are the other key attributes that determine shipping costs, safety limits, and other parameters.

2.3.4. Challenges to Depot Operations

Although analysis of depot operations is not central to this thesis, a brief summary of problems that have plagued munitions outloading capabilities at the depots through much of the 1990s (as discussed in the 1994 IASMP [24]) is given here to conclude our discussion. Clearly, a host of immediately identifiable issues will require attention in the years ahead to lend greater capabilities to the depots.

2.3.4.1. Inventory Growth

With the massive base realignment and closure moves of the late 1980s and 1990s and implementation of the tier depot concept, the Tier I and Tier II depots have been forced to absorb massive amounts of new munitions stock. Furthermore, during fiscal years (FY) 1992 and 1993 all the military services began major realignments in their force postures throughout the world. Army troop rollbacks from Europe alone forced the retrograde of more than 500,000 short tons of munitions back into the CONUS storage base.

2.3.4.2. Outdated Infrastructure & Technology

While inventories amassed in the major facilities, limited improvements have been made in infrastructure. As late as 1994, the CONUS distribution base was still biased toward the utilization of breakbulk transshipment methodologies. Army Strategic Mobility Plan funding has since corrected this, moving much of the infrastructure to the CADS system, but there remain major shortfalls in funding for road and track

upgrades, magazine modifications, rapid deployment facilities, and security systems through FY99.

2.3.4.3. Demilitarization Backlogs

Stockpiles of excess, unserviceable, and/or obsolete munitions are continuing to grow due to a myriad of factors such as global changes in the US national defense posture and environmental issues. The demilitarization inventory level in 1994 was over 413,000 short tons and annual generations were at an all time high. This inventory is large enough to fill almost 6,883 rail cars (a train 65 miles long) and is almost large enough to completely consume all the storage capacity of Blue Grass, Letterkenny and Red River Army Depots combined. Clearly, this inventory chokes depot storage capacity, is costly to maintain, is a risk to safety (older munitions tend to become less stable with time), and detracts from active stock operations. Demilitarization efforts are funded to full capacity through FY96 but are funded at less than one-third of capacity from FY97 to FY99; leaving a projected remaining stockpile of 372,000 short tons in FY99. Much more resources must be devoted to demilitarization to deplete this inventory to the 100,000 short ton goal by fiscal year 2001. This will prove a significant challenge as environmental considerations has forced the IOC to transition from a reliance on disposal methods (i.e. open burning and detonation) to a mix of Resource, Recovery, and Recycling (R³) programs that are more environmentally sound but costly to introduce.

2.3.4.4. Suboptimal Stock Distribution

Current munitions stock compositions at CONUS depots are not aligned with operational plans developed for the dual MRC scenario. This requires cross country shipments of some stocks within short time windows for onward movement from the ports. Additionally, assets are not distributed amongst the depots to assure balanced utilization of all infrastructure: shipping directives placed on some depots during a contingency may exceed their organic capabilities while others may be underutilized. It is estimated that 50,000 short tons per year through FY99 will require redistribution to support outloading optimization.

2.3.4.5. Lack of Funding for Essential Support Functions

Of central concern in the Wholesale Ammunition Stockpile Program (WASP) study [24], the impetus to the Integrated Ammunition Stockpile Management Plan, was the lack of funding applied to the essential stockpile readiness functions of inventory accountability, surveillance, maintenance, and rewarehousing at the depots. Annual inventories were accomplished through time consuming and labor intensive methods, requiring multiple visual inspections and repetitious data entries. The introduction of automatic identification technologies (AIT) into depot operations should alleviate this problem (see Section 3.5), but skilled personnel will always be needed for surveillance. Surveillance, accomplished through periodic sampling, inspection, and testing of stock, is required to assure munitions reliability and safety. Results are used to make appropriate stockpile decisions such as identifying items for maintenance or demilitarization, and withdrawing or restricting items considered to be of marginal serviceability. The ammunition surveillance program has been substandard throughout the 1990s. Coupled with large shortfalls in maintenance as well, this implies a severe impact on readiness. Finally, ammunition lots have often been fragmented or intermixed in storage, complicating inventory, surveillance, and outloading.

2.4. Port and Sealift Operations

In their design as facilities for uninterrupted, high volume transfer of cargoes between ship and inland transportation modes and vice versa, seaports are critical bottlenecks in global logistics networks. A port may be defined as “a terminal and an area within which ships are loaded with and/or discharged of cargo and includes the usual places where ships wait for their turn or are ordered or obliged to wait for their turn no matter the distance from that area. Usually it has an interface with other forms of transport and in so doing provides connecting services” [14]. Therefore, a port typically consists of at least one *terminal* and the surrounding water passages used to service it. A terminal is simply a set of piers and other port facilities under the administration of one organization (since the US munitions ports are proprietary, they each consist of only one terminal). Ports are typically classified by the cargoes they handle such as liquid and dry bulk; industrial; proprietary; roll-on/roll-off (RoRo); container; and to a much

lesser extent today, conventional breakbulk. The great majority of all general ocean cargo trade today is containerized: even in the early 1970s the proportion was 85% [8]. Total world-wide containerport traffic is forecasted to reach 607 million measurement tons by the year 2000 [22]. Containerports service specialized, largely non self-sustaining vessels that are unloaded by high productivity industrial equipment.

Containerization was introduced in the 1950s to facilitate efficient intermodal inland transportation and to promote port throughput. Due to the labor intensive nature of port operations, even after containerization had become widespread in the late 1980s, port costs still totaled over 50 percent of all transportation costs in international trade [20]. The first container services were successfully established by the McLean Trucking Company on the east coast and Matson Navigation Company on the west coast between 1955 and 1960 [8]. While the first containers were either 35 foot or 24 foot containers, the internationally adopted length soon became 20 or 40 feet (40 foot containers are far more common). Thus, containership and terminal throughputs and capacities are often quoted in twenty foot equivalent units (TEUs). Special cellularized ships with guides below deck and stacking devices on deck were developed shortly thereafter to facilitate the container trade at sea. This move to containerization has also had huge impacts on rail and highway carrier systems operation ever since.

Likewise, to facilitate rapid global response to contingencies, almost all sustainment munitions are shipped by the United States in containers. Due to weight and safety restrictions, only 20 foot containers are used although only 23 percent of US flagships regularly handle these [11]. Each of the US munitions ports are equipped and designed to transship these containers to some extent. Our discussion in this section provides a review of munitions container port operations to support follow-on sustainment and the vessels they are meant to serve.

2.4.1. The Ports

When sustainment munitions containers are received at the ports by the commercial rail and truck networks, they transition out of the SMCA mission owned by the IOC and into the port transshipment mission owned by the Military Transportation Management Command (MTMC). There are three CONUS ports that support this. Two are located on the west coast: Concord Naval Weapons Station, California and Port Hadlock,

Washington. Although the transshipment mission is under the auspices of MTMC, these ports have been under the command of the Naval Ordnance Center and have primarily served other missions such as ordnance resupply of the Navy's Pacific Fleet. On the east coast, the 1,303rd Major Port Command at the Military Ocean Terminal Sunny Point (MOTSU), North Carolina, reports directly to MTMC.

MOTSU, located just outside Southport, North Carolina with marine access via the Cape Fear River, is the primary facility for ordnance shipments across the Atlantic Ocean. The port has a huge internal NEW storage capacity, attributable to the vast reservation the port occupies. Although the port's current maximum throughput is unclear, in 1993 it was quoted at 789 containers per day [53], more than enough to meet the MRS BURU 720 TEU per day requirement. MOTSU has evolved into a fully container capable port, with 66 storage pads and 90 rail spurs each capable of storing eight rail cars. Rail traffic arrives via a US Army rail line, originating at Leland, a suburb of Wilmington. Munitions containers on railcars are delivered by CSXT Transportation to the Leland interchange each morning from the CSXT Navassa Yard [36]. The rail line includes 97 miles of track and has eight engines, 50 flatcars, and 144 boxcars that are dedicated to transfer traffic. The terminal itself is supported by a considerable amount of materials handling equipment (MHE). There are currently 877 CADS chassis available for moving containers within the port, with an authorization for up to 1,000. These are further supported by four container top pick loaders and 12 yard tractors. Containers are transferred from commercial truck chassis and railcars to port CADS chassis with the use of a 50-ton bridge crane. Likewise, each pier has at least one 50-ton gantry crane used for ship stowage and discharge. MOTSU has three piers, each approximately 2,000 feet long. Each of these is divided into two berths.

The Army does not have a munitions transshipment terminal on the west coast and must share capacity with the Navy at Concord and Hadlock. NWS Concord is located on the southern shore of Suisan Bay, about 35 miles northeast of San Francisco, California. It is the primary ordnance corridor to the Pacific and the designated west coast containerized ammunition transshipment facility; tasked with a MRS BURU throughput of 520 TEUs per day. The station is divided into an inland area and a tidal area [53]. The inland area consumes 5,272 acres and contains major administrative and industrial activities, and ammunition maintenance and storage facilities. The

larger tidal area (7,630 acres) consists of about five miles of waterfront with three 1,200 foot piers, each divided into two berths. The tidal area also has the land, roads, rail tracks, and other facilities needed to support munitions transshipment. The port has three main rail lines that are serviced separately by the Southern Pacific, Union Pacific, and Santa Fe railroads. Concord has 10 locomotives, well over 474 railcars, and over 400 CADS chassis.

One of Concord's disadvantages is its limited water access. The channel from the ocean is 39 miles long through San Francisco Bay, San Pablo Straight and Bay, Carquinez Straight, and finally Suisan Bay. Water draft is limited to 35 feet along the approach and there are a series of narrows and limited bridge clearances. In 1993, approximately only half of the commercial containerhips in the US Flag Fleet could traverse this path [53]. Pier explosive arc limits allow for 11.2 million pounds NEW.

Although MOTSU's capabilities have always been superior to Concord's, new developments promise to give the port a larger role. As a naval weapons station, one of Concord's primary missions was Receipt, Storage, Segregation, and Issue (RSS&I) of munitions for the US Navy's Pacific Fleet. There are 264 storage magazines providing a total of 825,000 square feet, 464 Navy railcars, two tugboats, 30 barges, and a 100 ton floating crane on post for this purpose [2]. This mission has been performed in breakbulk (i.e., palletized instead of containerized shipments) so unlike MOTSU, a large portion of Concord's capacity has not been designed for container throughput. However, the RSS&I mission has since been eliminated at Concord and although it is uncertain, the port's role as a general containerized munitions terminal under MTMC purview is likely to expand. Navy breakbulk munitions storage capacity has been offered for evaluation for munitions pre-staging activities to the IOC. These developments make it difficult to estimate how much internal storage capacity Concord can afford to sustainment munitions.

Additions in manning and infrastructure on the horizon should also improve throughput. Evolvments in the Base Realignment and Closure List have led to two new units taking up tenancy at the port. The 1,302nd Major Port Command (originally at the Port of Oakland) will offer an expanded work force and Headquarters Military Sealift Command will provide more centralized sealift control for the follow-on sustainment mission. Infrastructure improvements include the construction of a

second gantry crane at Pier 2, which has the highest explosive arc capacity, and the installment of eight storage pads within the new intermodal transfer area. These capabilities should be fully implemented in 1999 [2]. More construction funding is pending and the situation at Concord promises to be a dynamic one in the years ahead.

Finally, Seal Beach Detachment, Port Hadlock, is located on Indian Island at the mouth of Puget Sound on the northeast corner of the Olympic Peninsula in Washington State. The island is approximately 5 miles long and 1.25 miles wide and comprises 2,716 acres [53]. Much smaller than MOTSU and Concord, Hadlock supplements Concord's munitions transshipment capability on the west coast by being tasked with a daily throughput of 200 TEUs in the dual MRC scenario. This port has a single 1,660 foot pier with one container gantry crane, rated at 2.25 million pounds NEW. Although the port has unrestricted access to the ocean and a 55 foot draft, the island has no railroad service and highway access consists of only a single two lane, black top, winding country road. Port Hadlock has supported the Navy RSS&I mission with 102 storage magazines and also provides some capability to produce and manufacture bombs.

Although each port has different capabilities and follows slightly different operating procedures, there are many similarities in their general infrastructure and in how containers are processed for CONUS export.

2.4.2. Port Architecture

There are key characteristics of these munitions ports that distinguish them from any other commercial container port. All of these traits result from safety and security standards which must be met in transshipping these hazardous cargoes. *Safety in handling* is required to minimize the probability of mass sympathetic detonation – an explosive chain reaction caused by a mishap with a single container. Such an incident destroyed one of Concord's piers and killed many personnel during a World War II outload (the piers are numbered 2 through 4). Safety is promoted through meticulous container inspections and transfers, bermed storage pads and rail spurs (lots surrounded by large mounds of earth and reinforced with vertical concrete slabs) that are protected against lightning, and dispersion of net explosive weight over a large area. Minimum distances between concentrations of NEW are established by explosive "arc"

limits. The volatile nature of these cargoes also demands the use of specialized materials handling equipment such as electric powered forklifts. *Security* of these ports is critical due to their status as critical logistics installations that are high-value targeted during peace and war. The ability to sustain a military operation would be severely impacted if these ports were subjected to sabotage, terrorism, mining, or espionage. In addition to the safety considerations described above, security is provided by extensive guard operations at the installation gates and along the perimeter. Pads that maintain extra-hazardous munitions (high NEW class) are surrounded with razor wire topped fencing and extra lighting. The US Coast Guard regularly patrols vicinity marine access. Safety and security requirements also force these installations to locate away from urban populations and therefore along undeveloped shorelines.

The most dramatic impact of the requirement for safety and security on munitions port design is the use of dispersion [62]. These facilities are many times larger than any commercial container terminal, where land utilization is often an important objective, especially in congested urban ports. For example, in Hong Kong, containers are regularly stacked in blocks six high and fifteen deep [8], but munitions containers in pad storage are usually left on CADS chassis and are never stacked on the ground more than two high in two rows. This eliminates the ability to use most forms of high productivity container MHE that are common in congested commercial ports such as straddle carriers and yard gantry cranes. Where most commercial terminal yards consist of a large parking-lot like concrete surface that is continuous up to the pier face, all the munitions ports have expanses of undeveloped land in between roads, rail spurs, pads, magazines, and buildings. Additionally, each pier at a munitions terminal consists of a large concrete loop that extends from the shore out into the servicing water way. This isolates the high accumulation of NEW during ship stowage from the rest of the facility and also reduces the need for dredging the channel because ships are able to berth at a deeper draft farther away from the shore.

2.4.3. General Deployment Procedures and MHE

In our emphasis on munitions *deployment* through the ports, this section discusses the general processes and equipment used to receive, store, and transship munitions

containers to meet vessel bookings. Although specific procedures will be dictated by infrastructure and policy at each port, there are some basic principles by which they all operate. Since policies governing the handling of retrograde loaded or empty CADS containers back into CONUS are not known in detail (e.g., there is no NEW in an empty container so they may be shipped back through general purpose container ports to avoid congestion at munitions ports), we neglect a discussion of retrograde procedures except where relevant. It can be assumed that retrograde procedures are basically just the reverse of deployment. Clearly, any retrograde operations that are run concurrently with deployment will effect deployment throughput at ports.

The first step involves the receipt of containers from inbound rail and truck carriers. Usually, containers are scheduled to arrive on station three to five working days before they are required for ship stowage [36]. Barge cargo, or breakbulk cargo to be containerized at the port, is often scheduled to arrive ten days prior to ship arrival to permit timely reconfiguration, stuffing, transfer, staging, inspection, and documentation of containers and barges prior to loading.

Trucks arrive at a port gate where they wait to exchange documentation by hardcopy or automatic identification technology (AIT) with guard or clerk personnel. The number of traffic lanes will depend upon the volume normally handled through the gate on a peak basis. The lanes may be equipped with scales to weigh shipment contents, or scales might be located in a receiving area adjacent to the gate. The truck, chassis and container are given a thorough inspection either at the gate or at an inspection pad located just inside the gate for damage to the container and hazardous conditions (e.g., sparking components or a tampered door seal). Suspect deliveries are isolated and handled by explosive ordnance personnel. The truck driver is given a gate pass and directed to the port location where the container is required. For full container load deliveries, this is usually to a transfer or storage pad but in some cases a late truck may be required at the pier for direct transfer to ship. If the container is not yet required for ship loading, it is assigned a yard storage address on a holding pad that will not violate NEW limits. If the port accepts less than container load deliveries, the truck is directed to a container freight station (CFS) where the cargo will be removed or added to, completing the load in a full container.

Railcars are usually assembled into a train for delivery into the port by each servicing railroad at a local classification/interchange yard. The cars are either hooked up to a military engine at the interchange yard and pulled into the port or are delivered directly into the port by commercial engines. All applicable train documents, such as the railway switch list and hardcopy TCMDs are delivered at the point of engine change. As in truck receptions, the train's railcars are inspected for damage and hazardous conditions. This may be done in conjunction with the next phase when the train is decoupled, or classified, into separate blocks that are taken to either transfer pads or temporary rail holding spurs. Although track loops are usually installed on each pier, railcars are rarely, if ever, pulled out directly to the ship cranes because containers on the railcars would have to be in the correct stow sequence. It is very time consuming to move a string of railcars back and forth under the crane's spreader bar, whereas it is relatively easy to correctly position a truck chassis correctly. This is in spite of the fact that on-dock rail is being introduced at commercial containerports to improve throughput successfully [12]. Where appropriate, flatbed railcars with containers that require consolidation are directed to the CFS.

At transfer pads, containers are moved from flatbed railcars to port CADS chassis ("rail-to-rubber" transfer) or from commercial truck chassis to port CADS chassis ("rubber-to-rubber" transfer). All container transfers in the port from one mode to another are handled by special purpose forklifts with side pick attachments, front end-loaders with top-pick attachments, or large gantry cranes. A typical rail-truck transfer pad layout in cross-section and approximate scale is depicted in Figure 2.6. This pad, designed by Moffat & Nichol Engineers, employs a front end loader with top pick attachment to move containers off of cars on either rail spur and place them on CADS chassis. Such a pad would be approximately 36 meters wide and can be of any length. Note the berming that is at least as high as any container on the pad and the lighting posts installed to provide safety and security. Net explosive weight capacity depends on a number of variables that include exact dimensions used in construction.

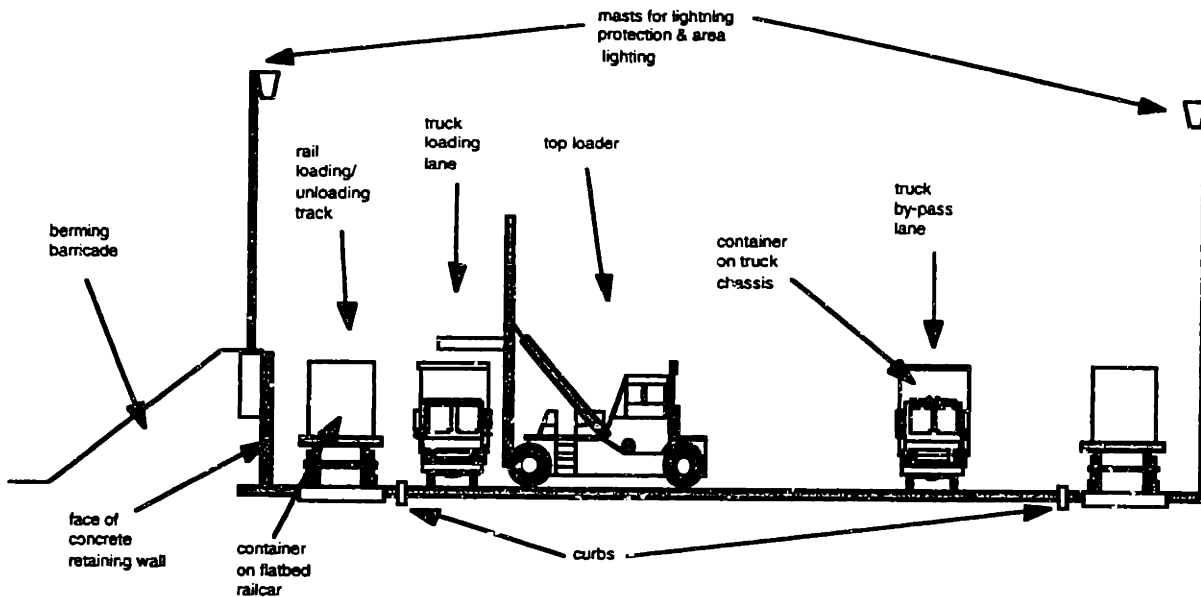

Figure 2.6 Port Rail-to-Truck Container Transfer Pad Layout (Moffat & Nichol Engineers)

Containers that are not imminently due for ship stowage are placed on storage (or holding) pads that can take a number of forms. Some containers may be left on a block of railroad flatcars on a rail holding spur. However, the ports usually make every attempt to discharge containers from railcars as soon as possible to avoid paying demurrage and detention fees to railroad carriers to whom the flatcars belong. Instead, most early containers are taken to storage pads where containers are either grounded in rows no more than two high or are left on CADS chassis. Stacking the containers provides more effective space utilization but also increases the amount of time required to retrieve a container for ship loading. Leaving containers on chassis consumes more space and ties up yard resources but provides for rapid container selection for ship loading. A typical storage pad layout, in the same Moffat & Nichol design, with grounded containers in cross-section and approximate scale is depicted in Figure 2.7. Such a pad is less wide, usually about 25 meters, while the length is again quite variable. For a pad like this, containers will arrive on either commercial or CADS chassis and will be discharged and stacked by a top-pick loader. When containers are needed for ship stowage, they are picked and stacked on a port CADS chassis by the top-pick loader and driven to the pier crane by a yard tractor. Note that the berming is as high as the container stack. Although this is representative of a typical storage pad, design will vary depending on the NEW classes it is configured for.

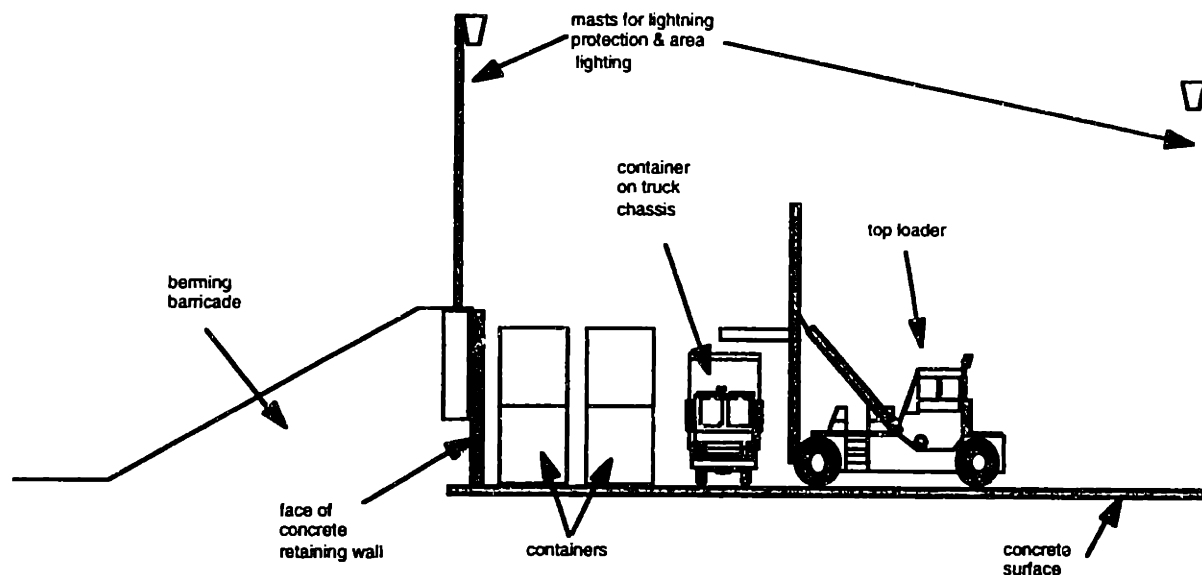

Figure 2.7 Port Container Storage/Holding Pad Layout (Moffat & Nichol Engineers)

The assignment of storage addresses on holding pads to deployment (and retrograde) containers as they are received is based on a layout pattern established and maintained by a yard control office. Usually, separate pads are used for deployment, retrograde loaded, and empty containers if they are handled. Since empty containers have no explosive weight and do not require selection by load, they can be stacked on unsecured lots up to three high in solid blocks of varying depths. Deployment containers may be further segregated by vessel booked, POD, and possibly by weight category to facilitate sequential access for ship stowage. However, organization of deployment containers by these divisions may lead to congestion as pads with similar container classifications will be accessed more heavily during ship loading. If the yard control office has an efficient storage control system that is well coordinated with stevedore teams, containers may be stored on a more random basis across pads, especially for those containers that are stored on CADS chassis. Operations are typically controlled by portable UHF radio units.

When containers in storage are required at a pier for ship stowage, the stevedore team working the ship sends a yard tractor, with chassis if necessary, to retrieve the container from the applicable pad. Before discussing container stowage operations, it is first helpful to review the types of marine vessels that are serviced by these ports.

2.4.4. Munitions Sealift: Vessel Operations in Port

The purpose of this section is to describe the ocean cargo vessels, usually under the command of the Military Sealift Command (MSC) that commonly provide munitions sealift and the vessel stowage operations that are used to service them at the ports. These vessels mainly consist of highly specialized containerships, and to a lesser extent some barge and roll-on/roll-off (RoRo) vessels.

2.4.4.1. Containerships

During the early days of container transportation, conventional cargo ships were installed with deck fittings for the stowage of containers on deck. The relatively small hatch openings that existed on break bulk ships limited the size of containers that could be lowered within and movement of containers into the wing spaces between decks was impractical [8]. Other ships were drastically converted by removing all of the break bulk gear, enlarging the deck openings, and installing larger, watertight steel hatches. Vertical cell guides were installed in the enlarged hatch openings to provide cellular stowage below deck such that containers could be lowered within a confined boundary. Many ships allow 20 ft containers to be stowed in tandem in a 40 ft cell [8]. The early adaptations permitted stowage of containers four or five deep below deck. The first modern containerships could stow them up to seven deep in their holds. These ships had their decks and hatch covers strengthened and special deck stacking fittings installed to permit the stacking of containers two or three high on deck. Since terminals did not yet have suitable shore based gantry cranes, shipboard cranes that moved up and down the deck on rails to each hatch opening were installed [8]. This allowed the first ships to be self-sustaining.

By the early 1970's containerized cargo shipments became predominant, with 85% of worldwide cargo being transported in containers and the remaining 15% remained break-bulk due to excess weight, size, or other similar restrictions [8]. Gradually, as cranes were introduced to every modern pier, the shipboard cranes were no longer required and their elimination further increased capacity. The most modern containerships do not even have hatch covers; the cell guides extend from below deck several layers above to provide above deck capacity that does not require time

consuming and often hazardous cable lashing efforts. Today's modern containerships have capacities on the order of 5,000 TEUs [12].

2.4.4.2. Barge Carrying Ships

Barge ships may also be used to carry munitions overseas. These ships utilize large covered barges to carry cargoes which are stowed in the vessel hold in much the same manner as containers (although they are much larger than CADS containers). However, cargo loading and discharge in and out of the barges is a breakbulk operation. These barges might be loaded at a specialized freight station near the pier by forklifts and other MHE and then pushed out to the barge ship at an off-shore anchorage by a tugboat. Although the barges require port stowage work, they have an advantage in that the ships are self-sustaining and do not require berthing since barges are loaded into and discharged from the ship in the water. This can be especially important in contingencies where the theater has an extensive network of undeveloped rivers and canals. Provided the capacity exists to load barges at the port, it is possible that the port could increase throughput by servicing these ships when pier berths are heavily utilized by containerships. Many barge vessels also have some container capacity. There are two primary types: Lighter Aboard Ship (LASH) and the SEABEE class.

2.4.4.2.1. Lighter Aboard Ship (LASH) Class

LASH barges are approximately 61 feet long, 31 feet wide, and 14 feet high [8]. They have an unloaded weight of about 82 long tons and can carry approximately 364 long tons of cargo [8]. The vessel utilizes a large crane on steel rails that traverses the working length of the main deck. At the stern of the vessel, extensions of the main deck on each side permit the crane to center itself over the water. A LASH barge is towed or pushed into position below the crane and lifted from the water. The crane then travels forward and stows the barge on or under deck, at one of the hatches.

2.4.4.2.2. SEABEE Class

SEABEE barges are even larger yet: about 97 ft long, 35 ft wide, and 16 ft high, with a cargo weight capacity of 834 long tons [8]. The SEABEE ships are similar in principle but operate with a more complicated lifting scheme. At the stern there is a large synchro-lift elevator which lowers into the water. Two barges at a time are brought into position over the elevator, one on the starboard side and one at port. The elevator is

then raised to one of the three stowage levels. Each level is equipped with a set of rails on each side of the vessel. Hydraulic jacks raise the barges from the elevator so that a transporter, which rides on the rails, can be moved under each barge. The hydraulic jacks then lower the barge onto the transporter. The transporter is powered by an electric motor which moves it and the barge along the rails to the desired stowage position. The jacks then lower the barge to a position of rest and the transporter moves aft to handle another barge. The transporters move from level to level on the elevator so only one set is required. The entire system is automatic, with limit switches providing automatic positioning and movement of the barges within the vessel [8].

2.4.4.3. RoRo Ships

The roll-on/roll-off vessel is designed to provide rapid access for wheeled vehicles, via ramps, to the interior and various decks of the vessel. There are many varieties of configurations, but most are designed for specific trades in certain classes of cargo and rolling stock. All decks have sufficient headroom to permit stowage of full-height truck-trailer units, but in different areas RoRo ships can also accommodate oversized trailers and pieces of equipment such as truck cranes, road making and construction equipment, combat tracked vehicles, or even mobile buildings. Some combination RoRo vessels also have container cells.

The ships usually maintain their own cargo handling equipment specially designed to maneuver the restricted working spaces. Ramps are often on the stern side of the ship and lower onto the pier from the starboard quarter, requiring the ship to always berth starboard side. Interior ramps and elevators provide access to each level in the ship. Longer ramps with flexible links allow ships to be piered at terminals with large tidal ranges [8].

In commercial trade, RoRo ships are often used to transport semi-trailers for three reasons: the trailers have much higher cubic capacities than containers, they can be immediately rolled out of a terminal after ship discharge, and they can be absorbed in the local highway network without necessarily requiring back-haul of an empty van to the terminal for return to the steamship line.

RoRo ships are key MSC mobility assets, most notable of which are the eight premier US flag commercial containerships which were converted into huge Fast Sealift Ships. These ships are almost as large as an aircraft carrier, are capable of speeds in

excess of 30 knots, and carried 12 percent of the tonnage to the Persian Gulf during the Gulf War. They are designed for the unit equipment movement requirements of heavy armored divisions. Although much more important to unit logistics, RoRo ships are important assets to consider which may be used to deliver containers along with theater container MHE (e.g., rough terrain container cranes and the like).

2.4.4.4. Principles of Vessel Stowage

As discussed previously, there are high costs associated with port dwell time for ships. Loading or discharging containers from a ship is the principal mission of the container port and is also the most labor intensive and time consuming operation. Large overhead gantry cranes are used to lift containers from conveyances on the pier, move them to the correct stowage cell, and lower them into place. Modern cranes can load or unload 20 to 30 containers per hour [8], but typical single munitions shiploads (i.e., at Concord) have ranged from 500 to 1,500 TEUs [58]. Furthermore, in stowing containers on board the ship, the port must be careful to meet a number of critical constraints. Since container loading commences almost immediately upon ship berthing, unless there has been previous data transfer, the ship's chief mate has little time in which to inspect the container loading plan. It is therefore essential that proper sequencing of deployment (and retrograde) containers to (and from) the vessel be planned as fully as possible before vessel arrival.

Our discussion in this section is confined to container stowage into containerships, although many of the principles can be applied to RoRo or barge vessels. On containerships, the ship administration controls the allocation of space in the vessel and directs which cells are to be designated for specific port calls. However, the actual planning of the stowage of each container and the rotation in which containers are to be loaded is, in most cases, the responsibility of the port.

2.4.4.4.1. Stowage Location Terminology

Containers are stowed in the vessel hull within cellular holds that are delineated by vertical guide rails. This organized stowage system lends itself to numerical addressing of containers within their three-dimensional arrangement. The following terms are commonly used to specify each axis [8]:

- **Cells:** Vertical holds in the ship where containers are stacked, one on top of another. There are multiple cells across the width of the ship.
- **Bay or row:** A group of these cells across the width of the ship. There are multiple bays across the length of the ship.
- **Level:** A stowage location at a certain depth from the deck.

Thus a stowage location address consists of three designators, one for each of the above three dimensions. A common system has bay numbers which run from forward to aft, with odd numbers used for 20 foot bays and even numbers for 40 foot bays (e.g., If the first two bays were for 40 ft containers, they would be numbered 2 and 4; if the next two bays were for 20 ft containers, they would be numbered 5 and 7, etc.). Level numbers are normally numbered from the bottom up in even numeric order with two digits (e.g., 02, 04, 06, 08 on up for containers stacked below deck). Containers stacked above deck level begin with a higher number, usually 8 (e.g., 82, 84, 86, 88). This is used to clearly distinguish between stowage under and above deck. Half height container levels are addressed with odd numbers in between. In this case, 01 would be used for a half-height container stowed on the bottom. Finally, there is the numbering of cells across the ship. There is more variation here among different shipping organizations. Some simply address them numerically from port to starboard or starboard to port. The most common tradition is to use odd numbers on the starboard side and even numbers on the port side, beginning from the centerline and progressing outward. Under this system, if there's an odd number of cells, the centerline cell is numbered 00. A example ship bay plan with this addressing system is demonstrated in Figure 2.8 below:

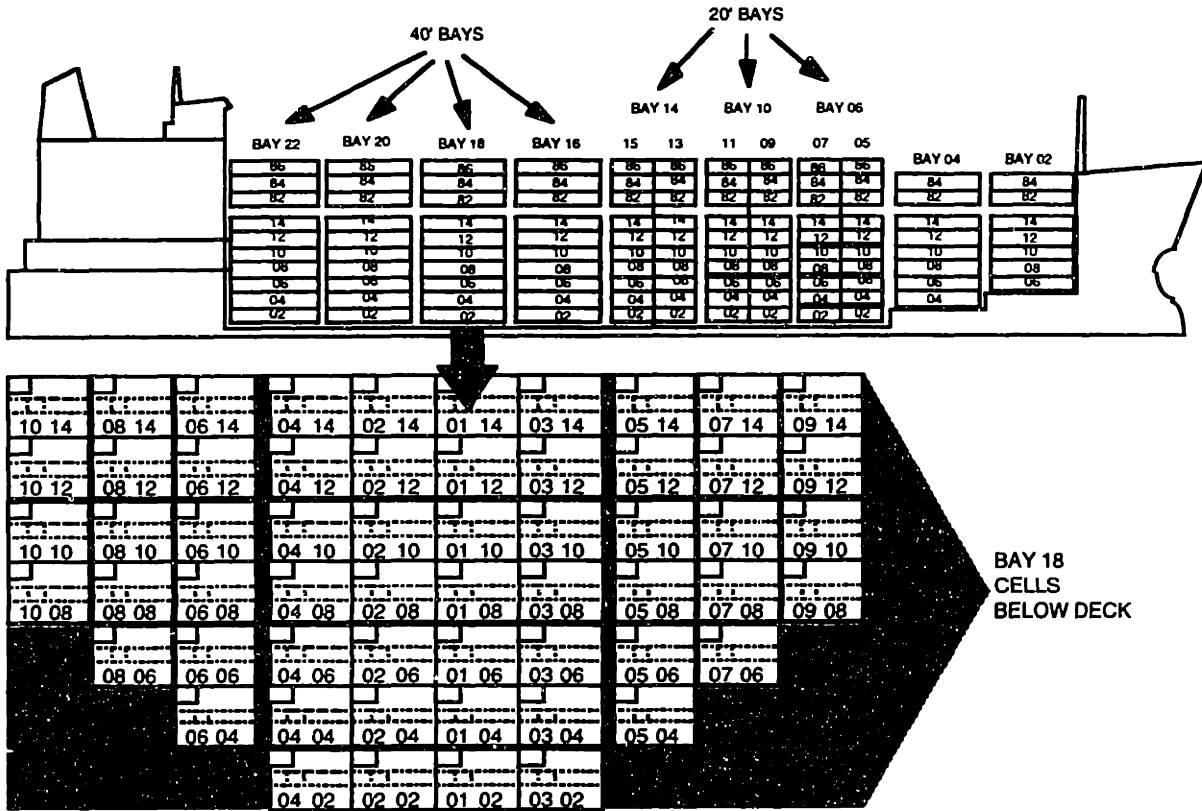

Figure 2.8 Container Stowage Addressing System

2.4.4.4.2. Stow Planning and Execution

There are several important inputs to the development of a vessel stowage plan. These are described functionally below; the actual names or format of the data available may vary among port and ship organizations [8]:

- **Inbound cargo plan:** Indicates containers to be discharged and those to be retained for port calls beyond, thus giving loading spaces available.
- **Inbound container manifest:** Supplies detailed information on consignees and ultimate destination of retrograde containers. Allows for some segregation at time of discharge to assist deliveries and reduce shifting of containers in the yard during the delivery process.
- **Ship condition report:** Gives amount of fuel, water and stores on board. Required for making stability, trim, and strength calculations.

- **Booking list:** Complete list of containers booked for loading at a particular port, used to check against actual number of containers that have been received in the terminal. If additional containers are due following the initial sequencing, spaces will have to be reserved.
- **Yard plan:** Addresses for deployment containers on storage pads throughout the port booked for the voyage under consideration.
- **General vessel and voyage information:** Other pertinent data such as port rotation and time schedule; fuel, oil, and water to be taken on board; and additional restrictions such as stacking weight limitations in any cell.

Given these input data sets, the stow planner is tasked with finding a stowage sequence plan that strikes an optimal balance among a few key objectives: minimizing container handling during the current loading operation and subsequent POD discharges (by not overstowing containers needed at the next POD with containers not needed), maximizing space utilization, and achieving the best weight balance to maximize ship seaworthiness.

Of course, there are a number of constraints that further complicate the problem. The first set of constraints impacting the sequence are related to vessel stability, trim, and stress. As containers are loaded, the heaviest containers must be placed at the bottom, and a sufficiently even distribution of weight fore and aft, port and starboard, must be maintained. Otherwise, the vessel may sail at a list, placing undue strain on the vessel structure. An extreme longitudinal imbalance could cause a rupture in the hull. The second set of constraints relates to strength of the individual containers in each cell. International Standards Organization (ISO) specifications require that containers be capable of being stacked six-high when each is loaded to rated capacity [8]. The normal capacity of a 20 ft container is 20 long tons; thus the stack height weight allowance cannot exceed 120 long tons. If containers were stacked more than six-high the total 120 long ton restriction would still apply. Additionally, ships with on deck hatch covers often have a specified gross weight allowance (usually

two- or three-high under full load conditions). Other restrictions may be necessary depending on specific operational considerations such as container priorities and compatibilities, and empty container cycling.

Clearly, the objectives can also be very interdependent. For example, a heavy container calls for deep stowage for trim and stability, but if it is needed immediately at the POD, it will likely be overstowed.

The stowage planning problem is very complex. In the past, the problem was tackled by one or more port experts manually using their best judgment. Container stickers or “chits” were placed on a yard layout overlay on large plastic sheets or clear Plexiglas panels to represent their storage locations as they were received. The chits were then transferred to numbered lines below each bay plan for a voyage [8]. Today, virtually all stowage planning is either completely automated or computer assisted for the port planner.

Using the completed bay plans, the port planner then develops a loading sequence for the ship. Depending on vessel trim and stability requirements as the load progresses, containers are either sequenced from the bottom up in each cell in rotation, or can be loaded level by level across the ship by the crane(s) working the ship. When the load sequence is completed, flow sheets or crane/bay sequences are generated for stevedore crews to show the rotation in which each of the bays is to be worked and the number of container moves to be made. Usually three to six yard tractors are assigned to feed a crane, cycling from yard storage pads to retrieve containers to delivering them at the pier.

2.5. Chapter Summary

The aim of this chapter was to provide a high level introduction to the key organizations and installations that are responsible for providing sustainment munitions transshipment from CONUS to a contingency theater. We described operational processes in general and provided important terminology and classifications that are integral to this topic. The interconnectedness and complexity of the underlying processes suggests both the massive amount of coordination required to successfully execute the mission and the difficulty involved in finding system wide

optimal solutions. Clearly, the challenge of finding even acceptable containership stow plans is a daunting one for manual operations and this is but one facet of the port problem alone.

The remainder of this thesis develops an integrated decision support framework for effective planning, command and control of the *entire* munitions transshipment pipeline. The first requirement is the establishment of real time visibility over the state of the network.

3. DoD Logistics Information Management and Total Asset Visibility (TAV)

Every post-conflict study of contingencies from Vietnam to Haiti has found the need for better visibility over DoD equipment and personnel in the logistics pipeline. Many attempts have been made to provide that visibility, but the DoD has been largely unsuccessful in developing effective systems for capturing and integrating accurate, timely, and comprehensive logistics information. Past development efforts have been fragmented, leading to a proliferation of legacy data systems that require multiple points of manual data entry and provide redundant capabilities. In building a modern logistics planning and control architecture, the DoD is focused on integrating new key technologies and developing a migration strategy to phase out old systems.

In our review of current operations in the previous chapter, we focused on the infrastructure and physical processes that are employed to deliver sustainment munitions from “fort through port” to the theater. Our discussion is incomplete without providing some insight into the complex network of information management systems that facilitate coordination and control of this pipeline. This examination is important for two reasons. First, it delineates the data flows that are currently used to authorize and coordinate munitions transportation between the array of organizations involved. Second, it provides a review of the technologies in existence or development

that will serve as the foundation for any integrated defense logistics command and control architecture.

3.1. Introduction and TAV Concept Overview

There are a host of automated information systems (AISs) that exist to provide “real time” decision support to the DoD logistics community. Total Asset Visibility (TAV) is a planned capability that a family of these logistics systems will provide. The definition of TAV, as given by the 1995 DTAV Implementation Plan [19], is “the capability to provide users with timely and accurate information on the location, movement, status, and identity of units, personnel, equipment, and supplies. It also includes the capability to *act* upon that information to improve overall performance of DoD’s logistics practices.” TAV might also be thought of as the world wide command, control, communications, computer and information (C⁴I) architecture for all logistics in the DoD. Total Asset Visibility is meant to satisfy the requirements of all customers from operational managers (e.g., CINCs, JTF commanders, lift and port operators, and requisitioning units) to logistics support managers (e.g., Military Service and Defense Logistics Agency headquarters, USTRANSCOM, and integrated material managers).

The Total Asset Visibility architecture is summarized in Figure 3.1 below. The baseline integration consists of four national-level systems that capture location and situation specific data – the Logistics Information Processing System (LIPS); the Inventory Control Point Automated Information System (ICP AIS); the Global Transportation Network (GTN); and in time of a contingency, the theater logistics management AIS that has been generically termed JTAV (Joint Total Asset Visibility System). This architecture is conceptual and high level: each core system is not necessarily representative of a single existing technology but instead represents an aggregate capability that the DoD is moving towards. In 1995 when the DTAV Implementation Plan was written there was no single ICP AIS but instead a set of legacy databases used to manage specialized commodity classes; GTN is not stand-alone but instead requires interface to a network of installation booking and transportation systems; and although some theater logistics management systems existed, none provided an acceptable JTAV capability.

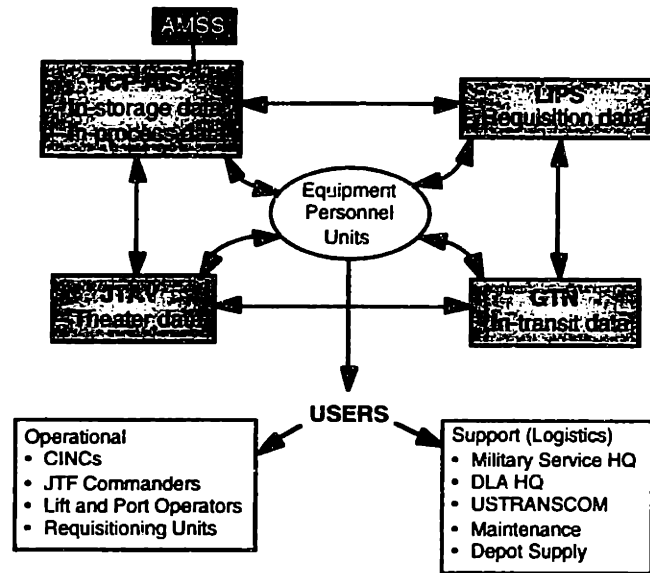

Figure 3.1: TAV Operating Concept

The central router of data in the TAV architecture will be the Defense Automatic Addressing System (DAAS) [61]. All of the four TAV systems will be supported by one or more physical data bases. LIPS, ICP AIS, and GTN will each contain DoD wide asset information, while JTA V will contain information only on assets within, inbound to or outbound from the theater of operations. Each system will provide the user a point of entry to the information in its underlying data bases. Although some TAV users could satisfy their visibility requirements by accessing only one of the four systems, others may require visibility of assets that are tracked in more than one system. As such, in the future the DoD will ultimately integrate the four components into a single system. In the near term, the challenge will focus on providing real time data connectivity among the four components world wide.

A classification of logistics assets by status as provided in the 1995 DTAV Implementation Plan [19] is necessary to understand this TAV architecture:

- **Material Business Area**
 - **In-Storage Assets:** Assets that are being stored at inventory organic and commercial sites, and at disposal activities. For munitions, these

are all depot war reserve, production offset, training, and demilitarization stocks.

- **In-Process Assets:** Assets on order from DoD vendors, but not yet shipped, or in repair at intermediate and depot level organic or commercial maintenance facilities. For munitions, this class includes all depot stocks in production or maintenance, and any ordnance still within vendor control.
- **Transportation Business Area**
 - **In-Transit Assets:** Assets that are being shipped from origin (i.e., vendors, storage activities, or maintenance facilities) to destination (i.e., consignee units). For munitions within our scope of analysis, this is follow-on sustainment that has transitioned out of war reserve stock.

As per Figure 3.1, the Inventory Control Point Automated Information System(s) covers all in-process and in-storage assets. The Global Transportation Network is the source for in-transit information. The Logistics Information Processing System is the technology for requisitions tracking and thus serves as the link between the material business area and the transportation business area.

In the next sections, we provide a functional high-level description of the processes and systems used to support each of the four pillars of Total Asset Visibility as they pertain to sustainment munitions, with an emphasis on the in-transit portion. This discussion is not intended to provide the technical architecture, user interface requirements, or detailed data requirements for the integrated systems. Furthermore, we do not provide any details regarding assets in-process or the development of the theater JTAV except within the context of in-transit visibility (ITV).

3.2. Munitions Requisition Tracking

Although asset requisitions are not physical material, they are the key requests and authorizations with associated data that must be processed to fill a logistics order.

Requisitions transform assets in-storage or in-process to assets in-transit. There are a number of actions entailed in filling these orders - the customer prepares the order and transmits it to the source of supply; the source of supply determines if the asset is available, releases the asset, and prepares it for shipment to the customer; then the shipping activity arranges for moving the asset to the customer. This procedural flow is illustrated in Figure 3.2. The first four steps are associated with the requisition. The asset is still in the material business area, but a customer has placed a requisition for it and the source of supply is processing the requisition and preparing the asset for shipment. Requisition procedures and data are governed by Military Standard Requisition and Issue Procedures (MILSTRIP), while procedures and data for assets that are in-transit are governed by Military Standard Transportation and Movement Procedures (MILSTAMP - DoD 4500.32R) [19].

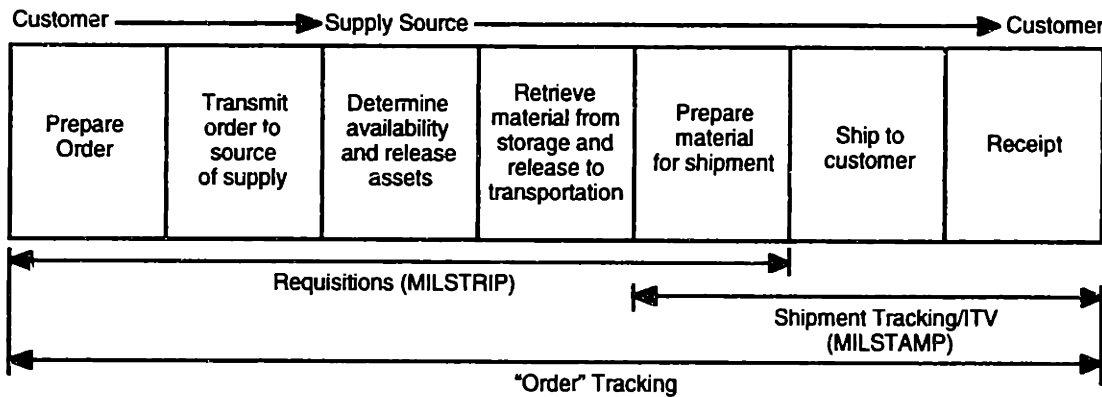

Figure 3.2: Processing Material Requisitions

Under MILSTRIP, supply sources are required to provide certain information on requisition status. This includes positive, rejection, or exception status (e.g., backordered); a direct delivery notice; or a shipment status (e.g., date released to carrier). MILSTRIP data has a major shortcoming in that it is not real-time because the DoD supply systems involved use batch processing cycles to generate status documents. Update delays have been on the order of two to five days. DoD is moving away from MILSTRIP and towards American National Standards Institute (ANSI) Accredited Standards Committee X12 Electronic Data Interchange formats.

All customers of the logistics process need accurate real-time requisition data. Consignees need this visibility to have confidence in their orders so that duplicate orders are avoided. Supply activities use it to respond to end-user queries and to plan

receipt workloads. Headquarters and major commands require this information to monitor the status of critical orders, while CINC and JTF planning staffs need it to assess contingency operations. Logistics managers throughout the supply system require the capability to track requisitions to capture logistics performance data.

LIPS has been fielded as the DoD central repository and standard query system for requisitions. LIPS captures the information it needs from DAAS including all queries, responses, and MILSTRIP data. DAAS will route this information among LIPS, the ICP AIS on the supply end, and JTAV on the customer end. It will also update GTN when requisitions are released to transportation.

3.3. Material Business Area: In-Storage and In-Process Visibility

The material business area encompasses two of the three TAV asset classifications: in-storage and in-process. The in-storage segment of the logistics pipeline involves approximately 6.75 million individual line items, with a total value of more than \$150 billion, stored at over 1,000 locations worldwide, and supporting nearly 2.2 billion transactions each year [19]. To stay within the focus of this thesis, we will only consider issues relevant to in-storage assets and munitions specific systems. Real-time information on munitions stocks is primarily important to material managers at depots for inventory planning and control purposes, but this information is also helpful to end-users for operational planning and to logisticians on various staffs to assist operating forces in resolving material problems and assessing the logistics consequences of operational plans. This data consists primarily of information on stock balances by condition and purpose codes.

The underlying network of AISs supporting this pillar of TAV is massive: In 1995 there were seventeen major technologies and ongoing initiatives grouped together under the generic umbrella of ICP AIS. DoD's long term strategy is to replace these existing ICP systems with the Material Management System (MMS), a series of applications being developed by the Joint Logistics Systems Center (JLSC). However, a single system was being developed specifically for ammunition: the Ammunition Management Standard System (AMSS). Once in-process or in-storage assets are

requisitioned and approved for transportation, they become in-transit assets and are tracked under a new array of AISs.

3.4. Transportation Business Area: In-Transit Visibility

In-transit visibility (ITV) is defined as "the ability to track the identity, status, and location of DoD unit and non-unit cargo, passengers, medical patients, and personal property from origin to consignee or destination during peace, contingencies, and war." This definition and a thorough high-level review of ITV is presented in the 1995 DoD Intransit Visibility Integration Plan [61]. The in-transit portion of the logistics pipeline entails more than 7 million shipments annually, including 100,000 international container shipments, with 41,000 containers stuffed at vendor facilities and shipped directly to DoD customers. At a minimum, DoD requires the capability to identify the contents of any shipment and monitor its location as it moves from origin to destination. DoD also needs the ability to track individual items, unit movements, and non-unit personnel movements; and to act in real-time to reconstitute and divert shipments to new destinations. The two principle elements of this capability are: automation at shipment sources to generate accurate data and send it to other operational nodes to support follow-on processes; and a central transportation data repository to support transportation management processes, current and future operations planning, reports and data analysis, and customer inquiries. In this section we describe the in-transit procedures and technologies that support sustainment munitions transportation, with GTN as the core ITV system. We also touch on some details regarding development of the theater logistics system (JTAV) as it is also closely linked to the transportation processes and GTN.

The OSD assigned USTRANSCOM the responsibility for developing a DoD wide ITV capability. As a response to that tasking USTRANSCOM developed GTN, discussed in Section 3.4.1. GTN is a key pillar in the TAV architecture because it is also the means of updating the Worldwide Military Command and Control System (WWMCCS) and the Joint Operations Planning and Execution System (JOPES) with selected data. Ultimately, GTN will become the transportation module of the Global

Command and Control System (GCCS), the system in development which will replace WWMCCS and JOPES.

Components of ITV fall along the logistics classification provided in Chapter 1. There are two major components of ITV - cargo and personnel. Cargo is further divided into unit, non-unit, personal property, and redeployment and retrograde subcomponents. Although they will share some common characteristics, operating concepts and technologies for each ITV subcomponent are unique. Our focus is on the procedures and systems that support non-unit cargo logistics, in which bulk munitions shipments fall. Non-unit cargo includes all sustainment material (except supplies and equipment accompanying a unit during deployment) in CONUS, pre-positioned overseas, or afloat [61].

Shipments should be referenced on a line-item basis by either shipment identification number, transportation control number (TCN), national stock number (NSN), or requisition number. Non-unit cargo is documented using transportation control and movement documents (TCMDs), government bills of lading (GBLs) and commercial bills of lading (CBLs).

Experience has shown that efficient management of non-unit cargo movements provides the greatest potential benefits for the implementation of ITV, but it also poses some of the biggest challenges. For one, more than 1,000 CONUS installation transportation offices (ITOs), supported by at least 11 different application systems, initiate millions of non-unit cargo shipments every year using all modes of transportation. Control and visibility is further complicated by the fact that about one-third of all non-unit shipments originate with commercial vendors [61]. Finally, all shipments are documented with a variety of standard and non-standard formats.

The ITV operating concept is depicted in Figure 3.3. The concept calls for GTN to receive transportation information from source systems through the CONUS Freight Management (CFM) System, POE and POD systems, and the theater transportation system. Requisition and NSN data are to be received from DAAS. Source systems include Military Service legacy depot systems; Defense Logistics Agency's new Distributed Standard System (DSS); the Transportation Automated Management System (TRAMS); systems supporting the Military Services' ITOs; and all commercial vendor systems.

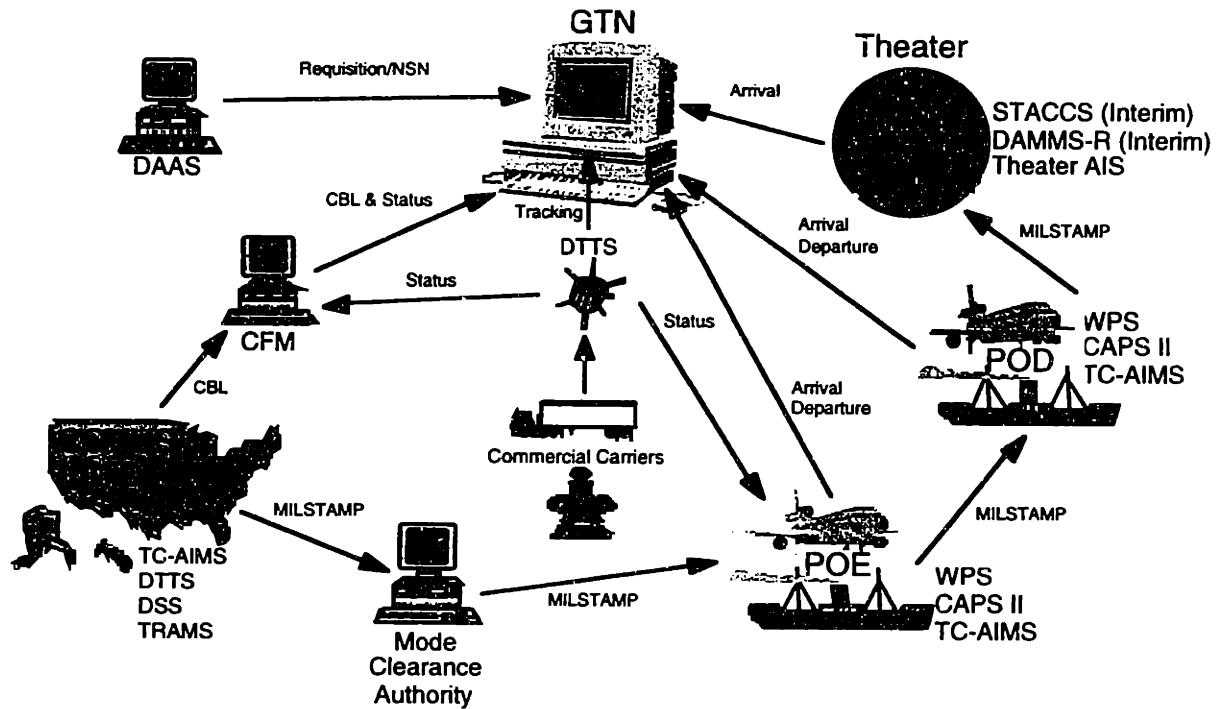

Figure 3.3: ITV Operating Concept for Non-Unit Cargo

Major port systems include MTMC's Worldwide Port System (WPS) for surface movements and AMC's Consolidated Aerial Port System II (CAPS II) for air movements. The ports still maintain internally developed systems specific to their operations (e.g., the Total Ammunition Movement Management Standard System (TAMMS) at Concord NWS and the Sunny Point Automated Network (SPAN) at MOTSU).

The theater transportation system has still not yet been developed, but could build upon capabilities present in the Military Services' Transportation Coordinator's Automated Information for Movement Systems (TC AIMSs) - a set of Military Service specific systems used primarily in the management of unit cargo shipments; the Standard Theater Army Command and Control System (STACCS) which tracks Army unit movements; and the Department of the Army Movement Management System - Redesign (DAMMS-R), which forecasts and tracks inter-theater cargo and containers.

When a non-unit shipment occurs, the CONUS source system transmits shipment information to the appropriate terminal, consolidation point, or consignee. This information is governed by MILSTAMP and the Defense Traffic Management Regulation (DTMR) and consists primarily of an Advance Transportation Control and

Movement Document (ATCMD). A Transportation Control and Movement Document (TCMD) accompanies the shipment through the pipeline. If the shipment is documented using a GBL or CBL, the data is transmitted to the CFM system which then updates GTN. CFM is used to provide both in-transit visibility information to GTN and rated shipment information to transportation payment centers for electronic funds transfer to commercial carriers. In January 1994, the MTMC implemented Electronic Data Interchange (EDI) techniques for receiving GBL data in the CFM system from a few defense shippers. If the shipment is being routed outside CONUS, the shipping activity submits an Export Traffic Release Request to MTMC as the OCCA (Chapter 2), the organization that owns the military surface clearance procedures. If approved, an Export Traffic Release (ETR) is returned and a booking is secured on either air or sealfit.

Commercial motor and rail carriers, under contract to the DoD, transport more than 55,000 arms, ammunition, and explosive shipments each year throughout CONUS [61]. Because of the high level of public exposure and sensitivity to these volatile shipments, DoD requires that these shipments be monitored by the Defense Transportation Tracking Service (DTTS) in Norfolk, Va., from origin to destination. DTTS receives shipment information in a variety of formats (phone, facsimile, and remote terminal entry) from over 200 activities. Shipment information is linked to hourly automatic position reports received via satellite from transponders on the commercial conveyances, and this data is forwarded to GTN.

Additionally, commercial carriers are required to provide shipment status messages via electronic data interchange whenever any of the following actions occur: ocean cargo is transshipped, a change is made in the mode of transportation, a carrier passes control of a shipment to another carrier, or a carrier completes delivery of the shipment. Ocean carriers would transmit data by commercial EDI to WPS which then forwards the status messages to GTN. In a similar manner, rail, motor, and air carriers would transmit their status messages to CFM, which then forwards the data to GTN.

POE systems provide GTN with three ITV messages for every shipment: expected shipment arrival information; port arrival information, and port departure information. POD systems then provide port arrival and departure information to both

GTN and the theater transportation system. Finally, GTN would receive destination arrival data from the theater system.

Four major issues must be resolved before the operating concept can be successfully implemented. First, DoD must ensure the availability, quality, and timeliness of MILSTAMP, GBL, CBL, vendor, mail and shipment status information from commercial carriers. This makes military transshipments (and even more so for munitions) for commercial carriers even less attractive than they already are due to the extra constraints that they impose. Second, the theater transportation system, which has been on the drawing board for many years, is yet to be developed. A theater commander's responsibility for the movement of cargo extends far beyond the arrival of material at the theater POD. Both unit and non-unit supplies and equipment are often subsequently shipped from the theater to CONUS or to another theater. While there is a substantial investment in a complicated CONUS infrastructure for deployment of cargo, lessons from Desert Shield/Storm indicate forces lack the capability to document and track shipments in theater. Today's military doctrine relies on rapid global response, and until a single, powerful theater system is developed that satisfies Joint Staff, Military Service, and Defense agency requirements, our capability in this area will suffer. Third, DoD needs to expand DTTS to use satellite tracking for other modes of transportation and commodities, and for OCONUS shipments (it has previously only been used for trucks). Finally, GTN interfaces with the necessary systems must be developed. Due to the complicated intertwining of existing systems meant to facilitate ITV (a total of 19 TCC, Military Service, and Defense Logistics Agency (DLA) systems at the time of this writing), The Joint Transportation Management Corporate Information Management Center (JTCC) has developed a migration strategy to reduce the number of Defense systems that provide source data.

Outside of these four major hurdles there are other significant challenges and unresolved policy, technical, and functional issues that could hinder USTRANSCOM's ability to field GTN as a comprehensive transportation C⁴I system, build a theater system, and develop the required interfaces. However, GTN has evolved successfully since its first prototype debut in 1989.

3.4.1. The Core ITV System: GTN

The Global Transportation Network's mission is to deliver comprehensive ITV, support command and control at the USTRANSCOM and its component commands, and guide transportation decision making throughout the DoD [10]. Although we have reviewed GTN's interfaces for non-unit cargo movements in the previous sections, GTN takes on a larger scope and encompasses almost every aspect of transportation throughout the DoD. It captures shipment status, booking information, passenger reservations and manifests, personal property, medical patients, and vessel and aircraft scheduling data.

Any user can supply appropriate unit, cargo, passenger, or patient information identifiers to the system. GTN then delivers an integrated view of transportation data (a combination of mode, location, date, and status). GTN begins to track a movement's status in the transportation system as soon as a request for common-user lift is made. Users can retrieve requisitions, schedules, itineraries, manifests, and related information about both classified and unclassified movements on all transportation modes. When extended to full operating capability (FOC), GTN will provide infrastructure metrics that reveal the level of commitment and stress of the transportation system; near real-time performance statistics; and historical data that transportation planners will use to identify longer-term trends.

Contracted to the Lockheed Martin Corporation, GTN is experiencing a rapid evolution. In 1989, USTRANSCOM demonstrated the first GTN proof of concept prototype. The GTN prototype focused on providing answers to a small number of ITV queries (e.g., location and status) by pulling "real-time" information from existing databases. In 1990, USTRANSCOM fielded Version 1.0. Although Version 1.0 relied on the same ITV architecture and systems developed for the prototype, it differed in two areas: it used leased instead of dial-up telephone lines, and it used a cache database to retain query information for 24 hours. Since both the prototype and Version 1.0 systems relied on pulling data from participating systems, they were highly communications intensive. They also processed queries individually and did not retain the results [61].

In an attempt to resolve those problems, Version 2.0 was developed, which used the participating systems to “push” information to a centralized database as part of their normal protocols and processing workloads. This permitted GTN to support a much larger base of customers without significantly increasing the interactive user-load on the supporting systems. Version 2.1, which was fielded as a prototype in FY93, focused on tracking air cargo and passengers moving from POE to POD. Version 2.2, fielded in January 1994, added similar capability for surface shipments. GTN Version 2.3 uses an improved Global Decision Support System (GDSS) interface to provide enhanced visibility over air missions and an expanded query capability [61].

The initial operating capability (IOC) version of GTN was delivered in late 1996 providing full ITV from POE to POD, enhanced CONUS links, updates from ten major transportation AISs, and the first interface with the GCCS/JOPES Schedule & Movement (S&M) client/server system, the repository of DoD deployment planning, activity, and status information. The ambitious GTN full operating capability (FOC) version, scheduled for delivery in 1999, will encompass movements from CONUS origins, through the ports, and forward to theater destinations; process more than three million update transactions a day and communicate simultaneously to hundreds of on-line users. Two different interfaces will be available: a “power user” interface that makes all GTN features available and allows for C² via a dedicated terminal, and a world-wide-web interface that delivers answers to “simpler” questions from most users [10].

The FOC version of GTN will also consist of four core capability modules: In-Transit Visibility (ITV), Current Operations, Future Operations, and Patient Movement. The ITV component is the core real-time decision support capability; it is meant to provide rapid transportation related information on all assets, schedules, and actual movements in peace, contingencies, or war. The other components are planned extensions that will make the FOC GTN a comprehensive planning and control system for defense transportation. Descriptions of capabilities within these modules are provided by Begert [10]:

- **Current Operations:** Provides information for operational planning and control. Displays asset information, planned versus actual comparisons,

requirements versus capabilities comparisons, and collateral transportation intelligence information on airfields, seaports, and transportation networks.

- **Future Operations:** Provides decision support for tactical and strategic transportation planning and analysis. Incorporates the functionality of the Joint Flow Analysis System for Transportation (JFAST) including mode and port selection, movement capacity, cost, feasibility, and predictive analysis, readiness assessment, and “what if” analysis of assets, resources, and infrastructure (JFAST is a massive simulation architecture that integrates the capabilities of a number of DoD nodal logistics simulations to model the entire pipeline).
- **Patient Movement:** Applies the TRANSCOM Regulating and Command & Control Evacuation System (TRAC2ES) to forecast, plan, coordinate and execute worldwide patient transportation, and to provide ITV of individual patients.

3.5. The Foundation for Real Time Information: Automatic Identification Technology (AIT)

Although a host of automated information systems exist to provide visibility information over different segments of the DoD logistics pipeline, these systems have traditionally relied on manual data entry at multiple nodes throughout the defense transportation system and thus comprehensive real-time data for planning is often unreliable, sparse, or nonexistent. Automatic Identification Technology (AIT) is a suite of logistics tools being pursued by the DoD for facilitating data capture, aggregation, and transfer [19]. It must be integrated with client logistics AISs to provide reliable real time information. AIT involves the use of electronic read and write tagging media (e.g., bar codes, magnetic storage media, integrated circuit or “smart” cards, laser memory cards, and radio frequency (RF) tags) to mark the contents of shipments [19]. It also includes the hardware and software required to create the devices, read the

information on them, and provide interface with AISs. The information on each AIT device can range, for example, from a single part number to an entire self-contained data base. These devices are interrogated with the use of either contact, laser, or RF devices. AIT tags will employ a standard supply and transportation data set (e.g., ASC X12 858) for documenting the contents of surface containers and air pallets, thus replacing hard-copy TCMDs. By minimizing human intervention, updates are made reliably and rapidly and a much richer pool of data can easily be made available for planning technologies.

After performing lengthy requirements assessments, the DoD has concluded that no single AIT device could support all potential applications [19]. The current operating concept calls for a family of devices with some redundancy across AITs to support the various logistics applications. Table 3-2, reproduced from the 1995 DTAV Implementation Plan [19], gives a summary of the selected AITs being integrated into defense transportation along with some of their advantages and disadvantages. These technologies are robust; operating in warehouses, terminals, ocean vessels, aircraft, land vehicles, and all DoD equipment used for moving unitized shipments.

Table 3-2: Selected AIT Summary Data

Technology	Capacity	Encoding	Access	Range
Linear Bar Code	25 characters	printer	handheld	close
2D Bar Code	1,850 characters	printer	handheld	close
Laser Card	2.8 MB	laser	fixed	contact
Smart Card	8 KB	electric	handheld	contact
Memory Card	20 MB	electric	handheld	contact
Passive RF Tag	16 bytes	RF	fixed/handheld	20 ft line of sight
Active RF Tag	unlimited	RF	fixed/mobile	300 ft omnidirectional or global (LEO satellite)

Technology	Advantages	Disadvantages
Linear Bar Code	<ul style="list-style-type: none"> • Inexpensive • Low error rate • Disposable • Industry standard 	<ul style="list-style-type: none"> • Low capacity • No updates
2D Bar Code	<ul style="list-style-type: none"> • Inexpensive • High capacity 	<ul style="list-style-type: none"> • No updates
Laser Card	<ul style="list-style-type: none"> • Inexpensive • All environments • Very high capacity 	<ul style="list-style-type: none"> • No DoD standard • Requires human contact • Expensive readers • Not portable

Technology	Advantages	Disadvantages
Smart Card	<ul style="list-style-type: none"> • Moderate cost • Secure • High capacity 	<ul style="list-style-type: none"> • Requires human contact • Slow transfer rate
Memory Card	<ul style="list-style-type: none"> • Reusable • Ultra high capacity • Rapid transfer rate 	<ul style="list-style-type: none"> • Requires human contact • Expensive
Passive RF Tag	<ul style="list-style-type: none"> • Reusable • Extensive data transfer 	<ul style="list-style-type: none"> • No DoD standard • Line of sight
Active RF Tag	<ul style="list-style-type: none"> • Reusable • Read/write capability • Location finding • Transaction capture processing • Ultra high capacity 	<ul style="list-style-type: none"> • Expensive • No DoD standard • Slow transfer rate • Frequency dependent

The operating concept for AIT implementation calls for the use of linear bar codes, two-dimensional bar codes, memory cards, and RF tags. Linear bar codes will be used to provide item identification and document control information for *individual* items and shipments. Two-dimensional symbology bar codes provide comprehensive data on individual items or shipments, and *consolidation* data on multipacks and air pallets (a multipack is a consolidation of several items stored or moving in various configurations such as tri-wall containers or shrink-wrapped or banded warehouse skids) [19]. Memory cards will be used to document supply-content data for material in multi-packs, air pallets, containers, tractors, trailers, and rail cars; used where extensive data are required. Finally, RF tags are used to support containerized ammunition and several other special large scale applications including all CCP-stuffed and depot-stuffed seavan containers and all unit cargo moving in containers. The DoD is attaching permanent RF tags to all CADS containers. This operating concept, depicted in Figure 3.4, covers all in-process, in-storage, and in-transit logistics.

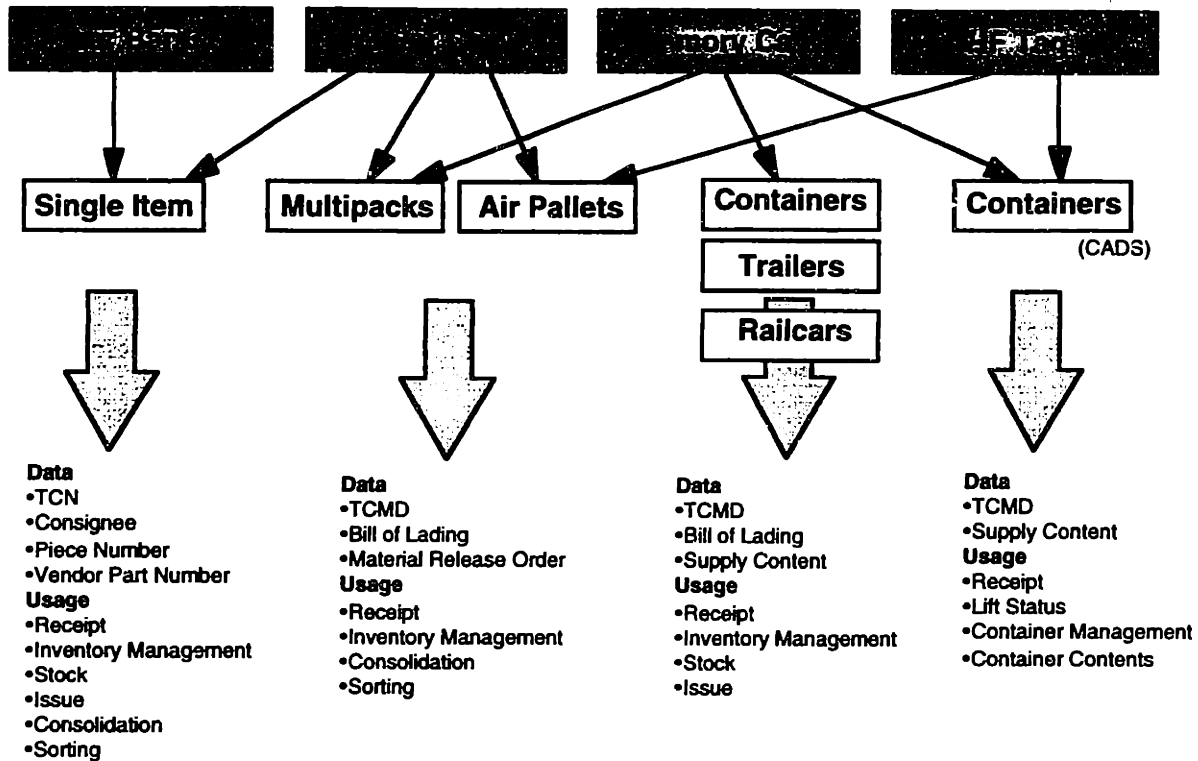

Figure 3.4: Concept of Operation for AIT Application

With RF tags mounted on CADS containers, depots would upload all required transportation and requisition data onto the tags; they would also transmit the transportation data electronically to the POE for manifest preparation. When shipments arrive at the sea ports, the ports would read the tags to capture movement status data and update their inventory and location files. Upon eventual receipt of the shipment in the theater, consignees would also read the tags to update their accountability files. The implementation of this operating concept is in its infancy for munitions transportation: in the summer of 1997 the technology had only been applied for testing at Crane and MOTSU.

3.6. Chapter Summary: TAV Within a Command and Control Perspective

This section provided a high level review of information management in DoD logistics, the automated information systems that are currently in use or planned to provide Total Asset Visibility, and the automatic identification technologies that will support these systems. The need for Total Asset Visibility is clear: In peacetime it serves as a

critical fiscal management tool, reducing the cost of material in the logistics pipeline and allowing for leaner inventories. For example, in the past when operating units consumed their retail assets (consumer level supply) during training or combat operations, they requisitioned replacement assets from the wholesale stock system even though nearby retail activities of other Military Services may have redistributable stocks for those same items. Weapon system readiness routinely suffers in the field because demands for critical replacement parts are backlogged pending receipt from procurement, while assets are readily available at nearby retail sites of another Military Service (or in some cases, the same service) [19]. Thus TAV offers to reduce inventory levels of retail assets (safety stocks), maintenance costs, and transportation costs from wholesale stocks.

The need for TAV during wartime is also obvious: it facilitates mobility and combat readiness. As it promises to instill more confidence in the supply system, redundant orders will be minimized and congestion in the logistics pipeline will be alleviated. Furthermore, this information will enable identification of priorities on material in the pipeline to the theater as the deployment progresses, throughput at the POD, and ultimate delivery to the troops in the field. TAV also provides a capability to act on this information via commands through its component AISs (e.g., reconstitution and diversion of shipments).

AIT, when integrated with automated logistics information systems, is the key to the DoD's efforts to build real-time TAV and decision support. The first efforts toward AIT integration were being taken at the time of this writing. To fully exploit its potential, AIT must be consistently applied to all material assets and shipment containers. All facilities and ports must be capable of reading, processing, and communicating AIT data.

Finally, this discussion is important because the TAV/ITV systems architecture must serve as the foundation on which higher level planning and analysis technologies are built. We are ready to summarize these capabilities and introduce them within the context of the remainder of this thesis by placing them within the perspective of a command and control (C²) system. This is pictured in Figure 3.5.

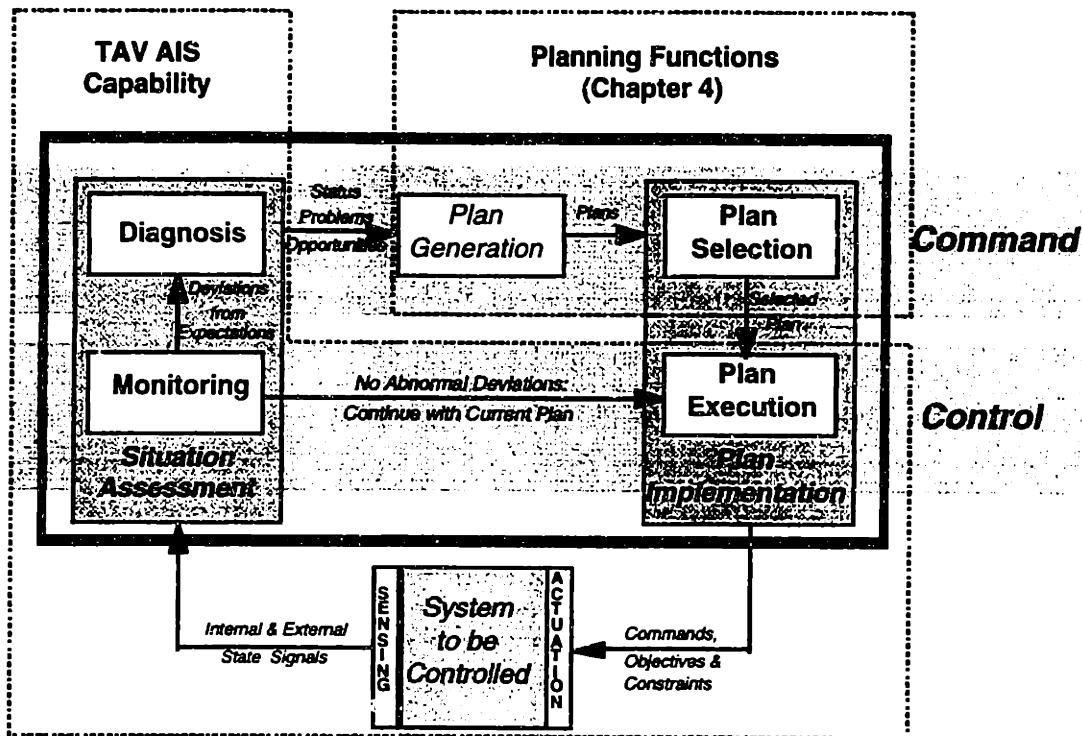

Figure 3.5: TAV/ITV AIS Capability Summary

The target of any command and control system is the external system which is to be controlled, in this case the CONUS munitions logistics network. This system decomposes into facilities such as depots and ports and resources such as transportation and lift assets and container storage locations. Real time information regarding elements internal to the system and external or environmental state variables are gathered through the function of *sensing*. Internal information on the state of the logistics network will mostly be provided via AIT and EDI. This data, which is highly disaggregate, is passed to the *situation assessment* function.

The situation assessment function is provided at varying levels of capability by the logistics AISs that we have reviewed. Here, much of the data is aggregated in ways to provide meaningful system metrics such as: average transit and throughput times, net explosive weight accumulations and resource utilizations, along with the variances in these measures. In the TAV architecture, databases also pass along specific status information requested by the user. The *monitoring* subfunction uses this data to identify bottlenecks in the pipeline, shipments which are early or late, constraints which have been violated, and any other relevant realized deviations from current transportation plans. These deviations are passed along to the *diagnosis* subfunction

which identifies the source and characterization of any problems or opportunities that these deviations present. This information in the TAV architecture is passed on to the user. Unsophisticated AISs may provide no monitoring or diagnosis, where others, such as the GTN FOC version (through its Current Operations module), provide this extensively.

Finally, in AISs where interfaces exist to allow authorized operators to act on the information presented, the user can input commands at the terminal and have them executed on the actual system. The *plan execution* function simply transforms these commands as appropriate and passes them on through the relevant communications channels to the operators who must put these directives into action (*actuation*).

All of the command in the TAV architecture is provided through human interaction, and thus any logistics *planning*, including *plan generation* and *selection*, is performed outside the loop by some other means. Even in the Future Operations module of GTN, the planning function is separate from the real system (i.e., it works “off-line”). The remainder of this thesis explores analytic plan generation as a means to provide automated logistics decision support at all levels. A paradigm for deployment planning and the development of an optimization model for sustainment munitions mobilization planning is explored in the next chapter.

4. Munitions Deployment Planning

The last chapter introduced the information *processes* and standards which are used to coordinate munitions transshipment activities and the supporting information *systems* which provide logistics and operational users with “real-time” visibility over the state of the network. This information is important to the logistics decision makers for planning and ultimately the theater commander charged with controlling and supporting forces in a contingency. TAV AISs exist as an important component of the logistics command and control system.

Command and control systems are ultimately developed to cope with uncertainty. Levis and Athans provide a notional mathematical definition of uncertainty that is particularly useful to our discussion. Let K_N represent the knowledge needed to make a decision and let K_A be the knowledge that a decision making entity has at the point in time and place that a choice needs to be made. Then uncertainty can be defined as:

$$U = K_N - K_A \quad (4.1)$$

Namely, uncertainty is the difference between what one needs to know and what one knows. The terms K represent knowledge, not data or information. Data is

transformed into information by technological processing, but the subsequent transformation of information into knowledge is a cognitive process done by humans (humans are the ultimate decision makers in the logistics pipeline). Therefore, underlying AISs supporting TAV are meant to increase the amount of available knowledge (K_A) by maximizing the amount of important information provided to the user through the sensing and situation assessment functions of the cybernetic diagram in Figure 3.5.

However, Equation (4.1) makes it clear that a reduction of uncertainty is not always synonymous with increased data flow. The second term, K_N , is a major hurdle in analysis of the munitions logistics pipeline. As we saw in Chapter 2, the CONUS segment alone presents a very complex problem. The problem is multidimensional in that there are multiple interdependent processes with numerous underlying stages. Each leg is plagued by elements of stochasticity and demand is ultimately driven by the external fog and friction of war in the theater. If we ever hope to be successful in planning for contingencies and control of this network during operations, ultimately some effort must be focused on reducing the K_N term. This is where the TAV AISs fall short as a complete C^2 system: they provide an overwhelming amount of information but little decision support.

Decision support can be provided to a large extent by automating the plan generation function. With today's modern computing technologies, mathematical models can be developed to rapidly evaluate alternative courses of action and assist the commander in plan selection.

In this chapter, we develop a framework for a hierarchical planning system as it relates to follow-on sustainment munitions deployment from CONUS; that is, the actual movement of container freight from the network described in Chapter 2 in response to contingency demand. Our approach does not directly consider capital investment decisions that are relevant to network design or configuration issues. Instead, the physical infrastructure and inventory of the network is treated as fixed and we focus on the problem of creating and executing flow plans and related schedules in response to contingency demand. To set the stage, we review the deployment planning classifications as practiced in the DoD and establish a hierarchical paradigm for munitions flow planning. We then develop a tactical level network flow model in a

linear programming context to support deliberate planning. The model is implemented and tested, and its extension to strategic analysis and as an operational decision aid within a command and control system is proposed.

4.1. Deployment Planning Taxonomy

In any large scale system that is to be directed toward the accomplishment of some mission, planning and control are conducted continuously at many different levels. The scope and objective of a planning effort determines the characteristic inputs and outputs to the process and the environment in which planning is carried out. It suggests the level in the system organization where it is employed. A commonly used classification, first presented in Anthony [6, 13], divides planning efforts into three separate but interconnected scopes: strategic, tactical, and operational. The aim of this section is to map this classification to the DoD's deployment planning taxonomy as reviewed in Schank et. al. [54] and to show how our focus on the CONUS portion of the logistics pipeline corresponds to an established spatial delineation of the network. Both of these dimensions will set the basis for a hierarchical decomposition of the follow-on sustainment munitions deployment problem proposed in this chapter.

4.1.1. Resource (Strategic) Deployment Planning

Resource planning is strategic. It is peacetime planning done primarily at the highest levels of the DoD logistics organization: the Joint Staff Logistics Directorate (JS J-4), military service headquarters, and Office of the Secretary of Defense (OSD). It encompasses program development and policy research conducted in the Planning, Programming, and Budgeting System (PPBS) [54]; it is geared towards long-range planning for developing force structures that are both affordable and operationally effective. Although mobility studies in resource planning may presume specific theater scenarios, the analyses are collectively meant to inform coordinated planning for total forces. In practice, this planning is conducted in two year cycles with horizons of six years.

Decisions made at this level often involve large capital expenditures for the introduction of new infrastructure. Examples in our context include construction of

new capacity and expansions of existing capacity, location and sizing of new facilities, munitions stock composition and distribution, the procurement of new MHE, and the employment of new transportation systems. Other decisions involve similar *static* optima in that they are fixed and unchangeable for relatively long periods of time such as authorized personnel levels and contracts with commercial carriers. Almost all of the information input to this planning process is external to the logistics organization and is based on long range forecasts. As such, there is a high level of uncertainty and risk involved in planning at this level.

4.1.2. Deliberate (Tactical) Deployment Planning

Conducted at the level of the CINCs of combatant commands and USTRANSCOM, deliberate planning is initiated by taskings from the Joint Staff every two years [54]. It is tactical in scope, with horizons of approximately 30 days and geared toward the generation of what are called operational plans (OPLANs). OPLANs provide scenario guidance for execution in a hypothetical conflict in a specific theater. They include the time phased force deployment data (TPFDD) which is essentially a specific transportation sequence (movement table) developed to meet the theater CINC's required force closure profile in the most cost effective manner.

The development of every OPLAN TPFDD is an iterative process primarily conducted between the CINC and USTRANSCOM components. To begin the process, the CINC generates a concept of operations which is passed along to the theater service components with a list of apportioned forces and transportation resources. The components specify necessary supporting units and supplies; these inputs are integrated into the first TPFDD requirements as *loose* schedule objectives. From here, USTRANSCOM and subordinate elements analyze the schedule to see if its feasible, generating best possible closure profiles [54]. Initial schedules generated typically do not satisfy the CINC's desired closure profile, and transport shortfalls must be negotiated by reconciling cargo priorities with capabilities. The final TPFDD represents a *dynamic* optimum, in that the sequence is a set of best logistics decisions to be made over time to meet the requirements of the first 30 days of a likely large conflict. Planning for smaller, low intensity conflicts (LICs) is much more ad-hoc and will not be discussed here.

Since infrastructure, resources, and policy are treated as given from resource planning, there is less uncertainty and risk involved in deliberate planning. However, the OPLAN outputs are geared toward notional conflicts and as such there remains a large amount of external input to planning at this level that is subject to variability. The OPLANs provide a hedge against uncertainty at the operational level. Clearly, a valid plan can significantly improve response time and effectiveness to a real conflict but some amount of operational planning will always be required to meet actual constraints.

4.1.3. Crisis Action (Operational) Deployment Planning

Crisis action planning is purely operational; it takes place immediately before and during real conflicts. It is carried out at all operational levels from the CINC, Chairman of the JCS, National Command Authority (NCA) and USTRANSCOM down to depot containerization and port stevedoring crews. Although the situation at hand will continue to evolve, the *current* status of the logistics pipeline and the theater is always certain (and known if it can be ascertained effectively). The output of planning here is an operational order (OPORD) at the CINC level and *tight* schedules and movement plans at all lower levels.

The first OPORD, which initiates execution, is developed as a crisis is being assessed for response. The CINC develops several courses of action (COAs) that are submitted to the NCA for approval. If it is determined that a military response is necessary, the NCA selects one of the COAs and the CINC initiates the execution planning phase. The objective of developing an OPORD is essentially the same as the objective of developing TPFDDs in the deliberate planning phase but now decisions must reflect the current situation. The process of developing an OPORD can range from pulling an existing OPLAN off the shelf and putting it onto action or developing a new TPFDD entirely from scratch [54].

Once execution begins, schedule generation, transportation routing, and movement plans are generated at all operational levels on a real-time basis (usually daily with a horizon of five to seven days) to control the network. MSC establishes port calls for containerships. Ports perform work crew scheduling, container and conveyance sequencing, storage allocation, crane scheduling, and ship stow planning.

With JMTCA coordination, depots schedule container stuffing and release to commercial transportation modes. The situation is highly complex; replanning must be performed rapidly as events unfold and smooth coordination between operating organizations is critical. To achieve effective command and control, the CINC and planners must be closely tied to a central information processing system that provides logistics TAV.

4.1.4. Spatial Network Decomposition

The previous three sections provided a “vertical” classification for deployment planning. In this section, suspense terms and a geographical breakdown of the deployment planning problem commonly used in the DoD logistics community are used to lend a second “horizontal” dimension to our framework.

All deployment plans are generated based on schedule adherence and are thus prepared using reverse planning, beginning with the ultimate destination in theater where the force is to be employed [38, 39]. The *required delivery date* (RDD), first assigned by the CINC, defines when resources (personnel or cargo) must arrive at their destination ready for operations. The *CINC’s required date* (CRD) is the same suspense adjusted for transportation feasibility in the deliberate planning process; it is the date published in the TPFDD. Planning cargo movement within and among combat units in the theater is called *employment planning* and is performed by the field commanders under the CINC given CRDs in execution.

The first critical interim date is the *latest arrival date* (LAD), which defines the latest date the last resources can arrive and complete offloading at the POD. It is determined by subtracting the number of days required to move from POD to destination from the CRD. This movement time consists of in-theater marshaling, assembly, and transportation times. Complementary to the LAD is the *earliest arrival date* (EAD), which defines the earliest date the first resources can be accepted at the POD. Establishment of an LAD/EAD window is necessary because theater logistics infrastructure must prepare for throughput; resources that are too early cause congestion and poor operational security [62]. Planning for the deployment of cargo from the POD through intermediate staging areas to the operational units is called *theater deployment planning* and is performed by the CINC and his logistics staff.

In CONUS, transportation can begin from the resources' origin (i.e., home station, depot, etc.) after it has been processed for onward movement to the POE. This date is the *ready-to-load date* (RLD). The *available-to-load date* (ALD) defines when these resources can begin loading at the POE; it is the RLD plus transportation time to the POE plus processing time at the POE. Finally, the *earliest departure date* (EDD) is when these resources can depart the POE for overseas transshipment to the POD. It is a function of sealift or airlift loading time. Planning for the transshipment of resources from CONUS is called *mobilization deployment planning* and for non-unit cargo, it is performed by the appropriate logistics support organizations. For munitions, this is a coordinated effort between IOC depots, JMTCA, MTMC ports, and MSC. Just as we focused on CONUS transshipment operations for follow-on sustainment munitions in Chapters 1 and 2, our emphasis in deployment planning for this specialized commodity is directed toward mobilization.

The EDD must be established for a shipment so that it allows transportation to arrive at the POD within the EAD/LAD window. Planning overseas transportation of all logistics is called *strategic deployment* and is performed by MSC and AMC under the purview of USTRANSCOM. This term is not to be confused with *strategic planning*. Strategic deployment planning is actually tactical or operational planning in scope. Figure 4.1 summarizes these definitions as they apply to the logistics pipeline from "fort to foxhole."

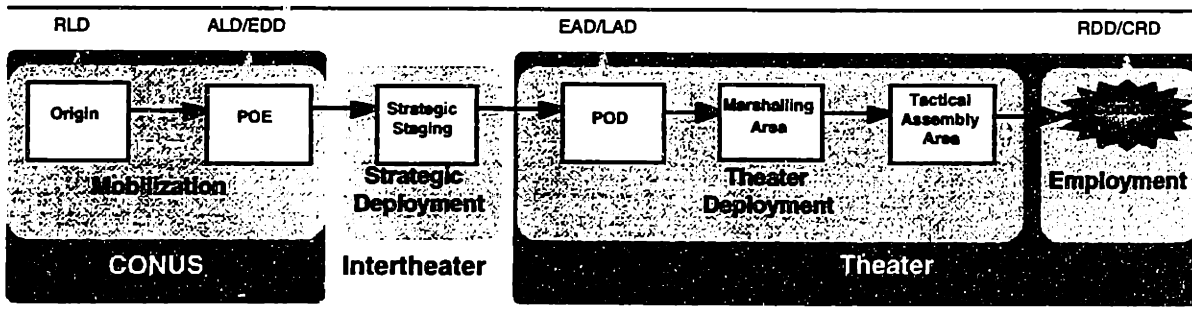

Figure 4.1: Deployment Pipeline with Suspenses – Fort to Foxhole

4.2 A Hierarchy for Munitions Deployment Planning

In this section we employ the planning classifications given in the previous sections to propose a framework for the development of models to assist munitions deployment planning and control. The complexity of the deployment planning problem was demonstrated by our discussion of transshipment operations in Chapter 2 and information management in Chapter 3. Clearly, construction of a model that plans actions over extended periods of time at a great level of detail for the entire network is both futile and impractical. This approach is futile because detailed actions planned on the basis of a specific prediction of the future may become obsolete. It is impractical because of the computational power required. A strategy that has proven successful in many similar large scale problems is a hierarchical decomposition of the problem that structures a *sequence* of decisions. Decomposition requires identification of discrete, tractable components of the problem at different levels that can be analyzed by appropriately scoped models. The architecture must describe the sequence in which models are used and the specific interfaces among these planning components. A hierarchical decomposition divides the problem along natural organizational and/or geographical lines in a manner similar to how the problem is addressed in practice. Such an approach is responsive to management needs at each level of the organization and thus facilitates interactions between models and managers at each organization echelon. Figure 4.2 illustrates the principles of hierarchical decomposition.

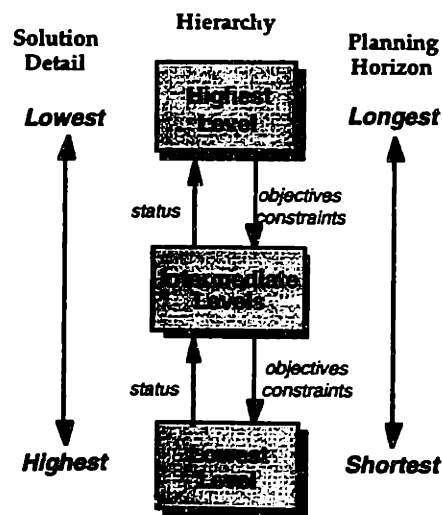

Figure 4.2: Hierarchical Decomposition Principles

The essence of the hierarchical decomposition approach is that decisions made at higher levels provide constraints for decision making at lower levels and the level in the hierarchy determines the planning scope and decision fidelity. Models and solutions to subproblems at the highest levels (i.e., strategic) of the hierarchy have the greatest temporal scope (longest planning horizon). However, detail at this level is minimal since only very aggregate decisions are useful. Often, a great deal of uncertainty must be handled at this level. At lower levels (i.e., tactical and operational) the planning horizon becomes shorter (nearer term), but the level of detail of planned activities increases. As each level is divided into smaller subproblems, these subproblems tend to cover narrower spatial divisions as well (e.g., individual facilities or regions as opposed to the entire network). Solutions to subproblems at each level are manageable with respect to capabilities of human operators and available computational systems. We might tie together the two dimensions of deployment planning discussed in previous sections to produce the planning hierarchy model in Figure 4.3.

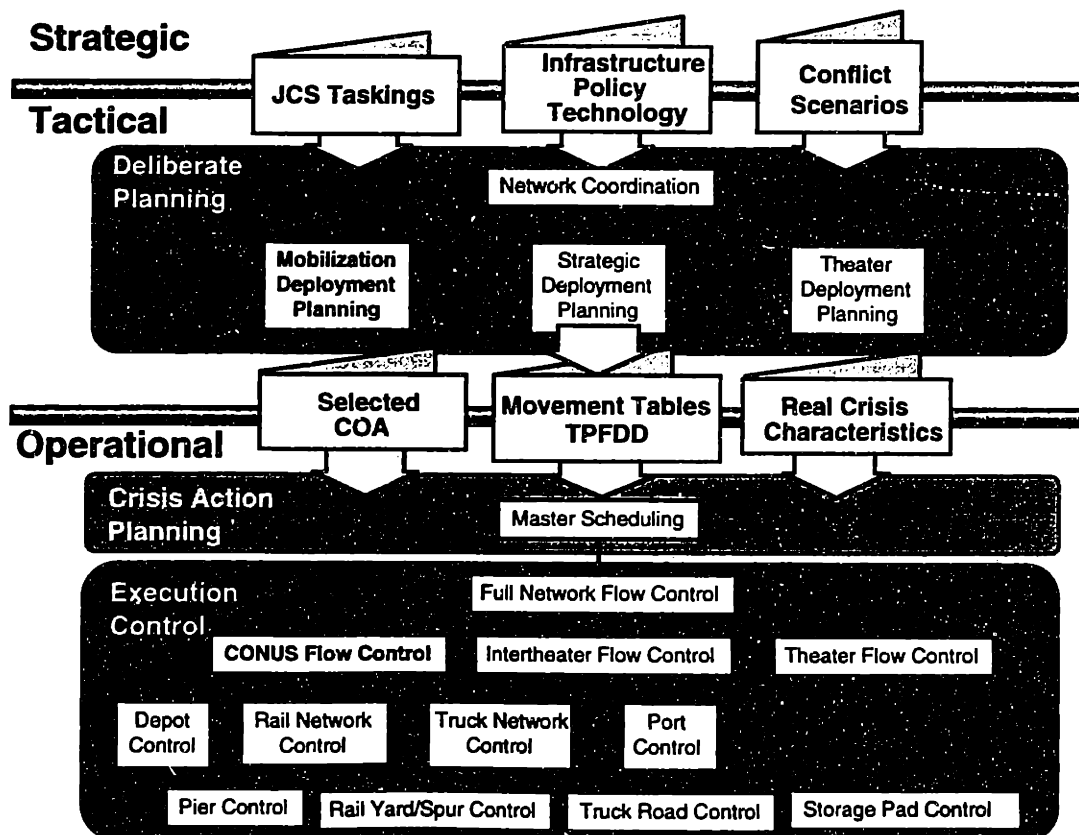

Figure 4.3: Hierarchical Decomposition for Munitions Deployment Planning

This hierarchy is purely functional; it is not meant to describe exact data interfaces among planning functions or to assign planning functions to specific logistics organizations. Instead, we provide it as a framework to pinpoint the scope of an optimization model developed in the next section and to set the stage for further analysis. Each box in the hierarchy is not a model but a function which can be supported by models. Modeling experience and operational considerations will dictate exact specifications in building a fully integrated decision support system.

We reintroduce the planning nomenclature in the context of how it applies to our hierarchy.

- **Deliberate Planning.** The set of planning functions that create loose, estimated deployment schedule objectives (i.e., RLD through CRD) and aggregate flow plans (i.e., routes, sequences, etc.) that are integrated into the TPFDD movement tables. External input to this planning function are the periodic JCS taskings which initiate the planning process; conflict scenarios; and infrastructure, policy, and technology constraints. Internal constraints include the CINC's required resources with associated RDDs. The network coordination function is used to reconcile differences between the theater, strategic, and mobilization plans and coordinate among them to achieve a better global (i.e., network wide) solution.
 - **Theater Deployment Planning.** Determination of required logistics flows from the POD in the theater in an attempt to meet RDDs, subject to available theater support. This function establishes the EAD/LAD window.
 - **Strategic Deployment Planning.** Determination of overseas lift routing to meet EAD/LAD windows, subject to available transportation assets. Establishes EDD cutoffs.

- **Mobilization Deployment Planning.** Determination of required logistics flows in CONUS to meet EDD cutoffs subject to capacities and outloading capabilities. This function establishes RLDs and ALDs.

- **Crisis Action Planning.** The set of planning functions that determine *tight* schedule objectives and aggregate flow plans given the actual constraints in the crisis at hand and the COA chosen by the NCA. This function uses available movement tables from the deliberate planning phase as guidance. Only one master scheduling component is depicted, although this function might also be segregated along the lines present in the deliberate planning function, especially if no TPFDD is available. As the operations progress, this function is invoked periodically off-line to reassess the theater situation and create new schedule objectives, if necessary. The emphasis is on precisely what items, where, and at what time.

- **Execution Control.** This function represents a fully integrated real-time command and control system. The architecture decomposes into a set of local controllers at all levels throughout the network that continuously specify activities that are to be performed to operate within the schedule determined by the crisis action planning function. Due to the hierarchical decomposition, command and control must be *coordinated* at each level. This function is integrated into our cybernetic diagram in Figure 4.4.

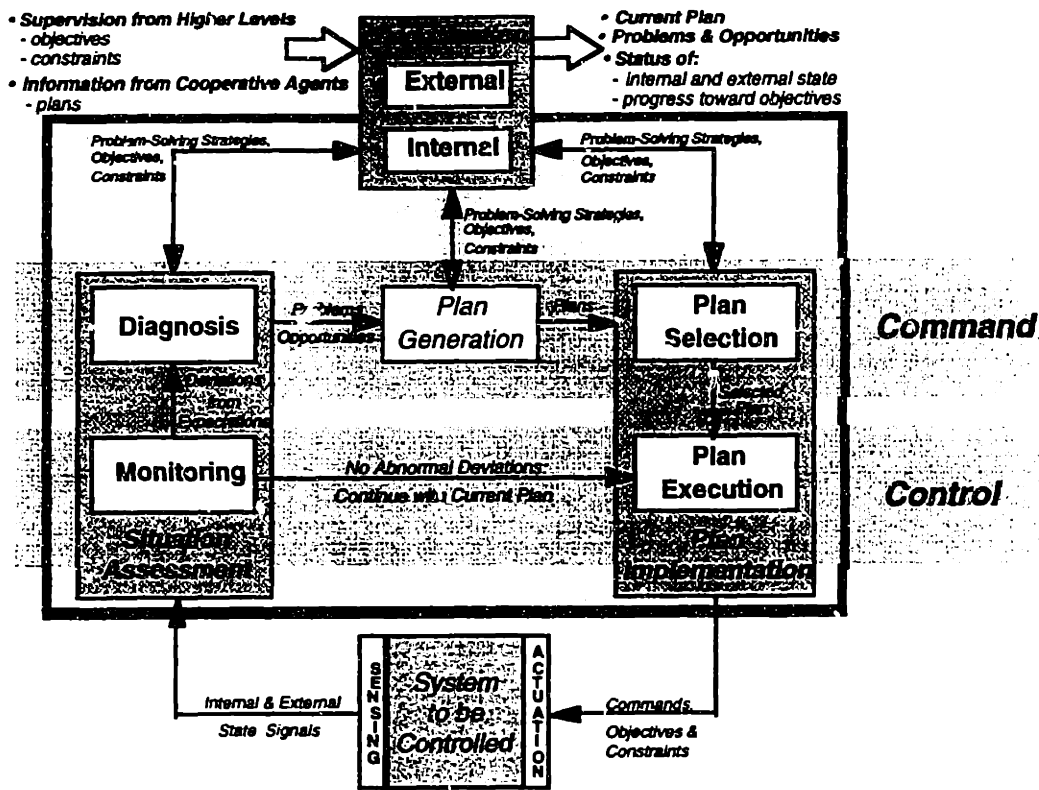

Figure 4.4: C² Internal and Hierarchical Functions

The coordination function organizes and executes communications with external organizations, and influences control of the internal C² sub-functions. *External coordination* is used to interpret requirements from higher planning authorities and to negotiate with subordinate and collateral planning levels. *Internal coordination* translates external inputs into objectives and constraints. Based on the problem at hand and the system status, it develops solution strategies and the criteria for determining when replanning is required. This will be the most challenging and also the most difficult C² function in the munitions logistics pipeline because of the array of organizations involved and the massive data interchange required to support operations.

As “significant” deviations from the schedule occur, the local controllers are responsible for resolving the problem as locally as possible to minimize impact on network operations. If deviations cannot be resolved within the local controller’s scope, the effects “spill” beyond the relevant boundaries and the network plan is impacted. An example might be a gantry crane breakdown at one of the ports under heavy loading conditions, causing a major bottleneck.

The local controller communicates these spillovers to the higher level planner, who again tries to resolve the problem as locally as possible. Approaches consist of two extremes. If there are no other opportunities, freight deliveries can only be rescheduled throughout the network. If there are underutilized routes or other slack points available, the flow might be rerouted. Many solutions might consist of a combination of the two. Upward communication and modification of schedule objectives is often referred to as *recovery* [7].

At the operational level, high fidelity models and information systems are used to provide decision support to operations personnel for creating *detailed* plans and controlling logistics activities. This is where crew and lift scheduling, transportation routing, and container and conveyance sequencing are done continuously. Due to time constraints at these lower levels, decisions implemented are rarely optimal. Instead they are derived from heuristic rules or algorithms designed to deliver good plans fast.

The next section presents the progressive development of an optimization model that can be used to assist munitions deployment planning. Again, our model is initially designed to develop *mobilization* plans, but we also show how its capabilities might be extended to the strategic and operational deployment planning levels. We use a linear programming approach because it is typically well suited to tactical level decision making, and more specifically, a network flow model because of its flexibility and broad applicability to transportation problems. Although we are not focused on the organizational aspects of modeling, the model we develop could be employed by the JMTCA, IOC, or MTMC.

4.3. Mathematical Problem Formulation

The tactical nature of the follow-on sustainment munitions mobilization problem suggests it might be well addressed analytically by a linear programming model. Tactical level decisions often generate models with a large number of variables and constraints due to the complex interactions among choices available to the decision maker [13]. Moderate uncertainties in the data can be addressed by performing

sensitivity analysis. Linear programming at the deliberate planning level will provide plans (movement tables) which must be disaggregated and met through execution at the operational level. Our objective in this section is to construct a network model geared toward deliberate planning off-line of the operational system. We later discuss how our approach might be extended to strategic analysis and to application for real time network planning and control. As in DoD logistics planning practice, our model is schedule driven; we plan flows to meet fixed munitions requirements at the ports. We seek to capture the dynamic essence of the problem by successively adding greater detail to a mathematical formulation. The recurring theme at each phase is to find a set of dynamic flow decisions that meet port requirements at minimum cost.

First, consider the problem in the most aggregate unrestricted planning perspective. Under the MRS BURU requirements and the Army Strategic Mobility Plan (ASMP) forecasts, there will be four Tier I depots (Bluegrass, Tooele, Crane, and McAlester) and one Tier II depot (Anniston) serving as *primary* sources responsible for containerizing and delivering follow-on sustainment ammunition to the three munitions terminals in the initial stages of a major contingency [43]. If delivery from any depot to any port is allowed, the network may be depicted as in Figure 4.5:

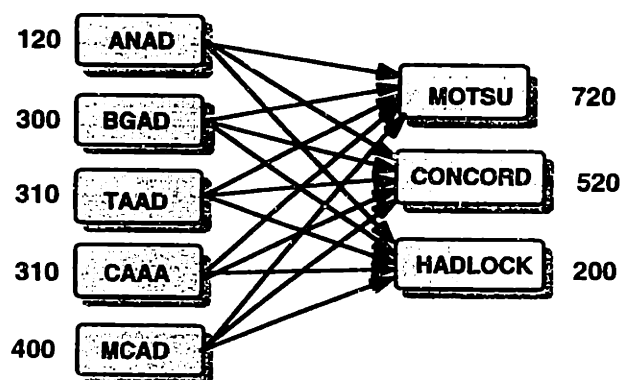

Figure 4.5: Daily Follow-On Sustainment Munitions Shipments (ASMP/MRS BURU)

The numbers on the left indicate the maximum daily container outload capacity (or supply) for each source facility as per the ASMP. The numbers on the right indicate the required daily container throughput (or demand) for each port in a dual MRC scenario as per MRS BURU. Note that total daily supply is equal to total daily demand. If we

allow any general linear cost of flow between each depot-port pair (e.g., travel time, transportation costs, etc.), no differentiation among containers, and a single uncapacitated link for each depot-port pair (i.e. a single transportation mode with unlimited capacity), the problem can be formulated as a transportation problem, a special case of the minimum cost network flow problem [4, 13].

Before giving the formal mathematical statement of the problem, we introduce the following notation:

- **Sets**

$G(\mathcal{N}, \mathcal{A})$ - the bipartite graph representing our problem

\mathcal{N} - the set of all nodes in the CONUS network (i.e., depots and ports)

\mathcal{N}_s - the source facility set (i.e., depots): $\mathcal{N}_s \subseteq \mathcal{N}$

\mathcal{N}_d - the destination facility set (i.e., ports): $\mathcal{N} \setminus \mathcal{N}_s = \mathcal{N}_d$

\mathcal{A} - the set of directed arcs $(i, j) : i \in \mathcal{N}_s, j \in \mathcal{N}_d$

- **Decision Variables**

x_{ij} - the flow of containers on arc $(i, j) \in \mathcal{A}$

- **Parameters**

s_i - the supply or available outload of containers at depot $i \in \mathcal{N}_s$

d_j - the demand or required throughput of containers at port $j \in \mathcal{N}_d$

c_{ij} - the per container cost of movement from $i \in \mathcal{N}_s$ to $j \in \mathcal{N}_d$.

Then the problem is stated as:

$$\text{Minimize} \quad \sum_{(i,j) \in \mathcal{A}} c_{ij} x_{ij} \quad (4.2)$$

$$\text{Subject to:} \quad \sum_{j:(i,j) \in \mathcal{A}} x_{ij} \leq s_i \quad \forall i \in \mathcal{N}_s \quad (4.3)$$

$$\sum_{i:(i,j) \in \mathcal{A}} x_{ij} \geq d_j \quad \forall j \in \mathcal{N}_d \quad (4.4)$$

$$x_{ij} \geq 0 \quad \forall (i, j) \in \mathcal{A} \quad (4.5)$$

In considering only one container type, that is, a single commodity, there is always an integer optimal solution to this problem. This particular application is a tiny optimization problem, consisting of only fifteen variables and eight constraints (excluding nonnegativity) if we use the depots and ports in Figure 4.5 and is trivial to implement and solve with a simple spreadsheet optimizer. Obviously, it yields little insight into a large scale dynamic logistics problem. However, it is illustrative of the basic problem structure that we wish to expand.

4.3.1. Multicommodity, Multimode, Capacitated Minimum Cost Flows

Retaining a linear cost structure and an aggregate planning perspective, we expand the problem formulation to include multiple capacitated links for each depot-port pair to represent different available modes of transportation (i.e. railroad, trucking, etc.) with capacity restrictions. We also differentiate among container types in accordance with Strategic Configured Load (SCL) operations [1]. We re-establish our notation with the following additions and/or modifications:

- **Sets**

- \mathcal{V} - the set of available transportation modes

- \mathcal{A} - the set of arcs $(i, j, k) : i \in \mathcal{N}_s, j \in \mathcal{N}_d, k \in \mathcal{V}$

- \mathcal{B} - the set of container types (i.e., SCLs)

- **Decision Variables**

- x_{ijk}^b - the flow of container type $b \in \mathcal{B}$ on arc $(i, j, k) \in \mathcal{A}$

- **Parameters**

- s_i^b - the supply or available outload of container type $b \in \mathcal{B}$ at depot $i \in \mathcal{N}_s$

- d_j^b - the demand or required throughput of container type $b \in \mathcal{B}$ at port $j \in \mathcal{N}_d$

- u_{ijk} - the maximum number of containers that can be shipped from $i \in \mathcal{N}_s$ to $j \in \mathcal{N}_d$ via $k \in \mathcal{V}$

- c_{ijk}^b - the unit cost of moving container type $b \in \mathcal{B}$ from $i \in \mathcal{N}_s$ to $j \in \mathcal{N}_d$ via mode $k \in \mathcal{V}$.

At this juncture, we can use a standard multicommodity flow problem formulation [4]:

$$\text{Minimize } \sum_{b \in \mathcal{B}} \sum_{(i,j,k) \in \mathcal{A}} c_{ijk}^b x_{ijk}^b \quad (4.6)$$

$$\text{Subject to: } \sum_{j,k:(i,j,k) \in \mathcal{A}} x_{ijk}^b \leq s_i^b \quad \forall i \in \mathcal{N}_s, b \in \mathcal{B} \quad (4.7)$$

$$\sum_{i,k:(i,j,k) \in \mathcal{A}} x_{ijk}^b \geq d_j^b \quad \forall j \in \mathcal{N}_d, b \in \mathcal{B} \quad (4.8)$$

$$\sum_{b \in \mathcal{B}} x_{ijk}^b \leq u_{ijk} \quad \forall (i,j,k) \in \mathcal{A} \quad (4.9)$$

$$x_{ijk}^b \geq 0 \text{ and integer} \quad \forall (i,j,k) \in \mathcal{A}, b \in \mathcal{B} \quad (4.10)$$

Constraints (4.7) and (4.8) are the same balance of flow constraints as in the transportation problem now augmented to deal with each container (commodity) type. These *balance of flow* constraints, which specify that the flow into any node must equal the flow out of any node, will reappear in various forms throughout this development.

This formulation captures much more detail but is also more difficult to solve since the optimal solution to the corresponding linear programming relaxation (i.e., with integrality requirements on the decision variables omitted) might be fractional.

Constraints (4.9) are commonly referred to as *bundle constraints* because they tie together all the container types and limits the flow on an arc (i, j, k) . These capacities should be known from existing contracts with commercial carriers. Although the container types will differ in mass and net explosive weight, they are homogeneous in volume and thus the assumption that every unit of flow of each container type consumes one unit of capacity on each arc is sufficient.

Note that this model is still static and does not capture any congestion effects that are likely to occur at the facilities under heavy loading conditions due to net explosive weight restrictions and processing capabilities. The costs remain linear and general. For example, if the c_{ijk}^b are mean travel times via mode k independent of b , the objective represents maximizing throughput/minimizing deployment makespan. Alternatively, these could be transportation dollar costs.

4.3.2. Toward a Dynamic Plan: Integrating the Temporal-Spatial Network

To make a sequence of transportation decisions over time, we solve the problem on a discrete time dynamic network which is generated by replicating the physical network at each time index in the planning horizon.

Suppose we have T planning *periods* in our horizon. Then decisions can be made at $T+1$ *points* over the horizon with respective indices $t = 0, 1, \dots, T$. Time *period* t for $t = 0, 1, \dots, T-1$ represents the interval $[t, t+1)$ and is of uniform length. Therefore, each node appears $T+1$ times in the dynamic network, denoted (i, t) . Links are likewise denoted (i, j, k, t) and have associated travel times $\tau_{ijk} \geq 0$. Each of these links is a directed arc from node (i, t) to node $(j, t+\tau_{ijk})$. We assume all link travel times are discrete, deterministic, and invariant with time. We re-establish our notation with the following additions or changes:

- **Sets**

\mathcal{N} - the set of all nodes in the CONUS network, each denoted (i, t)

\mathcal{A} - the set of all arcs $(i, j, k, t) : i \in \mathcal{N}_s, j \in \mathcal{N}_d, k \in \mathcal{V}, t = 0, 1, \dots, T$

\mathcal{A}^t - the set of physical arcs (i, j, k) at time period $t = 0, 1, \dots, T$

- **Decision Variables**

x^b_{ijkt} - the flow of container type $b \in \mathcal{B}$ on arc $(i, j, k, t) \in \mathcal{A}$

q^b_{jkt} - the number of containers of type $b \in \mathcal{B}$ enqueued on conveyances of mode $k \in \mathcal{V}$ at port $j \in \mathcal{N}_d$ at the beginning of time period $t = 0, 1, \dots, T$

- **Parameters**

τ_{ijk} - the discrete deterministic travel time from depot $i \in \mathcal{N}_s$ to port $j \in \mathcal{N}_d$ via mode $k \in \mathcal{V}$

s^b_i - the supply or available outload of container type $b \in \mathcal{B}$ at depot $i \in \mathcal{N}_s$ over the *entire* planning horizon

d^b_{jt} - the demand or required delivery of container type $b \in \mathcal{B}$ at port $j \in \mathcal{N}_d$ at time $t = 0, 1, \dots, T$

u_{ijkt} - the maximum number of containers that can be shipped from $i \in \mathcal{N}_s$ to $j \in \mathcal{N}_d$ via $k \in \mathcal{V}$ at time $t = 0, 1, \dots, T$ over the planning horizon

c_{ijk}^b - the unit cost of moving container type $b \in \mathcal{B}$ from $i \in \mathcal{Ns}$ to $j \in \mathcal{Nd}$ via mode $k \in \mathcal{V}$.

Note that the d_{jt}^b establish a minimum container delivery schedule over time for port $j \in \mathcal{Nd}$ determined by a ship loading sequence. Each positive d_{jt}^b represents a quantity of containers of type $b \in \mathcal{B}$ that begin the ship loading process. The form of this parameter is a very important modeling assumption remains throughout our model development. We assume this input is a key output from the strategic deployment planner that has been adjusted in some manner by the network coordinator. In this case, the strategic deployment planner requires extensive data on available containerships and all port pier and berth capabilities.

We also assume that as containers arrive at the port, they become *immediately* available for ship loading (i.e. there is no conveyance loading/unloading or port processing time). Vehicle loading and unloading times at either the depot or port may be neglected or subsumed in the τ_{ijk} . All movement times in the network must be nonzero; if any τ_{ijk} is shorter than the time period used in the planning horizon (an unlikely event), then we require $\tau_{ijk} = 1$.

A couple of other parameter notes are useful here: Positive values of the surplus variable q_{jkt}^b indicate quantities of early containers at the port ready for ship loading. By the definition of the s_{it}^b , we tentatively assume that all containers are pre-stuffed and immediately available for transportation at the depots.

The balance of flows at this stage in the formulation is depicted in the simple time-space network in Figure 4.6. For simplicity, we can consider only one container type and drop the superscript b on all flows. Here there are two modes of transportation which provide regular service between a single depot-port pair.

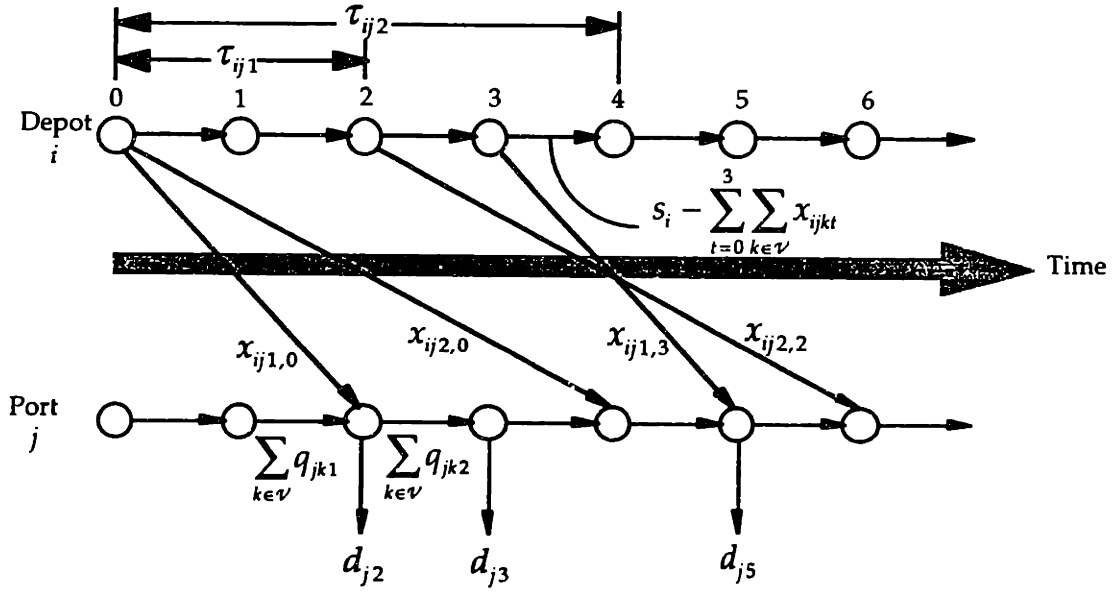

Figure 4.6: Time-Space Network Flows

Thus we may have the following formulation:

$$\text{Minimize } \sum_{t=0}^T \sum_{b \in \mathcal{B}} \sum_{(i,j,k) \in \mathcal{A}'} c_{ijk}^b x_{ijkt}^b \quad (4.11)$$

$$\text{Subject to: } \sum_{t=0}^T \sum_{j,k:(i,j,k) \in \mathcal{A}'} x_{ijkt}^b \leq S_i^b \quad \forall i \in \mathcal{N}_s, b \in \mathcal{B} \quad (4.12)$$

$$\sum_{i \in \mathcal{N}_s} x_{ijk(t-\tau_{ijk})}^b + q_{jk}^b(t-1) - q_{jkt}^b = d_{jt}^b \quad \forall j \in \mathcal{N}_d, b \in \mathcal{B}, t = 0, \dots, T \quad (4.13)$$

$$\sum_{b \in \mathcal{B}} x_{ijkt}^b \leq u_{ijkt} \quad \forall (i, j, k, t) \in \mathcal{A} \quad (4.14)$$

$$x_{ijkt}^b \geq 0 \text{ and integer} \quad \forall (i, j, k, t) \in \mathcal{A}, b \in \mathcal{B} \quad (4.15)$$

$$q_{jt}^b \geq 0 \text{ and integer} \quad \forall j \in \mathcal{N}_d, b \in \mathcal{B}, t = 0, \dots, T \quad (4.16)$$

Constraints (4.12) in this formulation restrict the flow over the entire planning horizon to the supply available at the depots. Constraints (4.13) require the delivery of container quantities prior to their due time. These are the balance of flow constraints.

Constraints (4.14) are the flow capacity (bundle) restrictions which capture available carrier pick-up capacity and frequency. The subscripts on u_{ijkt} denote dependence on depot-port pair, mode, and time. However, the form of these constraints for our problem may vary depending on the planning perspective taken and

real world operational considerations. If the time periods are long enough, we may drop the time dependency and have a constant bundle constraint for shipments at each time period. If the time periods are very granular, we may have positive u_{ijkt} at regular intervals to account for single truck or train arrivals (e.g., the u_{ijkt} will be 1, 2, or 3 for truck arrivals, possibly upwards of 50 or more for trains, and zero at all other times). If each depot has contracted their own transportation, they might have shipment availability independent of destination and the subscript j can be dropped (requiring a summation on j of the x^b_{ijkt}). Finally, these constraints might be dropped altogether in the temporal problem to generate transportation resource requirements at a higher level of planning.

Note that neither travel time nor transportation capacity are affected by utilization in this model. Facility congestion effects are still ignored.

4.3.3. Integrating Internal Capacity Constraints

We proceed towards a more exact model that captures effects we must consider by adding more dimensionality to the nodes in our network. However, throughout this development, we retain the multicommodity network flow structure of the problem and introduce more side constraints to capture unique capacity issues.

4.3.3.1. Intraport Flows

Clearly, an immediately identifiable weakness of our formulation is that it does not account for congestion or processing time at the ports. If the u_{ijkt} are not binding and we have not considered port processing capacity, the inbound container flow may overwhelm the port, causing work backlogs, transportation demurrage costs, and a dangerous accumulation of net explosive weight. The mix of inbound vehicles will also determine how rapidly containers can be made available for ship loading (e.g., containers on rail cars may take longer to unload than transferring a truck chassis to a port cab, or there may be more rail transfer pads than truck transfer pads). Furthermore, container volumes in different areas of the port will be restricted by available infrastructure that determines storage space and allowable net explosive weight. Before introducing additions to our formulation, consider the fact that export containers in the ports are essentially queued in two different areas until they are

needed pierside for stowage: reception areas for inbound conveyances, and internal yard storage pads. As containers are unloaded from trucks or trains, they can be taken to a storage address on a pad within the yard or moved directly to the pier if they are due for ship stowage. However, net explosive weight, volume, and throughput capacities will apply at all areas. Our first set of variables will balance the flow at transportation reception areas:

• **Decision Variables**

y^b_{jkt} - the number of containers of type $b \in \mathcal{B}$ at port $j \in \mathcal{N}$ that are unloaded from conveyances of mode $k \in \mathcal{V}$ at time $t = 0, 1, \dots, T$ and taken to yard storage pads

p^b_{jt} - the number of containers of type $b \in \mathcal{B}$ at port $j \in \mathcal{N}$ that are located on yard storage pads and ready for retrieval for ship loading at time $t = 0, 1, \dots, T$.

The q^b_{jkt} are surplus variables used to balance the inbound container flow on conveyances ($x^{b_{ikt}}$) and the flow of containers to all internal port areas (y^b_{jkt}). The value of y^b_{jkt} in any time period will be restricted by general throughput constraints that are meant to reflect port processing capability. With the d^b_{jt} defined as before to meet an aggregate ship stowage sequence, we achieve a high level decomposition of the port, illustrated in Figure 4.7. Again, to keep the visualization simple we have omitted the container type index.

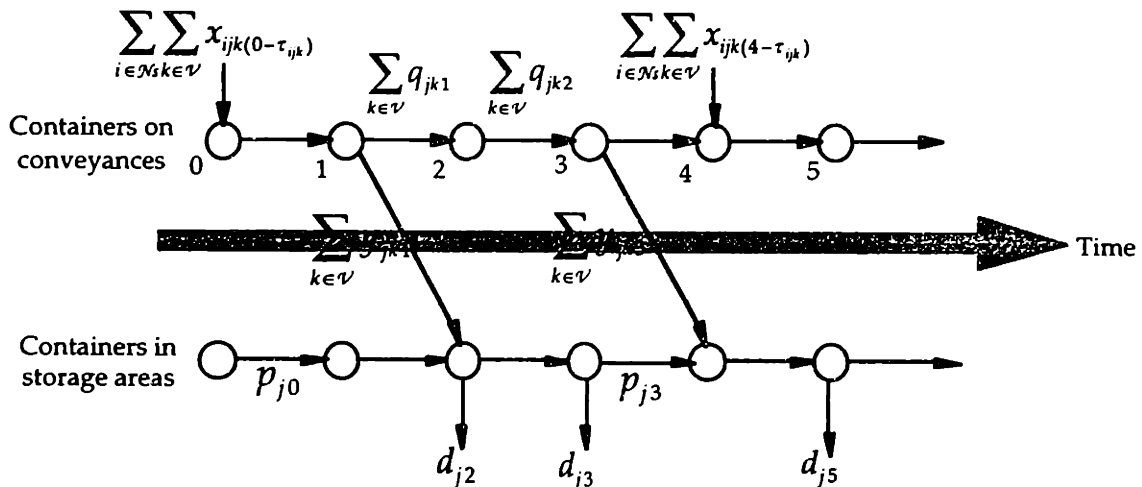

Figure 4.7 Intraport Flows at Port j

Clearly, to balance flows within the port we require:

$$\sum_{i \in \mathcal{N}_s} x_{ijk(t-\tau_{ijk})}^b + q_{jk(t-1)}^b - q_{jkt}^b - y_{jkt}^b = 0 \quad \forall j \in \mathcal{N}_d, k \in \mathcal{V}, b \in \mathcal{B}, \quad (4.17)$$

$$t = 0, \dots, T$$

$$\sum_{k \in \mathcal{V}} y_{jk(t-1)}^b + p_{j(t-1)}^b - p_{jt}^b = d_{jt}^b \quad \forall j \in \mathcal{N}_d, b \in \mathcal{B}, \quad (4.18)$$

$$t = 0, \dots, T$$

We add the following problem data to govern these intraport flows:

- **Parameters**

- μ_{jk} - the maximum number of containers that can be discharged from conveyances of mode $k \in \mathcal{V}$ and moved to internal port areas per time period at port $j \in \mathcal{N}_d$
- n_b - the net explosive weight for container type $b \in \mathcal{B}$
- K_j - the maximum number of containers that can be grounded on storage pads awaiting retrieval at port $j \in \mathcal{N}_d$
- η_j - the maximum allowable accumulation of net explosive weight on storage pads at port $j \in \mathcal{N}_d$
- f_{jk} - the average demurrage or detention costs per container per time period enqueued on conveyances of type $k \in \mathcal{V}$ waiting to be off-loaded at port $j \in \mathcal{N}_d$.

Assume for now that all costs in our objective are monetary and are incurred from utilization of commercial transportation. At this stage, we have a formulation that looks like the following:

$$\text{Minimize} \quad \sum_{t=0}^T \left(\sum_{b \in \mathcal{B}} \sum_{(i,j,k) \in \mathcal{A}^t} c_{ijk}^b x_{ijkt}^b + \sum_{j \in \mathcal{N}_d} \sum_{k \in \mathcal{V}} f_{jk} \sum_{b \in \mathcal{B}} q_{jkt}^b \right) \quad (4.19)$$

$$\text{Subject to:} \quad \sum_{t=0}^T \sum_{j,k:(i,j,k) \in \mathcal{A}^t} x_{ijkt}^b \leq s_i^b \quad \forall i \in \mathcal{N}_s, b \in \mathcal{B} \quad (4.12)$$

$$\sum_{i \in \mathcal{N}_i} x_{ijk(t-\tau_{jk})}^b + q_{jk(t-1)}^b - q_{jkt}^b - y_{jkt}^b = 0 \quad \forall j \in \mathcal{N}_d, k \in \mathcal{V}, b \in \mathcal{B}, \quad (4.17)$$

$$t = 0, \dots, T$$

$$\sum_{k \in \mathcal{V}} y_{jk(t-1)}^b + p_{j(t-1)}^b - p_{jt}^b = d_{jt}^b \quad \forall j \in \mathcal{N}_d, b \in \mathcal{B}, \quad (4.18)$$

$$t = 0, \dots, T$$

$$\sum_{b \in \mathcal{B}} x_{ijkt}^b \leq u_{ijkt} \quad \forall (i, j, k, t) \in \mathcal{A} \quad (4.14)$$

$$\sum_{b \in \mathcal{B}} y_{jkt}^b \leq \mu_{jk} \quad \forall j \in \mathcal{N}_d, k \in \mathcal{V}, b \in \mathcal{B}, \quad (4.20)$$

$$t = 0, \dots, T$$

$$\sum_{b \in \mathcal{B}} n_b p_{jt}^b \leq \eta_j \quad \forall j \in \mathcal{N}_d, t = 0, \dots, T \quad (4.21)$$

$$\sum_{b \in \mathcal{B}} p_{jt}^b \leq K_j \quad \forall j \in \mathcal{N}_d, t = 0, \dots, T \quad (4.22)$$

$$\text{All flows } x_{ijkt}^b, q_{jkt}^b, y_{jkt}^b, p_{jt}^b \geq 0 \text{ and integer.} \quad (4.23)$$

The first four constraints are balance of flow equations previously discussed. Constraints (4.14) are the usual transportation capacities, constraints (4.20) are the port throughput constraint, and constraints (4.21) and (4.22) are port container storage NEW and volume restrictions, respectively. For the sake of simplicity, we've omitted an upper bound on the q_{jkt}^b to allow conveyances to queue beyond the port perimeter if necessary. However, we penalize the length of this queue with a linear cost function per unit time to model delay fees that the DoD often incurs in holding commercial conveyances until they can be unloaded.

There are a number of assumptions inherent in this formulation. First, we assume that the μ_j are parameters that can be estimated from historical port data, a port simulation, or some analytical model that captures the throughput capabilities of the port. We also assume that there is *full selectivity* among all containers queued at any location within the port. Third, there is no distinction made among container types for handling within the port except for net explosive weight magnitudes (not classes). Finally, and most importantly, the model formulation assumes all intraport flows are feasible when disaggregated. In other words, although ports obviously have many rail spurs, transfer pads, yard storage pads, and multiple piers for ship berthing, we've chosen to model all of these in two very aggregate areas. Feasible container flows for the aggregate model may be infeasible when multiple smaller areas with different

capacities are considered. Again, more dimensionality could be added to explicitly separate these areas, but at the expense of additional complexity. This might be better checked by a port simulation model that incorporates stochasticity.

4.3.3.2. Intradepot Flows

Now that we have considered port operating capability, we turn our attention to container outloading capacity at the depots. Our current formulation would be correct if the entire war reserve stock at each depot were completely containerized and immediately available for transportation. However, the large majority of war reserve stock is stored in hardened igloos dispersed throughout many acres in a depot and the availability of containers and/or secure pad space limits the number of containers that can be pre-stuffed and made ready for transportation at any time. The entire supply of containerized munitions at a depot is not immediately available as we have modeled it. We must therefore include in our model the schedule of container stuffing and releases to transportation for each depot. Consider the following additions to decompose the depot set one level as we did with the ports:

- **Decision Variables**

r_{it}^b - the number of containers of type $b \in \mathcal{B}$ loaded and ready for transportation at depot $i \in \mathcal{Ns}$ at time $t = 0, 1, \dots, T$

w_{it}^b - the number of containers of type $b \in \mathcal{B}$ stuffed and delivered to staging pads for transportation at depot $i \in \mathcal{Ns}$ at time $t = 0, 1, \dots, T$

The inventory of loaded and ready containers is then used to balance the container production flow with the outbound transportation flow. We have the following new balance of flow equations:

$$\sum_{t=0}^T w_{it}^b \leq s_i^b \quad \forall i \in \mathcal{Ns}, b \in \mathcal{B} \quad (4.24)$$

$$w_{i(t-1)}^b + r_{i(t-1)}^b - r_{it}^b - \sum_{j,k:(i,j,k) \in \mathcal{A}^t} x_{ijkt}^b = 0 \quad \forall i \in \mathcal{Ns}, b \in \mathcal{B}, t = 0, \dots, T \quad (4.25)$$

The “travel time” for container loading flow is a single time period (as for container unloading flow at the ports). Therefore, the w_{it}^b establish a profile of work loads in each time period required to make containers available in the next period. Since the stock composition of a load determines the amount of time required to pick the stock, inspect it, stuff the container, etc., the depot will be tasked with scheduling this work appropriately off of the due times. Given an aggregate enough time period in the planning horizon, we can constrain this flow to model outloading capabilities at each depot. Finally, we employ the following parameters to govern the intradepot flows:

- **Decision Variables**

- λ_i - the maximum container production rate for depot $i \in \mathcal{N}_s$
- η_i - the maximum allowable accumulation of net explosive weight in queued loaded containers awaiting transportation at depot $i \in \mathcal{N}_s$
- K_i - the maximum allowable number of queued loaded containers at depot $i \in \mathcal{N}_s$.

These parameters parallel those of the previous section used to model port throughput. We are assuming as in the port model that the λ_i is a known capability or can be approximated with an appropriate model. We then have a problem statement that captures container transportation flows as well as intrafacility flows and their respective restrictions in the aggregate:

$$\text{Minimize} \quad \sum_{t=0}^T \left(\sum_{b \in \mathcal{B}} \sum_{(i,j,k) \in \mathcal{A}'} c_{ijk}^b x_{ijkt}^b + \sum_{j \in \mathcal{N}_d} \sum_{k \in \mathcal{V}} f_{jk} \sum_{b \in \mathcal{B}} q_{jkt}^b \right) \quad (4.19)$$

$$\text{Subject to:} \quad \sum_{t=0}^T w_{it}^b \leq s_i^b \quad \forall i \in \mathcal{N}_s, b \in \mathcal{B} \quad (4.24)$$

$$w_{i(t-1)}^b + r_{i(t-1)}^b - r_{it}^b - \sum_{j,k:(i,j,k) \in \mathcal{A}'} x_{ijkt}^b = 0 \quad \forall i \in \mathcal{N}_s, b \in \mathcal{B}, t = 0, \dots, T \quad (4.25)$$

$$\sum_{i \in \mathcal{N}_s} x_{ijk(t-\tau_{ijk})}^b + q_{jk(t-1)}^b - q_{jkt}^b - y_{jkt}^b = 0 \quad \forall j \in \mathcal{N}_d, k \in \mathcal{V}, b \in \mathcal{B}, t = 0, \dots, T \quad (4.17)$$

$$\sum_{k \in \mathcal{V}} y_{jk(t-1)}^b + p_{j(t-1)}^b - p_{jt}^b = a_{jt}^b \quad \forall j \in \mathcal{N}_d, b \in \mathcal{B}, t = 0, \dots, T \quad (4.18)$$

$$\sum_{b \in \mathcal{B}} w_{it}^b \leq \lambda_i \quad \forall i \in \mathcal{Ns}, t = 0, \dots, T \quad (4.26)$$

$$\sum_{b \in \mathcal{B}} x_{ijkt}^b \leq u_{ijkt} \quad \forall (i, j, k, t) \in \mathcal{A} \quad (4.14)$$

$$\sum_{b \in \mathcal{B}} y_{jkt}^b \leq \mu_{jk} \quad \forall j \in \mathcal{Nd}, k \in \mathcal{V}, b \in \mathcal{B}, \quad (4.20)$$

$$t = 0, \dots, T$$

$$\sum_{b \in \mathcal{B}} n_b r_{it}^b \leq \eta_i \quad \forall i \in \mathcal{Ns}, t = 0, \dots, T \quad (4.27)$$

$$\sum_{b \in \mathcal{B}} r_{it}^b \leq K_i \quad \forall i \in \mathcal{Ns}, t = 0, \dots, T \quad (4.28)$$

$$\sum_{b \in \mathcal{B}} n_b p_{jt}^b \leq \eta_j \quad \forall j \in \mathcal{Nd}, t = 0, \dots, T \quad (4.21)$$

$$\sum_{b \in \mathcal{B}} p_{jt}^b \leq K_j \quad \forall j \in \mathcal{Nd}, t = 0, \dots, T \quad (4.22)$$

$$\text{All flows } w_{it}^b, r_{it}^b, x_{ijkt}^b, q_{jkt}^b, y_{jkt}^b, p_{jt}^b \geq 0 \text{ and integer.} \quad (4.29)$$

The modifications in this formulation are the addition of balance of flow constraints (4.24) and (4.25), and intradepot capacity constraints (4.26), (4.27) and (4.28). As containers complete stuffing, they are queued on pads immediately adjacent to loading areas at depots. It is unclear whether or not separate loading areas are maintained for each outbound mode of transportation. Therefore, to keep matters simple, we maintain one aggregate storage area within NEW and volume constraints for each depot (constraints (4.26) and (4.27)). If necessary, these inventories could be split by mode as in the intraport flows. Since vehicles that are being loaded are in the same area with the containerized inventory, we still include loading times in the τ_{ijk} and do not update these inventories until a vehicle departure.

4.3.4. Other Potential Model Details

As we have shown, the flexibility of our multicommodity network flow approach allows the incorporation of many new model details without changing the basic structure of the problem formulation: a linear cost function with balance of flow and side constraints. Other operational considerations can often easily be translated into a mathematical representation and included in the model to evaluate their effect on container flows.

4.3.4.1. Minimization of Pipeline Inventory

As discussed in the first three chapters, safety is of paramount concern in handling munitions containers. Unlike munitions stored in hardened bunkers, containerized munitions will likely deliver much more destruction in the event of a detonation since they must be stored in the open. Although facility infrastructure arc limits determine strict upper bounds on accumulations of NEW, more safety can always be achieved with less NEW in the network. This consideration could be modeled with an objective function term in the form:

$$\text{Minimize} \quad \sum_{t=0}^T g \sum_{b \in \mathcal{B}} n_b \left[\sum_{i \in \mathcal{N}_s} r_{it}^b + \sum_{j \in \mathcal{N}_d} \left(\sum_{k \in \mathcal{V}} q_{jkt}^b + p_{jt}^b \right) \right], \quad (4.30)$$

where g is a safety penalty or cost in dollars of net explosive weight in the network in any time period. This value would be difficult to estimate in practice but its inclusion in the model would allow the planner to evaluate trade-offs in safety and large amounts of container storage and pre-staging in the network. Objective (4.30) is in a very simple form: it treats NEW at any storage location the same and does not include NEW in transit between facilities.

4.3.4.2. Activating Excess Capacity: Outload at Lower Tier Facilities

Suppose war reserve stocks at the Tier I and Tier II depots are not divided into $< C+30$ and $> C+30$ classifications and we are simply told that Tier II depots are not staffed for follow-on sustainment outload during peacetime. Our model could be used to determine when Tier II depots would have to support the flow during a contingency, which of these depots are used, and at what levels. Their idle capacity and additional inventories are available if the contingency's demands exceed the supply at the primary facilities. We can introduce these considerations into our problem by first partitioning the source facility set:

- Sets

\mathcal{N}_s - the set of primary depots (i.e., Tier I) that are fully staffed and active for follow-on sustainment outloading: $\mathcal{N}_s \subseteq \mathcal{N}_s$

\mathcal{N}_{SII} - the set of secondary depots (i.e., Tier II) that have capacity and inventory that can be activated if the need arises: $\mathcal{N}_S \setminus \mathcal{N}_{SI} = \mathcal{N}_{SII}$.

We can model this decision as a fixed cost problem, with the total cost of activity at Tier II depots equaling the sum of a variable cost related to the level of production and possibly a fixed cost necessary to initiate activity. Consider also then the following:

- **Parameters**

a_i - the average cost per container of work at depot $i \in \mathcal{N}_{SII}$

h_i - the fixed cost incurred for using depot $i \in \mathcal{N}_{SII}$ for outloading

To model the use of secondary depots, we introduce a new *binary contingent* decision variable:

$$z_i = \begin{cases} 1 & \text{if } \sum_{t=0}^T \sum_{b \in \mathcal{B}} w_{it}^b \geq 0; \\ 0 & \text{otherwise,} \end{cases} \quad \forall i \in \mathcal{N}_{SII} \quad (4.31)$$

Finally, we introduce one more parameter. Let M be a large positive number that exceeds the maximum feasible value of any total container loading work done for any depot. Then adding the constraints,

$$\sum_{t=0}^T \sum_{b \in \mathcal{B}} w_{i,t}^b \leq Mz_i \quad \forall i \in \mathcal{N}_{SII}, t = 0, \dots, T, \quad (4.32)$$

to our formulation will ensure that $z_i = 1$ rather than zero whenever there is a positive workload on depot $i \in \mathcal{N}_{SII}$. Although this is a correct integer programming formulation, in a linear relaxation the z_i can take on any non-negative fractional value less than one and it is unlikely that enough of the fixed cost will be absorbed. Instead, in an LP relaxation, since we know that

$$\sum_{b \in \mathcal{B}} w_{it}^b \leq \lambda_i \quad \forall i \in \mathcal{N}_S, t = 0, \dots, T, \quad (4.26)$$

it is more appropriate to modify these constraints for Tier II depots to the form

$$\sum_{b \in \mathcal{B}} w_{it}^b \leq \lambda_i z_i \quad \forall i \in \mathcal{Ns}_{II}, t = 0, \dots, T. \quad (4.33)$$

Although this introduces more constraints into the formulation, we will get a nonzero value of z_i much closer to 1, especially under heavy demand conditions. Assuming that the variable cost is roughly proportional to workload, our objective is (4.34), where both the maximum level of output desired and total work are penalized:

$$\text{Minimize} \quad \sum_{i \in \mathcal{Ns}_{II}} \left(h_i z_i + a_i \sum_{t=0}^T \sum_{b \in \mathcal{B}} w_{it}^b \right). \quad (4.34)$$

4.3.4.3. Relaxing Late Deliveries

For our last detail to consider in modifying the model, recall that schedule objectives created at the mobilization planning level are necessarily loose and must be coordinated with those produced in the strategic deployment planning function. Thus far, the formulation has a strict demand profile which must be met. However, suppose we allow containers to arrive up to a predetermined number of planning periods late for their due time for ship stowage at a cost. The amount of allowable slack in the demand suspenses will of course be determined in large part by the length of the planning periods used. For a given amount of acceptable delay, longer time periods imply fewer allowable delay periods. To demonstrate, suppose we allow container flows to arrive up to two planning periods behind the closure profile. We employ the following notation:

- **Decision Variables**

l_{jt}^b - the number of containers of type $b \in \mathcal{B}$ which arrive on schedule at port $j \in \mathcal{Nd}$ at time $t = 0, \dots, T$

l_{jt}^b - the number of containers of type $b \in \mathcal{B}$ which arrive one period late at port $j \in \mathcal{Nd}$ at time $t = 0, \dots, T$

l''_{jt} - the number of containers of type $b \in \mathcal{B}$ which arrive two periods late at port $j \in \mathcal{Nd}$ at time $t = 0, \dots, T$

- Parameters

m - the per container cost of a delivery one period late.

If a price coordination approach is used to achieve independence among subproblems in our planning hierarchy, the value of m might be a coordinated input from the deliberate planning network coordinator. We can introduce these late container flows at the last stage in the port by dividing it as in Figure 4.8.

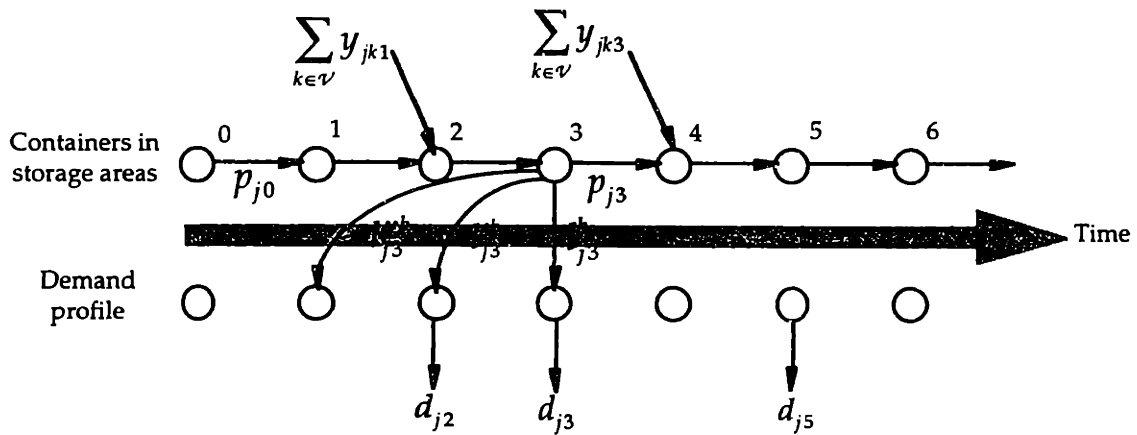

Figure 4.8: Late Container Flows

Likewise, conservation of flow is maintained by constraints (4.35) and (4.36):

$$\sum_{k \in \mathcal{V}} y_{jk(t-1)}^b + p_{j(t-1)}^b - p_{jt}^b - l_{jt}^b - l'_{jt}{}^b - l''_{jt}{}^b = 0 \quad \forall j \in \mathcal{Nd}, k \in \mathcal{V}, b \in \mathcal{B}, \quad (4.35)$$

$$t = 0, \dots, T$$

$$l_{jt}^b + l'_{j(t+1)}{}^b + l''_{j(t+2)}{}^b = d_{jt}^b \quad \forall j \in \mathcal{Nd}, b \in \mathcal{B}, \quad (4.36)$$

$$t = 0, \dots, T.$$

Then, we incorporate into the objective function the term (4.37), where ε is any positive constant:

$$\text{Minimize} \quad \sum_{t=0}^T \sum_{j \in \mathcal{N}^d} \sum_{b \in \mathcal{B}} m l_{jt}^{lb} + (2m + \varepsilon) l_{jt}^{rb}. \quad (4.37)$$

4.3.5. Summary

The additional modeling considerations we have introduced in these sections demonstrate the flexibility and power in the multicommodity temporal-spatial network flow approach. In fact, it is so versatile that it is *fundamental* to all transportation optimization problems. As the model is extended to operational use and its structure is refined, new variables and constraints can be added without changing the basic structure of the formulation. The model's output includes the detailed movement decisions, and as a by-product of the solution process, the shadow prices that imply the relative value of constraining resources throughout the network.

Of course, there are some inherent weaknesses in this approach. First and foremost, there are no provisions for handling stochasticity, which is a major facet of a network of queues and flows. It has been shown that optimal solutions to deterministic models can provide significantly worse results than approximate solutions to stochastic models [49]. Uncertainties in the problem parameters can only be addressed through sensitivity analysis. Second, the current model does not capture deliveries from vendor facilities, which for *all* DoD logistics can be approximately one third of the flow. Third, the model does not address the handling and compatibility requirements implied by the assignment of NEW classes to munitions containers. Even if these were known, their incorporation would severely complicate the model by, for example, requiring the disaggregation of port storage into areas representing different NEW classes. Finally, the model is unidirectional. It does not handle the delivery of retrograde loaded and empty containers from the ports back to the depots as outloading is being carried out. Nor does it account for distributing munitions grade containers as a constraining resource. Ostensibly, these issues could be handled by further additions and modifications to the problem formulation.

4.4. Model Implementation

The major hurdle in implementing any optimization model is gathering valid data that can be translated into the problem parameters: the objective function coefficients, the constraint coefficients, and the right-hand sides of the mathematical programming model [13]. This effort is further complicated in this application by security issues, the number of organizations involved in the sustainment munitions transportation mission, and the chronic absence of valid operational data in practice. Such a model can be developed for effective operational use only when AIT and TAV are fully integrated into DoD logistics and there is strong interagency support for the development of a decision support tool.

Thus, the objective of this section is to discuss the implementation and solution of the model on a computer to demonstrate a *capability*, not to provide real solutions. Although some of the data was aggregated from actual (albeit dated) DoD documents, much of it was estimated or randomly generated. Next, we perform some informal scenario analysis that suggests the model's capability to answer strategic questions (i.e., for resource planning).

4.4.1. Problem Test Case

The formulation implemented is the following:

$$\text{Minimize} \quad \sum_{t=0}^T \left(\sum_{b \in \mathcal{B}} \sum_{(i,j,k) \in \mathcal{A}'} c_{ijk}^b x_{ijkt}^b + \sum_{j \in \mathcal{N}d} \sum_{k \in \mathcal{V}} f_{jk} \sum_{b \in \mathcal{B}} q_{jkt}^b + g \sum_{b \in \mathcal{B}} n_b \left[\sum_{i \in \mathcal{N}s} r_{it}^b + \sum_{j \in \mathcal{N}d} \left(\sum_{k \in \mathcal{V}} q_{jkt}^b + p_{jt}^b \right) \right] \right) \quad (4.38)$$

$$\text{Subject to:} \quad \sum_{t=0}^T w_{it}^b \leq s_i^b \quad \forall i \in \mathcal{N}s, b \in \mathcal{B} \quad (4.24)$$

$$w_{i(t-1)}^b + r_{i(t-1)}^b - r_{it}^b - \sum_{j,k:(i,j,k) \in \mathcal{A}'} x_{ijkt}^b = 0 \quad \forall i \in \mathcal{N}s, b \in \mathcal{B}, t = 0, \dots, T \quad (4.25)$$

$$\sum_{i \in \mathcal{N}s} x_{ijk(t-\tau_{ijk})}^b + q_{jk(t-1)}^b - q_{jkt}^b - y_{jkt}^b = 0 \quad \forall j \in \mathcal{N}d, k \in \mathcal{V}, b \in \mathcal{B}, t = 0, \dots, T \quad (4.17)$$

$$\sum_{k \in \mathcal{V}} y_{jk(t-1)}^b + p_{j(t-1)}^b - p_{jt}^b = d_{jt}^b \quad \forall j \in \mathcal{N}d, b \in \mathcal{B}, t = 0, \dots, T \quad (4.18)$$

$$\sum_{b \in \mathcal{B}} w_{it}^b \leq \lambda_i \quad \forall i \in \mathcal{Ns}, t = 0, \dots, T \quad (4.26)$$

$$\sum_{b \in \mathcal{B}} y_{jkt}^b \leq \mu_{jk} \quad \forall j \in \mathcal{Nd}, k \in \mathcal{V}, b \in \mathcal{B}, \quad (4.20)$$

$$t = 0, \dots, T$$

$$\sum_{b \in \mathcal{B}} n_b r_{it}^b \leq \eta_i \quad \forall i \in \mathcal{Ns}, t = 0, \dots, T \quad (4.27)$$

$$\sum_{b \in \mathcal{B}} n_b p_{jt}^b \leq \eta_j \quad \forall j \in \mathcal{Nd}, t = 0, \dots, T \quad (4.21)$$

$$\text{All flows } w_{it}^b, r_{it}^b, x_{ijkt}^b, q_{jkt}^b, y_{jkt}^b, p_{jt}^b \geq 0 \text{ and integer.} \quad (4.29)$$

Thus, the objective function accounts for transportation, demurrage, and safety costs. We neglect intrafacility container volume constraints and bounds on transportation flows as these are impossible to estimate without more data. Instead of forcing the model to decide the allocation of flow among Tier I and Tier II depots, an external scenario variable in the code is set so that all Tier I depots and Anniston (see Figure 4.5) are used.

Since the number of container types used in practice is probably quite large and their characteristics are unknown, we employ a set of 23 notional containers developed and employed by Straight [58] in a computer simulation model of Concord NWS to represent this population. The frequency distribution of these containers, which range from 0.05 to 16.20 short tons of NEW (1 STON = 2,000 lb.), is shown in Figure 4.9. For each container type (sorted by NEW), the loaded container NEW is plotted alongside the shipping weight, both in STONs, in Figure 4.10. Note that there appears to be little relationship between weight and NEW. (Straight also specifies one of four different NEW classes for each of these containers, but we do not use these).

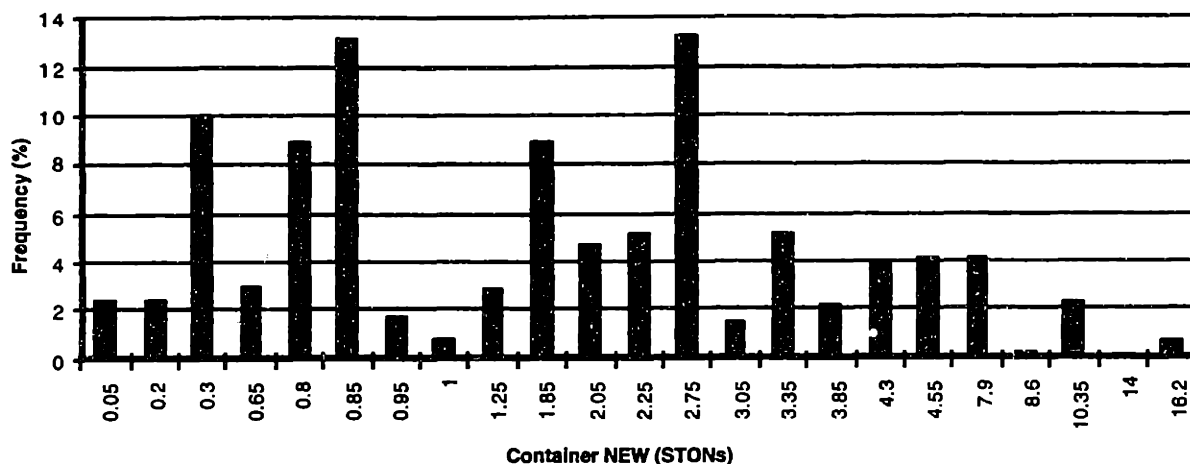

Figure 4.9: Notional Container Distribution by NEW in Short Tons

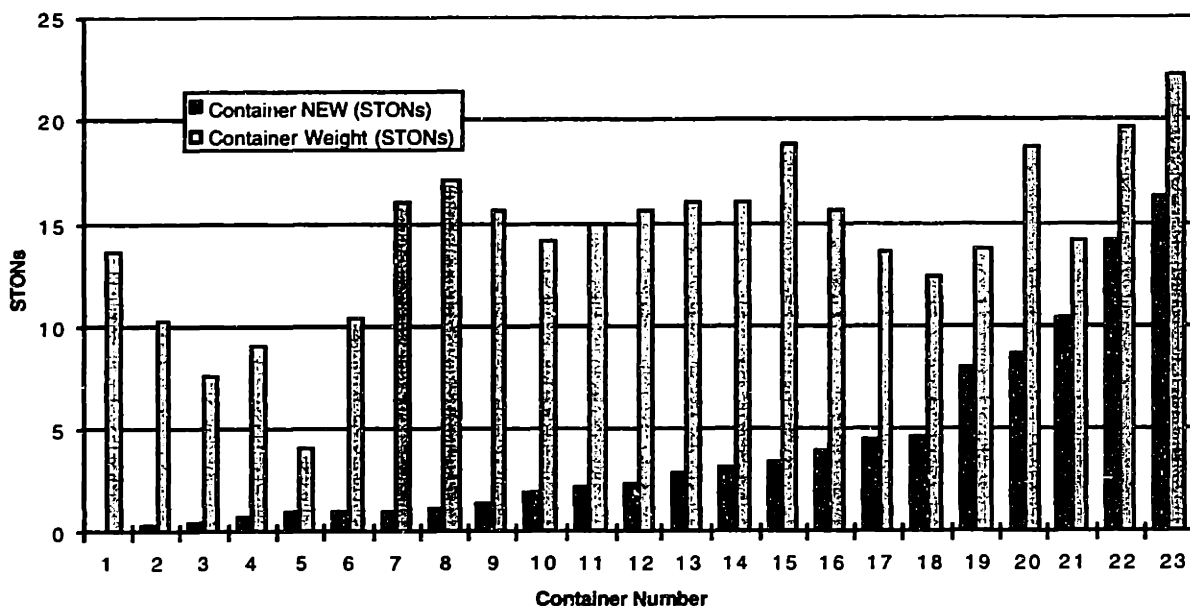

Figure 4.10: Notional Container NEWs and Shipping Weights in Short Tons

The dynamic demand profile of containers at each of the ports is a very difficult data set to estimate. As previously discussed, this would be a coordinated output of the strategic deployment planning function if the planning hierarchy follows that of Figure 4.3. It is a function of the crisis scenario, MSC sealift capacity and schedules, advance stow plans, and port pier and berth capabilities. For our initial application, we assume a worst case (dual MRC) scenario with sustained heavy outloading. That is, once outloading commences at each port, the quantity of containers demanded in each period is constant for each port and equal to the MRS BURU required throughput.

This quantity is broken down into individual container types according to the notional container distribution and assigned to depot supply. An external variable in the code determines the amount of slack in supply above and beyond the containers in demand that is assigned to the depots. Since we are not interested in stock levels as a binding constraint for an outload, this variable is set sufficiently high (total supply is equal to three times total demand).

Next, the total munitions supply available in the model is allocated to the depots according to *total* munitions tonnage stored at the Tier I and Tier II depots in 1994 as per the IASMP [24]. This distribution is represented in Figure 4.11. If only the Tier I depots (and Anniston) are used in the optimization, their stock shares are scaled up based on their share of the total Tier I stock. Due to the complexity of issues involved in how munitions stocks are distributed among the depots in practice, each container of each type available in the model is randomly assigned to one of the depots based solely on the distribution in Figure 4.11.

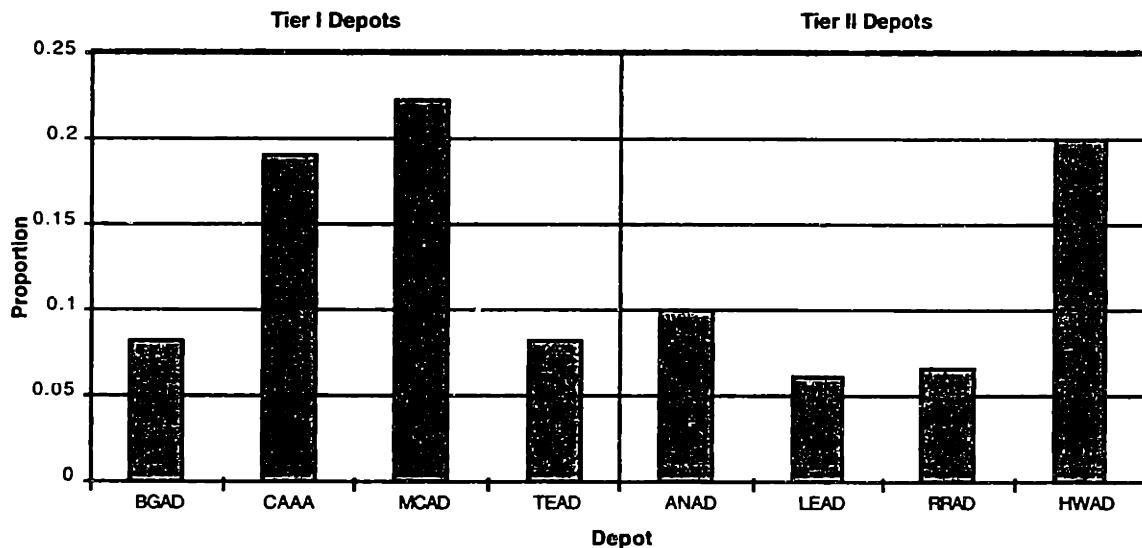

Figure 4.11: Sustainment Munitions Stock Distribution Used

The total available conveyance throughput per period at each port is assigned to match MRS BURU requirements. This throughput is then partitioned into a quantity of containers on rail based modes and a quantity of containers by truck to reflect port

processing infrastructure. Since the great majority of sustainment munitions volume has been handled by rail transportation in the past, this division is initially estimated at 80 percent by rail and 20 percent by truck for each port (except for Hadlock, where there is no rail access [53]). Likewise, the available depot container output is assigned according to Army Strategic Mobility Plan forecasts, except for Anniston which is given an output rate of 260 containers per day to allow sufficient depot processing capability in the test case.

Container net explosive weight capacities were unavailable and therefore set at an arbitrarily high level for the depots (500 STONs). Port container NEW limits were set sufficiently high to be non-binding. This was done to see what level of NEW would be used in a minimum cost transportation plan.

Transportation cost is a simple linear function of distance in the model. First, interfacility highway distances were found for each depot-port pair as per MTMCTEA Ref. 94-700-2 [39]. These distances, applied to each mode, were multiplied by the container type weight and a mode specific rate to establish a rough cost table (e.g., \$0.06 per STON*mile for truck, \$0.04 for rail). This is another great oversimplification; transportation costs, even for a single carrier, can be very complicated. Weight and/or volume discounts are usually offered and distance is often a much less important factor in costs than the internal structure of the carrier's freight network. Furthermore, different railroad and trucking companies serve different depot-port pairs. Although the model incorporates demurrage and safety costs, these are initially set to zero.

To keep the problem size modest, the test case model uses seven days of heavy dual MRC port outloading divided into eight hour shifts. Lead time until port outloading begins is initially set to four days. Round the clock operations are assumed. Also, to simplify problem solution, we assume flow volumes in eight hour periods will be sufficiently high to allow fractional variables for the test case.

The model was generated via a program written in the GAMS release 3.0^{*} language and its linear relaxation was solved by CPLEX 5.0 network simplex and simplex algorithms. GAMS allows the user to input model parameters in simple list and table formats and define the decision variables, constraints, and objective functions symbolically. Upon compilation, GAMS enters the *pre-processing* phase: it generates all

* See <http://www.gams.com>

model data and translates the model into the representation required by the solver system. Debugging and comprehension aids are produced and written to output files. GAMS verifies that there are no inconsistent bounds or unacceptable values in the problem. GAMS then passes control to the solver and waits for completion; periodically reporting on the status of the solution process. The solver either finds an optimal solution, reports an infeasible or unbounded problem, or halts due to set computation time or iteration limits. GAMS then enters the post processing phase, loading solution values (primal and dual for all variables and constraints) back into the GAMS database. User code then determines how this data is aggregated and written to additional output files; a row by row and column by column listing of the solution is provided by default.

This test case model consists of approximately 57,800 variables and 13,700 constraints, with an underlying network of approximately 8,000 nodes and 44,300 arcs. Solution run times on a Sun Sparcstation 20 Model 60 workstation were approximately two hours.

4.4.2. Scenario Analysis for Resource (Strategic) Planning

Although the model formulated in this chapter is for deliberate (tactical) planning, scenario analysis can be used to facilitate resource (strategic) planning. In this section, we demonstrate the model's capability to answer these kinds of questions by examining how a set of optimal plan characteristics vary with changes in the problem parameters. Specifically, we are interested in both local and system wide effects of changes in:

- **Network factors**
 - **Transportation service:** What if a new mode of transportation, such as premium intermodal rail service in addition to general merchandise rail freight, is used?
 - **Lead time:** What if lead time until port outloading is reduced?

- **Depot factors**
 - **Containerization capability:** What if there are shortfalls in depot outloading rates?

- **Port factors**
 - **Mode input mix:** What if port infrastructure supports a mode mix different from those described above?
 - **Conveyance throughput:** What if container discharge operations from inbound transportation is faster or slower than MRS BURU required output levels?
 - **Containerization capabilities:** What if munitions storage and container stuffing (depot) operations could be introduced at a port?

The following optimal plan characteristics were selected for evaluation:

- **Mode mix:** The percentage that each mode constitutes of total network flow, outbound from each depot, and inbound to each port.

- **Supply-demand assignments:** For each port, the percentage of demand satisfied by each depot.

- **Depot average utilization levels:** For each depot, the total number of containers stuffed and made ready for transportation divided by the maximum number possible in the planning horizon.

- **Depot container maximum and average NEW levels:** For each depot, the maximum container NEW reached in any planning period and the average container NEW across the planning horizon.

- **Port demurrage levels:** For each port, by mode, the total number of containers in all periods delayed from transfer from conveyance to storage.

- **Port container maximum and average NEW levels:** For each port, the maximum storage area NEW reached in any planning period and the average container NEW across the planning horizon.

These responses are defined mathematically as follows:

$$\text{System Mode Mix: } \frac{\sum_{b \in \mathcal{B}} \left(\sum_{(i,j,t):(i,j,k,t) \in \mathcal{A}} x_{ijkt}^b \right)}{\sum_{i \in \mathcal{D}} \left(\sum_{(i,j,k,t) \in \mathcal{A}} x_{ijkt}^b \right)} \quad \forall k \in \mathcal{V} \quad (4.39)$$

$$\text{Depot Outbound Mode Mix: } \frac{\sum_{b \in \mathcal{B}} \left(\sum_{j,t:(i,j,k,t) \in \mathcal{A}} x_{ijkt}^b \right)}{\sum_{b \in \mathcal{B}} \left(\sum_{j,k,t:(i,j,k,t) \in \mathcal{A}} x_{ijkt}^b \right)} \quad \forall i \in \mathcal{N}_s, k \in \mathcal{V} \quad (4.40)$$

$$\text{Port Inbound Mode Mix: } \frac{\sum_{b \in \mathcal{B}} \left(\sum_{i,t:(i,j,k,t) \in \mathcal{A}} x_{ijkt}^b \right)}{\sum_{b \in \mathcal{B}} \left(\sum_{i,k,t:(i,j,k,t) \in \mathcal{A}} x_{ijkt}^b \right)} \quad \forall j \in \mathcal{N}_d, k \in \mathcal{V} \quad (4.41)$$

$$\text{Supply-Demand Assignment: } \frac{\sum_{b \in \mathcal{B}} \left(\sum_{k,t:(i,j,k,t) \in \mathcal{A}} x_{ijkt}^b \right)}{\sum_{t=0}^T \sum_{b \in \mathcal{B}} d_{jt}^b} \quad \forall j \in \mathcal{N}_d, i \in \mathcal{N}_s \quad (4.42)$$

$$\text{Depot Average Utilization: } \frac{\sum_{t=0}^T \sum_{b \in \mathcal{B}} w_{it}^b}{T \lambda_i} \quad \forall i \in \mathcal{N}_s \quad (4.43)$$

$$\text{Depot Average NEW: } \frac{\sum_{t=0}^T \sum_{b \in \mathcal{B}} n_b r_{it}^b}{T} \quad \forall i \in \mathcal{N}_s \quad (4.44)$$

$$\text{Depot Maximum NEW: } \max_t \sum_{b \in \mathcal{B}} n_b r_{it}^b \quad \forall i \in \mathcal{N}_s \quad (4.45)$$

$$\text{Port Demurrage: } \sum_{t=0}^T \sum_{b \in \mathcal{B}} q_{jkt}^b \quad \forall j \in \mathcal{N}d, k \in \mathcal{V} \quad (4.46)$$

$$\text{Port Average NEW: } \frac{\sum_{t=0}^T \sum_{b \in \mathcal{B}} n_b p_{jt}^b}{T} \quad \forall j \in \mathcal{N}d \quad (4.47)$$

$$\text{Port Maximum NEW: } \max_t \sum_{b \in \mathcal{B}} n_b p_{jt}^b \quad \forall j \in \mathcal{N}d. \quad (4.48)$$

Since the model parameters are estimated and our goal is to simply gain some insight into model behavior and potential system trade-offs, our experimental design is a very informal screening. Nine model runs were performed, each representing a *single factor variation*. The “base” model includes the premium rail transportation service priced between general merchandise rail and truck rates (at \$0.05/STON*mile). To evaluate the addition of this service, another model run was accomplished with premium rail service priced out (i.e., given a very high cost coefficient). The other plan characteristics described above were *not* evaluated in this experiment. Then, using the “base” model as the standard for comparison, these responses were charted for eight additional runs designed to investigate the other factor changes described above. These charts are reproduced in Appendix A. Exact numerical outputs are not so important to analyze as are *relative* values and changes in these responses with changes in the problem parameters. It is also important to remember that all plan characteristics are the result of meeting the port schedule at *minimum transportation cost*, and that any optimal plan is not necessarily unique. We discuss plan characteristics for the base scenario and then evaluate significant changes in these values for each experiment.

4.4.2.1. Base Scenario

If port conveyance throughput matches MRS BURU requirements and consists of the mode mix we assumed, it can be shown that 68.89 percent of all port throughput is by railcar and 31.11 percent by truck. However, the optimal transportation plan results in a mix of 85 percent rail freight and 15 percent truck freight. This is because the four day lead time in the scenario and ample depot outload capability allows truck throughput (which is faster but more expensive) to be underutilized. Also, by pricing premium rail transportation (which consists of only two percent of volume in the base

scenario) out of the problem and re-running the model, the optimal plan costs increase by 0.27 percent. Thus, by simply including an intermediate level transportation service, overall transportation costs can be reduced. This is a tiny contribution but premium rail service is likely to be much more valuable if the contingency faces a shorter lead time or any shortfalls in depot outload capability. Of course, the model does not include stochastic effects and thus does not evaluate the additional reliability achieved over employing general merchandise rail freight alone.

Due to proximity, Bluegrass and Anniston serve approximately equal shares of MOTSU's demand, while Crane makes only a small contribution. McAlester and Tooele serve the west coast ports, with McAlester serving approximately 60 percent of Concord's demand and Tooele serving almost 90 percent of Hadlock's demand. The base case supply-demand assignment is shown in Figure 4.12.

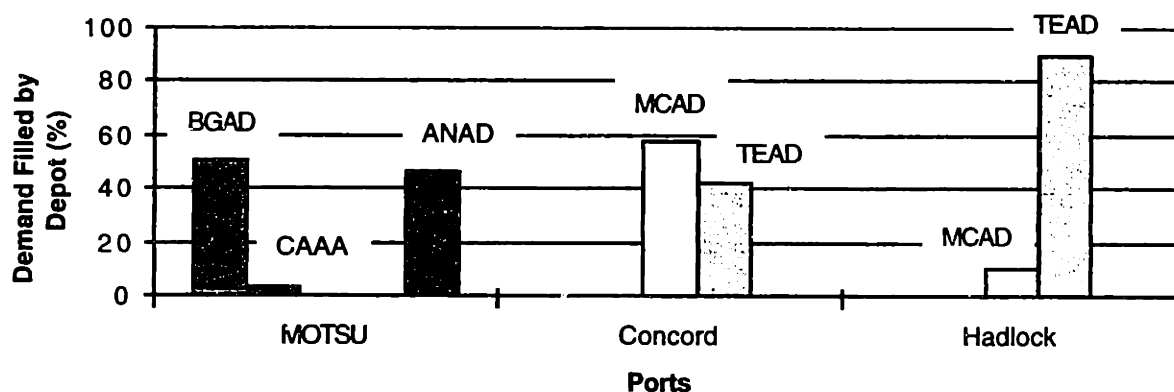

Figure 4.12: Base Case Supply-Demand Assignments

The modal mix can also be examined relative to depot outbound flow and port inbound flow. All shipments from Bluegrass, Crane, and Anniston are by rail freight, and thus by Figure 4.12, all of the containers arriving at MOTSU are via rail. Recall that railcars constitute 80 percent of MOTSU's conveyance throughput mix in the model, thus fully 20 percent of this capacity is not utilized. Trucking is only utilized from McAlester and Tooele. At Tooele it constitutes nearly 50% of output since the depot supplies 90 percent of Hadlock's demand (where there is no rail infrastructure). Although Concord's modal mix in the model is the same as MOTSU's, a small amount of truck throughput is utilized. These input-output mixes are charted in Appendix A.

Since total depot output capability is approximately ten percent greater than total port demand, there are large imbalances in depot utilization. Average utilizations for both Bluegrass and Anniston were well over 80 percent to feed MOTSU's large share of demand, while Tooele is also heavily utilized due to its proximity to Concord and Hadlock. Although McAlester serves the majority of Concord's demand and a small portion of Hadlock's, its utilization level is just over 60 percent because of its massive outloading capacity (400 containers/day). Finally, Crane is only utilized at about 25 percent in serving a tiny fraction of MOTSU's demand. Base case average utilizations are depicted in Figure 4.13.

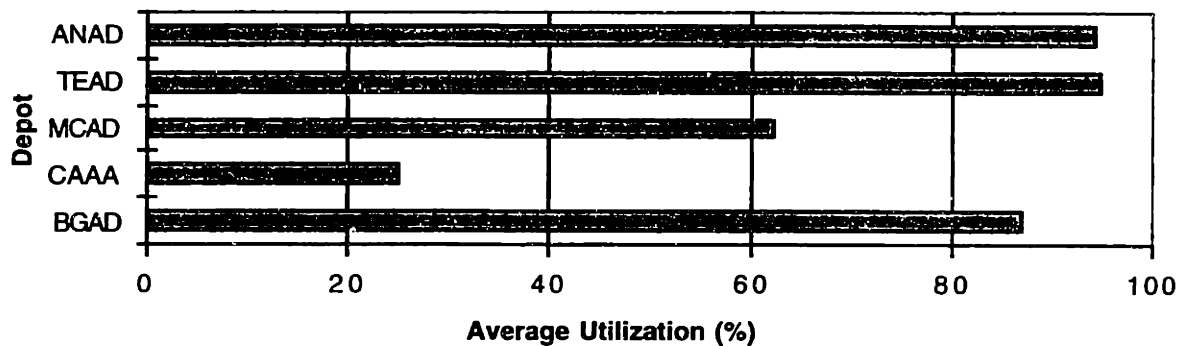

Figure 4.13: Base Case Depot Average Utilization Levels

In the model, there are essentially three general "queues" in which containers may remain from one planning period to the next before moving on to the next segment of the pipeline. The first of these is at depot stuffing/staging pads. Although the upper bound of 500 STONs of NEW was reached for most depots in every experiment, usually this only occurred in one of the final planning periods. Average NEW levels were much lower and never exceeded an amount just over 300 STONs. Average and maximum levels reached in the base case are displayed in Figure 4.14.

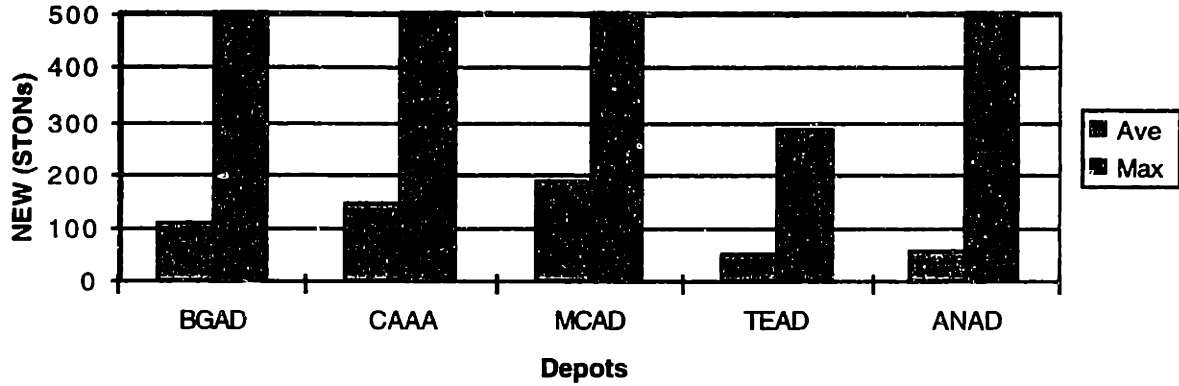

Figure 4.14: Base Case Depot NEW Levels

The second queue consists of containers at the ports remaining on conveyances. We would expect the length of this queue to grow with either a decrease in port conveyance throughput capacity or with decreases in *binding* internal NEW limits. Again, this queue is not controlled in our experiments with demurrage costs as it should be in practice. Since port NEW levels are never binding, delayed container levels vary seemingly arbitrarily from one experiment to the next. The total number of containers delayed by mode for each port in the base scenario is charted in Figure 4.15.

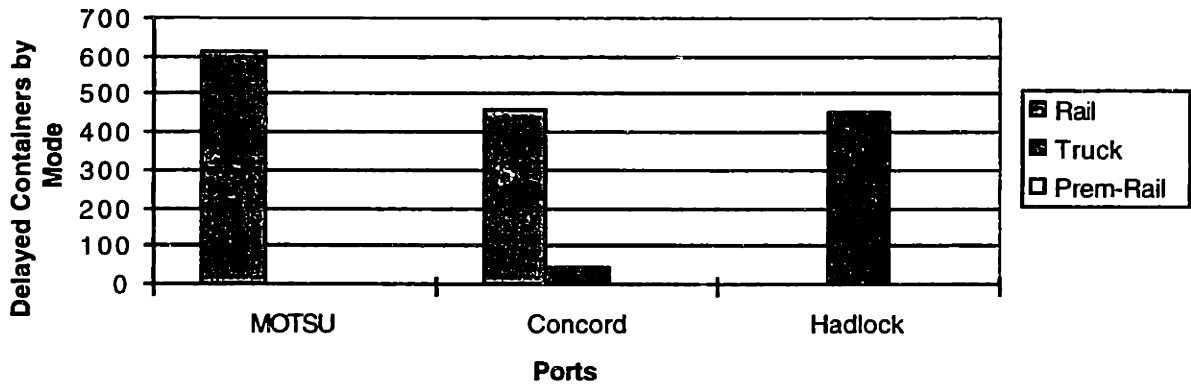

Figure 4.15: Base Case Port Demurrage Levels

The final stage in the CONUS pipeline before ship loading is port storage pads, where net explosive weight is the most important restriction to observe. The maximum NEW levels achieved in the base case were approximately 1,000 STONs for MOTSU, approximately 600 STONs for Concord, and negligible levels for Hadlock (see Figure

4.16). To put this in perspective, it has been stated that during day to day operations at Concord, container NEW ranges between two and ten million pounds [58]. Ten million pounds equates to 5,000 STONs, well below the maximum level reached for Concord in the model. Furthermore, maximum and average port NEW levels rarely varied significantly from the base scenario in the remaining experiments. Once again, our model only covers a single week of transshipment and these levels are likely to change significantly in a real application where MRC sustainment periods would probably be much longer.

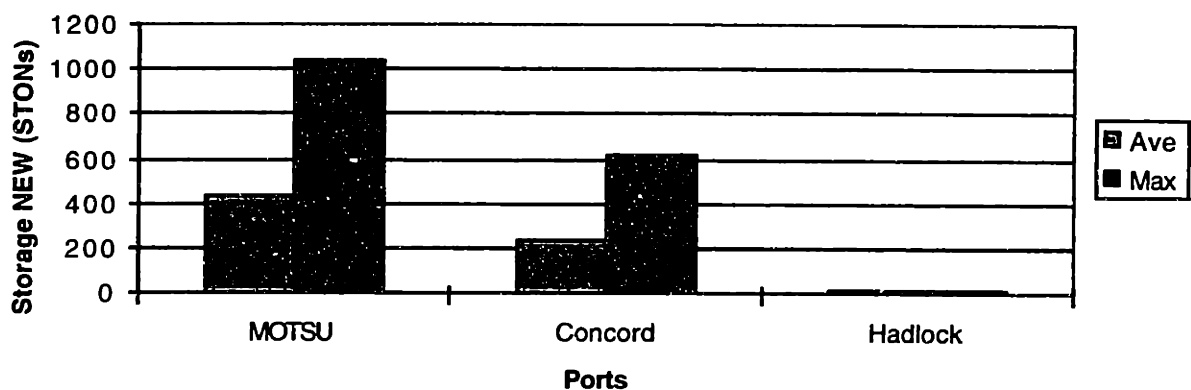

Figure 4.16: Base Case Port NEW Levels

In the remainder of this section we describe the results of model runs performed to investigate the effects of changes in the factors described above. The reader is encouraged to refer to Appendix A where appropriate to examine pictorial summaries of each experiment.

4.4.2.2. Shortfalls in Depot Containerization Capacity

As stated previously, there is excess depot outload capacity and slack in lead time in the base model that permits the use of cheaper modes of transportation to meet the closure profile. To examine the effect of reductions in depot outload capability, two experiments were run. In the first case all depot output levels were cut by five percent; in the second by ten percent. All other model parameters remained the same as in the base scenario. Such an analysis would be helpful with valid data to evaluate both the level and the distribution of outload capability among different depots. Clearly, the cheapest (in transportation dollars) and most mission responsive option for

contingency support is to locate sustainment stock and containerization capability as close to the ports as possible. However, this ignores issues of security and peacetime transportation costs to bases in CONUS for training purposes.

For both cases, an overall reduction in depot output of five percent resulted in a one percent shift of transportation volume from rail traffic to truck traffic. This makes sense; a faster mode of service must make up for the shortfall in depot capability. More interesting is that although the use of premium rail service does not change, less of it goes to Concord and more to MOTSU as depot capability drops. These are small changes - we are likely to see much more pronounced or entirely new results as depot capability approaches port demand. Of course, this mode shift also reflects itself in the optimal plan cost: for each five percent reduction in overall depot output, the objective function increased by approximately two percent.

Optimal plans also display interesting changes in supply-demand assignments. Although Crane is much more distant than either Bluegrass or Anniston from MOTSU, the depot supplies more of MOTSU's demand as overall depot capability is reduced. Likewise, McAlester fills an increasing share of demand at both Concord and Hadlock. The reasons for this can be seen in the changes that occur in average depot utilization. Although all depots are utilized more as their capability is reduced, for an even relative reduction across all depots, the least utilized depots take on more of the new relative demand.

4.4.2.3. Port Conveyance Throughput Levels

The next two experiments were designed to evaluate the impact of differences between conveyance throughput and the shipping schedule at the ports. Here, we chose Concord as our candidate for analysis because of the changes in manning and infrastructure that are occurring there. We increased Concord's vehicle processing capability by five percent (keeping the same mode mix), and decreased it by five percent. Significant effects in our response factors were local. By cutting throughput by five percent, two percent of overall transportation volume was shifted from rail to truck transportation. Closer examination reveals that this is solely due to more trucking from McAlester to Concord. Although this is the same overall transportation mix as in the case where depot outloading was cut by five percent, transportation costs only increased by 0.5 percent in this experiment. This is because the supply-demand

assignments do not change. When throughput was increased by five percent, truck transportation decreased by one percent (again, from a drop in trucking from McAlester to Concord), resulting in a drop in costs from the base case of 0.35 percent.

An expected response in decreasing throughput was that while average and maximum NEW levels at Concord remained the same, delayed containers increased by approximately 480 for railcars and 270 for trucks. However, a similar but smaller increase occurred in delayed containers when throughput was *increased* by five percent. Again, it is difficult to attribute parameter changes to changes in this response for our model.

4.4.2.4. Other Port Infrastructure Issues

Two other changes local to Concord were made. First, in the base case we assumed that Concord's throughput consisted of eighty percent railcar and twenty percent truck. The first experiment was done to assess sensitivity to this assumption: the mix was changed to 50 percent rail and 40 percent truck. This change shifts the overall port throughput capacity in the network to 41.11 percent truck and 58.89 percent rail; an increase in truck volume of ten percent. However, the optimal solution in this scenario produces a mode mix of 23 percent truck and 77 percent rail, representing only an eight percent shift toward trucking from the base case optimum. Costs increased by 2.5 percent. As in the previous analysis, this produced a local change in the network. There were no changes in the overall supply-demand assignments or in depot utilization. Significant increases in truck shipments occurred only at McAlester and Tooele, Concord's supplying depots.

Finally, recall from Chapter 2 that there are hardened magazines constituting some 825,000 square feet of explosive storage capacity at Concord. These magazines were originally used to maintain Navy munitions but have since been offered to the IOC for SMCA capacity [2]. This begs the question of what effect instituting internal depot operations would have on system performance. The cost of implementing this might consist only of setting up container stuffing capabilities, a one time move of sustainment munitions from the depot(s) that would otherwise supply it, and possibly moving some IOC functions to the port. There should be no effect on port security as this storage is hardened, and this would clearly reduce required lead time and increase

our west coast power projection capability. To evaluate this change in the model, we must make some minor additions:

- **Decision Variables**

v_{jt}^b - the number of containers of type $b \in \mathcal{B}$ which are stuffed locally at port $j \in \mathcal{Nd}$ at time $t = 0, \dots, T$

- **Parameters**

θ_j - number of containers that can be stuffed at port $j \in \mathcal{Nd}$ per planning period

s_j^b - the available supply of munitions for containers of type $b \in \mathcal{B}$ which are in long term storage at port $j \in \mathcal{Nd}$.

Then we include constraints (4.49) to restrict port containerization to supply available, constraints (4.50) to model the output capability, and the final balance of flow equation in the model is changed to (4.51). These additions (for a single port) increase the model size from the base case by approximately 1,500 variables and 100 constraints.

$$\sum_{t=0}^T v_{jt}^b \leq s_j^b \quad \forall b \in \mathcal{B} \quad (4.49)$$

$$\sum_{b \in \mathcal{B}} v_{jt}^b \leq \theta_j \quad \forall b \in \mathcal{B}, t = 0, \dots, T \quad (4.50)$$

$$\sum_{k \in \mathcal{V}} y_{jk}^b(t-1) + p_{j(t-1)}^b + v_{j(t-1)}^b - p_{jt}^b = d_{jt}^b \quad \forall k \in \mathcal{V}, b \in \mathcal{B}, t = 0, \dots, T. \quad (4.51)$$

The model was solved for a Concord munitions supply large enough to be non-binding in the horizon and with a container stuffing capability equal to 25 percent of its MRS BURU required ship loading rate. The optimum solution does not produce a system modal mix significantly different from the base case, but there is a major change in the supply-demand assignment. Due to slack in the lead time and a relatively short outload, Concord is able to supply approximately 36 percent of its own demand in the period (supply from McAlester was likewise reduced by this amount).

This extra slack in transportation reduces McAlester's average utilization from just over 60 percent to approximately 37 percent. Of the total amount still shipped to Concord from depots, slightly more of this is rail freight. This is because the port is able to supply more of its own demand earlier and the excess that must be made up by shipments can arrive via slower modes. This is also reflected in the very large increase of delayed containers by rail (approximately 2,000) and in a decrease in the maximum storage NEW that was reached (just over 100 STONs).

The cost of implementing this must be evaluated against projected transportation cost savings in the future. For this scenario alone, the objective function was reduced by 29 percent.

4.4.2.5. Lead Time Reduction

Our last experiment was designed to get a glimpse into the effects that changes in the lead time (i.e., the length of time until port outloading must begin) might have on system performance. The last model was solved with a lead time of three days instead of four, while keeping total demand over the seven day outload the same. The last day was devoid of demand to keep model size the same. As one might suspect, this produced the most dramatic changes in the response factors from the base scenario.

First, the transportation mode mix was pushed closer to the system 68.89 percent rail/31.11 percent truck capacity mix. Truck volume increased by 9 percent to 24 percent, while rail modes dropped by nine percent overall (premium rail increased by two percent to four percent while general merchandise rail dropped 11 percent to 72 percent). Each depot ships via all three modes of service, and trucking constitutes at least ten percent of input volume at each port. With a faster impending closure profile to meet, faster modes of transportation must be used to fill the pipeline.

Changes in the supply-demand assignments were more dynamic than in previous experiments. Crane's average utilization increased to approximately 35 percent and it now ships freight to each port, albeit constituting less than ten percent of demand at each port. McAlester, the most capable depot in the model, is also utilized slightly more and thus takes on a greater share of demand at Concord and Hadlock. However, all other depots are actually utilized slightly *less*. With these changes in supply-demand assignments and mode mix, total plan costs increased by approximately 7.6% over the base case.

Since containers are needed earlier at the port, in this experiment there were significant drops in port demurrage and NEW levels. While there were modest increases in delayed containers at MOTSU, total delayed containers at both Concord and Hadlock were well under 100. More important, average and maximum NEW levels reached at all ports were at least halved. This is because the shorter lead time restricts the model from taking advantage of port queueing areas as a buffer for demand. Faster modes of transportation are used and containers must be moved through the port more quickly.

The model was run a second time with a lead time of two days, but the problem proved infeasible, implying a minimum lead time between two and three days. Since depot output exceeds port demand, this window is simply the minimum time required to move containers across the maximum length arc for all ports such that these arcs are minimum length depot-port matchings (plus intrafacility processing periods). Longer lead times could result from shortfalls in depot outload or port throughput rates. This is because queueing/storage areas throughout the pipeline need to be utilized as buffers for the heavier demand. Furthermore, we suspect such changes would be more pronounced for longer sustainment periods as these shortfalls would accumulate over more time.

Table 4-1 summarizes the nature of these experiments and shows where significant local or network changes occurred in our response factors for each scenario. Again, the factors were not evaluated for the case where premium rail service was excluded. Recall that the base case scenario mode mix consisted of 85 percent rail volume and 15 percent truck volume.

Table 4-1: Scenario Analysis Summary: Significant Changes

Scenario	Experiment	Change scope
1	Reduce output of all depots by 5%	Network
2	Reduce output of all depots by 10%	Network
3	Reduce lead time by one day	Network
4	Reduce port throughput by 5%	Local (Concord)
5	Increase port throughput by 5%	Local (Concord)
6	Shift port mode mix to 60% rail/40% truck	Local (Concord)
7	Introduce deport operations at port (25% of output)	Local (Concord)

Scenario	Response nature		Node mix (rail/truck)	Supply-demand assignments
1	Network	+2.00%	84/16	more from underutilized depots
2	Network	+4.00%	83/17	more from underutilized depots
3	Network	+7.60%	76/24	more from McAlester and Crane
4	Local	+0.50%	83/17	
5	Local	-0.35%	86/14	
6	Local	+2.50%	77/23	
7	Local	-29.00%	83/17	Concord fills 36% of own

Scenario	Depot utilization	Depot NEW	Port demurrage	Port NEW
1	least utilized increase most			
2	least utilized increase most			
3	dynamic changes		large decrease	< - 50%
4				
5				
6				
7	McAlester relaxed		large increase	

4.5. Chapter Summary: Model Applicability

This chapter reviewed deployment planning as it is carried out in practice at the strategic, tactical, and operational levels in the DoD. Using this hierarchy, and an established geospatial partitioning of the logistics pipeline, we proposed a decomposition framework for the munitions deployment planning problem.

With an emphasis on munitions mobilization at the deliberate (tactical) planning level, this chapter lays the groundwork for analytic flow planning by developing a linear programming problem formulation. A dynamic multicommodity network flow approach is used because of its flexibility and broad applicability to all complex transportation problems. The model is schedule driven; a port closure profile must be met at minimum cost. This closure profile represents the linkage between the mobilization and strategic (i.e., intertheater) deployment problems that must be coordinated at a higher level. Possible extensions to the formulation are proposed.

An example problem is implemented on a workstation class computer and its linear relaxation is solved via commercial network simplex and simplex algorithms. Although the model is developed to generate flow plans, a series of experiments were conducted to demonstrate the model's capability to answer strategic level questions via scenario analysis.

Given the availability of extensive valid data, the linear programming problem formulation developed in this chapter could be used to support munitions mobilization planning in practice. By employing state of the art large-scale system optimization theory, such as the branch-and-price-and-cut algorithm [9], integer optimal solutions could be found for problems with *billions* of decision variables. This is critical because whereas our modestly sized test case examines a seven day outload, TPFDD development considers horizons of thirty days. More operational detail and greater time fidelity could also be incorporated. The approach combines branch-and-bound with column generation and cut generation, and uses a decomposition strategy that involves the repeated solution of a series of smaller, simpler subproblems.

At the operational level, the same decomposition based approach could be used to tackle CONUS network flow control as it allows *near-optimal* solutions to be generated in *real-time* with bounds. Coupling our model with such an advanced solution algorithm and real-time data connectivity would provide automated plan generation for munitions mobilization C². This is currently a non-existent decision support capability. The model would be solved on a predetermined rolling horizon or whenever significant deviations from the current plan have transpired. All queues and flows in the model would be set to initial values with each data update.

At either level of application, implementation will require a combination of domain knowledge, transportation modeling experience, and the development of special purpose codes. Success of the approach will depend on ease of solution of the subproblems generated. For other approaches to large scale systems optimization and real time algorithms, see [34, 47, 48, 49].

5. Summary and Future Work

The focal point of this thesis is the development of a framework for hierarchical deployment planning for DoD munitions logistics C² and the design and formulation of an optimization model that can be used to support deliberate planning. As initial research in this area, this thesis also provides an encompassing review of current transshipment operations, logistics information management systems, and deployment planning conducted in practice. Numerous problems remain to be addressed. This chapter summarizes the thesis and proposes some areas for future work.

5.1. Research Summary

From Chapter 1, we learned that lessons from recent contingencies and current evolvments in DoD force posture motivate the need for efficient logistics support for CONUS based global power projection. This can only be achieved through tight command and control over all legs of the logistics pipeline. We first focused our attention on one specific commodity class: sustainment munitions. This non-unit cargo class is supported by a unique logistics network that faces numerous challenges to mission success.

To lay the foundation for analysis, Chapter 2 provided a high-level description of the organizations, cargo handling processes, and CONUS network infrastructure that support sustainment munitions transshipment. We examined aspects of the Industrial Operations Command munitions depots, including stock classification and distribution, the tiering system, containerization operations, and the host of challenges to efficiency at these facilities in the years ahead. We discussed the critical role that the three munitions transshipment ports play in sustaining our forces abroad and provided a general characterization of cargo handling procedures, port infrastructure, materials handling equipment, and the sealift vessels that are serviced. Important terminology and classifications are defined throughout the chapter.

Key to establishing command and control are the functions of sensing and situation assessment. For all commodity classes of the logistics pipeline in the DoD, these functions represent a capability collectively known as Total Asset Visibility. The DoD has worked extensively to provide this capability through an automated information systems architecture which was reviewed in Chapter 3. A status based commodity classification provides a framework for understanding system capabilities and developing a connectivity strategy. Along with systems, this chapter discussed the information flows that are used to coordinate the logistics pipeline. The last part of the chapter discusses the implementation of automatic identification technologies as a fundamental step in capturing reliable, comprehensive, real-time network data.

Outside of providing total asset visibility, little work has been done in the development of analytic planning models. Chapter 4 explored automating the deployment plan generation function as a means to provide decision support to commanders and logisticians alike. The first part of the chapter broke the deployment planning problem along hierarchical lines and geospatial divisions used in practice. Although our emphasis has been on sustainment munitions deployment, the hierarchical planning framework proposed represents a functional decomposition applicable across commodity classes throughout the DoD. Focusing on the tactical (deliberate) level, a multicommodity network flow model was developed to generate mobilization movement tables. The model's flexibility was demonstrated by enumerating several extensions. Finally, the model was implemented and its linear relaxation was solved to provide initial computational results. The model's value as a

strategic decision aid was demonstrated through scenario analysis, and requirements for its extension to operational use are delineated.

5.2. Future Work

There are three areas in which future research in this problem will be most beneficial: enhancements to the capabilities of the mobilization planner, development of a simulation model, and integration of these components into a decision support tool.

5.2.1. Planning

First, recall from Chapter 4 that the test case implementation of the optimization model, which only considers one week of deployment, resulted in a problem size of close to 58,000 decision variables and 14,000 constraints. This is considerably large. It may be valuable to pursue methods to reduce or otherwise manipulate the size of the problem into a form more readily attacked by state of the art solution algorithms. The formulation herein uses standard arc flow variables and this thesis does not consider clever network formulation approaches that have been successful in ameliorating size effects (e.g., path flows and tree flows, etc.) [4].

Second, as discussed at the end of Chapter 4, the use of more advanced solution algorithms will be necessary to push the planner closer to operational level performance. Integer solutions must be found for potentially more detailed problems in a real-time setting. A possible decomposition approach that has been successful for optimizing problems with over a billion decision variables is branch-and-price-and-cut [9]. This algorithm can also generate near optimal solutions in real-time with bounds. Any such specialized approach will require the development of special processing programs written in a general purpose language (e.g., C or C++) to interface with the solver.

Third, the network model's flexibility in Chapter 4 was demonstrated by discussing possible extensions to the formulation. This is important to its applicability as an operational decision aid. Close cooperation with client agencies will be required in the future to specify all decisions that must be modeled and the exact form of the

objective function and constraints. Furthermore, gathering valid historical data will be an intensive effort necessary to generating realistic flow plans or scenario analyses.

Finally, as previously emphasized, the optimization model is deterministic. It is clear that the CONUS deployment network will demonstrate multiple layers of stochastic effects which may render plans suboptimal or completely impractical. As such, an examination of the stochastic programming literature may be useful in finding other models and algorithms to develop robust plans in the face of uncertainty.

5.2.2. Simulation

The C.S. Draper Laboratory has developed a discrete event simulation model of the munitions deployment pipeline that will be the core of an integrated decision support system for munitions logistics. This system, known as the Munitions Logistics Analysis Support Tool (MLAST) [28], incorporates an object-oriented design and web based client-server architecture, both of which facilitate further development. Employing a top-down design, the CONUS network can be represented in multiple levels of fidelity. For example, a port object exists as a node in the CONUS network but is also a detailed network itself. An aggregation hierarchy of transportation assets allows the modeling of conveyances, containers, and loose munitions stock. A base server class is used to derive resources such as work crews, gantry cranes, or materials handling equipment.

The simulation's underlying data structures and algorithms are implemented in C++ and the graphical user interface is coded in Java. In its infancy at this writing, the simulation's flow rules are currently just first-in-first-out. Although the general structure of the network is defined in a series of input files, the simulation is interactive. When MLAST is invoked, the user logs in using a username and password and then a map of CONUS overlaid with a graphical layer depicting the network is displayed. This interface is shown in Figure 5.1.

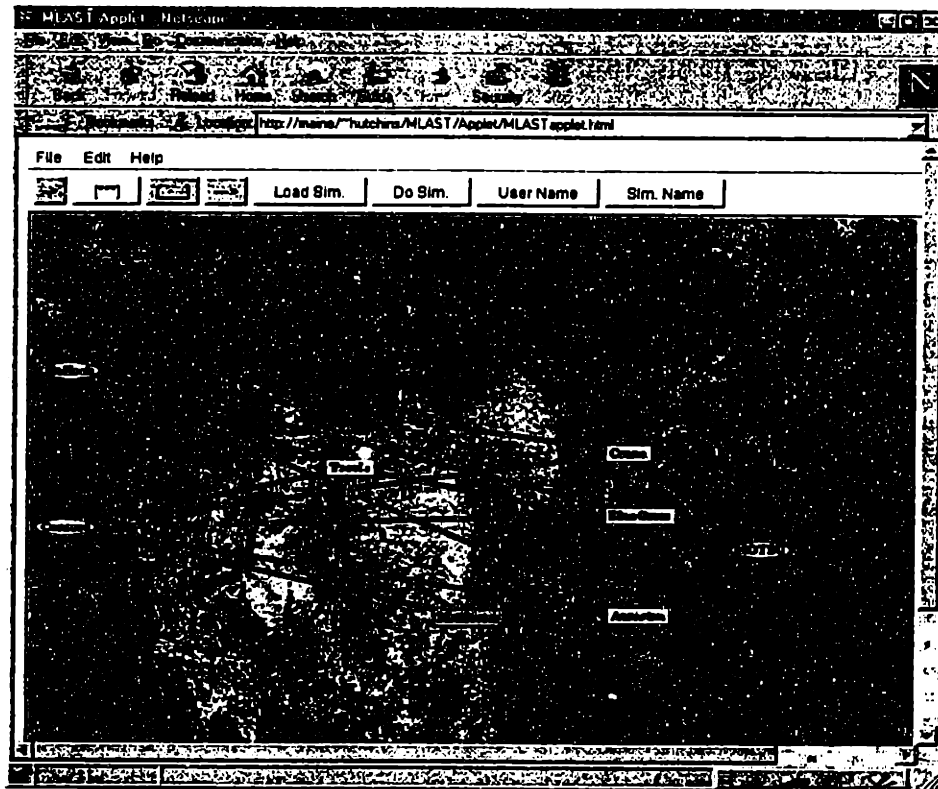

Figure 5.1: MLAST Simulation Graphical User Interface (Web Browser)

The entities comprising the network (e.g., a depot, a port, a rail line) can be selected and “opened.” Thus, the user has access to all the data that describes the characteristics of the entity and the quantity of and logistics plan for munitions in the entity. The data can be presented in a variety of tabular and graphical forms. The user can change appropriate values and invoke the simulation to see the effect of those changes on the network. The effect on network performance will be measured using appropriate metrics such as tardiness of munitions shipments, excess buildup of inventory at a port, or delays along a rail line. Each user is able to store his or her own analysis data for future access without affecting any other user’s data.

The specific data that a user edits will depend upon the user’s objective. For example, if the user is interested in understanding the effect on network performance of increased capacity at Concord Naval Weapons Station, then the port’s characteristics (e.g., inventory capacity, throughput) will be the data that is changed.

Although the simulation’s current capabilities are primitive, its development is valuable to network planning and analysis for three key reasons. First, although the simulation does not generate plans, it serves as a predictive mechanism to generate

network performance measures *given* different deployment plans and scenarios, such as closure profiles and throughput estimates. The simulation captures far more detail and is more flexible than any closed form expression. As such, it is even more valuable for strategic level analysis than the optimization model since it offers many more possibilities for experimentation. Second, as developers perform system analysis to enhance the validity of the simulation, they will garner a detailed knowledge of the underlying flow decision rules used in practice. This can assist in the design of heuristic sequencing algorithms to improve network performance at lower levels of the hierarchy. Finally, by employing random number generation to model real-world stochastic effects, the simulation serves as a representation of the actual network. This motivates its use as an algorithm testbed, where the robustness of plans can be evaluated.

In this framework, the plan generator (i.e., optimization) must be integrated with the simulation into one system. The state data that are used by the simulation must likewise be converted into the decision variables, constraints, and objective function in a form required by the solver. When the solver returns an optimal solution, the values of the decision variables must likewise be converted into a plan format useful to the simulation. These functions will be the job special pre- and post-processing programs that must be developed. The plan is then implemented in the simulation to achieve realizations of all performance metrics. In a real-time test setting, the optimization may be invoked to replan periodically as the simulation progresses or as significant problems or opportunities present themselves. This integration is illustrated in Figure 5.2.

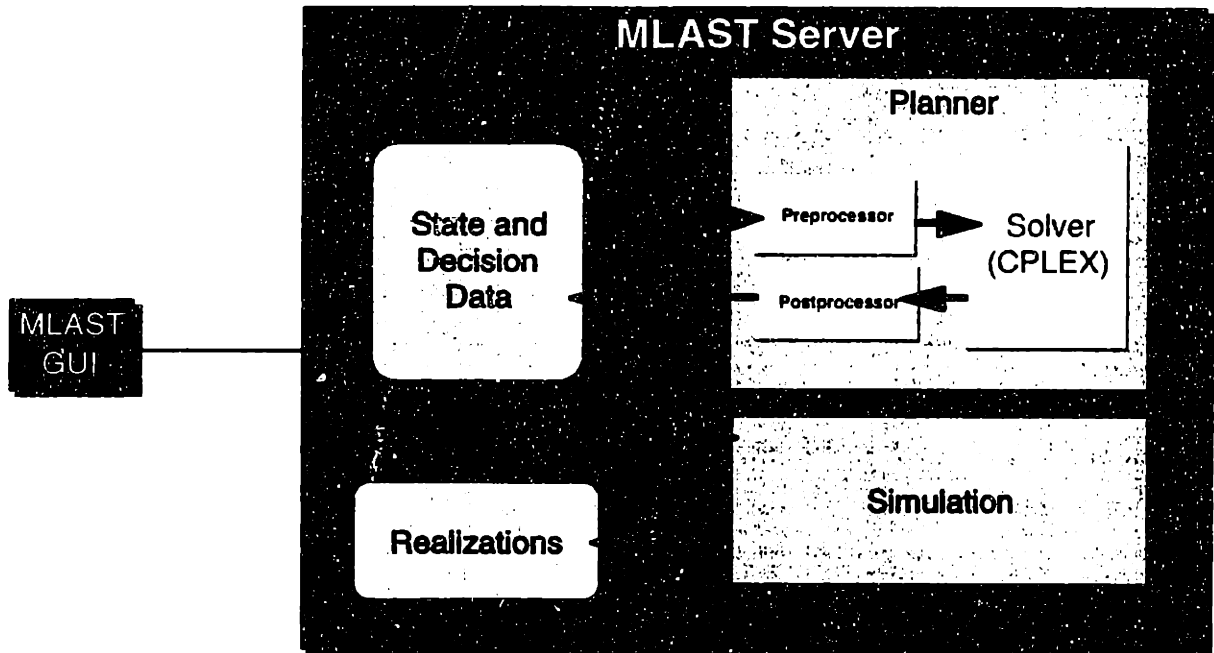

Figure 5.2: Plan Testbed Architecture

If further development is pursued, the MLAST system could eventually be extended to an operational system with connectivity to TAV systems for real time network data. Incorporating advanced optimization algorithms, plans could be generated for actual contingencies and communicated for execution.

Appendix A - Scenario Analysis Response Charts

This section includes charts of all optimal transportation plan characteristics, (except the base case without premium rail service) evaluated in the scenario analysis of Chapter 4. These are again:

- Base case (without premium rail service) (0)
- Base case (with premium rail service) (1)
- Cut depot outload capability by five percent (2)
- Cut depot outload capability by ten percent (3)
- Cut Concord conveyance throughput by five percent (4)
- Increase Concord conveyance throughput by ten percent (5)
- Change Concord input mix to 60 percent rail/40 percent truck (6)
- Introduce Concord containerization (depot) capability at 25 percent of required output (7)
- Cut lead time by one day (8)

The following chart depicts relative costs of each of these plans:

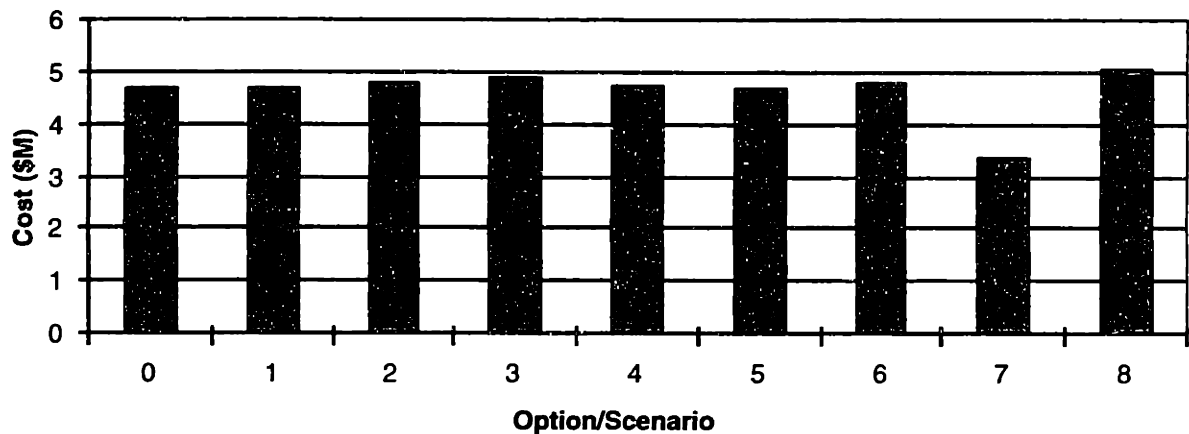

Base Case (with Premium Rail Service)

System Mode Mix

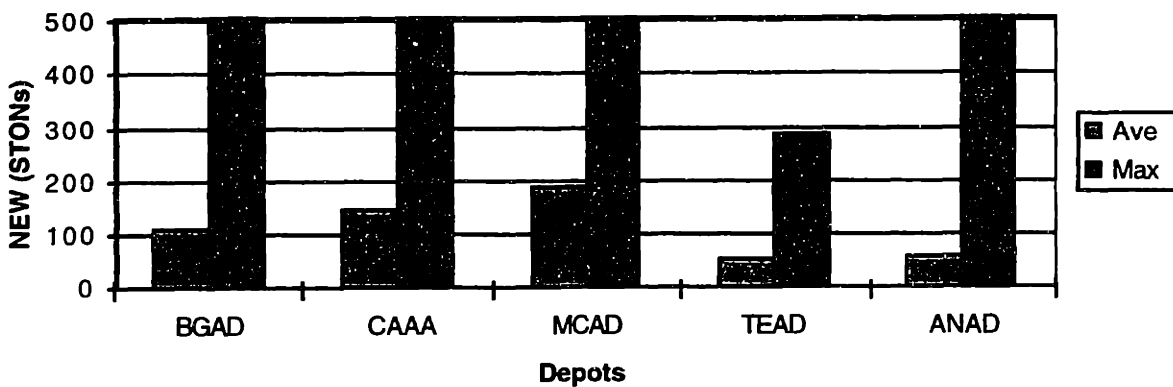
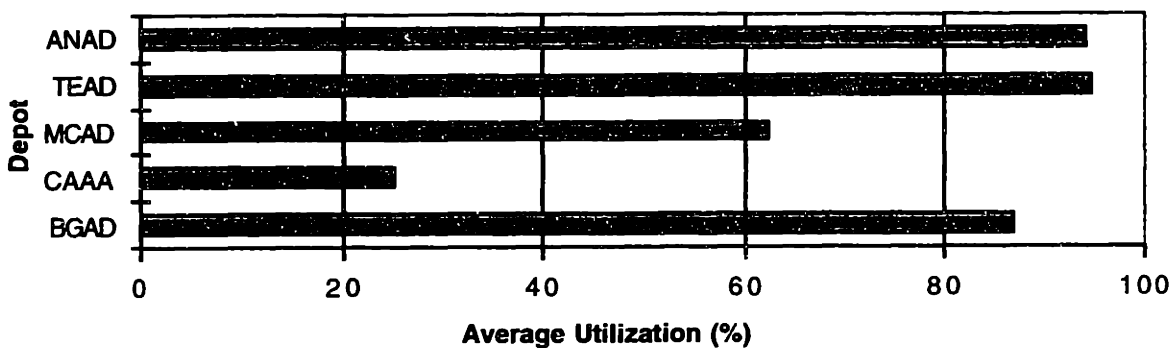
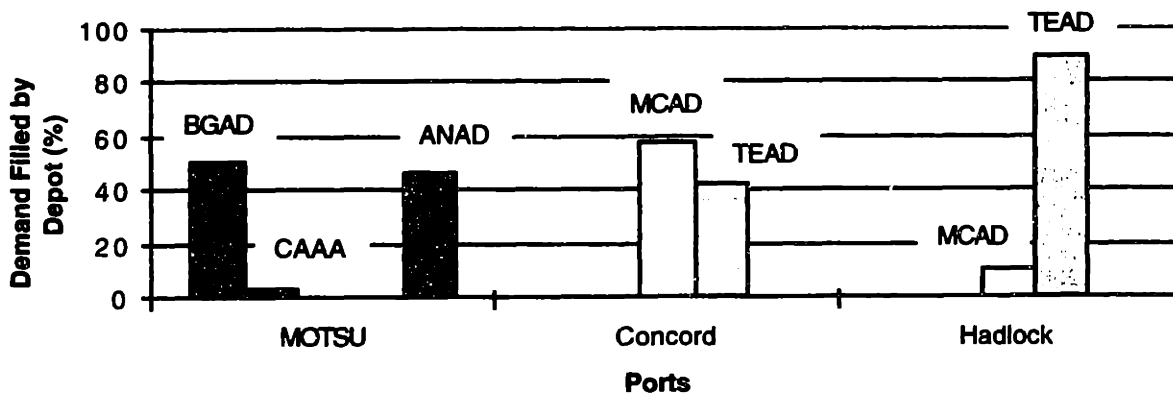
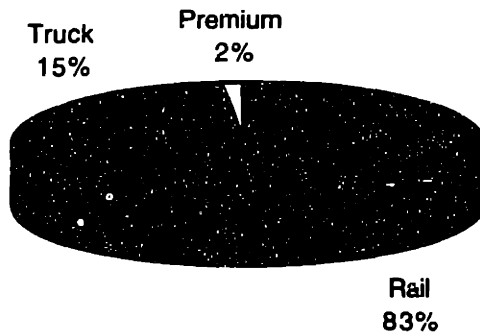

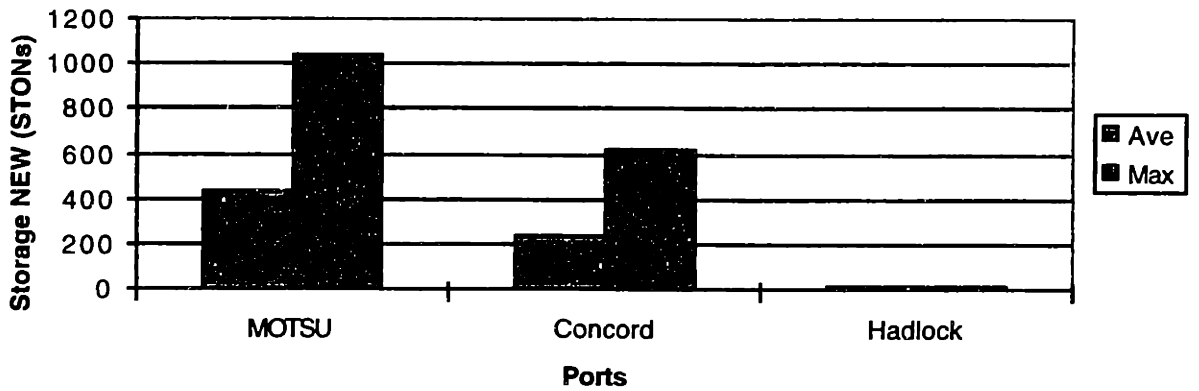
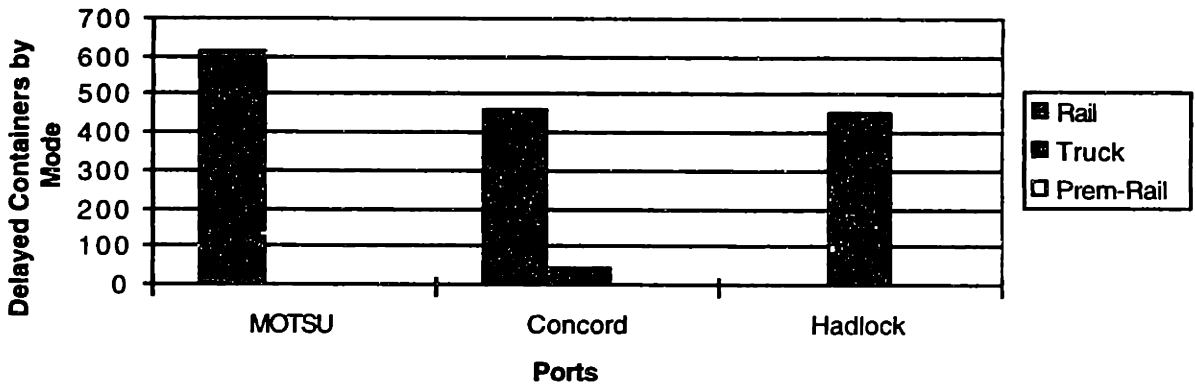
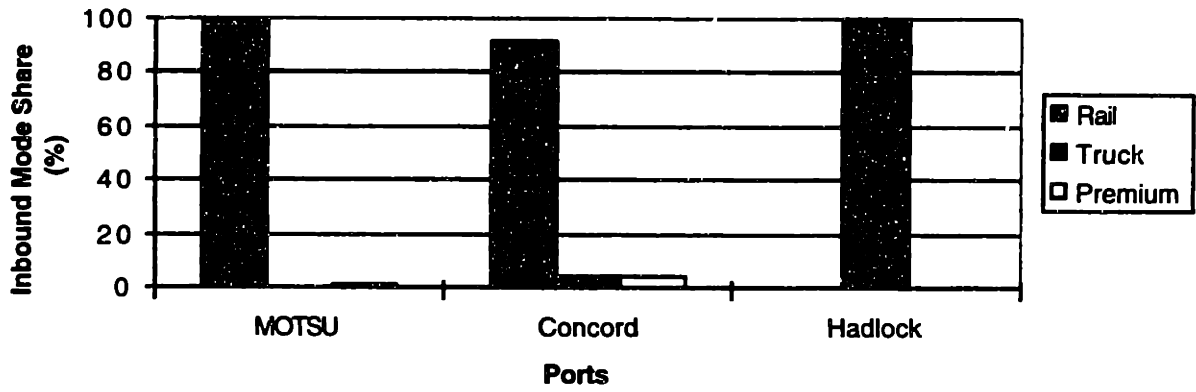
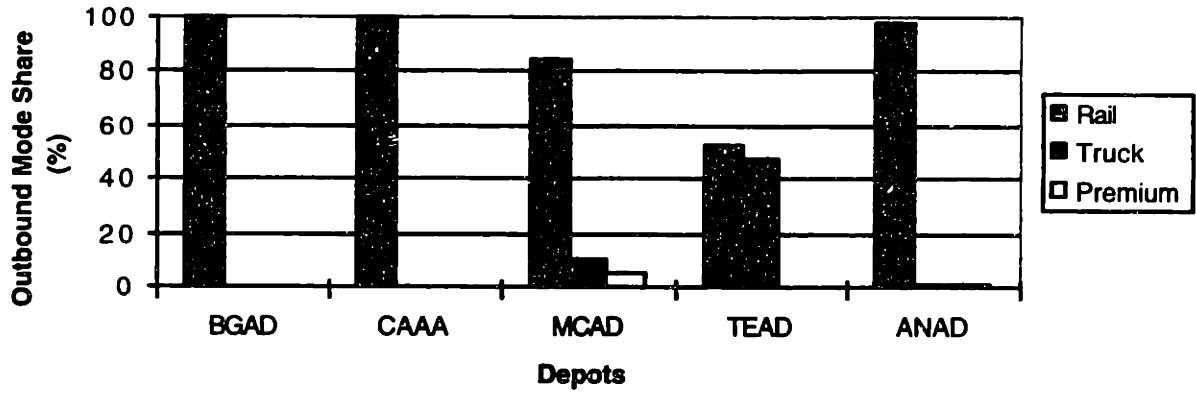

Cut Depot Output 5%

System Mode Mix

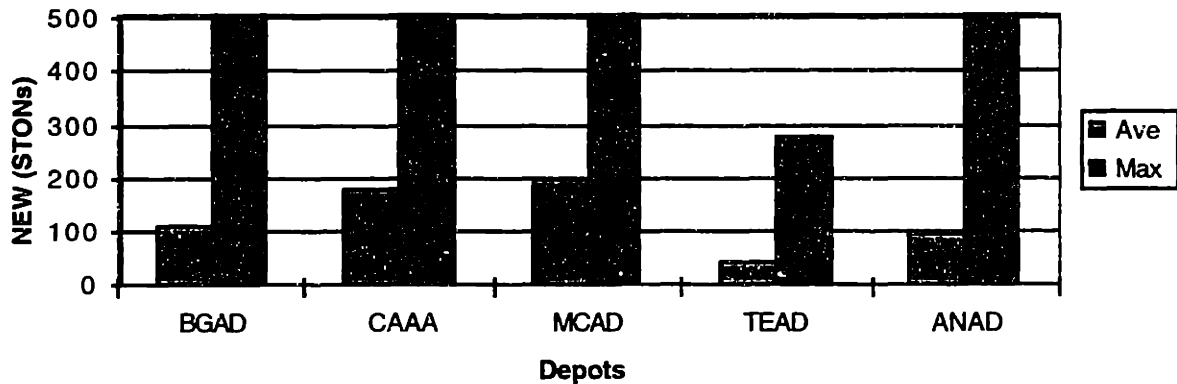
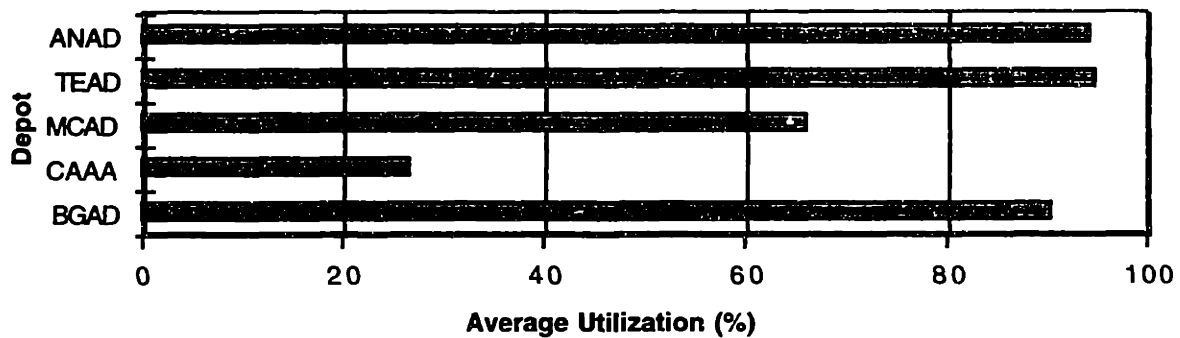
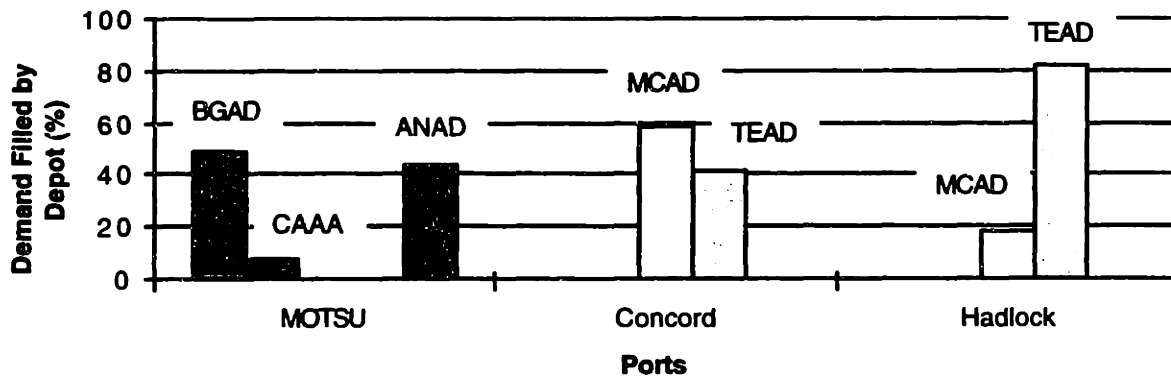
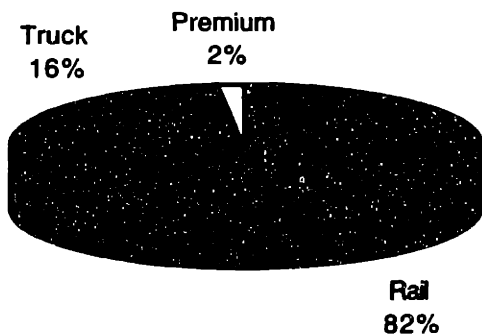

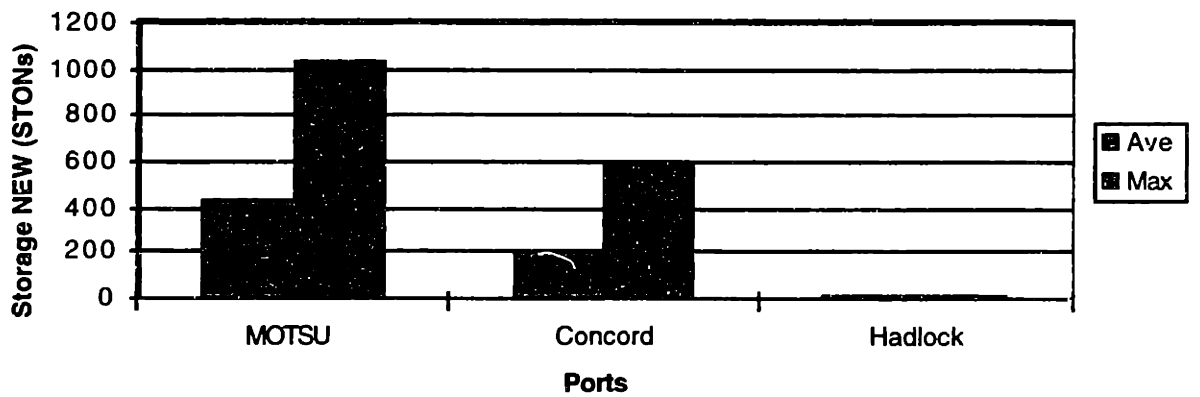
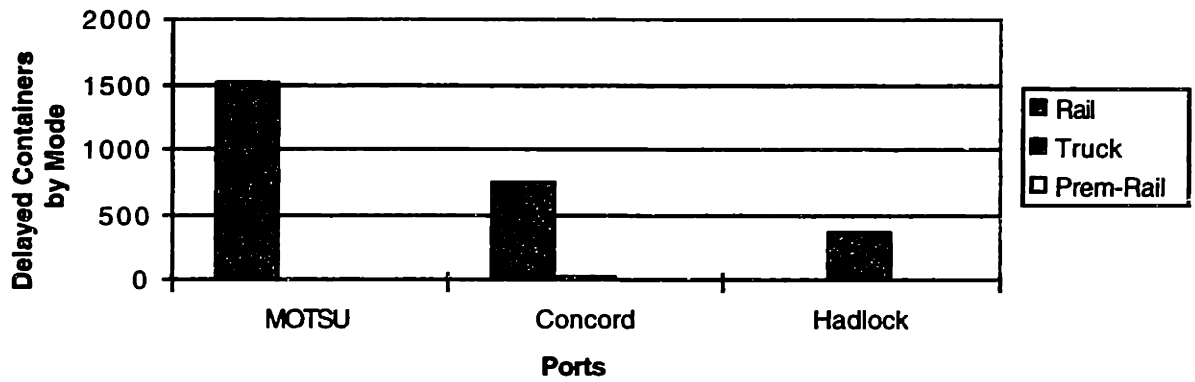
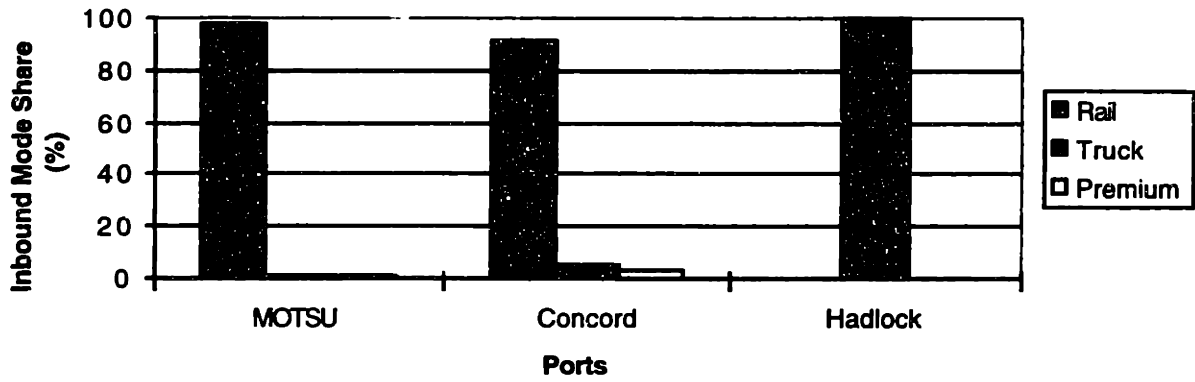
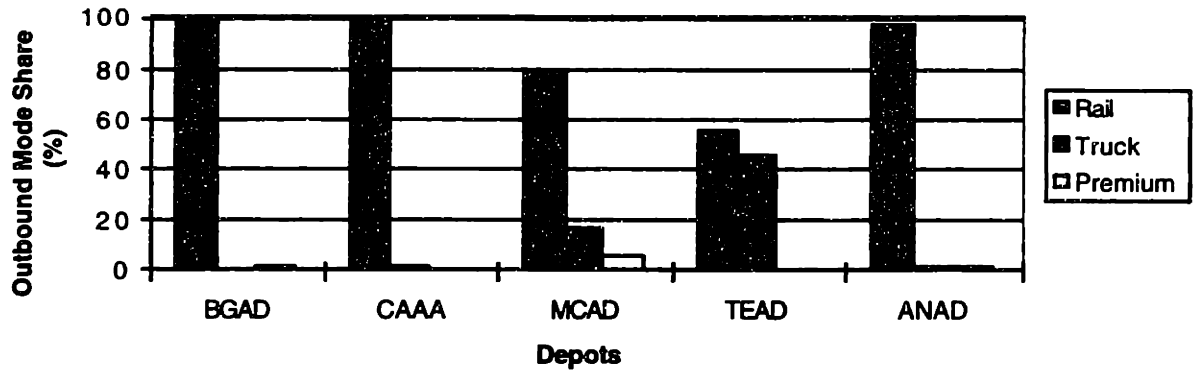

Cut Depot Output 10%

System Wide Mode Mix

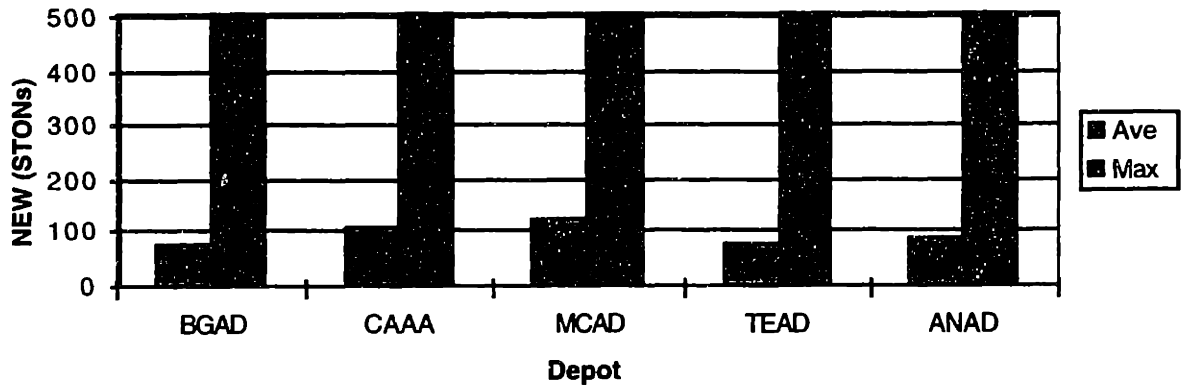
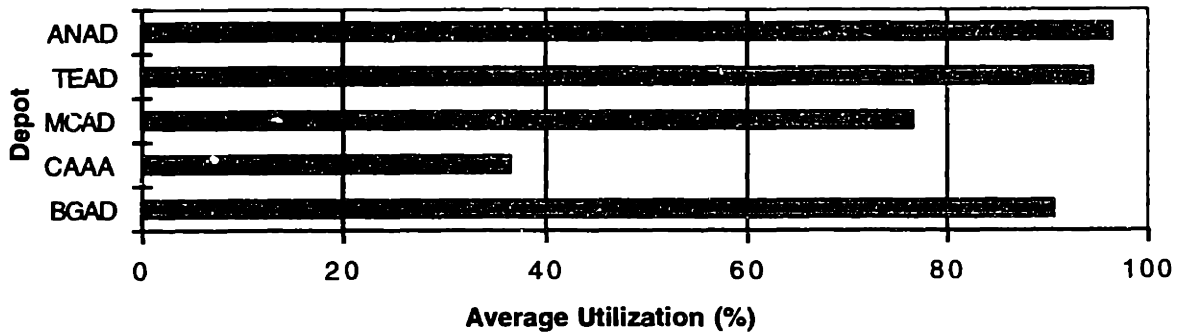
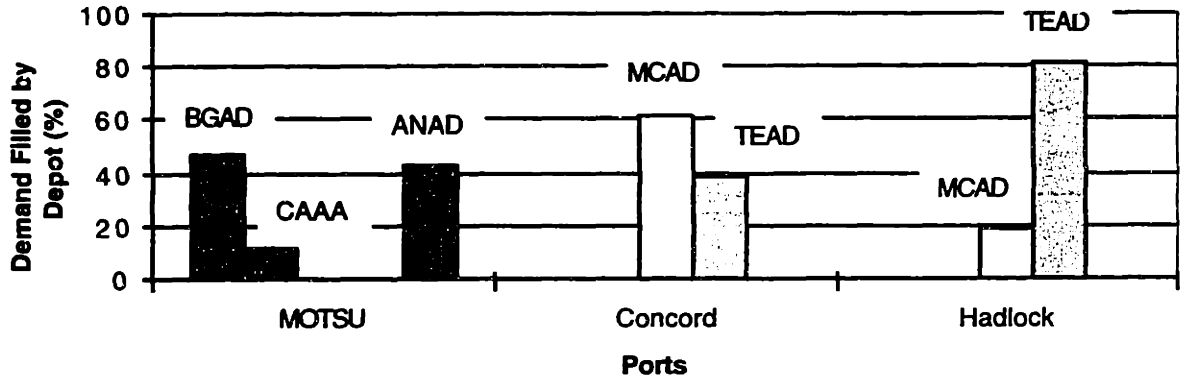
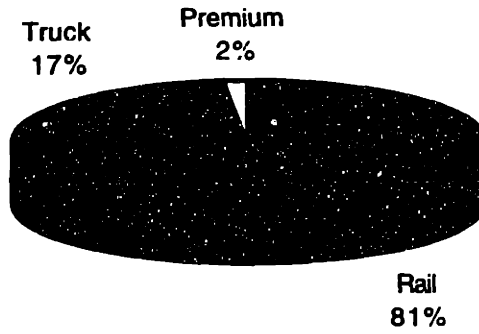

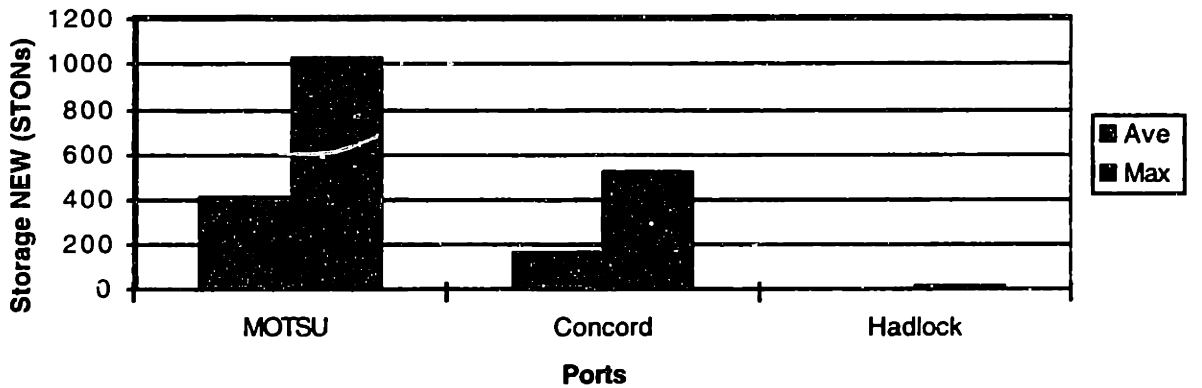
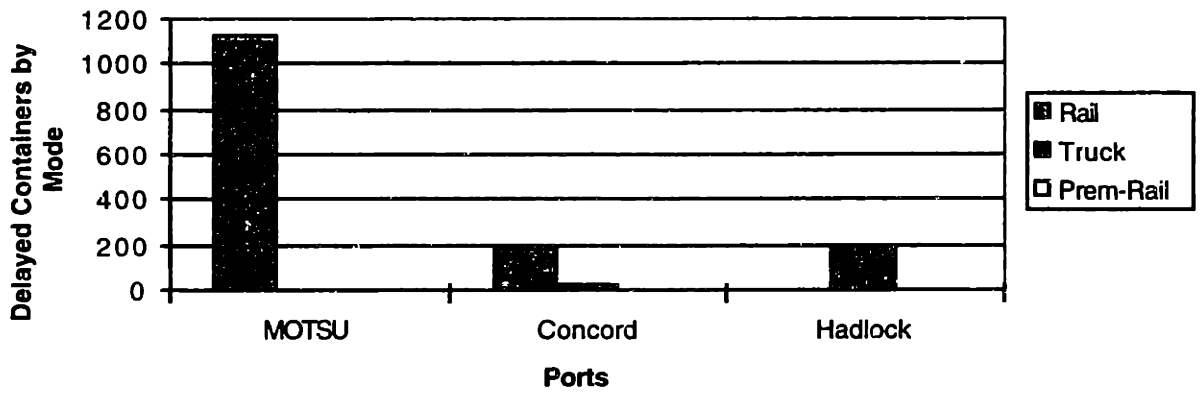
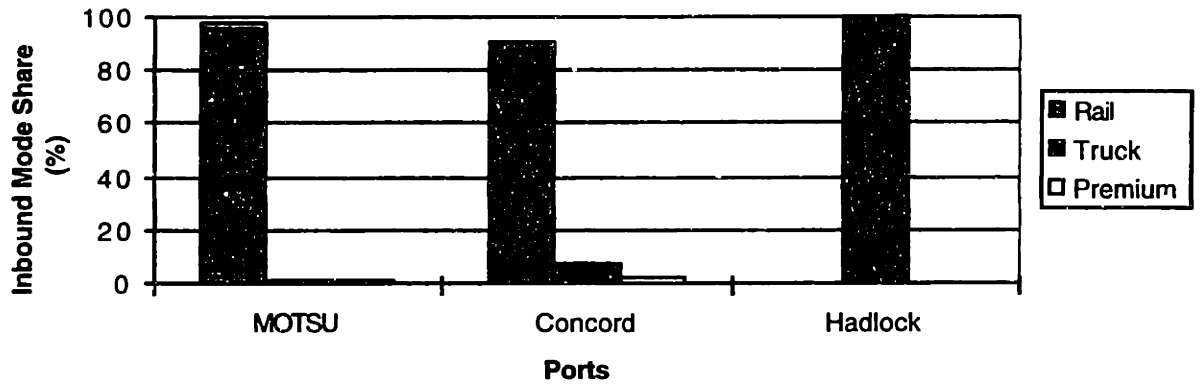
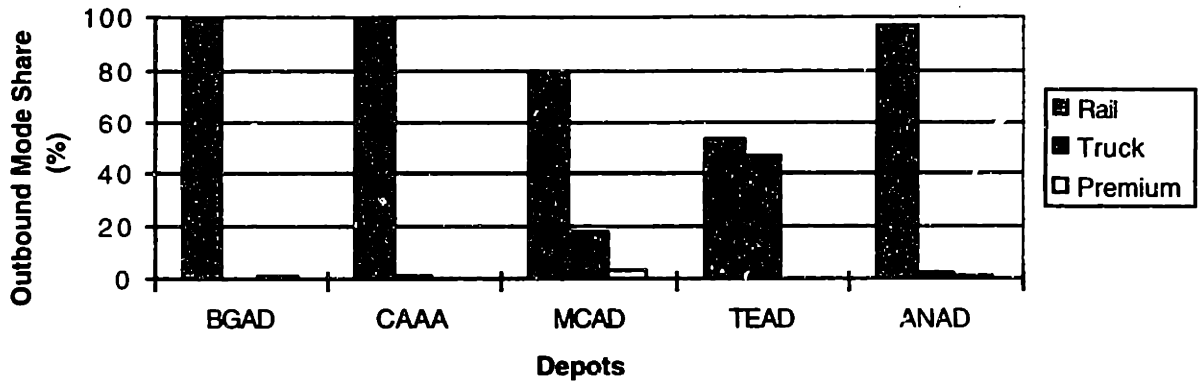

Cut Concord Conveyance Throughput 5%

System Mode Mix

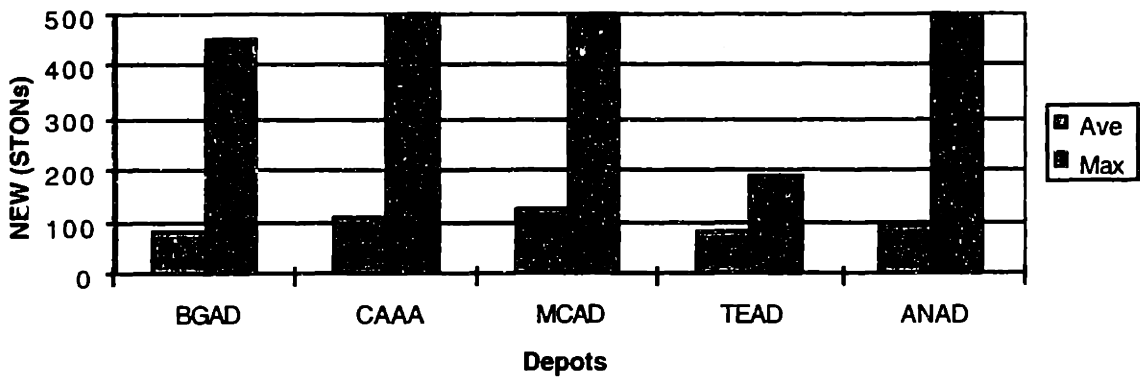
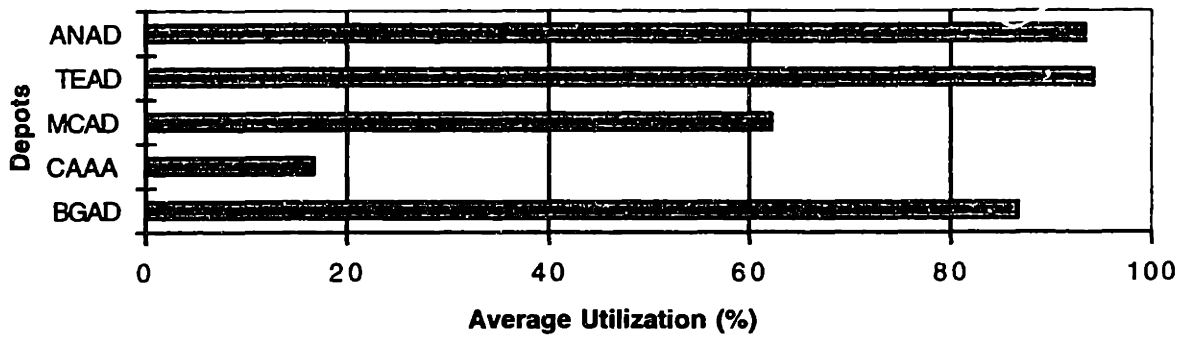
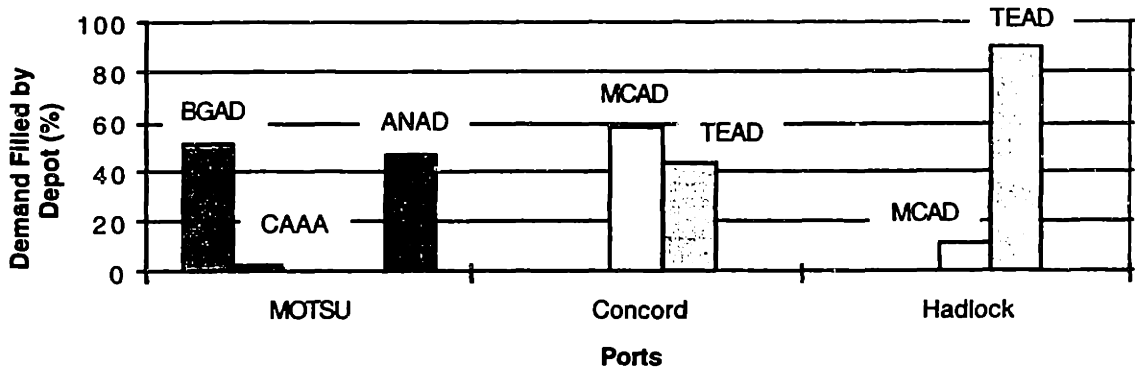
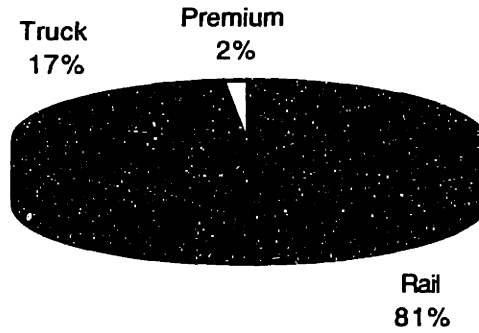

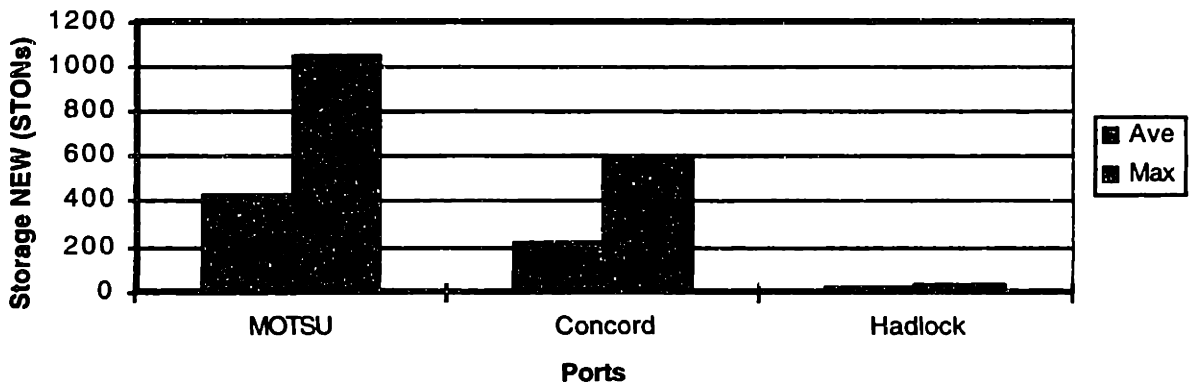
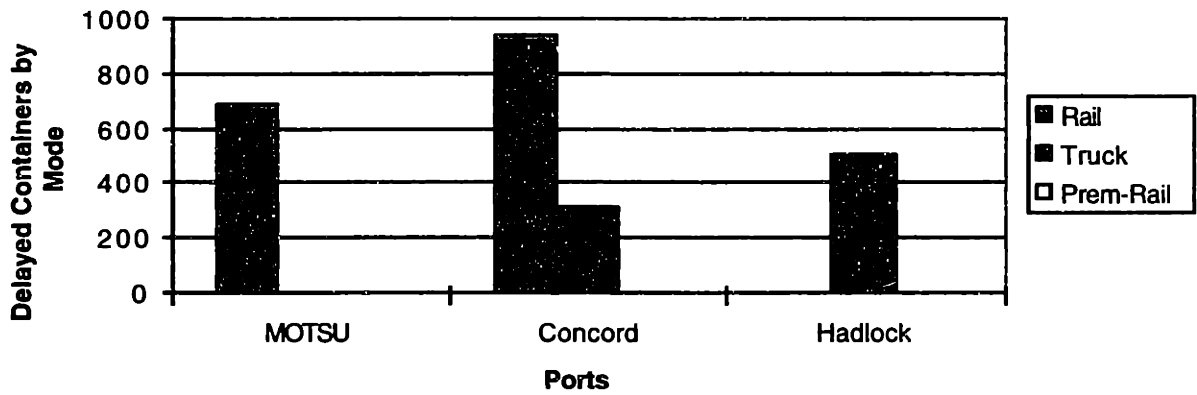
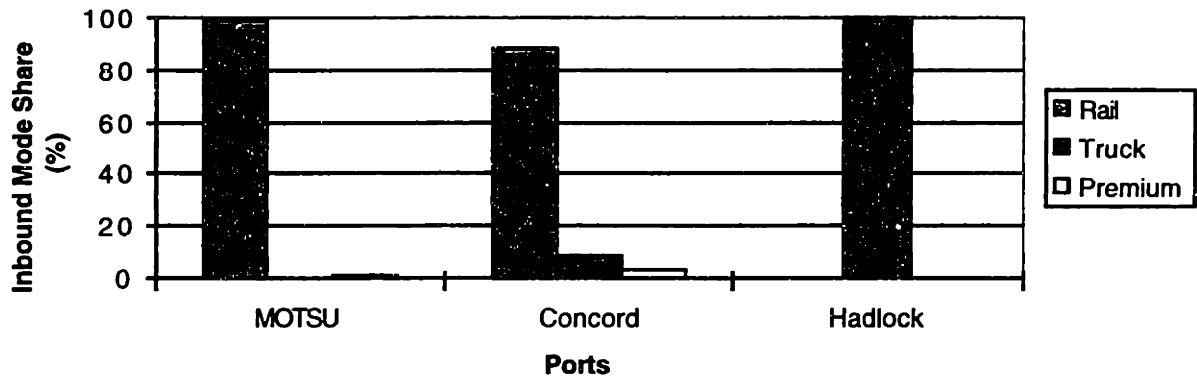
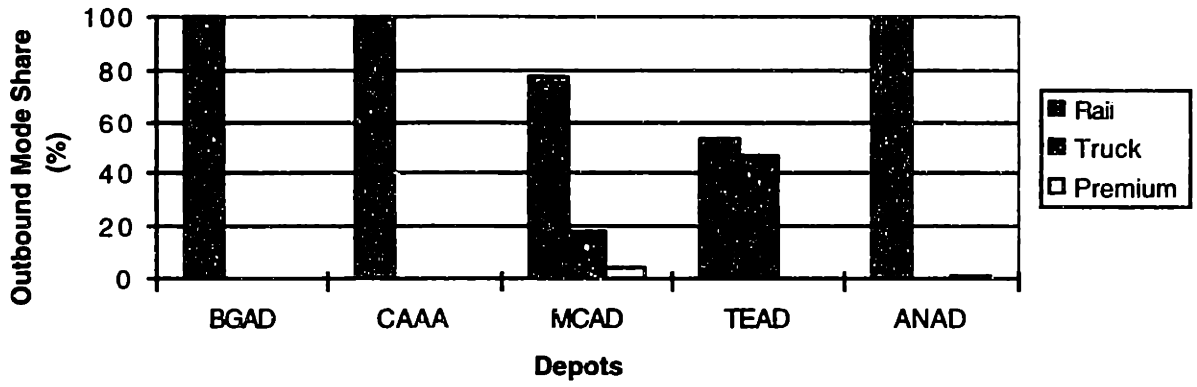

Increase Concord Conveyance Throughput 5%

System Mode Mix

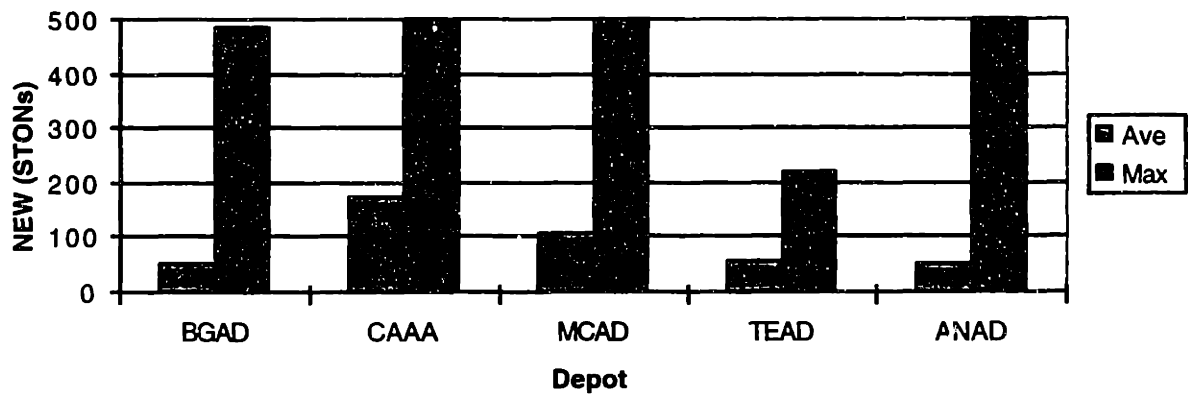
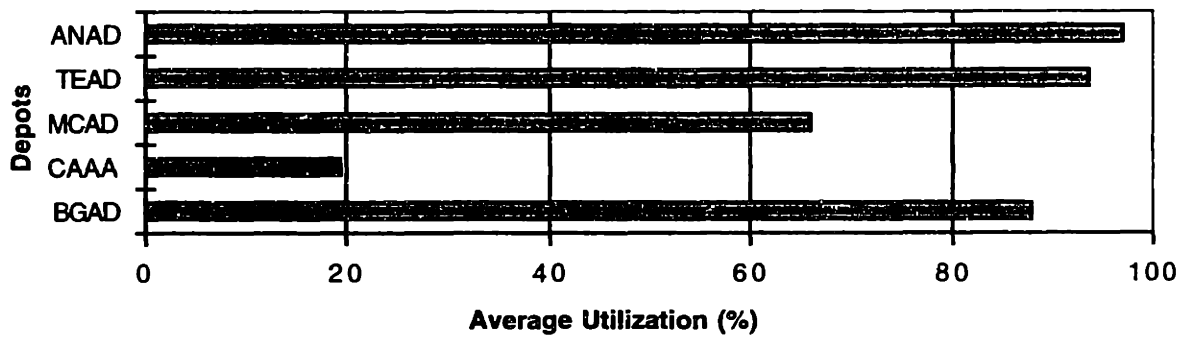
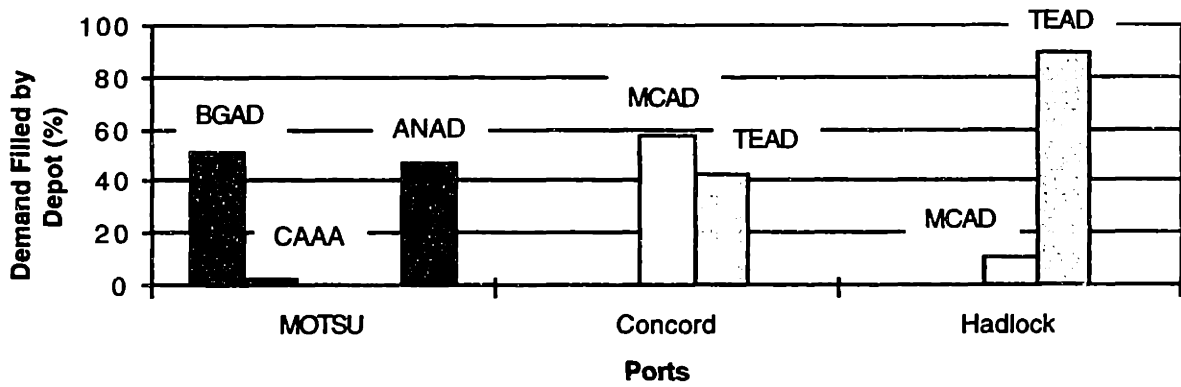
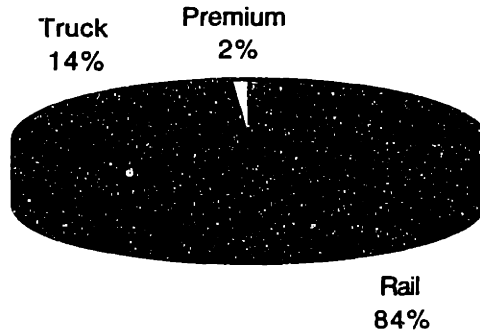

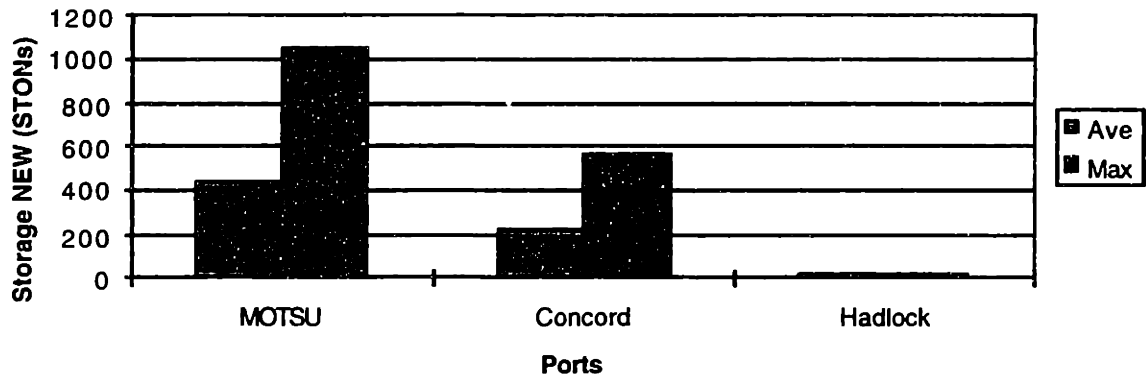
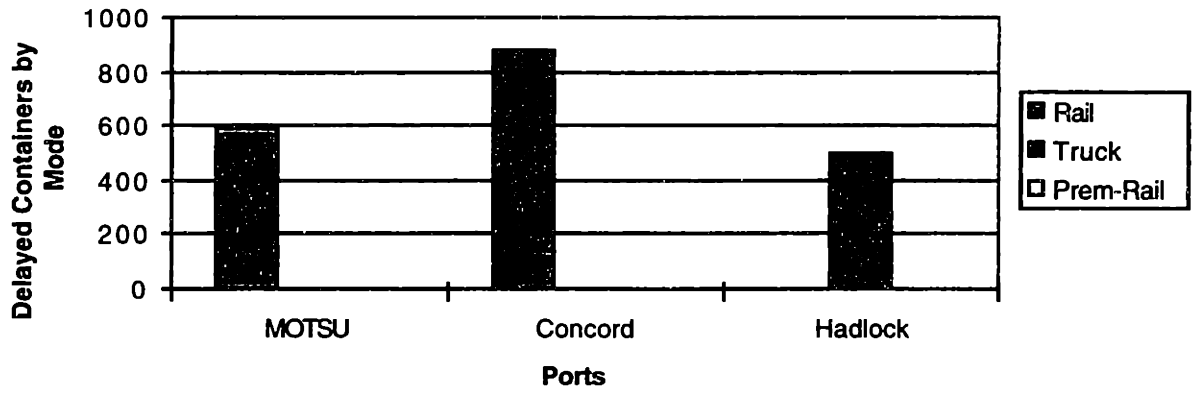
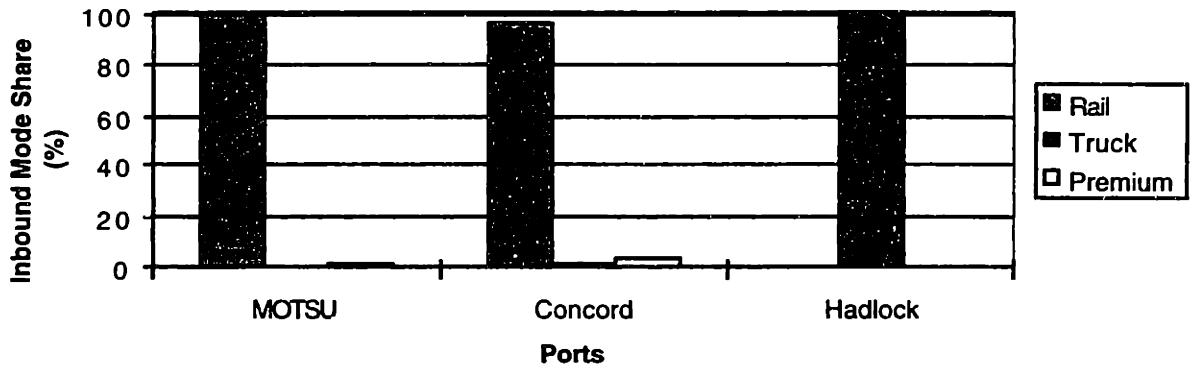
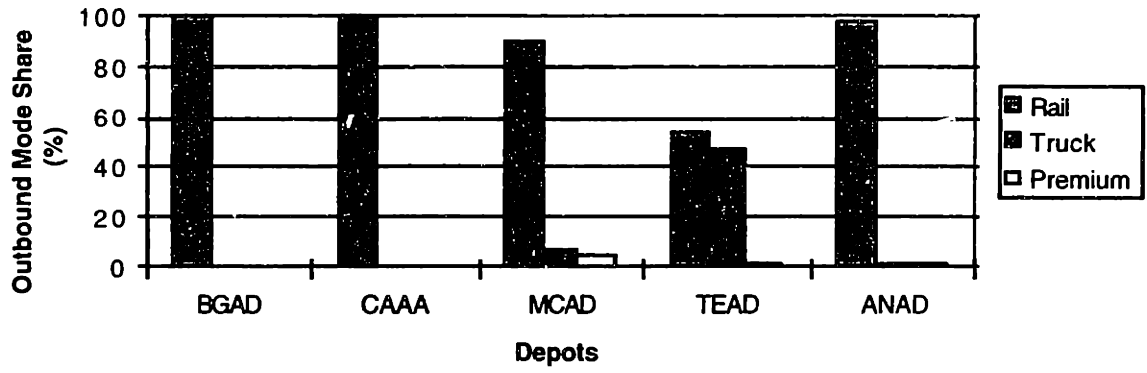

Change Concord Input Mix to 60% Rail/20% Truck

System Mode Mix

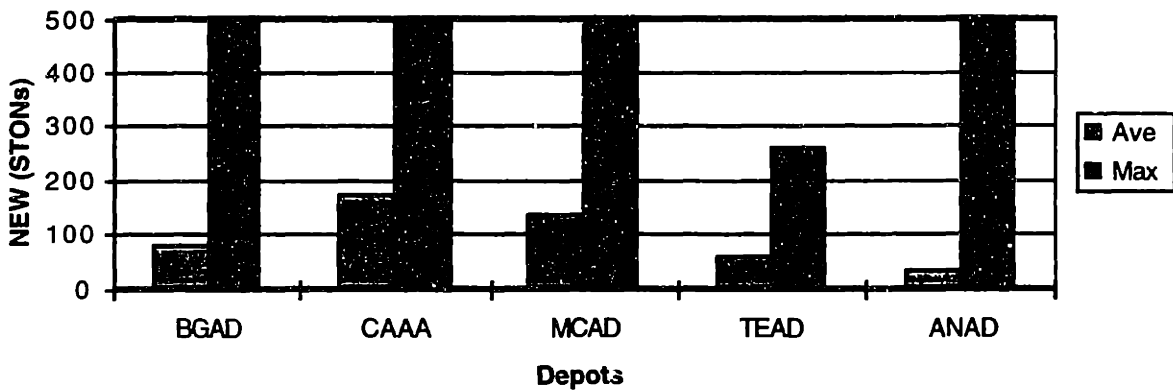
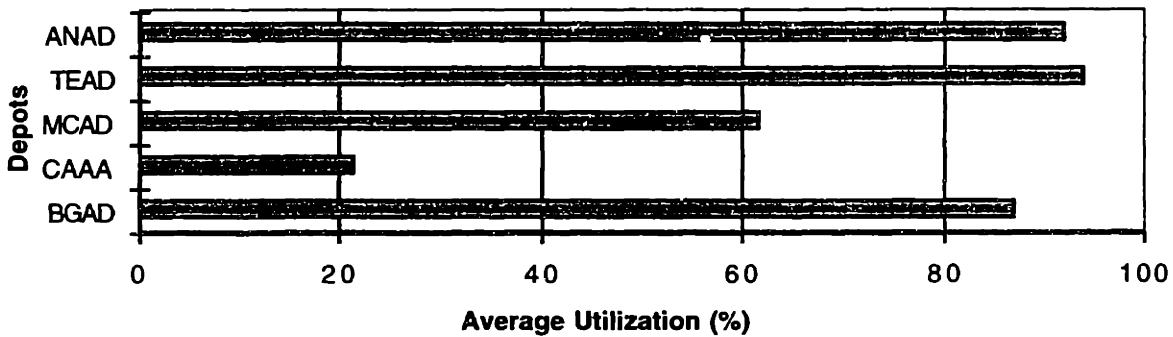
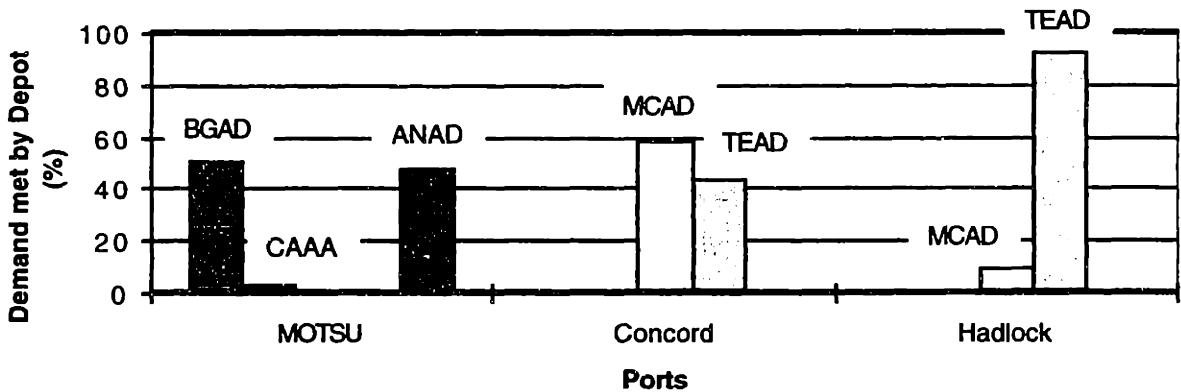
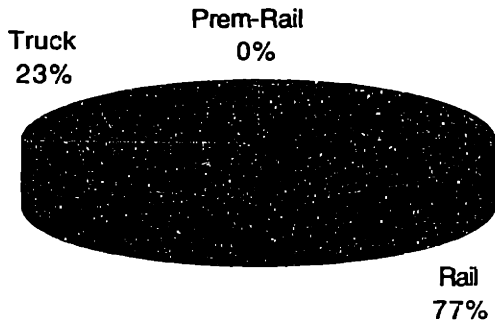

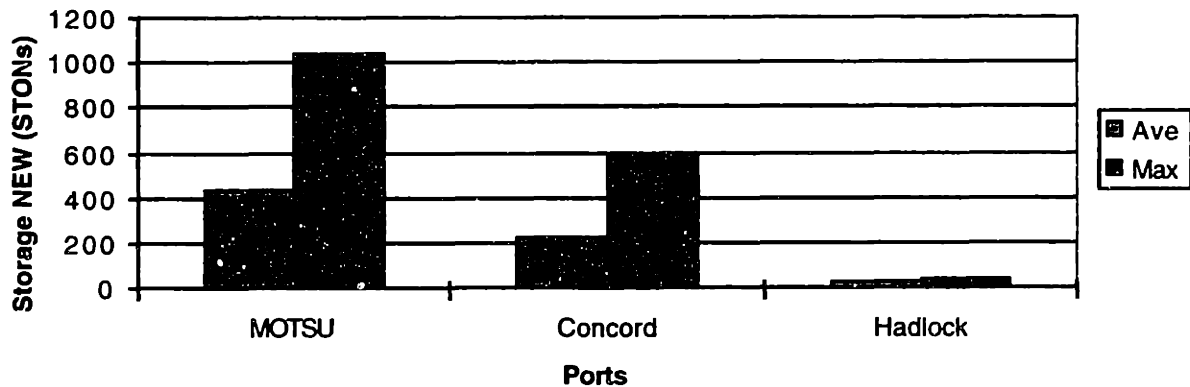
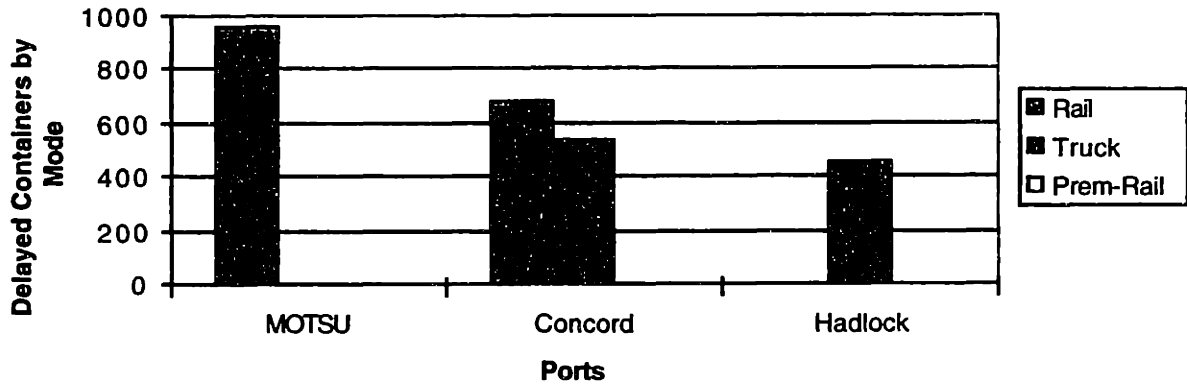
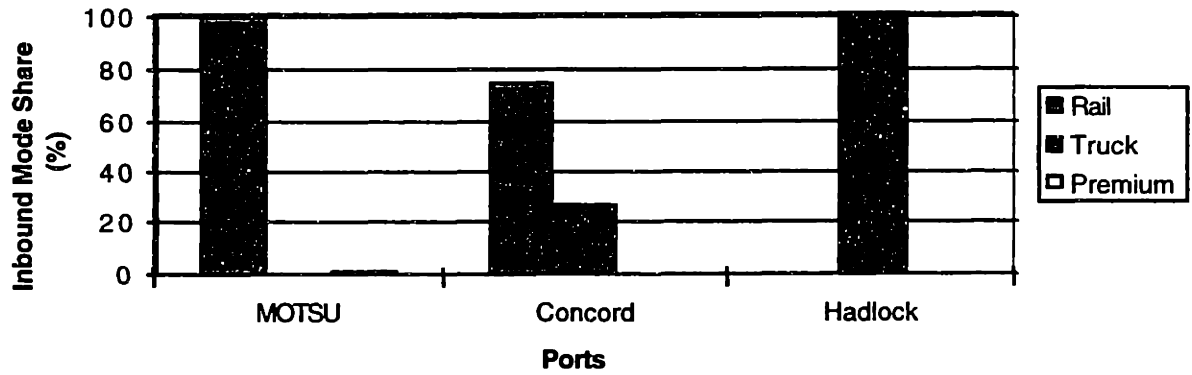
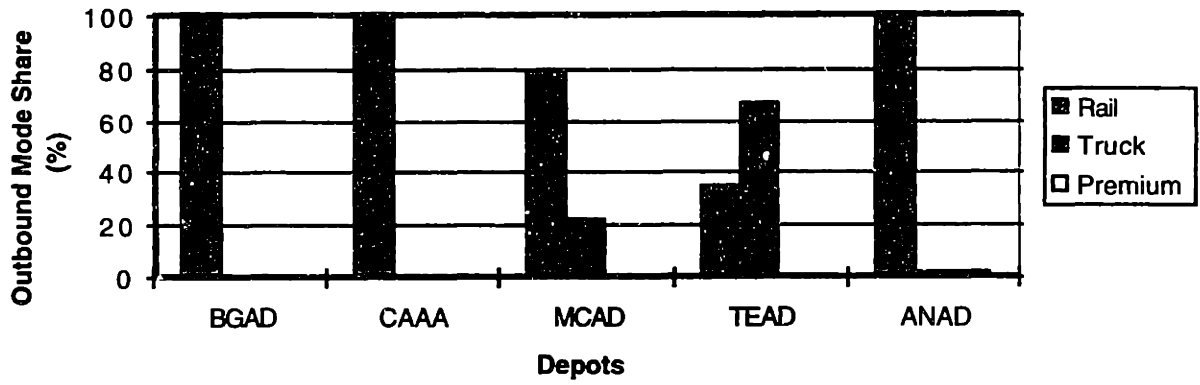

Introduce Concord Containerization (Depot) Operations

System Mode Mix

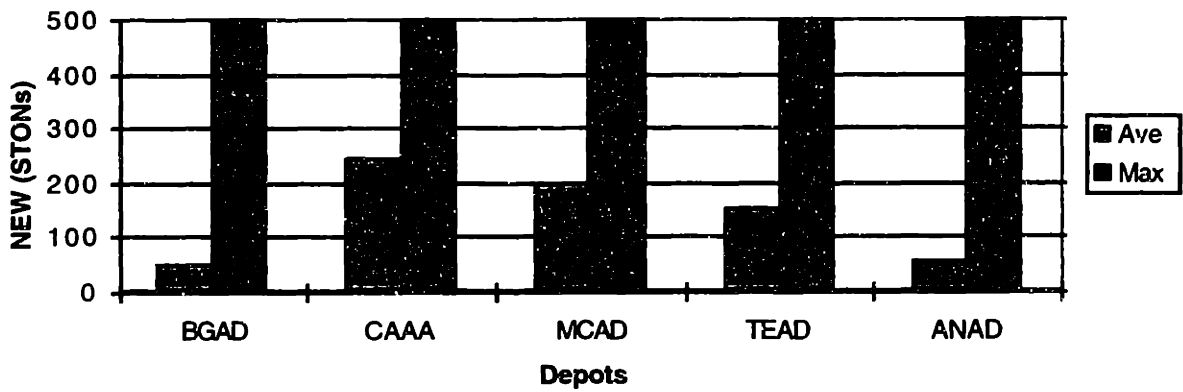
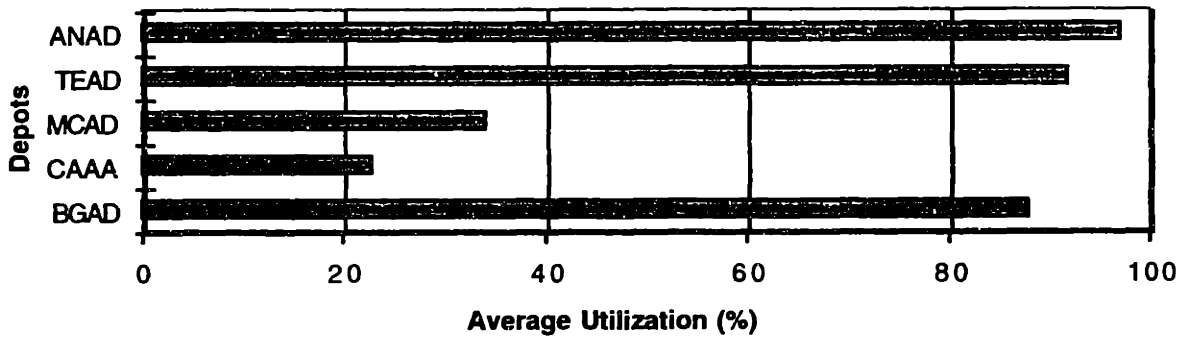
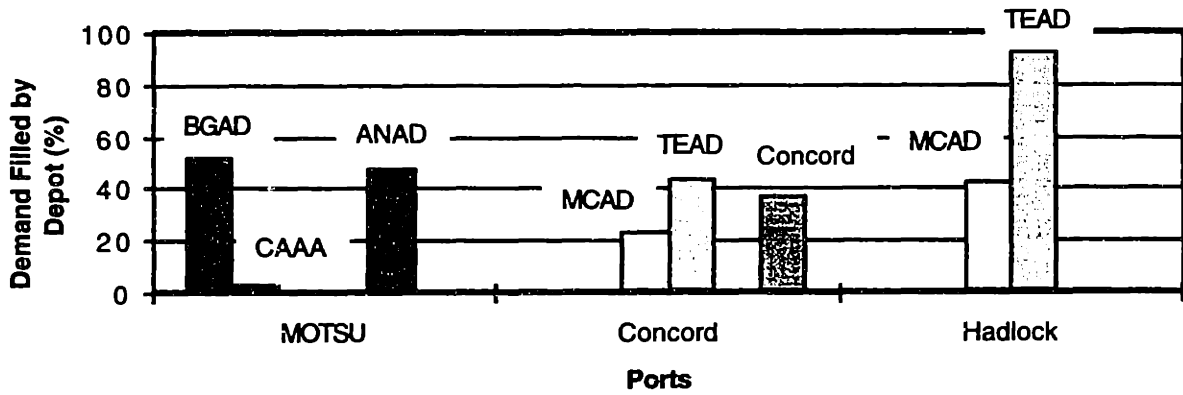
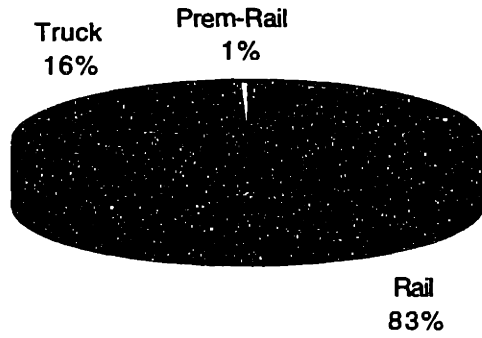

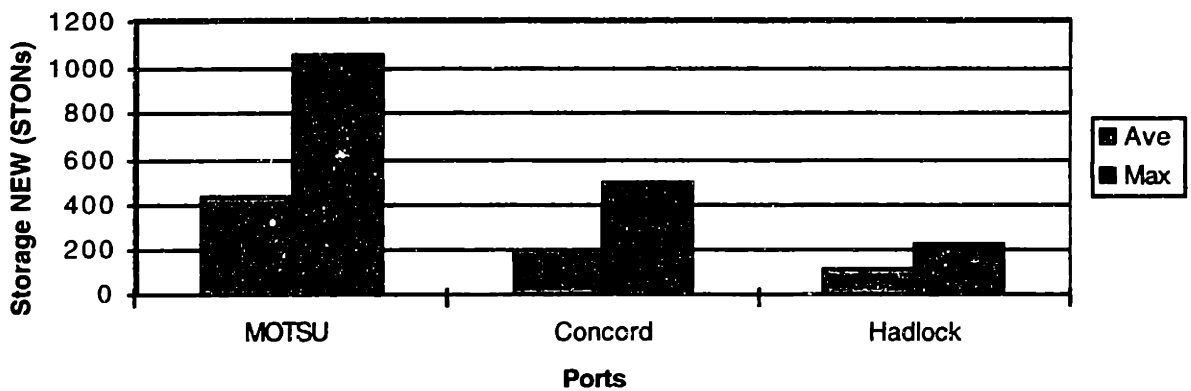
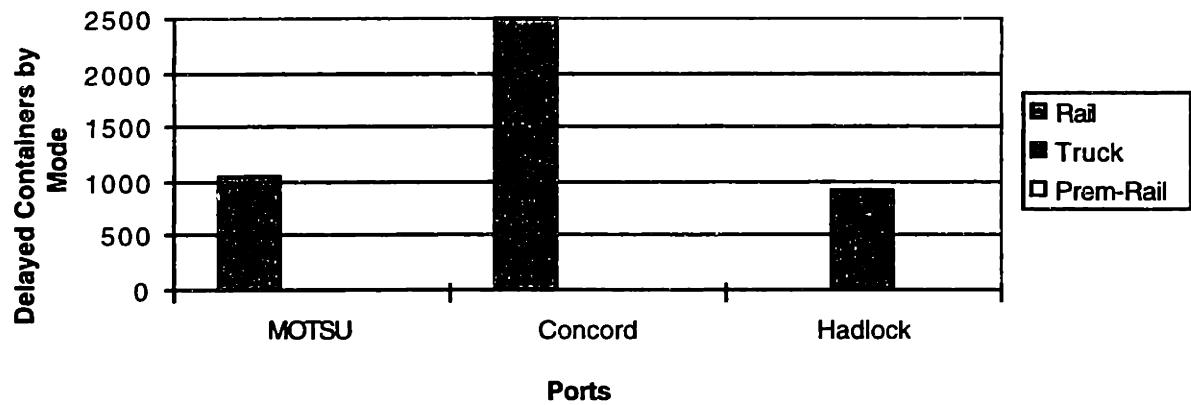
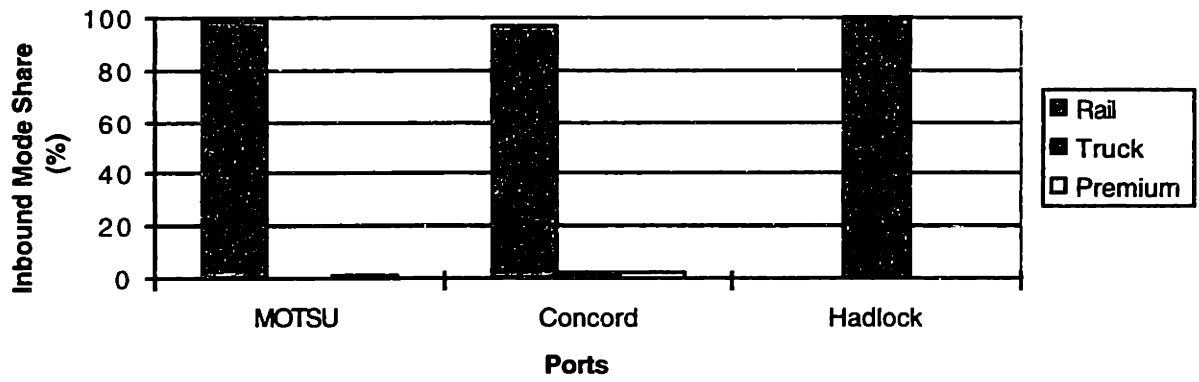
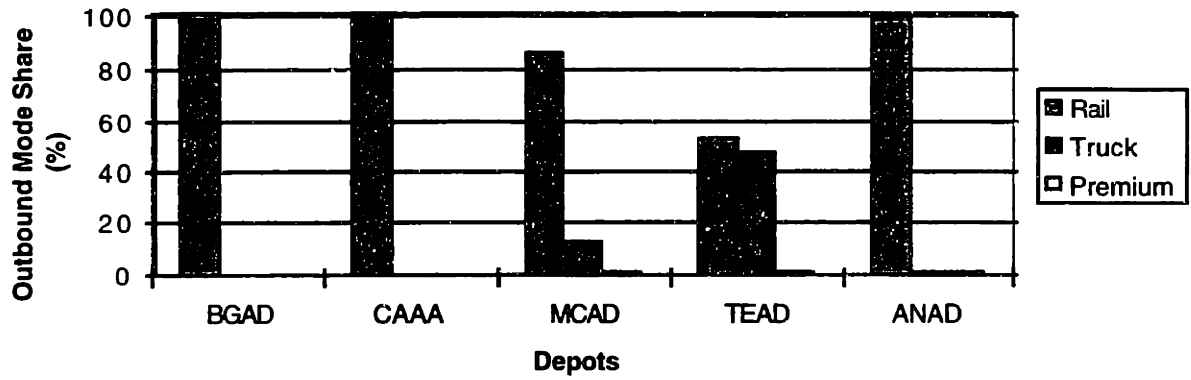

Cut Lead Time by One Day

System Mode Mix

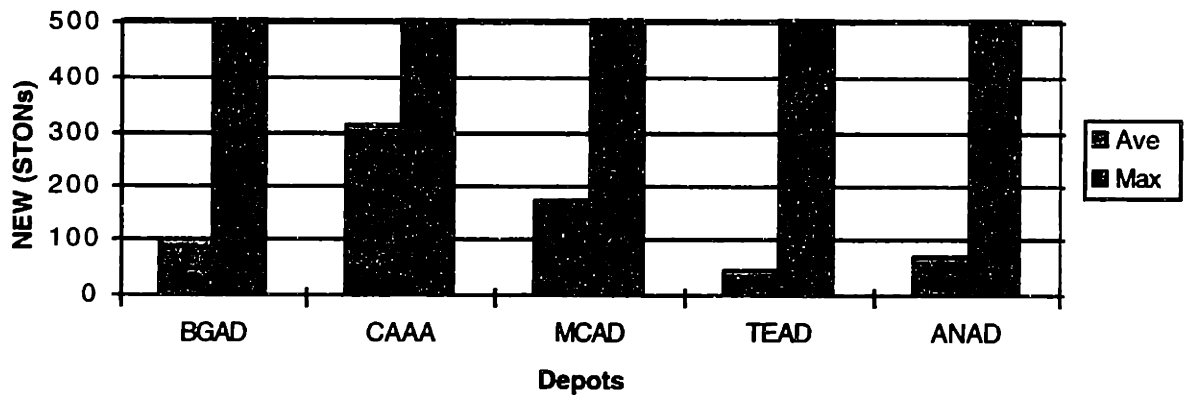
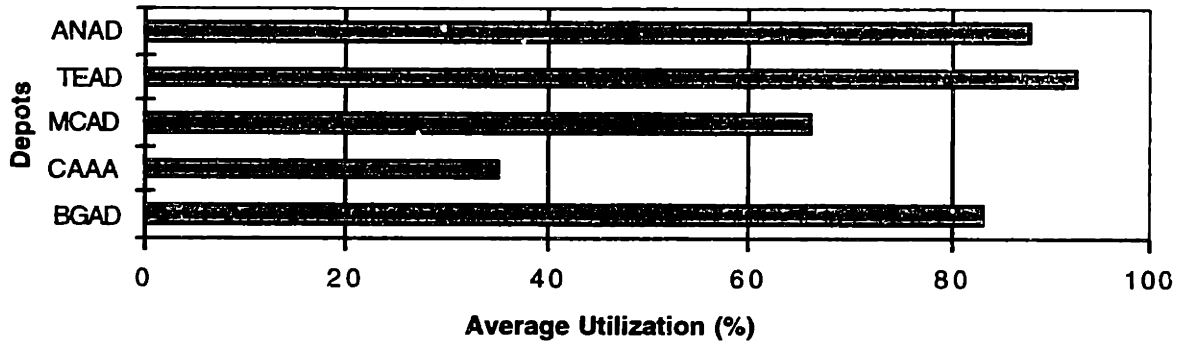
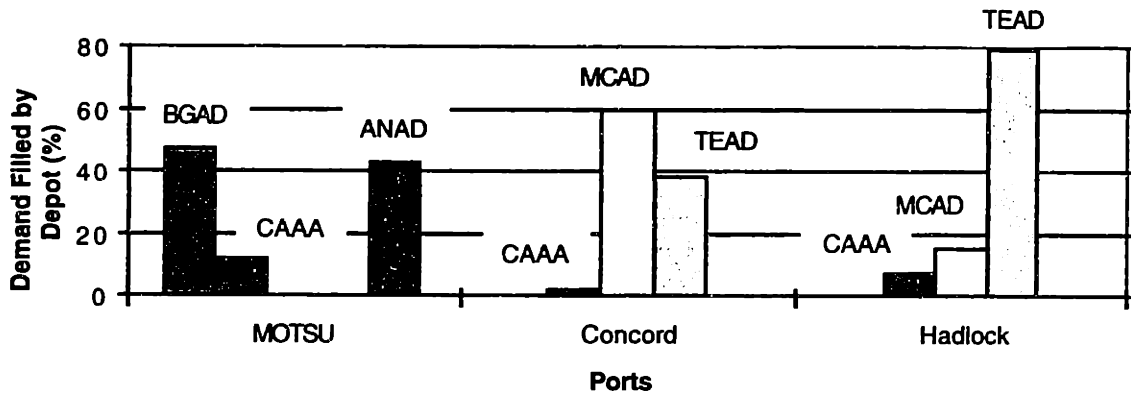
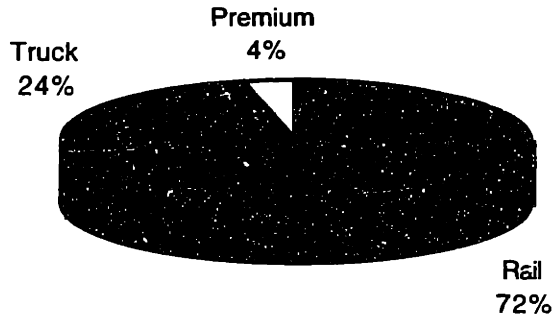

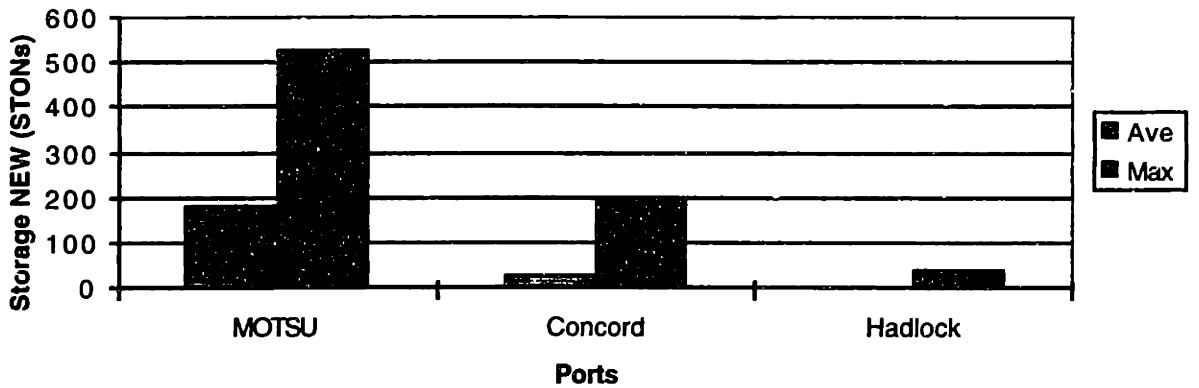
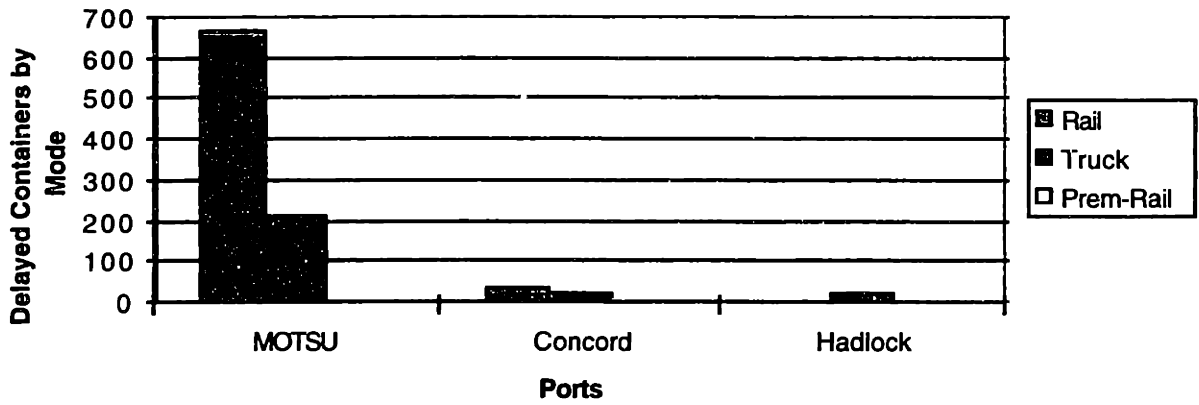
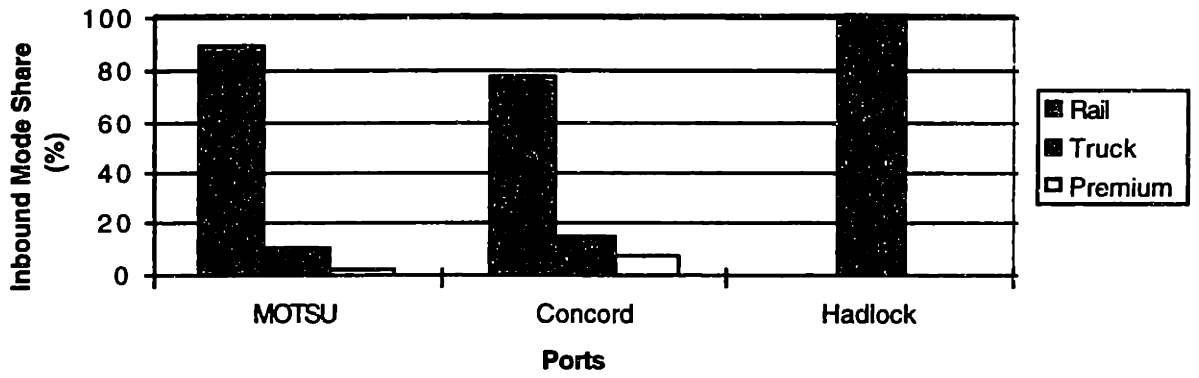
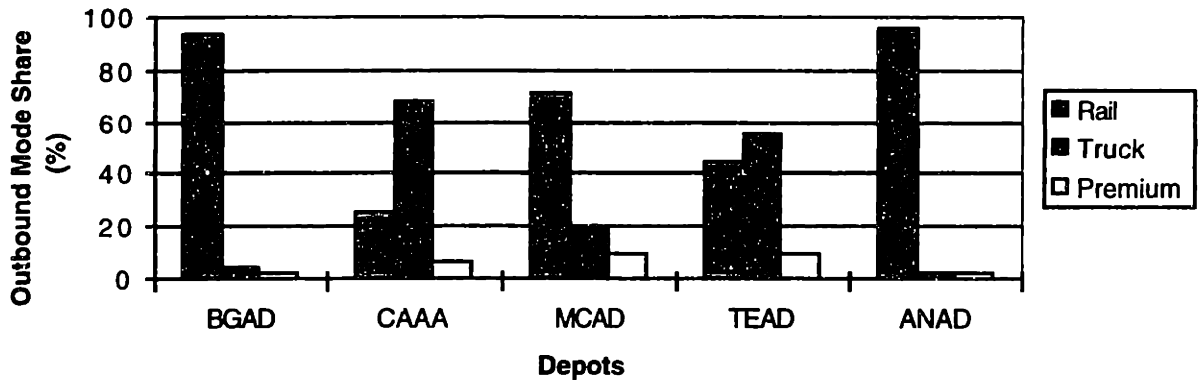

Glossary of Acronyms

AIS	Automated Information System
AIT	Automatic Identification Technology
ALD	Available to Load Date
AMC	Air Mobility Command
AMCCOM	Army Armament Munitions and Chemical Command
ANAD	Anniston Army Depot
ANSI	American National Standards Institute
APS	Afloat Prepositioning Ships
ARMS	Armament Retooling and Manufacturing Support
ASMP	Army Strategic Mobility Plan
ATCMD	Advance Transportation Control and Movement Document
AWR	Army War Reserve
BGAD	Bluegrass Army Depot
BRAC	Base Realignment and Closure
BURU	Bottom-Up Review
C ²	Command and Control
C ⁴ I	Command, Control, Communications, Computers, and Information Systems
CAAA	Crane Army Ammunition Activity
CADS	Containerized Ammunition Distribution System
CAPS II	Consolidated Aerial Port System II
CBL	Commercial Bill of Lading
CCP	Container Consolidation Point
CFM	CONUS Freight Management System
CFS	Container Freight Station

CINC	Commander In Chief
COA	Course of Action
CONUS	Continental United States
CRD	CINC's Required Date
CROP	Container Roll-In-Roll-Out Platform
CSA	Chief of Staff of the Army
DAAS	Defense Automatic Addressing System
DAMMS-R	Department of the Army Movement Management System - Redesign
DLA	Defense Logistics Agency
DoD	Department of Defense
DSS	Distributed Standard System
DTMR	Defense Traffic Management Regulation
DTTS	Defense Transportation Tracking System
EAD	Earliest Arrival Date
EDI	Electronic Data Interchange
ETR	Export Traffic Release
ETRR	Export Traffic Release Request
FOC	Full Operating Capability
FY	Fiscal Year
GAMS	General Algebraic Modeling System
GBL	Government Bill of Lading
GCCS	Global Command and Control System
GDSS	Geographical Decision Support System
GTN	Global Transportation Network
HWAD	Hawthorne Army Depot

IASMP	Integrated Ammunition Stockpile Management Plan
ICP	Inventory Control Point
IMMP	Integrated Munitions Management Project
IOC	Industrial Operations Command (or Initial Operating Capability)
ISO	International Standards Organization
ITO	Installation Transportation Office
ITV	In-Transit Visibility
JFAST	Joint Flow Analysis System for Transportation
JLSC	Joint Logistics Systems Center
JMTCA	Joint Munitions Transportation Coordinating Activity
JOPES	Joint Operations Planning and Execution System
JS J-4	Joint Staff, Logistics Directorate
JTAV	Joint Total Asset Visibility
JTCC	Joint Transportation Corporate Information Management Center
JTF	Joint Task Force
LAD	Latest Arrival Date
LASH	Lighter Aboard Ship
LEAD	Letterkenny Army Depot
LIC	Low Intensity Conflict
LIPS	Logistics Information Processing System
LP	Linear Program(ming)
MCAD	McAlester Army Depot
MHE	Material Handling Equipment
MILSTAMP	Military Standard Transportation and Movement Procedures
MILSTRIP	Military Standard Requisition and Issue Procedures

MLAST	Munitions Logistics Analysis Support Tool
MMS	Material Management System
MOTSU	Military Ocean Terminal Sunny Point
MRC	Major Regional Conflict
MRS	Mobility Requirements Study
MSC	Military Sealift Command
MTMC	Military Traffic Management Command
MTON	Measurement Ton
NCA	National Command Authority
NEW	Net Explosive Weight
NSN	National Stock Number
NWS	Naval Weapons Station
OCCA	Ocean Cargo Clearance Authority
OCONUS	Outside the Continental United States
OPLAN	Operational Plan
OPORD	Operational Order
OSD	Office of the Secretary of Defense
POD	Port of Debarkation
POE	Port of Embarkation
PPBS	Planning, Programming, and Budgeting System
R ³	Resource, Recovery, and Recycling
RDD	Required Delivery Date
RF	Radio Frequency
RLD	Ready to Load Date
RoRo	Roll-On/Roll-Off

RRAD	Red River Army Depot
RSS&I	Receipt, Storage, Segregation and Issue
S&M	Schedule and Movement
SCL	Strategic Configured Load
SMCA	Single Manager for Conventional Ammunition
SPAN	Sunny Point Automated Network
STACCS	Standard Theater Army Command and Control System
STON	Short Ton
TAMMS	Total Ammunition Movement Management System
TAT	To Accompany Troops
TAV	Total Asset Visibility
TC AIMS	Transportation Coordinator's Automated Information for Movement System
TCMD	Transportation Control and Movement Document
TCN	Transportation Control Number
TEAD	Tooele Army Depot
TEU	Twenty Foot Equivalent Unit
TPFDD	Time Phased Force Deployment Data
TRAC2ES	TRANSCOM Regulating Command and Control Evacuation System
TRAMS	Transportation Automated Management System
TRANSCOM	Transportation Command
UHF	Ultra High Frequency
USTRANSCOM	United States Transportation Command
WASP	Wholesale Ammunition Stockpile Program
WPS	World Wide Port System
WWMCCS	World Wide Military Command and Control System

References

1. TRADOC Munitions System Management Office. *Ammunition XXI*. Presentation at the 7th Annual Munitions Transportation Conference, Rock Island, IL, June, 1997.
2. James, Nile. *NWS Concord Infrastructure Update*. Presentation at the 7th Annual Munitions Transportation Conference, Rock Island, IL, June, 1997.
3. JMTCA. *Army Strategic Mobility Plan Update*. Presentation at the 7th Annual Munitions Transportation Conference, Rock Island, IL, June, 1997.
4. Ahuja, Ravindra K., Thomas L. Magnanti, and James B. Orlin. *Network Flows: Theory, Algorithms, and Applications*. Prentice Hall, Englewood Cliffs, NJ, 1993.
5. *Annual Report*. US Army Industrial Operations Command, Rock Island, IL, 1996.
6. Anthony, Robert N. *Planning and Control Systems: A Framework for Analysis*. Harvard Graduate School of Business Administration, Boston, MA, 1965.
7. Armacost, Andrew P. *Modeling Railroad Terminal Operations: Supporting Real-Time Network Planning and Control*. CSDL-T-1247, SM Thesis in Operations Research, Massachusetts Institute of Technology. C.S. Draper Laboratory, Cambridge, MA, June 1995.
8. Atkins, Capt. Warren H. *Modern Marine Terminal Operations and Management*. The Port of Oakland, Oakland, CA, 1983.
9. Barnhart, Cynthia and Rajesh Sheno. "Long-Haul Crew Scheduling: Models and Methods." *Transportation Science*, 1996.
10. Begert, Maj. Gen. William, USAF. "The Global Transportation Network." *Defense Transportation Journal*. September/October 1996.
11. Benbow, Lt. Col. Robert, USMC. *Joint Ordnance Wargame '97*. Presentation at the 7th Annual Munitions Transportation Conference, Rock Island, IL, June, 1997.
12. Brennan, Terry. "Trend Toward Multi-Carrier Partnerships Seen as Catalyst to Major Port Changes." *Traffic World*. 16 October 1995, pp. 25-27.
13. Bradley, Stephen P., Arnaldo C. Hax, and Thomas L. Magnanti. *Applied Mathematical Programming*. Addison Wesley, Reading, MA, 1977.
14. Branch, Alan E. *Elements of Port Operation and Management*. Chapman and Hall, New York, NY, 1986.
15. *Business Requirements for Containerized Munitions*. Naval Weapons Station Concord, Information Technology Center (Code 54), Concord, CA, 10 December 1996.
16. Castilho, Bernardo De and Carlos F. Daganzo. "Handling Strategies for Import Containers at Marine Terminals." *Transportation Research-B*. Vol. 27B, No. 2, pp. 151-166, 1993.

-
17. Coakley, Thomas P. *Command and Control for War and Peace*. National Defense University Press, Washington DC, 1992.
 18. Cottrill, Ken. "US Ports Buffeted by Harsh Commercial Climate." *Traffic World*. 16 October 1995, pp. 27-30.
 19. Deputy Under Secretary of Defense (Logistics), and Joint Defense Total Asset Visibility Office. *Defense Total Asset Visibility Implementation Plan*. Logistics Management Institute, McLean, VA, February 1995.
 20. Frankel, Ernst G. *Port Planning and Development*. John Wiley and Sons, New York, NY, 1987.
 21. GAO Report NSIAD-92-258. *Operation Desert Storm, Lack of Accountability Over Material During Redeployment*. May 1992.
 22. Guha, Tathagata and C. Michael Walton. "Intermodal Container Ports: Application of Automatic Vehicle Classification System for Collecting Trip Generation Data." *Transportation Research Record 1383*, pp 17-23.
 23. Imakita, J. *A Techno-Economic Analysis of the Port Transport System*. Praeger, New York, NY, 1978.
 24. *Integrated Ammunition Stockpile Management Plan*. Department of Defense Single Manager for Conventional Ammunition; Armament, Material, and Chemical Command, Rock Island, IL, May 1994.
 25. *Integrated Munitions Management Project (IMMP)*. Scoping Workshop Slides. Military Traffic Management Command, Falls Church, VA, August 1996.
 26. Kiesling, Max K. and C. Michael Walton. "Time Motion Analysis of Wharf Crane Operations." *Transportation Research Record 1383*, pp. 24-30.
 27. Knicker, Timothy S. *Analytical Modeling of an Intermodal Rail/Truck Terminal*. C.S. Draper Laboratory, Cambridge, MA, 3 May 1996.
 28. Kolitz, Stephan E. *Munitions Logistics Analysis Support Tool (MLAST)*. CSDL Proposal 8-503. C.S. Draper Laboratory, Cambridge, MA, 1997.
 29. Kozan, Erhan. "Comparison of Analytical and Simulation Planning Models of Seaport Container Terminals." *Transportation Planning and Technology*. Vol. 20, pp. 235-248.
 30. Law, Averill M. and W. David Kelton. *Simulation Modeling and Analysis*. 2nd ed. Mc-Graw Hill, New York, NY, 1991.
 31. Levis, Alexander H. and Michael Athans. "The Quest for a C³ Theory: Dreams and Realities." *Science of Command and Control: Coping with Uncertainty*. Stuart E. Johnson and Alexander H. Levis, editors. AFCEA International Press, Washington, DC, 1988.
 32. Liberty, Jesse and J. Mark Hord. *Teach Yourself ANSI C++ in 21 Days*. Premier Edition. SAMS Publishing, Indianapolis, IN, 1996.

-
33. Loy, Ursula M. *Integrated Munitions Management Project (IMMP)*. MTMC Memorandum MTIM-I (25-400). Military Traffic Management Command, Falls Church, VA, 11 October 1996.
 34. Magnanti, Thomas L. and R.W. Simpson. *Transportation Network Analysis and Decomposition Methods*. Report No. dot-tsc-rspd-78-6, US Department of Transportation, 1978.
 35. Major, Michael J. "Strong Transpacific Trade Growth Drives Expansion at Pacific Northwest Ports." *Traffic World*. 16 October 1995, pp. 35-36
 36. MOTSU Regulation 55-1. *Terminal Operations Procedures*. 1303rd Major Port Command/Military Ocean Terminal Sunny Point, Southport, NC, 3 February 1994.
 37. MTMC Regulation 56-59. *Surface Transportation Terminal Operations*. Military Traffic Management Command, Falls Church, VA.
 38. MTMCTEA Reference 97-700-2. *Logistics Handbook for Strategic Mobility Planning*. Military Traffic Management Command/Transportation Engineering Agency, Newport News, VA, August, 1997.
 39. MTMCTEA Reference 94-700-2. *Logistics Handbook for Strategic Mobility Planning*. Military Traffic Management Command/Transportation Engineering Agency, Newport News, VA, April, 1994.
 40. Nelson, Mark. *C++ Programmer's Guide to the Standard Template Library*. IDG Books Worldwide, Foster City, CA, 1995.
 41. Nevins, Michael R., and Joseph Joines. "PORTSIM: An Object-Oriented Port Simulation." *Proceedings of the 1995 Summer Computer Simulation Conference*, pp. 160-165.
 42. Nevins, Michael R., Charles M. Macal and Joseph Joines. *A Discrete Event Simulation Model for Seaport Operations*. Argonne National Laboratory, Argonne, IL, 1997
 43. Oaks, David M. *Should the US Army Adopt New Policies and Procedures for Responding to Emergency Armament Demands?* Ph.D. Dissertation in Public Policy, RAND Graduate School, Santa Monica, CA, May 1996.
 44. *Operations Research*. Preface to special issue on scheduling. Vol. 26, No. 1, pp. 1-2, January/February 1978.
 45. Pagonis, Lt. Gen. William G, USA. *Moving Mountains: Lessons in Leadership and Logistics from the Gulf War*. Harvard Business School Press, Boston, MA, 1992.
 46. Peterkofsky, Roy I. and Carlos F. Daganzo. "A Branch and Bound Solution Method for the Crane Scheduling Problem." *Transportation Research*. Vol. 24B, No. 3, pp. 159-172, 1990.
 47. Powell, Warren B. and Tassio A. Carvalho. *Optimal Control of Logistics Queueing Networks*. Statistics and Operations Research Technical Report SOR-95-XX, Princeton University, 8 August 1995.

-
48. Powell, Warren B. "Optimization Models and Algorithms: An Emerging Technology for the Motor Carrier Industry." *IEEE Transactions on Vehicular Technology*. Vol. 40, No. 1, pp. 68-80, February 1991.
 49. Powell, Warren B. *Toward a Unified Modeling Framework for Real-Time Control of Logistics*. Statistics and Operations Research Technical Report SOR-95-09, Princeton University, April 1995.
 50. Rumbaugh, James, Michael Blaha, William Premerlani, Frederick Eddy and William Lorenson. *Object Oriented Modeling and Design*. Prentice Hall, Englewood Cliffs, NJ, 1991.
 51. Sabria, F. *Analysis of Potential Improvements in Port Operations*. Ph.D. Thesis, Dept. of Civil Engineering (UCB-ITS-DS-86-1, Institute of Transportation Studies), University of California, Berkeley, 1986.
 52. Saginaw, D. J. II and A. N. Perakis. "A Decision Support System for Containership Stowage Planning." *Marine Technology*. Vol. 26, No. 1, pp. 47-61, January 1989.
 53. Schaible, Raymond A., James A. Weiss, and Henry C. Fortenberry. *Army Requirements for a West Coast Containerized Ammunition Port, Afloat Prepositioning Maintenance Facility, and Watercraft Maintenance Facility*. LMI Report AR105RD1. Logistics Management Institute, McLean, VA, September 1993.
 54. Schank, John, Michael Mattock, Gerald Sumner, Irwin Greenberg, Jeff Rothenberg, and James P. Stucker. *A Review of Strategic Mobility Models and Analysis*. RAND National Defense Research Institute Report R-3926-JS. RAND, Santa Monica, CA, 1991.
 55. Scott, D. K. and Chen. D. S.. *A Loading Model for a Containership*. Matson Navigation Company, Oakland, CA, November 1978.
 56. Shields, Jonathan J. "Containership Stowage: A Computer-Aided Preplanning System." *Marine Technology*. Vol. 21, No. 4, pp. 370 - 383, October 1984.
 57. Snyder, Terry W. and Charles D. Guilliams. *Integration of Automatic Identification Technology into MTMC Operations*. LMI Report MT501MR1. Logistics Management Institute, McLean, VA, August 1995.
 58. Straight, Roger. MTMCTEA Final Draft Report: SE-94-3a-37. *Concord Container Throughput Analysis*. Military Traffic Management Command/Transportation Engineering Agency, Newport News, VA, 8 November 1995.
 59. Thuermer, Karen E. "Competition Between N. European Ports Heats Up as Containerized Cargo Booms." *Traffic World*. 16 October 1995, pp. 30-33.
 60. Thuermer, Karen E. "Italian Ports Boost Infrastructure to Tap Growth in Mediterranean Trade Lanes." *Traffic World*. 16 October 1995, pp. 33-35
 61. United States Transportation Command, J4-LT; and Assistant Deputy Under Secretary of Defense, Transportation Policy. *Defense Intransit Visibility Integration Plan*. Logistics Management Institute, McLean, VA, February 1995.

-
62. US Army Field Manual 55-60. *Army Terminal Operations*. Headquarters Department of the Army, Washington DC, 15 April 1996.
 63. Webster, W. C. and P. Van Dyke. *Containership Loading: A Containership Allocation Model*. Computer-Aided Ship Design Engineering Summer Conference, the University of Michigan, Ann Arbor, MI, June 1970.