

SPECIAL REPORT 306:
NAVAL ENGINEERING IN THE 21ST CENTURY
THE SCIENCE AND TECHNOLOGY FOUNDATION FOR FUTURE NAVAL FLEETS

**Science and Technology Challenges and
Potential Game-Changing Opportunities**

Michael Triantafyllou
Massachusetts Institute of Technology

Paper prepared for the
Committee on Naval Engineering in the 21st Century
Transportation Research Board

2011

Science and Technology Challenges and Potential Game-Changing Opportunities

MICHAEL TRIANTAFYLLOU
Massachusetts Institute of Technology

The future of naval engineering in the 21st century will be shaped by novel and emerging technologies that will not only provide unprecedented capabilities but also require radical re-thinking of naval ship and vehicle design. This change is already in the works as engineering schools in major universities are hiring young faculty trained in new fields and developing novel technologies. This investment is expected to bring radical changes to mature fields, such as naval architecture and marine engineering; hence, to fully reap the benefits the ground must be prepared now.

The paper is structured around these new emerging technologies and the impact they are expected to have and provides discussion on their impact on naval ships and vessels and their capabilities. Traditional mechanical engineering departments and naval architecture and marine engineering schools are turning increasingly towards nano-engineering, novel power-trains and synthetic fuels, and robotic devices and smart sensors, in order to revitalize mature disciplines.

The following emerging technologies and fields are covered and a discussion of the related implications for naval ship design is included:

- Efficient power trains (especially of the hybrid type), efficient engines using alternative fuels that are more sustainable and environmentally friendly, and fuel cells that use conventional fuels more efficiently.
- Progress in surface chemistry that allows the development of novel coatings to protect ship hulls and cargo holds, reduce deposits in pipelines, and decrease fluid drag.
- Work on the all-electric ship, which has generated new methods to design and operate ships with increased automation, reduced manning, and increased reliability.
- New sensor arrays, which will allow sensing of the self-generated flow and will create the capability for active flow manipulation and hence increased capabilities for maneuvering and efficient propulsion.
- Robotic developments that promise routine unmanned inspection and remote underwater intervention.
- Smart autonomous underwater vehicles (AUV) that increase substantially the operational capability of ships and submarines. Naval ship and submarine design will be influenced significantly to accommodate the storage and servicing, as well as the launching and retrieval of AUVs in rough weather.
- New high-strength steels that improve hull protection against impact and fatigue, including operation in very cold climates.
- Global ocean modeling and prediction that will allow effective routing and operation of vessels in rough seas with unprecedented detail.

The paper concludes with an assessment of the shape of future naval designs and the capabilities they will offer.

THE FUTURE OF NAVAL ENGINEERING AS PART OF A RENAISSANCE IN MATURE FIELDS

Naval engineering is based on the principles of naval architecture and marine engineering, a field with considerable history and achievement. The level of maturity in many of the constituent technologies is significant, as almost every possible angle has been studied and, hence, future progress can be presumed to be only incremental and gradual.

While this view may have been correct a few years ago, it is completely outdated today because of a renaissance that is occurring currently in several other disciplines that can also be classified as mature, prompted by revolutionary changes in novel areas of research. The author became aware of the possibilities offered by new technologies because of the merger at the Massachusetts Institute of Technology (MIT) of the departments of ocean engineering and mechanical engineering about five years ago. Mechanical engineering has been in the process of transforming itself by adding to its traditional areas, primarily through hiring new faculty, to include and incorporate developments from such areas as nanotechnology, biotechnology, optics, and surface chemistry. Seven areas—mechanics modeling, instrumentation, and computation; design, manufacturing, and product development; control, instrumentation, and robotics; energy science and engineering; ocean science and engineering; bioengineering; and nano/micro engineering—reflect the new composition of the department. Several young faculty from diverse areas were hired to provide expertise in the new fields.

The operation of the area of ocean science and engineering within the mechanical engineering department allowed close collaboration with a variety of new disciplines, expanding the possibilities for multidisciplinary work. For example, when a new initiative, funded by the oil industry, was started through the Center of Ocean Engineering about three years ago, to develop the new technology needed to produce oil and gas in ultra-deep waters, beyond depths of 2,500 meters, it became obvious that this would be feasible only through a coordinated effort of several disciplines and technologies. Therefore, several faculty outside the area of ocean engineering, and even from other departments, joined in the effort. Likewise, in two other major research initiatives, the all-electric ship funded by the Office of Naval Research (ONR), and the pervasive monitoring of the environment around Singapore, funded by the National Research Foundation of Singapore, it was essential to bring in faculty from several other areas and departments. The Center for Ocean Engineering is operating today with 24 faculty from the department of mechanical engineering and 7 faculty from other departments, including materials science and engineering, chemical engineering, electrical engineering and computer science, and Earth and planetary sciences; as well as several scientists from the Woods Hole Oceanographic Institution.

This paper will illustrate the experience of working with faculty from various areas and explore the future of naval engineering by projecting the novel capabilities into the near-term and medium-term future. These developments are not mere contemplation since several traditional departments in major universities like MIT have invested in the hiring of faculty from other departments in order to bring in these new capabilities and technologies. It would be a major loss if the profession does not prepare now and take advantage of the upcoming developments as outlined below.

NEW ENABLING TECHNOLOGIES

Several areas are listed below in which progress is expected to be rapid as developments are very promising and a critical mass of researchers works already in these topics—not necessarily for application to naval engineering, but it would not take a significant effort to bring in these capabilities to the field.

Nano-Engineering Surface Chemistry

Development of novel nanostructured coatings and surface treatments to protect ship hulls and cargo holds from corrosion and biofouling and to reduce deposits in pipelines hold great promise as they are not toxic, are very robust to the ocean environment, and can be used to reduce ship resistance and therefore reduce operating costs and pollution. One of the developments is the property of super-hydrophobicity, first studied in connection with the lotus leaf effect (Barthlott and Neinhuis 1997, Solga et al. 2007, Forbes 2008). It was found that a combination of micro-textured bumps and nano-textured wax crystallites gave the lotus leaf its near-magical properties of non-wetting and self-cleaning.

The important discovery was that specially designed nano-texturing can cause a surface to become super-hydrophobic (with a contact angle in excess of 150 degrees) selectively for some (or all) liquids (Lafuma and Quere 2003) or super-hydrophilic (with a contact angle less than 5 degrees) (Varanasi et al. 2006b). For example, surfaces can be designed to be super-hydrophobic but super-oleophilic (oil-loving), thus acting as perfect separators of oil and water (Varanasi et al. 2009c, Liu et al. 2009, Choi et al. 2009). As shown in Tuteja et al. (2008ab), with the right choice of fluorinated nano-particles, simple dip-coating processes enable delivery of omni-phobic coating to textured substrates and can convey super-repellency even to low surface tension liquids such as oils and alcohols. Deng et al. (2009) show that under dynamic wetting, such as droplet impingement, compressibility effects have to be considered, and super-hydrophobic surfaces have to be designed to overcome even higher wetting pressures (such as Bernoulli and water hammer pressures)—these considerations become important in surface design for several practical applications. Figure 1 shows high-speed images of droplet impact on a variety of super-hydrophobic surfaces ranging from micro to nano length-scales with similar static wetting but dramatically different dynamic behavior and their efficacy in water repellency for impinging droplets.

Another important area of application for nano-engineered surfaces is in significant enhancements in heat transfer. Varanasi et al. (2006a, 2006b, 2008b, 2009a) show that enhancements in phase change heat transfer can be achieved by controlling nucleation-level phenomena using hybrid surfaces (Figure 2), increasing nucleation rate, and ultimately detaching the liquid (or vapor) rapidly to create fresh nucleation surfaces. These new concepts have high potential for new high-efficiency heat exchangers, boilers, evaporators, and condensers, including marine heat exchangers.

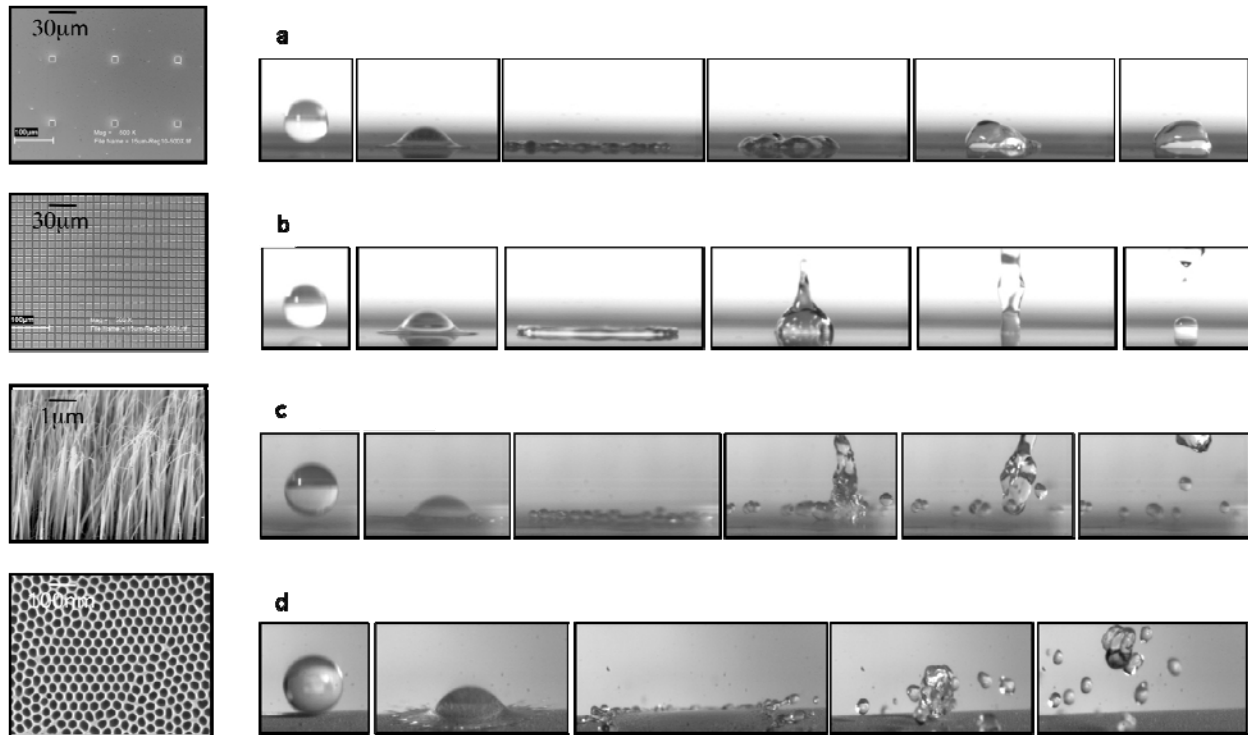

FIGURE 1 Dynamic interactions of 1mm diameter droplets with a variety of superhydrophobic surfaces captured using a high-speed camera (Deng et al. 2009): (a) micro-textured surface consisting of 15mm posts spaced apart by 150mm, droplet does not recoil, (b) partial drop recoil on microtextured surface consisting of 15mm posts spaced apart by 5mm, (c) complete drop recoil on nano-structured dendritic surface with 100nm features, and (d) complete drop recoil on durable metal-oxide nano-porous surface with ~40nm pores.

The greatest impact may come from durable nano-coatings for ships. Novel, multi-functional nano-engineered coatings and surface treatments can be used for the following:

- Anti-fouling and prevention of biofilm adhesion (Efimenko 2009, Rothstein 2010);
- Ultra low drag surfaces for application to hull resistance reduction, as well as pipeline friction reduction (Martell et al. 2009); and
- High efficiency heat exchanger surface treatments (Varanasi et al. 2006).

These developments can be combined with durable ceramic or ceramic-metallic, low surface energy nano-coatings (Figure 3), which are erosion and corrosion resistant (Deng et al. 2007, Varanasi et al. 2009c).

These coatings hold great promise for reduced biofouling, reduced energy use through significant drag reduction, and reduced maintenance and down time.

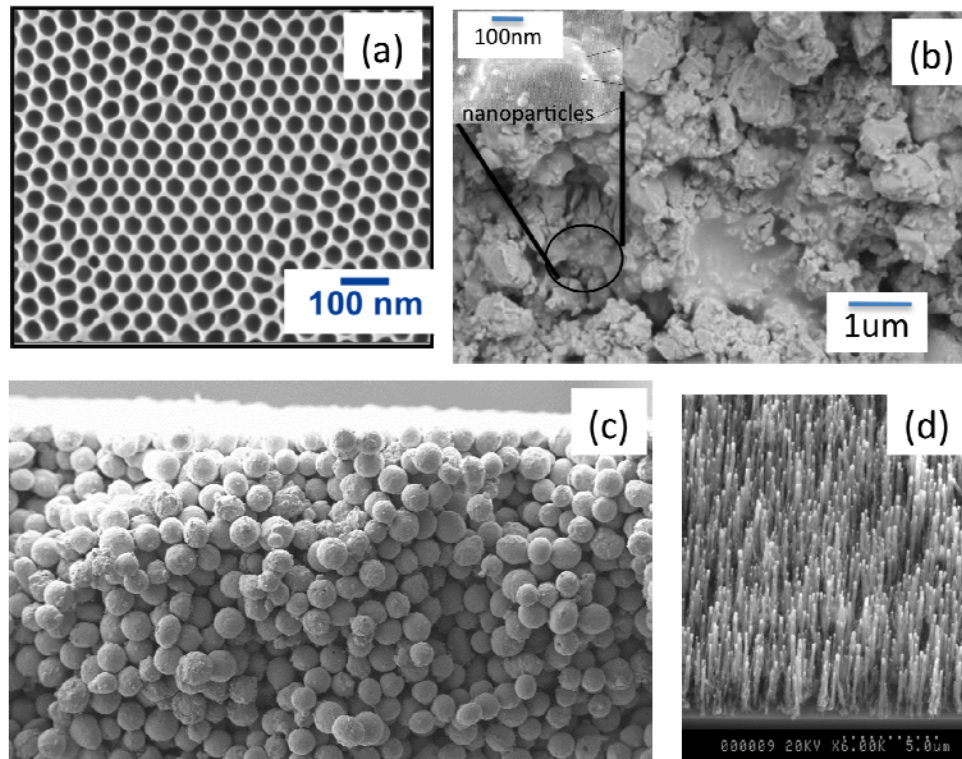

FIGURE 2 (a–c) Examples of hard, durable ceramic nanotextures that could be applied to ship hulls (Varanasi et al. 2009): (a) anodized metal oxide nanostructures (Deng et al. 2009, Bavykin et al. 2006); (b) durable thermal-spray based hierarchical micron-nano surfaces (Deng et al. 2006); (c) metallic particle-based surfaces (Varanasi et al. 2009c); and (d) carbon nanotube “nanograss,” with height $h=4\text{mm}$ demonstrating the type of nanotexturing that allows systematic changes in the surface hydrophobicity (Lau et al. 2003, Tuteja et al. 2007).

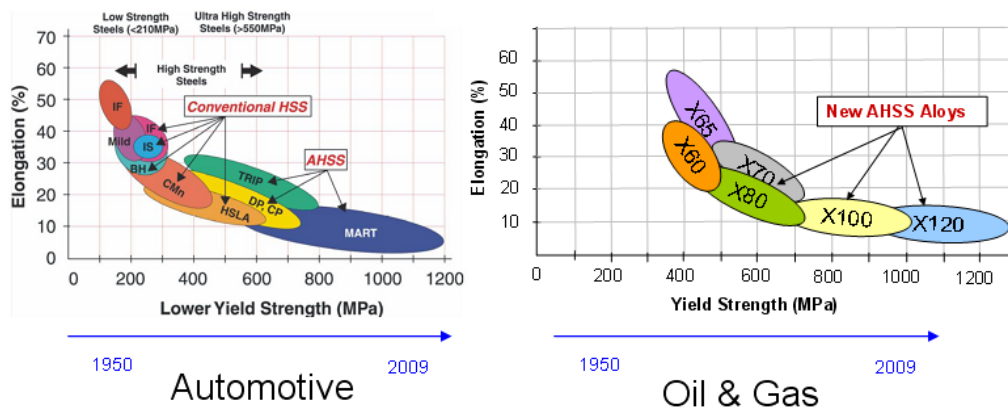

FIGURE 3 Trends in the marine, offshore, and automotive industries towards AHSS. Higher strength must be contrasted with lower ductility necessitating a thorough fracture analysis of structures.

New High-Strength Lightweight Marine Structures

Work to increase the strength of ship structures while making them lighter is promising to enhance ship design and construction methods. A new generation of advanced high strength steels (AHSS) is being introduced, characterized by higher strength but reduced ductility, as illustrated in Figure 3 (Bai and Wierzbicki 2010, Kofiani et al. 2010). As a result, although these materials offer unique capabilities to design high-strength and light ship structures, characterizing the mechanical and fracture properties is essential for their safe use.

Over the past few decades research has focused on the design of naval and other ships to increase their resistance against accidental loads such as collision, grounding, explosions, and weapon effects, through a thorough understanding of ductile fracture. A complete fracture technology is being developed, including three-dimensional fracture model development (Beese et al. 2010, Bai et al. 2010), calibration through experiments and simulation (Dunand and Mohr 2009), and demonstration through applications (Teng et al. 2008).

New Engines, Turbines, Fuel Cells, PowerTrains and Fuels

As new, more stringent environmental regulations are expected to apply, several efforts are underway to design engines, turbines, fuel cells, powertrains, and fuels that will reduce emissions and improve propulsive efficiency. Such systems are under development for ground propulsion and, with the requisite adjustment, can be adopted for marine propulsion (Ghoniem 2010).

If one considers that the global shipping industry consumes 8.6% of world's oil (see Figure 4) and accounts for 3% of global greenhouse gases, their application to the marine field, including naval engineering, will become essential.

The overall effort, which may be called the “greening of ships,” may profit from the results of ongoing research in the energy field (Center for 21st Century Energy at MIT):

- Reduction of CO₂ emissions through improving propulsion efficiency, use of biofuels and low carbon fuels, and onboard CO₂ capture for sequestration;

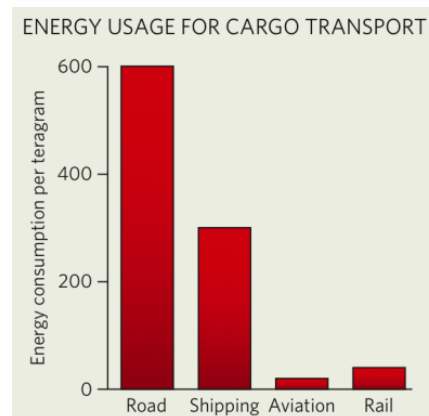

FIGURE 4 Energy use by ships worldwide.

- Solutions to reduce fuel consumption, diversify the fuel sources, and enhance the security of resources;
- Work on alternative fuels includes the production and utilization of CO₂-neutral biofuels and petroleum-free synfuels; and
- Work on alternative powertrains.

Specific projects include the following:

- Clean diesel technology with comprehensive after-treatment, including urea-based exhaust after-treatment to reduce nitrogen oxide (NO_x) emissions;
- Clean and fuel flexible premixed gas turbine propulsion to improve efficiency and reduce emissions, especially when used in a hybrid electric power-train;
- High-temperature fuel cells;
- Enabling technologies for hybrid-electric drivetrains, such as novel motors and generators, power electronics, and control systems; and
- CO₂ capture in large-scale mobile and stationary power plants.

Natural gas is an ideal fuel for lean premixed gas turbine engines—which, given their higher power density, compatibility with electricity generators, and the trend toward ship propulsion electrification, present a significant opportunity for alternative ship propulsion. Synthetic gas with varying concentrations of hydrogen is an alternative fuel to natural gas that can be produced from a variety of sources such as biomass and has better combustion characteristics (Speth and Ghoniem 2009). Research to fuel flexible gas turbine engines and their control is an important enabler for this purpose. Compact combined cycle technology for electricity generation in electric ships significantly enhances the efficiency of gas turbines and can be adopted in large ships.

Research on diesel engine technology, the more efficient propulsion technology for smaller ships (but also the most polluting engine) is noteworthy. The success of future diesel-engine technologies hinges on developing new combustion strategies that mitigate regulated emissions of NO_x and particulate matter (PM) without sacrificing fuel-economy and CO₂ reduction benefits. Diesel engines using alternative fuels such as natural gas and biodiesel may achieve better efficiency via higher compression ratios, but at lower CO₂, given the properties of these fuels. Research on high-temperature fuel cells, a more efficient but more expensive technology, which utilize hydrocarbon fuels, should also explore their compatibility with all-electric ship propulsion (Lee et al. 2009). The same technology can operate on hydrogen if deployed in electric submarines.

Finally, important efforts are underway to transition from reduced CO₂ to zero CO₂. Hence, there are unique opportunities to

- Reduce the carbon footprint in naval ships with improved engine efficiency, burning low carbon and using renewable fuels, and incorporating advanced power trains;
- Extend methods under development for CO₂ capture in stationary power systems to mobile propulsion systems (Hong et al. 2009); and
- Eliminate the naval ships' carbon emissions completely with CO₂ capture systems.

Automation and Reduced Manning in the All-Electric Ship

The electric drive technology for ship propulsion was developed mainly by the cruise ship industry and is in extensive use today in cruise ships and other commercial marine vehicles. The electric ship initiative for naval ships is underway, funded by ONR; a consortium of universities is working on several areas, including power generation, power distribution and control, energy storage, heat transfer and thermal management, and developments of new generators, motors and actuators (Englebretsen et al. 2009, Proper et al. 2009, Prempraneerach et al. 2009). These developments will lead to new methods to design and operate ships with substantially improved efficiency, power high-power weapons, achieve reduced manning, and provide increased reliability, but will require a drastic re-thinking on how ships are designed (Doerry and Fireman 2006).

The all-electric ship effort combines electric propulsion technology with energy-efficient power systems throughout a ship, including auxiliary systems that are steam- or hydraulically or pneumatically powered. A single set of main engines efficiently produces electricity for use by the ship's propulsion and all other systems. Gas turbines in use today are designed to supply the peak propulsive loads, but usually operate at efficiencies below 20%, since most of the time they operate at low or at most medium speeds. The use of new engines, combined with the use of the prime movers to provide energy continuously to other ship systems will improve fuel use substantially (Doerry and Fireman 2006, Englebretsen et al. 2009).

Automation and reduced manning is another major objective. Control and reconfiguration studies are significantly enabled using tools of stochastic simulation. The complexity of a naval vessel may rival that of a small city. At the same time, a high degree of integration is required to achieve the levels of at-sea performance and robustness needed by today's navy. New design

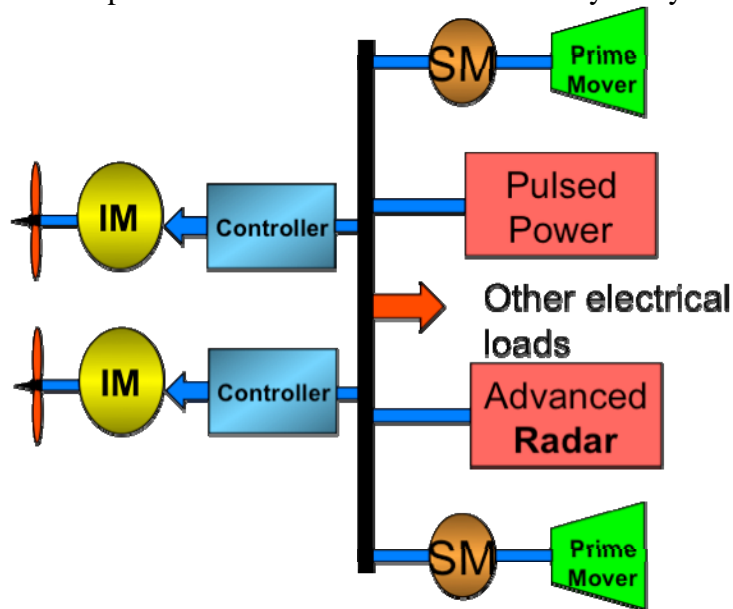

FIGURE 5 Integrated propulsion and energy generation in the all-electric ship allows the efficient energy production and distribution, starting from central prime movers and generators, and using large induction motors and power electronics.

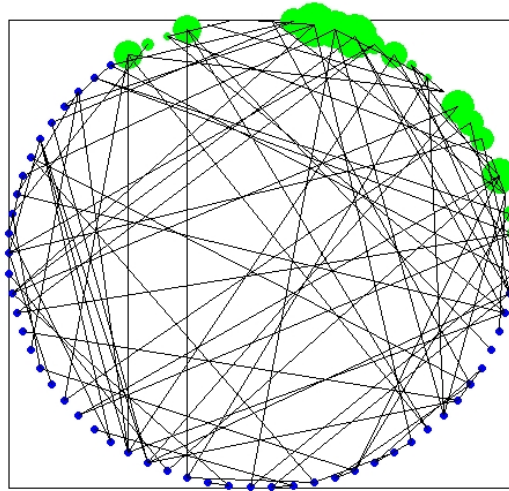

FIGURE 6 Posed properly, large-scale designs of distribution systems can be optimized using standard tools such as linear and semi-definite programming. Such problems are relevant to the power grid on a large vessel and to communications between marine vehicles through lossy acoustic communication links (Taylor and Hover 2009).

tools are needed to explore options at the early stages of design as well as at the detailing stages. Stochastic simulation has a major role throughout (Prempraneerach et al. 2009, Taylor and Hover 2009); its goal is to identify and characterize sensitivities to constituent user choices and to environmental conditions. For example, in the all-electric ship, a key question is how motion of the vessel in a seaway can cause the propellers to leave the water, in turn allowing the electric machines to spin up, potentially causing large disturbances to the ship's power system. Fundamentally new tools for generating and analyzing interconnections also support large-scale design. Observations of large terrestrial power grids and the Internet, for instance, have revealed that certain underlying structural properties can be tied to performance and robustness—and these could provide a new basis for early design.

Autonomous Vehicles for Operations, Reconnaissance, Inspection, and Repair

Autonomous vehicles already developed to the point that they are routinely employed for ocean mapping, reconnaissance, and exploration (Committee on Autonomous Vehicles in Support of Naval Operations 2005). As figure 7 shows, several autonomous surface and underwater vehicles are part of almost every oceanographic cruise, while they are becoming equally important to naval operations. The capabilities offered by AUVs and smart sensors, however, will increase many-fold as software and hardware are being developed to allow multivehicle operation, offering the possibility of mapping large events or large areas of the ocean in real time. The availability of AUVs, however, will require the routine launching and retrieval of a large number of such vehicles in rough seas, or underwater, at large depth. A substantial re-thinking of ship and submarine configuration and design will become imperative to allow the storage and efficient launching and retrieval of AUVs and the support of their operations and communications requirements. Also, many functions and operations currently undertaken by ships or submarines will be transferred to distributed autonomous systems (Figure 8).



FIGURE 7 Autonomous underwater vehicles (Odyssey II) and surface vehicles (kayak hulls) are essential to every oceanographic cruise and become increasingly important to naval operations (*photo courtesy of John Leonard*).

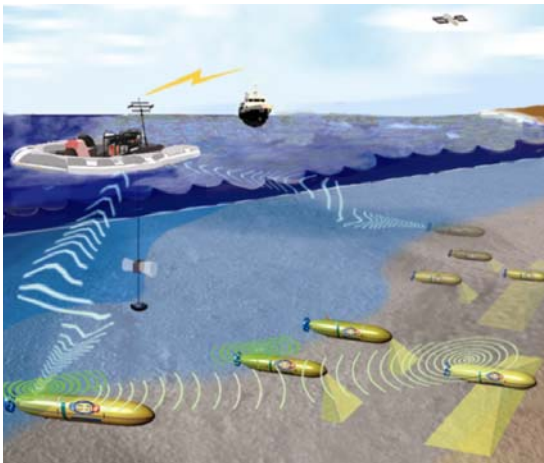

FIGURE 8 Multiple coordinating AUVs, gliders and surface craft, guided by Global Positioning System or submerged vehicles will offer a unique capability to map and explore the ocean on a scale that was unimaginable a decade ago.

Equally important is the capability by AUVs to conduct unmanned inspection of ship hulls, and, in the near future, remote underwater hull cleaning, without the need for docking. As figures 9, 10, and 11 show, new simultaneous localization and mapping (SLAM) algorithms allow the effective inspection of hulls without a prior map of the ship hull.

Figure 9 shows mapping of the entire submerged hull of a ship, obtained through systematic search. Figure 10 shows maps of the above-water part of a ship, obtained through laser scanning, as well as of the submerged part of the hull, obtained through sonar imaging. Figure 11 depicts the inspection of the stern of a ship obtained through a hovering autonomous vehicle.

Autonomous Operation in Rough Seas

Although ship routing has been in use for several years, a new unprecedented capability is becoming available as real-time sea prediction using radar and satellite allows the prediction of ship motions and the evaluation of path planning to reduce ship motions substantially and especially reduce the risk of damage or capsizing. The capability is crucial for the operation of smaller ships in rough seas and for the launching and retrieval of autonomous vehicles in stormy weather. Equally important, automation of ship handling to the point of complete automation of small craft in very rough seas becomes feasible.

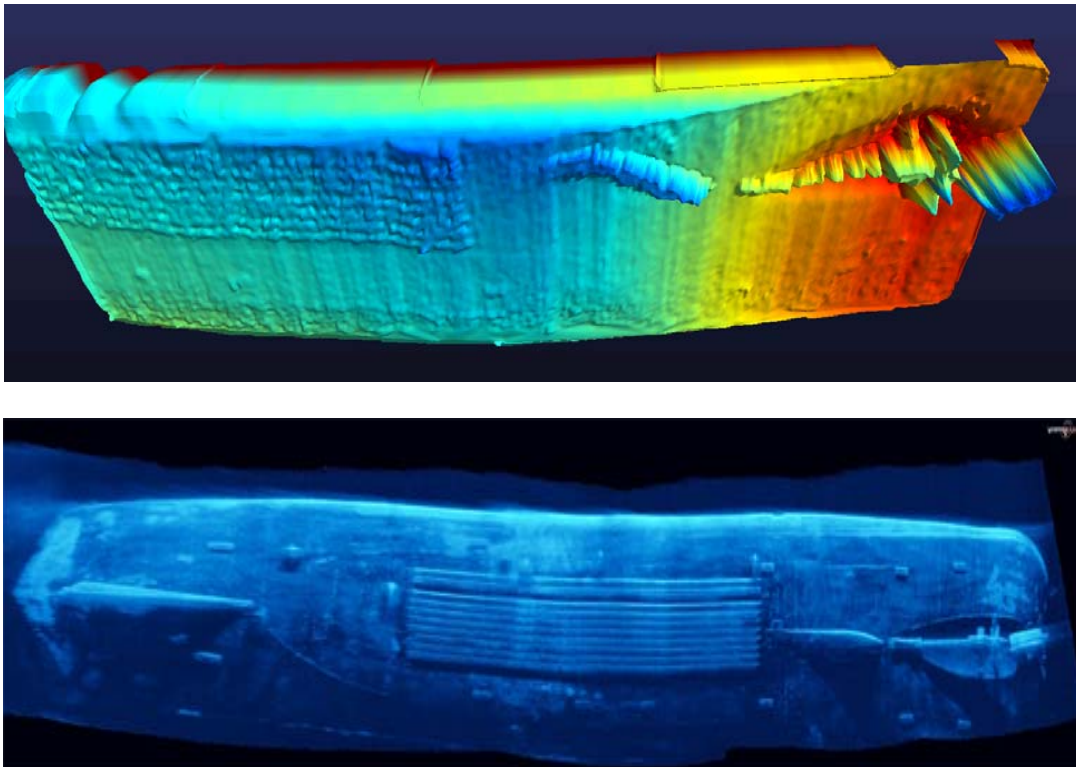

FIGURE 9 Inspection of a ship hull by an AUV using SLAM (*images courtesy of John Leonard*).

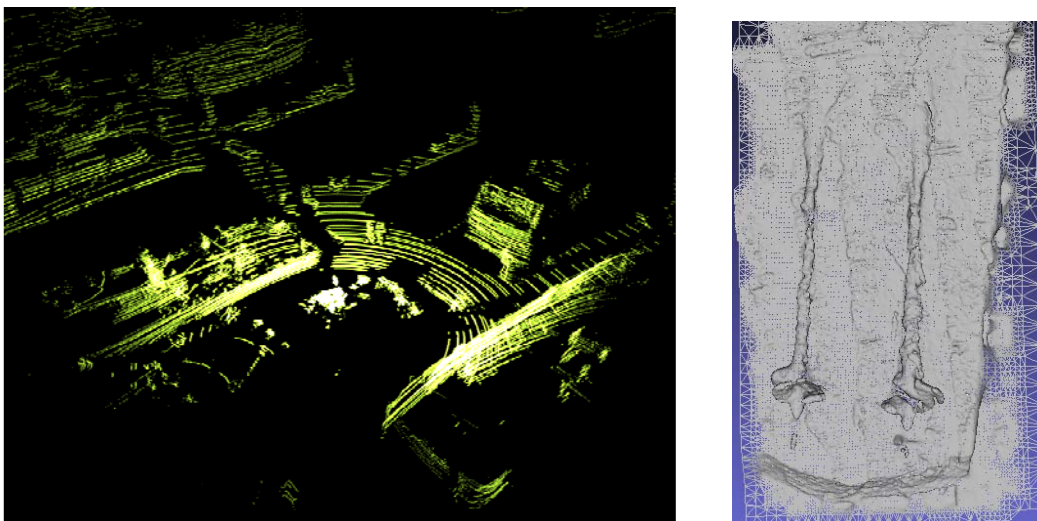

FIGURE 10 The increased use of advanced 3-D sensors will allow autonomous vehicles to inspect and monitor structures, both above- (laser scanning, left) and below (imaging sonar, right) water (*images courtesy of Franz Hover*).

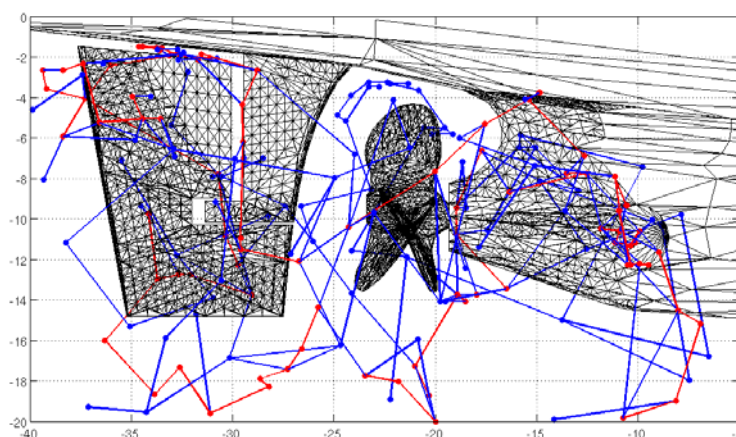

FIGURE 11 Path planned by a hovering underwater vehicle to inspect the running gear of a large tanker, using a steerable acoustic camera (*image courtesy of Franz Hover*).

The basis of these developments is a realistic, nonlinear, moderate- to large-scale, phased-resolved ocean wavefield reconstruction and prediction using direct numerical simulation (Mei et al. 2005; Yue 2008). The reconstruction and forecasting of nonlinear irregular wavefield evolution is based on wave measurements in the field, either at several specific points or specific areas, using the ship's radar, satellite measurements, and possibly moored buoys.

Figure 12 demonstrates the ability to predict the wavefield with high accuracy up to a full 60 seconds ahead; this allows the effective routing of small ships, or the identification of windows of opportunity for landing of helicopters on ships, or the launching and retrieval of AUVs.

Equally important is the ability to forecast the precise location and height of extreme waves, known as rogue waves (Onorato et al. 2001), which are known to cause major structural damage even in very large ships or to capsize smaller size ships (Dysthe et al. 2008). As shown in Figure 13, the real-time, precise identification of such events is possible, leading to invaluable tools for smaller vessel navigation.

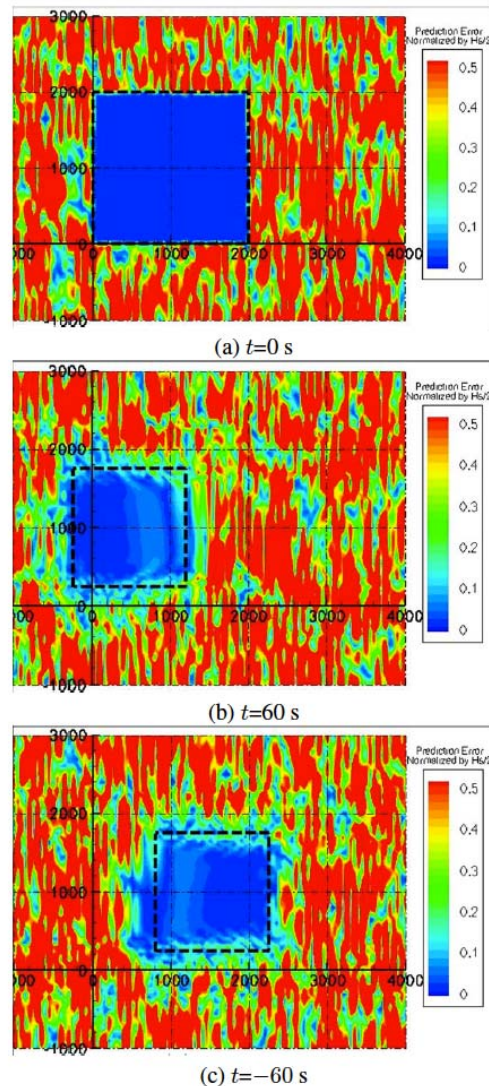

FIGURE 12 Deterministic hindcasting and forecasting of directional wavefield evolution based on wave profile measurement in the region marked blue in (a) (roughly 2 km by 2 km). In (b) and (c) the contours of the error between predicted and actual wavefields 60 s before and after the measured field at $t=0$ are plotted (Yue 2008).

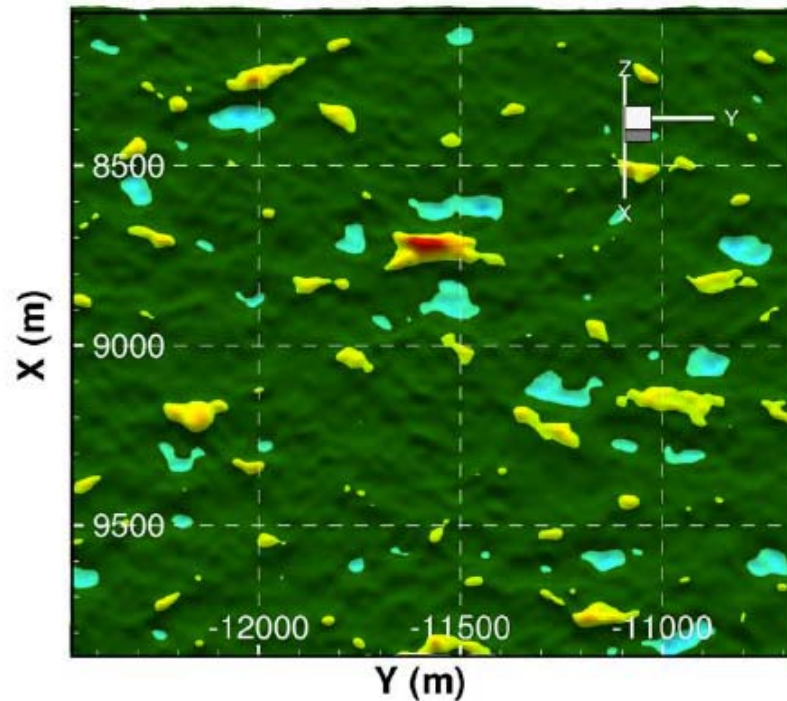

FIGURE 13 Effective rogue wave identification (red area) over an area roughly 2 km by 2 km (Yue 2008).

Smart Hulls for Super-Maneuverability and Efficient Propulsion

The hulls of surface ships and submarines are expected to undergo a radical transformation as inexpensive, robust, low-power pressure, and velocity micro-sensors will become available, in the same way that the safety of cars was revolutionized by the availability of inexpensive accelerometers, which can be used to activate airbags and air-curtains. In the case of the hulls, what is needed is a continuous sensing of the flow around them to achieve efficient propulsion and, especially, to achieve super-maneuverability.

An essential difference between man-made vehicles and live animals is the dense set of sensors on the surface of the skin of the latter, especially the so-called lateral line of fish, a set of sensors that allows them to detect velocity and pressure at several points along their body (Montgomery et al. 2001). This is a sensory organ that has no analog in the human body, yet it is essential to the impressive fish performance, especially its rapid maneuvering and detection of objects and flow patterns (Pitcher et al. 1976; Fish and Lauder 2006; Fernandez et al. 2007 and 2009).

The Mexican cavefish (Baker and Montgomery 1999) can navigate solely using its lateral line as its eyes have atrophied in the darkness of the caves it lives in. Trout can detect flow patterns in turbulent flow (Liao et al. 2003) through its lateral line, while all fish are capable of detecting prey or enemy.

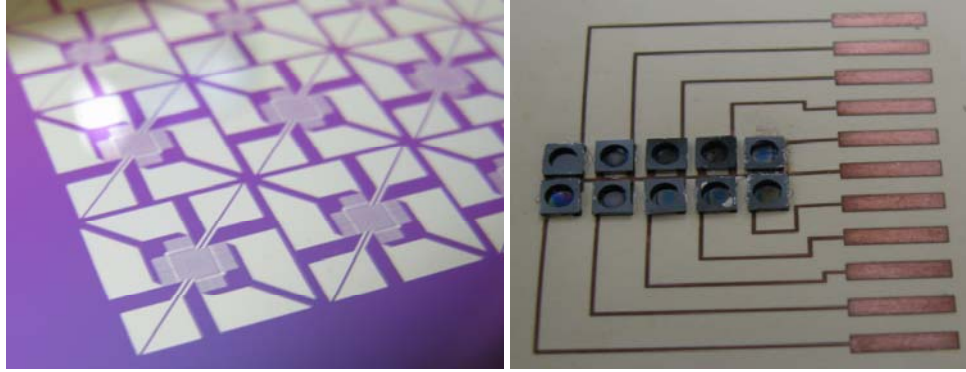

FIGURE 14 Arrays of micro-electrical-mechanical– (MEMS) based pressure micro-sensors (*left: strain-gauge sensors with diameter 1 mm; right: piezo-resistive sensors*) provide sufficiently detailed flow information to identify objects and detect flow patterns, emulating the lateral line of fish (Fernandez et al. 2009).

The development of MEMS-based pressure microsensor arrays provides a unique capability, emulating the performance of live fish (Fernandez et al. 2007 and 2009). Each sensor has a diameter of 1 mm and its resolution is 1 Pa—capabilities that almost match those of fish. In addition, these sensors are passive, in contrast to sonar, and require very low power levels. Recent efforts to develop robust sensor arrays (Wang et al. 2009) will provide sensors that can be easily installed at various locations along the hull of the ship, providing flow information to improve locomotion and fast maneuvering.

In the case of naval ships, the availability of distributed pressure and velocity sensors will allow the detection of separated flow, which is the major source of energy waste in propulsion, and the major source of drag preventing super-maneuverability. Submarines and surface ships are well streamlined to reduce their resistance; yet, when side currents are present, or when undergoing sharp maneuvers, their hulls cause large-scale separation, often in the form of helical vortices. Continuous monitoring of the flow around the hulls can guide the control of ships to reduce separation and can be used to activate actuators to reduce separation (Fiedler and Fernholz 1990; Hess and Fu 2003, Tan et al. 2010).

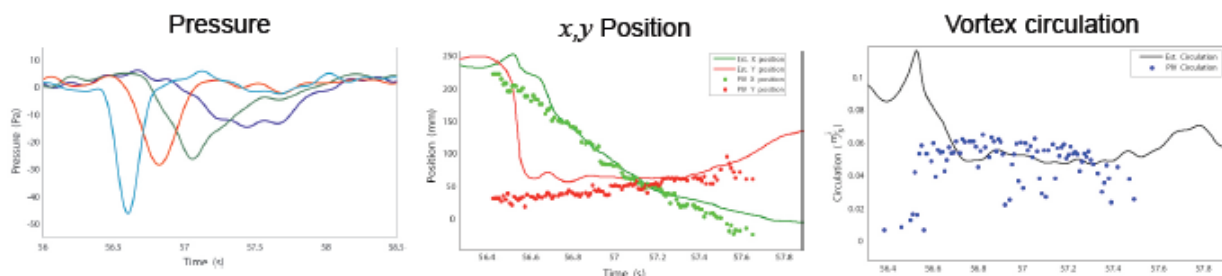

FIGURE 15 Identification of a traveling vortex by a four-sensor array. *Left: Pressure signals, exhibiting the characteristic deep-U signature of a vortex; note successive measurements of the pressure signal by adjacent sensors. Middle and right: Comparison of (x,y) estimated position of the vortex and its circulation (continuous lines) versus PIV measurements (dots).*

CONCLUSIONS: NAVAL SHIP OF THE FUTURE

he view of naval ships, vehicles, and submarines with considerable enhanced capabilities is based on solid advances in many of the constituent fields. Naval architecture always required the infusion of many disciplines as large ships and submarines remain some of the most complex self-standing structures on earth with unique operational requirements and continuous operation in a random environment. Based on the advances in the areas covered in the body of the paper, unique opportunities for significant advances are seen in the following areas:

- Highly automated, all-electric ships with reduced manning. The ships will be highly reconfigurable for robust operation and use new engines and fuels, which will be highly efficient and with very low CO₂ emissions.
- “Smart” submarine hulls equipped with arrays of pressure and velocity sensors as well as flow manipulators will provide super-maneuverability, high propulsive efficiency, and reduced hydrodynamic signature.
- New ceramic nano-textured coatings will be durable, while reducing biofouling and corrosion in the hull, the holds, and the pipelines of ships and submarines, hence reducing the need for servicing. The coatings could be used to reduce drag, and thus provide enhanced propulsive efficiency.
- New structural designs will allow for lighter hulls with much enhanced capability to withstand and absorb damage.
- Fleets of AUVs and smart sensors will be employed routinely; therefore, their storage, retrieval, and operation will become a central issue for the design or re-design of ships and submarines. AUVs can serve to inspect and service the hulls of ships reducing the need for servicing.
- Automatic operation in rough seas for small craft and assisted deployment and retrieval of AUVs will be possible through the real-time use of satellites and radar to reconstruct the sea elevation.

ACKNOWLEDGMENTS

The author acknowledges the discussions held and material provided by MIT professors Chrys Chryssostomidis, Ahmed Ghoniem, Franz Hover, Jeff Lang, John Leonard, Gareth McKinley, Kripa Varanasi, Tomasz Wierzbicki, and Dick Yue that helped shape the present paper. Research support by ONR, DARPA, NSF, the MIT Sea Grant Program, the Singapore –MIT SMART program, and the Chevron-MIT UPP program is gratefully acknowledged.

REFERENCES

- Bai, Y., and T. Wierzbicki. Application of the Extended Coulomb-Mohr Model to Ductile Fracture. *International Journal of Fracture*, Vol. 169, 2010, pp. 1–20.
- Baker, C. F., and J. C. Montgomery. The Sensory Basis of Rheotaxis in the Blind Mexican Cave Fish, *Astyanax Fasciatus*. *Journal of Comparative Physiology*, Vol. 184A, 1999, pp. 519–527.
- Barthlott, W., and C. Neinhuis. The Purity of Sacred Lotus or Escape Contamination in Biological Surfaces. *Planta*, Vol. 202, 1997, pp. 1–8.

- Beese, A. M., M. Luo, Y. Li, Y. Bai, and T. Wierzbicki. Partially Coupled Anisotropic Fracture Model for Aluminum Sheets. *Engineering Fracture Mechanics*, Vol. 77, 2010, pp. 1128–1152.
- Choi, W., A. Tuteja, S. Chhatre, R. E. Cohen, and G. H. McKinley. Fabrics with Tuneable Oleophobicity. *Advanced Materials*, Vol. 21, 2009, pp. 2190–2196.
- Committee on Autonomous Vehicles in Support of Naval Operations. *Autonomous Vehicles in Support of Naval Operations*. National Academies Press, Washington, D.C., 2005, 256 pp.
- Deng, T., D. Gray, T. Curtis, Y. C. Lau, M. Hsu, N. Bhate, P. Subramanian, M. Blohm, and K. K. Varanasi. *Method of Preparing Wetting-Resistant Surfaces and Articles Incorporating the Same*. U.S. Patent 20090004379, 2006.
- Deng, T., K. K. Varanasi, M. Hsu, N. Bhate, C. Keimel, J. Stein, and M. Blohm. Nonwetting of Impinging Droplets on Textured Surfaces. *Applied Physics Letters*, Vol. 94, 2009, 133109.
- Doerry, N. H., and H. Fireman. Designing All-Electric Ships. *Proc., 9th International Marine Design Conference*, Ann Arbor, Mich., May 16–19, 2006.
- Dunand, M., and D. Mohr. Hybrid Experimental-Numerical Analysis of Basic Ductile Fracture Experiments for Sheet Metals. *International Journal of Solids and Structures*, Vol. 47, 2010, pp. 1130–1143.
- Dysthe, K., H. Krogstad, and P. Muller. Oceanic Rogue Waves. *Annual Review of Fluid Mechanics*, Vol. 40, 2008, p. 287.
- Efimenko, K., J. Finlay, M. E. Callow, J. A. Callow, and J. Genzer. Development and Testing of Hierarchically Wrinkled Coatings for Marine Antifouling. *Applied Materials and Interfaces*, Vol. 1 (5), 2009, pp. 1031–1040.
- Englebretsen, S., J. Kirtley, and C. Chryssostomidis. Induction Motors Driving High-Speed Propellers. Presented at ESRDC Conference, Mississippi State University, 2009.
- Fernandez, V. I., S. M. Hou, F. S. Hover, J. H. Lang, and M. S. Triantafyllou. Lateral-Line Inspired MEMS-Array Pressure Sensing for Passive Underwater Navigation. *Proc., International Unmanned Untethered Submersible Technology Symposium*, Durham, NH, August 2007.
- Fernandez, V. I., S. M. Hou, F. S. Hover, J. H. Lang, and M. S. Triantafyllou. MEMS-Array Pressure Sensing for Underwater Navigation. *Proc., 2007 Undersea Distributed Networked Systems Conference*, Newport, RI, February 2007.
- Fernandez, V. I., S. M. Hou, F. S. Hover, J. H. Lang, and M. S. Triantafyllou. Development and Application of Distributed MEMS Pressure Sensor Array for AUV Object Avoidance. *Proc., International Unmanned Untethered Submersible Technology Symposium*, Durham, NH, August 2009.
- Fiedler, H. E., and H. H. Fernholz. On Management and Control of Turbulent Shear Flows. *Progress in Aerospace Sciences*, Vol. 27, 1999, pp. 305–387.
- Fish, F. E., and G. V. Lauder. Passive and Active Flow Control by Swimming Fishes and Mammals. *Annual Review of Fluid Mechanics*, Vol. 38, 2006, pp. 193–224.
- Forbes, P. Self-Cleaning Materials. *Scientific American*, Vol. 299, 2008, pp. 67–75.
- Ghoniem, A. Needs, Resources and Climate Change: Clean and Efficient Conversion Technologies. *Progress in Energy and Combustion Science*, Vol. 37, 2010, in press; available online <http://dx.doi.org/10.1016/j.pecs.2010.02.006>.
- Hess, D. E., and T. C. Fu. Impact of Flow Control Technologies on Naval Platforms. AIAA Paper 2003-3568, Presented at AIAA Fluid Dynamics Conference, Orlando, Florida, 2003.
- Hong, J., G. Chaudhry, J. B. Brisson, R. Field, M. Gazzino, and A. F. Ghoniem. Analysis of Oxy-Fuel Combustion Power Cycle Utilizing Pressurized Coal Combustor. *Energy, the International Journal*, Vol. 34, 2009, 1332–1340.
- Kofiani, K., T. Wierzbicki, T. Coppola, and G. Mannucci. Multi-Axial Fracture of Advanced High Strength Steels. Presented at 2nd International Conference on Super-High Strength Steels, Peschiera del Garda, Italy, October 17–20 2010.
- Lafuma, A., and D. Quere. Superhydrophobic States. *Nature Mater*, Vol. 2, 2003, pp. 457–460.
- Lau, K. K. S., J. Bico, K. B. K. Teo, M. Chhowalla, G. A. J. Amaratunga, W. Milne, G. H. McKinley, and

- K. K. Gleason. Superhydrophobic Carbon Nanotube Forests. *Nanoletters*, Vol. 3, No. 12, 2003, pp. 1701–1705.
- Lee, W. Y., D. H. Wee, and A. F. Ghoniem. Membrane Electrode Assemble Model of Solid Oxide Fuel Cells. *Journal of Power Sources*, Vol. 186, 2009, pp. 417–427.
- Liao, J. C., D. N. Beal, G. V. Lauder, and M. S. Triantafyllou. Fish Exploiting Vortices Use Less Muscle. *Science*, Vol. 302, 2003, pp. 1461–1608.
- Liu, M., S. Wang, Z. Wei, Y. Song, and L. Jiang. Bioinspired Design of a Super-Oleophobic and Low Adhesive Water/Solid Interface. *Advanced Materials*, Vol. 21, 2009, 665–669.
- Martell, M. B., J. B. Perot, and J. P. Rothstein. Direct Numerical Simulations of Turbulent Flows over Superhydrophobic Surfaces. *Journal of Fluid Mechanics*, Vol. 620, 2009, pp. 31–41.
- Mei, C. C., M. Stiassnie, and D. K. P. Yue. Theory and Applications of Ocean Surface Waves. In *World Scientific*, Chapter 15, Vol. 2, 2005.
- Montgomery, J. C., S. Coombs, and C. F. Baker. The Mechanosensory Lateral Line System of the Hypogean Form of *Astyanax Fasciatus*. *Environmental Biology of Fishes*, Vol. 62, 2001, pp. 87–96.
- Onorato, M., A. R. Osborne, M. Serio, and S. Bertone. Freak Waves in Random Oceanic Sea States. *Physical Review Letters*, Vol. 86, No. 25, 2001, pp. 5831–5834.
- Pitcher, T. J., B. L. Partridge, and C. S. Wardle. A Blind Fish Can School. *Science*, Vol. 194, 1976, pp. 963–965.
- Prempraneerach, P., J. Kirtley, C. Chryssostomidis, M. S. Triantafyllou, and G. E. Karniadakis. Design of the All-Electric Ship: Focus on Integrated Power System Coupled to Hydrodynamics. *Proc., the American Society of Naval Engineers and the Society of Naval Architects and Marine Engineers Electric Ship Design Symposium*, February 2009.
- Proper, E., R. Cox, S. Leeb, K. Douglas, J. Paris, W. Wichakool, L. Foulks, R. Jones, P. Branch, A. Fuller, J. Leghorn, and G. Elkins. Field Demonstration of a Real-Time Non-Intrusive Monitoring System for Condition-Based Maintenance. *Proc., Electric Ship Design Symposium*, National Harbor, Maryland, February 2009.
- Quere, D. Non-Sticking Drops. *Reports on Progress in Physics*, Vol. 68, 2005, pp. 2495–2532.
- Rothstein, J. P. Slip on Superhydrophobic Surfaces. *Annual Review of Fluid Mechanics*, Vol. 42, 2010, pp. 89–109.
- Solga, A., Z. Cerman, B. F. Striffler, M. Spaeth, and W. Barthlott. The Dream of Staying Clean: Lotus and Biomimetic Surfaces. *Bioinspiration and Biomimetics*, Vol. 2, 2007, pp. S126–S134.
- Speth, R. L., and A. F. Ghoniem. Using a Strained Flame Model to Collapse Model Data in a Swirl Stabilized Syngas Combustor. *Proc., Combustion Institute*, Vol. 32, Elsevier, 2009, pp. 2993–3000.
- Tan, C. W., J. M. Miao, G. Barbastathis, and M. S. Triantafyllou. A Diaphragm-Based Pressure Sensor Packaged Using Liquid Crystal Polymer and Silicone Oil for Underwater Applications. Presented at 5th Asia-Pacific Conference on Transducers and Micro-Nano Technology, Perth, Australia, July 6–9, 2010.
- Taylor, J. A., and F. S. Hover. Statistically Robust Design for the All-Electric from a Network Theoretic Perspective. ESTS 2009, Baltimore, MD.
- Teng, F., T. Wierzbicki, and M. Huang. Ballistic Resistance of Double-Layered Armor Plates. *International Journal of Impact Engineering*, Vol. 35, 2008, pp. 870–884.
- Tuteja, A., W. Choi, J. M. Mabry, G. H. McKinley, and R. E. Cohen. Designing Superoleophobic Surfaces. *Science*, Vol. 318, 2007, pp. 1618–1622.
- Tuteja, A., W. Choi, J. M. Mabry, G. H. McKinley, and R. E. Cohen. Robust Omniphobic Surfaces. *Proc., National Academy of Sciences*, Vol. 105, 2008a, 18200.
- Tuteja, A., W. Choi, G. H. McKinley, R. E. Cohen, and M. F. Rubner. Design Parameters for Superhydrophobicity and Superoleophobicity. *MRS Bulletin*, Vol. 33, 2008b, pp. 752–758.
- Varanasi, K. K., N. Bhate, M. F. Hsu, T. Deng, and M. Peter. *Articles Having Enhanced Wettability*. U.S. Patent 11/612946, 2006.

- Varanasi, K. K., T. Deng, M. F. Hsu, and N. Bhate. Spatial Control in the Heterogeneous Nucleation of Water. *Applied Physics Letters*, Vol. 95, 2009a, 094101.
- Varanasi, K. K., T. Deng, P. Chamarthy, S. Chauhan, P. de Bock, A. Kulkarni, G. Mandrusiak, B. Rush, B. Russ, L. Denault, S. Weaver, F. Gerner, Q. Leland, and K. Yerkes. Engineered Nanostructures for High Thermal Conductivity Substrates. *Proc., Nano Science and Technology Institute, Nanotech Conference and Expo*, Paper No. 870, Houston, TX, 2009b.
- Varanasi, K. K., A. Kulkarni, and C. Wolfe. *Oleophilic Hydrophobic Treatments for Oil-Water Separation*. U.S. Patent 12/492219, 2009c.
- Wang, Z. H., J. M. Miao, T. Xu, G. Barbastathis, and M. S. Triantafyllou. Micromachined Piezoelectric Microphone with High Signal/Noise Ratio. Presented at 15th International Conference on Solid-State Sensors, Actuators and Microsystems (Transducers 2009), Denver, Colorado, 2009.
- Yue, D. K. P. Nonlinear Wave Environments for Ship Analysis. *Proc. 27th Symposium on Naval Hydrodynamics*, Seoul, Korea, 2008.
- Zeiger, M. D., D. P. Telionis, and P. P. Vlachos. Unsteady Separated Flows over Three-Dimensional Slender Bodies. *Progress in Aerospace Sciences*, Vol. 40, 2004, pp. 291–320.